

*IBM Spectrum Protect Knowledge Center Version 8.1.2*



---

# Spis treści

<b>Witamy</b>	1
<b>Dostępność</b>	1
<b>Pakiety produktów i produkty pokrewne</b>	2
<b>Pliki PDF</b>	4
<b>Aktualizacje w tej wersji</b>	5
<b>IBM Spectrum Protect concepts</b>	5
IBM Spectrum Protect overview	5
Data protection components	6
Data protection services	7
Data protection management processes	8
User interfaces	11
Data storage concepts	12
Data storage devices	12
Storage pools	15
Data transport to storage	19
Data protection strategies	21
Backup storage space minimization	22
Disaster protection strategies	23
Disaster recovery concepts	26
<b>Data protection solutions</b>	28
Selecting a data protection solution	28
Single-site disk solution	28
Multisite disk solution	29
Multisite appliance solution	30
Tape solution	31
Solutions comparison	32
Solution roadmap	34
Single-site disk solution	34
Planning	35
Selecting a system size	36
System requirements for a single-site disk solution	36
Hardware requirements	36
Software requirements	37
Planning worksheets	39
Planning for storage	46
Planning for security	47
Planning for administrator roles	47
Planning for secure communications	48
Planning for storage of encrypted data	48
Planning firewall access	48
Implementation	49
Setting up the system	50
Configuring the storage hardware	50
Installing the server operating system	51

Installing on AIX systems	51
Installing on Linux systems	52
Installing on Windows systems	55
Configuring multipath I/O	56
AIX systems	56
Linux systems	57
Windows systems	58
Creating the user ID for the server	59
Preparing file systems for the server	59
AIX systems	60
Linux systems	61
Windows systems	61
Installing the server and Operations Center	62
Installing on AIX and Linux systems	62
Installing on Windows systems	63
Configuring the server and the Operations Center	64
Configuring the server instance	64
Installing the backup-archive client	65
Setting options for the server	65
Configuring secure communications with Transport Layer Security	66
Configuring the Operations Center	67
Registering the product license	67
Configuring data deduplication	68
Defining data retention rules for your business	68
Defining schedules for server maintenance activities	69
Defining client schedules	71
Installing and configuring backup-archive clients	71
Registering and assigning clients to schedules	71
Installing the client management service	72
Verifying that the client management service is installed correctly	72
Configuring the Operations Center to use the client management service	73
Completing the implementation	74
Monitoring	74
Daily checklist	75
Periodic checklist	79
Verifying license compliance	84
Tracking system status by using email reports	85
Managing	86
Managing the Operations Center	86
Adding and removing spoke servers	87
Adding a spoke server	87
Removing a spoke server	87
Starting and stopping the web server	88
Restarting the initial configuration wizard	88
Changing the hub server	89
Restoring the configuration to the preconfiguration state	89
Protecting applications, virtual machines, and systems	91
Adding clients	91
Selecting the client software and planning the installation	92
Specifying rules for backing up and archiving client data	93
Viewing policies	94
Editing policies	94
Scheduling backup and archive operations	95
Registering clients	96
Installing and configuring clients	97
Configuring the client to run scheduled operations	98

Configuring communications through a firewall	99
Managing client operations	100
Evaluating errors in client error logs	100
Stopping and restarting the client acceptor	101
Resetting passwords	102
Modifying the scope of a client backup	103
Managing client upgrades	103
Decommissioning a client node	104
Deactivating data to free storage space	106
Managing data storage	106
Auditing a storage pool container	106
Managing inventory capacity	107
Managing memory and processor usage	109
Tuning scheduled activities	109
Securing the server	109
Security concepts	110
Managing administrators	112
Changing password requirements	112
Securing the server on the system	113
Restricting user access to the server	114
Limiting access through port restrictions	114
Stopping and starting the server	115
Stopping the server	115
Starting the server for maintenance or reconfiguration tasks	116
Planning to upgrade the server	116
Preparing for an outage	117
Implementing a disaster recovery plan	117
Recovering from system outages	118
Multisite disk solution	118
Planning	119
Selecting a system size	120
Planning the sites	120
System requirements for a multisite disk solution	121
Hardware requirements	122
Software requirements	123
Planning worksheets	124
Planning for storage	132
Planning for security	132
Planning for administrator roles	133
Planning for secure communications	133
Planning for storage of encrypted data	134
Planning firewall access	134
Implementation	135
Setting up the system	135
Configuring the storage hardware	136
Installing the server operating system	136
Installing on AIX systems	136
Installing on Linux systems	138
Installing on Windows systems	141
Configuring multipath I/O	141
AIX systems	142
Linux systems	142
Windows systems	143
Creating the user ID for the server	144
Preparing file systems for the server	145
AIX systems	145



Linux systems	146
Windows systems	147
Installing the server and Operations Center	147
Installing on AIX and Linux systems	148
Installing on Windows systems	149
Configuring the server and the Operations Center	149
Configuring the server instance	150
Installing the backup-archive client	151
Setting options for the server	151
Configuring secure communications with Transport Layer Security	152
Configuring the Operations Center	152
Registering the product license	153
Configuring data deduplication	153
Defining data retention rules for your business	154
Defining schedules for server maintenance activities	154
Defining client schedules	156
Installing and configuring backup-archive clients	157
Registering and assigning clients to schedules	157
Installing the client management service	158
Verifying that the client management service is installed correctly	158
Configuring the Operations Center to use the client management service	159
Configuring the second server	160
Configuring SSL communications between the hub server and a spoke server	160
Adding the second server as a spoke	161
Enabling replication	161
Completing the implementation	162
Monitoring	162
Daily checklist	162
Periodic checklist	167
Verifying license compliance	172
Tracking system status by using email reports	173
Managing	174
Managing the Operations Center	174
Adding and removing spoke servers	175
Adding a spoke server	175
Removing a spoke server	175
Starting and stopping the web server	176
Restarting the initial configuration wizard	176
Changing the hub server	177
Restoring the configuration to the preconfiguration state	177
Protecting applications, virtual machines, and systems	179
Adding clients	179
Selecting the client software and planning the installation	180
Specifying rules for backing up and archiving client data	181
Viewing policies	182
Editing policies	182
Scheduling backup and archive operations	183
Registering clients	184
Installing and configuring clients	185
Configuring the client to run scheduled operations	186
Configuring communications through a firewall	187
Managing client operations	188
Evaluating errors in client error logs	188
Stopping and restarting the client acceptor	189
Resetting passwords	190
Modifying the scope of a client backup	191

Managing client upgrades	191
Decommissioning a client node	192
Deactivating data to free storage space	194
Managing data storage	194
Auditing a storage pool container	195
Managing inventory capacity	195
Managing memory and processor usage	197
Tuning scheduled activities	197
Managing replication	198
Replication compatibility	198
Enabling node replication	199
Protecting data in directory-container storage pools	199
Modifying replication settings	200
Setting different retention policies	201
Securing the server	202
Security concepts	202
Managing administrators	204
Changing password requirements	205
Securing IBM Spectrum Protect on the system	206
Restricting user access to the server	206
Limiting access through port restrictions	207
Stopping and starting the server	207
Stopping the server	207
Starting the server for maintenance or reconfiguration tasks	208
Planning to upgrade the server	209
Preparing for an outage	210
Implementing a disaster recovery plan	210
Recovering from data loss or system outages	210
Restoring the database	212
Recovering damaged data	213
Repairing storage pools	214
Tape solution	215
Planning	215
Tape planning requirements	216
System requirements for a tape-based solution	216
Hardware requirements	217
Software requirements	220
Planning worksheets	221
Planning for disk storage	224
Planning for tape storage	224
Supported tape devices and libraries	225
Supported tape device configurations	225
Data movement between storage devices	226
Library sharing	226
LAN-free data movement	227
Mixed device types in libraries	227
Different media generations in a library	228
Mixed media and storage pools	229
Required definitions for tape storage devices	229
Planning the storage pool hierarchy	229
Offsite data storage	231
Planning for security	232
Planning for administrator roles	232
Planning for secure communications	233
Planning for storage of encrypted data	233
Planning firewall access	233

Implementing	234
Setting up the system	235
Configuring the storage hardware	236
Installing the server operating system	236
Installing on AIX systems	236
Installing on Linux systems	238
Installing on Windows systems	241
Configuring multipath I/O	241
AIX systems	242
Linux systems	242
Windows systems	244
Creating the user ID for the server	244
Preparing file systems for the server	245
AIX systems	245
Linux systems	246
Windows systems	247
Installing the server and Operations Center	248
Installing on AIX and Linux systems	248
Installing on Windows systems	249
Configuring the server and the Operations Center	249
Configuring the server instance	250
Installing the backup-archive client	250
Setting options for the server	251
Security concepts	252
Configuring the Operations Center	254
Registering the product license	254
Defining data retention rules for your business	255
Defining schedules for server maintenance activities	255
Defining client schedules	259
Attaching tape devices for the server	260
Attaching an automated library device to your system	260
Selecting a tape device driver	261
IBM tape device drivers	261
IBM Spectrum Protect tape device drivers	261
Special file names for tape devices	262
Installing and configuring tape device drivers	263
Installing and configuring IBM device drivers for IBM tape devices	263
AIX systems	264
SCSI and Fibre Channel devices	265
Configuring IBM Spectrum Protect device drivers for autochangers	265
Configuring IBM Spectrum Protect device drivers for tape drives	266
Configuring Fibre Channel SAN-attached devices	267
Linux systems	267
Configuring IBM Spectrum Protect passthru drivers for tape devices and libraries	267
Installing zSeries Linux Fibre Channel adapter (zfcp) device drivers	268
Information about your system's SCSI devices	268
Preventing tape labels from being overwritten	269
Windows systems	269
Preparing to use the IBM Spectrum Protect passthru driver for tape devices and libraries	270
Configuring the IBM Spectrum Protect SCSI driver for tape devices and libraries	270
Configuring libraries for use by a server	271
Defining tape devices	272
Defining libraries and drives	272
Defining libraries	272
Defining drives	273
Defining tape device classes	274

Defining LTO device classes	275
Mixing LTO drives and media in a library	275
Mount limits in LTO mixed-media environments	276
Enabling and disabling drive encryption for LTO Generation 4 or later tape drives	277
Defining 3592 device classes	278
Mixing generations of 3592 drives and media in a single library	278
Controlling data-access speeds for 3592 volumes	279
Enabling and disabling 3592 Generation 2 and later drive encryption	280
Configuring library sharing	280
Example: Library sharing for AIX and Linux servers	281
Example: Library sharing for Windows servers	282
Setting up the library manager server	283
Setting up the library client servers	284
Setting up a storage pool hierarchy	285
Protecting applications, virtual machines, and systems	286
Configuring LAN-free data movement	286
Encryption methods	287
Controlling tape storage operations	288
How IBM Spectrum Protect fills volumes	289
Specifying the estimated capacity of tape volumes	289
Specifying recording formats for tape media	290
Associating library objects with device classes	290
Controlling media-mount operations for tape devices	290
Controlling the number of simultaneously mounted volumes	291
Controlling the amount of time that a volume remains mounted	292
Controlling the amount of time that the server waits for a drive	292
Preempting operations	292
Mount point preemption	293
Volume access preemption	293
Impacts of device changes on the SAN	294
Displaying device information	294
Write-once, read-many tape media	295
WORM-capable drives	295
Check-in of WORM media	296
Restrictions on WORM media	296
Mount failures with WORM media	296
Relabeling WORM media	296
Removing private WORM volumes from a library	296
Creation of DLT WORM volumes	297
Support for short and normal 3592 WORM tapes	297
Querying a device class for the WORM-parameter setting	297
Troubleshooting problems with devices	297
Completing the implementation	298
Monitoring	298
Daily checklist	298
Periodic checklist	302
Monitoring tape alert messages for hardware errors	307
Preventing errors caused by media incompatibility	308
Operations with cleaner cartridges	308
Verifying license compliance	308
Tracking system status by using email reports	310
Managing	310
Managing the Operations Center	311
Managing client operations	311
Evaluating errors in client error logs	312
Stopping and restarting the client acceptor	312

Resetting passwords	313
Managing client upgrades	314
Decommissioning a client node	315
Deactivating data to free storage space	317
Managing data storage	317
Managing inventory capacity	317
Tuning scheduled activities	319
Optimizing operations by enabling collocation of client files	319
Effects of collocation on operations	321
Selecting volumes with collocation enabled	322
Selecting volumes with collocation disabled	323
Collocation settings	324
Collocation of copy storage pools	324
Planning for and enabling collocation	324
Managing tape devices	326
Preparing removable media	326
Labeling tape volumes	327
Checking storage volumes into a library	327
Checking a single volume into a SCSI library	328
Checking in volumes from library storage slots	329
Checking in storage volumes from library entry/exit ports	329
Checking in volumes by using library bar code readers	330
Checking in volumes	330
Checking volumes into a full library with swapping	330
Private volumes and scratch volumes	331
Element addresses for library storage slots	331
Managing volume inventory	332
Controlling access to volumes	332
Reusing tapes	332
Maintaining a supply of scratch volumes	333
Maintaining a supply of volumes in a library that contains WORM media	334
Manage the volume inventory in automated libraries	335
Changing the status of a volume in an automated library	335
Removing volumes from an automated library	336
Maintaining a supply of scratch volumes in an automated library	336
Managing an overflow location	336
Auditing the volume inventory	337
Partially written volumes	338
Shared library operations	338
Server requests for volumes	339
Managing tape drives	341
Updating drives	341
Data validation during read/write operations to tape	342
Supported drives	343
Enabling and disabling logical block protection	343
Read/write operations to volumes	344
Storage pool management in a tape library	345
Cleaning tape drives	345
Methods for cleaning tape drives	346
Configuring the server for drive cleaning in an automated library	346
Checking a cleaner cartridge into a library	347
Operations with cleaner cartridges	308
Resolving errors that are related to drive cleaning	348
Tape drive replacement	348
Deleting tape drives	349
Replacing drives with others of the same type	349

Migrating data to upgraded drives	350
Securing the server	350
Managing administrators	350
Changing password requirements	351
Securing the server on the system	352
Stopping and starting the server	352
Stopping the server	353
Starting the server for maintenance or reconfiguration tasks	353
Planning to upgrade the server	354
Preparing for an outage	355
Preparing for and recovering from a disaster by using DRM.	355
Disaster recovery plan file	356
Recovering the server and client data	358
Recovery drills	359
Restoring the database	360
PDF files	361

## Servers

Servers	361
What's new	361
Operations Center updates	362
Server updates	362
Back up data to Microsoft Azure, a cloud-based object storage system	363
Encrypt client data in a directory-container storage pool	363
Back up a NAS file server to a directory-container storage pool	364
Install IBM Spectrum Protect on the Linux on Power Systems (little endian) operating system	364
Protect your storage environment with an improved security protocol	364
Optimize security with the automatically generated master encryption key	365
Configure a storage environment by using the Tape Solution Guide	365
Schedule automatic updates for backup-archive clients	365
Upgrade your IBM Spectrum Protect server to V8.1.2 before you upgrade clients	366
Deprecated and discontinued server options, commands, and parameters	366
V8.1 release notes	366
Servers	367
Operations Center	368
Devices	369
V8.1 readme files for fix packs	371
Installing and upgrading	371
Implementing an IBM Spectrum Protect solution	371
Availability of features by operating system	371
Installing and upgrading the server	373
AIX: Installing the server	373
AIX: Planning to install the IBM Spectrum Protect server	374
AIX: What you should know first	374
AIX: What you should know about security before you install or upgrade the server	375
AIX: Planning for optimal performance	375
AIX: Planning server hardware and operating system	375
AIX: Planning server database disks	378
AIX: Planning server recovery log disks	380
AIX: Planning container storage pools	381
AIX: Planning DISK or FILE storage pools	387
AIX: Planning storage technology	388
AIX: Installation best practices	390
AIX: Minimum system requirements for AIX systems	391
AIX: Compatibility of the IBM Spectrum Protect server with other DB2 products on the system	393
AIX: IBM Installation Manager	394

AIX: Worksheets for planning details for the server	395
AIX: Capacity planning	395
AIX: Database space requirements	396
AIX: Maximum number of files	396
AIX: Storage pool capacity	398
AIX: The database manager and temporary space	398
AIX: Recovery log space requirements	398
AIX: Active and archive log space	399
AIX: Example: Basic client-store operations	400
AIX: Example: Multiple client sessions	401
AIX: Example: Simultaneous write operations	402
AIX: Example: Basic client store and server operations	403
AIX: Example: Conditions of extreme variation	404
AIX: Example: Full database backups	404
AIX: Example: Data deduplication	405
AIX: Active-log mirror space	409
AIX: Archive-failover log space	409
AIX: Monitoring space utilization for the database and recovery logs	409
AIX: Deleting installation rollback files	410
AIX: Deleting installation rollback files by using a graphical wizard	410
AIX: Deleting installation rollback files by using the command line	411
AIX: Server naming best practices	411
AIX: Installation directories for the IBM Spectrum Protect server	413
AIX: Installing the server components	413
AIX: Obtaining the installation package	413
AIX: Using the installation wizard	414
AIX: Using the console installation wizard	415
AIX: Using silent mode	416
AIX: Installing server language packages	417
AIX: Server language locales	417
AIX: Configuring a language package	418
AIX: Updating a language package	418
AIX: Taking the first steps after you install Version 8.1.2	418
AIX: Creating the user ID and directories for the server instance	419
AIX: Configuring the IBM Spectrum Protect server	420
AIX: Using the configuration wizard	421
AIX: Using the manual configuration steps	421
AIX: Creating the server instance	421
AIX: Configuring server and client communications on UNIX systems	423
AIX: Setting TCP/IP options	423
AIX: Setting shared memory options	424
AIX: Setting Secure Sockets Layer options	424
AIX: Formatting the database and log	425
AIX: Preparing the database manager for database backup	425
AIX: Configuring server options for server database maintenance	427
AIX: Starting the server instance	428
AIX: Verifying access rights and user limits	429
AIX: Starting the server from the instance user ID	430
AIX: Automatically starting servers	430
AIX: Starting the server in maintenance mode	431
AIX: Stopping the server	432
AIX: Registering licenses	432
AIX: Specifying a device class in preparation for database backups	432
AIX: Running multiple server instances on a single system	433
AIX: Monitoring the server	433
AIX: Installing an IBM Spectrum Protect fix pack	434

AIX: Reverting from Version 8.1.2 to a previous server	436
AIX: Reference: DB2 commands for server databases	438
AIX: Uninstalling IBM Spectrum Protect	440
AIX: Uninstalling IBM Spectrum Protect by using a graphical wizard	441
AIX: Uninstalling IBM Spectrum Protect in console mode	441
AIX: Uninstalling IBM Spectrum Protect in silent mode	442
AIX: Uninstalling and reinstalling IBM Spectrum Protect	442
AIX: Uninstalling IBM Installation Manager	443
Linux: Installing the server	444
Linux: Planning to install the IBM Spectrum Protect server	444
Linux: What you should know first	445
Linux: What you should know about security before you install or upgrade the server	445
Linux: Planning for optimal performance	445
Linux: Planning server hardware and operating system	446
Linux: Planning server database disks	449
Linux: Planning server recovery log disks	451
Linux: Planning container storage pools	452
Linux: Planning DISK or FILE storage pools	457
Linux: Planning storage technology	459
Linux: Installation best practices	461
Linux: Minimum system requirements for Linux systems	462
Linux: Minimum Linux X86_64 server requirements	463
Linux: Minimum Linux on System z server requirements	465
Linux: Minimum Linux on Power Systems (little endian) server requirements	466
Linux: Compatibility of the IBM Spectrum Protect server with other DB2 products on the system	468
Linux: IBM Installation Manager	468
Linux: Worksheets for planning details for the server	469
Linux: Capacity planning	470
Linux: Database space requirements	470
Linux: Maximum number of files	471
Linux: Storage pool capacity	472
Linux: The database manager and temporary space	472
Linux: Recovery log space requirements	473
Linux: Active and archive log space	473
Linux: Example: Basic client-store operations	474
Linux: Example: Multiple client sessions	475
Linux: Example: Simultaneous write operations	476
Linux: Example: Basic client store and server operations	477
Linux: Example: Conditions of extreme variation	478
Linux: Example: Full database backups	478
Linux: Example: Data deduplication	479
Linux: Active-log mirror space	483
Linux: Archive-failover log space	483
Linux: Monitoring space utilization for the database and recovery logs	483
Linux: Deleting installation rollback files	484
Linux: Deleting installation rollback files by using a graphical wizard	484
Linux: Deleting installation rollback files by using the command line	485
Linux: Server naming best practices	485
Linux: Installation directories for the IBM Spectrum Protect server	487
Linux: Installing the server components	487
Linux: Obtaining the installation package	487
Linux: Using the installation wizard	488
Linux: Using the console installation wizard	489
Linux: Using silent mode	489
Linux: Installing server language packages	490
Linux: Server language locales	491



Linux: Configuring a language package	491
Linux: Updating a language package	492
Linux: Taking the first steps after you install Version 8.1.2	492
Linux: Tuning kernel parameters for Linux systems	493
Linux: Updating parameters	493
Linux: Suggested values	494
Linux: Creating the user ID and directories for the server instance	494
Linux: Configuring the IBM Spectrum Protect server	495
Linux: Using the configuration wizard	496
Linux: Using the manual configuration steps	496
Linux: Creating the server instance	496
Linux: Configuring server and client communications on UNIX systems	498
Linux: Setting TCP/IP options	498
Linux: Setting shared memory options	499
Linux: Setting Secure Sockets Layer options	500
Linux: Formatting the database and log	500
Linux: Preparing the database manager for database backup	500
Linux: Configuring server options for server database maintenance	502
Linux: Starting the server instance	503
Linux: Verifying access rights and user limits	504
Linux: Starting the server from the instance user ID	505
Linux: Automatically starting servers on Linux systems	505
Linux: Starting the server in maintenance mode	507
Linux: Stopping the server	507
Linux: Registering licenses	508
Linux: Specifying a device class in preparation for database backups	508
Linux: Running multiple server instances on a single system	508
Linux: Monitoring the server	509
Linux: Installing an IBM Spectrum Protect fix pack	510
Linux: Reverting from Version 8.1.2 to a previous server	512
Linux: Reference: DB2 commands for server databases	513
Linux: Uninstalling IBM Spectrum Protect	516
Linux: Uninstalling IBM Spectrum Protect by using a graphical wizard	517
Linux: Uninstalling IBM Spectrum Protect in console mode	517
Linux: Uninstalling IBM Spectrum Protect in silent mode	517
Linux: Uninstalling and reinstalling IBM Spectrum Protect	518
Linux: Uninstalling IBM Installation Manager	519
Windows: Installing the server	519
Windows: Planning to install the IBM Spectrum Protect server	519
Windows: What you should know first	520
Windows: What you should know about security before you install or upgrade the server	520
Windows: Planning for optimal performance	521
Windows: Planning server hardware and operating system	521
Windows: Planning server database disks	524
Windows: Planning server recovery log disks	526
Windows: Planning container storage pools	527
Windows: Planning DISK or FILE storage pools	533
Windows: Planning storage technology	534
Windows: Installation best practices	536
Windows: Minimum system requirements for Windows systems	537
Windows: IBM Installation Manager	539
Windows: Worksheets for planning details for the server	540
Windows: Capacity planning	540
Windows: Database space requirements	541
Windows: Maximum number of files	541
Windows: Storage pool capacity	543

Windows: The database manager and temporary space	543
Windows: Recovery log space requirements	543
Windows: Active and archive log space	544
Windows: Example: Basic client-store operations	545
Windows: Example: Multiple client sessions	546
Windows: Example: Simultaneous write operations	547
Windows: Example: Basic client store and server operations	548
Windows: Example: Conditions of extreme variation	549
Windows: Example: Full database backups	549
Windows: Example: Data deduplication	550
Windows: Active-log mirror space	554
Windows: Archive-failover log space	554
Windows: Monitoring space utilization for the database and recovery logs	554
Windows: Deleting installation rollback files	555
Windows: Deleting installation rollback files by using a graphical wizard	556
Windows: Deleting installation rollback files by using the command line	556
Windows: Server naming best practices	556
Windows: Installation directories for the IBM Spectrum Protect server	557
Windows: Installing the server components	558
Windows: Obtaining the installation package	558
Windows: Using the installation wizard	559
Windows: Using the console installation wizard	559
Windows: Using silent mode	560
Windows: Installing server language packages	561
Windows: Server language locales	561
Windows: Configuring a language package	562
Windows: Updating a language package	562
Windows: Taking the first steps after you install Version 8.1.2	562
Windows: Creating the user ID and directories for the server instance	563
Windows: Configuring the IBM Spectrum Protect server	564
Windows: Using the configuration wizard	565
Windows: Using the manual configuration steps	566
Windows: Creating the server instance	566
Windows: Configuring communications on Windows systems	567
Windows: Setting TCP/IP options	567
Windows: Setting Named Pipes options	568
Windows: Setting Secure Sockets Layer options	568
Windows: Formatting the database and log	568
Windows: Preparing the database manager for database backup	569
Windows: Configuring server options for server database maintenance	570
Windows: Starting the server instance on Windows systems	571
Windows: Configuring the server to start as a Windows service	572
Windows: Starting the server as a Windows service	572
Windows: Manually creating and configuring a Windows service	573
Windows: Starting the server in the foreground	574
Windows: Services associated with the server on Windows systems	574
Windows: Starting the server in maintenance mode	574
Windows: Stopping the server	575
Windows: Registering licenses	575
Windows: Specifying a device class in preparation for database backups	576
Windows: Running multiple server instances on a single system	576
Windows: Monitoring the server	577
Windows: Installing an IBM Spectrum Protect fix pack	577
Windows: Reverting from Version 8.1.2 to a previous server	579
Windows: Reference: DB2 commands for server databases	581
Windows: Uninstalling IBM Spectrum Protect	584

Windows: Uninstalling IBM Spectrum Protect by using a graphical wizard	585
Windows: Uninstalling IBM Spectrum Protect in console mode	585
Windows: Uninstalling IBM Spectrum Protect in silent mode	586
Windows: Uninstalling and reinstalling IBM Spectrum Protect	586
Windows: Uninstalling IBM Installation Manager	587
Upgrading the server to V8.1	587
Upgrading to V8.1	588
Planning the upgrade	589
Preparing the system	589
Installing the server and verifying the upgrade	592
Upgrading the server in a clustered environment	596
Upgrading from V6.3 or V7.1 to V8.1.2 in a clustered environment for AIX with a shared database instance	597
Upgrading from V6.3 to V8.1.2 in a clustered environment for AIX with separate database instances	599
Upgrading from V6.1 to V8.1.2 in a clustered environment for AIX	601
Upgrading to V8.1.2 in a clustered environment for Linux	603
Upgrading from V6.3 or V7.1 to V8.1.2 in a clustered environment for Windows	603
Upgrading from V6.1 to V8.1.2 in a clustered environment for Windows	605
Removing GSKit V7 after upgrading to IBM Spectrum Protect V8.1.2	607
Installing and upgrading the Operations Center	608
Planning to install the Operations Center	609
System requirements for the Operations Center	609
Operations Center computer requirements	610
Hub and spoke server requirements	610
Tips for designing the hub and spoke server configuration	611
Tips for choosing a hub server	612
Operating system requirements	613
Web browser requirements	613
Language requirements	614
Requirements and limitations for IBM Spectrum Protect client management services	615
Administrator IDs that the Operations Center requires	617
IBM Installation Manager	617
Installation checklist	618
Installing the Operations Center	620
Obtaining the Operations Center installation package	620
Installing the Operations Center by using a graphical wizard	621
Installing the Operations Center in console mode	622
Installing the Operations Center in silent mode	622
Upgrading the Operations Center	623
Getting started with the Operations Center	624
Configuring the Operations Center	625
Designating the hub server	625
Adding a spoke server	626
Sending email alerts to administrators	626
Adding customized text to the login screen	628
Enabling REST services	628
Configuring for secure communication	629
Between the Operations Center and the hub server	629
Between the hub server and a spoke server	631
Resetting the password for the Operations Center truststore file	632
Starting and stopping the web server	633
Opening the Operations Center	634
Collecting diagnostic information with the client management service	634
Installing the client management service by using a graphical wizard	635
Installing the client management service in silent mode	636
Verifying the installation	637
Configuring the Operations Center to use the client management service	638

Starting and stopping the client management service _____	638
Uninstalling the client management service _____	639
Configuring the client management service for custom client installations _____	639
Troubleshooting the Operations Center installation _____	640
Graphical installation wizard cannot be started on an AIX system _____	640
Chinese, Japanese, or Korean fonts are displayed incorrectly _____	640
Uninstalling the Operations Center _____	640
Uninstalling the Operations Center by using a graphical wizard _____	640
Uninstalling the Operations Center in console mode _____	641
Uninstalling the Operations Center in silent mode _____	641
Rolling back to a previous version of the Operations Center _____	642
Configuring servers _____	642
Securing the server _____	644
Security concepts _____	645
Managing administrators _____	647
Changing password requirements _____	647
Securing IBM Spectrum Protect on the system _____	648
Restricting user access to the server _____	648
Limiting access through port restrictions _____	649
Securing communications _____	649
SSL and TLS communication _____	650
Configuring storage agents, servers, clients, and the Operations Center to connect to the server by using SSL _____	651
Configuring the server to accept SSL connections _____	652
Configuring clients to communicate with the server by using SSL _____	653
Configuring the server to connect to another server by using SSL _____	653
Configuring the Operations Center to connect to the hub server by using SSL _____	654
Configuring a storage agent to use SSL _____	654
Configuring the client to connect to a storage agent by using SSL _____	655
Authenticating users by using an LDAP server _____	655
Replicating client data to another server _____	656
Replication compatibility _____	657
Enabling node replication _____	657
Protecting data in directory-container storage pools _____	658
Modifying replication settings _____	659
Setting different retention policies _____	659
Configuring clustered environments _____	660
Clustered environment overview _____	661
AIX clustered environment _____	661
Cluster requirements _____	662
PowerHA failover and failback _____	662
Installing and configuring PowerHA SystemMirror for AIX _____	663
Installing and configuring the cluster _____	663
Configuring on the primary node _____	664
Configuring on a secondary node with a shared DB2 instance _____	664
Configuring on a secondary node with a separate DB2 instance _____	665
Installing the server on a production node _____	666
Installing the client on a production node _____	666
Verifying the server configuration _____	667
Setting up the standby node _____	667
Defining the removable media storage devices _____	668
Configuring the cluster manager _____	668
Troubleshooting the PowerHA clustered environment _____	669
Linux clustered environment _____	669
Overview of a two-node clustered environment _____	670
Two-node shared disk topology _____	672
Tivoli System Automation resource groups _____	673

Setting up a cluster	674
Prerequisites for configuring a cluster environment	674
Installing and configuring components	675
Installing server components	675
Configuring the primary node	675
Configuring the secondary node	676
Installing Tivoli System Automation	677
Creating the label for the mount points	677
Installing and configuring Tivoli System Automation	677
Preparing to activate the cluster nodes for the domain	678
Configuring volume group resources	678
Configuring resources that are not in a volume group	679
Activating the base policy	679
Adding mount points to directories	680
Configuring storage resources	681
Adding a storage pool	681
Deleting a storage pool	681
Deleting a mount point	682
Upgrading the server that is configured Tivoli System Automation	682
Windows clustered environment	683
Microsoft Failover Cluster environment overview	683
Tape failover for nodes in a cluster	684
Planning for a clustered environment	685
Cluster configuration worksheet	685
Planning for cluster hardware and software configuration	686
Configuring IBM Spectrum Protect in Microsoft Failover Cluster	687
Setting up IBM Spectrum Protect in a Microsoft Failover Cluster	687
Preparing a cluster resource group for a virtual server	688
Installing IBM Spectrum Protect in a Microsoft Failover Cluster	688
Initializing the server on the primary node	688
Verifying configuration in a Microsoft Failover Cluster	689
Testing failover	689
Maintaining the clustered environment	689
Migrating an existing server into a cluster	690
Adding a server by using backup and restore	690
Managing a virtual server on a cluster	690
Managing tape failover	691
Troubleshooting using the cluster log	691
Configuring clients	691
Adding clients	692
Selecting the client software and planning the installation	692
Specifying rules for backing up and archiving client data	694
Viewing policies	695
Editing policies	695
Scheduling backup and archive operations	696
Registering clients	697
Installing and configuring clients	697
Configuring the client to run scheduled operations	699
Configuring communications through a firewall	700
Customizing policies	701
Policy concepts	701
Retention and expiration of backup versions	702
File expiration and expiration processing	703
Example: Retention when a policy uses only time controls	703
Example: Retention when a policy uses both version and time controls	704
Interactions among policy settings	706

Policy activation after updates	707
Customizing a policy	709
Creating a policy by copying an existing policy	710
Creating a policy domain	710
Controlling client operations through client option sets	711
Configuring storage	712
Types of storage pools	713
Data deduplication options	715
Configuring storage devices	716
Configuring a directory-container storage pool	716
Copying directory-container storage pools to tape	717
Rotating tape volumes offsite without DRM	718
Changing the volume reclamation threshold	719
Reclaiming tape volumes in container-copy storage pools	719
Determining whether to use container-copy storage pools for disaster protection	720
Configuring a cloud-container storage pool	722
Preparing for Amazon with S3 (off premises)	723
Preparing for an Amazon S3 compatible device	724
Preparing for Microsoft Azure (off premises)	725
Preparing for IBM Cloud Object Storage with Swift (off premises)	726
Preparing for IBM Cloud Object Storage with S3 (off premises)	727
Preparing for IBM Cloud Object Storage with S3 (on premises)	727
Preparing for OpenStack with Swift	729
Encrypting data for cloud-container storage pools	729
Optimizing performance for cloud object storage	730
Managing container storage pools	730
Converting a primary storage pool to a container storage pool	732
Cleaning up data in a source storage pool	733
Auditing a storage pool container	734
Storage system requirements and reducing the risk of data corruption	734
Monitoring storage solutions	735
Daily checklist	736
Periodic checklist	740
Verifying license compliance	745
Tracking system status by using email reports	746
Selecting, configuring, and using monitoring tools	747
Managing operations	749
Managing server operations	749
Stopping and starting the server	749
Stopping the server	750
Starting the server for maintenance or reconfiguration tasks	750
Managing inventory capacity	751
Managing memory and processor usage	753
Determining whether Aspera FASP can optimize data transfer in your environment	753
Planning to upgrade the server	755
Tuning scheduled activities	755
Managing client operations	756
Modifying the scope of a client backup	757
Evaluating errors in client error logs	757
Stopping and restarting the client acceptor	757
Resetting passwords	758
Decommissioning a client node	759
Deactivating data to free storage space	761
Managing client upgrades	762
Managing the Operations Center	762
Adding and removing spoke servers	763

Adding a spoke server	763
Removing a spoke server	763
Starting and stopping the web server	764
Restarting the initial configuration wizard	765
Changing the hub server	765
Restoring the configuration to the preconfiguration state	766
Configuring virtual tape libraries	767
Considerations for using virtual tape libraries	767
Storage capacity for virtual tape libraries	768
Drive configuration for virtual tape libraries	768
Adding a virtual tape library to your environment	768
Defining all drives and paths for a single library	769
Example: SCSI library or VTL with a single drive device type	770
Example: VTL or SCSI library with multiple drive device types	771
Protecting NAS file servers	772
NDMP requirements	773
Interfaces for NDMP operations	775
Data formats for NDMP backup operations	775
NDMP operations management	775
Managing NAS file server nodes	776
Managing data movers that are used in NDMP operations	777
Dedicating an IBM Spectrum Protect drive to NDMP operations	778
Storage pool management for NDMP operations	778
Managing tables of contents	779
Preventing inactive NDMP connections from closing	779
Enabling TCP keepalive	780
Specifying connection idle time (AIX, Linux, and Windows)	780
Configuring IBM Spectrum Protect for NDMP operations	780
In a nonclustered environment	780
Configuring an IBM Spectrum Protect policy for NDMP operations	781
Policies for backups initiated with an IBM Spectrum Protect server	782
Policies for backups initiated with the client interface	783
Determination of the NAS backup location	783
Tape libraries and drives for NDMP operations	785
Determining library drive usage when backing up to NAS-attached libraries	785
Configuring a tape library for NDMP operations	786
Attaching tape library robotics for NAS-attached libraries	788
Configuration 1: SCSI library connected to the IBM Spectrum Protect server	789
Configuration 2: SCSI library connected to the NAS file server	789
Configuration 3: 349x library connected to the IBM Spectrum Protect server	790
Configuration 4: ACSLS library connected to the IBM Spectrum Protect server	790
Registering NAS nodes with the IBM Spectrum Protect server	791
Defining a data mover for a NAS file server	791
Defining paths for NDMP operations	792
Defining paths to drives	792
Drives attached to a file server and the IBM Spectrum Protect server	792
Drives attached only to a file server	793
Obtaining names for devices attached to a file server	794
Defining paths to libraries	795
Scheduling NDMP operations	795
Defining virtual file spaces	796
Backing up data with the tape-to-tape function	796
Moving data with the tape-to-tape copy function	796
In a NetApp clustered environment	797
Configuring full cluster backups to tape devices	798
Configuring full cluster backups to an IBM Spectrum Protect server	800

Configuring partial cluster backups to an IBM Spectrum Protect server	801
Reconfiguring IBM Spectrum Protect to optimize clustered backups	802
Backing up and restoring NAS file servers using NDMP	804
NAS file servers: backups to a single IBM Spectrum Protect server	805
Backing up NDMP file servers to an IBM Spectrum Protect server	806
File-level backup and restore for NDMP operations	806
Interfaces for file-level restore operations	807
International characters for NetApp file servers	807
File-level restore operations from a directory-level backup image	808
Directory-level backup and restore operations	808
Directory-level backup and restore for NDMP operations	809
Backing up and restoring with snapshots	809
Backup and restore operations by using the NetApp SnapMirror to Tape feature	809
NDMP backup operations using Celerra file server-integrated checkpoints	810
Replicating NAS nodes	810
Data protection with the NetApp SnapLock feature	811
Reclamation and the SnapLock feature	812
Retention periods	812
Configuration of the SnapLock feature for event-based retention	814
Continuous data protection with the SnapLock feature	814
Setting up SnapLock volumes as IBM Spectrum Protect WORM FILE volumes	815
Repairing and recovering data	815
Repairing storage pools from a target replication server	816
Repairing storage pools from container-copy storage pool volumes	817
Repairing storage pools in an environment with both a replication server and container-copy storage pool volumes	819
Repairing storage pools on a target replication server	820
Repairing after a disaster	821
Repairing from container-copy storage pool volumes	822
Repairing from a target replication server	822
Repairing in an environment with both a replication server and container-copy storage pool volumes	824
Replacing a damaged container-copy storage pool tape volume	825
Server commands, options, and utilities	825
Managing the server from the command line	826
Issuing commands from the administrative client	827
Starting and stopping the administrative client	827
Monitoring server activities from the administrative client	828
Monitoring removable-media mounts from the administrative client	828
Processing individual commands from the administrative client	828
Processing a series of commands from the administrative client	829
Formatting output from commands	829
Saving command output to a specified location	829
Administrative client options	830
Issuing commands from the Operations Center	832
Issuing commands from the server console	832
Entering administrative commands	832
Reading syntax diagrams	833
Using continuation characters to enter long commands	836
Naming IBM Spectrum Protect objects	837
Using wildcard characters to specify object names	837
Specifying descriptions in keyword parameters	838
Controlling command processing	839
Server command processing	839
Stopping background processes	840
Performing tasks concurrently on multiple servers	840
Privilege classes for commands	842
Commands requiring system privilege	842



Commands requiring policy privilege	845
Commands requiring storage privilege	845
Commands requiring operator privilege	846
Commands any administrator can issue	847
Administrative commands	847
ACCEPT DATE (Accepts the current system date)	851
ACTIVATE POLICYSET (Activate a new policy set)	852
ASSIGN DEFMGMTCLASS (Assign a default management class)	853
AUDIT commands	854
AUDIT CONTAINER commands	854
Cloud-container audit	854
Directory-container audit	859
AUDIT LDAPDIRECTORY (Audit an LDAP directory server)	862
AUDIT LIBRARY (Audit volume inventories in an automated library)	864
AUDIT LIBVOLUME (Verify database information for a tape volume)	866
AUDIT LICENSES (Audit server storage usage)	867
AUDIT VOLUME (Verify database information for a storage pool volume)	868
BACKUP commands	872
BACKUP DB (Back up the database)	872
BACKUP DEVCONFIG (Create backup copies of device configuration information)	876
BACKUP NODE (Back up a NAS node)	878
BACKUP STGPOOL (Back up primary storage pool data to a copy storage pool)	881
BACKUP VOLHISTORY (Save sequential volume history information)	884
BEGIN EVENTLOGGING (Begin logging events)	885
CANCEL commands	886
CANCEL EXPIRATION (Cancel an expiration process)	887
CANCEL EXPORT (Delete a suspended export operation)	887
CANCEL PROCESS (Cancel an administrative process)	888
CANCEL REPLICATION (Cancel node replication processes)	890
CANCEL REQUEST (Cancel one or more mount requests)	890
CANCEL RESTORE (Cancel a restartable restore session)	891
CANCEL SESSION (Cancel one or more client sessions)	892
CHECKIN LIBVOLUME (Check a storage volume into a library)	892
CHECKOUT LIBVOLUME (Check a storage volume out of a library)	898
CLEAN DRIVE (Clean a drive)	902
COMMIT (Control committing of commands in a macro)	903
CONVERT STGPOOL (Convert a storage pool to a container storage pool)	904
COPY commands	905
COPY ACTIVATEDATA (Copy active backup data from a primary storage pool to an active-data pool)	905
COPY CLOPTSET (Copy a client option set)	908
COPY DOMAIN (Copy a policy domain)	909
COPY MGMTCLASS (Copy a management class)	910
COPY POLICYSET (Copy a policy set)	911
COPY PROFILE (Copy a profile)	912
COPY SCHEDULE (Copy a client or an administrative command schedule)	913
COPY SCHEDULE (Create a copy of a schedule for client operations)	913
COPY SCHEDULE (Create a copy of a schedule for administrative operations)	914
COPY SCRIPT (Copy an IBM Spectrum Protect script)	915
COPY SERVERGROUP (Copy a server group)	916
DEACTIVATE DATA (Deactivate data for a client node)	916
DECOMMISSION commands	918
DECOMMISSION NODE (Decommission an application or system)	918
DECOMMISSION VM (Decommission a virtual machine)	920
DEFINE commands	921
DEFINE ALERTTRIGGER (Define an alert trigger)	922
DEFINE ASSOCIATION (Associate client nodes with a schedule)	924

DEFINE BACKUPSET (Define a backup set)	925
DEFINE CLIENTACTION (Define a one-time client action)	928
DEFINE CLIENTOPT (Define an option to an option set)	932
DEFINE CLOPTSET (Define a client option set name)	934
DEFINE COLLOGROUP (Define a collocation group)	935
DEFINE COLLOCMEMBER	936
DEFINE COPYGROUP (Define a copy group)	938
DEFINE COPYGROUP (Define a backup copy group)	939
DEFINE COPYGROUP (Define an archive copy group)	942
DEFINE DATAMOVER (Define a data mover)	944
DEFINE DEVCLASS (Define a device class)	947
3590	947
3592	950
4MM	955
8MM	958
Centera	962
DLT	964
Ecartridge	968
File	972
Generictape	975
LTO	976
NAS	981
Removablefile	983
Server	985
VolSafe	986
DEFINE DEVCLASS - z/OS media server (Define device class for z/OS media server)	989
3590, for z/OS media server	990
3592, for z/OS media server	993
ECARTRIDGE, for z/OS media server	997
FILE, for z/OS media server	1002
DEFINE DOMAIN (Define a new policy domain)	1004
DEFINE DRIVE (Define a drive to a library)	1005
DEFINE EVENTSERVER (Define a server as the event server)	1009
DEFINE GRPMEMBER (Add a server to a server group)	1010
DEFINE LIBRARY (Define a library)	1011
349X	1012
ACSLs	1014
EXTERNAL	1016
FILE	1018
MANUAL	1018
SCSI	1020
SHARED	1023
VTL	1023
ZOSMEDIA	1026
DEFINE MACHINE (Define machine information for disaster recovery)	1027
DEFINE MACHNODEASSOCIATION (Associate a node with a machine)	1028
DEFINE MGMTCLASS (Define a management class)	1029
DEFINE NODEGROUP (Define a node group)	1031
DEFINE NODEGROUPMEMBER (Define node group member)	1032
DEFINE PATH (Define a path)	1033
Destination is a drive	1033
Destination is a library	1038
Destination is a ZOSMEDIA library	1040
DEFINE POLICYSET (Define a policy set)	1041
DEFINE PROFASSOCIATION (Define a profile association)	1042
DEFINE PROFILE (Define a profile)	1046

DEFINE RECMEDMACHASSOCIATION (Associate recovery media with a machine)	1047
DEFINE RECOVERYMEDIA (Define recovery media)	1048
DEFINE SCHEDULE (Define a client or an administrative command schedule)	1049
DEFINE SCHEDULE (Define a client schedule)	1050
DEFINE SCHEDULE (Define a schedule for an administrative command)	1060
DEFINE SCRATCHPADENTRY (Define a scratch pad entry)	1067
DEFINE SCRIPT (Define an IBM Spectrum Protect script)	1068
DEFINE SERVER (Define a server for server-to-server communications)	1070
DEFINE SERVERGROUP (Define a server group)	1076
DEFINE SPACETRIGGER (Define the space trigger)	1077
DEFINE STATUSTHRESHOLD (Define a status monitoring threshold)	1079
DEFINE STGPOOL (Define a storage pool)	1082
Cloud-container storage pool	1083
Directory-container storage pool	1087
Container-copy storage pool	1091
Primary random-access pool	1094
Primary sequential-access pool	1101
Copy pool	1114
Active-data pool	1120
DEFINE STGPOOLDIRECTORY (Define a storage pool directory)	1125
DEFINE SUBSCRIPTION (Define a profile subscription)	1126
DEFINE VIRTUALFSMAPPING (Define a virtual file space mapping)	1128
DEFINE VOLUME (Define a volume in a storage pool)	1129
DELETE commands	1135
DELETE ALERTTRIGGER (Remove a message from an alert trigger)	1135
DELETE ASSOCIATION (Delete the node association to a schedule)	1136
DELETE BACKUPSET (Delete a backup set)	1137
DELETE CLIENTOPT (Delete an option in an option set)	1140
DELETE CLOPTSET (Delete a client option set)	1141
DELETE COLLOCGROUP (Delete a collocation group)	1142
DELETE COLLOCMEMBER (Delete collocation group member)	1143
DELETE COPYGROUP (Delete a backup or archive copy group)	1145
DELETE DATAMOVER (Delete a data mover)	1146
DELETE DEDUPSTATS (Delete data deduplication statistics)	1147
DELETE DEVCLASS (Delete a device class)	1150
DELETE DOMAIN (Delete a policy domain)	1151
DELETE DRIVE (Delete a drive from a library)	1151
DELETE EVENT (Delete event records)	1152
DELETE EVENTSERVER (Delete the definition of the event server)	1154
DELETE FILESPACE (Delete client node data from the server)	1154
DELETE GRPMEMBER (Delete a server from a server group)	1157
DELETE LIBRARY (Delete a library)	1158
DELETE MACHINE (Delete machine information)	1159
DELETE MACHNODEASSOCIATION (Delete association between a machine and a node)	1160
DELETE MGMTCLASS (Delete a management class)	1160
DELETE NODEGROUP (Delete a node group)	1161
DELETE NODEGROUPMEMBER (Delete node group member)	1162
DELETE PATH (Delete a path)	1163
DELETE POLICYSET (Delete a policy set)	1164
DELETE PROFASSOCIATION (Delete a profile association)	1165
DELETE PROFILE (Delete a profile)	1167
DELETE RECMEDMACHASSOCIATION (Delete recovery media and machine association)	1168
DELETE RECOVERYMEDIA (Delete recovery media)	1169
DELETE SCHEDULE (Delete a client or an administrative command schedule)	1170
DELETE SCHEDULE (Delete a client schedule)	1170
DELETE SCHEDULE (Delete an administrative schedule)	1170

DELETE SCRATCHPADENTRY (Delete a scratch pad entry)	1171
DELETE SCRIPT (Delete command lines from a script or delete the entire script)	1172
DELETE SERVER (Delete a server definition)	1173
DELETE SERVERGROUP (Delete a server group)	1173
DELETE SPACETRIGGER (Delete the storage pool space triggers)	1174
DELETE STATUSTHRESHOLD (Delete a status monitoring threshold)	1175
DELETE STGPOOL (Delete a storage pool)	1176
DELETE STGPOOLDIRECTORY (Deleting a storage pool directory)	1177
DELETE SUBSCRIBER (Delete subscriptions from a configuration manager database)	1178
DELETE SUBSCRIPTION (Delete a profile subscription)	1179
DELETE VIRTUALFSMAPPING (Delete a virtual file space mapping)	1180
DELETE VOLHISTORY (Delete sequential volume history information)	1180
DELETE VOLUME (Delete a storage pool volume)	1184
DISABLE commands	1186
DISABLE EVENTS (Disable events for event logging)	1186
DISABLE REPLICATION (Prevent outbound replication processing on a server)	1189
DISABLE SESSIONS (Prevent new sessions from accessing IBM Spectrum Protect)	1190
DISMOUNT command	1191
DISPLAY OBJNAME (Display a full object name)	1191
ENABLE commands	1192
ENABLE EVENTS (Enable server or client events for logging)	1192
ENABLE REPLICATION (Allow outbound replication processing on a server)	1194
ENABLE SESSIONS (Resume user activity on the server)	1195
ENCRYPT STGPOOL (Encrypt data in a storage pool)	1197
END EVENTLOGGING (Stop logging events)	1198
EXPIRE INVENTORY (Manually start inventory expiration processing)	1199
EXPORT commands	1202
EXPORT ADMIN (Export administrator information)	1203
EXPORT ADMIN (Export administrator definitions to sequential media)	1204
EXPORT ADMIN (Export administrator information directly to another server)	1206
EXPORT NODE (Export client node information)	1208
EXPORT NODE (Export node definitions to sequential media)	1210
EXPORT NODE (Export node definitions or file data directly to another server)	1217
EXPORT POLICY (Export policy information)	1224
EXPORT POLICY (Export policy information to sequential media)	1225
EXPORT POLICY (Export a policy directly to another server)	1227
EXPORT SERVER (Export server information)	1228
EXPORT SERVER (Export a server to sequential media)	1230
EXPORT SERVER (Export server control information and client file data to another server)	1236
EXTEND DBSPACE (Increase space for the database)	1241
GENERATE commands	1243
GENERATE BACKUPSET (Generate a backup set of Backup-Archive Client data)	1243
GENERATE BACKUPSETTOC (Generate a table of contents for a backup set)	1250
GENERATE DEDUPSTATS (Generate data deduplication statistics)	1251
GRANT commands	1253
GRANT AUTHORITY (Add administrator authority)	1253
GRANT PROXYNODE (Grant proxy authority to a client node)	1256
HALT (Shut down the server)	1257
HELP (Get help on commands and error messages)	1258
IDENTIFY DUPLICATES (Identify duplicate data in a storage pool)	1259
IMPORT commands	1262
IMPORT ADMIN (Import administrator information)	1263
IMPORT NODE (Import client node information)	1265
IMPORT POLICY (Import policy information)	1270
IMPORT SERVER (Import server information)	1273
INSERT MACHINE (Insert machine characteristics information or recovery instructions)	1277

ISSUE MESSAGE (Issue a message from a server script)	1278
LABEL LIBVOLUME (Label a library volume)	1279
LOAD DEFALERTTRIGGERS (Load the default set of alert triggers)	1284
LOCK commands	1285
LOCK ADMIN (Lock out an administrator)	1285
LOCK NODE (Lock out a client node)	1286
LOCK PROFILE (Lock a profile)	1287
MACRO (Invoke a macro)	1288
MIGRATE STGPOOL (Migrate storage pool to next storage pool)	1289
MOVE commands	1292
MOVE CONTAINER (Move a container)	1292
MOVE DATA (Move files on a storage pool volume)	1293
MOVE DRMEDIA (Move disaster recovery media offsite and back onsite)	1296
MOVE GRPMEMBER (Move a server group member)	1308
MOVE MEDIA (Move sequential-access storage pool media)	1309
MOVE NODEDATA (Move data by node in a sequential access storage pool)	1315
File spaces for one or more nodes or a collocation group	1316
Selected file spaces of a single node	1318
NOTIFY SUBSCRIBERS (Notify managed servers to update profiles)	1321
PERFORM LIBACTION (Define or delete all drives and paths for a library)	1322
PING SERVER (Test the connection between servers)	1325
PREPARE (Create a recovery plan file)	1326
PROTECT STGPOOL (Protect data that belongs to a storage pool)	1332
QUERY commands	1336
QUERY ACTLOG (Query the activity log)	1338
QUERY ADMIN (Display administrator information)	1343
QUERY ALERTTRIGGER (Query the list of defined alert triggers)	1346
QUERY ALERTSTATUS (Query the status of an alert)	1347
QUERY ASSOCIATION (Query client node associations with a schedule)	1351
QUERY AUDITOCAPACITY (Query client node storage utilization)	1352
QUERY BACKUPSET (Query a backup set)	1354
QUERY BACKUPSETCONTENTS (Query contents of a backup set)	1358
QUERY CLEANUP (Query the cleanup that is required in a source storage pool)	1359
QUERY CLOPTSET (Query a client option set)	1361
QUERY COLLOGGROUP (Query a collocation group)	1362
QUERY CONTAINER (Display container information)	1364
QUERY CONTENT (Query the contents of a storage pool volume)	1368
QUERY CONVERSION (Query conversion status of a storage pool)	1373
QUERY COPYGROUP (Query copy groups)	1374
QUERY DAMAGED (Query damaged in a directory-container or cloud-container storage pool)	1378
QUERY DATAMOVER (Display data mover definitions)	1380
QUERY DB (Display database information)	1383
QUERY DBSPACE (Display database storage space)	1385
QUERY DEDUPSTATS (Query data deduplication statistics)	1386
QUERY DEVCLASS (Display information on one or more device classes)	1391
QUERY DIRSPACE (Query storage utilization of FILE directories)	1395
QUERY DOMAIN (Query a policy domain)	1396
QUERY DRIVE (Query information about a drive)	1398
QUERY DRMEDIA (Query disaster recovery media)	1401
QUERY DRMSTATUS (Query disaster recovery manager system parameters)	1408
QUERY ENABLED (Query enabled events)	1410
QUERY EVENT (Query scheduled and completed events)	1412
QUERY EVENT (Display client schedules)	1412
QUERY EVENT (Display administrative event schedules)	1418
QUERY EVENTRULES (Query rules for server or client events)	1421
QUERY EVENTSERVER (Query the event server)	1423

QUERY EXPORT (Query for active or suspended export operations)	1423
QUERY EXTENTUPDATES (Query updated data extents)	1428
QUERY FILESPACE (Query one or more file spaces)	1429
QUERY LIBRARY (Query a library)	1435
QUERY LIBVOLUME (Query a library volume)	1437
QUERY LICENSE (Display license information)	1439
QUERY LOG (Display information about the recovery log)	1442
QUERY MACHINE (Query machine information)	1444
QUERY MEDIA (Query sequential-access storage pool media)	1446
QUERY MGMTCLASS (Query a management class)	1451
QUERY MONITORSETTINGS (Query the configuration settings for monitoring alerts and server status)	1453
QUERY MONITORSTATUS (Query the monitoring status)	1455
QUERY MOUNT (Display information on mounted sequential access volumes)	1458
QUERY NASBACKUP (Query NAS backup images)	1460
QUERY NODE (Query nodes)	1463
QUERY NODEDATA (Query client data in volumes)	1472
QUERY NODEGROUP (Query a node group)	1474
QUERY OCCUPANCY (Query client file spaces in storage pools)	1476
QUERY OPTION (Query server options)	1479
QUERY PATH (Display a path definition)	1480
QUERY POLICYSET (Query a policy set)	1483
QUERY PROCESS (Query one or more server processes)	1485
QUERY PROFILE (Query a profile)	1489
QUERY PROTECTSTATUS (Query the status of storage pool protection)	1492
QUERY PROXYNODE (Query proxy authority for a client node)	1493
QUERY PVUESTIMATE (Display processor value unit estimate)	1494
QUERY RECOVERYMEDIA (Query recovery media)	1497
QUERY REPLICATION (Query node replication processes)	1499
QUERY REPLNODE (Display information about replication status for a client node)	1508
QUERY REPLRULE (Query replication rules)	1510
QUERY REPLSERVER (Query a replication server)	1511
QUERY REQUEST (Query one or more pending mount requests)	1513
QUERY RESTORE (Query restartable restore sessions)	1515
QUERY RPFCONTENT (Query recovery plan file contents stored on a target server)	1516
QUERY RPFFILE (Query recovery plan file information stored on a target server)	1518
QUERY SAN (Query the devices on the SAN)	1520
QUERY SCHEDULE (Query schedules)	1522
QUERY SCHEDULE (Query client schedules)	1522
QUERY SCHEDULE (Query an administrative schedule)	1525
QUERY SCRATCHPADENTRY (Query a scratch pad entry)	1527
QUERY SCRIPT (Query IBM Spectrum Protect scripts)	1529
QUERY SERVER (Query a server)	1531
QUERY SERVERGROUP (Query a server group)	1534
QUERY SESSION (Query client sessions)	1535
QUERY SHREDSTATUS (Query shredding status)	1539
QUERY SPACETRIGGER (Query the space triggers)	1540
QUERY STATUS (Query system parameters)	1542
QUERY STATUSTHRESHOLD (Query status monitoring thresholds)	1550
QUERY STGPOOL (Query storage pools)	1553
QUERY STGPOOLDIRECTORY (Query a storage pool directory)	1566
QUERY SUBSCRIBER (Display subscriber information)	1568
QUERY SUBSCRIPTION (Display subscription information)	1570
QUERY SYSTEM (Query the system configuration and capacity)	1571
QUERY TAPEALERTMSG (Display status of SET TAPEALERTMSG command)	1572
QUERY TOC (Display table of contents for a backup image)	1573
QUERY VIRTUALFSMAPPING (Query a virtual file space mapping)	1575

QUERY VOLHISTORY (Display sequential volume history information)	1576
QUERY VOLUME (Query storage pool volumes)	1582
QUIT (End the interactive mode of the administrative client)	1588
RECLAIM STGPOOL (Reclaim volumes in a sequential-access storage pool)	1588
RECONCILE VOLUMES (Reconcile differences in the virtual volume definitions)	1590
REGISTER commands	1592
REGISTER ADMIN (Register an administrator ID)	1592
REGISTER LICENSE (Register a new license)	1596
REGISTER NODE (Register a node)	1597
REMOVE commands	1611
REMOVE ADMIN (Delete an administrative user ID)	1611
REMOVE DAMAGED (Remove damaged data from a source storage pool)	1612
REMOVE NODE (Delete a node or an associated machine node)	1613
REMOVE REPLNODE (Remove a client node from replication)	1615
REMOVE REPLSERVER (Remove a replication server)	1616
RENAME commands	1617
RENAME ADMIN (Rename an administrator)	1617
RENAME FILESPACE (Rename a client file space on the server)	1618
RENAME NODE (Rename a node)	1620
RENAME SCRIPT (Rename an IBM Spectrum Protect script)	1621
RENAME SERVERGROUP (Rename a server group)	1622
RENAME STGPOOL (Change the name of a storage pool)	1623
REPAIR STGPOOL (Repair a directory-container storage pool)	1624
REPLICATE NODE (Replicate data in file spaces that belong to a client node)	1626
REPLY (Allow a request to continue processing)	1633
RESET PASSEXP (Reset password expiration)	1634
RESTART EXPORT (Restart a suspended export operation)	1635
RESTORE commands	1636
RESTORE NODE (Restore a NAS node)	1636
RESTORE STGPOOL (Restore storage pool data from a copy pool or an active-data pool)	1640
RESTORE VOLUME (Restore primary volume data from a copy pool or an active-data pool)	1643
REVOKE commands	1646
REVOKE AUTHORITY (Remove administrator authority)	1646
REVOKE PROXYNODE (Revoke proxy authority for a client node)	1649
ROLLBACK (Rollback uncommitted changes in a macro)	1649
RUN (Run an IBM Spectrum Protect script)	1650
SELECT (Perform an SQL query of the IBM Spectrum Protect database)	1652
SET commands	1660
SET ACCOUNTING (Set accounting records on or off)	1661
SET ACTLOGRETENTION (Set the retention period or the size of the activity log)	1662
SET ALERTACTIVEDURATION (Set the duration of an active alert)	1663
SET ALERTCLOSEDDURATION (Set the duration of a closed alert)	1664
SET ALERTEMAIL (Set the alert monitor to email alerts to administrators)	1665
SET ALERTEMAILFROMADDR (Set the email address of the sender)	1666
SET ALERTEMAILSMTPHOST (Set the SMTP mail server host name)	1666
SET ALERTEMAILSMTPPORT (Set the SMTP mail server host port)	1667
SET ALERTSUMMARYTOADMINS (Set the list of administrators to receive alert summaries by email)	1668
SET ALERTINACTIVEDURATION (Set the duration of an inactive alert)	1668
SET ALERTMONITOR (Set the alert monitor to on or off)	1669
SET ALERTUPDATEINTERVAL (Set how often the alert monitor updates and prunes alerts)	1670
SET ARCHIVERETENTIONPROTECTION (Activate data retention protection)	1671
SET ARREPLRULEDEFAULT (Set the server replication rule for archive data)	1672
SET BKREPLRULEDEFAULT (Set the server replication rule for backup data)	1673
SET CLIENTACTDURATION (Set the duration period for the client action)	1674
SET CONFIGMANAGER (Specify a configuration manager)	1675
SET CONFIGREFRESH (Set managed server configuration refresh)	1676

SET CONTEXTMESSAGING (Set message context reporting on or off)	1677
SET CPUINFOREFRESH (Refresh interval for the client workstation information scan)	1678
SET CROSSDEFINE (Specifies whether to cross-define servers)	1678
SET DBRECOVERY (Set the device class for automatic backups)	1679
SET DEDUPVERIFICATIONLEVEL (Set the percentage of extents to verify)	1681
SET DEFAULTAUTHENTICATION (Set the default authentication method for REGISTER NODE and REGISTER ADMIN commands)	1682
SET DISSIMILARPOLICIES (Enable the policies on the target replication server to manage replicated data)	1683
SET DRMACTIVEDATASTGPOOL (Specify the active-data pools to be managed by DRM)	1684
SET DRMCHECKLABEL (Specify label checking)	1685
SET DRMCMDFILENAME (Specify the name of a file to contain commands)	1685
SET DRMCOPYCONTAINERSTGPOOL (Specify the container-copy storage pools to be processed by DRM commands)	1686
SET DRMCOPYSTGPOOL (Specify the copy storage pools to be managed by DRM)	1687
SET DRMCOURIERNAME (Specify the courier name)	1688
SET DRMDBBACKUPEXPIREDAYS (Specify DB backup series expiration)	1688
SET DRMFILEPROCESS (Specify file processing)	1689
SET DRMINSTRPREFIX (Specify the prefix for recovery instructions file names)	1690
SET DRMNOTMOUNTABLENAME (Specify the not mountable location name)	1692
SET DRMPPLANPREFIX (Specify a prefix for recovery plan file names)	1692
SET DRMPPLANVPOSTFIX (Specify replacement volume names)	1694
SET DRMPRIMSTGPOOL (Specify the primary storage pools to be managed by DRM)	1695
SET DRMRPFEXPIREDAYS (Set criteria for recovery plan file expiration)	1696
SET DRMVaultNAME (Specify the vault name)	1697
SET EVENTRETENTION (Set the retention period for event records)	1698
SET FAILOVERHLADDRESS (Set a failover high level address)	1698
SET INVALIDPWLIMIT (Set the number of invalid logon attempts)	1699
SET LDAPPASSWORD (Set the LDAP password for the server)	1700
SET LDAPUSER (Specify an ID for an LDAP directory server)	1701
SET LICENSEAUDITPERIOD (Set license audit period)	1702
SET MAXCMDRETRIES (Set the maximum number of command retries)	1702
SET MAXSCHEDESESSIONS (Set maximum scheduled sessions)	1703
SET MINPWLENGTH (Set minimum password length)	1704
SET MONITOREDSEVERGROUP (Set the group of monitored servers)	1705
SET MONITORINGADMIN (Set the name of the monitoring administrator)	1705
SET NODEATRISKINTERVAL (Specifies at-risk mode for an individual node)	1706
SET PASSEXP (Set password expiration date)	1708
SET PRODUCTOFFERING (Set the product offering that is licensed to your enterprise)	1709
SET QUERYSCHEDPERIOD (Set query period for polling client nodes)	1710
SET RANDOMIZE (Set randomization of scheduled start times)	1711
SET REPLRECOVERDAMAGED (Specify whether damaged files are recovered from a replication server)	1712
SET REPLRETENTION (Set the retention period for replication records)	1714
SET REPLSERVER (Set the target replication server)	1715
SET RETRYPERIOD (Set time between retry attempts)	1716
SET SCHEDMODES (Select a central scheduling mode)	1716
SET SCRATCHPADRETENTION (Set scratch pad retention time)	1717
SET SERVERHLADDRESS (Set the high-level address of a server)	1718
SET SERVERLLADDRESS (Set the low-level address of a server)	1719
SET SERVERNAME (Specify the server name)	1719
SET SERVERPASSWORD (Set password for server)	1720
SET SPREPLRULEDEFAULT (Set the server replication rule for space-managed data)	1721
SET STATUSATRISKINTERVAL (Specifies whether to enable client at-risk activity interval evaluation)	1722
SET STATUSMONITOR (Specifies whether to enable status monitoring)	1723
SET STATUSREFRESHINTERVAL (Set refresh interval for status monitoring)	1724
SET STATUSSKIPASFALURE (Specifies whether to use client at-risk skipped files as failure evaluation)	1725
SET SUBFILE (Set subfile backup for client nodes)	1726
SET SUMMARYRETENTION (Set number of days to keep data in activity summary table)	1727



SET TAPEALERTMSG (Set tape alert messages on or off)	1728
SET TOCLOADRETENTION (Set load retention period for table of contents)	1729
SET VMATRISKINTERVAL (Specifies the at-risk mode for an individual VM filespace)	1729
SETOPT (Set a server option for dynamic update)	1731
SHRED DATA (Shred data)	1732
SUSPEND EXPORT (Suspend a currently running export operation)	1734
UNLOCK commands	1734
UNLOCK ADMIN (Unlock an administrator)	1735
UNLOCK NODE (Unlock a client node)	1736
UNLOCK PROFILE (Unlock a profile)	1736
UPDATE commands	1737
UPDATE ALERTTRIGGER (Update a defined alert trigger)	1738
UPDATE ALERTSTATUS (Update the status of an alert)	1740
UPDATE ADMIN (Update an administrator)	1741
UPDATE BACKUPSET (Update a retention value assigned to a backup set)	1744
UPDATE CLIENTOPT (Update a client option sequence number)	1748
UPDATE CLOPTSET (Update a client option set description)	1749
UPDATE COLLOGROUP (Update a collocation group)	1750
UPDATE COPYGROUP (Update a copy group)	1751
UPDATE COPYGROUP (Update a backup copy group)	1751
UPDATE COPYGROUP (Update a defined archive copy group)	1754
UPDATE DATAMOVER (Update a data mover)	1756
UPDATE DEVCLASS (Update the attributes of a device class)	1757
3590	1758
3592	1761
4MM	1765
8MM	1768
Centera	1772
DLT	1774
Ecartridge	1777
File	1782
Generictape	1785
LTO	1787
NAS	1791
Removablefile	1793
Server	1794
VolSafe	1796
UPDATE DEVCLASS - z/OS media server (Update device class for z/OS media server)	1799
3590, for z/OS media server	1799
3592, for z/OS media server	1802
ECARTRIDGE, for z/OS media server	1806
FILE, for z/OS media server	1810
UPDATE DOMAIN (Update a policy domain)	1812
UPDATE DRIVE (Update a drive)	1813
UPDATE FILESPACE (Update file-space node-replication rules)	1816
UPDATE LIBRARY (Update a library)	1820
349X	1821
ACSLs	1822
EXTERNAL	1824
FILE	1825
MANUAL	1825
SCSI	1826
SHARED	1829
VTL	1829
UPDATE LIBVOLUME (Change the status of a storage volume)	1831
UPDATE MACHINE (Update machine information)	1832

UPDATE MGMTCLASS (Update a management class)	1834
UPDATE NODE (Update node attributes)	1835
UPDATE NODEGROUP (Update a node group)	1850
UPDATE PATH (Change a path)	1851
Destination is a drive	1851
Destination is a library	1855
Destination is a ZOSMEDIA library	1857
UPDATE POLICYSET (Update a policy set description)	1858
UPDATE PROFILE (Update a profile description)	1859
UPDATE RECOVERYMEDIA (Update recovery media)	1860
UPDATE REPLRULE (Update replication rules)	1861
UPDATE SCHEDULE (Update a schedule)	1862
UPDATE SCHEDULE (Update a client schedule)	1862
UPDATE SCHEDULE (Update an administrative schedule)	1872
UPDATE SCRATCHPADENTRY (Update a scratch pad entry)	1879
UPDATE SCRIPT (Update an IBM Spectrum Protect script)	1880
UPDATE SERVER (Update a server defined for server-to-server communications)	1882
UPDATE SERVERGROUP (Update a server group description)	1886
UPDATE SPACETRIGGER (Update the space triggers)	1887
UPDATE STATUSTHRESHOLD (Update a status monitoring threshold)	1888
UPDATE STGPOOL (Update a storage pool)	1891
Cloud-container storage pool	1892
Directory-container storage pool	1895
Container-copy storage pool	1899
Primary random-access pool	1901
Primary sequential-access pool	1908
Copy pool	1919
Active-data pool	1924
UPDATE STGPOOLDIRECTORY (Update a storage pool directory)	1928
UPDATE VIRTUALFSMAPPING (Update a virtual file space mapping)	1930
UPDATE VOLHISTORY (Update sequential volume history information)	1931
UPDATE VOLUME (Change a storage pool volume)	1933
VALIDATE commands	1936
VALIDATE ASPERA (Validate an Aspera FASP configuration)	1936
VALIDATE CLOUD (Validate cloud credentials)	1939
VALIDATE LANFREE (Validate LAN-Free paths)	1940
VALIDATE POLICYSET (Verify a policy set)	1942
VALIDATE REPLICATION (Validate replication for a client node)	1943
VALIDATE REPLPOLICY (Verify the policies on the target replication server)	1946
VARY (Bring a random access volume online or offline)	1948
Server options	1949
Modifying server options	1956
Types of server options	1956
Server communication options	1957
Server storage options	1959
Client-server options	1959
Date, number, time, and language options	1960
Database options	1960
Data transfer options	1961
Message options	1961
Event logging options	1961
Security options and licensing options	1962
Miscellaneous options	1962
3494SHARED	1963
ACSACCESSID	1964
ACSLOCKDRIVE	1964

ACSQUICKINIT	1964
ACSTIMEOUTX	1965
ACTIVELOGDIRECTORY	1965
ACTIVELOGSIZE	1966
ADMINCOMMTIMEOUT	1966
ADMINIDLETIMEOUT	1967
ADMINONCLIENTPORT	1967
ADSMGROUPNAME	1967
ALIASHALT	1968
ALLOWDESAUTH	1968
ALLOWREORGINDEX	1969
ALLOWREORGTABLE	1969
ARCHFAILOVERLOGDIRECTORY	1970
ARCHLOGCOMPRESS	1970
ARCHLOGDIRECTORY	1971
ARCHLOGUSEDTHRESHOLD	1971
ASSISTVCRRECOVERY	1972
AUDITSTORAGE	1972
BACKUPINITIATIONROOT	1972
CHECKTAPEPOS	1973
CLIENTDEDUPTXNLIMIT	1974
COMMMETHOD	1975
COMMTIMEOUT	1975
CONTAINERRESOURCESTIMEOUT	1976
DATEFORMAT	1976
DBDIAGLOGSIZE	1977
DBDIAGPATHFSTHRESHOLD	1978
DBMEMPERCENT	1978
DBMTCPPORT	1979
DEDUPREQUIRESBACKUP	1979
DEDUPTIER2FILESIZE	1980
DEDUPTIER3FILESIZE	1980
DEVCONFIG	1981
DISABLEREORGTABLE	1982
DISABLESCHEDS	1982
DISPLAYLFINFO	1982
DNSLOOKUP	1983
DRIVEACQUIRERETRY	1984
ENABLENASDEDUP	1984
EVENTSERVER	1985
EXPINTERVAL	1985
EXPQUIET	1986
FASPBEGPORT	1986
FASPENDDPORT	1986
FASPTARGETRATE	1987
FFDCLOGLEVEL	1988
FFDCLOGNAME	1988
FFDCMAXLOGSIZE	1989
FFDCNUMLOGS	1989
FILEEXIT	1990
FILETEXTEXIT	1990
FSUSEDTHRESHOLD	1991
IDLETIMEOUT	1991
KEEPALIVE	1992
KEEPALIVETIME	1992
KEEPALIVEINTERVAL	1993

LANGUAGE	1993
LDAPCACHEDURATION	1996
LDAPURL	1996
MAXSESSIONS	1997
MESSAGEFORMAT	1997
MIRRORLOGDIRECTORY	1998
MOVEBATCHSIZE	1998
MOVESIZETHRESH	1999
MSGINTERVAL	1999
NAMEDPIPENAME	1999
NDMPCONNECTIONTIMEOUT	2000
NDMPCONTROLPORT	2000
NDMPENABLEKEEPALIVE	2001
NDMPKEEPIDLEMINUTES	2001
NDMPPORTRANGE	2002
NDMPPREFDATAINTERFACE	2002
NOPREEMPT	2003
NORETRIEVEDATE	2003
NPAUDITFAILURE	2004
NPAUDITSUCCESS	2004
NPBUFFERSIZE	2005
NUMBERFORMAT	2005
NUMOPENVOLSALLOWED	2006
PUSHSTATUS	2007
QUERYAUTH	2007
RECLAIMDELAY	2007
RECLAIMPERIOD	2008
REORGBEGINTIME	2008
REORGDURATION	2009
REPORTRETRIEVE	2009
REPLBATCHSIZE	2010
REPLSIZETHRESH	2010
REQSYSAUTHOUTFILE	2011
RESOURCETIMEOUT	2011
RESTOREINTERVAL	2012
RETENTIONEXTENSION	2012
SANDISCOVERY	2013
SANDISCOVERYTIMEOUT	2014
SANREFRESHTIME	2014
SEARCHMPQUEUE	2015
SECUREPIPES	2015
SERVERDEDUPTXNLIMIT	2015
SHMPORT	2016
SHREDDING	2017
SNMPHEARTBEATINTERVAL	2017
SNMPMESSAGECATEGORY	2018
SNMPSUBAGENT	2018
SNMPSUBAGENTHOST	2019
SNMPSUBAGENTPORT	2019
SSLFIPSMODE	2019
SSLINITTIMEOUT	2020
SSLTCPADMINPORT	2020
SSLTCPPOINT	2021
TCPADMINPORT	2021
TCPBUFSIZE	2022
TCPNODELAY	2023

TCPPORT	2023
TCPWINDOWSIZE	2024
TECBEGINEVENTLOGGING	2024
TECHOST	2025
TECPORT	2025
TECUTF8EVENT	2025
THROUGHPUTDATATHRESHOLD	2026
THROUGHPUTTIMETHRESHOLD	2026
TIMEFORMAT	2027
TXNGROUPMAX	2027
UNIQUETDPTEEVENTS	2028
UNIQUETECEVENTS	2028
USEREXIT	2029
VERBCHECK	2030
VOLUMEHISTORY	2030
Server utilities	2030
DSMMAXSG (Increase the block size for writing data)	2031
DSMSERV (Start the server)	2032
Server startup script: rc.dsmserv	2034
Server startup script: dsmserv.rc	2034
DSMSERV DISPLAY DBSPACE (Display information about database storage space)	2035
DSMSERV DISPLAY LOG (Display recovery log information)	2036
DSMSERV EXTEND DBSPACE (Increase space for the database)	2037
DSMSERV FORMAT (Format the database and log)	2039
DSMSERV INSERTDB (Move a server database into an empty database)	2041
DSMSERV LOADFORMAT (Format a database)	2042
DSMSERV REMOVEDB (Remove a database)	2044
DSMSERV RESTORE DB (Restore the database)	2045
DSMSERV RESTORE DB (Restore a database to its most current state)	2046
DSMSERV RESTORE DB (Restore a database to a point-in-time)	2048
DSMSERV UPDATE (Create registry entries for a server instance)	2052
DSMULOG (Capture IBM Spectrum Protect server messages to a user log file)	2052
Device utilities	2053
AIX: tsmdlst (Display information about devices)	2053
Linux: autoconf (Auto configure devices)	2054
Windows: tsmdlst (Display information about devices)	2055
Server scripts and macros for automation	2057
Server scripts	2057
Defining a server script	2058
Running commands in parallel or serially	2059
Continuing commands across multiple command lines	2059
Including substitution variables in a script	2060
Including logic flow statements in a script	2060
Specifying the IF clause	2060
Specifying the EXIT statement	2061
Specifying the GOTO statement	2061
Using SELECT commands in a script	2061
Updating a script	2062
Appending a new command	2062
Replacing an existing command	2063
Adding a command and line number	2063
Deleting a command from a server script	2063
Querying a server script to create another server script	2064
Running a server script	2064
Administrative client macros	2064
Writing commands in a macro	2065

Writing comments in a macro	2065
Including continuation characters in a macro	2066
Including substitution variables in a macro	2066
Running a macro	2067
Command processing in a macro	2067
Return codes for use in IBM Spectrum Protect scripts	2068
PDF files	2070

## Clients

Clients	2071
What's new	2071
Backup-archive client updates	2071
V8.1 release notes	2077
V8.1 readme files for fix packs	2078
Late-breaking documentation updates	2079
Protection for workstations and file servers	2079
Installing the IBM Spectrum Protect backup-archive clients (UNIX, Linux, and Windows)	2079
Upgrading the backup-archive client	2080
Upgrade path for clients and servers	2080
Additional upgrade information	2081
Automatic backup-archive client deployment	2081
Client environment requirements	2082
AIX client environment	2082
AIX client installable components	2083
System requirements for the AIX client	2083
AIX client communication methods	2083
Backup-archive client features that are available on AIX	2083
HP-UX Itanium 2 API environment	2084
HP-UX Itanium 2 API installable component	2084
System requirements for the HP-UX Itanium 2 API	2084
HP-UX Itanium 2 API communication methods	2084
Linux on Power Systems client environment	2084
Linux on Power Systems client installable components	2085
System requirements for clients on Linux on Power Systems	2085
Linux on Power Systems client communication methods	2085
Linux x86_64 client environment	2085
Linux x86_64 client installable components	2085
System requirements for Linux x86_64 clients	2086
Linux x86_64 client communication methods	2086
Linux on System z client environment	2086
Linux on System z client installable components	2086
System requirements for Linux on System z clients	2087
Linux on System z client communication methods	2087
Mac OS X client environment	2087
Mac OS X client installable components	2087
System requirements for Mac OS X clients	2087
Mac OS X client communication methods	2088
Oracle Solaris client environment	2088
Oracle Solaris client installable components	2088
System requirements for Oracle Solaris clients	2088
Oracle Solaris client communication methods	2088
Windows client environment requirements	2089
Windows client installable components	2089
System requirements for Windows clients	2089
Windows client communication methods	2089
Backup-archive client features that are available on Windows platforms	2090

Windows supported file systems	2090
NDMP support requirements (Extended Edition only)	2090
Installation requirements for backing up and archiving Tivoli Storage Manager FastBack client data	2090
Client configuration wizard for Tivoli Storage Manager FastBack	2091
Install the UNIX and Linux backup-archive clients	2091
Installing the AIX client	2092
Uninstalling the AIX client	2094
Installing the HP-UX Itanium 2 API	2095
Uninstalling the HP-UX Itanium 2 API	2096
Installing the client on Linux on Power Systems (Little Endian)	2097
Uninstalling the client on Linux on Power (Little Endian)	2099
Installing the client on Ubuntu Linux on Power Systems (Little Endian)	2100
Uninstalling the client on Ubuntu Linux on Power Systems (Little Endian)	2101
Installing the API on Linux on Power Systems (Big Endian)	2102
Uninstalling the API on Linux on Power Systems (Big Endian)	2104
Installing the Linux x86_64 client	2105
Uninstalling the Linux x86_64 client	2107
Installing the Ubuntu Linux x86_64 client	2108
Uninstalling the Ubuntu Linux x86_64 client	2110
Installing the Linux on System z client	2111
Uninstalling the Linux on System z client	2114
Installing the Mac OS X client	2115
Uninstalling the Mac OS X client	2116
Installing the Oracle Solaris x86_64 client	2117
Uninstalling the Oracle Solaris x86_64 client	2118
Installing the Oracle Solaris SPARC API	2119
Uninstalling the Oracle Solaris SPARC API	2120
Software updates (AIX, Linux, Mac, and Solaris clients)	2120
Windows client installation overview	2120
Windows client installation might require a reboot	2121
Installation procedures	2121
Installing the Windows client for the first time	2122
Upgrading the Windows client	2124
Reinstalling the Windows client	2126
Silent installation	2126
Modifying, repairing, or uninstalling the Windows client	2129
Troubleshooting problems during installation (Windows)	2130
Software updates (Windows clients)	2130
Installing the client management service	2131
Configuring backup-archive clients	2131
Configure the IBM Spectrum Protect client	2131
UNIX and Linux client root and authorized user tasks	2133
Enable non-root users to manage their own data	2135
Client options file overview	2135
Creating and modifying the client system-options file	2137
Creating and modifying the client options file	2139
Creating a default client-user options file	2140
Creating a customized client user-options file	2141
Create a shared directory options file	2142
Creating multiple client options files	2142
Environment variables (Windows)	2142
Environment variables (AIX, Linux, Mac, Solaris)	2143
Set language environment variables	2143
Set processing environment variables	2144
Set Bourne and Korn shell variables	2146
Set C shell variables	2146

Set API environment variables	2146
Configuring the language for displaying the Java GUI	2146
Web client configuration overview	2147
Configuring the web client on AIX, Linux, Mac, and Solaris systems	2148
Configuring the web client on Windows systems	2148
Configuring the scheduler	2149
Comparison between client acceptor-managed services and traditional scheduler services	2150
Configuring the client to use the client acceptor service to manage the scheduler	2150
Start the client scheduler (AIX, Linux, Mac, Solaris)	2152
Starting the client scheduler (Windows)	2152
Configuring IBM Spectrum Protect client/server communication across a firewall	2152
Configuring IBM Spectrum Protect client/server communication with Secure Sockets Layer	2154
Creating a symbolic link to access the latest GSKit library	2157
Certificate Authorities root certificates	2158
Configure your system for journal-based backup	2158
Configuring the journal engine service	2158
JournalSettings stanza (Windows)	2160
JournalExcludeList stanza	2161
JournaledFileSystemSettings stanza	2162
Overriding stanzas	2164
Journal daemon configuration	2165
JournalSettings stanza	2166
JournalExcludeList stanza	2167
JournaledFileSystemSettings stanza	2167
Overriding stanzas	2169
Client-side data deduplication	2169
Configuring the client for data deduplication	2172
Excluding files from data deduplication	2174
Automated client failover configuration and use	2175
Automated client failover overview	2175
Requirements for automated client failover	2176
Restrictions for automated client failover	2177
Failover capabilities of other components	2178
Configuring the client for automated failover	2178
Determining the status of replicated client data	2179
Preventing automated client failover	2180
Forcing the client to fail over	2181
Configuring the client to back up and archive Tivoli Storage Manager FastBack data	2181
Configuring the backup-archive client to protect FastBack client data	2182
Cluster environment configuration and use	2183
Overview of cluster environments	2184
Active/Active: Pool cluster resources	2184
Active/Passive: Fault tolerant	2184
Concurrent access	2184
Configuring the backup-archive client in a cluster environment	2184
Enabling web client access in a Cluster Environment	2189
Migrating legacy AIX/IBM PowerHA SystemMirror setups	2190
Backups in a cluster server environment	2191
Protecting data in MSCS clusters (Windows Server clients)	2192
Configure the web client in a cluster environment	2192
Frequently asked questions	2192
Configuring online-image backup support	2194
Configuring Open File Support	2195
AIX configuration considerations prior to performing snapshot-based file backups and archives	2195
Configuring NetApp and IBM Spectrum Protect for snapshot difference incremental backups	2195
Protecting clustered-data ONTAP NetApp file server volumes	2197



SnapMirror support for NetApp snapshot-assisted progressive incremental backup (snapdiff)	2200
Register your workstation with a server	2202
Closed registration	2202
Open registration	2203
Creating an include-exclude list	2203
Include-exclude options	2205
Exclude file spaces and directories	2205
Include-exclude statements for networked file systems	2207
Exclude files and directories from a journal-based backup	2208
Control processing with exclude statements	2208
System files to exclude	2209
Exclude files with UNC names	2210
Include and exclude files that contain wildcard characters	2211
Include and exclude groups of files with wildcard characters	2212
Examples using wildcards with include and exclude patterns	2213
Symbolic link and alias processing	2215
Determine compression and encryption processing	2215
Preview include-exclude list files	2216
Include and exclude option processing	2217
Processing rules when using UNC names	2220
Explicit use of UNC names for remote drives	2220
Conversion of DOS pathnames for fixed and remote drives	2220
Character-class matching examples	2220
Getting started	2220
Configuring the client security settings to connect to the IBM Spectrum Protect server version 8.1.2 and later	2222
Default security settings for the client (fast path)	2222
Configuring the client without automatic certificate distribution	2223
Secure password storage	2225
Backup-archive client operations and security rights	2226
Backup Operators group operations	2228
Considerations before you start using a Backup Operators group account	2228
Permissions required to restore files that use adaptive subfile backup	2229
Permissions required to back up, archive, restore or retrieve files on cluster resources	2229
IBM Spectrum Protect client authentication	2229
User account control	2230
Starting a Java GUI session	2230
IBM Spectrum Protect password	2231
Setup wizard	2231
Starting a command-line session	2231
Using batch mode	2232
Issuing a series of commands by using interactive mode	2232
Displaying Euro characters in a command-line prompt	2233
Use options on the DSMC command	2233
Specifying input strings that contain blank spaces or quotation marks	2234
Starting: Additional considerations	2234
Using the web client in the new security environment	2235
Start the client scheduler automatically	2235
Changing your password	2235
Sorting file lists using the backup-archive client GUI	2237
Displaying online help	2238
Ending a session	2238
Online forums	2239
Back up and restore data with backup-archive clients	2239
Backing up your data	2239
Planning your backups (Windows)	2242
Planning your backups	2242

Which files are backed up	2243
Open file support for backup operations	2243
Backing up data using the GUI	2244
Backing up data using the command line	2245
Deleting backup data	2247
When to back up and when to archive files	2248
Pre-backup considerations (Windows)	2248
LAN-free data movement	2249
LAN-free prerequisites	2249
LAN-free data movement options	2249
Unicode file spaces (Windows)	2250
Incremental backups on memory-constrained systems	2250
Incremental backups on systems with a large number of files	2250
Control processing with an include-exclude list	2251
Data encryption during backup or archive operations	2252
Maximum file size for operations	2252
How the client handles long user and group names	2252
Pre-backup considerations (UNIX and Linux)	2253
LAN-free data movement	2253
LAN-free prerequisites	2254
LAN-free data movement options	2254
Incremental backups on memory-constrained systems	2254
Incremental backups on systems with a large number of files	2255
Include-exclude options to control processing	2255
Data encryption during backup or archive operations	2256
File system and ACL support	2256
Maximum file size for operations	2259
Long user and group names	2260
Mac OS X volume names	2260
Mac OS X volume naming precautions	2261
Mac OS X volume naming precautions on dual boot systems	2261
Mac OS X Unicode enablement	2262
Mac OS X Time Machine backup disk	2262
Incremental, selective, or incremental-by-date backups (Windows)	2262
Full and partial incremental backup	2263
Incremental-by-date backup	2265
Comparing incremental-by-date, journal-based, and NetApp snapshot difference to full incremental and partial incremental backups	2265
Snapshot differential backup with HTTPS (Windows)	2266
Selective backup	2267
Performing an incremental, selective, or incremental-by-date backup (UNIX and Linux)	2267
Full and partial incremental backup	2268
Incremental-by-date backup	2270
Comparing incremental-by-date, journal-based, and NetApp snapshot difference to full incremental and partial incremental backups	2270
Snapshot differential backup with HTTPS (Linux)	2272
Selective backup	2272
Solaris global zone and non-global zones backups	2273
Saving access permissions	2273
Setting a virtual mount point	2273
Backing up data using the Java GUI	2273
Backing up data using the command line	2274
Deleting backup data	2276
Deleting file spaces	2277
Backing up files from one or more file spaces for a group backup (Windows)	2278
Backing up files from one or more file spaces for a group backup (UNIX and Linux)	2278

Backing up data with client-node proxy support (Windows)	2279
Enabling multiple node operations from the GUI	2280
Setting up encryption	2280
Scheduling backups with client-node proxy support	2280
Backing up data with client-node proxy support (UNIX and Linux)	2281
Enabling multiple node operations from the GUI	2280
Setting up encryption	2283
Scheduling backups with client-node proxy support	2283
Examples of how to schedule a backup of an IBM PowerHA SystemMirror cluster	2284
Scheduling a backup of a GPFS file system	2285
Associate a local snapshot with a server file space (Windows)	2286
Associate a local snapshot with a server file space (UNIX and Linux)	2286
Backing up Windows system state	2286
Backing up Automated System Recovery files	2287
Preparation for Automated System Recovery	2288
Creating a client options file for Automated System Recovery	2288
Backing up the boot drive and system drive for Automated System Recovery	2289
Image backup	2289
Performing prerequisite tasks before creating an image backup	2291
Utilizing image backups to perform file system incremental backups	2292
Method 1: Using image backups with file system incremental backups	2292
Method 2: Using image backups with incremental-by-date image backups	2293
Comparing methods 1 and 2	2294
Performing an image backup using the GUI	2294
Performing an image backup using the command line	2295
Snapshot-based file backup and archive and snapshot-based image backup	2296
Protecting Btrfs file systems	2297
Backing up and restoring Btrfs file systems	2297
Backing up and restoring Btrfs subvolumes	2298
Back up NAS file systems using Network Data Management Protocol	2299
Backing up NAS file systems with the web client GUI using NDMP protocol	2300
Back up NAS file systems using the command line	2301
Methods for backing up and recovering data on NAS file servers accessed by CIFS protocol	2302
Support for CDP Persistent Storage Manager	2303
Backup network file systems	2304
Back up AIX workload partition file systems	2304
Backing up Solaris Zettabyte file systems	2305
AIX JFS2 encrypted file system backup	2306
Back up AIX JFS2 extended attributes	2307
Backing up VMware virtual machines	2307
Preparing the environment for full backups of VMware virtual machines	2309
Creating full backups for VMware virtual machines	2311
Parallel backups of virtual machines	2312
Back up virtual machines on a Hyper-V system	2313
Back up and archive Tivoli Storage Manager FastBack data	2313
Backing up Net Appliance CIFS share definitions	2313
Display backup processing status	2314
Backup (Windows): Additional considerations	2316
Open files	2317
Ambiguous file space names in file specifications	2318
Management classes	2318
Deleted file systems	2318
Removable media backup	2319
Fixed drives	2319
NTFS and ReFS file spaces	2319
Universal Naming Convention names	2320

Examples: UNC names in domain lists	2320
Examples: UNC name backup	2320
Microsoft Dfs file protection methods	2321
Backup (UNIX and Linux): Additional considerations	2323
Stored files	2323
Special file systems	2324
NFS or virtual mount points	2324
Management classes	2324
Back up symbolic links	2325
Examples: Incremental or selective backup of symbolic links	2325
Incremental backup of a domain only	2326
Hard links	2326
Sparse files	2327
NFS hard and soft mounts	2327
Deleted file systems	2328
Opened files	2328
Wildcard characters	2328
Restoring your data	2329
Duplicate file names	2331
Universal Naming Convention names restore	2331
Active or inactive backup restore	2332
Restoring files and directories	2332
Restoring data by using the GUI	2332
Examples for restoring data using the command line	2333
Examples: Restoring large amounts of data	2334
Standard query restore, no-query restore, and restartable restore	2335
Standard query restore process	2335
No-query restore process	2336
Restartable restore process	2336
Restoring Windows system state	2337
Restoring Automated System Recovery files	2337
Restoring the operating system when the computer is working	2338
Recovering a computer when the Windows OS is not working	2338
Creating a bootable WinPE CD	2338
Restoring the Windows operating system with Automated System Recovery	2338
Microsoft Dfs tree and file restore	2339
Restoring an image	2339
Restoring an image using the GUI	2340
Restoring an image using the command line	2341
Restore data from a backup set	2341
Restore backup sets: considerations and restrictions	2343
Backup set restore	2344
Restoring backup sets using the GUI	2344
Backup set restores using the client command-line interface	2345
Restore Net Appliance CIFS shares	2346
Restoring data from a VMware backup	2346
Restoring full VM backups	2347
Scenarios for running full VM instant access and full VM instant restore from the backup-archive client command line	2348
Full VM instant restore cleanup and repair scenarios	2350
Recovering from non-standard error conditions	2352
Scenario: Restoring file-level VM backups	2352
Restoring full VM backups that were created with VMware Consolidated Backup	2354
Restore Windows individual Active Directory objects	2356
Reanimate tombstone objects or restoring from a system state backup	2356
Restoring Active Directory objects using the GUI and command line	2357
Restrictions and limitations when restoring Active Directory objects	2357

Preserve attributes in tombstone objects _____	2358
Modifying the client acceptor and agent services to use the web client _____	2359
Restoring or retrieving data during a failover _____	2359
Authorizing another user to restore or retrieve your files _____	2360
Restoring or retrieving files from another client node _____	2361
Restoring or retrieving your files to another workstation _____	2362
Deleting file spaces _____	2362
Restore an image to file _____	2363
Manage GPFS file system data with storage pools _____	2364
Restoring data to a point in time _____	2364
Restore AIX encrypted files _____	2366
Restore AIX workload partition file systems _____	2366
Restore NAS file systems _____	2367
Restoring NAS file systems using the web client _____	2367
Restoring NAS files and directories using the web client _____	2368
Options and commands to restore NAS file systems from the command line _____	2369
Restore active or inactive backups _____	2370
Restoring data using the GUI _____	2370
Command line restore examples _____	2371
Examples: Command line restores for large amounts of data _____	2372
Standard query restore, no-query restore, and restartable restore _____	2373
Standard query restore process _____	2373
No-query restore process _____	2373
Restartable restore process _____	2374
Restoring Solaris Zettabyte (ZFS) file systems _____	2374
Additional restore tasks _____	2375
Authorizing another user to restore or retrieve your files _____	2375
Restoring or retrieving files from another client node _____	2376
Restore or retrieve files to another workstation _____	2377
Restoring a disk in case of disk loss _____	2377
Deleting file spaces _____	2378
Enable SELinux to restore files on the Red Hat Enterprise Linux 5 client _____	2378
Archive and retrieve data with backup-archive clients _____	2378
Archive and retrieve your data (Windows) _____	2379
Archive files _____	2379
Snapshot backup or archive with open file support _____	2380
Archiving data with the GUI _____	2380
Archive data examples by using the command line _____	2381
Archiving data with client node proxy _____	2382
Deleting archive data _____	2383
Retrieve archives _____	2383
Retrieving archives with the GUI _____	2384
Retrieve archive copies by using the command line _____	2384
Archive and retrieve your data (UNIX and Linux) _____	2385
Archive files _____	2386
Archiving data with the GUI _____	2386
Archive data examples by using the command line _____	2387
Archiving data with client node proxy _____	2388
Deleting archive data _____	2389
Advanced archive tasks _____	2389
Access permissions _____	2390
Archive and retrieve symbolic links _____	2390
Hard links _____	2391
Retrieve archives _____	2391
Retrieving data with the GUI _____	2391
Retrieve data examples by using the command line _____	2392

Archive management classes	2392
Schedule operations for backup-archive clients	2393
IBM Spectrum Protect scheduler overview	2393
Examples: Blank spaces in file names in schedule definitions	2394
Preferential start times for certain nodes	2395
Scheduler processing options	2396
Evaluate schedule return codes in schedule scripts	2397
Return codes from preschedulecmd and postschedulecmd scripts	2397
Client-acceptor scheduler services versus the traditional scheduler services	2398
Setting the client scheduler process to run as a background task and start automatically at startup	2399
Examples: Display information about scheduled work	2401
Display information about completed work	2403
Specify scheduling options	2404
Scheduler options for commands	2404
Enable or disable scheduled commands	2404
Change processing options used by the scheduler service	2405
Manage multiple schedule requirements on one system	2405
Client return codes	2408
Storage management policies	2409
Policy domains and policy sets	2410
Management classes and copy groups	2410
Display information about management classes and copy groups	2411
Copy group name attribute	2412
Copy type attribute	2412
Copy frequency attribute	2412
Versions data exists attribute	2413
Versions data deleted attribute	2413
Retain extra versions attribute	2413
Retain only version attribute	2413
Copy serialization attribute	2413
Copy mode parameter	2414
Copy destination attribute	2414
Retain versions attribute	2414
Deduplicate data attribute	2414
Select a management class for files	2415
Assign a management class to files	2415
Override the management class for archived files	2416
Select a management class for directories	2417
Bind management classes to files	2417
Rebind backup versions of files	2417
Retention grace period	2418
Event-based policy retention protection	2418
Backup-archive client options and commands	2419
Reading syntax diagrams	2419
Processing options	2421
Processing options overview	2422
Communication options	2422
TCP/IP options	2423
Named Pipes option	2423
Shared memory options	2424
Server options	2424
Backup and archive processing options	2425
Restore and retrieve processing options	2434
Scheduling options	2437
Format and language options	2438
Command processing options	2439

Authorization options	2439
Error processing options	2439
Transaction processing options	2440
Web client options	2440
Using options with commands	2441
Entering options with a command	2441
Initial command-line-only options	2442
Client options that can be set by the IBM Spectrum Protect server	2443
Client options reference	2444
Absolute	2457
Adlocation	2458
Afmskipuncachedfiles	2459
Archmc	2460
Archsymlinkasfile	2460
Asnodename	2461
Asnodename	2462
Asrmode	2464
Auditlogging	2464
Auditlogname	2467
Autodeploy	2470
Autofsrename	2471
Automount	2473
Backmc	2474
Backupsetname	2474
Basesnapshotname	2476
Cadlistenonport	2477
Casesensitiveaware	2477
Changingretries	2478
Class	2479
Clientview	2480
Clusterdiskonly	2481
Clusternode	2482
Collocatebyfilespec	2483
Commmethod	2484
Commrestartduration	2486
Commrestartinterval	2487
Compressalways	2487
Compression	2488
Console	2490
Createnewbase	2491
Datacenter	2492
Datastore	2492
Dateformat	2493
Dedupcachepath	2496
Dedupcachesize	2497
Deduplication	2497
Defaultserver	2498
Deletefiles	2499
Description	2500
Detail	2501
Diffsnapshot	2502
Diffsnapshotname	2503
Dirmc	2504
Dirsonly	2505
Disablenqr	2506
Diskbuffsize	2506

Diskcachelocation	2507
Domain	2508
Domain.image	2513
Domain.nas	2514
Domain.vmfull	2515
Dontload	2522
Dynamicimage	2523
Efsdecrypt	2523
Enable8dot3namesupport	2524
Enablearchiveretentionprotection	2525
Enablededupcache	2526
Enableinstrumentation	2527
Enablelanfree	2529
Encryptiontype	2530
Encryptkey	2530
Errorlogmax	2532
Errorlogname	2533
Errorlogretention	2534
Exclude options	2536
Controlling symbolic link and alias processing	2540
Controlling compression processing	2540
Processing NAS file systems	2541
Virtual machine exclude options	2541
Fbranch	2541
Fbclientname	2542
Fbpolicyname	2543
Fbreposlocation	2545
Fbserver	2546
Fbvolumename	2548
Filelist	2549
Filename	2551
Filesonly	2553
Followsymbolic	2553
Forcefailover	2554
Fromdate	2555
Fromnode	2556
Fromowner	2557
Fromtime	2557
Groupname	2558
Groups (deprecated)	2559
Host	2559
Httpport	2559
Hsmreparsetag	2560
Ieobjtype	2561
Ifnewer	2562
Imagegapsize	2562
Imagetofile	2563
Inactive	2564
Incl excl	2565
Include options	2566
Controlling symbolic link and alias processing	2572
Compression and encryption processing	2572
Compression and encryption backup processing	2573
Processing NAS file systems	2573
Virtual machine include options	2574
Include.vm	2574



Include.vmdisk	2575
INCLUDE.VMSNAPSHOTATTEMPTS	2578
INCLUDE.VMTSMVSS	2580
Incrbydate	2582
Incremental	2582
Incrthreshold	2583
Instrlogmax	2584
Instrlogname	2585
Journalpipe	2586
Lanfreecommmethod	2587
Lanfreeshmport	2588
Lanfreetcport	2589
Lanfreessl	2590
Lanfreetcpserveraddress	2590
Language	2591
Latest	2592
Localbackupset	2592
Makesparsefile	2593
Managedservices	2594
Maxcmdretries	2596
Mbobjrefreshthresh	2597
Mbpctrefreshthresh	2597
Memoryefficientbackup	2598
Mode	2600
Monitor	2603
Myprimaryserver	2604
Myreplicationserver	2605
Namedpipename	2606
Nasnodename	2607
Nfstimeout	2608
Nodename	2609
Nojournal (Windows)	2610
Nojournal (AIX, Linux)	2611
Noprompt	2611
Nrtablepath	2612
Numberformat	2613
Optfile	2615
Password	2615
Passwordaccess	2617
Passworddir	2618
Pick	2619
Pitdate	2620
Pitime	2621
Postschedulecmd/Postnschedulecmd	2622
Postsnapshotcmd	2623
Preschedulecmd/Prenschedulecmd	2625
Preserveaccessdate	2627
Preservepath	2628
Presnapshotcmd	2631
Queryschedperiod	2633
Querysummary	2634
Quiet	2636
Quotesareliteral	2637
Removeoperandlimit	2638
Replace	2638
Replserverguid	2640

Replservername	2641
Replsslport	2643
Repltcpport	2645
Repltcpserveraddress	2646
Resetarchiveattribute	2648
Resourceutilization	2649
Regulating backup and archive sessions	2650
Regulating restore sessions	2650
Multiple client session considerations	2651
Retryperiod	2651
Revokeremoteaccess	2652
Runasservice	2653
Schedcmddisabled	2654
Schedcmdexception	2654
Schedgroup	2655
Schedlogmax	2656
Schedlogname	2657
Schedlogretention	2658
Schedmode	2660
Schedrestretrdisabled	2661
Scrolllines	2662
Scrollprompt	2662
Servername	2663
Sessioninitiation	2664
Setwindowtitle	2666
Shmport	2667
Showmembers	2667
Skipacl	2668
Skipaclupdatecheck	2669
Skipmissingsyswfiles	2669
Skipntpermissions	2670
Skipntsecuritycrc	2671
Skipsystemexclude	2672
Snapdiff	2672
Snapdiffchangelogdir	2678
Snapdiffhttps	2679
Snapshotcachesize	2681
Snapshotproviderfs	2682
Snapshotproviderimage	2683
Snapshotroot	2684
Srvoptsetencryptiondisabled	2687
Srvprepostscheddisabled	2688
Srvprepostsnapdisabled	2688
Ssl	2689
Sslacceptcertfromserv	2690
Ssldisablelegacytls	2691
Sslfipsmode	2692
Sslrequired	2692
Stagingdirectory	2694
Subdir	2695
Systemstatebackupmethod	2697
Tapeprompt	2698
Tcpadminport	2699
Tcpbuffsize	2699
Tpcadaddress	2700
Tcpclientaddress	2701

Tcpclientport	2702
Tcpnodelay	2702
Tcpport	2703
Tcpserveraddress	2704
Tcpwindowsize	2705
Timeformat	2706
Toc	2708
Todate	2709
Totime	2710
Txnbytelimit	2711
Type	2712
Updatectime	2712
Usedirectory	2713
Useexistingbase	2714
Usereplicationfailover	2715
Users (deprecated)	2715
V2archive	2715
Verbose	2716
Verifyimage	2717
Virtualfsname	2718
Virtualmountpoint	2718
Virtualnodename	2719
Vmautostartvm	2721
Vmbackdir	2721
Vmbackuplocation	2722
Vmbackupmailboxhistory	2723
Vmbackuptype	2724
Vmchost	2725
Vmcpw	2726
Vmctlmc	2727
Vmcuser	2728
Vmdatastorethreshold	2729
Vmdefaultdvportgroup	2730
Vmdefaultdvswitch	2731
Vmdefaultnetwork	2732
Vmdiskprovision	2732
Vmenabletemplatebackups	2733
Vmexpireprotect	2735
Vmiscsiadapter	2736
Vmiscsiserveraddress	2736
Vmlimitperdatastore	2737
Vmlimitperhost	2738
Vmlist	2739
Vmmaxbackupsessions	2739
Vmmaxparallel	2741
Vmmaxpersnapshot	2742
Vmmaxrestoresessions	2743
Vmmaxrestoreparalleldisks	2744
Vmmaxsnapshotretry	2745
Vmmaxvirtualdisks	2746
Vmmc	2747
Vmmountage	2748
Vmnoprmdisks	2748
Vmnovrdmdisks	2749
Vmpreferdagpassive	2750
Vmprocessvmwithindependent	2751

Vmprocessvmwithphysdisks	2752
Vmprocessvmwithprdm	2752
Vmrestoretype	2753
Vmskipctlcompression	2755
Vmskipmaxvirtualdisks	2756
Vmskipmaxvmdks	2757
Vmskipphysdisks	2757
Vmstoragetype	2758
Vmtagdatamover	2759
Vmtagdefaultdatamover	2761
Vmtempdatastore	2763
Vmverifyifaction	2763
Vmverifyiflatest	2765
Vmvstortransport	2766
Vssaltstagingdir	2767
Vssusesystemprovider	2768
Vmtimeout	2768
Webports	2769
Wildcardsareliteral	2770
Using commands	2771
Start and end a client command session	2777
Process commands in batch mode	2777
Process commands in interactive mode	2777
Enter client command names, options, and parameters	2778
Command name	2778
Options	2778
Parameters	2779
File specification syntax	2779
Wildcard characters	2781
Client commands reference	2782
Archive	2782
Archive FastBack	2785
Backup FastBack	2788
Backup Group	2791
Backup Image	2792
Static, dynamic, and snapshot image backup	2795
Offline and online image backup	2796
Utilizing image backup to perform file system incremental backup	2796
Backup NAS	2798
Backup Systemstate	2799
Backup VM	2801
Cancel Process	2812
Cancel Restore	2812
Delete Access	2813
Delete Archive	2814
Delete Backup	2816
Delete Filespace	2819
Delete Group	2820
Expire	2821
Help	2823
Incremental	2824
Open file support	2830
Journal-based backup (Windows)	2830
Journal-based backup (AIX, Linux)	2831
Backing up NTFS or ReFS volume mount points	2832
Back up Microsoft Dfs root	2832

Incremental-by-Date	2833
Associate a local snapshot with a server file space	2833
Loop	2833
Macro	2835
Monitor Process	2835
Preview Archive	2836
Preview Backup	2837
Query Access	2838
Query Adobjects	2838
Query Archive	2840
Query Backup	2843
Query Backupset	2846
Query Filespace	2848
Query Group	2850
Query Image	2852
Query Inclexcl	2853
Query Mgmtclass	2855
Query Node	2856
Query Options	2857
Query Restore	2858
Query Schedule	2858
Query Session	2859
Query Systeminfo	2860
Query Systemstate	2862
Query VM	2863
Restart Restore	2868
Restore	2869
Restoring NTFS or ReFS volume mount points	2874
Restore Microsoft Dfs junctions	2874
Restore active files	2874
Universal Naming Convention restores	2875
Restore from file spaces that are not Unicode-enabled	2875
Restore named streams	2875
Restore sparse files	2876
Restore Adobjects	2876
Restore Backupset	2877
Restore backup sets: considerations and restrictions	2343
Restore backup sets in a SAN environment	2881
Restore Backupset without the backupsetname parameter	2881
Restore Group	2884
Restore Image	2886
Restore NAS	2889
Restore Systemstate	2891
Restore VM	2891
Retrieve	2898
Retrieve archives from file spaces that are not Unicode-enabled	2902
Retrieve named streams	2902
Retrieve sparse files	2902
Schedule	2903
Selective	2905
Open file support	2908
Associate a local snapshot with a server file space	2908
Set Access	2908
Set Event	2911
Set Netappsvm	2914
Set Password	2915

Set Vmtags	2919
Client Service Configuration Utility	2921
Install the backup-archive scheduler service	2921
dsmcutil command	2921
Dsmcutil commands: Required options and examples	2922
Dsmcutil valid options	2930
PDF files for printing	2932

<b>Developing solutions with the API</b>	<b>2932</b>
What's new	2933
API updates	2933
V8.1 release notes	2934
V8.1 readme files for fix packs	2936
Late-breaking documentation updates	2936
Installing the API	2936
API overview	2937
Understanding configuration and options files	2937
Setting up the API environment	2938
Building and running the sample API application	2939
UNIX or Linux sample application source files	2939
Windows 64-bit sample application	2940
Considerations for designing an application	2941
Determining size limits	2946
Maintaining API version control	2946
Using multithreading	2947
Signals and signal handlers	2948
Starting or ending a session	2948
Session security	2949
Controlling access to password files	2951
Creating an administrative user with client owner authority	2951
Object names and IDs	2952
File space name	2953
High-level and low-level names	2953
Object type	2953
Accessing objects as session owner	2954
Accessing objects across nodes and owners	2954
Managing file spaces	2955
Associating objects with management classes	2956
Expiration/deletion hold and release	2957
Querying the IBM Spectrum Protect system	2958
Server efficiency	2959
Sending data to a server	2960
The transaction model	2960
File aggregation	2960
LAN-free data transfer	2961
Simultaneous-write operations	2961
Enhancing API performance	2961
Set up the API to send performance data	2961
Sending objects to the server	2962
Understanding backup and archive objects	2962
Compression	2963
Buffer copy elimination	2964
API encryption	2964
Application-managed encryption	2965
IBM Spectrum Protect client encryption	2966

Data deduplication	2967
API client-side data deduplication	2968
Exclude files from data deduplication	2971
Include files for data deduplication	2971
Server-side data deduplication	2971
Application failover	2971
Example flow diagrams for backup and archive	2972
File grouping	2975
Receiving data from a server	2977
Partial object restore or retrieve	2977
Restoring or retrieving data	2977
Querying the server	2978
Selecting and sorting objects by restore order	2978
Starting the dsmBeginGetData call	2980
Receiving each object to restore or retrieve	2980
Example flow diagrams for restore and retrieve	2981
Code example of receiving data from a server	2982
Updating and deleting objects on the server	2983
Logging events	2984
State diagram summary for the IBM Spectrum Protect API	2984
Understanding interoperability	2985
Backup-archive client interoperability	2986
Naming your API objects	2986
Backup-archive client commands you can use with the API	2987
Operating system interoperability	2988
Backing up multiple nodes with client node proxy support	2988
Using the API with Unicode	2989
When to use Unicode	2989
Setting up Unicode	2989
API function calls	2990
dsmBeginGetData	2995
dsmBeginQuery	2996
dsmBeginTxn	3000
dsmBindMC	3001
dsmChangePW	3002
dsmCleanUp	3003
dsmDeleteAccess	3003
dsmDeleteFS	3003
dsmDeleteObj	3004
dsmEndGetData	3005
dsmEndGetDataEx	3005
dsmEndGetObj	3006
dsmEndQuery	3006
dsmEndSendObj	3007
dsmEndSendObjEx	3007
dsmEndTxn	3008
dsmEndTxnEx	3009
dsmGetData	3010
dsmGetBufferData	3011
dsmGetNextQObj	3011
dsmGetObj	3014
dsmGroupHandler	3014
dsmInit	3015
dsmInitEx	3018
dsmLogEvent	3021
dsmLogEventEx	3021

dsmQueryAccess	3022
dsmQueryApiVersion	3023
dsmQueryApiVersionEx	3023
dsmQueryCliOptions	3024
dsmQuerySessInfo	3025
dsmQuerySessOptions	3025
dsmRCMsg	3026
dsmRegisterFS	3027
dsmReleaseBuffer	3028
dsmRenameObj	3028
dsmRequestBuffer	3029
dsmRetentionEvent	3030
dsmSendBufferData	3031
dsmSendData	3032
dsmSendObj	3033
dsmSetAccess	3035
dsmSetUp	3036
dsmTerminate	3037
dsmUpdateFS	3038
dsmUpdateObj	3038
dsmUpdateObjEx	3040
API return codes source file: dsrmrc.h	3041
API type definitions source files	3051
API function definitions source file	3090
PDF files for printing	3098

<b>Wydajność</b>	3098
------------------	------

<b>Rozwiązywanie problemów</b>	3098
--------------------------------	------

<b>Messages, return codes, and error codes</b>	3098
--	------

Introduction to messages	3099
IBM Spectrum Protect server and client messages format	3099
Interpreting return code messages	3100
Example one for QUERY EVENT command	3100
Example two for DEFINE VOLUME command	3101
ANE messages	3101
ANR messages	3101
ANS 0000-9999 messages	3101
API return codes	3102
API return code format	3102
API return codes	3102
-452 E	3113
-451 E	3113
-450 E	3113
-190 E	3114
-057 E	3114
-056 E	3114
-055 E	3114
-054 E	3115
-053 E	3115
-052 E	3115
-051 E	3116
-050 E	3116
0000 I	3116



0001 E	3117
0002 E	3117
0003 E	3117
0004 W	3118
0005 E	3118
0006 E	3119
0007 E	3119
0008 E	3119
0009 W	3119
0010 E	3120
0011 E	3120
0012 E	3120
0013 E	3121
0014 E	3121
0015 E	3121
0016 E	3122
0017 E	3122
0018 E	3122
0020 E	3123
0021 S	3123
0022 S	3123
0023 S	3124
0024 S	3124
0024 E	3124
0025 E	3125
0026 S	3125
0027 E	3125
0028 E	3126
0029 S	3126
0030 E	3126
0032 E	3126
0033 E	3127
0034 E	3127
0036 E	3127
0041 E	3128
0045 E	3128
0047 E	3128
0048 E	3129
0049 E	3129
0050 E	3129
0051 E	3129
0052 E	3130
0053 E	3130
0054 E	3131
0055 E	3131
0056 E	3131
0057 S	3132
0058 S	3132
0059 E	3132
0061 E	3132
0062 S	3133
0063 E	3133
0064 E	3133
0065 E	3134
0066 E	3134
0067 S	3134

0068 E	3135
0069 E	3135
0073 E	3135
0074 E	3136
0075 E	3136
0079 E	3136
0101 W	3136
0102 E	3137
0104 E	3137
0105 E	3138
0106 E	3138
0106 E	3138
0107 E	3138
0108 E	3139
0109 E	3139
0110 E	3139
0111 E	3140
0113 E	3140
0114 E	3140
0115 E	3140
0116 E	3141
0117 E	3141
0118 E	3141
0119 E	3142
0120 E	3142
0121 I	3142
0122 E	3142
0123 E	3143
0124 E	3143
0125 E	3143
0126 E	3144
0127 E	3144
0128 E	3144
0129 E	3145
0130 E	3145
0131 E	3145
0131 S	3146
0132 E	3146
0133 E	3146
0134 E	3147
0135 E	3147
0136 E	3147
0137 E	3147
0138 E	3148
0139 S	3148
0145 S	3148
0146 S	3149
0147 S	3149
0148 S	3149
0149 S	3149
0151 S	3150
0154 E	3150
0155 T	3150
0156 E	3151
0157 S	3151
0158 E	3151

0159 I	3152
0160 E	3152
0162 E	3152
0164 E	3152
0165 E	3153
0166 E	3153
0167 E	3153
0168 E	3153
0169 E	3154
0173 E	3154
0174 E	3154
0175 E	3155
0177 S	3155
0184 E	3155
0185 W	3156
0186 E	3156
0187 E	3156
0188 S	3157
0189 S	3157
0190 S	3157
0231 E	3158
0232 E	3158
0233 E	3158
0234 E	3158
0235 E	3159
0236E	3159
0237E	3159
0238E	3160
0239E	3160
0240E	3160
0241E	3160
0242E	3161
0245 E	3161
0247 E	3161
0248 E	3162
0249 E	3162
0250 E	3162
0292 E	3163
0295 E	3163
0296 E	3163
0297 E	3163
0298 E	3164
0400 E	3164
0405 E	3164
0406 S	3165
0408 E	3165
0409 E	3165
0410 E	3166
0411 S	3166
0412 S	3166
0426 E	3167
0427 E	3167
0600 E	3167
0601 E	3168
0610 E	3168
0611 E	3168

0612 E	3169
0613 E	3169
0614 E	3169
0615 E	3170
0620 E	3170
0621 E	3170
0622 E	3170
0927 E	3171
961 E	3171
963 E	3171
0996 E	3172
0997 E	3172
0998 E	3172
1376 E	3173
2000 E	3173
2001 E	3173
2002 E	3174
2004 E	3174
2006 E	3174
2007 E	3174
2008 E	3175
2009 E	3175
2010 E	3175
2011 E	3175
2012 E	3176
2014 E	3176
2015 E	3176
2016 E	3177
2017 E	3177
2018 E	3177
2019 E	3177
2020 E	3178
2021 E	3178
2022 E	3178
2023 E	3179
2024 E	3179
2025 E	3179
2026 E	3180
2027 E	3180
2028 E	3180
2029 E	3181
2030 E	3181
2031 E	3181
2032 E	3181
2033 E	3182
2034 E	3182
2035 E	3182
2041 E	3183
2042 E	3183
2043 E	3184
2044 E	3184
2045 E	3184
2046 E	3184
2047 E	3185
2048 E	3185
2049 E	3185

2050 E	3186
2051 E	3186
2052 E	3186
2053 E	3187
2060 E	3187
2061 E	3187
2062 W	3187
2063 E	3188
2064 E	3188
2065 E	3188
2070 E	3189
2080 E	3189
2081 E	3189
2082 E	3190
2090 E	3190
2100 E	3190
2101 E	3190
2102 E	3191
2103 E	3191
2104 E	3191
2105 E	3192
2106 E	3192
2107 E	3192
2110 E	3192
2111 E	3193
2112 E	3193
2113 E	3193
2114 E	3194
2120 E	3194
2200 I	3194
2210 E	3195
2228 E	3195
2229 E	3195
2230 E	3195
2231 E	3196
2300 E	3196
2301 E	3196
2302 I	3197
2400 E	3197
2401 E	3197
2402 E	3197
2403 E	3198
2404 E	3198
2405 E	3198
4580 E	3199
4582 E	3199
4584 E	3199
4600 E	3200
4601 E	3200
4602 E	3200
4603 E	3201
4604 E	3201
4605 E	3201
4606 E	3202
5200 E	3202
5702 E	3202

5705 E	3203
5710 E	3203
5717 E	3203
5722 E	3203
5746 E	3204
5748 E	3204
5749 E	3204
5801 E	3205
I/O code descriptions in server messages	3205
Device drivers completion code and operation code descriptions overview	3206
Completion code values common to all device classes	3206
Completion code values for media changers	3207
Completion code values for tape drives	3209
Standard ASC and ASCQ codes descriptions	3210
Device error codes in the AIX system error log	3213
IBM Global Security Kit return codes	3214

## Glosariusz

	3223
A	3223
B	3224
C	3225
D	3225
E	3226
F	3226
G	3226
H	3227
I	3227
K	3227
L	3229
M	3230
N	3231
O	3232
P	3233
R	3236
S	3237
Ś	3239
T	3239
U	3240
V	3241
W	3241
Z	3242

# Dokumentacja produktu IBM Spectrum Protect

---

Produkt IBM Spectrum Protect udostępnia zautomatyzowane, centralnie planowane, sterowane za pomocą strategii funkcje tworzenia kopii zapasowych i archiwalnych oraz zarządzania pamięcią masową dla serwerów plików, stacji roboczych, maszyn wirtualnych i aplikacji. Dokumentacja produktu IBM Spectrum Protect ułatwia przygotowanie, skonfigurowanie i zarządzanie rozwiązaniami do ochrony danych.

## Pierwsze kroki

- Instalowanie i aktualizowanie serwerów
- Instalowanie i aktualizowanie Operations Center
- Instalowanie klientów kopii zapasowych i archiwalnych
- Wybieranie i implementowanie rozwiązań ochrony danych
- Nowości dla serwera
- Nowości dla klientów
- [🔗 Filmy wideo dla nowości](#)
- Pliki PDF

## Typowe czynności

- Codziennie zadania monitorowania
- Dodawanie klientów
- Replikowanie danych klientów do innego serwera
- Zarządzanie serwerem, klientami i Operations Center
- Konfigurowanie pamięci masowej
- Konfigurowanie klientów kopii zapasowych i archiwalnych
- Tworzenie kopii zapasowej danych
- Komendy, opcje i programy narzędziowe serwera

## Rozwiązywanie problemów i wsparcie

- Rozwiązywanie problemów
- Optymalizowanie wydajności
- [🔗 Najnowsze pakiety poprawek dla klientów i serwerów produktu IBM Spectrum Protect](#)
- [🔗 Dział wsparcia IBM dla oprogramowania](#)

## Więcej informacji

-  Wskazówki dla użytkowników Centrum wiedzy IBM®
- Pakiety produktów i produkty pokrewne
- [🔗 Strona główna rodziny produktów](#)
- [🔗 Serwis wiki dla produktów IBM Spectrum Protect](#)
- [🔗 IBM Spectrum Protect Developer Center](#)
- [🔗 Dokumentacja techniczna IBM Redbooks](#)
- [🔗 Szkolenia IBM Systems](#)
- Dostępność
- Klauzula prawna

© Copyright IBM Corp. 1993, 2017

## Ułatwienia dostępu w rodzinie produktów IBM Spectrum Protect

---

Funkcje dostępności ułatwiają postępowanie z oprogramowaniem osobom niepełnosprawnym, np. z ograniczonymi możliwościami poruszania się lub z osłabionym wzrokiem.

## Przegląd

---

Rodzina produktów IBM Spectrum Protect obsługuje następujące główne funkcje ułatwień dostępu:

- Możliwość obsługi tylko przy użyciu klawiatury
- Operacje używające oprogramowania lektora ekranowego

Rodzina produktów IBM Spectrum Protect używa najnowszego standardu W3C WAI-ARIA 1.0 do zachowania zgodności z przepisami US Section 508 i Web Content Accessibility Guidelines (WCAG) 2.0. Aby skorzystać z ułatwień dostępu, należy użyć najnowszej wersji lektora ekranowego w połączeniu z najnowszą przeglądarką WWW obsługiwaną przez ten produkt.

Dokumentacja produktu w Centrum Wiedzy IBM obsługuje ułatwienia dostępu. Funkcje ułatwień dostępu w Centrum Wiedzy IBM zostały opisane w sekcji Ułatwienia dostępu w Centrum Wiedzy IBM.

## Nawigowanie przy użyciu klawiatury

---

Ten produkt używa standardowych klawiszy nawigacyjnych.

## Informacje dotyczące interfejsów

---

Interfejs użytkownika produktu nie stosuje elementów, które migają z częstotliwością od 2 do 55 razy na sekundę.

Internetowy interfejs użytkownika wykorzystuje arkusze stylów CSS do wyświetlania treści. Aplikacja pozwala użytkownikom z wadą wzroku na używanie innych ustawień wyświetlania, w tym trybu wyświetlania o wysokim kontraście. Użytkownik może kontrolować wielkość czcionki za pomocą urządzenia lub ustawień przeglądarki WWW.

Interfejsy użytkownika zawierają elementy nawigacyjne WAI-ARIA, które umożliwiają szybkie przechodzenie między obszarami funkcjonalnymi aplikacji.

## Oprogramowanie dostawcy

---

Rodzina produktów IBM Spectrum Protect zawiera oprogramowanie pochodzące od innych dostawców, które nie jest objęte umową licencyjną firmy IBM. Firma IBM nie udziela jakichkolwiek gwarancji w zakresie ułatwień dostępu w tych produktach. Skontaktuj się z dostawcą, aby uzyskać informacje o ułatwieniach dostępu w tych produktach.

## Informacje pokrewne na temat ułatwień dostępu

---

Oprócz standardowych serwisów WWW działów pomocy telefonicznej i wsparcia firma IBM wprowadziła usługę telefonu tekstowego (TTY) dla niesłyszących lub niedostyszących klientów pozwalającą uzyskać dostęp do usług handlowych i wsparcia:

Usługa TTY  
800-IBM-3383 (800-426-3383)  
(w Ameryce Północnej)

Więcej informacji na temat zaangażowania firmy IBM w upowszechnianie ułatwień dostępu można znaleźć w sekcji IBM Accessibility .

## Pakiety produktów i produkty pokrewne

---

Pakiety produktów i produkty pokrewne produktu IBM Spectrum Protect zwiększają możliwości podstawowego produktu IBM Spectrum Protect.

## Pakiety produktów i licencjonowanie

---

Produkty IBM Spectrum Protect i IBM Spectrum Protect Extended Edition oferują podstawowe komponenty pozwalające na automatyzację i centralne zarządzanie operacjami tworzenia i odtwarzania kopii zapasowych. Komponenty serwera oraz klienta kopii zapasowych i archiwalnych zawierają podstawowe funkcje, takie jak tworzenie i odtwarzanie kopii zapasowych oraz archiwizowanie i odtwarzanie plików, katalogów oraz obrazów dyskowych.

Dokumentacja produktu zawiera informacje dotyczące produktów IBM Spectrum Protect i IBM Spectrum Protect Extended Edition.

Pakiety produktów, które łączą IBM Spectrum Protect z produktami pokrewnymi, mogą umożliwiać prostsze kupowanie i zarządzanie oprogramowaniem IBM Spectrum Protect. Pakiety zawierają produkty, które mogą spełniać szereg wymagań dotyczących ochrony danych i odtwarzania, udostępniając uproszczony model licencjonowania. Więcej informacji na temat pakietów produktu IBM Spectrum Protect.



## Produkty pokrewne

Produkt IBM Spectrum Protect można rozbudować, dodając funkcje dostępne w produktach pokrewnych.

Produkt	Kluczowe korzyści	Odsyłacze
IBM Spectrum Copy Data Management	Ten produkt kataloguje obrazy stanu NetApp i VMware w celu ułatwienia zarządzaniem z wykorzystaniem ról i odtwarzaniem danych z kopii zapasowych.	<ul style="list-style-type: none"> <li>• Dowiedz się więcej i kup</li> <li>• Dokumentacja produktu</li> </ul>
IBM Spectrum Protect High Speed Data Transfer	Ten produkt pozwala na użycie technologii FASP (Fast Adaptive Secure Protocol), pozwalającej na zwiększenie szybkości przesyłania danych w środowisku, w którym wykryto problemy z wydajnością sieci WAN.	<ul style="list-style-type: none"> <li>• Dowiedz się więcej i kup</li> <li>• Określenie, czy technologia Aspera FASP może zoptymalizować przesyłanie danych w używanym środowisku</li> </ul>
IBM Spectrum Protect for Data Retention	<p>Zapewnia długoterminową ochronę w przypadku archiwizowania rekordów biznesowych, plików lub danych.</p> <p>Archiwizowanie danych zgodnie z obowiązującymi przepisami wymaga dodatkowych zabezpieczeń umożliwiających zapewnienie czasu przechowywania danych. Dzięki temu można uzyskać pewność, że dane nie zostaną usunięte przedwcześnie (nieumyślnie lub intencjonalnie). Aby spełnić wymagania, IBM Spectrum Protect for Data Retention zapewnia dodatkową ochronę danych archiwizowanych przez produkt IBM Spectrum Protect.</p>	<ul style="list-style-type: none"> <li>• Dowiedz się więcej i kup</li> <li>• Dokumentacja produktu</li> </ul> <p>Wskazówka: Dokumentacja dla tego produktu jest zawarta w dokumentacji produktu IBM Spectrum Protect.</p>
IBM Spectrum Protect Snapshot	<p>Produkt chroni dane dzięki zintegrowanej funkcji tworzenia i odtwarzania kopii zapasowej obrazu stanu (z rozpoznawaniem aplikacji).</p> <p>Dane przechowywane przez aplikacje IBM® DB2, SAP, Oracle, Microsoft Exchange i Microsoft SQL Server mogą być chronione przez produkt IBM Spectrum Protect Snapshot. Dzięki temu można tworzyć i zarządzać obrazami stanu na poziomie woluminów dla systemów plików i aplikacji niestandardowych. Można określić, czy produkt IBM Spectrum Protect Snapshot ma być zintegrowany z produktem IBM Spectrum Protect.</p>	<ul style="list-style-type: none"> <li>• Dowiedz się więcej i kup</li> <li>• Dokumentacja produktu</li> </ul>

Produkt	Kluczowe korzyści	Odsyłacze
IBM Spectrum Protect for Databases	Chroni dane zapisane w bazach danych Oracle i Microsoft SQL dzięki zautomatyzowanym zadaniom, narzędziom i interfejsom. To oprogramowanie tworzy na bieżąco spójne i scentralizowane kopie zapasowe, chroniąc istotne dane, jednocześnie minimalizując koszty działania. Wskazówka: Obsługa otwartych baz danych IBM DB2 i IBM Informix jest zapewniana przez serwery IBM Spectrum Protect. Do tworzenia kopii zapasowych tych baz danych nie trzeba instalować produktu IBM Spectrum Protect for Databases. Więcej informacji zawiera dokumentacja produktów DB2 i Informix.	<ul style="list-style-type: none"> <li>• Dowiedz się więcej i kup</li> <li>• Dokumentacja produktu</li> </ul>
IBM Spectrum Protect for Enterprise Resource Planning	Udostępnia ochronę danych systemu SAP.	<ul style="list-style-type: none"> <li>• Dowiedz się więcej i kup</li> <li>• Dokumentacja produktu</li> </ul>
IBM Spectrum Protect for Mail	Automatyzuje ochronę danych, dzięki czemu kopie zapasowe są tworzone bez zamykania serwerów Microsoft Exchange lub IBM Domino.	<ul style="list-style-type: none"> <li>• Dowiedz się więcej i kup</li> <li>• Dokumentacja produktu</li> </ul>
IBM Spectrum Protect for Space Management	Produkt hierarchicznego zarządzania pamięcią masową, który zmniejsza koszty pamięci masowej dla rzadko używanych informacji, bez modyfikowania aplikacji i zmiany sposobu pracy użytkowników. Ten produkt jest dostępny dla systemów operacyjnych AIX i Linux.	<ul style="list-style-type: none"> <li>• Dowiedz się więcej i kup</li> <li>• Dokumentacja produktu</li> </ul>
IBM Spectrum Protect HSM for Windows	Produkt hierarchicznego zarządzania pamięcią masową, który zmniejsza koszty pamięci masowej dla rzadko używanych informacji, bez modyfikowania aplikacji i zmiany sposobu pracy użytkowników. Ten produkt jest dostępny dla systemu operacyjnego Windows.	<ul style="list-style-type: none"> <li>• Dowiedz się więcej i kup</li> <li>• Dokumentacja produktu</li> </ul>
IBM Spectrum Protect for SAN	Współpracuje z serwerami i komputerami klienckimi, przesyłając dane w sieci pamięci masowej (SAN) zamiast w sieci LAN. Ten produkt jest agentem pamięci masowej, który umożliwia tworzenie i odtwarzanie kopii zapasowych bez obciążania sieci LAN.	<ul style="list-style-type: none"> <li>• Dowiedz się więcej i kup</li> <li>• Dokumentacja produktu</li> </ul> <p>Product documentation version: The documentation for IBM Spectrum Protect for SAN Version 7.1 is applicable for use with the IBM Spectrum Protect Version 8.1 product family.</p>
IBM Spectrum Protect for Virtual Environments	Zapewnia ochronę dostosowaną do wirtualnych środowisk VMware i Hyper-V.	<ul style="list-style-type: none"> <li>• Dowiedz się więcej i kup</li> <li>• Dokumentacja produktu</li> </ul>
IBM Tivoli Storage Manager for z/OS Media	Zarządza zasobami dyskowymi i taśmowymi w systemie z/OS dla serwerów IBM Spectrum Protect działających w systemach AIX lub Linux na platformie System z.	<ul style="list-style-type: none"> <li>• Dokumentacja produktu</li> </ul>

Gotowe pliki PDF można pobrać z Centrum Wiedzy IBM® lub z serwisu FTP.

## Gotowe pliki PDF

---

W podanych niżej sekcjach zamieszczono pliki PDF dostępne dla tej wersji:

- Rozwiązania ochrony danych
- Serwery
- Klienci kopii zapasowych i archiwalnych
- Interfejs API

## Pakiet plików PDF

---

Pobierz pakiet, który zawiera wszystkie pliki PDF dla tego wydania:

<ftp://public.dhe.ibm.com/software/products/ISP/current/>

## Aktualizacje w tej wersji

---

Zapoznaj się z nowymi funkcjami i udoskonaleniami produktów, aby określić potencjalne korzyści dla operacji zarządzania pamięcią masową. Uwagi do wydania zawierają odsyłacze, do których można uzyskać dostęp w celu uzyskania ważnych informacji przed rozpoczęciem instalacji lub aktualizacji produktów i komponentów.

Komponent	Podsumowanie aktualizacji	Uwagi do wydania dla wersji 8.1
Komponenty serwera	Aktualizacje	Uwagi do wydania
Klient kopii zapasowych i archiwalnych	Aktualizacje	Uwagi do wydania
Aplikacyjny interfejs programistyczny (API)	Aktualizacje	Uwagi do wydania

## IBM Spectrum Protect concepts

---

IBM Spectrum Protect™ provides a comprehensive data protection environment.

- IBM Spectrum Protect overview  
IBM Spectrum Protect provides centralized, automated data protection that helps to reduce data loss and manage compliance with data retention and availability requirements.
- Data storage concepts in IBM Spectrum Protect  
IBM Spectrum Protect provides functions to store data in a range of device and media storage.
- Data protection strategies with IBM Spectrum Protect  
IBM Spectrum Protect provides ways for you to implement various data protection strategies.

## IBM Spectrum Protect overview

---

IBM Spectrum Protect™ provides centralized, automated data protection that helps to reduce data loss and manage compliance with data retention and availability requirements.

- Data protection components  
The data protection solutions that IBM Spectrum Protect provides consist of a server, client systems and applications, and storage media. IBM Spectrum Protect provides management interfaces for monitoring and reporting the data protection status.
- Data protection services  
IBM Spectrum Protect provides data protection services to store and recover data from various types of clients. The data protection services are implemented through policies that are defined on the server. You can use client scheduling to automate the data protection services.
- Processes for managing data protection with IBM Spectrum Protect  
The IBM Spectrum Protect server inventory has a key role in the processes for data protection. You define policies that the server uses to manage data storage.

- User interfaces for the IBM Spectrum Protect environment  
For monitoring and configuration tasks, IBM Spectrum Protect provides various interfaces, including the Operations Center, a command-line interface, and an SQL administrative interface.

## Data protection components

The data protection solutions that IBM Spectrum Protect™ provides consist of a server, client systems and applications, and storage media. IBM Spectrum Protect provides management interfaces for monitoring and reporting the data protection status.

### Server

Client systems send data to the server to be stored as backups or archived data. The server includes an *inventory*, which is a repository of information about client data.

The inventory includes the following components:

#### Database

Information about each file, logical volume, or database that the server backs up, archives, or migrates is stored in the server database. The server database also contains information about the policy and schedules for data protection services.

#### Recovery log

Records of database transactions are kept in this log. The database uses the recovery log to ensure data consistency in the database.

### Client systems and applications

*Clients* are applications, virtual machines, and systems that must be protected. The clients send data to the server, as shown in Figure 1.

Figure 1. Components in the data protection solution

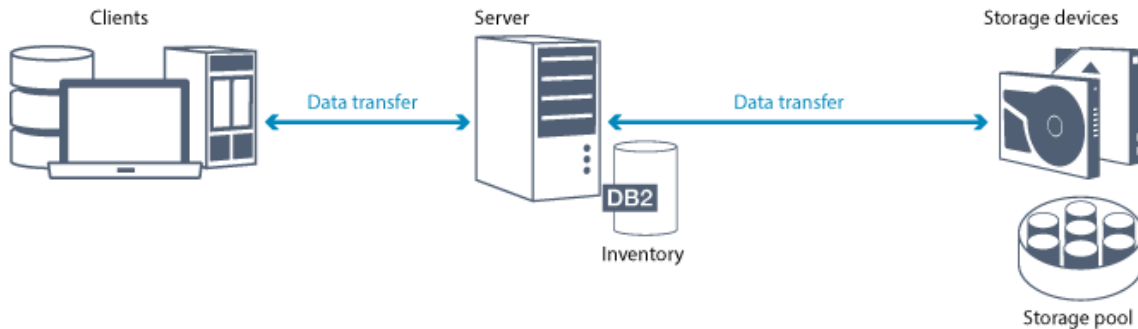

#### Client software

For IBM Spectrum Protect to protect client data, the appropriate software must be installed on the client system and the client must be registered with the server.

#### Client nodes

A *client node* is equivalent to a computer, virtual machine, or application, such as a backup-archive client that is installed on a workstation for file system backups. Each client node must be registered with the server. Multiple nodes can be registered on a single computer.

### Storage media

The server stores client data to storage media. The following types of media are used:

#### Storage devices

The server can write data to hard disk drives, disk arrays and subsystems, stand-alone tape drives, tape libraries, and other types of random-access and sequential-access storage. Storage devices can be connected directly to the server or connected through a local area network (LAN) or a storage area network (SAN).

#### Storage pools

Storage devices that are connected to the server are grouped into *storage pools*. Each storage pool represents a set of storage devices of the same media type, such as disk or tape drives. IBM Spectrum Protect stores all of the client data in storage pools. You can organize storage pools into a *hierarchy*, so that data storage can transfer from disk storage to lower-cost storage such as tape devices.

## Data protection services

IBM Spectrum Protect™ provides data protection services to store and recover data from various types of clients. The data protection services are implemented through policies that are defined on the server. You can use client scheduling to automate the data protection services.

### Types of data protection services

IBM Spectrum Protect provides services to store and recover client data as shown in Figure 1.

Figure 1. Data protection services

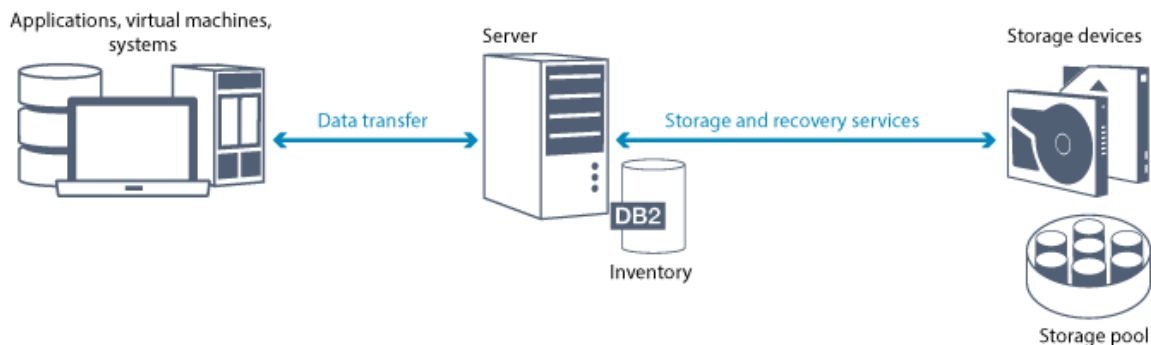

IBM Spectrum Protect provides the following types of data protection services:

#### Back up and restore services

You run a backup process to create a copy of a *data object* that can be used for recovery if the original data object is lost. A data object can be a file, a directory, or a user-defined data object, such as a database.

To minimize the use of system resources during the backup operation, IBM Spectrum Protect uses the *progressive incremental backup* method. For this backup method, a first full backup of all data objects is created and in subsequent backup operations only changed data is moved to storage. Compared to incremental and differential backup methods that require taking periodic full backups, the progressive incremental backup method provides the following benefits:

- Reduces data redundancy
- Uses less network bandwidth
- Requires less storage pool space

To further reduce storage capacity requirements and network bandwidth usage, IBM Spectrum Protect includes *data deduplication* for data backups. The data deduplication technique removes duplicate data extents from backups.

You run a restore process to copy an object from a storage pool to the client. You can restore a single file, all files in a directory, or all of the data on a computer.

#### Archive and retrieve services

You use the archive service to preserve data that must be stored for a long time, such as for regulatory compliance. The archive service provides the following features:

- When you archive data, you specify how long the data must be stored.
- You can request that files and directories are copied to long-term storage on media. For example, you might choose to store this data on a tape device, which can reduce the cost of storage.
- You can specify that the original files are erased from the client after the files are archived.

The retrieve service provides the following features:

- When you retrieve data, the data is copied from a storage pool to a client node.
- The retrieve operation does not affect the archive copy in the storage pool.

## Migrate and recall services

You use migrate and recall services to manage space on client systems. The goal of space management is to maximize available media capacity for new data and to minimize access time to data. You can migrate data to server storage to maintain sufficient free storage space on a local file system. You can store migrated data in the following ways:

- On disk storage for long-term storage
- In a *virtual tape library* (VTL) for fast recall of files

You can recall files to the client node on demand, either automatically or selectively.

## Types of client data that can be protected

---

You can protect data for the following types of clients with IBM Spectrum Protect:

### Application clients

IBM Spectrum Protect can protect data for specific products or applications. These clients are called *application clients*. To protect the *structured data* for these clients, in other words the data in database fields, you must back up components that are specific to the application. IBM Spectrum Protect can protect the following applications:

- IBM Spectrum Protect for Enterprise Resource Planning clients:
  - Data Protection for SAP HANA
  - Data Protection for SAP for DB2®
  - Data Protection for SAP for Oracle
- IBM Spectrum Protect for Databases clients:
  - Data Protection for Microsoft SQL server
  - Data Protection for Oracle
- IBM Spectrum Protect for Mail clients:
  - Data Protection for IBM® Domino®
  - Data Protection for Microsoft Exchange Server

### Virtual machines

Virtual machines that are backed up by using application client software that is installed on the virtual machine. In the IBM Spectrum Protect environment, a virtual machine can be protected by the IBM Spectrum Protect for Virtual Environments.

### System clients

The following IBM Spectrum Protect clients are called *system clients*:

- All clients that back up data in files and directories, in other words *unstructured data*, such as backup-archive clients and API clients that are installed on workstations.
- A server that is included in a server-to-server virtual volume configuration.
- A virtual machine that is backed up by using backup-archive client software that is installed on the virtual machine.

## Processes for managing data protection with IBM Spectrum Protect

---

The IBM Spectrum Protect™ server inventory has a key role in the processes for data protection. You define policies that the server uses to manage data storage.

### Data management process

---

Figure 1 shows the IBM Spectrum Protect data management process.

Figure 1. Data management process

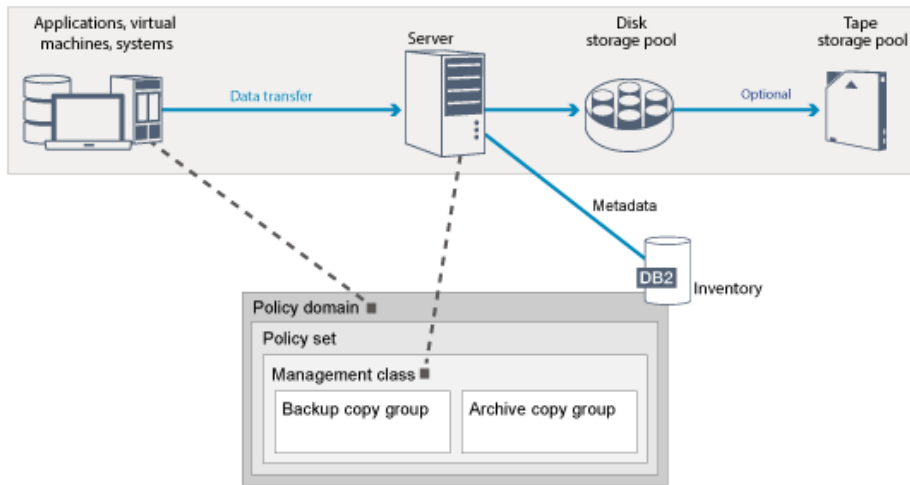

IBM Spectrum Protect uses policies to control how the server stores and manages data objects on various types of storage devices and media. You associate a client with a policy domain that contains one active policy set. When a client backs up, archives, or migrates a file, the file is bound to a management class in the active policy set of the policy domain. The management class and the backup and archive copy groups specify where files are stored and how they are managed. If you set up server storage in a hierarchy, you can migrate files to different storage pools.

## Inventory components

The following inventory components are key to the operation of the server:

### Server database

The server database contains information about client data and server operations. The database stores information about client data, called *metadata*. Information about client data includes the file name, file size, file owner, management class, copy group, and location of the file in server storage. The database includes the following information that is necessary for the operation of the server:

- Definitions of client nodes and administrators
- Policies and schedules
- Server settings
- Records of server operations, such as activity logs and event records
- Intermediate results for administrative queries

### Recovery log

The server records database transactions in the recovery log. The recovery log helps to ensure that a failure does not leave the database in an inconsistent state. The recovery log is also used to maintain consistency across server start operations. The recovery log consists of the following logs:

#### Active log

This log records current transactions on the server. This information is required to start the server and database after a disaster.

#### Log mirror (optional)

The active log mirror is a copy of the active log that can be used if the active log files cannot be read. All changes that are made to the active log are also written to a log mirror. You can set up one active log mirror.

#### Archive log

The archive log contains copies of closed log files that were in the active log. The archive log is included in database backups and is used for recovery of the server database. Archive log files that are included in a database backup are automatically pruned after a full database backup cycle is complete. The archive log must have enough space to store the log files for database backups.

#### Archive failover log (optional)

The archive failover log, also called a secondary archive log, is the directory that the server uses to store archive log files when the archive log directory is full.

## Policy-based data management

In the IBM Spectrum Protect environment, a *policy* for data protection management contains rules that determine how client data is stored and managed. The primary purpose of a policy is to implement the following data management objectives:

- Control which storage pool client data is initially stored in
- Define retention criteria that controls how many copies of objects are stored
- Define how long copies of objects are retained

Policy-based data management helps you to focus on the business requirements for protecting data rather than on managing storage devices and media. Administrators define policies and assign client nodes to a *policy domain*.

Depending on your business needs, you can have one policy or many. In a business organization, for example, different departments with different types of data can have customized storage management plans. Policies can be updated, and the updates can be applied to data that is already managed.

When you install IBM Spectrum Protect, a default policy that is named STANDARD is already defined. The STANDARD policy provides basic backup protection for user workstations. To provide different levels of service for different clients, you can add to the default policy or create a new policy.

You create policies by defining the following policy components:

#### Policy domain

The policy domain is the primary organizational method of grouping client nodes that share common rules for data management. Although a client node can be defined to more than one server, the client node can be defined to only one policy domain on each server.

#### Policy set

A *policy set* is a number of policies that are grouped so that the policy for the client nodes in the domain can be activated or deactivated as required. An administrator uses a policy set to implement different management classes based on business and user needs. A policy domain can contain multiple policy sets, but only one policy set can be active in the domain. Each policy set contains a default management class and any number of extra management classes.

#### Management class

A *management class* is a policy object that you can bind to each category of data to specify how the server manages the data. There can be one or more management classes. One management class is assigned to be the default management class that is used by clients unless they specifically override the default to use a specific management class.

The management class can contain a backup copy group, an archive copy group, and space management attributes. A copy group determines how the server manages backup versions or archived copies of the file. The space management attributes determine whether the file is eligible for migration by the space manager client to server storage, and under what conditions the file is migrated.

#### Copy group

A *copy group* is a set of attributes in a management class that controls the following factors:

- Where the server stores versions of backed up files or archive copies
- How long the server keeps versions of backed up files or archive copies
- How many versions of backup copies are retained
- What method to use to generate versions of backed up files or archive copies

## Security management

---

IBM Spectrum Protect includes security features for registration of administrators and users. After administrators are registered, they must be granted authority by being assigned one or more administrative privilege classes. An administrator with system privilege can perform any server function. Administrators with policy, storage, operator, or node privileges can perform subsets of server functions. The server can be accessed by using the following methods, each controlled with a password:

- Administrator access to manage the server
- Client access to nodes to store and retrieve data

Also included are features that can help to ensure security when clients connect to the server. Depending on business requirements, as an administrator, you can choose one of the following client registration methods:

#### Open registration

When the client first connects to the server, the user is requested for a node name, password, and contact information. Open registration provides the user with following default settings:

- The client node is assigned to the STANDARD policy domain.
- The user can define whether files are compressed to decrease the amount of data that is sent over networks and the space that is occupied by the data in storage.



- The user can delete archived copies of files from server storage, but not backup versions of files.

#### Closed registration

Closed registration is the default method for client registration to the server. For this type of registration, an administrator registers all clients. The administrator can implement the following settings:

- Assign the node to any policy domain
- Determine whether the user can use compression or not, or if the user can choose
- Control whether the user can delete backed up files or archived files

You can add more protection for your data and passwords by using Secure Sockets Layer (SSL). SSL is the standard technology that you use to create encrypted sessions for servers and clients, and provides a secure channel to communicate over open communication paths. With SSL, the identity of the server is verified by using digital certificates. If you authenticate with a Lightweight Directory Access Protocol (LDAP) server, passwords between the server and the LDAP server are protected by Transport Layer Security (TLS). The TLS protocol is the successor to the SSL protocol. When a server and client communicate, TLS ensures that third parties cannot intercept messages.

## User interfaces for the IBM Spectrum Protect environment

For monitoring and configuration tasks, IBM Spectrum Protect™ provides various interfaces, including the Operations Center, a command-line interface, and an SQL administrative interface.

### Interfaces for data storage management

The Operations Center is the primary interface for administrators to monitor and administer servers. A key benefit of the Operations Center is that you can monitor multiple servers, as shown in Figure 1. You can also monitor and administer IBM Spectrum Protect from a command-line administrative interface.

Figure 1. User interfaces for data storage management

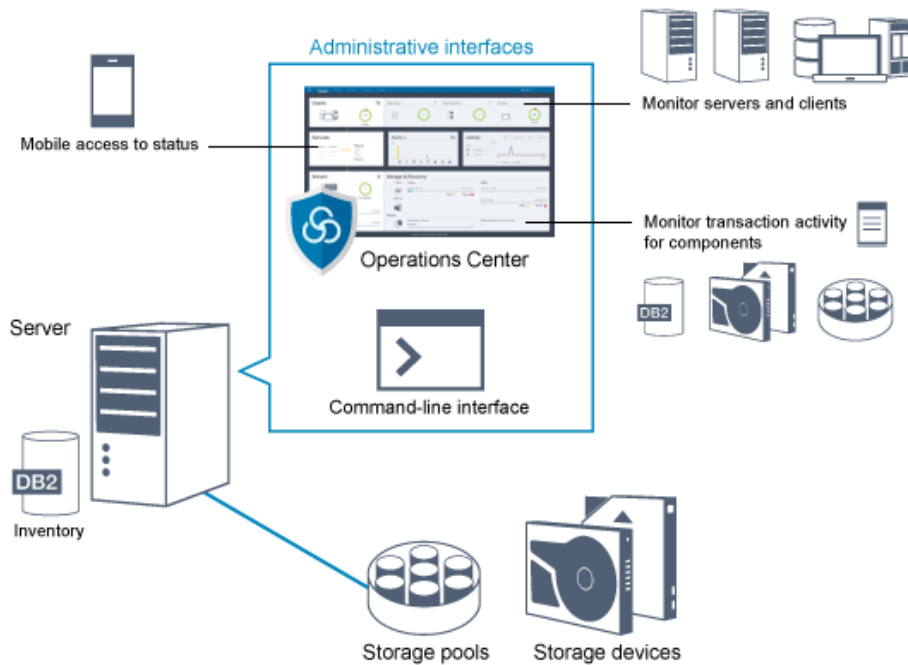

You use the following interfaces to interact with IBM Spectrum Protect:

#### Operations Center

The Operations Center provides web and mobile access to status information about the IBM Spectrum Protect environment. You can use the Operations Center to complete monitoring and certain administration tasks, for example:

- You can monitor multiple servers and clients.
- You can monitor the transaction activity for specific components in the data path, such as the server database, the recovery log, storage devices, and storage pools.

#### Command-line interface

You can use a command-line interface to run administration tasks for servers. You can access the command-line interface through either the IBM Spectrum Protect administrative client or the Operations Center.

Access to information in the server database by using SQL statements

You can use SQL SELECT statements to query the server database and display the results. Third-party SQL tools are available to aid administrators in database management.

## Interfaces for client activity management

---

IBM Spectrum Protect provides the following types of interfaces for managing client activity:

- An application programming interface (API)
- Graphical user interfaces for clients
- Browser interface for the backup-archive client
- Command-line interfaces for clients

## Data storage concepts in IBM Spectrum Protect

---

IBM Spectrum Protect™ provides functions to store data in a range of device and media storage.

To make storage devices available to the server, you must attach the storage devices and map storage pools to device classes, libraries, and drives.

- Types of storage devices  
You can use various storage devices with IBM Spectrum Protect to meet specific data protection goals.
- Data storage in storage pools  
Logical storage pools are the principal components in the IBM Spectrum Protect model of data storage. You can optimize the usage of storage devices by manipulating the properties of storage pools and volumes.
- Data transport to storage across networks  
The IBM Spectrum Protect environment provides ways to securely move data to storage across various types of networks and configurations.

## Types of storage devices

---

You can use various storage devices with IBM Spectrum Protect™ to meet specific data protection goals.

## Storage devices and storage objects

---

The IBM Spectrum Protect server can connect to a combination of manual and automated storage devices. You can connect the following types of storage devices to IBM Spectrum Protect:

- Disk devices that are directly attached, SAN-attached, or network attached
- Physical tape devices that are either manually operated or automated
- Virtual tape devices
- Cloud object storage

IBM Spectrum Protect represents physical storage devices and media with storage objects that you define in the server database. Storage objects classify available storage resources and manage migration from one storage pool to another. Table 1 describes the storage objects in the server storage environment.

Table 1. Storage objects and representations

Storage object	What the object represents
Volume	A discrete unit of storage on disk, tape, or other storage media. Each volume is associated with a single storage pool.

Storage object	What the object represents
Storage pool	<p>A set of storage volumes or containers that is the destination that is used to store client data. IBM Spectrum Protect uses the following types of storage pool:</p> <ul style="list-style-type: none"> <li>• Directory-container storage pools</li> <li>• Cloud-container storage pools</li> <li>• Sequential-access storage pools that are associated with a device class</li> <li>• Random-access storage pools that are associated with a device class</li> </ul>
Container	A data storage location, for example, a file, directory, or device.
Container storage pool	A primary storage pool that a server uses to store data. Data is stored in containers in file system directories or in cloud storage. Data is deduplicated, if necessary, as the server writes data to the storage pool.
Device class	The type of storage device that can use the volumes that are defined in a sequential-access or random-access storage pool. Each device class of removable media type is associated with a single library.
Library	A storage device. For example, a library can represent a stand-alone drive, a set of stand-alone drives, a multiple-drive automated device, or a set of drives that is controlled by a media manager.
Drive	An object of a tape library device that provides the capability to read and write data to tape library media. Each drive is associated with a single library.
Path	The specification of the data source and the device destination. Before a storage device can be used, a path must be defined between the device and the source server that is moving data.
Data mover	A SAN-attached device that is used to transfer client data. A data mover is used only in a data transfer where the server is not present, such as in a Network Data Management Protocol (NDMP) environment. Data movers transfer data between storage devices without using significant server, client, or network resources.
Server	A server that is managed by another IBM Spectrum Protect server.

The administrator defines the storage objects in the logical layer of the server, as illustrated in Figure 1.

Figure 1. Storage objects

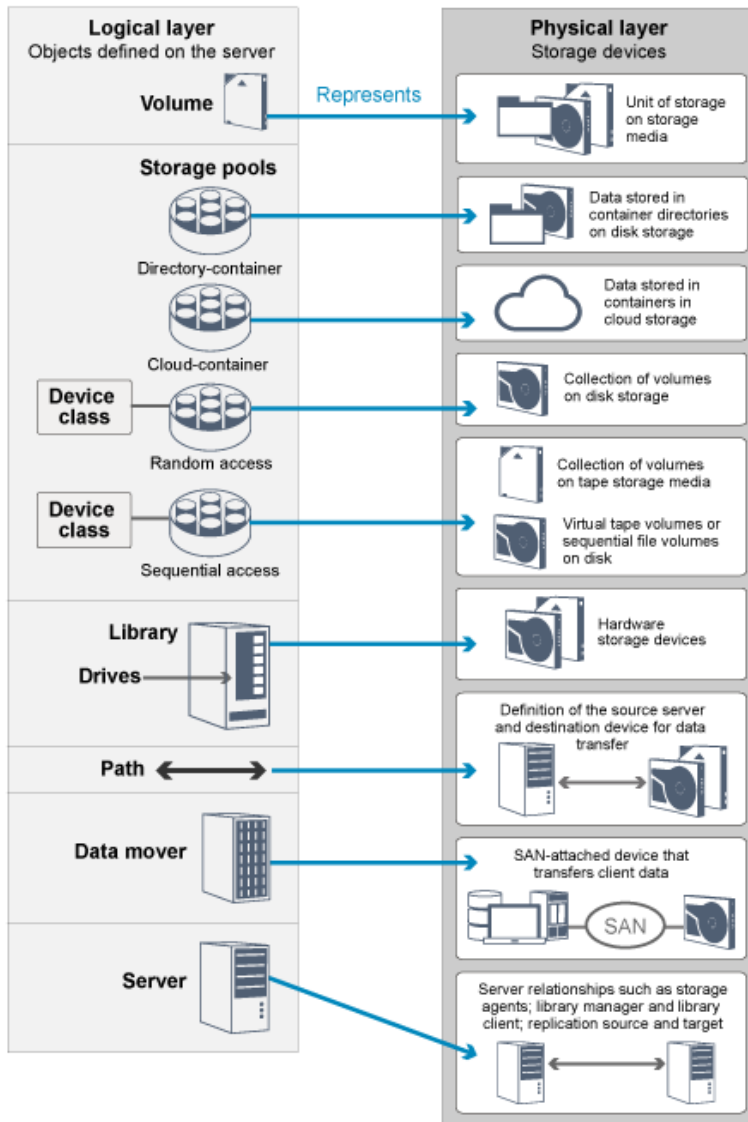

## Disk devices

You can store client data on disk devices with the following types of volumes:

- Directories in directory-container storage pools
- Random-access volumes of device type DISK
- Sequential-access volumes of device type FILE

IBM Spectrum Protect offers the following features when you use directory-container storage pools for data storage:

- You can apply data deduplication and disk caching techniques to maximize data storage usage.
- You can retrieve data from disk much faster than you can retrieve data from tape storage.

## Physical tape devices

In a physical tape library, the storage capacity is defined in terms of the total number of volumes in the library. Physical tape devices can be used for the following activities:

- Storing client data that is backed up, archived, or migrated from client nodes
- Storing database backups
- Exporting data to another server or offsite storage

Moving data to tape provides the following benefits:

- You can keep data for clients on a disk device at the same time that the data is moved to tape.
- You can improve tape drive performance by streaming the data migration from disk to tape.

- You can spread out the times when the drives are in use to improve the efficiency of the tape drives.
- You can move data on tape to off-site vaults.
- You can limit power consumption because tape devices do not consume power after data is written to tape.
- You can apply encryption that is provided by the tape drive hardware to protect the data on tape.

Compared to equivalent disk and virtual tape storage, the unit cost to store data tends to be much less for physical tape devices.

## Virtual tape libraries

---

A virtual tape library (VTL) does not use physical tape media. When you use VTL storage, you emulate the access mechanisms of tape hardware. In a VTL, you can define volumes and drives to provide greater flexibility for the storage environment. The storage capacity of a VTL is defined in terms of total available disk space. You can increase or decrease the number and size of volumes on disk.

Defining a VTL to the IBM Spectrum Protect server can improve performance because the server handles mount point processing for VTLs differently than for real tape libraries. Although the logical limitations of tape devices are still present, the physical limitations for tape hardware are not applicable to a VTL thus affording better scalability. You can use the IBM Spectrum Protect VTL when the following conditions are met:

- Only one type and generation of drive and media is emulated in the VTL.
- Every server and storage agent with access to the VTL has paths that are defined for all drives in the library.

## Data storage in storage pools

---

Logical storage pools are the principal components in the IBM Spectrum Protect™ model of data storage. You can optimize the usage of storage devices by manipulating the properties of storage pools and volumes.

### Types of storage pools

---

The group of storage pools that you set up for the server is called *server storage*. You can define the following types of storage pools in server storage:

#### Primary storage pools

A named set of volumes that the server uses to store backup versions of files, archive copies of files, and files that are migrated from client nodes.

#### Copy storage pools

A named set of volumes that contain copies of files that reside in primary storage pools. Copy storage pools are used only to back up the data that is stored in primary storage pools. A copy storage pool cannot be a destination for a backup copy group, an archive copy group, or a management class for space-managed files.

#### Container-copy storage pools

A named set of volumes that contain a copy of data extents that reside in directory-container storage pools. Container-copy storage pools are used only to protect the data that is stored in directory-container storage pools.

#### Active-data storage pools

A named set of storage pool volumes that contain only active versions of client backup data.

### Primary storage pools

---

When you restore, retrieve, recall, or export file data, the requested file is obtained from a primary storage pool. Depending on the type of primary storage pool, the storage pools can be onsite or offsite. You can arrange primary storage pools in a storage hierarchy so that data can be transferred from disk storage to lower-cost storage such as tape devices. Figure 1 illustrates the concept of primary storage pools.

Figure 1. Primary storage pools

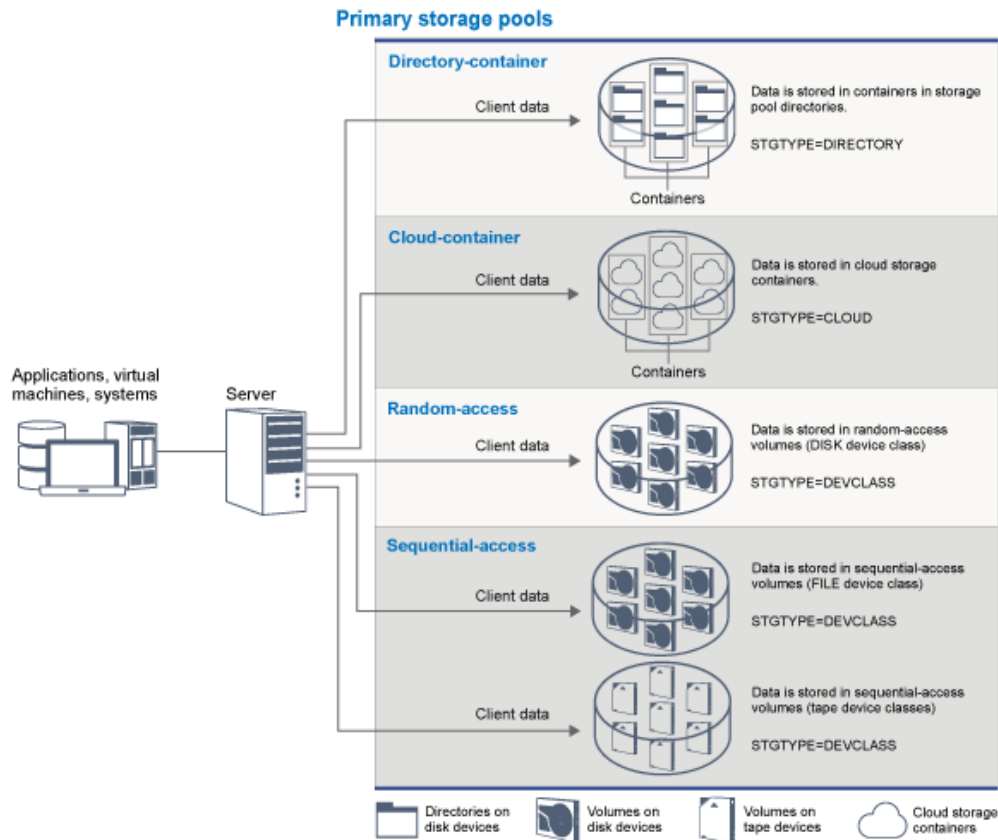

You can define the following types of primary storage pool:

#### Directory-container storage pools

A storage pool that the server uses to store data in containers in storage pool directories. Data that is stored in a directory-container storage pool can use either inline data deduplication, client-side data deduplication, inline compression, or client-side compression. Inline data deduplication or inline compression reduces data at the time it is stored. By using directory-container storage pools, you remove the need for volume reclamation, which improves server performance and reduces the cost of storage hardware. You can protect and repair data in directory-container storage pools at the level of the storage pool.

Restriction: You cannot use any of the following functions with directory-container storage pools:

- Migration
- Reclamation
- Aggregation
- Collocation
- Simultaneous-write
- Storage pool backup
- Virtual volumes

#### Cloud-container storage pools

A storage pool that a server uses to store data in cloud storage. The cloud storage can be on premises or off premises. The cloud-container storage pools that are provided by IBM Spectrum Protect can store data to cloud storage that is object-based. By storing data in cloud-container storage pools, you can exploit the cost per unit advantages that clouds offer along with the scaling capabilities that cloud storage provides. IBM Spectrum Protect manages the credentials, security, read and write I/Os, and the lifecycle for data that is stored to the cloud. When cloud-container storage pools are implemented on the server, you can write directly to the cloud by configuring a cloud-container storage pool with the cloud credentials. Data that is stored in a cloud-container storage pool can use both inline data deduplication and inline compression. The server writes deduplicated and encrypted data directly to the cloud. You can back up and restore data or archive and retrieve data directly from the cloud-container storage pool.

You can define the following types of cloud-container storage pools:

On premises

You can use the on premises type of cloud-container storage pool to store data in a private cloud, for more security and maximum control over your data. The disadvantages of a private cloud are higher costs due to hardware requirements and onsite maintenance.

#### Off premises

You can use the off premises type of cloud-container storage pool to store data in a public cloud. The advantage of using a public cloud is that you can achieve lower costs than for a private cloud, for example by eliminating maintenance. However, you must balance this benefit against possible performance issues due to connection speeds and reduced control over your data.

#### Storage pools that are associated with device classes

You can define a primary storage pool to use the following types of storage devices:

##### DISK device class

In a DISK device type of storage pool, data is stored in random access disk blocks. You can use caching in DISK storage pools to increase client restore performance with some limitations on server processing. Space allocation and tracking by blocks uses more database storage space and requires more processing power than allocation and tracking by volume.

##### FILE device class

In a FILE device type of storage pool, files are stored in sequential volumes for better sequential performance than for storage in disk blocks. To the server, these files have the characteristics of a tape volume so that this type of storage pool is better suited for migration to tape. FILE volumes are useful for *electronic vaulting*, where data is transferred electronically to a remote site rather than by physical shipment of tape. In general, this type of storage pool is preferred over DISK storage pools.

The server uses the following default random-access primary storage pools:

##### ARCHIVEPOOL

In the STANDARD policy, this storage pool is the destination for files that are archived from client nodes.

##### BACKUPPOOL

In the STANDARD policy, this storage pool is the destination for files that are backed up from client nodes.

##### SPACEMGPPOOL

This storage pool is for space-managed files that are migrated from IBM Spectrum Protect for Space Management client nodes.

## Copy storage pools

Copy storage pools contain active and inactive versions of data that is backed up from primary storage pools. A directory-container storage pool cannot be used as a copy storage pool. In addition, data from a directory-container storage pool cannot be copied into a copy storage pool. To protect directory-container storage pools, copy the data to a container-copy storage pool.

Figure 2 illustrates the concept of copy storage pools.

Figure 2. Copy storage pools

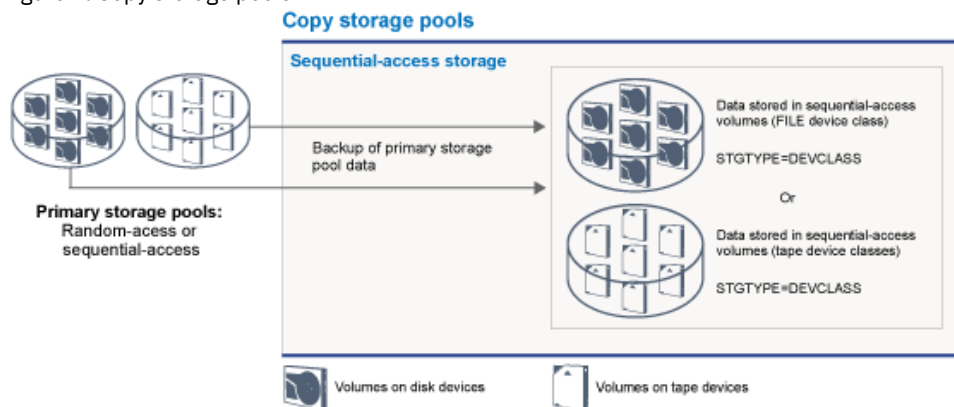

Copy storage pools provide a means of recovering from disasters or media failures. For example, when a client attempts to retrieve a damaged file from the primary storage pool, the client can restore the data from the copy storage pool.

You can move the volumes of copy storage pools offsite and still have the server track the volumes. Moving these volumes offsite provides a means of recovering from an onsite disaster. A copy storage pool can use sequential-access storage only, such as a tape device class or FILE device class.

## Container-copy storage pools

A server can protect a directory-container storage pool by storing copies of the data in a container-copy storage pool. Data in container-copy storage pools is stored on tape volumes, which can be stored onsite or offsite. Damaged data in directory-container storage pools can be repaired by using deduplicated extents in container-copy storage pools. Container-copy storage pools provide an alternative to using a replication server to protect data in a directory-container storage pool.

Restriction: If all server data is lost, container-copy storage pools alone do not provide the same level of protection as replication:

- With replication, you can directly restore client data from the target server if the source server is unavailable.
- With container-copy storage pools, you must first restore the server from a database backup and then repair directory-container storage pools from tape volumes.

Figure 3 illustrates the concept of container-copy storage pools.

Figure 3. Container-copy storage pools

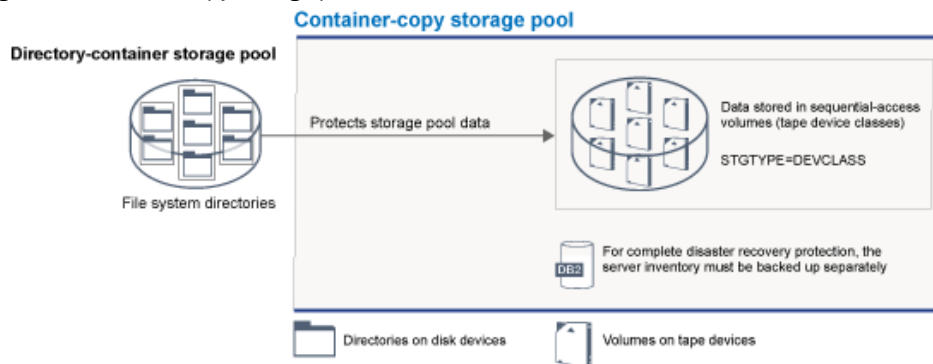

Depending on your system configuration, you can create protection schedules to simultaneously copy the directory-container storage pool data to onsite or offsite container-copy storage pools to meet your requirements:

- If replication is enabled, you can create one offsite container-copy pool. The offsite copy can be used to provide extra protection in a replicated environment.
- If replication is not enabled, you can create one onsite and one offsite storage pool.

Depending on the resources and requirements of your site, the ability to copy directory-container storage pools to tape has the following benefits:

- You avoid maintaining another server and more disk storage space.
- Data is copied to storage pools that are defined on the server. Performance is not dependent on, or affected by, the network connection between servers.
- You can satisfy regulatory and business requirements for offsite tape copies.

## Active-data storage pools

An active-data pool contains only active versions of client backup data. In this case, the server does not have to position past inactive files that do not have to be restored. A directory-container storage pool cannot be used as an active-data storage pool. You use active-data pools to improve the efficiency of data storage and restore operations, for example this type of storage pool can help you to achieve the following objectives:

- Increase the speed of client data restore operations
- Reduce the number of onsite or offsite storage volumes
- Reduce the amount of data that is transferred when you copy or restore files that are vaulted electronically in a remote location

Data that is migrated by hierarchical storage management (HSM) clients and archive data are not permitted in active-data pools. As updated versions of backup data are stored in active-data pools, older versions are removed as the remaining data is consolidated from many sequential-access volumes onto fewer, new sequential-access volumes. Figure 4 illustrates the concept of active-data storage pools.

Figure 4. Active-data storage pools



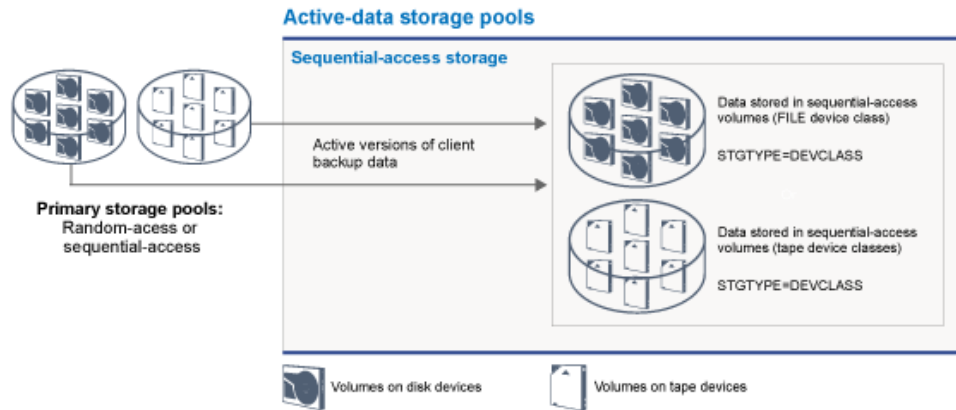

Active-data pools can use any type of sequential-access storage. However, the benefits of an active-data pool depend on the device type that is associated with the pool. For example, active-data pools that are associated with a FILE device class are ideal for fast client restore operations because of the following reasons:

- FILE volumes do not have to be physically mounted
- Client sessions that are restoring from FILE volumes in an active-data pool can access the volumes concurrently, which improves restore performance

**Related information:**

- 🔗 [Directory-container storage pools FAQs](#)
- 🔗 [Cloud-container storage pools FAQs](#)

## Data transport to storage across networks

The IBM Spectrum Protect™ environment provides ways to securely move data to storage across various types of networks and configurations.

### Network configurations for storage devices

IBM Spectrum Protect provides methods for configuring clients and servers on a local area network (LAN), on a storage area network (SAN), LAN-free data movement, and as network-attached storage.

**Data backup operations over a LAN**

Figure 1 shows the data path for IBM Spectrum Protect backup operations over a LAN.

Figure 1. IBM Spectrum Protect backup operations over a LAN

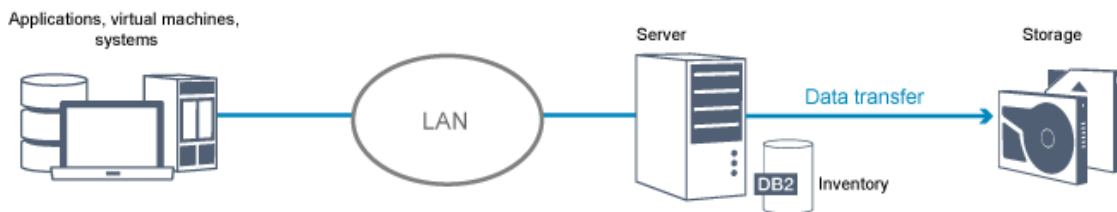

In a LAN configuration, one or more tape libraries are associated with a single IBM Spectrum Protect server. In this type of configuration, client data, electronic mail, terminal connection, application program, and device control information must all be handled by the same network. Device control information and client backup and restore data flow across the LAN.

**Data backup operations over a SAN**

Figure 2 shows the data path for IBM Spectrum Protect backup operations over a SAN.

Figure 2. IBM Spectrum Protect backup operations over a SAN

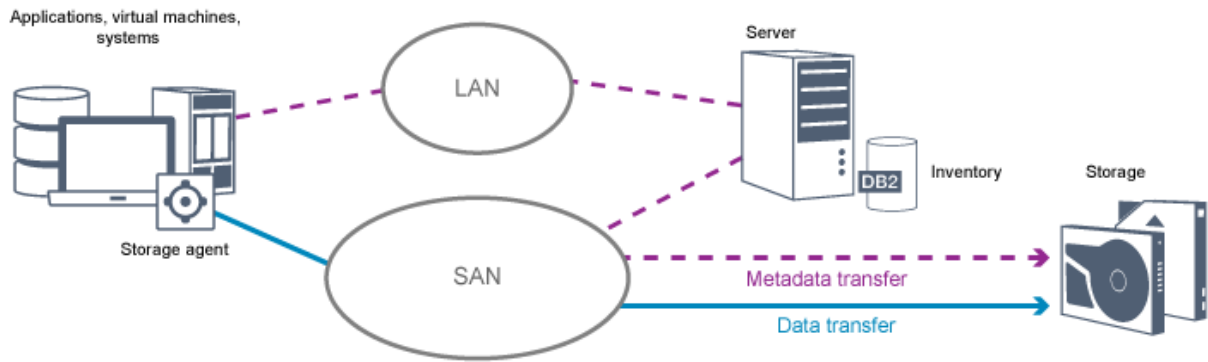

A SAN is a dedicated storage network that can improve system performance. On a SAN, you can consolidate storage and relieve the distance, scalability, and bandwidth limitations of LANs and wide area networks (WANs). By using IBM Spectrum Protect in a SAN, you can take advantage of the following functions:

- Share storage devices among multiple IBM Spectrum Protect servers. Devices that use the GENERICTAPE device type are not included.
- Move data from a client system directly to storage devices without using the LAN. LAN-free data movement requires the installation of a storage agent on the client system. The storage agent is available with the IBM Spectrum Protect for SAN product.

Through the storage agent, the client can directly back up and restore data to a tape library or shared file system such as GPFS™. The IBM Spectrum Protect server maintains the server database and recovery log, and acts as the library manager to control device operations. The storage agent on the client handles the data transfer to the device on the SAN. This implementation frees bandwidth on the LAN that would otherwise be used for client data movement.

- Share tape drives and libraries that are supported by the IBM Spectrum Protect server.
- Consolidate multiple clients under a single client node name in a General Parallel File System (GPFS) cluster.

#### Network-attached storage

Network-attached storage (NAS) file servers are dedicated storage servers whose operating systems are optimized for file-serving functions. NAS file servers typically interact with IBM Spectrum Protect through industry-standard network protocols, such as network data management protocol (NDMP) or as primary storage for random-access or sequential access storage pools. IBM Spectrum Protect provides the following basic types of configurations that use NDMP for backing up and managing NAS file servers:

- IBM Spectrum Protect backs up a NAS file server to a library device that is directly attached to the NAS file server. The NAS file server, which can be remote from the IBM Spectrum Protect server, transfers backup data directly to a drive in a SCSI-attached tape library. Data is stored in NDMP-formatted storage pools, which can be backed up to storage media that can be moved offsite for protection in case of an onsite disaster.
- IBM Spectrum Protect backs up a NAS file server over the LAN to a storage-pool hierarchy. In this type of configuration, you can store NAS data directly to disk, either random access or sequential access, and then migrate the data to tape. You can also use this type of configuration for system replication. Data can also be backed up to storage media that can be moved offsite. The advantage of this type of configuration is that you have all of the data management features associated with a storage pool hierarchy.
- The IBM Spectrum Protect client reads the data from the NAS system by using NFS or CIFS protocols and sends the data to the server to be stored.

## Storage management

You manage the devices and media that are used to store client data through the IBM Spectrum Protect server. The server integrates storage management with the policies that you define for managing client data in the following areas:

#### Types of devices for server storage

With IBM Spectrum Protect, you can use directly attached devices and network-attached devices for server storage. IBM Spectrum Protect represents physical storage devices and media with administrator-defined storage objects.

#### Data migration through the storage hierarchy

For primary storage pools other than directory-container storage pools, you can organize the storage pools into one or more hierarchical structures. This storage hierarchy provides flexibility in a number of ways. For example, you can set a policy to back up data to disks for faster backup operations. The IBM Spectrum Protect server can then automatically migrate data from disk to tape.

### Removal of expired data

The policy that you define controls when client data automatically expires from the IBM Spectrum Protect server. To remove data that is eligible for expiration, a server expiration process marks data as expired and deletes metadata for the expired data from the database. The space that is occupied by the expired data is then available for new data. You can control the frequency of the expiration process by using a server option.

### Media reuse by reclamation

As server policies automatically expire data, the media where the data is stored accumulates unused space. For storage media other than directory-container storage pools or random disk storage pools, the IBM Spectrum Protect server implements *reclamation*, a process that frees media for reuse without traditional tape rotation. Reclamation automatically defragments media by consolidating unexpired data onto other media when the free space on media reaches a defined level. The reclaimed media can then be used again by the server. Reclamation allows media to be automatically circulated through the storage management process and minimize the number of media that are required.

## Consolidating backed up client data

---

By grouping the client data that is backed up, you can minimize the number of media mounts required for client recovery. The IBM Spectrum Protect server provides the following methods for grouping client files on storage media other than directory-container storage pools:

### Collocating client data

The IBM Spectrum Protect server can *collocate* client data, in other words store client data on a few volumes instead of spreading the data across many volumes. Collocation by client minimizes the number of volumes that are required to back up and restore client data. Data collocation might increase the number of volume mounts because each client might have a dedicated volume instead of data storage from several clients in the same volume.

You can set the server to collocate client data when the data is initially placed in server storage. In a storage hierarchy, you can collocate the data when the server migrates the data from the initial storage pool to the next storage pool in the storage hierarchy. You can collocate by client, by file space per client, or by a group of clients. Your selection depends on the size of the file spaces that are stored and restore requirements.

### Associating active-data pools with various devices

Active-data pools are useful for fast restoration of client data. Benefits include a reduction in the number of onsite or offsite storage volumes, or reducing bandwidth when you copy or restore files that are vaulted electronically in a remote location. Active-data pools that use removable media, such as tape, offer similar benefits. Although tape devices must be mounted, the server does not have to position past inactive files. However, the primary benefit of using removable media in active-data pools is that the number of volumes that are used for onsite and offsite storage is reduced. If you store data to a remote location, you can minimize the amount of data that must be transferred by copying and restoring only active data.

### Creating a backup set

A backup set contains all of the active backed-up files that exist for that client in server storage. The backup set is portable and is retained for the time that you specify. A backup set is in addition to the backups that are already stored and requires extra media.

### Moving data for a client node

You can consolidate data for a client node by moving the data within server storage. You can move a backup set to different media, where the backup set is retained until the time that you specify. Consolidating data can help to improve efficiency during client restore or retrieve operations.

## Data protection strategies with IBM Spectrum Protect

---

IBM Spectrum Protect™ provides ways for you to implement various data protection strategies.

You can configure IBM Spectrum Protect to send data to storage devices that are on the local site or on a remote site. To maximize data protection, you can configure replication to a remote server.

- Strategies to minimize the use of storage space for backups  
To minimize the amount of storage space that is required, IBM Spectrum Protect backs up data by using the data deduplication and progressive incremental backup techniques.
- Strategies for disaster protection  
IBM Spectrum Protect provides strategies to protect data if a disaster occurs. These strategies include node replication to a

remote site, storage pool protection, database backups, moving backup tapes offsite, and device replication to a standby server.

- Strategies for disaster recovery with IBM Spectrum Protect  
IBM Spectrum Protect provides several ways to recover the server if the database or storage pools fail.

## Strategies to minimize the use of storage space for backups

To minimize the amount of storage space that is required, IBM Spectrum Protect™ backs up data by using the data deduplication and progressive incremental backup techniques.

### Data deduplication

When the IBM Spectrum Protect server receives data from a client, the server identifies duplicate data extents and stores unique instances of the data extents in a directory-container storage pool. The data deduplication technique improves storage utilization and eliminates the need for a dedicated data deduplication appliance.

Figure 1. Data deduplication process

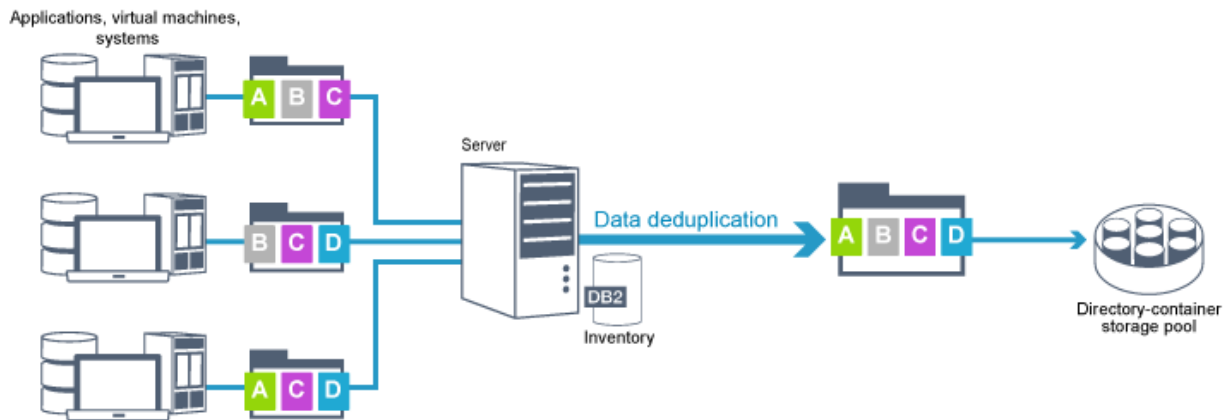

If the same byte pattern occurs many times, data deduplication greatly reduces the amount of data that must be stored or transferred. In addition to whole files, IBM Spectrum Protect can also deduplicate parts of files that are common with parts of other files.

IBM Spectrum Protect provides the following types of data deduplication:

#### Server-side data deduplication

The server identifies duplicate data extents and moves the data to a directory-container storage pool. The server-side process uses *inline data deduplication*, where data is deduplicated at the same time that the data is written to a directory-container storage pool. Deduplicated data can also be stored in other types of storage pools. Inline data deduplication on the server provides the following benefits:

- Eliminates the need for reclamation
- Reduces the space that is occupied by the stored data

#### Client-side data deduplication

With this method, processing is distributed between the server and the client during a backup process. The client and the server identify and remove duplicate data to save storage space on the server. In client-side data deduplication, only compressed, deduplicated data is sent to the server. The server stores the data in the compressed format that is provided by the client. Client-side data deduplication provides the following benefits:

- Reduces the amount of data that is sent over the local area network (LAN)
- Eliminates extra processing power and time that is required to remove duplicate data on the server
- Improves database performance because the client-side data deduplication is also inline

You can combine both client-side and server-side data deduplication in the same production environment. The ability to deduplicate data on either the client or the server provides flexibility in terms of resource utilization, policy management, and data protection.

Compression

Use inline compression to reduce the amount of space that is stored in container storage pools. Data is compressed as it is written to the container storage pool.

Restriction: The IBM Spectrum Protect server cannot compress encrypted data.

## Progressive incremental backup

---

In a progressive incremental backup process, the server monitors client activity and backs up any files that change since the initial full backup. Entire files are backed up, so that the server does not need to reference base versions of the files. This backup technique eliminates the need for multiple full backups of client data thus saving network resources and storage space.

## Strategies for disaster protection

---

IBM Spectrum Protect™ provides strategies to protect data if a disaster occurs. These strategies include node replication to a remote site, storage pool protection, database backups, moving backup tapes offsite, and device replication to a standby server.

### Replication to a remote site

---

*Node replication* is the process of incrementally copying data from one server to another server. The server from which client data is replicated is called a *source replication server*. The server to which client data is replicated is called a *target replication server*. For the purposes of disaster protection, the target replication server is on a remote site. A replication server can function as a source server, a target server, or both. You use replication processing to maintain the same level of files on the source and the target servers.

Node replication provides for immediate availability of data through failover. Although node replication protects most of the metadata, this approach does not provide adequate protection for database damage. You can provide more comprehensive protection by using storage pools to store data backups.

#### Advantages

- Failover so that data is available immediately if a disaster occurs.
- Incremental replication, which results in fast transmission of data.
- Electronic transfer
- Protects both data and most metadata

#### Disadvantages

- Both data and metadata must be recovered.
- Data on the source server must be replicated again from the remote site.

Figure 1 shows the node replication process to a remote site.

Figure 1. Node replication process

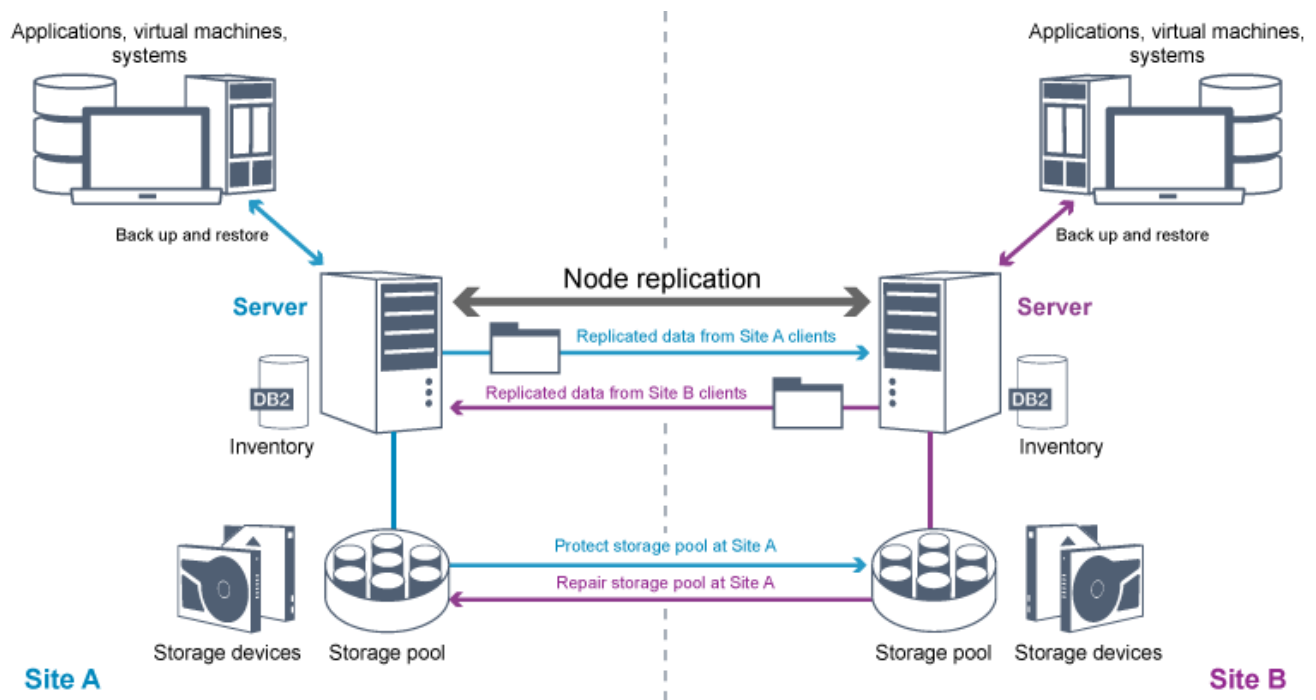

When client data is replicated, data that is not on the target server is copied to the target server. When replicated data exceeds the retention limit, the target server automatically removes the data from the source server. To maximize data protection, you synchronize the local server and the remote server; for example, Site B replicates data from Site A and Site A replicates data from Site B. As part of replication processing, client data that was deleted from the source server is also deleted from the target server.

IBM Spectrum Protect provides the following replication functions:

- You can define policies for the target server in the following ways:
  - Identical policies on the source server and target server
  - Different policies on the source server and target server to meet different business requirements.
 If a disaster occurs and the source server is not available, clients can recover data from the target server. If the source server cannot be recovered, you can direct clients to store data on the target server. When an outage occurs, the clients that are backed up to the source server can automatically fail over to restore their data from the target server.
- You can use replication processing to recover damaged files from storage pools. You must replicate the client data to the target server before the file damage occurs. Subsequent replication processes detect damaged files on the source server and replace the files with undamaged files from the target server.

## Role of replication in disaster protection

If a disaster occurs, you can recover replicated data from the remote site and maintain the same level of files on the source and target servers. You use replication to achieve the following objectives:

- Control network throughput by scheduling node replication at specific times
- Recover data after a site loss.
- Recover damaged files on the source server.

## Storage pool protection

As part of a disaster recovery strategy, ensure that a backup copy of data in storage pools is available at a remote site.

Advantages

- Fast recovery and rebuild of the source system.

Disadvantages

- Only data is protected; metadata is not protected.
- For each storage pool, you must define the storage medium.

You use different techniques to protect against the permanent loss of data that is stored in container storage pools and in FILE and DISK storage pools.

#### Directory-container storage pools

If you do not need to replicate all the data that is contained in a client node, you use container-copy storage pools to protect some directory-container storage pools. By protecting a directory-container storage pool, you do not use resources that replicate existing data and metadata, which improves server performance.

The preferred method is to protect the directory-container storage pool before you replicate the client node. When node replication is started, the data extents that are already replicated through storage pool protection are skipped, which reduces the replication processing time. If the data in a directory-container storage pool becomes damaged, you can repair the data from a copy in a container-copy storage pool.

#### Container-copy storage pools

You protect directory-container storage pools by copying the data in the directory-container storage pool to container-copy storage pools. Use container-copy storage pools to create up to two tape copies of a directory-container storage pool. The tape copies can be stored onsite or offsite. Damaged data in directory-container storage pools can be repaired by using container-copy storage pools. Container-copy storage pools provide an alternative to using a replication server to protect data in a directory-container storage pool.

#### Storage pools that are associated with FILE and DISK device classes

For storage pools that are associated with FILE and DISK device classes, you use node replication to maintain a node-consistent copy of the data at the target server. The data copy can be directly restored from the target server to the storage pools.

## Database backups

---

You use database backups to recover your system following database damage. Also, database backup operations must be used to prevent DB2 from running out of archive log space. Database backup operations are not part of node replication. A database backup can be full, incremental, or snapshot. To provide for disaster recovery, a copy of the database backups must be stored offsite. To restore the database, you must have the backup volumes for the database. You can restore the database from backup volumes by either a point-in-time restore or a most current restore operation.

#### Point-in-time restore

Use point-in-time restore operations for situations such as disaster recovery or to remove the effects of errors that can cause inconsistencies in the database. Restore operations for the database that use snapshot backups are a form of point-in-time restore operation. The point-in-time restore operation includes the following actions:

- Removes and re-creates the active log directory and archive log directory that are specified in the dsmserv.opt file.
- Restores the database image from backup volumes to the database directories that are recorded in a database backup or to new directories.
- Restores archive logs from backup volumes to the overflow directory.
- Uses log information from the overflow directory up to a specified point in time.

#### Most current restore

If you want to recover the database to the time when the database was lost, recover the database to the most current state. The most current restore operation includes the following actions:

- Restores a database image from the backup volumes to the database directories that are recorded in a database backup or to new directories.
- Restores archive logs from backup volumes to the overflow directory.
- Uses log information from the overflow directory and archive logs from archive log directory.

The most current restore does not remove and re-create the active log directory or archive log directory.

## Alternative methods for disaster protection

---

In addition to replication, storage pool protection, and database backups, you can also use the following methods to protect data and implement disaster recovery with IBM Spectrum Protect:

Sending backup tapes to a remote site

Data is backed up to tape at scheduled times by the source server. The tapes are sent to a remote site. If a disaster occurs, the tapes are returned to the site of the source server and the data is restored on the source clients. Offsite copies of data on backup tape can also help you to recover from ransomware attacks.

Multisite appliance replication to a standby server

In the multisite appliance configuration, the source appliance is replicated to a remote server in a SAN architecture. In this configuration, if the client hardware at the original site is damaged, the source device can be replicated from the standby server at the remote site. This configuration provides disk-based backup and restore operations.

## Comparison of protection configuration strategies

---

Consider the following potential data-loss scenarios:

- Database data is damaged: protect against loss of data in the database by using onsite database backup.
- Storage pool data is damaged: protect against loss of data in storage pools by using onsite copy storage pools or node replication.
- Disaster scenario where both the onsite database and storage pools are lost: protect against a full disaster by using node replication and both off-site database backup and storage pool backup copies.

The following possible configurations address the most common data protection scenarios:

Configurations for damage protection only

- Implement database backup operations onsite with an optional container-copy storage pool onsite to protect data in directory-container storage pools.
- Implement database backup operations onsite and node replication onsite.

Configurations for disaster recovery and damage protection

- Implement database backup operations offsite with container-copy storage pools offsite to protect data in directory-container storage pools.
- Implement database backup operations onsite and node replication offsite with an optional container-copy storage pool onsite for faster recovery of damaged data.

## Strategies for disaster recovery with IBM Spectrum Protect

---

IBM Spectrum Protect™ provides several ways to recover the server if the database or storage pools fail.

### Automatic failover for disaster recovery

---

*Automatic failover* is an operation that switches to a standby system if a software, hardware, or network interruption occurs. Automatic failover is used with node replication to recover data after a system failure. Figure 1 shows the IBM Spectrum Protect automatic failover process.

Figure 1. Automatic failover process



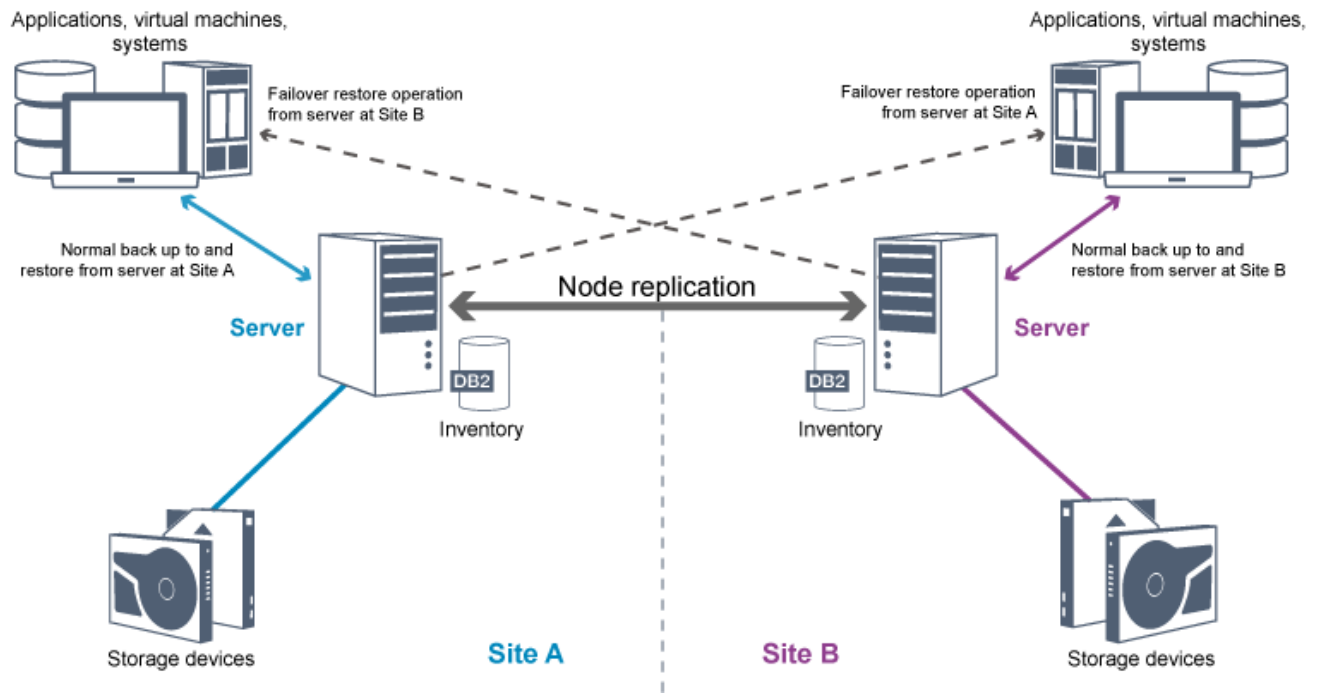

Automatic failover for data recovery occurs if the source replication server is unavailable because of a disaster or a system outage. During normal operations, when the client accesses a source replication server, the client receives connection information for the target replication server. The client node stores the failover connection information in the client options file.

During client restore operations, the server automatically changes clients from the source replication server to the target replication server and back again. Only one server per node can be used for failover protection at any time. When a new client operation is started, the client attempts to connect to the source replication server. The client resumes operations on the source server if the source replication server is available.

To use automatic failover for replicated client nodes, the source replication server, the target replication server, and the client must be at the V7.1 level or later. If any of the servers are at an earlier level, automatic failover is disabled and you must rely on a manual failover process.

## Recovery of IBM Spectrum Protect components

The server database, recovery log, and storage pools are critical to the operation of IBM Spectrum Protect and must be protected. If the database is unusable, the entire server is unavailable and recovering data that is managed by the server might be difficult or impossible.

Even without the database, fragments of data or complete files might be read from storage pool volumes that are not encrypted and security can be compromised. Therefore, you must always back up the database. Also, always encrypt sensitive data by using the client or the storage device, unless the storage media is physically secured.

IBM Spectrum Protect provides several data protection methods, which include backing up storage pools and the database. For example, you can define schedules so that the following operations occur:

- After the initial full backup of your storage pools, incremental storage pool backups are run every night.
- Incremental database backups are run every night.
- Full database backups are run once a week.

For tape-based environments, you can use disaster recovery manager (DRM) to assist you in many of the tasks that are associated with protecting and recovering data. DRM is available with IBM Spectrum Protect Extended Edition.

## Preventive actions for recovery

Recovery is based on the following preventive actions:

- Mirroring, by which the server maintains a copy of the active log
- Backing up the database
- Backing up the storage pools

- Auditing storage pools for damaged files and recovery of damaged files when necessary
- Backing up the device configuration and volume history files
- Validating the data in storage pools by using cyclic redundancy checking
- Storing the cert.kdb file in a safe place to ensure that the Secure Sockets Layer (SSL) is secure

If you are using tape for storage, you can also create a disaster recovery plan to guide you through the recovery process by using DRM. You can use the disaster recovery plan for audit purposes to certify the recoverability of the server. The disaster recovery methods of DRM are based on taking the following actions:

- Creating a disaster recovery plan file for the server
- Backing up server data to tape
- Sending the server backup data to a remote site or to another server
- Storing client system information
- Defining and tracking the storage media that is used for storing and recovering client data

## IBM Spectrum Protect data protection solutions

---

IBM Spectrum Protect™ servers and clients provide data protection solutions for the most common business and compliance requirements.

- Selecting a data protection solution for your environment  
To help you to deploy a data protection environment, review information about best practice IBM Spectrum Protect configurations, and select the best solution for your business needs.
- Single-site disk solution  
This data protection solution provides cost-effective data storage at a single site with minimal hardware setup.
- Multisite disk solution  
This data protection solution provides replication at multiple sites so that each server protects data for the other site.
- Tape solution  
This data protection solution provides storage to tape media, a flexible and affordable option for long-term data retention.
- Server solution documentation in PDF files  
Prebuilt PDF files for IBM Spectrum Protect documentation are available for you to download.

## Selecting a data protection solution for your environment

---

To help you to deploy a data protection environment, review information about best practice IBM Spectrum Protect™ configurations, and select the best solution for your business needs.

- Disk-based implementation of a data protection solution for a single site  
This disk-based implementation of a data protection solution with IBM Spectrum Protect uses inline data deduplication and provides protection for data on a single site.
- Disk-based implementation of a data protection solution for multiple sites  
This disk-based implementation of a data protection solution with IBM Spectrum Protect uses inline data deduplication and replication at two sites.
- Appliance-based implementation of a data protection solution for multiple sites  
This implementation of a multi-site IBM Spectrum Protect data protection solution uses appliance-based data deduplication and replication. A standby server is configured at a second site to recover data if the primary server is unavailable.
- Tape-based implementation of a data protection solution  
This implementation of a data protection solution with IBM Spectrum Protect uses one or more tape storage devices to back up data. Tape backup provides low-cost scalability that is optimized for long-term retention.
- Comparison of data protection solutions  
Compare the key features for each IBM Spectrum Protect solution to determine which configuration best meets your data protection requirements. Then, review the available documentation to implement the solution.
- Roadmap for implementing a data protection solution  
Plan and implement the most suitable data protection solution for your business environment with IBM Spectrum Protect.

## Disk-based implementation of a data protection solution for a single site

---

This disk-based implementation of a data protection solution with IBM Spectrum Protect™ uses inline data deduplication and provides protection for data on a single site.



## Single-site disk

✓ Single-site architecture

✓ Cost effective

✓ Space efficient

✓ Simpler implementation

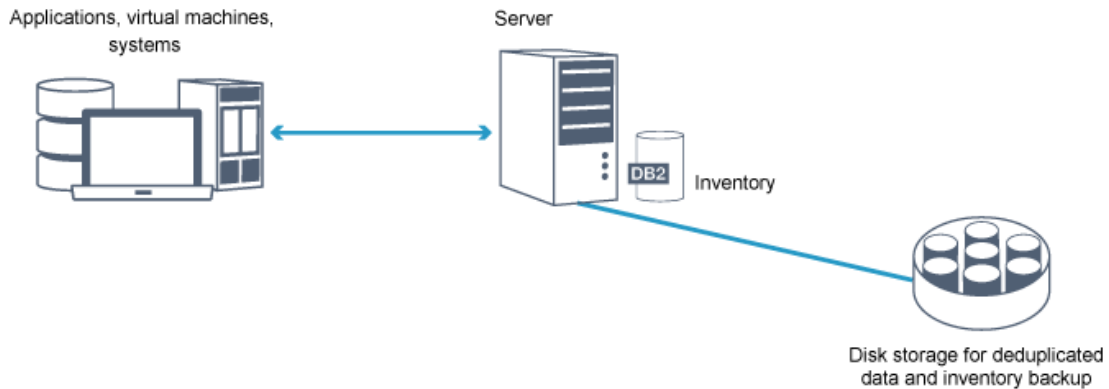

This data protection solution provides the following benefits:

- Server system and storage hardware at a single site
- Cost-effective use of storage through the data deduplication feature
- Space-efficient solution with minimal hardware setup
- Minimal implementation that requires installation and configuration for only one server and supporting storage hardware

In this solution, the client sends data to the IBM Spectrum Protect server, where the data is deduplicated and stored in a directory-container storage pool that is implemented in disk storage. Data from the inventory is also backed up to disk storage. This solution is suitable for entry-level environments for which a second copy of data is not required.

**Related reference:**

Comparison of data protection solutions

Roadmap for implementing a data protection solution

## Disk-based implementation of a data protection solution for multiple sites

This disk-based implementation of a data protection solution with IBM Spectrum Protect™ uses inline data deduplication and replication at two sites.

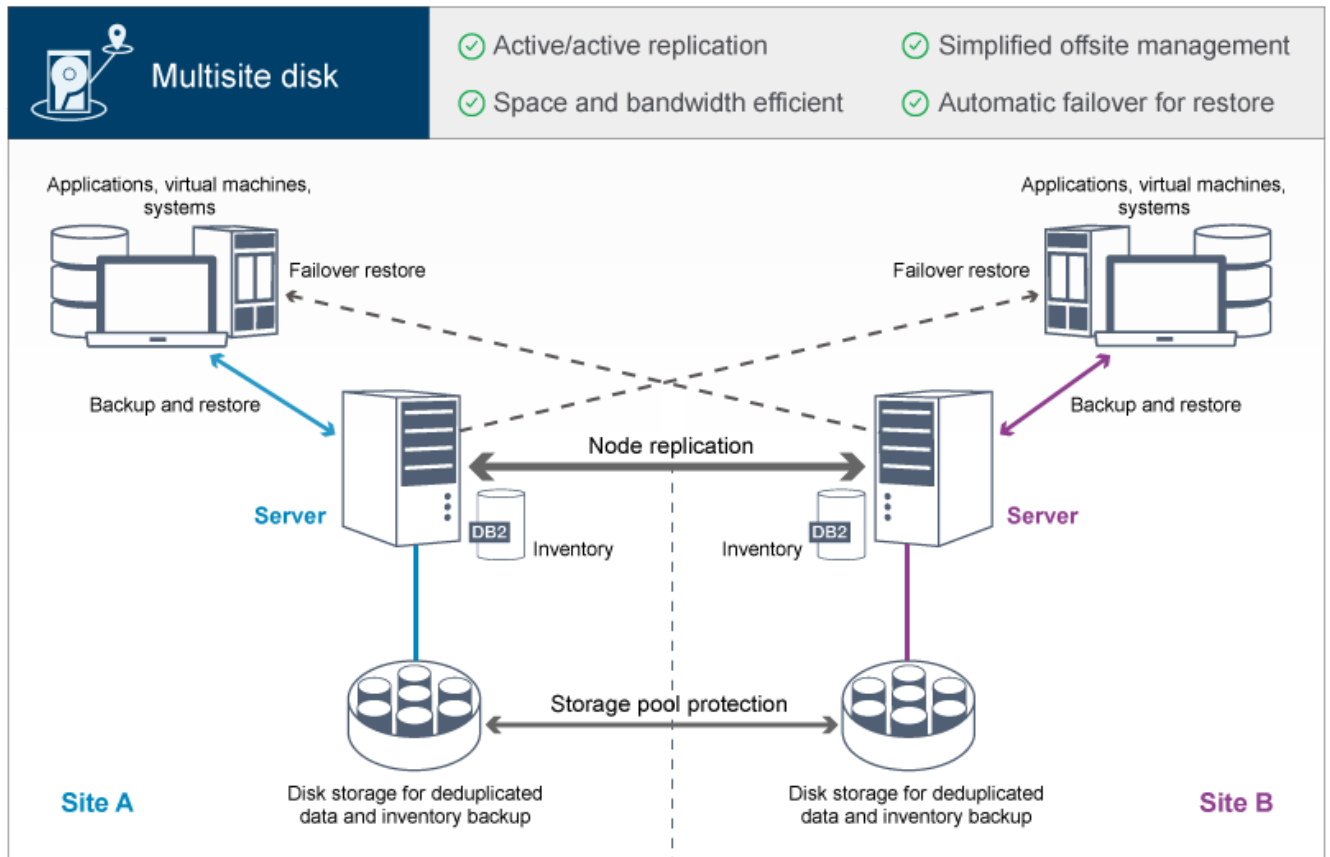

This data protection solution provides the following benefits:

- Replication can be configured at both sites so that each server protects data for the other site
- Offsite data storage for each location is simplified
- Bandwidth is used efficiently because only deduplicated data is replicated between the sites
- Clients can automatically fail over to a target replication server if the source replication server is unavailable

In this solution, clients send data to the source server, where the data is deduplicated and stored in a directory-container storage pool that is implemented in disk storage. The data is replicated to the storage pool on the target server for each site. This solution is suitable for environments that require disaster protection. If mutual replication is configured, clients at both sites can use failover recovery for continued backups and data recovery from the available server on the other site.

**Related reference:**

- Comparison of data protection solutions
- Roadmap for implementing a data protection solution

## Appliance-based implementation of a data protection solution for multiple sites

This implementation of a multi-site IBM Spectrum Protect™ data protection solution uses appliance-based data deduplication and replication. A standby server is configured at a second site to recover data if the primary server is unavailable.

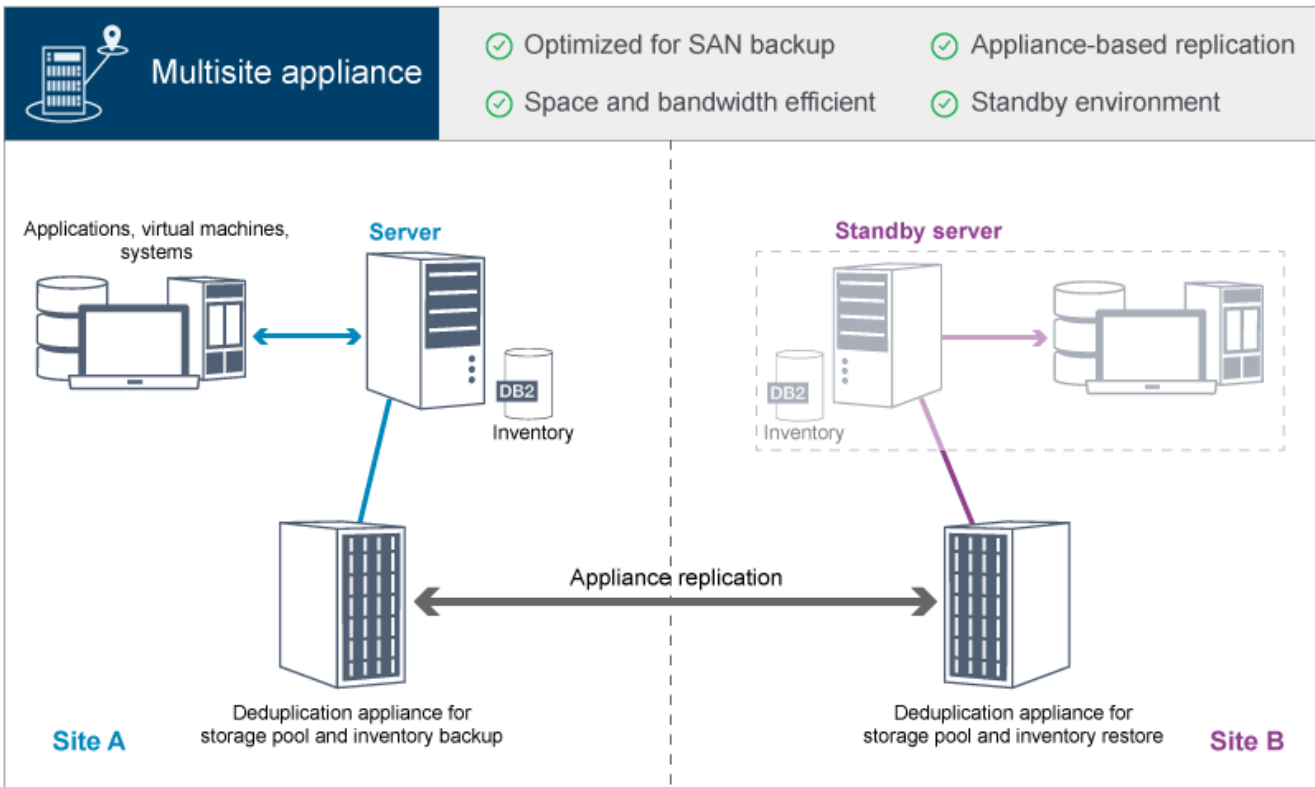

This data protection solution provides the following benefits:

- Performance is optimized for backups on high-speed storage area networks (SAN) and for use with IBM Spectrum Protect for SAN, when clients back up directly to SAN-attached virtual tape devices.
- Fast, appliance-based replication frees the server from having to track replication metadata in the server database.
- Bandwidth and storage space are used efficiently because only deduplicated data is replicated between the sites.
- A standby environment provides for disaster recovery, but does not require the amount of resources that are needed for a fully active site.

In this data protection configuration, the server uses hardware appliances to deduplicate and replicate data. The appliance at Site A deduplicates data and then replicates the data to the appliance at Site B for disaster protection. If a failure at Site A occurs, you make the standby server active by restoring the most recent database backup, and by activating the replicated copy of data.

For more information about configuring virtual tape libraries, see [Configuring virtual tape libraries](#).

**Related reference:**

- Comparison of data protection solutions
- Roadmap for implementing a data protection solution

## Tape-based implementation of a data protection solution

This implementation of a data protection solution with IBM Spectrum Protect™ uses one or more tape storage devices to back up data. Tape backup provides low-cost scalability that is optimized for long-term retention.

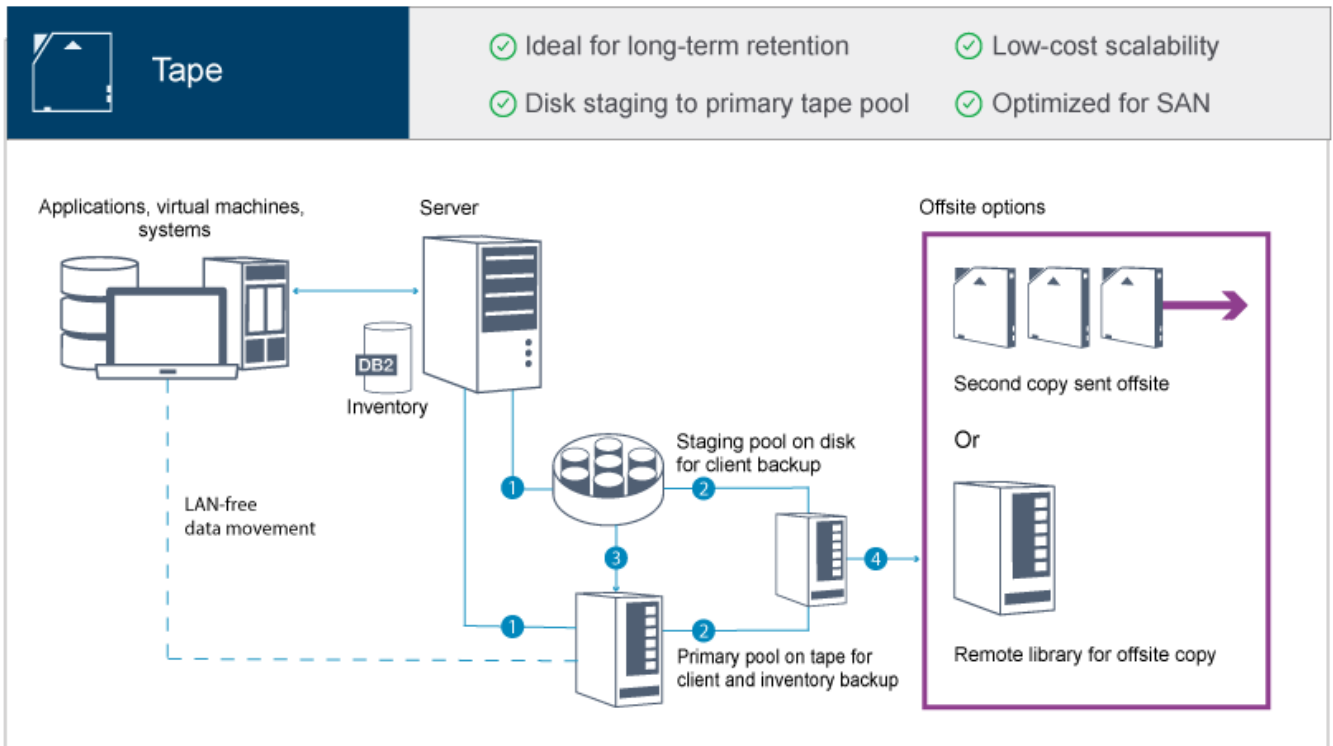

This data protection solution provides the following benefits:

- Performance is optimized for backup operations on high-speed storage area networks (SAN) directly to tape for large data types and for long-term retention of data.
- Data availability is optimized by storing copies of data at offsite locations for disaster recovery.
- Low-cost scalability is achieved by reducing the need for additional disk hardware and lowering energy costs.

**Related concepts:**

Selecting a tape device driver

**Related tasks:**

Creating data backup strategies

Managing volume inventory

**Related reference:**





Comparison of data protection solutions

Installing and configuring tape device drivers

## Comparison of data protection solutions

Compare the key features for each IBM Spectrum Protect™ solution to determine which configuration best meets your data protection requirements. Then, review the available documentation to implement the solution.

	Single-site disk	Multisite disk	Multisite appliance	Tape
<b>Highlights</b>				
Cost	\$	\$\$\$	\$\$\$\$	\$\$
Protection level	One data copy	Two or more data copies	Two or more data copies	Two or more data copies
Disaster recovery	None	Active server	Standby server	Offsite copies
<b>Key benefits</b>				
Leading-edge data reduction	✓	✓	✓	✓

	Single-site disk	Multisite disk	Multisite appliance	Tape
				
Fast and efficient disk-based backup and restore operations	✓		✓	
Simplified offsite management		✓		
Data deduplication feature at no extra cost	✓	✓		
Replication processing included at no extra charge		✓		
Data deduplication at both the source and target server		✓		
Low-cost scalability and optimized for long-term retention				✓
<b>Efficiency and cost</b>				
Optimized for high-speed storage area network (SAN) backup operations			✓	✓
Optimized for high-speed local area network (LAN)	✓	✓	✓	
Global data deduplication across all data types and sources	✓	✓	✓	
Bandwidth-efficient replication		✓	✓	
Lower energy costs				✓
Option for a second copy without extra disk hardware				✓
<b>Availability</b>				
Offsite copy capability		✓	✓	✓
Appliance-based replication			✓	
Client recovery from high-availability server		✓		
Replication target in the cloud		✓		
Independent management of retention policies for replication data; ability to keep more or less data at recovery site		✓		
Application-level replication; ability to choose which systems and applications are replicated		✓		
<b>Scalability</b>				
Global data deduplication across servers			✓	
SAN-optimized backup directly to tape for large data types				✓
Single-instance petabyte scalability				✓

## What to do next

Review available documentation for the solutions in Roadmap for implementing a data protection solution.

**Related reference:**

Disk-based implementation of a data protection solution for a single site

Disk-based implementation of a data protection solution for multiple sites  
Appliance-based implementation of a data protection solution for multiple sites  
Tape-based implementation of a data protection solution

## Roadmap for implementing a data protection solution

---

Plan and implement the most suitable data protection solution for your business environment with IBM Spectrum Protect™.

### Single-site disk solution

---

For steps that describe how to plan for, implement, monitor, and operate a single-site disk solution, see [Single-site disk solution](#).

### Multisite disk solution

---

For steps that describe how to plan for, implement, monitor, and operate a multisite disk solution, see [Multisite disk solution](#).

### Tape solution

---

For steps that describe how to plan for, implement, monitor, and operate a tape device solution, see [Tape solution](#).

### Multisite appliance solution

---

For an overview of the tasks that are required to implement a multisite appliance solution, review the following steps:

1. Begin planning for the solution by reviewing information at the following links:
  - o [AIX: Capacity planning](#)
  - o [Linux: Capacity planning](#)
  - o [Windows: Capacity planning](#)
2. Install the server and optionally, the Operations Center. Review information at the following links:
  - o [Installing the server](#)
  - o [Installing and upgrading the Operations Center](#)
3. Configure the server for storage in a virtual tape library.
  - o [Managing virtual tape libraries](#)
  - o [Attaching tape devices for the server](#)

For guidance about improving system performance, see [Configuration best practices](#).

4. Configure policies to protect your data. Review the information in [Customizing policies](#).
5. Set up client schedules. Review the information in [Scheduling backup and archive operations](#).
6. Install and configure clients. To determine the type of client software that you need, review the information in [Adding clients for details](#).
7. Configure monitoring for your system. Review the information in [Monitoring storage solutions](#).

#### Related reference:

[Comparison of data protection solutions](#)  
[Disk-based implementation of a data protection solution for a single site](#)  
[Disk-based implementation of a data protection solution for multiple sites](#)  
[Appliance-based implementation of a data protection solution for multiple sites](#)  
[Tape-based implementation of a data protection solution](#)

## Single-site disk solution

---

This data protection solution provides cost-effective data storage at a single site with minimal hardware setup.

- [Planning for a single-site disk data protection solution](#)  
Plan for a data protection implementation that includes a server at a single site that uses data deduplication.
- [Single-site disk implementation of a data protection solution](#)  
The single-site disk solution is configured at one site and uses data deduplication.
- [Monitoring a single-site disk solution](#)  
After you implement a single-site disk solution with IBM Spectrum Protect, monitor the solution for correct operation. By



monitoring the solution daily and periodically, you can identify existing and potential issues. The information that you gather can be used to troubleshoot problems and optimize system performance.

- Managing operations for a single-site disk solution

Use this information to manage operations for a single-site disk solution with IBM Spectrum Protect that includes a server and uses data deduplication for a single location.

## Planning for a single-site disk data protection solution

Plan for a data protection implementation that includes a server at a single site that uses data deduplication.

### Implementation options

You can configure the server for a single-site disk solution in the following ways:

Configure the server by using the Operations Center and administrative commands

This documentation provides steps to configure a range of storage systems and the server software for your solution.

Configuration tasks are completed by using wizards and options in the Operations Center and IBM Spectrum Protect™ commands. For information about getting started, see the Planning roadmap.

Configure the server by using automated scripts

For detailed guidance on implementing a single-site disk solution with specific IBM® Storwize® storage systems, and by using automated scripts to configure the server, see the IBM Spectrum Protect blueprints. The documentation and scripts are available on IBM developerWorks® at: IBM Spectrum Protect Blueprints.

The blueprint documentation does not include steps for installing and configuring the Operations Center, or setting up secure communications by using Transport Security Layer (TLS). An option for using Elastic Storage Server, based on IBM Spectrum Scale™ technology, is included.

### Planning roadmap

Plan for the single-site disk solution by reviewing the architecture layout in the following figure and then completing the roadmap tasks that follow the diagram.

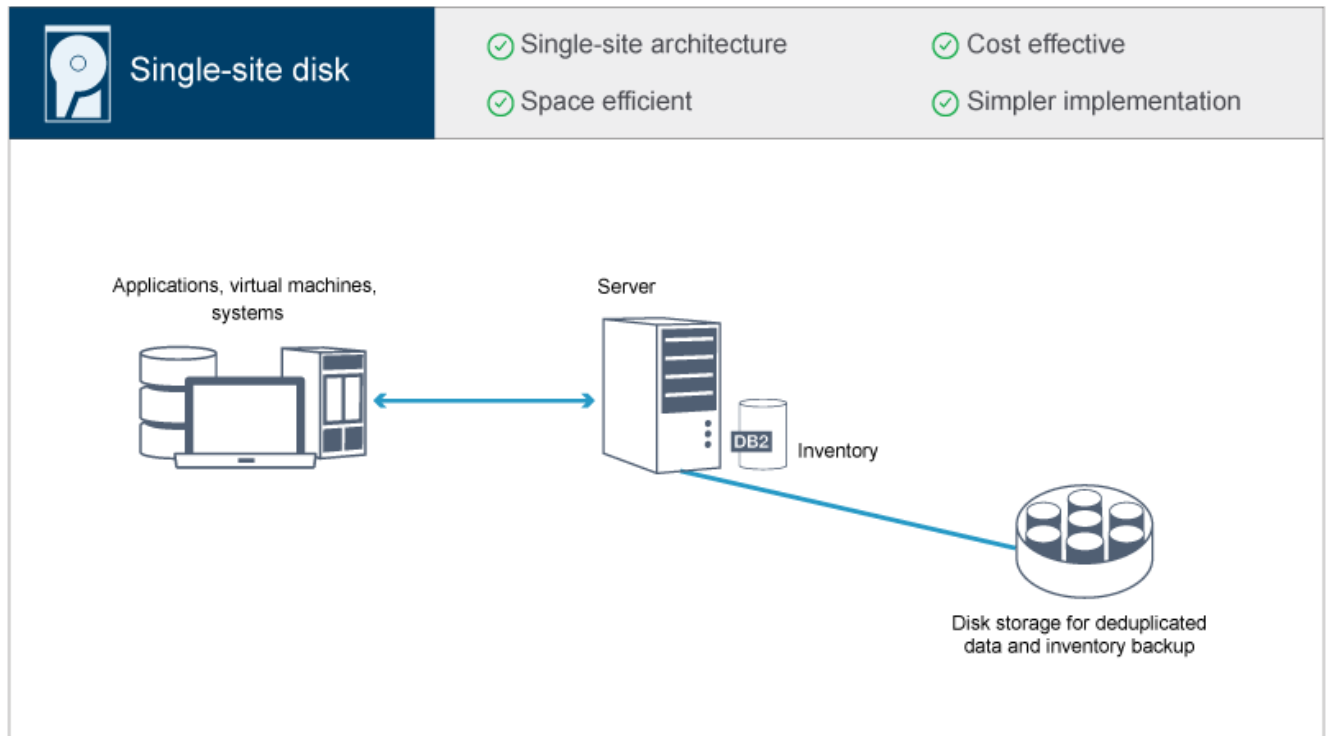

The following steps are required to plan for a single-site disk environment.

1. Select your system size.
2. Meet system requirements for hardware and software.
3. Record values for your system configuration in the planning worksheets.

4. Plan for storage.
5. Plan for security.
  - a. Plan for administrator roles.
  - b. Plan for secure communications.
  - c. Plan for storage of encrypted data.
  - d. Plan for firewall access.

## Selecting a system size

Select the size of the IBM Spectrum Protect™ server based on the amount of data that you manage and the systems to be protected.

### About this task

You can use the information in the table to determine the size of the server that is required, based on the amount of data that you manage.

The following table describes the volume of data that a server manages. This amount includes all versions. The daily amount of data is how much new data you back up each day. Both the total managed data and daily amount of new data are measured as the size before any data reduction.

Table 1. Determining the size of the server

Total managed data	Daily amount of new data to back up	Required server size
48 TB - 192 TB	Up to 10 TB per day	Small
200 TB - 800 TB	10 - 20 TB per day	Medium
1000 TB - 4000 TB	20 - 100 TB per day	Large

The daily backup values in the table are based on test results with 128 MB sized objects, which are used by IBM Spectrum Protect for Virtual Environments. Workloads that consist of objects that are smaller than 128 KB might not be able to achieve these daily limits.

## System requirements for a single-site disk solution

After you select the IBM Spectrum Protect™ solution that best fits your data protection requirements, review the system requirements to plan for implementation of the data protection solution.

Ensure that your system meets the hardware and software prerequisites for the size of server that you plan to use.

- **Hardware requirements**  
Hardware requirements for your IBM Spectrum Protect solution are based on system size. Choose equivalent or better components than those items that are listed to ensure optimum performance for your environment.
- **Software requirements**  
Documentation for the single-site disk IBM Spectrum Protect solution includes installation and configuration tasks for the following operating systems. You must meet the minimum software requirements that are listed.

#### Related information:

[IBM Spectrum Protect Supported Operating Systems](#)

## Hardware requirements

Hardware requirements for your IBM Spectrum Protect™ solution are based on system size. Choose equivalent or better components than those items that are listed to ensure optimum performance for your environment.

For a definition of system sizes, see [Selecting a system size](#).

The following table includes minimum hardware requirements for the server and storage, based on the size of the server that you plan to build. If you are using local partitions (LPARs) or work partitions (WPARs), adjust the network requirements to take account of the partition sizes.

Hardware component	Small system	Medium system	Large system

Hardware component	Small system	Medium system	Large system
Server processor	<p><b>AIX</b> 6 processor cores, 3.42 GHz or faster</p> <p><b>Linux</b>   <b>Windows</b> 12 processor cores, 1.9 GHz or faster</p>	<p><b>AIX</b> 8 processor cores, 3.42 GHz or faster</p> <p><b>Linux</b>   <b>Windows</b> 16 processor cores, 2.0 GHz or faster</p>	<p><b>AIX</b> 20 processor cores, 3.42 GHz</p> <p><b>Linux</b>   <b>Windows</b> 32 processor cores, 2.0 GHz or faster</p>
Server memory	64 GB RAM	128 GB RAM	192 GB RAM
Network	<ul style="list-style-type: none"> <li>10 GB Ethernet (1 port)</li> <li>8 GB Fibre Channel adapter (2 ports)</li> </ul>	<ul style="list-style-type: none"> <li>10 GB Ethernet (2 ports)</li> <li>8 GB Fibre Channel adapter (2 ports)</li> </ul>	<ul style="list-style-type: none"> <li>10 GB Ethernet (4 ports)</li> <li>8 GB Fibre Channel adapter (4 ports)</li> </ul>
Storage	<ul style="list-style-type: none"> <li>1.3 TB inventory, plus space for Operations Center records</li> <li>46 TB deduplicated directory-container storage pool</li> </ul>	<ul style="list-style-type: none"> <li>2 TB inventory, plus space for Operations Center records</li> <li>200 TB deduplicated directory-container storage pool</li> </ul>	<ul style="list-style-type: none"> <li>6 TB inventory, plus space for Operations Center records</li> <li>1000 TB deduplicated directory-container storage pool</li> </ul>

## Estimating database space requirements for the Operations Center

Hardware requirements for the Operations Center are included in the preceding table, except for the database and archive log space (inventory) that the Operations Center uses to hold records for managed clients.

If you do not plan to install the Operations Center on the same system as the server, you can estimate system requirements separately. To calculate system requirements for the Operations Center, see the system requirements calculator in technote 1641684.

Managing the Operations Center on the server is a workload that requires extra space for database operations. The amount of space depends on the number of clients that are monitored on a server. Review the following guidelines to estimate how much space your server requires.

### Database space

The Operations Center uses approximately 1.2 GB of database space for every 1000 clients that are monitored on a server. For example, consider a hub server with 2000 clients that also manages three spoke servers, each with 1500 clients. This configuration has a total of 6500 clients across the four servers and requires approximately 8.4 GB of database space. This value is calculated by rounding the 6500 clients up to the next closest 1000, which is 7000:

$$7 \times 1.2 \text{ GB} = 8.4 \text{ GB}$$

### Archive log space

The Operations Center uses approximately 8 GB of archive log space every 24 hours, for every 1000 clients. In the example of 6500 clients across the hub server and the spoke servers, 56 GB of archive log space is used over a 24-hour period for the hub server.

For each spoke server in the example, the archive log space that is used over 24 hours is approximately 16 GB. These estimates are based on the default status collection interval of 5 minutes. If you reduce the collection interval from once every 5 minutes to once every 3 minutes, the space requirements increase. The following examples show the approximate increase in the log space requirement with a collection interval of once every 3 minutes:

- Hub server: 56 GB to approximately 94 GB
- Each spoke server: 16 GB to approximately 28 GB

Increase the archive log space so that you have sufficient space available to support the Operations Center, without affecting the existing server operations.

## Software requirements

Documentation for the single-site disk IBM Spectrum Protect™ solution includes installation and configuration tasks for the following operating systems. You must meet the minimum software requirements that are listed.

For information about software requirements for IBM® lin\_tape device drivers, refer to the IBM Tape Device Drivers Installation and User's Guide.

## AIX systems

Type of software	Minimum software requirements
Operating system	IBM AIX® 7.1  For more information about operating system requirements, see AIX: Minimum system requirements for AIX systems.
Gunzip utility	The gunzip utility must be available on your system before you install or upgrade the IBM Spectrum Protect server. Ensure that the gunzip utility is installed and the path to it is set in the PATH environment variable.
File system type	JFS2 file systems  AIX systems can cache a large amount of file system data, which can reduce memory that is required for server and IBM DB2® processes. To avoid paging with the AIX server, use the rbrw mount option for the JFS2 file system. Less memory is used for the file system cache and more is available for IBM Spectrum Protect.  Do not use the file system mount options, Concurrent I/O (CIO), and Direct I/O (DIO), for file systems that contain the IBM Spectrum Protect database, logs, or storage pool volumes. These options can cause performance degradation of many server operations. IBM Spectrum Protect and DB2 can still use DIO where it is beneficial to do so, but IBM Spectrum Protect does not require the mount options to selectively take advantage of these techniques.
Other software	Korn Shell (ksh)

## Linux systems

Type of software	Minimum software requirements
Operating system	Red Hat Enterprise Linux 7 (x86_64)
Libraries	GNU C libraries, Version 2.3.3-98.38 or later that is installed on the IBM Spectrum Protect system. Red Hat Enterprise Linux Servers: <ul style="list-style-type: none"> <li>• libaio</li> <li>• libstdc++.so.6 (32-bit and 64-bit packages are required)</li> <li>• numactl.x86_64</li> </ul>
File system type	Format database-related file systems with ext3 or ext4.  For storage pool-related file systems, use XFS.
Other software	Korn Shell (ksh)

## Windows systems

Type of software	Minimum software requirements
Operating system	Microsoft Windows Server 2012 R2 (64-bit) or Windows Server 2016
File system type	NTFS
Other software	Windows 2012 R2 or Windows 2016 with .NET Framework 3.5 is installed and enabled.  The following User Account Control policies must be disabled: <ul style="list-style-type: none"> <li>• User Account Control: Admin Approval Mode for the Built-in Administrator account</li> <li>• User Account Control: Run all administrators in Admin Approval Mode</li> </ul>

**Related tasks:**

[Setting AIX network options](#)

## Planning worksheets

Use the planning worksheets to record values that you use to set up your system and configure the IBM Spectrum Protect™ server. Use the best practice default values that are listed in the worksheets.

Each worksheet helps you prepare for different parts of the system configuration by using best practice values:

### Server system preconfiguration

Use the preconfiguration worksheets to plan for the file systems and directories that you create when you configure file systems for IBM Spectrum Protect during system setup. All directories that you create for the server must be empty.

### Server configuration

Use the configuration worksheets when you configure the server. Default values are suggested for most items, except where noted.

**AIX®**

Table 1. Worksheet for preconfiguration of an AIX server system

Item	Default value	Your value	Minimum directory size	Notes
TCP/IP port address for communications with the server	1500		Not applicable	Ensure that this port is available when you install and configure the operating system  The port number can be a number in the range 1024 - 32767.
Directory for the server instance	/home/tsminst1/tsminst1		50 GB	If you change the value for the server instance directory from the default, also modify the DB2® instance owner value in Table 2.
Directory for server installation	/		Available space that is required for the directory: 5 GB	
Directory for server installation	/usr		Available space that is required for the directory: 5 GB	
Directory for server installation	/var		Available space that is required for the directory: 5 GB	
Directory for server installation	/tmp		Available space that is required for the directory: 5 GB	
Directory for server installation	/opt		Available space that is required for the directory: 10 GB	
Directory for the active log	/tsminst1/TSMalog		<ul style="list-style-type: none"> <li>• Small and medium: 140 GB</li> <li>• Large: 300 GB</li> </ul>	When you create the active log during the initial configuration of the server, set the size to 128 GB.

Item	Default value	Your value	Minimum directory size	Notes
Directory for the archive log	/tsminst1/TSMarchlog		<ul style="list-style-type: none"> <li>• Small: 1 TB</li> <li>• Medium: 3 TB</li> <li>• Large: 4 TB</li> </ul>	
Directories for the database	/tsminst1/TSMdbspace00 /tsminst1/TSMdbspace01 /tsminst1/TSMdbspace02 /tsminst1/TSMdbspace03 ...		Minimum total space for all directories: <ul style="list-style-type: none"> <li>• Small: At least 1 TB</li> <li>• Medium: At least 2 TB</li> <li>• Large: At least 4 TB</li> </ul>	Create a minimum number of file systems for the database, depending on the size of your system: <ul style="list-style-type: none"> <li>• Small: At least 4 file systems</li> <li>• Medium: At least 4 file systems</li> <li>• Large: At least 8 file systems</li> </ul>
Directories for storage	/tsminst1/TSMfile00 /tsminst1/TSMfile01 /tsminst1/TSMfile02 /tsminst1/TSMfile03 ...		Minimum total space for all directories: <ul style="list-style-type: none"> <li>• Small: At least 38 TB</li> <li>• Medium: At least 180 TB</li> <li>• Large: At least 500 TB</li> </ul>	Create a minimum number of file systems for storage, depending on the size of your system: <ul style="list-style-type: none"> <li>• Small: At least 10 file systems</li> <li>• Medium: At least 20 file systems</li> <li>• Large: At least 40 file systems</li> </ul>
Directories for database backup	/tsminst1/TSMbkup00 /tsminst1/TSMbkup01 /tsminst1/TSMbkup02 /tsminst1/TSMbkup03		Minimum total space for all directories: <ul style="list-style-type: none"> <li>• Small: At least 3 TB</li> <li>• Medium: At least 10 TB</li> <li>• Large: At least 16 TB</li> </ul>	Create a minimum number of file systems for backing up the database, depending on the size of your system: <ul style="list-style-type: none"> <li>• Small: At least 2 file systems</li> <li>• Medium: At least 4 file systems</li> <li>• Large: At least 4 file systems, but preferably 6</li> </ul> <p>The first database backup directory is also used for the archive log failover directory and a second copy of the volume history and device configuration files.</p>

Table 2. Worksheet for IBM Spectrum Protect configuration

Item	Default value	Your value	Notes
DB2 instance owner	tsminst1		If you changed the value for the server instance directory in Table 1 from the default, also modify the value for the DB2 instance owner.
DB2 instance owner password	passw0rd		Select a different value for the instance owner password than the default. Ensure that you record this value in a secure location.
Primary group for the DB2 instance owner	tsmsrvrs		
Server name	The default value for the server name is the system host name.		
Server password	passw0rd		Select a different value for the server password than the default. Ensure that you record this value in a secure location.
Administrator ID: user ID for the server instance	admin		
Administrator ID password	passw0rd		Select a different value for the administrator password than the default. Ensure that you record this value in a secure location.
Schedule start time	22:00		<p>The default schedule start time begins the client workload phase, which is predominantly the client backup and archive activities. During the client workload phase, server resources support client operations. Normally, these operations are completed during the nightly schedule window.</p> <p>Schedules for server maintenance operations are defined to begin 10 hours after the start of the client backup window.</p>

## Linux

Table 3. Worksheet for preconfiguration of a Linux server system

Item	Default value	Your value	Minimum directory size	Notes
------	---------------	------------	------------------------	-------

Item	Default value	Your value	Minimum directory size	Notes
TCP/IP port address for communications with the server	1500		Not applicable	Ensure that this port is available when you install and configure the operating system  The port number can be a number in the range 1024 - 32767.
Directory for the server instance	/home/tsminst1/tsminst1		25 GB	If you change the value for the server instance directory from the default, also modify the DB2 instance owner value in Table 4.
Directory for the active log	/tsminst1/TSMalog		<ul style="list-style-type: none"> <li>• Small and medium: 140 GB</li> <li>• Large: 300 GB</li> </ul>	
Directory for the archive log	/tsminst1/TSMarchlog		<ul style="list-style-type: none"> <li>• Small: 1 TB</li> <li>• Medium: 3 TB</li> <li>• Large: 4 TB</li> </ul>	
Directories for the database	/tsminst1/TSMdbspace00 /tsminst1/TSMdbspace01 /tsminst1/TSMdbspace02 /tsminst1/TSMdbspace03 ...		Minimum total space for all directories: <ul style="list-style-type: none"> <li>• Small: At least 1 TB</li> <li>• Medium: At least 2 TB</li> <li>• Large: At least 4 TB</li> </ul>	Create a minimum number of file systems for the database, depending on the size of your system: <ul style="list-style-type: none"> <li>• Small: At least 4 file systems</li> <li>• Medium: At least 4 file systems</li> <li>• Large: At least 8 file systems</li> </ul>
Directories for storage	/tsminst1/TSMfile00 /tsminst1/TSMfile01 /tsminst1/TSMfile02 /tsminst1/TSMfile03 ...		Minimum total space for all directories: <ul style="list-style-type: none"> <li>• Small: At least 38 TB</li> <li>• Medium: At least 180 TB</li> <li>• Large: At least 500 TB</li> </ul>	Create a minimum number of file systems for storage, depending on the size of your system: <ul style="list-style-type: none"> <li>• Small: At least 10 file systems</li> <li>• Medium: At least 20 file systems</li> <li>• Large: At least 40 file systems</li> </ul>



Item	Default value	Your value	Minimum directory size	Notes
Directories for database backup	/tsminst1/TSMbkup00 /tsminst1/TSMbkup01 /tsminst1/TSMbkup02 /tsminst1/TSMbkup03		Minimum total space for all directories: <ul style="list-style-type: none"> <li>• Small: At least 3 TB</li> <li>• Medium: At least 10 TB</li> <li>• Large: At least 16 TB</li> </ul>	Create a minimum number of file systems for backing up the database, depending on the size of your system: <ul style="list-style-type: none"> <li>• Small: At least 2 file systems</li> <li>• Medium: At least 4 file systems</li> <li>• Large: At least 4 file systems, but preferably 6</li> </ul> <p>The first database backup directory is also used for the archive log failover directory and a second copy of the volume history and device configuration files.</p>

Table 4. Worksheet for IBM Spectrum Protect configuration

Item	Default value	Your value	Notes
DB2 instance owner	tsminst1		If you changed the value for the server instance directory in Table 3 from the default, also modify the value for the DB2 instance owner.
DB2 instance owner password	passw0rd		Select a different value for the instance owner password than the default. Ensure that you record this value in a secure location.
Primary group for the DB2 instance owner	tsmsrvrs		
Server name	The default value for the server name is the system host name.		
Server password	passw0rd		Select a different value for the server password than the default. Ensure that you record this value in a secure location.
Administrator ID: user ID for the server instance	admin		
Administrator ID password	passw0rd		Select a different value for the administrator password than the default. Ensure that you record this value in a secure location.

Item	Default value	Your value	Notes
Schedule start time	22:00		<p>The default schedule start time begins the client workload phase, which is predominantly the client backup and archive activities. During the client workload phase, server resources support client operations. Normally, these operations are completed during the nightly schedule window.</p> <p>Schedules for server maintenance operations are defined to begin 10 hours after the start of the client backup window.</p>

## Windows

Because many volumes are created for the server, configure the server by using the Windows feature of mapping disk volumes to directories rather than to drive letters.

For example, C:\tsminst1\TSMdbpspace00 is a mount point to a volume with its own space. The volume is mapped to a directory under the C: drive, but does not take up space from the C: drive. The exception is the server instance directory, C:\tsminst1, which can be a mount point or a regular directory.

Table 5. Worksheet for preconfiguration of a Windows server system

Item	Default value	Your value	Minimum directory size	Notes
TCP/IP port address for communications with the server	1500		Not applicable	<p>Ensure that this port is available when you install and configure the operating system</p> <p>The port number can be a number in the range 1024 - 32767.</p>
Directory for the server instance	C:\tsminst1		25 GB	If you change the value for the server instance directory from the default, also modify the DB2 instance owner value in Table 6.
Directory for the active log	C:\tsminst1\TSMalog		<ul style="list-style-type: none"> <li>• Small and medium: 140 GB</li> <li>• Large: 300 GB</li> </ul>	
Directory for the archive log	C:\tsminst1\TSMarchlog		<ul style="list-style-type: none"> <li>• Small: 1 TB</li> <li>• Medium: 3 TB</li> <li>• Large: 4 TB</li> </ul>	

Item	Default value	Your value	Minimum directory size	Notes
Directories for the database	C:\tsminst1\TSMdbspace00 C:\tsminst1\TSMdbspace01 C:\tsminst1\TSMdbspace02 C:\tsminst1\TSMdbspace03 ...		Minimum total space for all directories: <ul style="list-style-type: none"> <li>• Small: At least 1 TB</li> <li>• Medium: At least 2 TB</li> <li>• Large: At least 4 TB</li> </ul>	Create a minimum number of file systems for the database, depending on the size of your system: <ul style="list-style-type: none"> <li>• Small: At least 4 file systems</li> <li>• Medium: At least 4 file systems</li> <li>• Large: At least 8 file systems</li> </ul>
Directories for storage	C:\tsminst1\TSMfile00 C:\tsminst1\TSMfile01 C:\tsminst1\TSMfile02 C:\tsminst1\TSMfile03 ...		Minimum total space for all directories: <ul style="list-style-type: none"> <li>• Small: At least 38 TB</li> <li>• Medium: At least 180 TB</li> <li>• Large: At least 500 TB</li> </ul>	Create a minimum number of file systems for storage, depending on the size of your system: <ul style="list-style-type: none"> <li>• Small: At least 10 file systems</li> <li>• Medium: At least 20 file systems</li> <li>• Large: At least 40 file systems</li> </ul>
Directories for database backup	C:\tsminst1\TSMbkup00 C:\tsminst1\TSMbkup01 C:\tsminst1\TSMbkup02 C:\tsminst1\TSMbkup03		Minimum total space for all directories: <ul style="list-style-type: none"> <li>• Small: At least 3 TB</li> <li>• Medium: At least 10 TB</li> <li>• Large: At least 16 TB</li> </ul>	Create a minimum number of file systems for backing up the database, depending on the size of your system: <ul style="list-style-type: none"> <li>• Small: At least 2 file systems</li> <li>• Medium: At least 4 file systems</li> <li>• Large: At least 4 file systems, but preferably 6</li> </ul> <p>The first database backup directory is also used for the archive log failover directory and a second copy of the volume history and device configuration files.</p>

Table 6. Worksheet for IBM Spectrum Protect configuration

Item	Default value	Your value	Notes
------	---------------	------------	-------

Item	Default value	Your value	Notes
DB2 instance owner	tsminst1		If you changed the value for the server instance directory in Table 5 from the default, also modify the value for the DB2 instance owner.
DB2 instance owner password	pAssW0rd		Select a different value for the instance owner password than the default. Ensure that you record this value in a secure location.
Server name	The default value for the server name is the system host name.		
Server password	passw0rd		Select a different value for the server password than the default. Ensure that you record this value in a secure location.
Administrator ID: user ID for the server instance	admin		
Administrator ID password	passw0rd		Select a different value for the administrator password than the default. Ensure that you record this value in a secure location.
Schedule start time	22:00		<p>The default schedule start time begins the client workload phase, which is predominantly the client backup and archive activities. During the client workload phase, server resources support client operations. Normally, these operations are completed during the nightly schedule window.</p> <p>Schedules for server maintenance operations are defined to begin 10 hours after the start of the client backup window.</p>

## Planning for storage

Choose the most effective storage technology for IBM Spectrum Protect™ components to ensure efficient server performance and operations.

Storage hardware devices have different capacity and performance characteristics, which determine how they can be used effectively with IBM Spectrum Protect. For general guidance on selecting the appropriate storage hardware and set up for your solution, review the following guidelines.

### Database and active log

- Use a fast disk for the IBM Spectrum Protect database and active log, for example with the following characteristics:
  - High performance, 15k rpm disk with Fibre Channel or serial-attached SCSI (SAS) interface
  - Solid-state disk (SSD)
- Isolate the active log from the database unless you use SSD or flash hardware

- When you create arrays for the database, use RAID level 5

#### Storage pool

- You can use less expensive and slower disks for the storage pool
- The storage pool can share disks for the archive log and database backup storage
- Use RAID level 6 for storage pool arrays to add protection against double drive failures when you use large disk types
- Planning the storage arrays  
Prepare for disk storage configuration by planning for RAID arrays and volumes, according to the size of your IBM Spectrum Protect system.

#### Related reference:

[Storage system requirements and reducing the risk of data corruption](#)

## Planning for security

Plan to protect the security of systems in the IBM Spectrum Protect™ solution with access and authentication controls, and consider encrypting data and password transmission.

- Planning for administrator roles  
Define the authority levels that you want to assign to administrators who have access to the IBM Spectrum Protect solution.
- Planning for secure communications  
Plan for protecting communications among the IBM Spectrum Protect solution components.
- Planning for storage of encrypted data  
Determine whether your company requires stored data to be encrypted, and choose the option that best suits your needs.
- Planning firewall access  
Determine the firewalls that are set and the ports that must be open for the IBM Spectrum Protect solution to work.

## Planning for administrator roles

Define the authority levels that you want to assign to administrators who have access to the IBM Spectrum Protect™ solution.

You can assign one of the following levels of authority to administrators:

#### System

Administrators with system authority have the highest level of authority. Administrators with this level of authority can complete any task. They can manage all policy domains and storage pools, and grant authority to other administrators.

#### Policy

Administrators who have policy authority can manage all of the tasks that are related to policy management. This privilege can be unrestricted, or can be restricted to specific policy domains.

#### Storage

Administrators who have storage authority can allocate and control storage resources for the server.

#### Operator

Administrators who have operator authority can control the immediate operation of the server and the availability of storage media such as tape libraries and drives.

The scenarios in Table 1 provide examples about why you might want to assign varying levels of authority so that administrators can perform tasks:

Table 1. Scenarios for administrator roles

Scenario	Type of administrator ID to set up
An administrator at a small company manages the server and is responsible for all server activities.	<ul style="list-style-type: none"> <li>• System authority: 1 administrator ID</li> </ul>
An administrator for multiple servers also manages the overall system. Several other administrators manage their own storage pools.	<ul style="list-style-type: none"> <li>• System authority on all servers: 1 administrator ID for the overall system administrator</li> <li>• Storage authority for designated storage pools: 1 administrator ID for each of the other administrators</li> </ul>

Scenario	Type of administrator ID to set up
An administrator manages 2 servers. Another person helps with the administration tasks. Two assistants are responsible for helping to ensure that important systems are backed up. Each assistant is responsible for monitoring the scheduled backups on one of the IBM Spectrum Protect servers.	<ul style="list-style-type: none"> <li>• System authority on both servers: 2 administrator IDs</li> <li>• Operator authority: 2 administrator IDs for the assistants with access to the server that each person is responsible for</li> </ul>

## Planning for secure communications

Plan for protecting communications among the IBM Spectrum Protect™ solution components.

Determine the level of protection that is required for your data, based on regulations and business requirements under which your company operates.

If your business requires a high level of security for passwords and data transmission, plan on implementing secure communication with Transport Layer Security (TLS) or Secure Sockets Layer (SSL) protocols.

TLS and SSL provide secure communications between the server and client, but can affect system performance. To improve system performance, use TLS for authentication without encrypting object data. To specify whether the server uses TLS 1.2 for the entire session or only for authentication, see the SSL client option for client-to-server communication, and the UPDATE SERVER=SSL parameter for server-to-server communication. Beginning in V8.1.2, TLS is used for authentication by default. If you decide to use TLS to encrypt entire sessions, use the protocol only for sessions where it is necessary and add processor resources on the server to manage the increase in network traffic. You can also try other options. For example, some networking devices such as routers and switches provide the TLS or SSL function.

You can use TLS and SSL to protect some or all of the different possible communication paths, for example:

- Operations Center: browser to hub; hub to spoke
- Client to server
- Server to server: node replication

### Related tasks:

[🔗 Securing communications](#)

## Planning for storage of encrypted data

Determine whether your company requires stored data to be encrypted, and choose the option that best suits your needs.

If your company requires the data in storage pools to be encrypted, then you have the option of using IBM Spectrum Protect™ encryption, or an external device such as tape for encryption.

If you choose IBM Spectrum Protect to encrypt the data, extra computing resources are required at the client that might affect the performance of backup and restore processes.

### Related information:

[🔗 technote 1963635](#)

## Planning firewall access

Determine the firewalls that are set and the ports that must be open for the IBM Spectrum Protect™ solution to work.

Table 1 describes the ports that are used by the server, client, and Operations Center.

Table 1. Ports that are used by the server, client, and Operations Center

Item	Default	Direction	Description
------	---------	-----------	-------------

Item	Default	Direction	Description
Base port (TCPSPORT)	1500	Outbound/inbound	Each server instance requires a unique port. You can specify an alternative port number instead of using the default. The TCPSPORT option listens for both TCP/IP and SSL-enabled sessions from the client. For administrative client traffic, you can use the TCPADMINPORT and ADMINONCLIENTPORT options to set port values.
SSL-only port (SSLTCPSPORT)	No default	Outbound/inbound	This port is used if you want to restrict communication on the port to SSL-enabled sessions only. To support both SSL and non-SSL communications, use the TCPSPORT or TCPADMINPORT options.
SMB	45	Inbound/outbound	This port is used by configuration wizards that communicate by using native protocols with multiple hosts.
SSH	22	Inbound/outbound	This port is used by configuration wizards that communicate by using native protocols with multiple hosts.
SMTP	25	Outbound	This port is used to send email alerts from the server.
NDMP	No default	Inbound/outbound	<p>The server must be able to open an outbound NDMP control port connection to the NAS device. The outbound control port is the Low-Level Address in the data mover definition for the NAS device.</p> <p>During an NDMP filer-to-server restore, the server must be able to open an outbound NDMP data connection to the NAS device. The data connection port that is used during a restore can be configured on the NAS device.</p> <p>During NDMP filer-to-server backups, the NAS device must be able to open outbound data connections to the server and the server must be able to accept inbound NDMP data connections. You can use the server option NDMPPORTRANGE to restrict the set of ports available for use as NDMP data connections. You can configure a firewall for connections to these ports.</p>
Replication	No default	Outbound/inbound	<p>The port and protocol for the outbound port for replication are set by the DEFINE SERVER command that is used to set up replication.</p> <p>The inbound ports for replication are the TCP ports and SSL ports that the source server names in the DEFINE SERVER command.</p>
Client schedule port	Client port: 1501	Outbound	The client listens on the port that is named and communicates the port number to the server. The server contacts the client if server prompted scheduling is used. You can specify an alternative port number in the client options file.
Long running sessions	KEEPALIVE setting: YES	Outbound	When the KEEPALIVE option is enabled, keepalive packets are sent during client-server sessions to prevent the firewall software from closing long-running, inactive connections.
Operations Center	HTTPS: 11090	Inbound	These ports are used for the Operations Center web browser. You can specify an alternative port number.
Client management service port	Client port: 9028	Inbound	The client management service port must be accessible from the Operations Center. Ensure that firewalls cannot prevent connections. The client management service uses the TCP port of the server for the client node for authentication by using an administrative session.

## Single-site disk implementation of a data protection solution

The single-site disk solution is configured at one site and uses data deduplication.

## Implementation roadmap

---

The following steps are required to set up the IBM Spectrum Protect™ single-site disk environment.

1. Set up the system.
  - a. Configure the storage hardware and set up storage arrays for your environment size.
  - b. Install the server operating system.
  - c. Configure multipath I/O.
  - d. Create the user ID for the server instance.
  - e. Prepare file systems for IBM Spectrum Protect.
2. Install the server and Operations Center.
3. Configure the server and Operations Center.
  - a. Complete the initial configuration of the server.
  - b. Set server options.
  - c. Configure Secure Sockets Layer for the server and client.
  - d. Configure the Operations Center.
  - e. Register your IBM Spectrum Protect license.
  - f. Configure data deduplication.
  - g. Define data retention rules for your business.
  - h. Define server maintenance schedules.
  - i. Define client schedules.
4. Install and configure clients.
  - a. Register and assign clients to schedules.
  - b. Install and verify the client management service.
  - c. Configure the Operations Center to use the client management service.
5. Complete the implementation.

## Setting up the system

---

To set up the system, you must first configure your disk storage hardware and the server system for IBM Spectrum Protect™.

- **Configuring the storage hardware**  
To configure your storage hardware, review general guidance for disk systems and IBM Spectrum Protect.
- **Installing the server operating system**  
Install the operating system on the server system and ensure that IBM Spectrum Protect server requirements are met. Adjust operating system settings as directed.
- **Configuring multipath I/O**  
You can enable and configure multipathing for disk storage. Use the documentation that is provided with your hardware for detailed instructions.
- **Creating the user ID for the server**  
Create the user ID that owns the IBM Spectrum Protect server instance. You specify this user ID when you create the server instance during initial configuration of the server.
- **Preparing file systems for the server**  
You must complete file system configuration for the disk storage to be used by the server.

## Configuring the storage hardware

---

To configure your storage hardware, review general guidance for disk systems and IBM Spectrum Protect™.

### Procedure

---

1. Provide a connection between the server and the storage devices by following these guidelines:
  - Use a switch or direct connection for Fibre Channel connections.
  - Consider the number of ports that are connected and account for the amount of bandwidth that is needed.
  - Consider the number of ports on the server and the number of host ports on the disk system that are connected.
2. Verify that device drivers and firmware for the server system, adapters, and operating system are current and at the recommended levels.
3. Configure storage arrays. Make sure that you planned properly to ensure optimal performance. See Planning for storage for more information.
4. Ensure that the server system has access to disk volumes that are created. Complete the following steps:



- a. If the system is connected to a Fibre Channel switch, zone the server to see the disks.
- b. Map all of the volumes to tell the disk system that this specific server is allowed to see each disk.

## Installing the server operating system

---

Install the operating system on the server system and ensure that IBM Spectrum Protect™ server requirements are met. Adjust operating system settings as directed.

- Installing on AIX systems  
Complete the following steps to install AIX® on the server system.
- Installing on Linux systems  
Complete the following steps to install Linux x86\_64 on the server system.
- Installing on Windows systems  
Install Microsoft Windows Server 2012 Standard Edition on the server system and prepare the system for installation and configuration of the IBM Spectrum Protect server.

## Installing on AIX systems

---

Complete the following steps to install AIX® on the server system.

### Procedure

---

1. Install AIX Version 7.1, TL4, SP2, or later according to the manufacturer instructions.
2. Configure your TCP/IP settings according to the operating system installation instructions.
3. Open the /etc/hosts file and complete the following actions:

- Update the file to include the IP address and host name for the server. For example:

```
192.0.2.7 server.yourdomain.com server
```

- Verify that the file contains an entry for localhost with an address of 127.0.0.1. For example:

```
127.0.0.1 localhost
```

4. Enable AIX I/O completion ports by issuing the following command:

```
chdev -l iocp0 -P
```

Server performance can be affected by the Olson time zone definition.

5. To optimize performance, change your system time zone format from Olson to POSIX. Use the following command format to update the time zone setting:

```
chtz=local_timezone,date/time,date/time
```

For example, if you lived in Tucson, Arizona, where Mountain Standard Time is used, you would issue the following command to change to the POSIX format:

```
chtz MST7MDT,M3.2.0/2:00:00,M11.1.0/2:00:00
```

6. Add an entry in the .profile of the instance user so that the following environment is set:

```
export MALLOCOPTIONS=multiheap:16
```

7. Set the system to create full application core files. Issue the following command:

```
chdev -l sys0 -a fullcore=true -P
```

8. For communications with the server and Operations Center, make sure that the following ports are open on any firewalls that might exist:

- For communications with the server, open port 1500.
- For secure communications with the Operations Center, open port 11090 on the hub server.

If you are not using the default port values, make sure that the ports that you are using are open.

9. Enable TCP high-performance enhancements. Issue the following command:

```
no -p -o rfc1323=1
```

10. For optimal throughput and reliability, bond four 10 Gb Ethernet ports together. Use the System Management Interface Tool (SMIT) to bond the ports together by using Etherchannel. The following settings were used during testing:

```

mode                8023ad
auto_recovery       yes           Enable automatic recovery after failover
backup_adapter      NONE         Adapter used when whole channel fails
hash_mode           src_dst_port Determines how outgoing adapter is chosen
interval            long         Determines interval value for IEEE
                        802.3ad mode
mode                8023ad       EtherChannel mode of operation
netaddr             0            Address to ping
no_loss_failover    yes         Enable lossless failover after ping
                        failure
num_retries         3            Times to retry ping before failing
retry_time          1            Wait time (in seconds) between pings
use_alt_addr        no           Enable Alternate EtherChannel Address
use_jumbo_frame     no           Enable Gigabit Ethernet Jumbo Frames

```

11. Verify that user process resource limits, also known as *ulimits*, are set according to guidelines in Table 1. If ulimit values are not set correctly, you might experience server instability or a failure of the server to respond.

Table 1. User limits (ulimit) values

User limit type	Setting	Value	Command to query value
Maximum size of core files created	core	Unlimited	ulimit -Hc
Maximum size of a data segment for a process	data	Unlimited	ulimit -Hd
Maximum file size	fsize	Unlimited	ulimit -Hf
Maximum number of open files	nofile	65536	ulimit -Hn
Maximum amount of processor time in seconds	cpu	Unlimited	ulimit -Ht
Maximum number of user processes	nproc	16384	ulimit -Hu

If you need to modify any user limit values, follow the instructions in the documentation for your operating system.

## Installing on Linux systems

Complete the following steps to install Linux x86\_64 on the server system.

### Before you begin

The operating system will be installed on the internal hard disks. Configure the internal hard disks by using a hardware RAID 1 array. For example, if you are configuring a small system, the two 300 GB internal disks are mirrored in RAID 1 so that a single 300 GB disk appears available to the operating system installer.

### Procedure

1. Install Red Hat Enterprise Linux Version 7.1 or later, according to the manufacturer instructions. Obtain a bootable DVD that contains Red Hat Enterprise Linux Version 7.1 and start your system from this DVD. See the following guidance for installation options. If an item is not mentioned in the following list, leave the default selection.
  - a. After you start the DVD, choose Install or upgrade an existing system from the menu.
  - b. On the Welcome screen, select Test this media & install Red Hat Enterprise Linux 7.1.
  - c. Select your language and keyboard preferences.
  - d. Select your location to set the correct time zone.
  - e. Select Software Selection and then on the next screen, select Server with GUI.
  - f. From the installation summary page, click Installation Destination and verify the following items:
    - The local 300 GB disk is selected as the installation target.
    - Under Other Storage Options, Automatically configure partitioning is selected.
 Click Done.
  - g. Click Begin Installation. After the installation starts, set the root password for your root user account.

After the installation is completed, restart the system and log in as the root user. Issue the `df` command to verify your basic partitioning. For example, on a test system, the initial partitioning produced the following result:

```
[root@tvapp02]# df -h
Filesystem      Size  Used Avail Use% Mounted on
/dev/mapper/rhel-root  50G  3.0G  48G   6% /
devtmpfs        32G   0    32G   0% /dev
tmpfs           32G  92K   32G   1% /dev/shm
tmpfs           32G  8.8M  32G   1% /run
tmpfs           32G   0    32G   0% /sys/fs/cgroup
/dev/mapper/rhel-home 220G  37M  220G   1% /home
/dev/sda1       497M 124M  373M  25% /boot
```

2. Configure your TCP/IP settings according to the operating system installation instructions.

For optimal throughput and reliability, consider bonding multiple network ports together. This can be accomplished by creating a Link Aggregation Control Protocol (LACP) network connection, which aggregates several subordinate ports into a single logical connection. The preferred method is to use a bond mode of `802.3ad`, `miimon` setting of `100`, and a `xmit_hash_policy` setting of `layer3+4`.

Restriction: To use an LACP network connection, you must have a network switch that supports LACP.

For additional instructions about configuring bonded network connections with Red Hat Enterprise Linux Version 7, see [Create a Channel Bonding Interface](#).

3. Open the `/etc/hosts` file and complete the following actions:

- o Update the file to include the IP address and host name for the server. For example:

```
192.0.2.7  server.yourdomain.com  server
```

- o Verify that the file contains an entry for localhost with an address of `127.0.0.1`. For example:

```
127.0.0.1  localhost
```

4. Install components that are required for the server installation. Complete the following steps to create a Yellowdog Updater Modified (YUM) repository and install the prerequisite packages.

- a. Mount your Red Hat Enterprise Linux installation DVD to a system directory. For example, to mount it to the `/mnt` directory, issue the following command:

```
mount -t iso9660 -o ro /dev/cdrom /mnt
```

- b. Verify that the DVD mounted by issuing the `mount` command. You should see output similar to the following example:

```
/dev/sr0 on /mnt type iso9660
```

- c. Change to the YUM repository directory by issuing the following command:

```
cd /etc/yum/repos.d
```

If the `repos.d` directory does not exist, create it.

- d. List directory contents:

```
ls rhel-source.repo
```

- e. Rename the original repo file by issuing the `mv` command. For example:

```
mv rhel-source.repo rhel-source.repo.orig
```

- f. Create a new repo file by using a text editor. For example, to use the `vi` editor, issue the following command:

```
vi rhel71_dvd.repo
```

- g. Add the following lines to the new repo file. The `baseurl` parameter specifies your directory mount point:

```
[rhel71_dvd]
name=DVD Redhat Enterprise Linux 7.1
baseurl=file:///mnt
enabled=1
gpgcheck=0
```

- h. Install the prerequisite package `ksh.x86_64`, by issuing the `yum` command. For example:

```
yum install ksh.x86_64
```

Exception: You do not need to install the compat-libstdc++-33-3.2.3-69.el6.i686 and libstdc++.i686 libraries for Red Hat Enterprise Linux Version 7.1.

5. When the software installation is complete, you can restore the original YUM repository values by completing the following steps:

a. Unmount the Red Hat Enterprise Linux installation DVD by issuing the following command:

```
umount /mnt
```

b. Change to the YUM repository directory by issuing the following command:

```
cd /etc/yum/repos.d
```

c. Rename the repo file that you created:

```
mv rhel71_dvd.repo rhel71_dvd.repo.orig
```

d. Rename the original file to the original name:

```
mv rhel-source.repo.orig rhel-source.repo
```

6. Determine whether kernel parameter changes are required. Complete the following steps:

a. Use the `sysctl -a` command to list the parameter values.

b. Analyze the results by using the guidelines in Table 1 to determine whether any changes are required.

c. If changes are required, set the parameters in the `/etc/sysctl.conf` file. The file changes are applied when the system is started.

Tip: Automatically adjust kernel parameter settings and eliminate the need for manual updates to these settings. On Linux, the DB2® database software automatically adjusts interprocess communication (IPC) kernel parameter values to the preferred settings. For more information about kernel parameter settings, search for Linux kernel parameters in the IBM DB2 Version 11.1 Knowledge Center.

Table 1. Linux kernel parameter optimum settings

Parameter	Description
kernel.shmni	The maximum number of segments.
kernel.shmmax	The maximum size of a shared memory segment (bytes). This parameter must be set before automatically starting the IBM Spectrum Protect™ server on system startup.
kernel.shmall	The maximum allocation of shared memory pages (pages).
kernel.sem	(SEMMSL) The maximum semaphores per array.
There are four values for the kernel.sem parameter.	(SEMNS) The maximum semaphores per system.
	(SEMOPM) The maximum operations per semaphore call.
	(SEMMNI) The maximum number of arrays.
kernel.msgmni	The maximum number of system-wide message queues.
kernel.msgmax	The maximum size of messages (bytes).
kernel.msgmnb	The default maximum size of queue (bytes).
kernel.randomize_va_space	The kernel.randomize_va_space parameter configures the use of memory ASLR for the kernel. Disable ASLR because it can cause errors for the DB2 software. To learn more details about the Linux ASLR and DB2, see technote 1365583.

Parameter	Description
vm.swappiness	The vm.swappiness parameter defines whether the kernel can swap application memory out of physical random access memory (RAM). For more information about kernel parameters, see the DB2 product information.
vm.overcommit_memory	The vm.overcommit_memory parameter influences how much virtual memory the kernel permits allocating. For more information about kernel parameters, see the DB2 product information.

7. Open firewall ports to communicate with the server. Complete the following steps:

a. Determine the zone that is used by the network interface. The zone is public, by default.

Issue the following command:

```
# firewall-cmd --get-active-zones
public
  interfaces: ens4f0
```

b. To use the default port address for communications with the server, open TCP/IP port 1500 in the Linux firewall.

Issue the following command:

```
firewall-cmd --zone=public --add-port=1500/tcp --permanent
```

If you want to use a value other than the default, you can specify a number in the range 1024 - 32767. If you open a port other than the default, you will need to specify that port when you run the configuration script.

c. If you plan to use this system as a hub, open port 11090, which is the default port for secure (https) communications.

Issue the following command:

```
firewall-cmd --zone=public --add-port=11090/tcp --permanent
```

d. Reload the firewall definitions for the changes to take effect.

Issue the following command:

```
firewall-cmd --reload
```

8. Verify that user process resource limits, also known as *ulimits*, are set according to guidelines in Table 2. If ulimit values are not set correctly, you might experience server instability or a failure of the server to respond.

Table 2. User limits (ulimit) values

User limit type	Setting	Value	Command to query value
Maximum size of core files created	core	Unlimited	ulimit -Hc
Maximum size of a data segment for a process	data	Unlimited	ulimit -Hd
Maximum file size	fsize	Unlimited	ulimit -Hf
Maximum number of open files	nofile	65536	ulimit -Hn
Maximum amount of processor time in seconds	cpu	Unlimited	ulimit -Ht
Maximum number of user processes	nproc	16384	ulimit -Hu

If you need to modify any user limit values, follow the instructions in the documentation for your operating system.

## Installing on Windows systems

Install Microsoft Windows Server 2012 Standard Edition on the server system and prepare the system for installation and configuration of the IBM Spectrum Protect™ server.

### Procedure

1. Install Microsoft Windows Server 2012 R2 Standard Edition, according to the manufacturer instructions.
2. Change the Windows account control policies by completing the following steps.
  - a. Open the Local Security Policy editor by running secpol.msc.
  - b. Click Local Policies > Security Options and ensure that the following User Account Control policies are disabled:
    - Admin Approval Mode for the Built-in Administrator account
    - Run all administrators in Admin Approval Mode
3. Configure your TCP/IP settings according to installation instructions for the operating system.
4. Apply Windows updates and enable optional features by completing the following steps:
  - a. Apply the latest Windows 2012 R2 updates.
  - b. Install and enable the Windows 2012 R2 feature Microsoft .NET Framework 3.5 from the Windows Server Manager.
  - c. If required, update the FC and Ethernet HBA device drivers to newer levels.
  - d. Install the multipath I/O driver that is appropriate for the disk system that you are using.
5. Open the default TCP/IP port, 1500, for communications with the IBM Spectrum Protect server. For example, issue the following command:

```
netsh advfirewall firewall add rule name="Backup server port 1500"
dir=in action=allow protocol=TCP localport=1500
```

6. On the Operations Center hub server, open the default port for secure (https) communications with the Operations Center. The port number is 11090. For example, issue the following command:

```
netsh advfirewall firewall add rule name="Operations Center port 11090"
dir=in action=allow protocol=TCP localport=11090
```

## Configuring multipath I/O

---

You can enable and configure multipathing for disk storage. Use the documentation that is provided with your hardware for detailed instructions.

- AIX systems
- Linux systems
- Windows systems

## AIX systems

---

### Procedure

---

1. Determine the Fibre Channel port address that you must use for the host definition on the disk subsystem. Issue the `lscfg` command for every port.
  - o On small and medium systems, issue the following commands:

```
lscfg -vps -l fcs0 | grep "Network Address"
lscfg -vps -l fcs1 | grep "Network Address"
```

- o On large systems, issue the following commands:

```
lscfg -vps -l fcs0 | grep "Network Address"
lscfg -vps -l fcs1 | grep "Network Address"
lscfg -vps -l fcs2 | grep "Network Address"
lscfg -vps -l fcs3 | grep "Network Address"
```

2. Ensure that the following AIX® file sets are installed:
  - o devices.common.IBM.mpio.rte
  - o devices.fcp.disk.array.rte
  - o devices.fcp.disk.rte
3. Issue the `cfgmgr` command to have AIX rescan the hardware and discover available disks. For example:

```
cfgmgr
```

4. To list the available disks, issue the following command:

```
lsdev -Ccdisk
```

You should see output similar to the following:

```

hdisk0 Available 00-00-00 SAS Disk Drive
hdisk1 Available 00-00-00 SAS Disk Drive
hdisk2 Available 01-00-00 SAS Disk Drive
hdisk3 Available 01-00-00 SAS Disk Drive
hdisk4 Available 06-01-02 MPIO IBM 2076 FC Disk
hdisk5 Available 07-01-02 MPIO IBM 2076 FC Disk
...

```

5. Use the output from the `lsdev` command to identify and list device IDs for each disk device.

For example, a device ID could be `hdisk4`. Save the list of device IDs to use when you create file systems for the IBM Spectrum Protect™ server.

6. Correlate the SCSI device IDs to specific disk LUNs from the disk system by listing detailed information about all physical volumes in the system. Issue the following command:

```
lspv -u
```

On an IBM® Storwize® system, the following information is an example of what is shown for each device:

```

hdisk4 00f8cf083fd97327 None active
33213600507630081010578000000000003004214503IBMfcp

```

In the example, `6005076300810105780000000000030` is the UID for the volume, as reported by the Storwize management interface.

To verify disk size in megabytes and compare the value with what is listed for the system, issue the following command:

```
bootinfo -s hdisk4
```

## Linux systems

---

### Procedure

---

1. Edit the `/etc/multipath.conf` file to enable multipathing for Linux hosts. If the `multipath.conf` file does not exist, you can create it by issuing the following command:

```
mpathconf --enable
```

The following parameters were set in `multipath.conf` for testing on an IBM Storwize® system:

```

defaults {
    user_friendly_names no
}

devices {
    device {
        vendor "IBM "
        product "2145"
        path_grouping_policy group_by_prio
        user_friendly_names no
        path_selector "round-robin 0"
        prio "alua"
        path_checker "tur"
        failback "immediate"
        no_path_retry 5
        rr_weight uniform
        rr_min_io_rq "1"
        dev_loss_tmo 120
    }
}

```

2. Set the multipath option to start when the system is started. Issue the following commands:

```

systemctl enable multipathd.service
systemctl start multipathd.service

```

3. To verify that disks are visible to the operating system and are managed by multipath, issue the following command:

```
multipath -l
```

4. Ensure that each device is listed and that it has as many paths as you expect. You can use size and device ID information to identify which disks are listed.

For example, the following output shows that a 2 TB disk has two path groups and four active paths. The 2 TB size confirms that the disk corresponds to a pool file system. Use part of the long device ID number (12, in this example) to search for the volume on the disk-system management interface.

```
[root@tapsrv01 code]# multipath -l
36005076802810c509800000000000012 dm-43 IBM,2145
 size=2.0T features='1 queue_if_no_path' hwhandler='0' wp=rw
|+- policy='round-robin 0' prio=0 status=active
| |- 2:0:1:18 sdcw 70:64 active undef running
| `-- 4:0:0:18 sdgb 131:112 active undef running
`+- policy='round-robin 0' prio=0 status=enabled
  |- 1:0:1:18 sdat 66:208 active undef running
  `-- 3:0:0:18 sddy 128:0 active undef running
```

- a. If needed, correct disk LUN host assignments and force a bus rescan. For example:

```
echo "- - -" > /sys/class/scsi_host/host0/scan
echo "- - -" > /sys/class/scsi_host/host1/scan
echo "- - -" > /sys/class/scsi_host/host2/scan
```

You can also restart the system to rescan disk LUN host assignments.

- b. Confirm that disks are now available for multipath I/O by reissuing the multipath -l command.

5. Use the multipath output to identify and list device IDs for each disk device.

For example, the device ID for your 2 TB disk is 36005076802810c509800000000000012.

Save the list of device IDs to use in the next step.

## Windows systems

### Procedure

1. Ensure that the Multipath I/O feature is installed. If needed, install additional vendor-specific multipath drivers.
2. To verify that disks are visible to the operating system and are managed by multipath I/O, issue the following command:

```
c:\program files\IBM\SDDDSM\datapath.exe query device
```

3. Review the multipath output and ensure that each device is listed and that it has as many paths as you expect. You can use size and device serial information to identify which disks are listed.

For example, by using part of the long device serial number (34, in this example) you can search for the volume on the disk-system management interface. The 2 TB size confirms that the disk corresponds to a storage pool file system.

```
DEV#: 4 DEVICE NAME: Disk5 Part0 TYPE: 2145 POLICY: OPTIMIZED
SERIAL: 60050763008101057800000000000034 LUN SIZE: 2.0TB
=====
Path# Adapter/Hard Disk State Mode Select Errors
0 Scsi Port2 Bus0/Disk5 Part0 OPEN NORMAL 0 0
1 Scsi Port2 Bus0/Disk5 Part0 OPEN NORMAL 27176 0
2 Scsi Port3 Bus0/Disk5 Part0 OPEN NORMAL 28494 0
3 Scsi Port3 Bus0/Disk5 Part0 OPEN NORMAL 0 0
```

4. Create a list of disk device IDs by using the serial numbers that are returned from the multipath output in the previous step.

For example, the device ID for your 2 TB disk is 60050763008101057800000000000034

Save the list of device IDs to use in the next step.

5. To bring new disks online and clear the read-only attribute, run diskpart.exe with the following commands. Repeat for each of the disks:

```
diskpart
select Disk 1
online disk
attribute disk clear readonly
select Disk 2
online disk
attribute disk clear readonly
```



```
< ... >
select Disk 49
online disk
attribute disk clear readonly
exit
```

## Creating the user ID for the server

---

Create the user ID that owns the IBM Spectrum Protect™ server instance. You specify this user ID when you create the server instance during initial configuration of the server.

### About this task

---

You can specify only lowercase letters (a-z), numerals (0-9), and the underscore character ( \_ ) for the user ID. The user ID and group name must comply with the following rules:

- The length must be 8 characters or fewer.
- The user ID and group name cannot start with *ibm*, *sql*, *sys*, or a numeral.
- The user ID and group name cannot be *user*, *admin*, *guest*, *public*, *local*, or any SQL reserved word.

### Procedure

---

1. Use operating system commands to create a user ID.

- o **AIX** | **Linux** Create a group and user ID in the home directory of the user that owns the server instance.

For example, to create the user ID `tsminst1` in group `tsmsrvrs` with a password of `tsminst1`, issue the following commands from an administrative user ID:

**AIX**

```
mkgroup id=1001 tsmsrvrs
mkuser id=1002 pgrp=tsmsrvrs home=/home/tsminst1 tsminst1
passwd tsminst1
```

**Linux**

```
groupadd tsmsrvrs
useradd -d /home/tsminst1 -m -g tsmsrvrs -s /bin/bash tsminst1
passwd tsminst1
```

Log off, and then log in to your system. Change to the user account that you created. Use an interactive login program, such as `telnet`, so that you are prompted for the password and can change it if necessary.

- o **Windows** Create a user ID and then add the new ID to the Administrators group. For example, to create the user ID `tsminst1`, issue the following command:

```
net user tsminst1 * /add
```

After you create and verify a password for the new user, add the user ID to the Administrators group by issuing the following commands:

```
net localgroup Administrators tsminst1 /add
net localgroup DB2ADMNS tsminst1 /add
```

2. Log off the new user ID.

## Preparing file systems for the server

---

You must complete file system configuration for the disk storage to be used by the server.

- Preparing file systems on AIX systems  
You must create volume groups, logical volumes, and file systems for the server by using the AIX® Logical Volume Manager.
- Preparing file systems on Linux systems  
You must format `ext4` or `xfs` file systems on each of the disk LUNs to be used by the IBM Spectrum Protect server.
- Preparing file systems on Windows systems  
You must format New Technology File System (NTFS) file systems on each of the disk LUNs to be used by the IBM

## Preparing file systems on AIX systems

You must create volume groups, logical volumes, and file systems for the server by using the AIX® Logical Volume Manager.

### Procedure

1. Increase the queue depth and maximum transfer size for all of the available *hdiskX* disks. Issue the following commands for each disk:

```
chdev -l hdisk4 -a max_transfer=0x100000
chdev -l hdisk4 -a queue_depth=32
chdev -l hdisk4 -a reserve_policy=no_reserve
chdev -l hdisk4 -a algorithm=round_robin
```

Do not run these commands for operating system internal disks, for example, *hdisk0*.

2. Create volume groups for the IBM Spectrum Protect™ database, active log, archive log, database backup, and storage pool. Issue the `mkvg` command, specifying the device IDs for corresponding disks that you previously identified. For example, if the device names *hdisk4*, *hdisk5*, and *hdisk6* correspond to database disks, include them in the database volume group and so on. System size: The following commands are based on the medium system configuration. For small and large systems, you must adjust the syntax as required.

```
mkvg -S -y tsmdb hdisk2 hdisk3 hdisk4
mkvg -S -y tsmactlog hdisk5
mkvg -S -y tsmarchlog hdisk6
mkvg -S -y tsmdbback hdisk7 hdisk8 hdisk9 hdisk10
mkvg -S -y tsmstgpool hdisk11 hdisk12 hdisk13 hdisk14 ... hdisk49
```

3. Determine the physical volume names and the number of free physical partitions to use when you create logical volumes. Issue the `lsvg` for each volume group that you created in the previous step. For example:

```
lsvg -p tsmdb
```

The output is similar to the following. The *FREE PPs* column represents the free physical partitions:

```
tsmdb:
PV_NAME  PV STATE  TOTAL PPs  FREE PPs  FREE DISTRIBUTION
hdisk4   active    1631       1631      327..326..326..326..326
hdisk5   active    1631       1631      327..326..326..326..326
hdisk6   active    1631       1631      327..326..326..326..326
```

4. Create logical volumes in each volume group by using the `mklv` command. The volume size, volume group, and device names vary, depending on the size of your system and variations in your disk configuration. For example, to create the volumes for the IBM Spectrum Protect database on a medium system, issue the following commands:

```
mklv -y tsmdb00 -t jfs2 -u 1 -x 1631 tsmdb 1631 hdisk2
mklv -y tsmdb01 -t jfs2 -u 1 -x 1631 tsmdb 1631 hdisk3
mklv -y tsmdb02 -t jfs2 -u 1 -x 1631 tsmdb 1631 hdisk4
```

5. Format file systems in each logical volume by using the `crfs` command. For example, to format file systems for the database on a medium system, issue the following commands:

```
crfs -v jfs2 -d tsmdb00 -p rw -a logname=INLINE -a options=rbrw
-a agblksize=4096 -m /tsminst1/TSMdbspace00 -A yes
crfs -v jfs2 -d tsmdb01 -p rw -a logname=INLINE -a options=rbrw
-a agblksize=4096 -m /tsminst1/TSMdbspace01 -A yes
crfs -v jfs2 -d tsmdb02 -p rw -a logname=INLINE -a options=rbrw
-a agblksize=4096 -m /tsminst1/TSMdbspace02 -A yes
```

6. Mount all of the newly created file systems by issuing the following command:

```
mount -a
```

7. List all file systems by issuing the `df` command. Verify that file systems are mounted at the correct LUN and correct mount point. Also, verify the available space.

The following example of command output shows that the amount of used space is typically 1%:

```
tapsrv07> df -g /tsminst1/*
Filesystem      GB blocks   Free    %Used   Iused   %Iused   Mounted on
/dev/tsmact00   195.12     194.59    1%       4        1%       /tsminst1/TSMalog
```

8. Verify that the user ID you created in Creating the user ID for the server has read and write access to the directories for the server.

## Preparing file systems on Linux systems

---

You must format ext4 or xfs file systems on each of the disk LUNs to be used by the IBM Spectrum Protect™ server.

### Procedure

---

1. Using the list of device IDs that you generated previously, issue the mkfs command to create and format a file system for each storage LUN device. Specify the device ID in the command. See the following examples. For the database, format ext4 file systems:

```
mkfs -t ext4 -T largefile -m 2 /dev/mapper/36005076802810c50980000000000012
```

For storage pool LUNs, format xfs file systems:

```
mkfs -t xfs /dev/mapper/3600507630081010578000000000002c3
```

You might issue the mkfs command as many as 50 times, depending on how many different devices you have.

2. Create mount point directories for file systems.

Issue the mkdir command for each directory that you must create. Use the directory values that you recorded in the planning worksheets.

For example, to create the server instance directory by using the default value, issue the following command:

```
mkdir /tsminst1
```

Repeat the mkdir command for each file system.

3. Add an entry in the /etc/fstab file for each file system so that file systems are mounted automatically when the server is started.

For example:

```
/dev/mapper/36005076802810c50980000000000012 /tsminst1/TSMdbspace00 ext4 defaults 0 0
```

4. Mount the file systems that you added to the /etc/fstab file by issuing the mount -a command.
5. List all file systems by issuing the df command. Verify that file systems are mounted at the correct LUN and correct mount point. Also, verify the available space.

The following example on an IBM® Storwize® system shows that the amount of used space is typically 1%:

```
[root@tapsrv04 ~]# df -h /tsminst1/*
Filesystem      Size  Used Avail Use% Mounted on
/dev/mapper/36005076300810105780000000000003 134G  188M 132G   1%  /tsminst1/TSMalog
```

6. Verify that the user ID you created in Creating the user ID for the server has read and write access to the directories for the IBM Spectrum Protect server.

## Preparing file systems on Windows systems

---

You must format New Technology File System (NTFS) file systems on each of the disk LUNs to be used by the IBM Spectrum Protect™ server.

### Procedure

---

1. Create mount point directories for file systems.

Issue the md command for each directory that you must create. Use the directory values that you recorded in the planning worksheets. For example, to create the server instance directory by using the default value, issue the following command:

```
md c:\tsminst1
```

Repeat the md command for each file system.

2. Create a volume for every disk LUN that is mapped to a directory under the server instance directory by using the Windows volume manager.

Go to Server Manager > File and Storage Services and complete the following steps for each disk that corresponds to the LUN mapping that was created in the previous step:

- a. Bring the disk online.
- b. Initialize the disk to the GPT basic type, which is the default.
- c. Create a simple volume that occupies all of the space on the disk. Format the file system by using NTFS, and assign a label that matches the purpose of the volume, such as TSMfile00. Do not assign the new volume to a drive letter. Instead, map the volume to a directory under the instance directory, such as C:\tsminst1\TSMfile00.

Tip: Determine the volume label and directory mapping labels based on the size of the disk that is reported.

3. Verify that file systems are mounted at the correct LUN and correct mount point. List all file systems by issuing the mountvol command and then review the output. For example:

```
\\?\Volume{8ffb9678-3216-474c-a021-20e420816a92}\  
C:\tsminst1\TSMdbspace00\
```

4. After the disk configuration is complete, restart the system.

## What to do next

---

You can confirm the amount of free space for each volume by using Windows Explorer.

## Installing the server and Operations Center

---

Use the IBM® Installation Manager graphical wizard to install the components.

- Installing on AIX and Linux systems  
Install the IBM Spectrum Protect™ server and the Operations Center on the same system.
- Installing on Windows systems  
Install the IBM Spectrum Protect server and the Operations Center on the same system.

## Installing on AIX® and Linux systems

---

Install the IBM Spectrum Protect™ server and the Operations Center on the same system.

### Before you begin

---

Verify that the operating system is set to the language that you require. By default, the language of the operating system is the language of the installation wizard.

### Procedure

---

1. **AIX** Verify that the required RPM files are installed on your system.

See Installing prerequisite RPM files for the graphical wizard for details.

2. Before you download the installation package, verify that you have enough space to store the installation files when they are extracted from the product package. For space requirements, see the download document at technote 4042992.
3. Go to Passport Advantage® and download the package file to an empty directory of your choice.
4. Ensure that executable permission is set for the package. If necessary, change the file permissions by issuing the following command:

```
chmod a+x package_name.bin
```

5. Extract the package by issuing the following command:

```
./package_name.bin
```

where *package\_name* is the name of the downloaded file.

6. **AIX** Ensure that the following command is enabled so that the wizards work properly:

```
lsuser
```

By default, the command is enabled.

7. Change to the directory where you placed the executable file.
8. Start the installation wizard by issuing the following command:

```
./install.sh
```

When you select the packages to install, choose both the server and Operations Center.

## What to do next

---

- If errors occur during the installation process, the errors are recorded in log files that are stored in the IBM Installation Manager logs directory.

To view installation log files from the Installation Manager tool, click File > View Log. To collect these log files from the Installation Manager tool, click Help > Export Data for Problem Analysis.

- After you install the server and before you customize it for your use, go to the IBM Spectrum Protect support site. Click Support and downloads and apply any applicable fixes.
- Installing prerequisite RPM files for the graphical wizard  
RPM files are required for the IBM Installation Manager graphical wizard.

### Related tasks:

- [Other methods for installing IBM Spectrum Protect components \(AIX\)](#)
- [Other methods for installing IBM Spectrum Protect components \(Linux\)](#)

## Installing on Windows systems

---

Install the IBM Spectrum Protect™ server and the Operations Center on the same system.

### Before you begin

---

Make sure that the following prerequisites are met:

- Verify that the operating system is set to the language that you require. By default, the language of the operating system is the language of the installation wizard.
- Ensure that the user ID that you plan to use during the installation is a user with local Administrator authority.

### Procedure

---

1. Before you download the installation package, verify that you have enough space to store the installation files when they are extracted from the product package. For space requirements, see the download document at technote 4042993.
2. Go to Passport Advantage® and download the package file to an empty directory of your choice.
3. Change to the directory where you placed the executable file.
4. Double-click the executable file to extract to the current directory.
5. In the directory where the installation files were extracted, start the installation wizard by double-clicking the install.bat file. When you select the packages to install, choose both the server and Operations Center.

## What to do next

---

- If errors occur during the installation process, the errors are recorded in log files that are stored in the IBM® Installation Manager logs directory.

To view installation log files from the Installation Manager tool, click File > View Log. To collect these log files from the Installation Manager tool, click Help > Export Data for Problem Analysis.

- After you install the server and before you customize it for your use, go to the IBM Spectrum Protect support site. Click Support and downloads and apply any applicable fixes.

### Related tasks:

## Configuring the server and the Operations Center

---

After you install the components, complete the configuration for the IBM Spectrum Protect™ server and the Operations Center.

- **Configuring the server instance**  
Use the IBM Spectrum Protect server instance configuration wizard to complete the initial configuration of the server.
- **Installing the backup-archive client**  
As a best practice, install the IBM Spectrum Protect backup-archive client on the server system so that the administrative command-line client and scheduler are available.
- **Setting options for the server**  
Review the server options file that is installed with the IBM Spectrum Protect server to verify that the correct values are set for your system.
- **Configuring secure communications with Transport Layer Security**  
To encrypt data and secure communications in your environment, Secure Sockets Layer (SSL) or Transport Layer Security (TLS) is enabled on the IBM Spectrum Protect server and backup-archive client. An SSL certificate is used to verify communication requests between the server and client.
- **Configuring the Operations Center**  
After you install the Operations Center, complete the following configuration steps to start managing your storage environment.
- **Registering the product license**  
To register your license for the IBM Spectrum Protect product, use the REGISTER LICENSE command.
- **Configuring data deduplication**  
Create a directory-container storage pool and at least one directory to use inline data deduplication.
- **Defining data retention rules for your business**  
After you create a directory-container storage pool for data deduplication, update the default server policy to use the new storage pool. The Add Storage Pool wizard opens the Services page in the Operations Center to complete this task.
- **Defining schedules for server maintenance activities**  
Create schedules for each server maintenance operation by using the DEFINE SCHEDULE command in the Operations Center command builder.
- **Defining client schedules**  
Use the Operations Center to create schedules for client operations.

## Configuring the server instance

---

Use the IBM Spectrum Protect™ server instance configuration wizard to complete the initial configuration of the server.

### Before you begin

---

Ensure that the following requirements are met:

**AIX** | **Linux**

- The system where you installed IBM Spectrum Protect must have the X Window System client. You must also be running an X Window System server on your desktop.
- The system must have the Secure Shell (SSH) protocol enabled. Ensure that the port is set to the default value, 22, and that the port is not blocked by a firewall. You must enable password authentication in the `sshd_config` file in the `/etc/ssh/directory`. Also, ensure that the SSH daemon service has access rights to connect to the system by using the `localhost` value.
- You must be able to log in to IBM Spectrum Protect with the user ID that you created for the server instance, by using the SSH protocol. When you use the wizard, you must provide this user ID and password to access that system.
- If you changed any settings in the preceding steps, restart the server before you proceed with the configuration wizard.

**Windows**

Verify that the remote registry service is started by completing the following steps:

1. Click Start > Administrative Tools > Services. In the Services window, select Remote Registry. If it is not started, click Start.
2. Ensure that port 137, 139, and 445 are not blocked by a firewall:
  - a. Click Start > Control Panel > Windows Firewall.
  - b. Select Advanced Settings.
  - c. Select Inbound Rules.
  - d. Select New Rule.

- e. Create a port rule for TCP ports 137, 139, and 445 to allow connections for domain and private networks.
3. Configure the user account control by accessing the local security policy options and completing the following steps.
  - a. Click Start > Administrative Tools > Local Security Policy. Expand Local Policies > Security Options.
  - b. If not already enabled, enable the built-in administrator account by selecting Accounts: Administrator account status > Enable > OK.
  - c. If not already disabled, disable user account control for all Windows administrators by selecting User Account Control: Run all administrators in Admin Approval Mode > Disable > OK.
  - d. If not already disabled, disable the User Account Control for the built-in Administrator account by selecting User Account Control: Admin Approval Mode for the Built-in Administrator Account > Disable > OK.
4. If you changed any settings in the preceding steps, restart the server before you proceed with the configuration wizard.

## About this task

The wizard can be stopped and restarted, but the server is not operational until the entire configuration process is complete.

## Procedure

1. Start the local version of the wizard.
  - o **AIX** | **Linux** Open the dsmsicgx program in the /opt/tivoli/tsm/server/bin directory. This wizard can be only run as a root user.
  - o **Windows** Click Start > All Programs > IBM Spectrum Protect > Configuration Wizard.
2. Follow the instructions to complete the configuration. Use the information that you recorded in Planning worksheets during IBM Spectrum Protect system set up to specify directories and options in the wizard.

**AIX** | **Linux** On the Server Information window, set the server to start automatically by using the instance user ID when the system boots.

**Windows** By using the configuration wizard, the server is set to start automatically when rebooted.

## Installing the backup-archive client

As a best practice, install the IBM Spectrum Protect™ backup-archive client on the server system so that the administrative command-line client and scheduler are available.

## Procedure

To install the backup-archive client, follow the installation instructions for your operating system.

- Installing the UNIX and Linux backup-archive clients
- Installing the Windows backup-archive client

## Setting options for the server

Review the server options file that is installed with the IBM Spectrum Protect™ server to verify that the correct values are set for your system.

## Procedure

1. Go to the server instance directory and open the dsmserv.opt file.
2. Review the values in the following table and verify your server option settings, based on system size.

Server option	Small system value	Medium system value	Large system value
ACTIVELOGDIRECTORY	Directory path that was specified during configuration	Directory path that was specified during configuration	Directory path that was specified during configuration
ACTIVELOGSIZE	131072	131072	262144
ARCHLOGCOMPRESS	Yes	No	No

Server option	Small system value	Medium system value	Large system value
ARCHLOGDIRECTORY	Directory path that was specified during configuration	Directory path that was specified during configuration	Directory path that was specified during configuration
COMMMETHOD	TCP/IP	TCP/IP	TCP/IP
COMMTIMEOUT	3600	3600	3600
DEDUPREQUIRESBACKUP	No	No	No
DEVCONFIG	devconf.dat	devconf.dat	devconf.dat
EXPINTERVAL	0	0	0
IDLETIMEOUT	60	60	60
MAXSESSIONS	250	500	1000
NUMOPENVOLSALLOWED	20	20	20
TCPADMINPORT	1500	1500	1500
TCPPORT	1500	1500	1500
VOLUMEHISTORY	volhist.dat	volhist.dat	volhist.dat

Update server option settings if necessary, to match the values in the table. To make updates, close the dsmserv.opt file and use the SETOPT command from the administrative command-line interface to set the options.

For example, to update the IDLETIMEOUT option to 60, issue the following command:

```
setopt idletimeout 60
```

- To configure secure communications for the server, clients, and the Operations Center, verify the options in the following table.

Server option	All system sizes
SSLFIPSMODE	NO
TCPPORT	Specify the port number on which the server waits for requests for TCP/IP and SSL-enabled sessions from the client.
TCPADMINPORT	Specify the port address on which the server waits for requests for TCP/IP and SSL-enabled sessions from the command-line administrative client.

If any of the option values must be updated, edit the dsmserv.opt file by using the following guidelines:

- Remove the asterisk at the beginning of a line to enable an option.
- On each line, enter only one option and the specified value for the option.
- If an option occurs in multiple entries in the file, the server uses the last entry.

Save your changes and close the file. If you edit the dsmserv.opt file directly, you must restart the server for the changes to take effect.

**Related reference:**

[Server options reference](#)

[SETOPT \(Set a server option for dynamic update\)](#)

## Configuring secure communications with Transport Layer Security

To encrypt data and secure communications in your environment, Secure Sockets Layer (SSL) or Transport Layer Security (TLS) is enabled on the IBM Spectrum Protect™ server and backup-archive client. An SSL certificate is used to verify communication requests between the server and client.

### About this task

As shown in the following figure, you can manually configure secure communications between the server and backup-archive client by setting options in the server and client options files, and then transferring the self-signed certificate that is generated on the server to the client. Alternatively, you can obtain and transfer a unique certificate that is signed by a certificate authority (CA).





For more information about configuring the server and clients for SSL or TLS communications, see [Configuring storage agents, servers, clients, and the Operations Center to connect to the server by using SSL](#).

## Configuring the Operations Center

After you install the Operations Center, complete the following configuration steps to start managing your storage environment.

### Before you begin

When you connect to the Operations Center for the first time, you must provide the following information:

- Connection information for the server that you want to designate as a hub server
- Login credentials for an administrator ID that is defined for that server

### Procedure

1. Designate the hub server. In a web browser, enter the following address:

```
https://hostname:secure_port/oc
```

where:

- *hostname* represents the name of the computer where the Operations Center is installed
- *secure\_port* represents the port number that the Operations Center uses for HTTPS communication on that computer

For example, if your host name is `tsm.storage.mylocation.com` and you are using the default secure port for the Operations Center, which is 11090, the address is:

```
https://tsm.storage.mylocation.com:11090/oc
```

When you log in to the Operations Center for the first time, a wizard guides you through an initial configuration to set up a new administrator with system authority on the server.

2. Set up secure communications between the Operations Center and the hub server by configuring the Secure Sockets Layer (SSL) protocol.

Follow the instructions in [Securing communications between the Operations Center and the hub server](#).

3. Optional: To receive a daily email report that summarizes system status, configure your email settings in the Operations Center.

Follow the instructions in [Tracking system status by using email reports](#).

- Securing communications between the Operations Center and the hub server  
To secure communications between the Operations Center and the hub server, add the Transport Layer Security (TLS) certificate of the hub server to the truststore file of the Operations Center.

## Registering the product license

To register your license for the IBM Spectrum Protect™ product, use the `REGISTER LICENSE` command.

### About this task

Licenses are stored in enrollment certificate files, which contain licensing information for the product. The enrollment certificate files are on the installation media, and are placed on the server during installation. When you register the product, the licenses are stored in a NODELOCK file within the current directory.

## Procedure

---

Register a license by specifying the name of the enrollment certificate file that contains the license. To use the Operations Center command builder for this task, complete the following steps.

1. Open the Operations Center.
2. Open the Operations Center command builder by hovering over the settings icon  and clicking Command Builder.
3. Issue the REGISTER LICENSE command. For example, to register a base IBM Spectrum Protect license, issue the following command:

```
register license file=tsmbasic.lic
```

## What to do next

---

Save the installation media that contains your enrollment certificate files. You might need to register your license again if, for example, one of the following conditions occur:

- The server is moved to a different computer.
- The NODELOCK file is corrupted. The server stores license information in the NODELOCK file, which is in the directory from which the server is started.
-  If you change the processor chip that is associated with the server on which the server is installed.

### Related reference:

 REGISTER LICENSE (Register a new license)

## Configuring data deduplication

---

Create a directory-container storage pool and at least one directory to use inline data deduplication.

## Before you begin

---

Use the storage pool directory information that you recorded in Planning worksheets for this task.

## Procedure

---

1. Open the Operations Center.
2. On the Operations Center menu bar, hover over Storage.
3. From the list that is displayed, click Storage Pools.
4. Click the +Storage Pool button.
5. Complete the steps in the Add Storage Pool wizard:
  - To use inline data deduplication, select a Directory storage pool under Container-based storage.
  - When you configure directories for the directory-container storage pool, specify the directory paths that you created for storage during system setup.
6. After you configure the new directory-container storage pool, click Close & View Policies to update a management class and start using the storage pool.

## Defining data retention rules for your business

---

After you create a directory-container storage pool for data deduplication, update the default server policy to use the new storage pool. The Add Storage Pool wizard opens the Services page in the Operations Center to complete this task.

## Procedure

---

1. On the Services page of the Operations Center, select the STANDARD domain and click Details.
2. On the Summary page for the policy domain, click the Policy Sets tab. The Policy Sets page indicates the name of the active policy set and lists all of the management classes for that policy set.
3. Click the Configure toggle, and make the following changes:

- Change the backup destination for the STANDARD management class to the directory-container storage pool.
  - Change the value for the Backups column to No limit.
  - Change the retention period. Set the Keep Extra Backups column to 30 days or more, depending on your business requirements.
4. Save your changes and click the Configure toggle again so that the policy set is no longer editable.
  5. Activate the policy set by clicking Activate.

**Related tasks:**

Specifying rules for backing up and archiving client data

## Defining schedules for server maintenance activities

Create schedules for each server maintenance operation by using the DEFINE SCHEDULE command in the Operations Center command builder.

### About this task

Schedule server maintenance operations to run after client backup operations. You can control the timing of schedules by setting the start time in combination with the duration time for each operation.

The following example shows how you can schedule server maintenance operations in combination with the client backup schedule for a single-site disk solution.

Operation	Schedule
Client backup	Starts at 22:00.
Processing for database and disaster recovery files	<ul style="list-style-type: none"> <li>• The database backup operation starts at 11:00, or 13 hours after the beginning of the client backup operation. This process runs until completion.</li> <li>• Device configuration information and volume history backup operations start at 17:00, or 6 hours after the start of the database backup operation.</li> <li>• Volume history deletion starts at 20:00, or 9 hours after the start of the database backup operation.</li> </ul>
Inventory expiration	Starts at 12:00, or 14 hours after the beginning of the client backup operation. This process runs until completion.

### Procedure

After you configure the device class for the database backup operations, create schedules for database backup and other required maintenance operations by using the DEFINE SCHEDULE command. Depending on the size of your environment, you might need to adjust the start times for each schedule in the example.

1. Define a device class for the backup operations. For example, use the DEFINE DEVCLASS command to create a device class that is named DBBACK\_FILEDEV:

```
define devclass dbback_filedev devtype=file
  directory=db_backup_directories
```

where *db\_backup\_directories* is a list of the directories that you created for the database backup.

**AIX Linux** For example, if you have four directories for database backups, starting with /tsminst1/TSMbkup00, issue the following command:

```
define devclass dbback_filedev devtype=file
  directory=/tsminst1/TSMbkup00,
  /tsminst1/TSMbkup01,/tsminst1/TSMbkup02,
  /tsminst1/TSMbkup03"
```

**Windows** For example, if you have four directories for database backups, starting with C:\tsminst1\TSMbkup00, issue the following command:

```
define devclass dbback_filedev devtype=file
  directory="c:\tsminst1\TSMbkup00,
  c:\tsminst1\TSMbkup01,c:\tsminst1\TSMbkup02,
  c:\tsminst1\TSMbkup03"
```

- Set the device class for automatic database backup operations. Use the SET DBRECOVERY command to specify the device class that you created in the preceding step. For example, if the device class is dbback\_filedev, issue the following command:

```
set dbrecovery dbback_filedev
```

- Create schedules for the maintenance operations by using the DEFINE SCHEDULE command. See the following table for the required operations with examples of the commands.

Operation	Example command
Back up the database.	<p>Create a schedule to run the BACKUP DB command. If you are configuring a small system, set the COMPRESS parameter to YES. For example, on a small system, issue the following command to create a backup schedule that uses the new device class:</p> <pre>define schedule DBBACKUP type=admin cmd="backup db   devclass=dbback_filedev type=full numstreams=3   wait=yes   compress=yes" active=yes desc="Back up the   database."   startdate=today starttime=11:00:00 duration=45   durunits=minutes</pre>
Back up the device configuration information.	<p>Create a schedule to run the BACKUP DEVCONFIG command:</p> <pre>define schedule DEVCONFIGBKUP type=admin cmd="backup   devconfig   filenames=devconfig.dat" active=yes desc="Backup the   device   configuration file." startdate=today   starttime=17:00:00   duration=45 durunits=minutes</pre>
Back up the volume history.	<p>Create a schedule to run the BACKUP VOLHISTORY command:</p> <pre>define schedule VOLHISTBKUP type=admin cmd="backup   volhistory   filenames=volhist.dat" active=yes desc="Back up the   volume   history." startdate=today starttime=17:00:00   duration=45   durunits=minutes</pre>
Remove older versions of database backups that are no longer required.	<p>Create a schedule to run the DELETE VOLHISTORY command:</p> <pre>define schedule DELVOLHIST type=admin cmd="delete   volhistory   type=dbb todate=today-6 totime=now" active=yes   desc="Remove   old database backups." startdate=today   starttime=20:00:00   duration=45 durunits=minutes</pre>
Remove objects that exceed their allowed retention.	<p>Create a schedule to run the EXPIRE INVENTORY command. Set the RESOURCE parameter based on the system size that you are configuring:</p> <ul style="list-style-type: none"> <li>o Small systems: 10</li> <li>o Medium systems: 30</li> <li>o Large systems: 40</li> </ul> <p>For example, on a medium-sized system, issue the following command to create a schedule that is named EXPINVENTORY:</p> <pre>define schedule EXPINVENTORY type=admin cmd="expire   inventory   wait=yes resource=30 duration=120" active=yes   desc="Remove expired   objects." startdate=today starttime=12:00:00   duration=45   durunits=minutes</pre>

## What to do next

After you create schedules for the server maintenance tasks, you can view them in the Operations Center by completing the following steps:

1. On the Operations Center menu bar, hover over Servers.
2. Click Maintenance.

**Related reference:**

[DEFINE SCHEDULE](#) (Define a schedule for an administrative command)

## Defining client schedules

---

Use the Operations Center to create schedules for client operations.

### Procedure

---

1. On the Operations Center menu bar, hover over Clients.
2. Click Schedules.
3. Click +Schedule.
4. Complete the steps in the Create Schedule wizard. Set client backup schedules to start at 22:00, based on the server maintenance activities that you scheduled in Defining schedules for server maintenance activities.

## Installing and configuring backup-archive clients

---

Following the successful setup of your IBM Spectrum Protect™ server system, install and configure client software to begin backing up data.

### Procedure

---

To install the backup-archive client, follow the installation instructions for your operating system.

- Installing the UNIX and Linux backup-archive clients
- Installing the Windows backup-archive client

### What to do next

---

Register and assign your clients to schedules.

- Registering and assigning clients to schedules  
Add and register your clients through the Operations Center by using the Add Client wizard.
- Installing the client management service  
Install the client management service for backup-archive clients that run on Linux and Windows operating systems. The client management service collects diagnostic information about backup-archive clients and makes the information available to the Operations Center for basic monitoring capability.

## Registering and assigning clients to schedules

---

Add and register your clients through the Operations Center by using the Add Client wizard.

### Before you begin

---

Determine whether the client requires an administrative user ID with client owner authority over the client node. To determine which clients require an administrative user ID, see technote 7048963.

Restriction: For some types of clients, the client node name and the administrative user ID must match. You cannot authenticate those clients by using the Lightweight Directory Access Protocol authentication method that was introduced in V7.1.7. For details about this authentication method, sometimes referred to as integrated mode, see Authenticating users by using an Active Directory database.

### Procedure

---

To register a client, complete one of the following actions.

- If the client requires an administrative user ID, register the client by using the REGISTER NODE command and specify the USERID parameter:

```
register node node_name password userid=node_name
```

where *node\_name* specifies the node name and *password* specifies the node password. For details, see Register a node.

- If the client does not require an administrative user ID, register the client by using the Operations Center Add Client wizard. Complete the following steps:
  - a. On the Operations Center menu bar, click Clients.
  - b. In the Clients table, click +Client.
  - c. Complete the steps in the Add Client wizard:
    - i. Specify that redundant data can be eliminated on both the client and server. In the Client-side data deduplication area, select the Enable check box.
    - ii. In the Configuration window, copy the TCPSERVERADDRESS, TCPPORT, NODENAME, and DEDUPLICATION option values.  
Tip: Record the option values and keep them in a safe place. After you complete the client registration and install the software on the client node, use the values to configure the client.
    - iii. Follow the instructions in the wizard to specify the policy domain, schedule, and option set.
    - iv. Set how risks are displayed for the client by specifying the at-risk setting.
    - v. Click Add Client.

## Installing the client management service

---

Install the client management service for backup-archive clients that run on Linux and Windows operating systems. The client management service collects diagnostic information about backup-archive clients and makes the information available to the Operations Center for basic monitoring capability.

### Procedure

---

Install the client management service on the same computer as the backup-archive client by completing the following steps:

1. Download the installation package for the client management service from an IBM® download site such as IBM Passport Advantage® or IBM Fix Central. Look for a file name that is similar to `<version>-IBM_Spectrum_Protect-CMS-operating_system.bin`.
  2. Create a directory on the client system that you want to manage, and copy the installation package there.
  3. Extract the contents of the installation package file.
  4. Run the installation batch file from the directory where you extracted the installation and associated files. This is the directory that you created in step 2.
  5. To install the client management service, follow the instructions in the IBM Installation Manager wizard. If IBM Installation Manager is not already installed on the client system, you must select both IBM Installation Manager and IBM Spectrum Protect™ Client Management Services.
- Verifying that the client management service is installed correctly  
Before you use the client management service to collect diagnostic information about a backup-archive client, you can verify that the client management service is correctly installed and configured.
  - Configuring the Operations Center to use the client management service  
If you did not use the default configuration for the client management service, you must configure the Operations Center to access the client management service.

#### Related tasks:

- [🔗 Configuring the client management service for custom client installations](#)

## Verifying that the client management service is installed correctly

---

Before you use the client management service to collect diagnostic information about a backup-archive client, you can verify that the client management service is correctly installed and configured.

### Procedure

---

On the client system, at the command line, run the following commands to view the configuration of the client management service:

- On Linux client systems, issue the following command:

```
client_install_dir/cms/bin/CmsConfig.sh list
```

where *client\_install\_dir* is the directory where the backup-archive client is installed. For example, with the default client installation, issue the following command:

```
/opt/tivoli/tsm/cms/bin/CmsConfig.sh list
```

The output is similar to the following text:

```
Listing CMS configuration

server1.example.com:1500 NO_SSL HOSTNAME
Capabilities: [LOG_QUERY]
  Opt Path: /opt/tivoli/tsm/client/ba/bin/dsm.sys

  Log File: /opt/tivoli/tsm/client/ba/bin/dsmerror.log
            en_US MM/dd/yyyy HH:mm:ss Windows-1252

  Log File: /opt/tivoli/tsm/client/ba/bin/dsmsched.log
            en_US MM/dd/yyyy HH:mm:ss Windows-1252
```

- On Windows client systems, issue the following command:

```
client_install_dir\cms\bin\CmsConfig.bat list
```

where *client\_install\_dir* is the directory where the backup-archive client is installed. For example, with the default client installation, issue the following command:

```
C:\Program Files\Tivoli\TSM\cms\bin\CmsConfig.bat list
```

The output is similar to the following text:

```
Listing CMS configuration

server1.example.com:1500 NO_SSL HOSTNAME
Capabilities: [LOG_QUERY]
  Opt Path: C:\Program Files\Tivoli\TSM\baclient\dsm.opt

  Log File: C:\Program Files\Tivoli\TSM\baclient\dsmerror.log
            en_US MM/dd/yyyy HH:mm:ss Windows-1252

  Log File: C:\Program Files\Tivoli\TSM\baclient\dmsched.log
            en_US MM/dd/yyyy HH:mm:ss Windows-1252
```

If the client management service is correctly installed and configured, the output displays the location of the error log file. The output text is extracted from the following configuration file:

- On Linux client systems:

```
client_install_dir/cms/Liberty/usr/servers/cmsServer/client-configuration.xml
```

- On Windows client systems:

```
client_install_dir\cms\Liberty\usr\servers\cmsServer\client-configuration.xml
```

If the output does not contain any entries, you must configure the client-configuration.xml file. For instructions to configure this file, see [Configuring the client management service for custom client installations](#). You can use the CmsConfig verify command to verify that a node definition is correctly created in the client-configuration.xml file.

## Configuring the Operations Center to use the client management service

---

If you did not use the default configuration for the client management service, you must configure the Operations Center to access the client management service.

### Before you begin

---

Ensure that the client management service is installed and started on the client system. Verify whether the default configuration is used. The default configuration is not used if either of the following conditions is met:

- The client management service does not use the default port number, 9028.
- The backup-archive client is not accessed by the same IP address as the client system where the backup-archive client is installed. For example, a different IP address might be used in the following situations:
  - The computer system has two network cards. The backup-archive client is configured to communicate on one network, while the client management service communicates on the other network.
  - The client system is configured with the Dynamic Host Configuration Protocol (DHCP). As a result, the client system is dynamically assigned an IP address, which is saved on the server during the previous backup-archive client operation. When the client system is restarted, the client system might be assigned a different IP address. To ensure that the Operations Center can always find the client system, you specify a fully qualified domain name.

## Procedure

To configure the Operations Center to use the client management service, complete the following steps:

1. On the Clients page of the Operations Center, select the client.
2. Click Details > Properties.
3. In the Remote diagnostics URL field in the General section, specify the URL for the client management service on the client system. The address must start with `https`. The following table shows examples of the remote diagnostics URL.

Type of URL	Example
With DNS host name and default port, 9028	<code>https://server.example.com</code>
With DNS host name and non-default port	<code>https://server.example.com:1599</code>
With IP address and non-default port	<code>https://192.0.2.0:1599</code>

4. Click Save.

## What to do next

You can access client diagnostic information such as client log files from the Diagnosis tab in the Operations Center.

## Completing the implementation

After the IBM Spectrum Protect™ solution is configured and running, test backup operations and set up monitoring to ensure that everything runs smoothly.

## Procedure

1. Test backup operations to verify that your data is protected in the way that you expect.
  - a. On the Clients page of the Operations Center, select the clients that you want to back up, and click Back Up.
  - b. On the Servers page of the Operations Center, select the server for which you want to back up the database. Click Back Up, and follow the instructions in the Back Up Database window.
  - c. Verify that the backup operations completed successfully with no warning or error messages.
 

Tip: Alternatively, you can use the backup-archive client GUI to back up client data and you can backup the server database by issuing BACKUP DB command from an administrative command-line.
2. Set up monitoring for your solution by following the instructions in Monitoring a single-site disk solution.

## Monitoring a single-site disk solution

After you implement a single-site disk solution with IBM Spectrum Protect™, monitor the solution for correct operation. By monitoring the solution daily and periodically, you can identify existing and potential issues. The information that you gather can be used to troubleshoot problems and optimize system performance.

## About this task

The preferred way to monitor a solution is by using the Operations Center, which provides overall and detailed system status in a graphical user interface. In addition, you can configure the Operations Center to generate a daily email report that summarizes system status.

In some cases, you might want to use advanced monitoring tools to complete specific monitoring or troubleshooting tasks.



Tip: If you plan to diagnose issues with backup-archive clients on Linux or Windows operating systems, install IBM Spectrum Protect client management services on each computer where a backup-archive client is installed. In this way, you can ensure that the Diagnose button is available in the Operations Center for diagnosing issues with backup-archive clients. To install the client management service, follow the instructions in Installing the client management service.

## Procedure

1. Complete daily monitoring tasks. For instructions, see Daily checklist.
2. Complete periodic monitoring tasks. For instructions, see Periodic checklist.
3. To verify that your IBM Spectrum Protect solution complies with licensing requirements, follow the instructions in Verifying license compliance.
4. To set up Operations Center to generate email status reports, see Tracking system status by using email reports

## What to do next

Resolve any issues that you detect. To resolve an issue by changing the configuration of your solution, follow the instructions in Managing operations for a single-site disk solution. The following resources are also available:

- To resolve performance issues, see Performance.
- To resolve other types of issues, see Troubleshooting.

## Daily monitoring checklist

To ensure that you are completing the daily monitoring tasks for your IBM Spectrum Protect™ solution, review the daily monitoring checklist.

Complete the daily monitoring tasks from the Operations Center Overview page. You can access the Overview page by opening the Operations Center and clicking Overviews.

The following figure shows the location for completing each task.

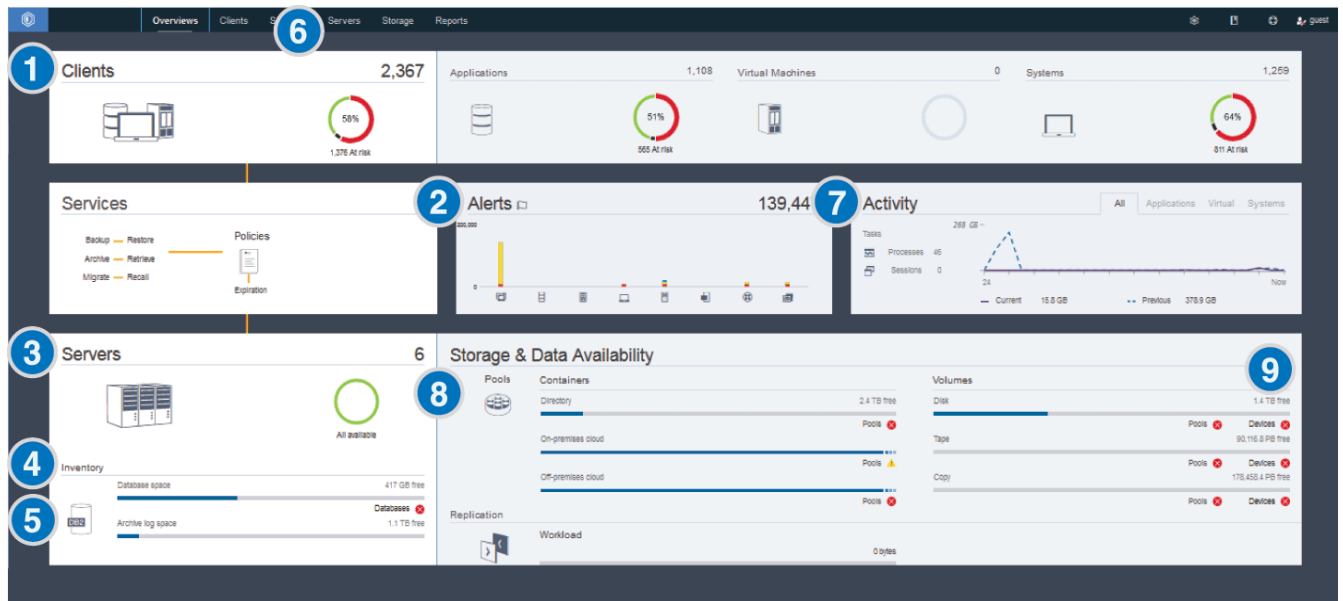





Tip: To run administrative commands for advanced monitoring tasks, use the Operations Center command builder. The command builder provides a type-ahead function to guide you as you enter commands. To open the command builder, go to the Operations Center Overview page. On the menu bar, hover over the settings icon  and click Command Builder.

The following table lists the daily monitoring tasks and provides instructions for completing each task.





Table 1. Daily monitoring tasks

Task	Basic procedures	Advanced procedures and troubleshooting information
------	------------------	---

Task	Basic procedures	Advanced procedures and troubleshooting information
<p><b>1</b> Determine whether clients are at risk of being unprotected due to failed or missed backup operations.</p>	<p>To verify whether clients are at risk, in the Clients area, look for an At risk notification. To view details, click the Clients area.</p> <p>If you installed the client management service on a backup-archive client, you can view and analyze the client error and schedule logs by completing the following steps:</p> <ol style="list-style-type: none"> <li>1. In the Clients table, select the client and click Details.</li> <li>2. To diagnose an issue, click Diagnosis.</li> </ol>	<p>For clients that do not have the client management service installed, access the client system to review the client error logs.</p>
<p><b>2</b> Determine whether client-related or server-related errors require attention.</p>	<p>To determine the severity of any reported alerts, in the Alerts area, hover over the columns.</p>	<p>To view additional information about alerts, complete the following steps:</p> <ol style="list-style-type: none"> <li>1. Click the Alerts area.</li> <li>2. In the Alerts table, select an alert.</li> <li>3. In the Activity Log pane, review the messages. The pane displays related messages that were issued before and after the selected alert occurred.</li> </ol>
<p><b>3</b> Determine whether servers that are managed by the Operations Center are available to provide data protection services to clients.</p>	<ol style="list-style-type: none"> <li>1. To verify whether servers are at risk, in the Servers area, look for an Unavailable notification.</li> <li>2. To view additional information, click the Servers area.</li> <li>3. Select a server in the Servers table and click Details.</li> </ol>	<p>Tip: If you detect an issue that is related to server properties, update the server properties:</p> <ol style="list-style-type: none"> <li>1. In the Servers table, select a server and click Details.</li> <li>2. To update server properties, click Properties.</li> </ol>

Task	Basic procedures	Advanced procedures and troubleshooting information
<p><b>4</b> Determine whether sufficient space is available for the server inventory, which consists of the server database, active log, and archive log.</p>	<ol style="list-style-type: none"> <li>1. Click the Servers area.</li> <li>2. In the Status column of the table, view the status of the server and resolve any issues: <ul style="list-style-type: none"> <li>o Normal  Sufficient space is available for the server database, active log, and archive log.</li> <li>o Critical  Insufficient space is available for the server database, active log, or archive log. You must add space immediately, or the data protection services that are provided by the server will be interrupted.</li> <li>o Warning  The server database, active log, or archive log is running out of space. If this condition persists, you must add space.</li> <li>o Unavailable  Status cannot be obtained. Ensure that the server is running, and that there are no network issues. This status is also shown if the monitoring administrator ID is locked or otherwise unavailable on the server. This ID is named IBM-OC-hub_server_name.</li> <li>o Unmonitored  Unmonitored servers are defined to the hub server, but are not configured for management by the Operations Center. To configure an unmonitored server, select the server, and click Monitor Spoke.</li> </ul> </li> </ol>	<p>You can also look for related alerts on the Alerts page. For additional instructions about troubleshooting, see Resolving server problems.</p>

Task	Basic procedures	Advanced procedures and troubleshooting information
<p><b>5</b> Verify server database backup operations.</p>	<p>To determine when a server was most recently backed up, complete the following steps:</p> <ol style="list-style-type: none"> <li>1. Click the Servers area.</li> <li>2. In the Servers table, review the Last Database Backup column.</li> </ol>	<p>To obtain more detailed information about backup operations, complete the following steps:</p> <ol style="list-style-type: none"> <li>1. In the Servers table, select a row and click Details.</li> <li>2. In the DB Backup area, hover over the check marks to review information about backup operations.</li> </ol> <p>If a database was not backed up recently (for example, in the last 24 hours), you can start a backup operation:</p> <ol style="list-style-type: none"> <li>1. On the Operations Center Overview page, click the Servers area.</li> <li>2. In the table, select a server and click Back Up.</li> </ol> <p>To determine whether the server database is configured for automatic backup operations, complete the following steps:</p> <ol style="list-style-type: none"> <li>1. On the menu bar, hover over the settings icon  and click Command Builder.</li> <li>2. Issue the QUERY DB command: <pre>query db f=d</pre> </li> <li>3. In the output, review the Full Device Class Name field. If a device class is specified, the server is configured for automatic database backups.</li> </ol>
<p><b>6</b> Monitor other server maintenance tasks. Server maintenance tasks can include running administrative command schedules, maintenance scripts, and related commands.</p>	<p>To search for information about processes that failed because of server issues, complete the following steps:</p> <ol style="list-style-type: none"> <li>1. Click Servers &gt; Maintenance.</li> <li>2. To obtain the two-week history of a process, view the History column.</li> <li>3. To obtain more information about a scheduled process, hover over the check box that is associated with the process.</li> </ol>	<p>For more information about monitoring processes and resolving issues, see the Operations Center online help.</p>
<p><b>7</b> Verify that the amount of data that was recently sent to and from servers is within the expected range.</p>	<ul style="list-style-type: none"> <li>• To obtain an overview of activity in the last 24 hours, view the Activity area.</li> <li>• To compare activity in the last 24 hours with activity in the previous 24 hours, review the figures in the Current and Previous areas.</li> </ul>	<ul style="list-style-type: none"> <li>• If more data was sent to the server than you expected, determine which clients are backing up more data and investigate the cause. It is possible that client-side data deduplication is not working correctly.</li> <li>• If less data was sent to the server than you expected, investigate whether client backup operations are proceeding on schedule.</li> </ul>

Task	Basic procedures	Advanced procedures and troubleshooting information
<p>8 Verify that storage pools are available to back up client data.</p>	<ol style="list-style-type: none"> <li>If problems are indicated in the Storage &amp; Data Availability area, click Pools to view the details: <ul style="list-style-type: none"> <li>If the Critical  status is displayed, insufficient space is available in the storage pool, or its access status is unavailable.</li> <li>If the Warning  status is displayed, the storage pool is running out of space, or its access status is read-only.</li> </ul> </li> <li>To view the used, free, and total space for your selected storage pool, hover over the entries in the Capacity Used column.</li> </ol>	<p>To view the storage-pool capacity that was used over the past two weeks, select a row in the Storage Pools table and click Details.</p>
<p>9 Verify that storage devices are available for backup operations.</p>	<p>In the Storage &amp; Data Availability area, in the Volumes section, under the capacity bars, review the status that is reported next to Devices. If a Critical  or Warning  status is displayed for any device, investigate the issue. To view details, click Devices.</p>	<p>Disk devices might have a critical or warning status for the following reasons:</p> <ul style="list-style-type: none"> <li>For DISK device classes, volumes might be offline or have a read-only access status. The Disk Storage column of the Disk Devices table shows the state of volumes.</li> <li>For FILE device classes that are not shared, directories might be offline. Also, insufficient free space might be available for allocating scratch volumes. The Disk Storage column of the Disk Devices table shows the state of directories.</li> <li>For FILE device classes that are shared, drives might be unavailable. A drive is unavailable if it is offline, if it stopped responding to the server, or if its path is offline. Other columns of the Disk Devices table show the state of the drives and paths.</li> </ul>

## Periodic monitoring checklist

To help ensure that your IBM Spectrum Protect™ solution operates correctly, complete the tasks in the periodic monitoring checklist. Schedule periodic tasks frequently enough so that you can detect potential issues before they become problematic.



Tip: To run administrative commands for advanced monitoring tasks, use the Operations Center command builder. The command builder provides a type-ahead function to guide you as you enter commands. To open the command builder, go to the Operations Center Overview page. On the menu bar, hover over the settings icon  and click Command Builder.

Table 1. Periodic monitoring tasks

Task	Basic procedures	Advanced procedures and troubleshooting
------	------------------	---

Task	Basic procedures	Advanced procedures and troubleshooting
Monitor system performance.	<p>Determine the length of time that is required for client backup operations:</p> <ol style="list-style-type: none"> <li>1. On the Operations Center Overview page, click Clients. Find the server that is associated with the client.</li> <li>2. Click Servers. Select the server and click Details.</li> <li>3. To view the duration of completed tasks in the last 24 hours, click Completed Tasks.</li> <li>4. To view the duration of tasks that were completed more than 24 hours ago, use the QUERY ACTLOG command. Follow the instructions in QUERY ACTLOG (Query the activity log).</li> <li>5. If the duration of client backup operations is increasing and the reasons are not clear, investigate the cause.</li> </ol> <p>If you installed the client management service on a backup-archive client, you can diagnose performance issues for the backup-archive client by completing the following steps:</p> <ol style="list-style-type: none"> <li>1. On the Operations Center Overview page, click Clients.</li> <li>2. Select a backup-archive client and click Details.</li> <li>3. To retrieve client logs, click Diagnosis.</li> </ol>	<p>For instructions about reducing the time that it takes for the client to back up data to the server, see Resolving common client performance problems.</p> <p>Look for performance bottlenecks. For instructions, see Identifying performance bottlenecks.</p> <p>For information about identifying and resolving other performance issues, see Performance.</p>
Determine the disk savings that are provided by data deduplication.	<ol style="list-style-type: none"> <li>1. On the Operations Center Overview page, click Pools.</li> <li>2. Select a pool and click Quick Look.</li> <li>3. In the Data Deduplication area, view the Space saved row.</li> </ol>	<p>For advanced monitoring, to obtain detailed statistics about the data-deduplication process for a specific directory-container storage pool or cloud-container storage pool, complete the following steps:</p> <ol style="list-style-type: none"> <li>1. On the Operations Center Overview page, hover over the settings icon  and click Command Builder.</li> <li>2. Obtain a statistical report by issuing the GENERATE DEDUPSTATS command. Follow the instructions in GENERATE DEDUPSTATS (Generate data deduplication statistics for a directory-container storage pool).</li> <li>3. View the statistical report by issuing the QUERY DEDUPSTATS command. Follow the instructions in QUERY DEDUPSTATS (Query data deduplication statistics).</li> </ol>

Task	Basic procedures	Advanced procedures and troubleshooting
<p>Verify that current backup files for device configuration and volume history information are saved.</p>	<p>Access your storage locations to ensure that the files are available. The preferred method is to save the backup files to two locations.</p> <p>To locate the volume history and device configuration files, complete the following steps:</p> <ol style="list-style-type: none"> <li>1. On the Operations Center Overview page, hover over the settings icon  and click Command Builder.</li> <li>2. To locate the volume history and device configuration files, issue the following commands: <pre>query option volhistory query option devconfig</pre> </li> <li>3. In the output, review the Option Setting column to find the file locations.</li> </ol> <p>If a disaster occurs, both the volume history file and the device configuration file are required to restore the server database.</p>	

Task	Basic procedures	Advanced procedures and troubleshooting
<p>Determine whether sufficient space is available for the instance directory file system.</p>	<p>Verify that at least 20% of free space is available in the instance directory file system. Take the action that is appropriate for your operating system:</p> <ul style="list-style-type: none"> <li> <p><b>AIX</b> To view available space in the file system, on the operating system command line, issue the following command:</p> <pre>df -g instance_directory</pre> <p>where <i>instance_directory</i> specifies the instance directory.</p> </li> <li> <p><b>Linux</b> To view available space in the file system, on the operating system command line, issue the following command:</p> <pre>df -h instance_directory</pre> <p>where <i>instance_directory</i> specifies the instance directory.</p> </li> <li> <p><b>Windows</b> In the Windows Explorer program, right-click the file system and click Properties. View the capacity information.</p> </li> </ul> <p>The preferred location of the instance directory depends on the operating system where the server is installed:</p> <ul style="list-style-type: none"> <li> <p><b>AIX</b>   <b>Linux</b> /home/tsminst1/tsminst1</p> </li> <li> <p><b>Windows</b> C:\tsminst1</p> </li> </ul> <p>Tip: If you completed a planning worksheet, the location of the instance directory is recorded in the worksheet.</p>	
<p>Identify unexpected client activity.</p>	<p>To monitor client activity to determine whether data volumes exceed expected amounts, complete the following steps:</p> <ol style="list-style-type: none"> <li>1. On the Operations Center Overview page, click the Clients area.</li> <li>2. To view activity over the past two weeks, double-click any client.</li> <li>3. To view the number of bytes sent to the client, click the Properties tab.</li> <li>4. In the Last Session area, view the Sent to client row.</li> </ol>	<p>When you double-click a client in the Clients table, the Activity over 2 Weeks area displays the amount of data that the client sent to the server each day.</p>



Task	Basic procedures	Advanced procedures and troubleshooting
<p>Monitor storage pool growth over time.</p>	<ol style="list-style-type: none"> <li>1. On the Operations Center Overview page, click the Pools area.</li> <li>2. To view the capacity that was used over the last two weeks, select a pool and click Details.</li> </ol>	<p>Tips:</p> <ul style="list-style-type: none"> <li>• To specify the time period that must elapse before all deduplicated extents are removed from a directory-container storage pool or cloud-container storage pool after they are no longer referenced by the inventory, complete the following steps: <ol style="list-style-type: none"> <li>1. On the Storage Pools page of the Operations Center, select the storage pool.</li> <li>2. Click Details &gt; Properties.</li> <li>3. Specify the duration in the <code>Delay period for container reuse</code> field.</li> </ol> </li> <li>• To determine data deduplication performance for directory-container and cloud-container storage pools, use the <code>GENERATE DEDUPSTATS</code> command.</li> <li>• To view data deduplication statistics for a storage pool, complete the following steps: <ol style="list-style-type: none"> <li>1. On the Storage Pools page of the Operations Center, select the storage pool.</li> <li>2. Click Details &gt; Properties.</li> </ol> </li> </ul> <p>Alternatively, use the <code>QUERY EXTENTUPDATES</code> command to display information about updates to data extents in directory-container or cloud-container storage pools. The command output can help you determine which data extents are no longer referenced and which ones are eligible to be deleted from the system. In the output, monitor the number of data extents that are eligible to be deleted from the system. This metric has a direct correlation to the amount of free space that will be available within the container storage pool.</p> <ul style="list-style-type: none"> <li>• To display the amount of physical space that is occupied by a file space after the removal of the data deduplication savings, use the <code>select * from occupancy</code> command. The command output includes the <code>LOGICAL_MB</code> value. <code>LOGICAL_MB</code> is the amount of space that is used by the file space.</li> </ul>
<p>Evaluate the timing of client schedules. Ensure that the start and end times of client schedules meet your business needs.</p>	<p>On the Operations Center Overview page, click Clients &gt; Schedules.</p> <p>In the Schedules table, the Start column displays the configured start time for the scheduled operation. To see when the most recent operation was started, hover over the clock icon.</p>	<p>Tip: You can receive a warning message if a client operation runs longer than expected. Complete the following steps:</p> <ol style="list-style-type: none"> <li>1. On the Operations Center Overview page, hover over Clients and click Schedules.</li> <li>2. Select a schedule and click Details.</li> <li>3. View the details of a schedule by clicking the blue arrow next to the row.</li> <li>4. In the Run time alert field, specify the time when a warning message will be issued if the scheduled operation is not completed.</li> <li>5. Click Save.</li> </ol>

Task	Basic procedures	Advanced procedures and troubleshooting
Evaluate the timing of maintenance tasks. Ensure that the start and end times of maintenance tasks meet your business needs.	<p>On the Operations Center Overview page, click Servers &gt; Maintenance.</p> <p>In the Maintenance table, review the information in the Last Run Time column. To see when the last maintenance task was started, hover over the clock icon.</p>	<p>Tip: If a maintenance task is running too long, change the start time or the maximum run time. Complete the following steps:</p> <ol style="list-style-type: none"> <li>1. On the Operations Center Overview page, hover over the settings icon  and click Command Builder.</li> <li>2. To change the start time or maximum run time for a task, issue the UPDATE SCHEDULE command. For instructions, see UPDATE SCHEDULE (Update a client schedule).</li> </ol>

**Related reference:**

QUERY ACTLOG (Query the activity log)

[🔗](#) UPDATE STGPOOL (Update a storage pool)

[🔗](#) QUERY EXTENTUPDATES (Query updated data extents)

## Verifying license compliance

Verify that your IBM Spectrum Protect™ solution complies with the provisions of your licensing agreement. By verifying compliance regularly, you can track trends in data growth or processor value unit (PVU) usage. Use this information to plan for future license purchasing.

### About this task

The method that you use to verify that your solution complies with license terms varies depending on the provisions of your IBM Spectrum Protect licensing agreement.

#### Front-end capacity licensing

The front-end model determines license requirements based on the amount of primary data that is reported as being backed up by clients. Clients include applications, virtual machines, and systems.

#### Back-end capacity licensing

The back-end model determines license requirements based on the terabytes of data that are stored in primary storage pools and repositories.

Tips:

- To ensure the accuracy of front-end and back-end capacity estimates, install the most recent version of the client software on each client node.
- The front-end and back-end capacity information in the Operations Center is for planning and estimation purposes.

#### PVU licensing

The PVU model is based on the use of PVUs by server devices.

Important: The PVU calculations that are provided by IBM Spectrum Protect are considered estimates and are not legally binding. The PVU licensing information that is reported by IBM Spectrum Protect is not considered an acceptable substitute for the IBM® License Metric Tool.



For the most recent information about licensing models, see the information about product details and licenses at the IBM Spectrum Protect product family website. If you have questions or concerns about licensing requirements, contact your IBM Spectrum Protect software provider.

## Procedure

To monitor license compliance, complete the steps that correspond to the provisions of your licensing agreement.

Tip: The Operations Center provides an email report that summarizes front-end and back-end capacity usage. Reports can be sent automatically to one or more recipients regularly. To configure and manage email reports, click Reports on the Operations Center menu bar.

Option	Description
--------	-------------

Option	Description
<b>Front-end model</b>	<p>a. On the Operations Center menu bar, hover over the settings icon  and click Licensing.</p> <p>The front-end capacity estimate is displayed on the Front-end Usage page.</p> <p>b. If a value is displayed in the Not Reporting column, click the number to identify clients that did not report capacity usage.</p> <p>c. To estimate capacity for clients that did not report capacity usage, go to the following FTP site, which provides measuring tools and instructions:</p> <p><code>ftp://public.dhe.ibm.com/storage/tivoli-storage-management/front_end_capacity_measurement_tools</code></p> <p>To measure front-end capacity by script, complete the instructions in the most recently available licensing guide.</p> <p>d. Add the Operations Center estimate and any estimates that you obtained by using a script.</p> <p>e. Verify that the estimated capacity complies with your licensing agreement.</p>
<b>Back-end model</b>	<p>Restriction: If the source and target replication servers do not use the same policy settings, you cannot use the Operations Center to monitor back-end capacity usage for replicated clients. For information about how to estimate capacity usage for these clients, see technote 1656476.</p> <p>a. On the Operations Center menu bar, hover over the settings icon  and click Licensing.</p> <p>b. Click the Back-end tab.</p> <p>c. Verify that the estimated amount of data complies with your licensing agreement.</p>
<b>PVU model</b>	<p>For information about how to assess compliance with PVU licensing terms, see <a href="#">Assessing compliance with the PVU licensing model</a>.</p>

## Tracking system status by using email reports

Set up the Operations Center to generate email reports that summarize system status. You can configure a mail server connection, change report settings, and optionally create custom SQL reports.

### Before you begin

Before you set up email reports, ensure that the following requirements are met:

- A Simple Mail Transfer Protocol (SMTP) host server is available to send and receive reports by email. The SMTP server must be configured as an open mail relay. You must also ensure that the IBM Spectrum Protect™ server that sends email messages has access to the SMTP server. If the Operations Center is installed on a separate computer, that computer does not require access to the SMTP server.
- To set up email reports, you must have system privilege for the server.
- To specify the recipients, you can enter one or more email addresses or administrator IDs. If you plan to enter an administrator ID, the ID must be registered on the hub server and must have an email address associated with it. To specify an email address for an administrator, use the EMAILADDRESS parameter of the UPDATE ADMIN command.

### About this task

You can configure the Operations Center to send a general operations report, a license compliance report, and one or more custom reports, which use SQL SELECT statements to query managed servers.

### Procedure

To set up and manage email reports, complete the following steps:

1. On the Operations Center menu bar, click Reports.
2. If an email server connection is not yet configured, click Configure Mail Server and complete the fields. After you configure the mail server, the general operations report and license compliance report are enabled.
3. To change report settings, select a report, click Details, and update the form.

- Optional: To add a custom SQL report, click + Report, and complete the fields.  
Tip: To immediately run and send a report, select the report and click Send.

## Results

---

Enabled reports are sent according to the specified settings.

**Related reference:**

[UPDATE ADMIN](#) (Update an administrator)

## Managing operations for a single-site disk solution

---

Use this information to manage operations for a single-site disk solution with IBM Spectrum Protect™ that includes a server and uses data deduplication for a single location.

- **Managing the Operations Center**  
The Operations Center provides web and mobile access to status information about the IBM Spectrum Protect environment. You can use the Operations Center to monitor multiple servers and to complete some administrative tasks. The Operations Center also provides web access to the IBM Spectrum Protect command line.
- **Protecting applications, virtual machines, and systems**  
The server protects data for clients, which can include applications, virtual machines, and systems. To start protecting client data, register the client node with the server and select a backup schedule to protect the client data.
- **Managing data storage**  
Manage your data for efficiency and add supported devices and media to the server to store client data.
- **Securing the IBM Spectrum Protect server**  
Secure the IBM Spectrum Protect server and data by controlling access to servers and client nodes, encrypting data, and maintaining secure access levels and passwords.
- **Stopping and starting the server**  
Before you complete maintenance or reconfiguration tasks, stop the server. Then, start the server in maintenance mode. When you are finished with the maintenance or reconfiguration tasks, restart the server in production mode.
- **Planning to upgrade the server**  
When a fix pack or interim fix becomes available, you can upgrade the IBM Spectrum Protect server to take advantage of product improvements. Servers and clients can be upgraded at different times. Ensure that you complete the planning steps before you upgrade the server.
- **Preparing for an outage or system update**  
Prepare IBM Spectrum Protect to maintain your system in a consistent state during a planned power outage or system update.
- **Implementing a disaster recovery plan**  
Implement a disaster recovery strategy to recover your applications if a disaster occurs and to ensure high server availability.
- **Recovering from system outages**  
For IBM Spectrum Protect single-site disk solutions, you can recover the inventory locally only and restore the database to protect your data.

## Managing the Operations Center

---

The Operations Center provides web and mobile access to status information about the IBM Spectrum Protect™ environment. You can use the Operations Center to monitor multiple servers and to complete some administrative tasks. The Operations Center also provides web access to the IBM Spectrum Protect command line.

- **Adding and removing spoke servers**  
In a multiple-server environment, you can connect the other servers, called *spoke servers*, to the hub server.
- **Starting and stopping the web server**  
The web server of the Operations Center runs as a service and starts automatically. You might have to stop and start the web server, for example, to make configuration changes.
- **Restarting the initial configuration wizard**  
You might need to restart the initial configuration wizard of the Operations Center, for example, to make configuration changes.
- **Changing the hub server**  
You can use the Operations Center to remove the hub server of IBM Spectrum Protect, and configure another hub server.
- **Restoring the configuration to the preconfiguration state**  
If certain problems occur, you might want to restore the Operations Center configuration to the preconfigured state where

the IBM Spectrum Protect servers are not defined as hub or spoke servers.

## Adding and removing spoke servers

---

In a multiple-server environment, you can connect the other servers, called *spoke servers*, to the hub server.

### About this task

---

The spoke servers send alerts and status information to the hub server. The Operations Center shows you a consolidated view of alerts and status information for the hub server and any spoke servers.

- Adding a spoke server  
After you configure the hub server for the Operations Center, you can add one or more spoke servers to the hub server.
- Removing a spoke server  
You can remove a spoke server from the Operations Center.

## Adding a spoke server

---

After you configure the hub server for the Operations Center, you can add one or more spoke servers to the hub server.

### Before you begin

---

Communication between the spoke server and the hub server must be secured by using the Transport Layer Security (TLS) protocol. To secure communication, add the certificate of the spoke server to the truststore file of the hub server.

### Procedure

---

1. In the Operations Center menu bar, click Servers. The Servers page opens.

In the table on the Servers page, a server might have a status of "Unmonitored." This status means that although an administrator defined this server to the hub server by using the DEFINE SERVER command, the server is not yet configured as a spoke server.

2. Complete one of the following steps:
  - Click the server to highlight it, and in the table menu bar, click Monitor Spoke.
  - If the server that you want to add is not shown in the table, and secure SSL/TLS communication is not required, click + Spoke in the table menu bar.
3. Provide the necessary information, and complete the steps in the spoke configuration wizard.  
Tip: If the event-record retention period of the server is less than 14 days, the period is automatically reset to 14 days if you configure the server as a spoke server.

## Removing a spoke server

---

You can remove a spoke server from the Operations Center.

### About this task

---

You might need to remove a spoke server in the following situations, for example:

- You want to move the spoke server from one hub server to another hub server.
- You want to decommission the spoke server.

### Procedure

---

To remove the spoke server from the group of servers that are managed by the hub server, complete the following steps:

1. From the IBM Spectrum Protect™ command line, issue the following command on the hub server:

```
QUERY MONITORSETTINGS
```

2. From the output of the command, copy the name that is in the Monitored Group field.

3. Issue the following command on the hub server, where *group\_name* represents the name of the monitored group, and *member\_name* represents the name of the spoke server:

```
DELETE GRPMEMBER group_name member_name
```

4. Optional: If you want to move the spoke server from one hub server to another hub server, do **not** complete this step. Otherwise, you can disable alerting and monitoring on the spoke server by issuing the following commands on the spoke server:

```
SET STATUSMONITOR OFF  
SET ALERTMONITOR OFF
```

5. Optional: If the spoke server definition is used for other purposes, such as enterprise configuration, command routing, storing virtual volumes, or library management, do **not** complete this step. Otherwise, you can delete the spoke server definition on the hub server by issuing the following command on the hub server:

```
DELETE SERVER spoke_server_name
```

## Starting and stopping the web server

---

The web server of the Operations Center runs as a service and starts automatically. You might have to stop and start the web server, for example, to make configuration changes.

### Procedure

---

1. Stop the web server.
  - o **AIX** From the */installation\_dir/ui/utls* directory, where *installation\_dir* represents the directory where the Operations Center is installed, issue the following command:

```
./stopserver.sh
```

- o **Linux** Issue the following command:

```
service opscenter.rc stop
```

- o **Windows** From the Services window, stop the IBM Spectrum Protect™ Operations Center service.

2. Start the web server.

- o **AIX** From the */installation\_dir/ui/utls* directory, where *installation\_dir* represents the directory where the Operations Center is installed, issue the following command:

```
./startserver.sh
```

- o **Linux** Issue the following commands:

Start the server:

```
service opscenter.rc start
```

Restart the server:

```
service opscenter.rc restart
```

Determine whether the server is running:

```
service opscenter.rc status
```

- o **Windows** From the Services window, start the IBM Spectrum Protect Operations Center service.

## Restarting the initial configuration wizard

---

You might need to restart the initial configuration wizard of the Operations Center, for example, to make configuration changes.

### Before you begin

---

To change the following settings, use the Settings page in the Operations Center rather than restarting the initial configuration wizard:

- The frequency at which status data is refreshed
- The duration that alerts remain active, inactive, or closed
- The conditions that indicate that clients are at risk

The Operations Center help includes more information about how to change these settings.

## About this task

---

To restart the initial configuration wizard, you must delete a properties file that includes information about the hub server connection. However, any alerting, monitoring, at-risk, or multiserver settings that were configured for the hub server are not deleted. These settings are used as the default settings in the configuration wizard when the wizard restarts.

## Procedure

---

1. Stop the Operations Center web server.
2. On the computer where the Operations Center is installed, go to the following directory, where *installation\_dir* represents the directory in which the Operations Center is installed:
  - o **AIX** | **Linux** *installation\_dir*/ui/Liberty/usr/servers/guiServer
  - o **Windows** *installation\_dir*\ui\Liberty\usr\servers\guiServer
 For example:
  - o **AIX** | **Linux** /opt/tivoli/tsm/ui/Liberty/usr/servers/guiServer
  - o **Windows** c:\Program Files\Tivoli\TSM\ui\Liberty\usr\servers\guiServer
3. In the guiServer directory, delete the serverConnection.properties file.
4. Start the Operations Center web server.
5. Open the Operations Center.
6. Use the configuration wizard to reconfigure the Operations Center. Specify a new password for the monitoring administrator ID.
7. On any spoke servers that were previously connected to the hub server, update the password for the monitoring administrator ID by issuing the following command from the IBM Spectrum Protect™ command-line interface:

```
UPDATE ADMIN IBM-OC-hub_server_name new_password
```

Restriction: Do not change any other settings for this administrator ID. After you specify the initial password, this password is managed automatically by the Operations Center.

## Changing the hub server

---

You can use the Operations Center to remove the hub server of IBM Spectrum Protect™, and configure another hub server.

## Procedure

---

1. Restart the initial configuration wizard of the Operations Center. As part of this procedure, you delete the existing hub server connection.
2. Use the wizard to configure the Operations Center to connect to the new hub server.

### Related tasks:

Restarting the initial configuration wizard

## Restoring the configuration to the preconfiguration state

---

If certain problems occur, you might want to restore the Operations Center configuration to the preconfigured state where the IBM Spectrum Protect™ servers are not defined as hub or spoke servers.

## Procedure

---

To restore the configuration, complete the following steps:

1. Stop the Operations Center web server.
2. Unconfigure the hub server by completing the following steps:
  - a. On the hub server, issue the following commands:

```
SET MONITORINGADMIN ""
SET MONITOREDSEVERGROUP ""
SET STATUSMONITOR OFF
SET ALERTMONITOR OFF
REMOVE ADMIN IBM-OC-hub_server_name
```

Tip: *IBM-OC-hub\_server\_name* represents the monitoring administrator ID that was automatically created when you initially configured the hub server.

- b. Reset the password for the hub server by issuing the following command on the hub server:

```
SET SERVERPASSWORD ""
```

Attention: Do not complete this step if the hub server is configured with other servers for other purposes, such as library sharing, exporting and importing of data, or node replication.

3. Unconfigure any spoke servers by completing the following steps:

- a. On the hub server, to determine whether any spoke servers remain as members of the server group, issue the following command:

```
QUERY SERVERGROUP IBM-OC-hub_server_name
```

Tip: *IBM-OC-hub\_server\_name* represents the name of the monitored server group that was automatically created when you configured the first spoke server. This server group name is also the same as the monitoring administrator ID that was automatically created when you initially configured the hub server.

- b. On the hub server, to delete spoke servers from the server group, issue the following command for each spoke server:

```
DELETE GRPMEMBER IBM-OC-hub_server_name spoke_server_name
```

- c. After all spoke servers are deleted from the server group, issue the following commands on the hub server:

```
DELETE SERVERGROUP IBM-OC-hub_server_name
SET MONITOREDSEVERGROUP ""
```

- d. On each spoke server, issue the following commands:

```
REMOVE ADMIN IBM-OC-hub_server_name
SETOPT PUSHSTATUS NO
SET ALERTMONITOR OFF
SET STATUSMONITOR OFF
```

- e. On each spoke server, delete the definition of the hub server by issuing the following command:

```
DELETE SERVER hub_server_name
```

Attention: Do not complete this step if the definition is used for other purposes, such as library sharing, exporting and importing of data, or node replication.

- f. On the hub server, delete the definition of each spoke server by issuing the following command:

```
DELETE SERVER spoke_server_name
```

Attention: Do not complete this step if the server definition is used for other purposes, such as library sharing, exporting and importing of data, or node replication.

4. Restore the default settings on each server by issuing the following commands:

```
SET STATUSREFRESHINTERVAL 5
SET ALERTUPDATEINTERVAL 10
SET ALERTACTIVEDURATION 480
SET ALERTINACTIVEDURATION 480
SET ALERTCLOSEDDURATION 60
SET STATUSATRISKINTERVAL TYPE=AP INTERVAL=24
SET STATUSATRISKINTERVAL TYPE=VM INTERVAL=24
SET STATUSATRISKINTERVAL TYPE=SY INTERVAL=24
SET STATUSSKIPASFAILURE YES TYPE=ALL
```

5. Restart the initial configuration wizard of the Operations Center.

#### Related tasks:

Restarting the initial configuration wizard

Starting and stopping the web server



# Protecting applications, virtual machines, and systems

---

The server protects data for clients, which can include applications, virtual machines, and systems. To start protecting client data, register the client node with the server and select a backup schedule to protect the client data.

- **Adding clients**  
After you implement a data protection solution with IBM Spectrum Protect, you can expand the solution by adding clients.
- **Managing client operations**  
You can evaluate and resolve errors that are related to a backup-archive client by using the Operations Center, which provides suggestions for resolving errors. For errors on other types of clients, you must examine the error logs on the client and review the product documentation.
- **Managing client upgrades**  
When a fix pack or interim fix becomes available for a client, you can upgrade the client to take advantage of product improvements. Servers and clients can be upgraded at different times and can be at different levels with some restrictions.
- **Decommissioning a client node**  
If a client node is no longer required, you can start a process to remove it from the production environment. For example, if a workstation was backing up data to the IBM Spectrum Protect server, but the workstation is no longer used, you can decommission the workstation.
- **Deactivating data to free storage space**  
In some cases, you can deactivate data that is stored on the IBM Spectrum Protect server. When you run the deactivation process, any backup data that was stored before the specified date and time is deactivated and will be deleted as it expires. In this way, you can free space on the server.

## Adding clients

---

After you implement a data protection solution with IBM Spectrum Protect™, you can expand the solution by adding clients.

### About this task

---

The procedure describes basic steps for adding a client. For more specific instructions about configuring clients, see the documentation for the product that you install on the client node. You can have the following types of client nodes:

#### Application client nodes

Application client nodes include email servers, databases, and other applications. For example, any of the following applications can be an application client node:

- IBM Spectrum Protect Snapshot
- IBM Spectrum Protect for Databases
- IBM Spectrum Protect for Enterprise Resource Planning
- IBM Spectrum Protect for Mail
- IBM Spectrum Protect for Virtual Environments

#### System client nodes

System client nodes include workstations, network-attached storage (NAS) file servers, and API clients.

#### Virtual machine client nodes

Virtual machine client nodes consist of an individual guest host within a hypervisor. Each virtual machine is represented as a file space.

## Procedure

---

To add a client, complete the following steps:

1. Select the software to install on the client node and plan the installation. Follow the instructions in [Selecting the client software and planning the installation](#).
2. Specify how to back up and archive client data. Follow the instructions in [Specifying rules for backing up and archiving client data](#).
3. Specify when to back up and archive client data. Follow the instructions in [Scheduling backup and archive operations](#).
4. To allow the client to connect to the server, register the client. Follow the instructions in [Registering clients](#).
5. To start protecting a client node, install and configure the selected software on the client node. Follow the instructions in [Installing and configuring clients](#).

## Selecting the client software and planning the installation

Different types of data require different types of protection. Identify the type of data that you must protect and select the appropriate software.

### About this task

The preferred practice is to install the backup-archive client on all client nodes so that you can configure and start the client acceptor on the client node. The client acceptor is designed to efficiently run scheduled operations.

The client acceptor runs schedules for the following products: the backup-archive client, IBM Spectrum Protect™ for Databases, IBM Spectrum Protect for Enterprise Resource Planning, IBM Spectrum Protect for Mail, and IBM Spectrum Protect for Virtual Environments. If you install a product for which the client acceptor does not run schedules, you must follow the configuration instructions in the product documentation to ensure that scheduled operations can occur.

### Procedure

Based on your goal, select the products to install and review the installation instructions.

Tip: If you install the client software now, you must also complete the client configuration tasks that are described in [Installing and configuring clients](#) before you can use the client.

Goal	Product and description	Installation instructions
Protect a file server or workstation	The backup-archive client backs up and archives files and directories from file servers and workstations to storage. You can also restore and retrieve backup versions and archived copies of files.	<ul style="list-style-type: none"><li>• Backup-archive client requirements</li><li>• Installing the UNIX and Linux backup-archive clients</li><li>• Installing the Windows backup-archive client</li></ul>
Protect applications with snapshot backup and restore capabilities	IBM Spectrum Protect Snapshot protects data with integrated, application-aware snapshot backup and restore capabilities. You can protect data that is stored by IBM DB2® database software and SAP, Oracle, Microsoft Exchange, and Microsoft SQL Server applications.	<ul style="list-style-type: none"><li>• Installing and upgrading IBM Spectrum Protect Snapshot for UNIX and Linux</li><li>• Installing and upgrading IBM Spectrum Protect Snapshot for VMware</li><li>• Installing and upgrading IBM Spectrum Protect Snapshot for Windows</li></ul>
Protect an email application on an IBM Domino® server	IBM Spectrum Protect for Mail: Data Protection for IBM® Domino automates data protection so that backups are completed without shutting down IBM Domino servers.	<ul style="list-style-type: none"><li>• Installation of Data Protection for IBM Domino on a UNIX, AIX, or Linux system (V7.1.0)</li><li>• Installation of Data Protection for IBM Domino on a Windows system (V7.1.0)</li></ul>
Protect an email application on a Microsoft Exchange server	IBM Spectrum Protect for Mail: Data Protection for Microsoft Exchange Server automates data protection so that backups are completed without shutting down Microsoft Exchange servers.	Installing, upgrading, and migrating IBM Spectrum Protect for Mail: Data Protection for Microsoft Exchange Server
Protect an IBM DB2 database	The application programming interface (API) of the backup-archive client can be used to back up DB2 data to the IBM Spectrum Protect server.	Installing the IBM Spectrum Protect backup-archive clients (UNIX, Linux, and Windows)
Protect an IBM Informix® database	The API of the backup-archive client can be used to back up Informix data to the IBM Spectrum Protect server.	Installing the IBM Spectrum Protect backup-archive clients (UNIX, Linux, and Windows)
Protect a Microsoft SQL database	IBM Spectrum Protect for Databases: Data Protection for Microsoft SQL Server protects Microsoft SQL data.	Installing Data Protection for SQL Server on Windows Server Core
Protect an Oracle database	IBM Spectrum Protect for Databases: Data Protection for Oracle protects Oracle data.	Data Protection for Oracle installation

Goal	Product and description	Installation instructions
Protect an SAP environment	IBM Spectrum Protect for Enterprise Resource Planning: Data Protection for SAP provides protection that is customized for SAP environments. The product is designed to improve the availability of SAP database servers and reduce administration workload.	<ul style="list-style-type: none"> <li>Installing IBM Spectrum Protect for Enterprise Resource Planning: Data Protection for SAP for DB2</li> <li>Installing IBM Spectrum Protect for Enterprise Resource Planning: Data Protection for SAP for Oracle</li> </ul>
Protect a virtual machine	<p>IBM Spectrum Protect for Virtual Environments provides protection that is tailored for Microsoft Hyper-V and VMware virtual environments. You can use IBM Spectrum Protect for Virtual Environments to create incremental forever backups that are stored on a centralized server, create backup policies, and restore virtual machines or individual files.</p> <p>Alternatively, use the backup-archive client to back up and restore a full VMware or Microsoft Hyper-V virtual machine. You can also back up and restore files or directories from a VMware virtual machine.</p>	<ul style="list-style-type: none"> <li>Installing Data Protection for Microsoft Hyper-V</li> <li>Installing and upgrading Data Protection for VMware</li> <li>Installing the IBM Spectrum Protect backup-archive clients (UNIX, Linux, and Windows)</li> </ul>

Tip: To use the client for space management, you can install IBM Spectrum Protect for Space Management or IBM Spectrum Protect HSM for Windows.

## Specifying rules for backing up and archiving client data

Before you add a client, ensure that appropriate rules are specified for backing up and archiving the client data. During the client registration process, you assign the client node to a policy domain, which has the rules that control how and when client data is stored.

### Before you begin

Determine how to proceed:

- If you are familiar with the policies that are configured for your solution and you know that they do not require changes, continue with Scheduling backup and archive operations.
- If you are not familiar with the policies, follow the steps in this procedure.

### About this task

Policies affect how much data is stored over time, and how long data is retained and available for clients to restore. To meet objectives for data protection, you can update the default policy and create your own policies. A policy includes the following rules:

- How and when files are backed up and archived to server storage
- The number of copies of a file and the length of time copies are kept in server storage

During the client registration process, you assign a client to a *policy domain*. The policy for a specific client is determined by the rules in the policy domain to which the client is assigned. In the policy domain, the rules that are in effect are in the active *policy set*.

When a client backs up or archives a file, the file is bound to a management class in the active policy set of the policy domain. A *management class* is the key set of rules for managing client data. The backup and archive operations on the client use the settings in the default management class of the policy domain unless you further customize policy. A policy can be customized by defining more management classes and assigning their use through client options.

Client options can be specified in a local, editable file on the client system and in a client option set on the server. The options in the client option set on the server can override or add to the options in the local client option file.

## Procedure

---

1. Review the policies that are configured for your solution by following the instructions in Viewing policies.
2. If you need to make minor changes to meet data retention requirements, follow the instructions in Editing policies.
3. Optional: If you need to create policy domains or make extensive changes to policies to meet data retention requirements, see Customizing policies.

## Viewing policies

---

View policies to determine whether they must be edited to meet your requirements.

## Procedure

---

1. To view the active policy set for a policy domain, complete the following steps:
  - a. On the Services page of the Operations Center, select a policy domain and click Details.
  - b. On the Summary page for the policy domain, click the Policy Sets tab.
2. To view inactive policy sets for a policy domain, complete the following steps:
  - a. On the Policy Sets page, click the Configure toggle. You can now view and edit the policy sets that are inactive.
  - b. Scroll through the inactive policy sets by using the forward and back arrows. When you view an inactive policy set, the settings that differentiate the inactive policy set from the active policy set are highlighted.
  - c. Click the Configure toggle. The policy sets are no longer editable.

## Editing policies

---

To change the rules that apply to a policy domain, edit the active policy set for the policy domain. You can also activate a different policy set for a domain.

## Before you begin

---

Changes to policy can affect data retention. Ensure that you continue to back up data that is essential to your organization so that you can restore that data if a disaster occurs. Also, ensure that your system has sufficient storage space for planned backup operations.

## About this task

---

You edit a policy set by changing one or more management classes within the policy set. If you edit the active policy set, the changes are not available to clients unless you reactivate the policy set. To make the edited policy set available to clients, activate the policy set.

Although you can define multiple policy sets for a policy domain, only one policy set can be active. When you activate a different policy set, it replaces the currently active policy set.

To learn about preferred practices for defining policies, see Customizing policies.

## Procedure

---

1. On the Services page of the Operations Center, select a policy domain and click Details.
2. On the Summary page for the policy domain, click the Policy Sets tab.

The Policy Sets page indicates the name of the active policy set and lists all of the management classes for that policy set.

3. Click the Configure toggle. The policy set is editable.
4. Optional: To edit a policy set that is not active, click the forward and back arrows to locate the policy set.
5. Edit the policy set by completing any of the following actions:

Option	Description
--------	-------------

Option	Description
<b>Add a management class</b>	a. In the Policy Sets table, click +Management Class. b. To specify the rules for backing up and archiving data, complete the fields in the Add Management Class window. c. To make the management class the default management class, select the Make default check box. d. Click Add.
<b>Delete a management class</b>	In the Management Class column, click -. Tip: To delete the default management class, you must first assign a different management class as the default.
<b>Make a management class the default management class</b>	In the Default column for the management class, click the radio button. Tip: The default management class manages client files when another management class is not assigned to, or appropriate for managing, a file. To ensure that clients can always back up and archive files, choose a default management class that contains rules for both backing up and archiving files.
<b>Modify a management class</b>	To change the properties of a management class, update the fields in the table.

6. Click Save.

Attention: When you activate a new policy set, data might be lost. Data that is protected under one policy set might not be protected under another policy set. Therefore, before you activate a policy set, ensure that the differences between the previous policy set and the new policy set do not cause data to be lost.

7. Click Activate. A summary of the differences between the active policy set and the new policy set is displayed. Ensure that the changes in the new policy set are consistent with your data retention requirements by completing the following steps:
- Review the differences between corresponding management classes in the two policy sets, and consider the consequences for client files. Client files that are bound to management classes in the active policy set will be bound to the management classes with the same names in the new policy set.
  - Identify management classes in the active policy set that do not have counterparts in the new policy set, and consider the consequences for client files. Client files that are bound to these management classes will be managed by the default management class in the new policy set.
  - If the changes to be implemented by the policy set are acceptable, select the I understand that these updates can cause data loss check box and click Activate.

## Scheduling backup and archive operations

Before you register a new client with the server, ensure that a schedule is available to specify when backup and archive operations take place. During the registration process, you assign a schedule to the client.

### Before you begin

Determine how to proceed:

- If you are familiar with the schedules that are configured for the solution and you know that they do not require modification, continue with Registering clients.
- If you are not familiar with the schedules or the schedules require modification, follow the steps in this procedure.

### About this task

Typically, backup operations for all clients must be completed daily. Carefully schedule client and server workloads to achieve the best performance for your storage environment. To avoid the overlap of client and server operations, consider scheduling client backup and archive operations so that they run at night. If client and server operations overlap or are not given enough time and resources to be processed, you might experience decreased system performance, failed operations, and other issues.

### Procedure

- Review available schedules by hovering over Clients on the Operations Center menu bar. Click Schedules.
- Optional: Modify or create a schedule by completing the following steps:

Option	Description
--------	-------------

Option	Description
<b>Modify a schedule</b>	<ol style="list-style-type: none"> <li>In the Schedules view, select the schedule and click Details.</li> <li>On the Schedule Details page, view details by clicking the blue arrows at the beginning of the rows.</li> <li>Modify the settings in the schedule, and click Save.</li> </ol>
<b>Create a schedule</b>	In the Schedules view, click +Schedule and complete the steps to create a schedule.

- Optional: To configure schedule settings that are not visible in the Operations Center, use a server command. For example, you might want to schedule a client operation that backs up a specific directory and assigns it to a management class other than the default.
  - On the Overview page of the Operations Center, hover over the settings icon  and click Command Builder.
  - Issue the DEFINE SCHEDULE command to create a schedule or the UPDATE SCHEDULE command to modify a schedule. For details about the commands, see DEFINE SCHEDULE (Define a schedule for an administrative command) or UPDATE SCHEDULE (Update a client schedule).

**Related tasks:**

[Tuning the schedule for daily operations](#)

## Registering clients

Register a client to ensure that the client can connect to the server, and the server can protect client data.

### Before you begin

Determine whether the client requires an administrative user ID with client owner authority over the client node. To determine which clients require an administrative user ID, see technote 7048963.

Restriction: For some types of clients, the client node name and the administrative user ID must match. You cannot authenticate those clients by using the Lightweight Directory Access Protocol authentication method that was introduced in V7.1.7. For details about this authentication method, sometimes referred to as integrated mode, see Authenticating users by using an Active Directory database.

### Procedure

To register a client, complete one of the following actions.

- If the client requires an administrative user ID, register the client by using the REGISTER NODE command and specify the USERID parameter:

```
register node node_name password userid=node_name
```

where *node\_name* specifies the node name and *password* specifies the node password. For details, see Register a node.

- If the client does not require an administrative user ID, register the client by using the Operations Center Add Client wizard. Complete the following steps:
  - On the Operations Center menu bar, click Clients.
  - In the Clients table, click +Client.
  - Complete the steps in the Add Client wizard:
    - Specify that redundant data can be eliminated on both the client and server. In the Client-side data deduplication area, select the Enable check box.
    - In the Configuration window, copy the TCPSEVERADDRESS, TCPPOINT, NODENAME, and DEDUPLICATION option values.

Tip: Record the option values and keep them in a safe place. After you complete the client registration and install the software on the client node, use the values to configure the client.
    - Follow the instructions in the wizard to specify the policy domain, schedule, and option set.
    - Set how risks are displayed for the client by specifying the at-risk setting.
    - Click Add Client.

**Related reference:**

- [Tcpserveraddress option](#)
- [Tcpoint option](#)
- [Nodename option](#)

## Installing and configuring clients

To start protecting a client node, you must install and configure the selected software.

### Procedure

If you already installed the software, start at step 2.

1. Take one of the following actions:

- To install software on an application or client node, follow the instructions.

Software	Link to instructions
IBM Spectrum Protect™ backup-archive client	<ul style="list-style-type: none"> <li>▪ Installing the UNIX and Linux backup-archive clients</li> <li>▪ Installing the Windows backup-archive client</li> </ul> <p>For information about manual deployment of client updates from the server, see the following documents:</p> <ul style="list-style-type: none"> <li>▪ For IBM Spectrum Protect 8.1.2 or later servers, see technote 2004596.</li> <li>▪ For IBM® Tivoli® Storage Manager V7.1 servers and IBM Spectrum Protect V8.1.0 and V8.1.1 servers, see technote 1673299.</li> </ul>
IBM Spectrum Protect for Databases	<ul style="list-style-type: none"> <li>▪ Data Protection for Oracle installation</li> <li>▪ Installing Data Protection for SQL Server on Windows Server Core</li> </ul>
IBM Spectrum Protect for Mail	<ul style="list-style-type: none"> <li>▪ Installation of Data Protection for IBM Domino on a UNIX, AIX, or Linux system (V7.1.0)</li> <li>▪ Installation of Data Protection for IBM Domino on a Windows system (V7.1.0)</li> <li>▪ Installing, upgrading, and migrating IBM Spectrum Protect for Mail: Data Protection for Microsoft Exchange Server</li> </ul>
IBM Spectrum Protect Snapshot	<ul style="list-style-type: none"> <li>▪ Installing and upgrading IBM Spectrum Protect Snapshot for UNIX and Linux</li> <li>▪ Installing and upgrading IBM Spectrum Protect Snapshot for VMware</li> <li>▪ Installing and upgrading IBM Spectrum Protect Snapshot for Windows</li> </ul>
IBM Spectrum Protect for Enterprise Resource Planning	<ul style="list-style-type: none"> <li>▪ Installing IBM Spectrum Protect for Enterprise Resource Planning: Data Protection for SAP for DB2®</li> <li>▪ Installing IBM Spectrum Protect for Enterprise Resource Planning: Data Protection for SAP for Oracle</li> </ul>

- To install software on a virtual machine client node, follow the instructions for the selected backup type.

Backup type	Link to instructions
If you plan to create full VMware backups of virtual machines, install and configure the IBM Spectrum Protect backup-archive client.	<ul style="list-style-type: none"> <li>▪ Installing the UNIX and Linux backup-archive clients</li> <li>▪ Installing the Windows backup-archive client</li> </ul>
If you plan to create incremental forever full backups of virtual machines, install and configure IBM Spectrum Protect for Virtual Environments and the backup-archive client on the same client node or on different client nodes.	<ul style="list-style-type: none"> <li>▪ IBM Spectrum Protect for Virtual Environments online product documentation</li> </ul> <p>Tip: You can obtain the software for IBM Spectrum Protect for Virtual Environments and the backup-archive client in the IBM Spectrum Protect for Virtual Environments installation package.</p>

2. To allow the client to connect to the server, add or update the values for the TCPSERVERADDRESS, TCPPORT, and NODENAME options in the client options file. Use the values that you recorded when you registered the client (Registering clients).

- For clients that are installed on an AIX®, Linux, or Mac OS X operating system, add the values to the client system-options file, dsm.sys.
- For clients that are installed on a Windows operating system, add the values to the dsm.opt file.

- By default, the options files are in the installation directory.
3. If you installed a backup-archive client on a Linux or Windows operating system, install the client management service on the client. Follow the instructions in [Installing the client management service](#).
  4. Configure the client to run scheduled operations. Follow the instructions in [Configuring the client to run scheduled operations](#).
  5. Optional: Configure communications through a firewall. Follow the instructions in [Configuring client/server communications through a firewall](#).
  6. Run a test backup to verify that data is protected as you planned. For example, for a backup-archive client, complete the following steps:
    - a. On the Clients page of the Operations Center, select the client that you want to back up, and click Back Up.
    - b. Verify that the backup completes successfully and that there are no warning or error messages.
  7. Monitor the results of the scheduled operations for the client in the Operations Center.

## What to do next

---

If you need to change what is getting backed up from the client, follow the instructions in [Modifying the scope of a client backup](#).

## Configuring the client to run scheduled operations

---

You must configure and start a client scheduler on the client node. The client scheduler enables communication between the client and server so that scheduled operations can occur. For example, scheduled operations typically include backing up files from a client.

### About this task

---

The preferred method is to install the backup-archive client on all client nodes so that you can configure and start the client acceptor on the client node. The client acceptor is designed to efficiently run scheduled operations. The client acceptor manages the client scheduler so that the scheduler runs only when required:

- When it is time to query the server about the next scheduled operation
- When it is time to start the next scheduled operation

By using the client acceptor, you can reduce the number of background processes on the client and help to avoid memory retention problems.

The client acceptor runs schedules for the following products: the backup-archive client, IBM Spectrum Protect™ for Databases, IBM Spectrum Protect for Enterprise Resource Planning, IBM Spectrum Protect for Mail, and IBM Spectrum Protect for Virtual Environments. If you installed a product for which the client acceptor does not run schedules, follow the configuration instructions in the product documentation to ensure that scheduled operations can occur.

If your business uses a third-party scheduling tool as standard practice, you can use that scheduling tool as an alternative to the client acceptor. Typically, third-party scheduling tools start client programs directly by using operating system commands. To configure a third-party scheduling tool, see the product documentation.

## Procedure

---

To configure and start the client scheduler by using the client acceptor, follow the instructions for the operating system that is installed on the client node:

AIX® and Oracle Solaris

- a. From the backup-archive client GUI, click Edit > Client Preferences.
- b. Click the Web Client tab.
- c. In the Managed Services Options field, click Schedule. If you also want the client acceptor to manage the web client, click the Both option.
- d. To ensure that the scheduler can start unattended, in the `dsm.sys` file, set the `passwordaccess` option to `generate`.
- e. To store the client node password, issue the following command and enter the client node password when prompted:

```
dsmc query sess
```

- f. Start the client acceptor by issuing the following command on the command line:



```
/usr/bin/dsmcad
```

- g. To enable the client acceptor to start automatically after a system restart, add the following entry to the system startup file (typically, `/etc/inittab`):

```
tsm::once:/usr/bin/dsmcad > /dev/null 2>&1 # Client Acceptor Daemon
```

## Linux

- From the backup-archive client GUI, click Edit > Client Preferences.
- Click the Web Client tab.
- In the Managed Services Options field, click Schedule. If you also want the client acceptor to manage the web client, click the Both option.
- To ensure that the scheduler can start unattended, in the `dsm.sys` file, set the `passwordaccess` option to `generate`.
- To store the client node password, issue the following command and enter the client node password when prompted:

```
dsmc query sess
```

- f. Start the client acceptor by logging in with the root user ID and issuing the following command:

```
service dsmcad start
```

- g. To enable the client acceptor to start automatically after a system restart, add the service by issuing the following command at a shell prompt:

```
# chkconfig --add dsmcad
```

## MAC OS X

- In the backup-archive client GUI, click Edit > Client Preferences.
- To ensure that the scheduler can start unattended, click Authorization, select Password Generate, and click Apply.
- To specify how services are managed, click Web Client, select Schedule, click Apply, and click OK.
- To ensure that the generated password is saved, restart the backup-archive client.
- Use the IBM Spectrum Protect Tools for Administrators application to start the client acceptor.

## Windows

- In the backup-archive client GUI, click Utilities > Setup Wizard > Help me configure the Client Scheduler. Click Next.
- Read the information on the Scheduler Wizard page and click Next.
- On the Scheduler Task page, select Install a new or additional scheduler and click Next.
- On the Scheduler Name and Location page, specify a name for the client scheduler that you are adding. Then, select Use the Client Acceptor daemon (CAD) to manage the scheduler and click Next.
- Enter the name that you want to assign to this client acceptor. The default name is Client Acceptor. Click Next.
- Complete the configuration by stepping through the wizard.
- Update the client options file, `dsm.opt`, and set the `passwordaccess` option to `generate`.
- To store the client node password, issue the following command at the command prompt:

```
dsmc query sess
```

Enter the client node password when prompted.

- Start the client acceptor service from the Services Control page. For example, if you used the default name, start the Client Acceptor service. Do not start the scheduler service that you specified on the Scheduler Name and Location page. The scheduler service is started and stopped automatically by the client acceptor service as needed.

## Configuring client/server communications through a firewall

---

If a client must communicate with a server through a firewall, you must enable client/server communications through the firewall.

### Before you begin

---

If you used the Add Client wizard to register a client, find the option values in the client options file that you obtained during that process. You can use the values to specify ports.

### About this task

---

Attention: Do not configure a firewall in a way that might cause termination of sessions that are in use by a server or storage agent. Termination of a valid session can cause unpredictable results. Processes and sessions might appear to stop due to input/output errors. To help exclude sessions from timeout restrictions, configure known ports for IBM Spectrum Protect™ components. Ensure that the KEEPALIVE server option remains set to the default value of YES. In this way, you can help to ensure that client/server communication is uninterrupted. For instructions about setting the KEEPALIVE server option, see KEEPALIVE.

## Procedure

---

Open the following ports to allow access through the firewall:

TCP/IP port for the backup-archive client, command-line administrative client, and the client scheduler

Specify the port by using the tcpport option in the client options file. The tcpport option in the client options file must match the TCPSPORT option in the server options file. The default value is 1500. If you decide to use a value other than the default, specify a number in the range 1024 - 32767.

HTTP port to enable communication between the web client and remote workstations

Specify the port for the remote workstation by setting the httpport option in the client options file of the remote workstation. The default value is 1581.

TCP/IP ports for the remote workstation

The default value of 0 (zero) causes two free port numbers to be randomly assigned to the remote workstation. If you do not want the port numbers to be randomly assigned, specify values by setting the webports option in the client options file of the remote workstation.

TCP/IP port for administrative sessions

Specify the port on which the server waits for requests for administrative client sessions. The value of the client tcpadminport option must match the value of the TCPADMINPORT server option. In this way, you can secure administrative sessions within a private network.

## Managing client operations

---

You can evaluate and resolve errors that are related to a backup-archive client by using the Operations Center, which provides suggestions for resolving errors. For errors on other types of clients, you must examine the error logs on the client and review the product documentation.

### About this task

---

In some cases, you can resolve client errors by stopping and starting the client acceptor. If client nodes or administrator IDs are locked, you can resolve the issue by unlocking the client node or administrator ID, and then resetting the password.

For detailed instructions about identifying and resolving client errors, see Resolving client problems.

- Evaluating errors in client error logs  
You can resolve client errors by obtaining suggestions from the Operations Center or by reviewing error logs on the client.
- Stopping and restarting the client acceptor  
If you change the configuration of your solution, you must restart the client acceptor on all client nodes where a backup-archive client is installed.
- Resetting passwords  
If a password for a client node or an administrator ID is lost or forgotten, you can reset the password. Multiple attempts to access the system with an incorrect password can cause a client node or administrator ID to be locked. You can take steps to resolve the issue.
- Modifying the scope of a client backup  
When you set up client backup operations, the preferred practice is to exclude objects that you do not require. For example, you typically want to exclude temporary files from a backup operation.

## Evaluating errors in client error logs

---

You can resolve client errors by obtaining suggestions from the Operations Center or by reviewing error logs on the client.

### Before you begin

---

To resolve errors in a backup-archive client on a Linux or Windows operating system, ensure that the client management service is installed and started. For installation instructions, see [Installing the client management service](#). For instructions about verifying the installation, see [Verifying that the client management service is installed correctly](#).

## Procedure

---

To diagnose and resolve client errors, take one of the following actions:

- If the client management service is installed on the client node, complete the following steps:
  1. On the Operations Center Overview page, click Clients and select the client.
  2. Click Details.
  3. On the client Summary page, click the Diagnosis tab.
  4. Review the retrieved log messages.

Tips:

- To show or hide the Client Logs pane, double-click the Client Logs bar.
- To resize the Client Logs pane, click and drag the Client Logs bar.

If suggestions are displayed on the Diagnosis page, select a suggestion. In the Client Logs pane, client log messages to which the suggestion relates are highlighted.

5. Use the suggestions to resolve the problems that are indicated by the error messages.

Tip: Suggestions are provided for only a subset of client messages.
- If the client management service is not installed on the client node, review the error logs for the installed client.

## Stopping and restarting the client acceptor

---

If you change the configuration of your solution, you must restart the client acceptor on all client nodes where a backup-archive client is installed.

### About this task

---

In some cases, you can resolve client scheduling problems by stopping and restarting the client acceptor. The client acceptor must be running to ensure that scheduled operations can occur on the client. For example, if you change the IP address or domain name of the server, you must restart the client acceptor.

## Procedure

---

Follow the instructions for the operating system that is installed on the client node:

AIX and Oracle Solaris

- To stop the client acceptor, complete the following steps:
  - a. Determine the process ID for the client acceptor by issuing the following command on the command line:

```
ps -ef | grep dsmcad
```

Review the output. In the following sample output, 6764 is the process ID for the client acceptor:

```
root 6764 1 0 16:26:35 ? 0:00 /usr/bin/dsmcad
```

- b. Issue the following command on the command line:

```
kill -9 PID
```

where *PID* specifies the process ID for the client acceptor.

- To start the client acceptor, issue the following command on the command line:

```
/usr/bin/dsmcad
```

Linux

- To stop the client acceptor (and not restart it), issue the following command:

```
# service dsmcad stop
```

- To stop and restart the client acceptor, issue the following command:

```
# service dsmscad restart
```

## MAC OS X

Click Applications > Utilities > Terminal.

- To stop the client acceptor, issue the following command:

```
/bin/launchctl unload -w com.ibm.tivoli.dsmscad
```

- To start the client acceptor, issue the following command:

```
/bin/launchctl load -w com.ibm.tivoli.dsmscad
```

## Windows

- To stop the client acceptor service, complete the following steps:
  - a. Click Start > Administrative Tools > Services.
  - b. Double-click the client acceptor service.
  - c. Click Stop and OK.
- To restart the client acceptor service, complete the following steps:
  - a. Click Start > Administrative Tools > Services.
  - b. Double-click the client acceptor service.
  - c. Click Start and OK.

### Related reference:

[Resolving client scheduling problems](#)

## Resetting passwords

---

If a password for a client node or an administrator ID is lost or forgotten, you can reset the password. Multiple attempts to access the system with an incorrect password can cause a client node or administrator ID to be locked. You can take steps to resolve the issue.

### Procedure

---

To resolve password issues, take one of the following actions:

- If a backup-archive client is installed on a client node, and the password is lost or forgotten, complete the following steps:
  1. Generate a new password by issuing the UPDATE NODE command:

```
update node node_name new_password forcepwnreset=yes
```

where *node\_name* specifies the client node and *new\_password* specifies the password that you assign.

2. Inform the client node owner about the changed password. When the owner of the client node logs in with the specified password, a new password is generated automatically. That password is unknown to users to enhance security.  
Tip: The password is generated automatically if you previously set the passwordaccess option to *generate* in the client options file.

- If an administrator is locked out because of password issues, complete the following steps:
  1. To provide the administrator with access to the server, issue the UNLOCK ADMIN command. For instructions, see UNLOCK ADMIN (Unlock an administrator).
  2. Set a new password by using the UPDATE ADMIN command:

```
update admin admin_name new_password forcepwnreset=yes
```

where *admin\_name* specifies the name of the administrator and *new\_password* specifies the password that you assign.

- If a client node is locked, complete the following steps:
  1. Determine why the client node is locked and whether it must be unlocked. For example, if the client node is decommissioned, the client node is being removed from the production environment. You cannot reverse the decommission operation, and the client node remains locked. A client node also might be locked if the client data is the subject of a legal investigation.
  2. If you must unlock a client node, use the UNLOCK NODE command. For instructions, see UNLOCK NODE (Unlock a client node).

3. Generate a new password by issuing the UPDATE NODE command:

```
update node node_name new_password forcepwreset=yes
```

where *node\_name* specifies the name of the node and *new\_password* specifies the password that you assign.

4. Inform the client node owner about the changed password. When the owner of the client node logs in with the specified password, a new password is generated automatically. That password is unknown to users to enhance security.

Tip: The password is generated automatically if you previously set the passwordaccess option to `generate` in the client options file.

## Modifying the scope of a client backup

---

When you set up client backup operations, the preferred practice is to exclude objects that you do not require. For example, you typically want to exclude temporary files from a backup operation.

### About this task

---

When you exclude unnecessary objects from backup operations, you get better control of the amount of storage space that is required for backup operations, and the cost of storage. Depending on your licensing package, you also might be able to limit licensing costs.

### Procedure

---

How you modify the scope of backup operations depends on the product that is installed on the client node:

- For a backup-archive client, you can create an include-exclude list to include or exclude a file, groups of files, or directories from backup operations. To create an include-exclude list, follow the instructions in [Creating an include-exclude list](#).

To ensure consistent use of an include-exclude list for all clients of one type, you can create a client option set on the server that contains the required options. Then, you assign the client option set to each of the clients of the same type. For details, see [Controlling client operations through client option sets](#).

- For a backup-archive client, you can specify the objects to include in an incremental backup operation by using the domain option. Follow the instructions in [Domain client option](#).
- For other products, to define which objects are included in and excluded from backup operations, follow the instructions in the product documentation.

## Managing client upgrades

---

When a fix pack or interim fix becomes available for a client, you can upgrade the client to take advantage of product improvements. Servers and clients can be upgraded at different times and can be at different levels with some restrictions.

### Before you begin

---

1. Review the client/server compatibility requirements in [technote 1053218](#). If your solution includes servers or clients at a level that is earlier than V7.1, review the guidelines to ensure that client backup and archive operations are not disrupted.
2. Verify system requirements for the client in [IBM Spectrum Protect™ Supported Operating Systems](#).
3. If the solution includes storage agents or library clients, review the information about storage-agent and library-client compatibility with servers that are configured as library managers. See [technote 1302789](#).

If you plan to upgrade a library manager and a library client, you must upgrade the library manager first.

### Procedure

---

To upgrade the software, complete the instructions that are listed in the following table.

Software	Link to instructions
IBM Spectrum Protect backup-archive client	<ul style="list-style-type: none"><li>• <a href="#">Upgrading the backup-archive client</a></li></ul>

Software	Link to instructions
IBM Spectrum Protect Snapshot	<ul style="list-style-type: none"> <li>Installing and upgrading IBM Spectrum Protect Snapshot for UNIX and Linux</li> <li>Installing and upgrading IBM Spectrum Protect Snapshot for VMware</li> <li>Installing and upgrading IBM Spectrum Protect Snapshot for Windows</li> </ul>
IBM Spectrum Protect for Databases	<ul style="list-style-type: none"> <li>Upgrading Data Protection for SQL Server</li> <li>Data Protection for Oracle installation</li> <li>Installing, upgrading, and migrating IBM Spectrum Protect for Mail: Data Protection for Microsoft Exchange Server</li> </ul>
IBM Spectrum Protect for Enterprise Resource Planning	<ul style="list-style-type: none"> <li>Upgrading IBM Spectrum Protect for Enterprise Resource Planning: Data Protection for SAP for DB2®</li> <li>Upgrading IBM Spectrum Protect for Enterprise Resource Planning: Data Protection for SAP for Oracle</li> </ul>
IBM Spectrum Protect for Mail	<ul style="list-style-type: none"> <li>Installation of Data Protection for IBM Domino on a UNIX, AIX, or Linux system (V7.1.0)</li> <li>Installation of Data Protection for IBM Domino on a Windows system (V7.1.0)</li> <li>Installing, upgrading, and migrating IBM Spectrum Protect for Mail: Data Protection for Microsoft Exchange Server</li> </ul>
IBM Spectrum Protect for Virtual Environments	<ul style="list-style-type: none"> <li>Installing and upgrading Data Protection for VMware</li> <li>Installing Data Protection for Microsoft Hyper-V</li> </ul>

## Decommissioning a client node

If a client node is no longer required, you can start a process to remove it from the production environment. For example, if a workstation was backing up data to the IBM Spectrum Protect™ server, but the workstation is no longer used, you can decommission the workstation.

### About this task

When you start the decommission process, the server locks the client node to prevent it from accessing the server. Files that belong to the client node are gradually deleted, and then the client node is deleted. You can decommission the following types of client nodes:

#### Application client nodes

Application client nodes include email servers, databases, and other applications. For example, any of the following applications can be an application client node:

- IBM Spectrum Protect Snapshot
- IBM Spectrum Protect for Databases
- IBM Spectrum Protect for Enterprise Resource Planning
- IBM Spectrum Protect for Mail
- IBM Spectrum Protect for Virtual Environments

#### System client nodes

System client nodes include workstations, network-attached storage (NAS) file servers, and API clients.

#### Virtual machine client nodes

Virtual machine client nodes consist of an individual guest host within a hypervisor. Each virtual machine is represented as a file space.

The simplest method for decommissioning a client node is to use the Operations Center. The decommission process runs in the background. If the client is configured to replicate client data, the Operations Center automatically removes the client from replication on the source and target replication servers before it decommissions the client.

Tip: Alternatively, you can decommission a client node by issuing the `DECOMMISSION NODE` or `DECOMMISSION VM` command. You might want to use this method in the following cases:

- To schedule the decommission process for the future or to run a series of commands by using a script, specify the decommission process to run in the background.
- To monitor the decommission process for debugging purposes, specify the decommission process to run in the foreground. If you run the process in the foreground, you must wait for the process to be completed before you continue with other tasks.

## Procedure

---

Take one of the following actions:

- To decommission a client in the background by using the Operations Center, complete the following steps:
  1. On the Operations Center Overview page, click Clients and select the client.
  2. Click More > Decommission.
- To decommission a client node by using an administrative command, take one of the following actions:
  - To decommission an application or system client node in the background, issue the DECOMMISSION NODE command. For example, if the client node is named AUSTIN, issue the following command:
 

```
decommission node austin
```
  - To decommission an application or system client node in the foreground, issue the DECOMMISSION NODE command and specify the `wait=yes` parameter. For example, if the client node is named AUSTIN, issue the following command:
 

```
decommission node austin wait=yes
```
  - To decommission a virtual machine in the background, issue the DECOMMISSION VM command. For example, if the virtual machine is named AUSTIN, the file space is 7, and the file space name is specified by the file space ID, issue the following command:
 

```
decommission vm austin 7 nametype=fsid
```

If the virtual machine name includes one or more spaces, enclose the name in double quotation marks. For example:

```
decommission vm "austin 2" 7 nametype=fsid
```
  - To decommission a virtual machine in the foreground, issue the DECOMMISSION VM command and specify the `wait=yes` parameter. For example, issue the following command:
 

```
decommission vm austin 7 nametype=fsid wait=yes
```

If the virtual machine name includes one or more spaces, enclose the name in double quotation marks. For example:

```
decommission vm "austin 2" 7 nametype=fsid wait=yes
```

## What to do next

---

Watch for error messages, which might be displayed in the user interface or in the command output, immediately after you run the process.

You can verify that the client node is decommissioned:

1. On the Operations Center Overview page, click Clients.
2. In the Clients table, in the At risk column, review the state:
  - A DECOMMISSIONED state specifies that the node is decommissioned.
  - A null value specifies that the node is not decommissioned.
  - A PENDING state specifies that the node is being decommissioned, or the decommission process failed.

Tip: If you want to determine the status of a pending decommission process, issue the following command:

```
query process
```

3. Review the command output:
  - If status is provided for the decommission process, the process is in progress. For example:

```
query process
```

Process Number	Process Description	Process Status
-----	-----	-----

- If no status is provided for the decommission process, and you did not receive an error message, the process is incomplete. A process can be incomplete if files that are associated with the node are not yet deactivated. After the files are deactivated, run the decommission process again.
- If no status is provided for the decommission process, and you receive an error message, the process failed. Run the decommission process again.

**Related reference:**

[DECOMMISSION NODE \(Decommission a client node\)](#)

[DECOMMISSION VM \(Decommission a virtual machine\)](#)

## Deactivating data to free storage space

---

In some cases, you can deactivate data that is stored on the IBM Spectrum Protect™ server. When you run the deactivation process, any backup data that was stored before the specified date and time is deactivated and will be deleted as it expires. In this way, you can free space on the server.

### About this task

---

Some application clients always save data to the server as active backup data. Because active backup data is not managed by inventory expiration policies, the data is not deleted automatically, and uses server storage space indefinitely. To free the storage space that is used by obsolete data, you can deactivate the data.

When you run the deactivation process, all active backup data that was stored before the specified date becomes inactive. The data is deleted as it expires and cannot be restored. The deactivation feature applies only to application clients that protect Oracle databases.

### Procedure

---

1. From the Operations Center Overview page, click Clients.
2. In the Clients table, select one or more clients and click More > Clean Up.  
Command-line method: Deactivate data by using the DEACTIVATE DATA command.

**Related reference:**

[DEACTIVATE DATA \(Deactivate data for a client node\)](#)

## Managing data storage

---

Manage your data for efficiency and add supported devices and media to the server to store client data.

- Auditing a storage pool container  
Audit a storage pool container to check for inconsistencies between database information and a container in a storage pool.
- Managing inventory capacity  
Manage the capacity of the database, active log, and archive logs to ensure that the inventory is sized for the tasks, based on the status of the logs.
- Managing memory and processor usage  
Ensure that you manage memory requirements and processor usage to ensure that the server can complete data processes such as backup and data deduplication. Consider the impact on performance when you complete certain processes.
- Tuning scheduled activities  
Schedule maintenance tasks daily to ensure that your solution operates correctly. By tuning your solution, you maximize server resources and effectively use different functions available within your solution.

**Related reference:**

[Types of storage pools](#)

## Auditing a storage pool container

---

Audit a storage pool container to check for inconsistencies between database information and a container in a storage pool.



## About this task

---

You audit a storage pool container in the following situations:

- When you issue the QUERY DAMAGED command and a problem is detected
- When the server displays messages about damaged data extents
- Your hardware reports an issue and error messages that are associated with the storage pool container are displayed

## Procedure

---

1. To audit a storage pool container, issue the AUDIT CONTAINER command. For example, issue the following command to audit a container, 000000000000076c.dcf:

```
audit container c:\tsm-storage\07\000000000000076c.dcf
```

2. Review the output from the ANR4891I message for information about any damaged data extents.

## What to do next

---

If you detect problems with the storage pool container, you can restore data based on your configuration. Issue the AUDIT CONTAINER command and specify the container name.

### Related reference:

- [AUDIT CONTAINER](#) (Verify the consistency of database information for a directory-container storage pool)
- [QUERY DAMAGED](#) (Query damaged data in a directory-container or cloud-container storage pool)

## Managing inventory capacity

---

Manage the capacity of the database, active log, and archive logs to ensure that the inventory is sized for the tasks, based on the status of the logs.

## Before you begin

---

The active and archive logs have the following characteristics:

- The active log can be a maximum size of 512 GB. For more information about sizing the active log for your system, see [Planning the storage arrays](#).
- The archive log size is limited to the size of the file system that it is installed on. The archive log size is not maintained at a predefined size like the active log. Archive log files are automatically deleted after they are no longer needed.

As a best practice, you can optionally create an archive failover log to store archive log files when the archive log directory is full.

Check the Operations Center to determine the component of the inventory that is full. Ensure that you stop the server before you increase the size of one of the inventory components.

## Procedure

---

- To increase the size of the database, complete the following steps:
  - Create one or more directories for the database on separate drives or file systems.
  - Issue the EXTEND DBSPACE command to add the directory or directories to the database. The directories must be accessible to the instance user ID of the database manager. By default, data is redistributed across all database directories and space is reclaimed.
    - Tips:
      - The time that is needed to complete redistribution of data and reclaiming of space is variable, depending on the size of your database. Make sure that you plan adequately.
      - Ensure that the directories that you specify are the same size as existing directories to ensure a consistent degree of parallelism for database operations. If one or more directories for the database are smaller than the others, they reduce the potential for optimized parallel prefetching and distribution of the database.
  - Halt and restart the server to fully use the new directories.
  - Reorganize the database if necessary. Index and table reorganization for the server database can help to avoid unexpected database growth and performance issues. For more information about reorganizing the database, see [technote 1683633](#).

- To decrease the size of the database for V7.1 servers and later, issue the following DB2® commands from the server instance directory:  
Restriction: The commands can increase I/O activity, and might affect server performance. To minimize performance problems, wait until one command is completed before you issue the next command. The DB2 commands can be issued when the server is running.

```

db2 connect to tsmdb1
db2 set schema tsmdb1
db2 ALTER TABLESPACE USERSPACE1 REDUCE MAX
db2 ALTER TABLESPACE IDXSPACE1 REDUCE MAX
db2 ALTER TABLESPACE LARGEIDXSPACE1 REDUCE MAX
db2 ALTER TABLESPACE LARGESPACE1 REDUCE MAX
db2 ALTER TABLESPACE REPLTBLSPACE1 REDUCE MAX
db2 ALTER TABLESPACE REPLIDXSPACE1 REDUCE MAX
db2 ALTER TABLESPACE ARCHOBJDATASPACE REDUCE MAX
db2 ALTER TABLESPACE ARCHOBJIDXSPACE REDUCE MAX
db2 ALTER TABLESPACE BACKOBJDATASPACE REDUCE MAX
db2 ALTER TABLESPACE BACKOBJIDXSPACE REDUCE MAX
db2 ALTER TABLESPACE BFABFDATASPACE REDUCE MAX
db2 ALTER TABLESPACE BFABFIDXSPACE REDUCE MAX
db2 ALTER TABLESPACE BFBFEXTDATASPACE REDUCE MAX
db2 ALTER TABLESPACE BFBFEXTIDXSPACE REDUCE MAX
db2 ALTER TABLESPACE DEDUPTBLSPACE1 REDUCE MAX
db2 ALTER TABLESPACE DEDUPIIDXSPACE1 REDUCE MAX
db2 ALTER TABLESPACE DEDUPTBLSPACE2 REDUCE MAX
db2 ALTER TABLESPACE DEDUPIIDXSPACE2 REDUCE MAX
db2 ALTER TABLESPACE DEDUPTBLSPACE3 REDUCE MAX
db2 ALTER TABLESPACE DEDUPIIDXSPACE3 REDUCE MAX
db2 ALTER TABLESPACE DEDUPTBLSPACE4 REDUCE MAX
db2 ALTER TABLESPACE DEDUPIIDXSPACE4 REDUCE MAX
db2 ALTER TABLESPACE DEDUPTBLSPACE5 REDUCE MAX
db2 ALTER TABLESPACE DEDUPIIDXSPACE5 REDUCE MAX

```

- To increase or decrease the size of the active log, complete the following steps:
  - Ensure that the location for the active log has enough space for the increased log size. If a log mirror exists, its location must also have enough space for the increased log size.
  - Halt the server.
  - In the dsmserv.opt file, update the ACTIVELOGSIZE option to the new size of the active log, in megabytes. The size of an active log file is based on the value of the ACTIVELOGSIZE option. Guidelines for space requirements are in the following table:

Table 1. How to estimate volume and file space requirements

ACTIVELOGSize option value	Reserve this much free space in the active log directory, in addition to the ACTIVELOGSize space
16 GB - 128 GB	5120 MB
129 GB - 256 GB	10240 MB
257 GB - 512 GB	20480 MB

To change the active log to its maximum size of 512 GB, enter the following server option:

```
activelogsize 524288
```

- If you plan to use a new active log directory, update the directory name that is specified in the ACTIVELOGDIRECTORY server option. The new directory must be empty and must be accessible to the user ID of the database manager.
  - Restart the server.
- Compress the archive logs to reduce the amount of space that is required for storage. Enable dynamic compression of the archive log by issuing the following command:

```
setopt archlogcompress yes
```

Restriction: Use caution when you enable the ARCHLOGCOMPRESS server option on systems with sustained high volume usage and heavy workloads. Enabling this option in this system environment can cause delays in archiving log files from the active log file system to the archive log file system. This delay can cause the active log file system to run out of space. Be sure to monitor the available space in the active log file system after archive log compression is enabled. If the active log directory file system usage nears out of space conditions, the ARCHLOGCOMPRESS server option must be disabled. You can use the SETOPT command to disable archive log compression immediately without halting the server.

**Related reference:**

- 🔗 [ACTIVELOGSIZE server option](#)
- 🔗 [EXTEND DBSPACE \(Increase space for the database\)](#)
- 🔗 [SETOPT \(Set a server option for dynamic update\)](#)

## Managing memory and processor usage

---

Ensure that you manage memory requirements and processor usage to ensure that the server can complete data processes such as backup and data deduplication. Consider the impact on performance when you complete certain processes.

### Before you begin

---

- Ensure that your configuration uses the required hardware and software. For more information, see [IBM Spectrum Protect™ Supported Operating Systems](#).
- For more information about managing resources such as the database and recovery log, see [Planning the storage arrays](#).
- Add more system memory to determine whether there is a performance improvement. Monitor memory usage regularly to determine whether more memory is required.

### Procedure

---

1. Release memory from the file system cache where possible.
2. To manage the system memory that is used by each server on a system, use the `DBMEMPERCENT` server option. Limit the percentage of system memory that can be used by the database manager of each server. If all servers are equally important, use the same value for each server. If one server is a production server and other servers are test servers, set the value for the production server to a higher value than the test servers.
3. Set the user data limit and private memory for the database to ensure that private memory is not exhausted. Exhausting private memory can result in errors, less than optimal performance, and instability.

## Tuning scheduled activities

---

Schedule maintenance tasks daily to ensure that your solution operates correctly. By tuning your solution, you maximize server resources and effectively use different functions available within your solution.

### Procedure

---

1. Monitor system performance regularly to ensure that backup and maintenance tasks are completing successfully. For more information about monitoring, see [Monitoring a single-site disk solution](#).
2. If the monitoring information shows that the server workload increased, you might need to review the planning information. Review whether the capacity of the system is adequate in the following cases:
  - The number of clients increases
  - The amount of data that is being backed up increases
  - The amount of time that is available for backups changes
3. Determine whether your solution has performance issues. Review the client schedules to check whether tasks are completing within the scheduled time frame:
  - a. On the Clients page of the Operations Center, select the client.
  - b. Click Details.
  - c. From the client Summary page, review the Backed up and Replicated activity to identify any risks. Adjust the time and frequency of client backup operations, if necessary.
4. Schedule enough time for the following maintenance tasks to complete successfully within a 24-hour period:
  - a. Back up the database
  - b. Run expiration to remove client backups and archive file copies from server storage.

**Related concepts:**

- 🔗 [Performance](#)

**Related tasks:**

- 🔗 [Deduplicating data \(V7.1.1\)](#)

## Securing the IBM Spectrum Protect server

---

Secure the IBM Spectrum Protect™ server and data by controlling access to servers and client nodes, encrypting data, and maintaining secure access levels and passwords.

- Security concepts  
You can protect IBM Spectrum Protect from security risks by using communication protocols, securing passwords, and providing different access levels for administrators.
- Managing administrators  
An administrator who has system authority can complete any task with the IBM Spectrum Protect server, including assigning authority levels to other administrators. To complete some tasks, you must be granted authority by being assigned one or more authority levels.
- Changing password requirements  
You can change the minimum password limit, password length, password expiration, and enable or disable authentication for IBM Spectrum Protect.
- Securing the server on the system  
Protect the system where the IBM Spectrum Protect server runs to prevent unauthorized access.

## Security concepts

---

You can protect IBM Spectrum Protect™ from security risks by using communication protocols, securing passwords, and providing different access levels for administrators.

### Transport Layer Security

---

You can use the Secure Sockets Layer (SSL) or the Transport Layer Security (TLS) protocol to provide transport layer security for a secure connection between servers, clients, and storage agents. If you send data between the server, client, and storage agent, use SSL or TLS to encrypt the data.

Tip: Any IBM Spectrum Protect documentation that indicates "SSL" or to "select SSL" applies to TLS.

SSL is provided by the Global Security Kit (GSKit) that is installed with the IBM Spectrum Protect server that the server, client, and storage agent use.

Restriction: Do not use the SSL or TLS protocols for communications with a DB2® database instance that is used by any IBM Spectrum Protect servers.

Each server, client, or storage agent that enables SSL must use a trusted self-signed certificate or obtain a unique certificate that is signed by a certificate authority (CA). You can use your own certificates or purchase certificates from a CA. Either certificate must be installed and added to the key database on the IBM Spectrum Protect server, client, or storage agent. The certificate is verified by the SSL client or server that requests or initiates the SSL communication. Some CA certificates are preinstalled in the key databases, by default.

SSL is set up independently on the IBM Spectrum Protect server, client, and storage agent.

### Authority levels

---

With each IBM Spectrum Protect server, different administrative authority levels are available that determine the tasks that an administrator can complete.

After registration, an administrator must be granted authority by being assigned one or more administrative authority levels. An administrator with system authority can complete any task with the server and assign authority levels to other administrators by using the GRANT AUTHORITY command. Administrators with policy, storage, or operator authority can complete subsets of tasks.

An administrator can register other administrator IDs, grant levels of authority to them, rename IDs, remove IDs, and lock and unlock them from the server.

An administrator can control access to specific client nodes for root user IDs and non-root user IDs. By default, a non-root user ID cannot back up data on the node. Use the UPDATE NODE command to change the node settings to enable backup.

### Passwords

---

By default, the server automatically uses password authentication. With password authentication, all users must enter a password when they access the server.

Use Lightweight Directory Access Protocol (LDAP) to apply stricter requirements for passwords. For more information, see [Managing passwords and logon procedures \(V7.1.1\)](#).

Table 1. Password authentication characteristics

Characteristic	More information
Case-sensitivity	Not case-sensitive.
Default password expiration	90 days.  The expiration period begins when an administrator ID or client node is first registered to the server. If the password is not changed within this period, the password must be changed the next time that the user accesses the server.
Invalid password attempts	You can set a limit on consecutive invalid password attempts for all client nodes. When the limit is exceeded, the server locks the node.
Password length	The administrator can specify a minimum length.

## Session security

Session security is the level of security that is used for communication among IBM Spectrum Protect client nodes, administrative clients, and servers and is set by using the SESSIONSECURITY parameter.

The SESSIONSECURITY parameter can be set to one of the following values:

- The STRICT value enforces the highest level of security for communication between IBM Spectrum Protect servers, nodes, and administrators.
- The TRANSITIONAL value specifies that the existing communication protocol is used while you update your IBM Spectrum Protect software to V8.1.2 or later. This is the default. When SESSIONSECURITY=TRANSITIONAL, stricter security settings are automatically enforced as higher versions of the TLS protocol are used and as the software is updated to V8.1.2 or later. After a node, administrator, or server meets the requirements for the STRICT value, session security is automatically updated to the STRICT value, and the entity can no longer authenticate by using a previous version of the client or earlier TLS protocols.

For more information about the SESSIONSECURITY parameter values, see the following commands.

Table 2. Commands used to set the SESSIONSECURITY parameter

Entity	Command
Client nodes	<ul style="list-style-type: none"> <li>• REGISTER NODE</li> <li>• UPDATE NODE</li> </ul>
Administrators	<ul style="list-style-type: none"> <li>• REGISTER ADMIN</li> <li>• UPDATE ADMIN</li> </ul>
Servers	<ul style="list-style-type: none"> <li>• DEFINE SERVER</li> <li>• UPDATE SERVER</li> </ul>

Administrators that authenticate by using the DSMADMC command, DSMC command, or dsm program cannot authenticate by using an earlier version after authenticating by using V8.1.2 or later. To resolve authentication issues for administrators, see the following tips:

Tips:

- Ensure that all IBM Spectrum Protect software that the administrator account uses to log on is upgraded to V8.1.2 or later. If an administrator account logs on from multiple systems, ensure that the server's certificate is installed on each system.
- After an administrator authenticates to a V8.1.2 or later server by using a V8.1.2 or later client, the administrator can authenticate only on clients or servers that are using V8.1.2 or later. An administrator command can be issued from any system.
- If necessary, create a separate administrator account to use only with clients and servers that are using V8.1.1 or earlier software.

Enforce the highest level of security for communication with the IBM Spectrum Protect server by ensuring that all nodes, administrators, and servers use STRICT session security. You can use the SELECT command to determine which servers, nodes, and administrators are using TRANSITIONAL session security and should be updated to use STRICT session security.

**Related tasks:**

[↗ Securing communications](#)

## Managing administrators

---

An administrator who has system authority can complete any task with the IBM Spectrum Protect™ server, including assigning authority levels to other administrators. To complete some tasks, you must be granted authority by being assigned one or more authority levels.

### Procedure

---

Complete the following tasks to modify administrator settings.

Task	Procedure
Add an administrator.	To add an administrator, ADMIN1, with system authority and specify a password, complete the following steps:  a. Register the administrator and specify Pa\$#\$twO as the password by issuing the following command: <pre>register admin admin1 Pa\$#\$twO</pre> b. Grant system authority to the administrator by issuing the following command: <pre>grant authority admin1 classes=system</pre>
Change administrative authority.	Change the authority level for an administrator, ADMIN1. <ul style="list-style-type: none"><li>Grant system authority to the administrator by issuing the following command: <pre>grant authority admin1 classes=system</pre></li><li>Revoke system authority for the administrator by issuing the following command: <pre>revoke authority admin1 classes=system</pre></li></ul>
Remove administrators.	Remove an administrator, ADMIN1, from accessing the IBM Spectrum Protect server by issuing the following command: <pre>remove admin admin1</pre>
Temporarily prevent access to the server.	Lock or unlock an administrator by using the LOCK ADMIN or UNLOCK ADMIN command.

## Changing password requirements

---

You can change the minimum password limit, password length, password expiration, and enable or disable authentication for IBM Spectrum Protect™.

### About this task

---

By enforcing password authentication and managing password restrictions, you protect your data and your servers from potential security risks.

### Procedure

---

Complete the following tasks to change password requirements for IBM Spectrum Protect servers.

Table 1. Authentication tasks for IBM Spectrum Protect servers

Task	Procedure
Set a limit for invalid password attempts.	<ol style="list-style-type: none"> <li>On the Servers page in the Operations Center, select the server.</li> <li>Click Details, and then click the Properties tab.</li> <li>Set the number of invalid attempts in the Invalid sign-on attempt limit field.</li> </ol> <p>The default value at installation is 0.</p>
Set a minimum length for passwords.	<ol style="list-style-type: none"> <li>On the Servers page in the Operations Center, select the server.</li> <li>Click Details and then click the Properties tab.</li> <li>Set the number of characters in the Minimum password length field.</li> </ol>
Set the expiration period for passwords.	<ol style="list-style-type: none"> <li>On the Servers page in the Operations Center, select the server.</li> <li>Click Details and then click the Properties tab.</li> <li>Set the number of days in the Password common expiration field.</li> </ol>
Disable password authentication.	<p>By default, the server automatically uses password authentication. With password authentication, all users must enter a password to access the server.</p> <p>You can disable password authentication only for passwords that authenticate with the server (LOCAL). By disabling password authentication, you increase the security risk for the server.</p>
Set a default authentication method.	<p>Issue the SET DEFAULTAUTHENTICATION command. For example, to use the server as the default authentication method, issue the following command:</p> <pre>set defaultauthentication local</pre> <p>To update one client node to authenticate with the server, include AUTHENTICATION=LOCAL in the UPDATE NODE command:</p> <pre>update node authentication=local</pre>

**Related concepts:**

- [Authenticating IBM Spectrum Protect users by using an LDAP server](#)
- [Managing passwords and logon procedures \(V7.1.1\)](#)

## Securing the server on the system

Protect the system where the IBM Spectrum Protect™ server runs to prevent unauthorized access.

### Procedure

Ensure that unauthorized users cannot access the directories for the server database and the server instance. Keep the access settings for these directories that you configured during implementation.

- Restricting user access to the server
  - Authority levels determine what an administrator can do with the IBM Spectrum Protect server. An administrator with system authority can complete any task with the server. Administrators with policy, storage, or operator authority can complete subsets of tasks.

- Limiting access through port restrictions  
Limit access to the server by applying port restrictions.

## Restricting user access to the server

Authority levels determine what an administrator can do with the IBM Spectrum Protect™ server. An administrator with system authority can complete any task with the server. Administrators with policy, storage, or operator authority can complete subsets of tasks.

### Procedure

1. After you register an administrator by using the REGISTER ADMIN command, use the GRANT AUTHORITY command to set the administrator's authority level. For details about setting and changing authority, see Managing administrators.
2. To control the authority of an administrator to complete some tasks, use the following two server options:
  - a. You can select the authority level that an administrator must have to issue QUERY and SELECT commands with the QUERYAUTH server option. By default, no authority level is required. You can change the requirement to one of the authority levels, including system.
  - b. You can specify that system authority is required for commands that cause the server to write to an external file with the REQSYSAUTHOUTFILE server option. By default, system authority is required for such commands.
3. You can restrict data backup on a client node to only root user IDs or authorized users. For example, to limit backups to the root user ID, issue the REGISTER NODE or UPDATE NODE command and specify the BACKUPINITIATION=root parameter:

```
update node backupinitiation=root
```

## Limiting access through port restrictions

Limit access to the server by applying port restrictions.

### About this task

You might have to restrict access to specific servers, based on your security requirements. The IBM Spectrum Protect™ server can be configured to listen on four TCP/IP ports: two that can be used for either regular TCP/IP protocols or Secure Sockets Layer (SSL)/Transport Layer Security (TLS) protocols and two that can be used only for the SSL/TLS protocol.

### Procedure

You can set the server options to specify the port that you require, as listed in Table 1.

Table 1. Server options and port access

Server option	Port access
TCPPORT	Specifies the port number on which the server TCP/IP communication driver is to wait for requests for client sessions. This port listens for both TCP/IP and SSL-enabled sessions. The default value is 1500.
TCPADMINPORT	Specifies the port number on which the server TCP/IP communication driver is to wait for requests for sessions other than client sessions. This port listens for both TCP/IP and SSL-enabled sessions. The default is the value of TCPPORT.  Use this option to separate administrative client traffic from regular client traffic that uses the TCPPORT and SSLTCPSPORT options.
SSLTCPSPORT	Specifies the SSL TCP/IP port address for a server. This port listens for SSL-enabled sessions only. A default port value is not available.
SSLTCPADMINPORT	Specifies the port address on which the server TCP/IP communication driver waits for requests for SSL-enabled sessions. A default port value is not available.  Use this option to separate administrative client traffic from regular client traffic that uses the TCPPORT and SSLTCPSPORT options.

**Related reference:**

Planning firewall access



# Stopping and starting the server

---

Before you complete maintenance or reconfiguration tasks, stop the server. Then, start the server in maintenance mode. When you are finished with the maintenance or reconfiguration tasks, restart the server in production mode.

## Before you begin

---

You must have system or operator privilege to stop and start the IBM Spectrum Protect™ server.

- Stopping the server  
Before you stop the server, prepare the system by ensuring that all database backup operations are completed, and all other processes and sessions are ended. In this way, you can safely shut down the server and ensure that data is protected.
- Starting the server for maintenance or reconfiguration tasks  
Before you begin server maintenance or reconfiguration tasks, start the server in maintenance mode. When you start the server in maintenance mode, you disable operations that might disrupt your maintenance or reconfiguration tasks.

## Stopping the server

---

Before you stop the server, prepare the system by ensuring that all database backup operations are completed, and all other processes and sessions are ended. In this way, you can safely shut down the server and ensure that data is protected.

## About this task

---

When you issue the HALT command to stop the server, the following actions occur:

- All processes and client node sessions are canceled.
- All current transactions are stopped. (The transactions will be rolled back when the server is restarted.)

## Procedure

---

To prepare the system and stop the server, complete the following steps:

1. Prevent new client node sessions from starting by issuing the DISABLE SESSIONS command:

```
disable sessions all
```

2. Determine whether any client node sessions or processes are in progress by completing the following steps:
  - a. On the Overview page of the Operations Center, view the Activity area for the total numbers of processes and sessions that are currently active. If numbers differ significantly from the usual numbers that are displayed during your daily storage-management routine, view other status indicators in the Operations Center to check whether there is a problem.
  - b. View the graph in the Activity area to compare the amount of network traffic over the following periods:
    - The current period, that is, the most recent 24-hour period
    - The previous period, that is, the 24 hours before the current periodIf the graph for the previous period represents the expected amount of traffic, significant differences on the graph for the current period might indicate a problem.
  - c. On the Servers page, select a server for which you want to view processes and sessions, and click Details. If the server is not registered as a hub or spoke server in the Operations Center, obtain information about processes by using administrative commands. Issue the QUERY PROCESS command to query processes and obtain information about sessions by issuing the QUERY SESSION command.
3. Wait until the client node sessions are completed or cancel them. To cancel processes and sessions, complete the following steps:
  - On the Servers page, select a server for which you want to view processes and sessions, and click Details.
  - Click the Active Tasks tab, and select one or more processes, sessions, or a combination of both that you want to cancel.
  - Click Cancel.
  - If the server is not registered as a hub or spoke server in the Operations Center, cancel sessions by using administrative commands. Issue the CANCEL SESSION command to cancel a session and cancel processes by using the CANCEL PROCESS command.

Tip: If the process that you want to cancel is waiting for a tape volume to be mounted, the mount request is canceled. For example, if you issue an EXPORT, IMPORT, or MOVE DATA command, the command might initiate a

process that requires a tape volume to be mounted. However, if a tape volume is being mounted by an automated library, the cancel operation might not take effect until the mount process is complete. Depending on your system environment, this could take several minutes.

4. Stop the server by issuing the HALT command:

```
halt
```

## Starting the server for maintenance or reconfiguration tasks

---

Before you begin server maintenance or reconfiguration tasks, start the server in maintenance mode. When you start the server in maintenance mode, you disable operations that might disrupt your maintenance or reconfiguration tasks.

### About this task

---

Start the server in maintenance mode by running the DSMSEV utility with the MAINTENANCE parameter.

The following operations are disabled in maintenance mode:

- Administrative command schedules
- Client schedules
- Reclamation of storage space on the server
- Inventory expiration
- Migration of storage pools

In addition, clients are prevented from starting sessions with the server.

Tips:

- You do not have to edit the server options file, `dsmserv.opt`, to start the server in maintenance mode.
- While the server is running in maintenance mode, you can manually start the storage-space reclamation, inventory expiration, and storage-pool migration processes.

### Procedure

---

To start the server in maintenance mode, issue the following command:

```
dsmserv maintenance
```

Tip: To view a video about starting the server in maintenance mode, see [Starting a server in maintenance mode](#).

### What to do next

---

To resume server operations in production mode, complete the following steps:

1. Shut down the server by issuing the HALT command:

```
halt
```

2. Start the server by using the method that you use in production mode. Follow the instructions for your operating system:

- o **AIX** Starting the server instance
- o **Linux** Starting the server instance
- o **Windows** Starting the server instance

Operations that were disabled during maintenance mode are reenabled.

## Planning to upgrade the server

---

When a fix pack or interim fix becomes available, you can upgrade the IBM Spectrum Protect™ server to take advantage of product improvements. Servers and clients can be upgraded at different times. Ensure that you complete the planning steps before you upgrade the server.

### About this task

---

Follow these guidelines:

- The preferred method is to upgrade the server by using the installation wizard. After you start the wizard, in the IBM Installation Manager window, click the Update icon; do not click the Install or Modify icon.
- If upgrades are available for both the server component and the Operations Center component, select the check boxes to upgrade both components.

## Procedure

---

1. Review the list of fix packs and interim fixes. See technote 1239415.
2. Review product improvements, which are described in readme files.  
Tip: When you obtain the installation package file from the IBM Spectrum Protect support site, you can also access the readme file.
3. Ensure that the version that you upgrade your server to is compatible with other components, such as storage agents and library clients. See technote 1302789.
4. If your solution includes servers or clients at a level that is earlier than V7.1, review the guidelines to ensure that client backup and archive operations are not disrupted. See technote 1053218.
5. Review the upgrade instructions. Ensure that you back up the server database, the device configuration information, and the volume history file.

## What to do next

---

To install a fix pack or interim fix, follow the instructions for your operating system:

- **AIX** Installing an IBM Spectrum Protect server fix pack
- **Linux** Installing an IBM Spectrum Protect server fix pack
- **Windows** Installing an IBM Spectrum Protect server fix pack

### Related information:

[Upgrade and Migration Process - Frequently Asked Questions](#)

## Preparing for an outage or system update

---

Prepare IBM Spectrum Protect™ to maintain your system in a consistent state during a planned power outage or system update.

### About this task

---

Ensure that you schedule activities regularly to manage, protect, and maintain the server.

## Procedure

---

1. Cancel processes and sessions that are in progress by completing the following steps:
  - a. In the Operations Center, on the Servers page, select a server for which you want to view processes and sessions, and click Details.
  - b. Click the Active Tasks tab, and select one or more processes, sessions, or a combination of both that you want to cancel.
  - c. Click Cancel.
2. Stop the server by issuing the HALT command:

```
halt
```

Tip: You can issue the halt command from the Operations Center by hovering over the Settings icon and clicking Command Builder. Then, select the server, type `halt`, and press Enter.

## Implementing a disaster recovery plan

---

Implement a disaster recovery strategy to recover your applications if a disaster occurs and to ensure high server availability.

### About this task

---

Determine your disaster recovery requirements by identifying the business priorities for client node recovery, the systems that you use to recover data, and whether client nodes have connectivity to a recovery server. Use replication and storage pool protection to protect data. You must also determine how often directory-container storage pools are protected.

- Completing recovery drills  
Schedule disaster recovery drills to prepare for audits that certify the recoverability of the IBM Spectrum Protect server and to ensure that data can be restored and operations can resume after an outage. A drill also helps you ensure that all data can be restored and operations resumed before a critical situation occurs.

## Recovering from system outages

For IBM Spectrum Protect™ single-site disk solutions, you can recover the inventory locally only and restore the database to protect your data.

### Procedure

Use one of the following methods to recover inventory to a local site, based on the type of information that is backed up. Restriction: Because single-site disk solutions do not have a second copy of the storage pool, you cannot restore storage pools. To review the architecture of disk solutions, see [Selecting an IBM Spectrum Protect solution](#).

Table 1. Scenarios for recovering from a disaster

Scenario	Procedure
Your system is inaccessible and you want to locally restore to an earlier version by using system tools.	<ul style="list-style-type: none"> <li>• Use IBM Spectrum Protect to back up the server to another server.</li> <li>• Use operating system tools to back up and restore your system to an earlier version.</li> </ul>
An outage or disaster occurs and you want to restore your data from backed up versions of the data.	<ul style="list-style-type: none"> <li>• To back up a client, on the TSM Clients page of the Operations Center, select the clients that you want to back up, and click Back Up.</li> <li>• On the TSM Servers page of the Operations Center, select the server whose database you want to back up. Click Back Up, and follow the instructions in the Back Up Server Database window.</li> </ul> <p>To restore a storage pool from a backed-up version of the storage pool, you must restore the database. Issue the DSMSERV RESTORE DB command to restore the database and associated storage pools to a backed-up version.</p>

- Restoring the database  
You might have to restore the IBM Spectrum Protect database after a disaster. You can restore the database to the most current state or to a specified point in time. You must have full, incremental, or snapshot database backup volumes to restore the database.

**Related reference:**

- 🔗 [AUDIT CONTAINER](#) (Verify the consistency of database information for a directory-container storage pool)
- 🔗 [DSMSERV RESTORE DB](#) (Restore the database)

## Multisite disk solution

This data protection solution provides replication at multiple sites so that each server protects data for the other site.

- Planning for a multisite disk data protection solution  
Plan for a multisite disk data protection solution with servers at two sites that use data deduplication and replication.
- Multisite disk implementation of a data protection solution  
The multisite disk solution is configured at two sites and uses data deduplication and replication.
- Monitoring a multisite disk solution  
After you implement a multisite disk solution with IBM Spectrum Protect, monitor the solution to ensure correct operation. By monitoring the solution daily and periodically, you can identify existing and potential issues. The information that you gather can be used to troubleshoot problems and optimize system performance.

- Managing operations for a multisite disk solution  
Use this information to manage operations for a multisite disk solution with IBM Spectrum Protect that includes a server and uses data deduplication for multiple locations.

## Planning for a multisite disk data protection solution

Plan for a multisite disk data protection solution with servers at two sites that use data deduplication and replication.

### Implementation methods

You can configure servers for a multisite disk solution in the following ways:

Configure servers by using the Operations Center and administrative commands

You can configure a range of storage systems and the server software for your solution. Configuration tasks are completed by using wizards and options in the Operations Center and IBM Spectrum Protect™ commands. For information about getting started, see the Planning roadmap.

Configure the servers by using automated scripts

For detailed guidance on configuration with specific IBM® Storwize® storage systems, and by using automated scripts to configure each server, see the IBM Spectrum Protect blueprints. The documentation and scripts are available on IBM developerWorks® at IBM Spectrum Protect Blueprints.

The blueprint documentation does not include steps for installing and configuring the Operations Center, or setting up secure communications by using Transport Security Layer (TLS). Replication is configured by using commands after each server is set up. An option for using Elastic Storage Server, based on IBM Spectrum Scale™ technology, is included.

### Planning roadmap

Plan for a multisite disk solution by reviewing the architecture layout in the following figure and then completing the roadmap tasks that follow the diagram.

Figure 1. Multisite disk solution

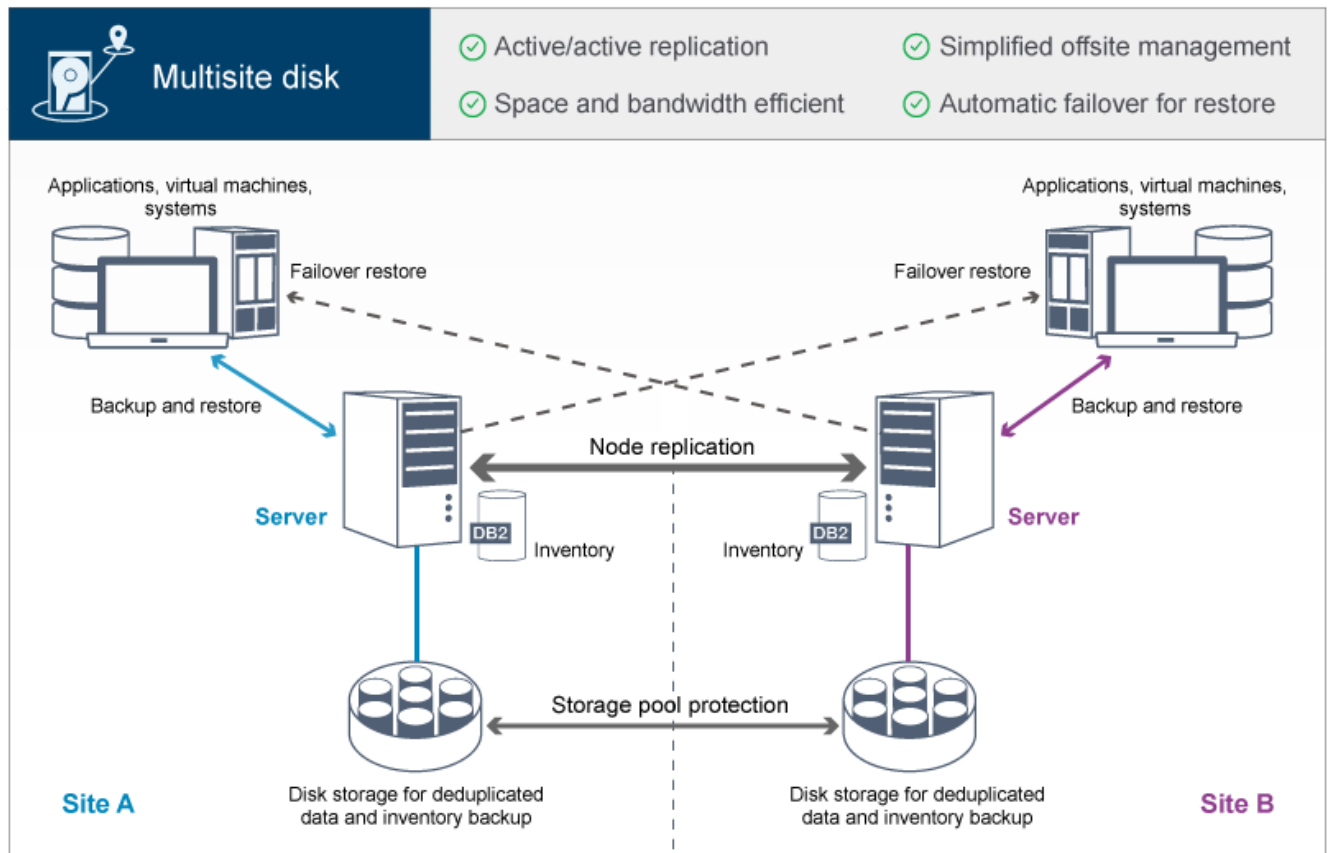

The following steps are required to plan properly for a multisite disk environment.

1. Select your system size.

2. Plan for the sites.
3. Meet system requirements for hardware and software.
4. Record values for your system configuration in the planning worksheets.
5. Plan for storage.
6. Plan for security.
  - a. Plan for administrator roles.
  - b. Plan for secure communications.
  - c. Plan for storage of encrypted data.
  - d. Plan for firewall access.

## Selecting a system size

---

Select the size of the IBM Spectrum Protect™ server based on the amount of data that you manage and the systems to be protected.

### About this task

---

You can use the information in the table to determine the size of the server that is required, based on the amount of data that you manage.

The following table describes the volume of data that a server manages. This amount includes all versions. The daily amount of data is how much new data you back up each day. Both the total managed data and daily amount of new data are measured as the size before any data reduction.

Table 1. Determining the size of the server

Total managed data	Daily amount of new data to back up	Required server size
48 TB - 192 TB	Up to 10 TB per day	Small
200 TB - 800 TB	10 - 20 TB per day	Medium
1000 TB - 4000 TB	20 - 100 TB per day	Large

The daily backup values in the table are based on test results with 128 MB sized objects, which are used by IBM Spectrum Protect for Virtual Environments. Workloads that consist of objects that are smaller than 128 KB might not be able to achieve these daily limits.

## Planning the sites

---

Review use cases and evaluate the factors to provide the most efficient data protection for the multisite disk solution for IBM Spectrum Protect™.

### Use cases

---

The multisite disk solution creates at least one copy of backed-up data. If the IBM Spectrum Protect servers are at separate locations, the backed-up replica is maintained offsite. Although your company might benefit from a multisite disk solution for various reasons, the most common reasons to use a multisite disk solution include the following replication scenarios:

Replication from the primary site to the disaster recovery site

In this scenario, data that is backed up from the primary site, Site A, is replicated to a server at the secondary, disaster recovery site, Site B. If a disaster occurs at Site A, such as failure of the server, you can use the server at Site B to recover systems. Alternatively, you can use the server at Site A to restore primary storage pool data at Site B, such as after a disk storage failure at Site B.

Mutual replication at two active sites

In this scenario, local data at each site is backed up by the servers at both Site A and Site B. Data that is backed up from Site A is replicated to Site B, and backed-up data from Site B is replicated to Site A. If data that was backed up is lost at Site A, you can use the server at Site B to recover storage pool data to the server at Site A. If Site A is no longer available, you can recover the replicated data for Site A to a new system at Site B. You must size the server resources to ensure that either server has sufficient capacity to back up and restore all client nodes as part of your disaster recovery plan.

Protect remote servers to the primary site

In this scenario, you configure remote servers that are relatively small to replicate data that is backed up to a larger server at the primary site. If bandwidth is limited, it might not be practical to restore systems to the remote sites. In this case, you might want to recover systems at the primary site before you replicate the backed-up data to the remote servers.

## Factors to evaluate

---

Before you implement a multisite disk solution, evaluate the following factors:

### Network bandwidth

The network must have sufficient bandwidth for the expected data transfers between nodes, for replication, and for the cross-site restore operations that are required for disaster recovery. Before you proceed with testing replication throughput, ensure that your network can handle the replication traffic. Calculate the required network bandwidth for the steady-state requirement by applying the guidelines in *Estimating network bandwidth required for replication (V7.1.1)*.

The network connection is often a shared resource. Plan the time of day to schedule node replication to run to avoid a conflict with other resource users. Also, network controls might limit activity to only a portion of the bandwidth. There are no controls in IBM Spectrum Protect to restrict network usage.

### Resources for the initial replication

To set up the data protection solution across two sites, you must replicate data initially from Site A to the target server at Site B. To ensure that the initial replication is successful, you must determine whether you have the network bandwidth, processor resources, and time available to replicate the data. You might have to plan for replicating the initial full backups across several days. If you cannot extend the schedule for the initial backups, you can replicate data from Site A to Site B without using the network. For example, you can export and import the backed-up data by using media or you can temporarily locate the source and target servers on the same site.

### Daily data ingestion

For the multisite disk solution, the daily data ingestion and total data retention must be within the capacity of the configurations. For example, a large configuration has a data ingestion capacity of up to 100 TB per day, including node replication. In cases where the backup requirements exceed the capacity of a single server, you can configure a solution that uses multiple servers to achieve the required capacity.

### Server configuration

The server configuration must meet or exceed the requirements for the multisite disk solution.

### Single replica of backed-up data

The multisite disk solution is most efficient when a single, offsite copy of the backed-up data meets your data protection and risk mitigation requirements. In this case, the single copy of the data is maintained off-site at the location of a replication server.

### Related reference:

[System requirements for a multisite disk solution](#)

## System requirements for a multisite disk solution

---

After you select the IBM Spectrum Protect™ solution that best fits your data protection requirements, review the system requirements to plan for implementation of the data protection solution.

Ensure that your system meets the hardware and software prerequisites for the size of server that you plan to use.

- **Hardware requirements**  
Hardware requirements for your IBM Spectrum Protect solution are based on system size. Choose equivalent or better components than those items that are listed to ensure optimum performance for your environment.
- **Software requirements**  
Documentation for the IBM Spectrum Protect multisite disk solution includes installation and configuration tasks for the following operating systems. You must meet the minimum software requirements that are listed.

### Related information:

[IBM Spectrum Protect Supported Operating Systems](#)

## Hardware requirements

Hardware requirements for your IBM Spectrum Protect™ solution are based on system size. Choose equivalent or better components than those items that are listed to ensure optimum performance for your environment.

For a definition of system sizes, see [Selecting a system size](#).

The following table includes minimum hardware requirements for the server and storage, based on the size of the server that you plan to build. If you are using local partitions (LPARs) or work partitions (WPARs), adjust the network requirements to take account of the partition sizes.

Hardware component	Small system	Medium system	Large system
Server processor	<p><b>AIX</b> 6 processor cores, 3.42 GHz or faster</p> <p><b>Linux</b>   <b>Windows</b> 12 processor cores, 1.9 GHz or faster</p>	<p><b>AIX</b> 8 processor cores, 3.42 GHz or faster</p> <p><b>Linux</b>   <b>Windows</b> 16 processor cores, 2.0 GHz or faster</p>	<p><b>AIX</b> 20 processor cores, 3.42 GHz</p> <p><b>Linux</b>   <b>Windows</b> 32 processor cores, 2.0 GHz or faster</p>
Server memory	64 GB RAM	128 GB RAM	192 GB RAM
Network	<ul style="list-style-type: none"> <li>10 GB Ethernet (1 port)</li> <li>8 GB Fibre Channel adapter (2 ports)</li> </ul>	<ul style="list-style-type: none"> <li>10 GB Ethernet (2 ports)</li> <li>8 GB Fibre Channel adapter (2 ports)</li> </ul>	<ul style="list-style-type: none"> <li>10 GB Ethernet (4 ports)</li> <li>8 GB Fibre Channel adapter (4 ports)</li> </ul>
Storage	<ul style="list-style-type: none"> <li>1.3 TB inventory, plus space for Operations Center records</li> <li>46 TB deduplicated directory-container storage pool</li> </ul>	<ul style="list-style-type: none"> <li>2 TB inventory, plus space for Operations Center records</li> <li>200 TB deduplicated directory-container storage pool</li> </ul>	<ul style="list-style-type: none"> <li>6 TB inventory, plus space for Operations Center records</li> <li>1000 TB deduplicated directory-container storage pool</li> </ul>

## Estimating database space requirements for the Operations Center

Hardware requirements for the Operations Center are included in the preceding table, except for the database and archive log space (inventory) that the Operations Center uses to hold records for managed clients.

If you do not plan to install the Operations Center on the same system as the server, you can estimate system requirements separately. To calculate system requirements for the Operations Center, see the system requirements calculator in technote 1641684.

Managing the Operations Center on the server is a workload that requires extra space for database operations. The amount of space depends on the number of clients that are monitored on a server. Review the following guidelines to estimate how much space your server requires.

### Database space

The Operations Center uses approximately 1.2 GB of database space for every 1000 clients that are monitored on a server. For example, consider a hub server with 2000 clients that also manages three spoke servers, each with 1500 clients. This configuration has a total of 6500 clients across the four servers and requires approximately 8.4 GB of database space. This value is calculated by rounding the 6500 clients up to the next closest 1000, which is 7000:

$$7 \times 1.2 \text{ GB} = 8.4 \text{ GB}$$

### Archive log space

The Operations Center uses approximately 8 GB of archive log space every 24 hours, for every 1000 clients. In the example of 6500 clients across the hub server and the spoke servers, 56 GB of archive log space is used over a 24-hour period for the hub server.

For each spoke server in the example, the archive log space that is used over 24 hours is approximately 16 GB. These estimates are based on the default status collection interval of 5 minutes. If you reduce the collection interval from once every 5 minutes to once every 3 minutes, the space requirements increase. The following examples show the approximate increase in the log space requirement with a collection interval of once every 3 minutes:



- Hub server: 56 GB to approximately 94 GB
- Each spoke server: 16 GB to approximately 28 GB

Increase the archive log space so that you have sufficient space available to support the Operations Center, without affecting the existing server operations.

## Hardware requirements for the second server

If you are planning to set up your sites so that everything at the first site is replicated to the second site, hardware requirements are identical at both sites. If you want to only replicate a subset of data to your second site, storage and network requirements might be reduced.

## Software requirements

Documentation for the IBM Spectrum Protect™ multisite disk solution includes installation and configuration tasks for the following operating systems. You must meet the minimum software requirements that are listed.

For information about software requirements for IBM® lin\_tape device drivers, refer to the IBM Tape Device Drivers Installation and User's Guide.

### AIX systems

Type of software	Minimum software requirements
Operating system	IBM AIX® 7.1  For more information about operating system requirements, see AIX: Minimum system requirements for AIX systems.
Gunzip utility	The gunzip utility must be available on your system before you install or upgrade the IBM Spectrum Protect server. Ensure that the gunzip utility is installed and the path to it is set in the PATH environment variable.
File system type	JFS2 file systems  AIX systems can cache a large amount of file system data, which can reduce memory that is required for server and IBM DB2® processes. To avoid paging with the AIX server, use the rbrw mount option for the JFS2 file system. Less memory is used for the file system cache and more is available for IBM Spectrum Protect.  Do not use the file system mount options, Concurrent I/O (CIO), and Direct I/O (DIO), for file systems that contain the IBM Spectrum Protect database, logs, or storage pool volumes. These options can cause performance degradation of many server operations. IBM Spectrum Protect and DB2 can still use DIO where it is beneficial to do so, but IBM Spectrum Protect does not require the mount options to selectively take advantage of these techniques.
Other software	Korn Shell (ksh)

### Linux systems

Type of software	Minimum software requirements
Operating system	Red Hat Enterprise Linux 7 (x86_64)
Libraries	GNU C libraries, Version 2.3.3-98.38 or later that is installed on the IBM Spectrum Protect system. Red Hat Enterprise Linux Servers: <ul style="list-style-type: none"> <li>• libaio</li> <li>• libstdc++.so.6 (32-bit and 64-bit packages are required)</li> <li>• numactl.x86_64</li> </ul>

Type of software	Minimum software requirements
File system type	Format database-related file systems with ext3 or ext4.  For storage pool-related file systems, use XFS.
Other software	Korn Shell (ksh)

## Windows systems

Type of software	Minimum software requirements
Operating system	Microsoft Windows Server 2012 R2 (64-bit) or Windows Server 2016
File system type	NTFS
Other software	Windows 2012 R2 or Windows 2016 with .NET Framework 3.5 is installed and enabled.  The following User Account Control policies must be disabled: <ul style="list-style-type: none"> <li>User Account Control: Admin Approval Mode for the Built-in Administrator account</li> <li>User Account Control: Run all administrators in Admin Approval Mode</li> </ul>

### Related tasks:

[Setting AIX network options](#)

## Planning worksheets

Use the planning worksheets to record values that you use to set up your system and configure the IBM Spectrum Protect™ server. Use the best practice default values that are listed in the worksheets.

Each worksheet helps you prepare for different parts of the system configuration by using best practice values:

### Server system preconfiguration

Use the preconfiguration worksheets to plan for the file systems and directories that you create when you configure file systems for IBM Spectrum Protect during system setup. All directories that you create for the server must be empty.

### Server configuration

Use the configuration worksheets when you configure the server. Default values are suggested for most items, except where noted.

## AIX®

Table 1. Worksheet for preconfiguration of an AIX server system

Item	Default value	Your value	Minimum directory size	Notes
TCP/IP port address for communications with the server	1500		Not applicable	Ensure that this port is available when you install and configure the operating system  The port number can be a number in the range 1024 - 32767.
Directory for the server instance	/home/tsminst1/tsminst1		50 GB	If you change the value for the server instance directory from the default, also modify the DB2® instance owner value in Table 2.

Item	Default value	Your value	Minimum directory size	Notes
Directory for server installation	/		Available space that is required for the directory: 5 GB	
Directory for server installation	/usr		Available space that is required for the directory: 5 GB	
Directory for server installation	/var		Available space that is required for the directory: 5 GB	
Directory for server installation	/tmp		Available space that is required for the directory: 5 GB	
Directory for server installation	/opt		Available space that is required for the directory: 10 GB	
Directory for the active log	/tsminst1/TSMalog		<ul style="list-style-type: none"> <li>• Small and medium: 140 GB</li> <li>• Large: 300 GB</li> </ul>	When you create the active log during the initial configuration of the server, set the size to 128 GB.
Directory for the archive log	/tsminst1/TSMarchlog		<ul style="list-style-type: none"> <li>• Small: 1 TB</li> <li>• Medium: 3 TB</li> <li>• Large: 4 TB</li> </ul>	
Directories for the database	/tsminst1/TSMdbspace00 /tsminst1/TSMdbspace01 /tsminst1/TSMdbspace02 /tsminst1/TSMdbspace03 ...		<p>Minimum total space for all directories:</p> <ul style="list-style-type: none"> <li>• Small: At least 1 TB</li> <li>• Medium: At least 2 TB</li> <li>• Large: At least 4 TB</li> </ul>	<p>Create a minimum number of file systems for the database, depending on the size of your system:</p> <ul style="list-style-type: none"> <li>• Small: At least 4 file systems</li> <li>• Medium: At least 4 file systems</li> <li>• Large: At least 8 file systems</li> </ul>
Directories for storage	/tsminst1/TSMfile00 /tsminst1/TSMfile01 /tsminst1/TSMfile02 /tsminst1/TSMfile03 ...		<p>Minimum total space for all directories:</p> <ul style="list-style-type: none"> <li>• Small: At least 38 TB</li> <li>• Medium: At least 180 TB</li> <li>• Large: At least 500 TB</li> </ul>	<p>Create a minimum number of file systems for storage, depending on the size of your system:</p> <ul style="list-style-type: none"> <li>• Small: At least 10 file systems</li> <li>• Medium: At least 20 file systems</li> <li>• Large: At least 40 file systems</li> </ul>

Item	Default value	Your value	Minimum directory size	Notes
Directories for database backup	/tsminst1/TSMbkup00 /tsminst1/TSMbkup01 /tsminst1/TSMbkup02 /tsminst1/TSMbkup03		Minimum total space for all directories: <ul style="list-style-type: none"> <li>• Small: At least 3 TB</li> <li>• Medium: At least 10 TB</li> <li>• Large: At least 16 TB</li> </ul>	<p>Create a minimum number of file systems for backing up the database, depending on the size of your system:</p> <ul style="list-style-type: none"> <li>• Small: At least 2 file systems</li> <li>• Medium: At least 4 file systems</li> <li>• Large: At least 4 file systems, but preferably 6</li> </ul> <p>The first database backup directory is also used for the archive log failover directory and a second copy of the volume history and device configuration files.</p>

Table 2. Worksheet for IBM Spectrum Protect configuration

Item	Default value	Your value	Notes
DB2 instance owner	tsminst1		If you changed the value for the server instance directory in Table 1 from the default, also modify the value for the DB2 instance owner.
DB2 instance owner password	passw0rd		Select a different value for the instance owner password than the default. Ensure that you record this value in a secure location.
Primary group for the DB2 instance owner	tsmsrvrs		
Server name	The default value for the server name is the system host name.		
Server password	passw0rd		Select a different value for the server password than the default. Ensure that you record this value in a secure location.
Administrator ID: user ID for the server instance	admin		
Administrator ID password	passw0rd		Select a different value for the administrator password than the default. Ensure that you record this value in a secure location.

Item	Default value	Your value	Notes
Schedule start time	22:00		<p>The default schedule start time begins the client workload phase, which is predominantly the client backup and archive activities. During the client workload phase, server resources support client operations. Normally, these operations are completed during the nightly schedule window.</p> <p>Schedules for server maintenance operations are defined to begin 10 hours after the start of the client backup window.</p>

## Linux

Table 3. Worksheet for preconfiguration of a Linux server system

Item	Default value	Your value	Minimum directory size	Notes
TCP/IP port address for communications with the server	1500		Not applicable	<p>Ensure that this port is available when you install and configure the operating system</p> <p>The port number can be a number in the range 1024 - 32767.</p>
Directory for the server instance	/home/tsminst1/tsminst1		25 GB	If you change the value for the server instance directory from the default, also modify the DB2 instance owner value in Table 4.
Directory for the active log	/tsminst1/TSMalog		<ul style="list-style-type: none"> <li>• Small and medium: 140 GB</li> <li>• Large: 300 GB</li> </ul>	
Directory for the archive log	/tsminst1/TSMarchlog		<ul style="list-style-type: none"> <li>• Small: 1 TB</li> <li>• Medium: 3 TB</li> <li>• Large: 4 TB</li> </ul>	

Item	Default value	Your value	Minimum directory size	Notes
Directories for the database	/tsminst1/TSMdbspace00 /tsminst1/TSMdbspace01 /tsminst1/TSMdbspace02 /tsminst1/TSMdbspace03 ...		Minimum total space for all directories: <ul style="list-style-type: none"> <li>• Small: At least 1 TB</li> <li>• Medium: At least 2 TB</li> <li>• Large: At least 4 TB</li> </ul>	Create a minimum number of file systems for the database, depending on the size of your system: <ul style="list-style-type: none"> <li>• Small: At least 4 file systems</li> <li>• Medium: At least 4 file systems</li> <li>• Large: At least 8 file systems</li> </ul>
Directories for storage	/tsminst1/TSMfile00 /tsminst1/TSMfile01 /tsminst1/TSMfile02 /tsminst1/TSMfile03 ...		Minimum total space for all directories: <ul style="list-style-type: none"> <li>• Small: At least 38 TB</li> <li>• Medium: At least 180 TB</li> <li>• Large: At least 500 TB</li> </ul>	Create a minimum number of file systems for storage, depending on the size of your system: <ul style="list-style-type: none"> <li>• Small: At least 10 file systems</li> <li>• Medium: At least 20 file systems</li> <li>• Large: At least 40 file systems</li> </ul>
Directories for database backup	/tsminst1/TSMbkup00 /tsminst1/TSMbkup01 /tsminst1/TSMbkup02 /tsminst1/TSMbkup03		Minimum total space for all directories: <ul style="list-style-type: none"> <li>• Small: At least 3 TB</li> <li>• Medium: At least 10 TB</li> <li>• Large: At least 16 TB</li> </ul>	Create a minimum number of file systems for backing up the database, depending on the size of your system: <ul style="list-style-type: none"> <li>• Small: At least 2 file systems</li> <li>• Medium: At least 4 file systems</li> <li>• Large: At least 4 file systems, but preferably 6</li> </ul> <p>The first database backup directory is also used for the archive log failover directory and a second copy of the volume history and device configuration files.</p>

Table 4. Worksheet for IBM Spectrum Protect configuration

Item	Default value	Your value	Notes
------	---------------	------------	-------

Item	Default value	Your value	Notes
DB2 instance owner	tsminst1		If you changed the value for the server instance directory in Table 3 from the default, also modify the value for the DB2 instance owner.
DB2 instance owner password	passw0rd		Select a different value for the instance owner password than the default. Ensure that you record this value in a secure location.
Primary group for the DB2 instance owner	tsmsrvrs		
Server name	The default value for the server name is the system host name.		
Server password	passw0rd		Select a different value for the server password than the default. Ensure that you record this value in a secure location.
Administrator ID: user ID for the server instance	admin		
Administrator ID password	passw0rd		Select a different value for the administrator password than the default. Ensure that you record this value in a secure location.
Schedule start time	22:00		The default schedule start time begins the client workload phase, which is predominantly the client backup and archive activities. During the client workload phase, server resources support client operations. Normally, these operations are completed during the nightly schedule window.  Schedules for server maintenance operations are defined to begin 10 hours after the start of the client backup window.

## Windows

Because many volumes are created for the server, configure the server by using the Windows feature of mapping disk volumes to directories rather than to drive letters.

For example, C:\tsminst1\TSMdbpsace00 is a mount point to a volume with its own space. The volume is mapped to a directory under the C: drive, but does not take up space from the C: drive. The exception is the server instance directory, C:\tsminst1, which can be a mount point or a regular directory.

Table 5. Worksheet for preconfiguration of a Windows server system

Item	Default value	Your value	Minimum directory size	Notes
------	---------------	------------	------------------------	-------

Item	Default value	Your value	Minimum directory size	Notes
TCP/IP port address for communications with the server	1500		Not applicable	Ensure that this port is available when you install and configure the operating system  The port number can be a number in the range 1024 - 32767.
Directory for the server instance	C:\tsminst1		25 GB	If you change the value for the server instance directory from the default, also modify the DB2 instance owner value in Table 6.
Directory for the active log	C:\tsminst1\TSMalog		<ul style="list-style-type: none"> <li>• Small and medium: 140 GB</li> <li>• Large: 300 GB</li> </ul>	
Directory for the archive log	C:\tsminst1\TSMarchlog		<ul style="list-style-type: none"> <li>• Small: 1 TB</li> <li>• Medium: 3 TB</li> <li>• Large: 4 TB</li> </ul>	
Directories for the database	C:\tsminst1\TSMdbspace00 C:\tsminst1\TSMdbspace01 C:\tsminst1\TSMdbspace02 C:\tsminst1\TSMdbspace03 ...		Minimum total space for all directories: <ul style="list-style-type: none"> <li>• Small: At least 1 TB</li> <li>• Medium: At least 2 TB</li> <li>• Large: At least 4 TB</li> </ul>	Create a minimum number of file systems for the database, depending on the size of your system: <ul style="list-style-type: none"> <li>• Small: At least 4 file systems</li> <li>• Medium: At least 4 file systems</li> <li>• Large: At least 8 file systems</li> </ul>
Directories for storage	C:\tsminst1\TSMfile00 C:\tsminst1\TSMfile01 C:\tsminst1\TSMfile02 C:\tsminst1\TSMfile03 ...		Minimum total space for all directories: <ul style="list-style-type: none"> <li>• Small: At least 38 TB</li> <li>• Medium: At least 180 TB</li> <li>• Large: At least 500 TB</li> </ul>	Create a minimum number of file systems for storage, depending on the size of your system: <ul style="list-style-type: none"> <li>• Small: At least 10 file systems</li> <li>• Medium: At least 20 file systems</li> <li>• Large: At least 40 file systems</li> </ul>



Item	Default value	Your value	Minimum directory size	Notes
Directories for database backup	C:\tsminst1\TSMbkup00 C:\tsminst1\TSMbkup01 C:\tsminst1\TSMbkup02 C:\tsminst1\TSMbkup03		Minimum total space for all directories: <ul style="list-style-type: none"> <li>• Small: At least 3 TB</li> <li>• Medium: At least 10 TB</li> <li>• Large: At least 16 TB</li> </ul>	Create a minimum number of file systems for backing up the database, depending on the size of your system: <ul style="list-style-type: none"> <li>• Small: At least 2 file systems</li> <li>• Medium: At least 4 file systems</li> <li>• Large: At least 4 file systems, but preferably 6</li> </ul> The first database backup directory is also used for the archive log failover directory and a second copy of the volume history and device configuration files.

Table 6. Worksheet for IBM Spectrum Protect configuration

Item	Default value	Your value	Notes
DB2 instance owner	tsminst1		If you changed the value for the server instance directory in Table 5 from the default, also modify the value for the DB2 instance owner.
DB2 instance owner password	pAssW0rd		Select a different value for the instance owner password than the default. Ensure that you record this value in a secure location.
Server name	The default value for the server name is the system host name.		
Server password	passw0rd		Select a different value for the server password than the default. Ensure that you record this value in a secure location.
Administrator ID: user ID for the server instance	admin		
Administrator ID password	passw0rd		Select a different value for the administrator password than the default. Ensure that you record this value in a secure location.

Item	Default value	Your value	Notes
Schedule start time	22:00		<p>The default schedule start time begins the client workload phase, which is predominantly the client backup and archive activities. During the client workload phase, server resources support client operations. Normally, these operations are completed during the nightly schedule window.</p> <p>Schedules for server maintenance operations are defined to begin 10 hours after the start of the client backup window.</p>

## Planning for storage

Choose the most effective storage technology for IBM Spectrum Protect™ components to ensure efficient server performance and operations.

Storage hardware devices have different capacity and performance characteristics, which determine how they can be used effectively with IBM Spectrum Protect. For general guidance on selecting the appropriate storage hardware and set up for your solution, review the following guidelines.

### Database and active log

- Use a fast disk for the IBM Spectrum Protect database and active log, for example with the following characteristics:
  - High performance, 15k rpm disk with Fibre Channel or serial-attached SCSI (SAS) interface
  - Solid-state disk (SSD)
- Isolate the active log from the database unless you use SSD or flash hardware
- When you create arrays for the database, use RAID level 5

### Storage pool

- You can use less expensive and slower disks for the storage pool
- The storage pool can share disks for the archive log and database backup storage
- Use RAID level 6 for storage pool arrays to add protection against double drive failures when you use large disk types
- Planning the storage arrays

Prepare for disk storage configuration by planning for RAID arrays and volumes, according to the size of your IBM Spectrum Protect system.

### Related reference:

[Storage system requirements and reducing the risk of data corruption](#)

## Planning for security

Plan to protect the security of systems in the IBM Spectrum Protect™ solution with access and authentication controls, and consider encrypting data and password transmission.

- Planning for administrator roles

Define the authority levels that you want to assign to administrators who have access to the IBM Spectrum Protect solution.
- Planning for secure communications

Plan for protecting communications among the IBM Spectrum Protect solution components.
- Planning for storage of encrypted data

Determine whether your company requires stored data to be encrypted, and choose the option that best suits your needs.

- Planning firewall access  
Determine the firewalls that are set and the ports that must be open for the IBM Spectrum Protect solution to work.

## Planning for administrator roles

Define the authority levels that you want to assign to administrators who have access to the IBM Spectrum Protect™ solution.

You can assign one of the following levels of authority to administrators:

### System

Administrators with system authority have the highest level of authority. Administrators with this level of authority can complete any task. They can manage all policy domains and storage pools, and grant authority to other administrators.

### Policy

Administrators who have policy authority can manage all of the tasks that are related to policy management. This privilege can be unrestricted, or can be restricted to specific policy domains.

### Storage

Administrators who have storage authority can allocate and control storage resources for the server.

### Operator

Administrators who have operator authority can control the immediate operation of the server and the availability of storage media such as tape libraries and drives.

The scenarios in Table 1 provide examples about why you might want to assign varying levels of authority so that administrators can perform tasks:

Table 1. Scenarios for administrator roles

Scenario	Type of administrator ID to set up
An administrator at a small company manages the server and is responsible for all server activities.	<ul style="list-style-type: none"> <li>• System authority: 1 administrator ID</li> </ul>
An administrator for multiple servers also manages the overall system. Several other administrators manage their own storage pools.	<ul style="list-style-type: none"> <li>• System authority on all servers: 1 administrator ID for the overall system administrator</li> <li>• Storage authority for designated storage pools: 1 administrator ID for each of the other administrators</li> </ul>
An administrator manages 2 servers. Another person helps with the administration tasks. Two assistants are responsible for helping to ensure that important systems are backed up. Each assistant is responsible for monitoring the scheduled backups on one of the IBM Spectrum Protect servers.	<ul style="list-style-type: none"> <li>• System authority on both servers: 2 administrator IDs</li> <li>• Operator authority: 2 administrator IDs for the assistants with access to the server that each person is responsible for</li> </ul>

## Planning for secure communications

Plan for protecting communications among the IBM Spectrum Protect™ solution components.

Determine the level of protection that is required for your data, based on regulations and business requirements under which your company operates.

If your business requires a high level of security for passwords and data transmission, plan on implementing secure communication with Transport Layer Security (TLS) or Secure Sockets Layer (SSL) protocols.

TLS and SSL provide secure communications between the server and client, but can affect system performance. To improve system performance, use TLS for authentication without encrypting object data. To specify whether the server uses TLS 1.2 for the entire session or only for authentication, see the SSL client option for client-to-server communication, and the UPDATE SERVER=SSL parameter for server-to-server communication. Beginning in V8.1.2, TLS is used for authentication by default. If you decide to use TLS to encrypt entire sessions, use the protocol only for sessions where it is necessary and add processor resources on the server to manage the increase in network traffic. You can also try other options. For example, some networking devices such as routers and switches provide the TLS or SSL function.

You can use TLS and SSL to protect some or all of the different possible communication paths, for example:

- Operations Center: browser to hub; hub to spoke
- Client to server

- Server to server: node replication

**Related tasks:**

[Securing communications](#)

## Planning for storage of encrypted data

Determine whether your company requires stored data to be encrypted, and choose the option that best suits your needs.

If your company requires the data in storage pools to be encrypted, then you have the option of using IBM Spectrum Protect™ encryption, or an external device such as tape for encryption.

If you choose IBM Spectrum Protect to encrypt the data, extra computing resources are required at the client that might affect the performance of backup and restore processes.

**Related information:**

[technote 1963635](#)

## Planning firewall access

Determine the firewalls that are set and the ports that must be open for the IBM Spectrum Protect™ solution to work.

Table 1 describes the ports that are used by the server, client, and Operations Center.

Table 1. Ports that are used by the server, client, and Operations Center

Item	Default	Direction	Description
Base port (TCPPOINT)	1500	Outbound/inbound	Each server instance requires a unique port. You can specify an alternative port number instead of using the default. The TCPPOINT option listens for both TCP/IP and SSL-enabled sessions from the client. For administrative client traffic, you can use the TCPADMINPORT and ADMINONCLIENTPORT options to set port values.
SSL-only port (SSLTCPPOINT)	No default	Outbound/inbound	This port is used if you want to restrict communication on the port to SSL-enabled sessions only. To support both SSL and non-SSL communications, use the TCPPOINT or TCPADMINPORT options.
SMB	45	Inbound/outbound	This port is used by configuration wizards that communicate by using native protocols with multiple hosts.
SSH	22	Inbound/outbound	This port is used by configuration wizards that communicate by using native protocols with multiple hosts.
SMTP	25	Outbound	This port is used to send email alerts from the server.
NDMP	No default	Inbound/outbound	<p>The server must be able to open an outbound NDMP control port connection to the NAS device. The outbound control port is the Low-Level Address in the data mover definition for the NAS device.</p> <p>During an NDMP filer-to-server restore, the server must be able to open an outbound NDMP data connection to the NAS device. The data connection port that is used during a restore can be configured on the NAS device.</p> <p>During NDMP filer-to-server backups, the NAS device must be able to open outbound data connections to the server and the server must be able to accept inbound NDMP data connections. You can use the server option NDMPPORTRANGE to restrict the set of ports available for use as NDMP data connections. You can configure a firewall for connections to these ports.</p>

Item	Default	Direction	Description
Replication	No default	Outbound/inbound	The port and protocol for the outbound port for replication are set by the DEFINE SERVER command that is used to set up replication.  The inbound ports for replication are the TCP ports and SSL ports that the source server names in the DEFINE SERVER command.
Client schedule port	Client port: 1501	Outbound	The client listens on the port that is named and communicates the port number to the server. The server contacts the client if server prompted scheduling is used. You can specify an alternative port number in the client options file.
Long running sessions	KEEPALIVE setting: YES	Outbound	When the KEEPALIVE option is enabled, keepalive packets are sent during client-server sessions to prevent the firewall software from closing long-running, inactive connections.
Operations Center	HTTPS: 11090	Inbound	These ports are used for the Operations Center web browser. You can specify an alternative port number.
Client management service port	Client port: 9028	Inbound	The client management service port must be accessible from the Operations Center. Ensure that firewalls cannot prevent connections. The client management service uses the TCP port of the server for the client node for authentication by using an administrative session.

## Multisite disk implementation of a data protection solution

The multisite disk solution is configured at two sites and uses data deduplication and replication.

### Implementation roadmap

The following steps are required to set up a multisite disk environment.

1. Set up the system.
  - a. Configure the storage hardware and set up storage arrays for your environment size.
  - b. Install the server operating system.
  - c. Configure multipath I/O.
  - d. Create the user ID for the server instance.
  - e. Prepare file systems for IBM Spectrum Protect.
2. Install the server and Operations Center.
3. Configure the server and Operations Center.
  - a. Complete the initial configuration of the server.
  - b. Set server options.
  - c. Configure Secure Sockets Layer for the server and client.
  - d. Configure the Operations Center.
  - e. Register your IBM Spectrum Protect license.
  - f. Configure data deduplication.
  - g. Define data retention rules for your business.
  - h. Define server maintenance schedules.
  - i. Define client schedules.
4. Install and configure clients.
  - a. Register and assign clients to schedules.
  - b. Install and verify the client management service.
  - c. Configure the Operations Center to use the client management service.
5. Configure the second server.
  - a. Configure for SSL communication between the hub and spoke server.
  - b. Add the second server as a spoke.
  - c. Enable replication.
6. Complete the implementation.

## Setting up the system

To set up the system, you must first configure your disk storage hardware and the server system for IBM Spectrum Protect™.

- **Configuring the storage hardware**  
To configure your storage hardware, review general guidance for disk systems and IBM Spectrum Protect.
- **Installing the server operating system**  
Install the operating system on the server system and ensure that IBM Spectrum Protect server requirements are met. Adjust operating system settings as directed.
- **Configuring multipath I/O**  
You can enable and configure multipathing for disk storage. Use the documentation that is provided with your hardware for detailed instructions.
- **Creating the user ID for the server**  
Create the user ID that owns the IBM Spectrum Protect server instance. You specify this user ID when you create the server instance during initial configuration of the server.
- **Preparing file systems for the server**  
You must complete file system configuration for the disk storage to be used by the server.

## Configuring the storage hardware

---

To configure your storage hardware, review general guidance for disk systems and IBM Spectrum Protect™.

### Procedure

---

1. Provide a connection between the server and the storage devices by following these guidelines:
  - Use a switch or direct connection for Fibre Channel connections.
  - Consider the number of ports that are connected and account for the amount of bandwidth that is needed.
  - Consider the number of ports on the server and the number of host ports on the disk system that are connected.
2. Verify that device drivers and firmware for the server system, adapters, and operating system are current and at the recommended levels.
3. Configure storage arrays. Make sure that you planned properly to ensure optimal performance. See *Planning for storage* for more information.
4. Ensure that the server system has access to disk volumes that are created. Complete the following steps:
  - a. If the system is connected to a Fibre Channel switch, zone the server to see the disks.
  - b. Map all of the volumes to tell the disk system that this specific server is allowed to see each disk.

#### Related tasks:

[↗ Configuring storage](#)

## Installing the server operating system

---

Install the operating system on the server system and ensure that IBM Spectrum Protect™ server requirements are met. Adjust operating system settings as directed.

- **Installing on AIX systems**  
Complete the following steps to install AIX® on the server system.
- **Installing on Linux systems**  
Complete the following steps to install Linux x86\_64 on the server system.
- **Installing on Windows systems**  
Install Microsoft Windows Server 2012 Standard Edition on the server system and prepare the system for installation and configuration of the IBM Spectrum Protect server.

## Installing on AIX systems

---

Complete the following steps to install AIX® on the server system.

### Procedure

---

1. Install AIX Version 7.1, TL4, SP2, or later according to the manufacturer instructions.
2. Configure your TCP/IP settings according to the operating system installation instructions.
3. Open the `/etc/hosts` file and complete the following actions:
  - Update the file to include the IP address and host name for the server. For example:

```
192.0.2.7 server.yourdomain.com server
```

- o Verify that the file contains an entry for localhost with an address of 127.0.0.1. For example:

```
127.0.0.1 localhost
```

4. Enable AIX I/O completion ports by issuing the following command:

```
chdev -l iocp0 -P
```

Server performance can be affected by the Olson time zone definition.

5. To optimize performance, change your system time zone format from Olson to POSIX. Use the following command format to update the time zone setting:

```
chtz=local_timezone,date/time,date/time
```

For example, if you lived in Tucson, Arizona, where Mountain Standard Time is used, you would issue the following command to change to the POSIX format:

```
chtz MST7MDT,M3.2.0/2:00:00,M11.1.0/2:00:00
```

6. Add an entry in the .profile of the instance user so that the following environment is set:

```
export MALLOCOPTIONS=multiheap:16
```

7. Set the system to create full application core files. Issue the following command:

```
chdev -l sys0 -a fullcore=true -P
```

8. For communications with the server and Operations Center, make sure that the following ports are open on any firewalls that might exist:

- o For communications with the server, open port 1500.
- o For secure communications with the Operations Center, open port 11090 on the hub server.

If you are not using the default port values, make sure that the ports that you are using are open.

9. Enable TCP high-performance enhancements. Issue the following command:

```
no -p -o rfc1323=1
```

10. For optimal throughput and reliability, bond four 10 Gb Ethernet ports together. Use the System Management Interface Tool (SMIT) to bond the ports together by using Etherchannel. The following settings were used during testing:

```
mode          8023ad
auto_recovery yes          Enable automatic recovery after failover
backup_adapter NONE       Adapter used when whole channel fails
hash_mode     src_dst_port Determines how outgoing adapter is chosen
interval      long        Determines interval value for IEEE
                                802.3ad mode
mode          8023ad       EtherChannel mode of operation
netaddr       0            Address to ping
noloss_failover yes       Enable lossless failover after ping
                                failure
num_retries   3            Times to retry ping before failing
retry_time    1            Wait time (in seconds) between pings
use_alt_addr  no           Enable Alternate EtherChannel Address
use_jumbo_frame no        Enable Gigabit Ethernet Jumbo Frames
```

11. Verify that user process resource limits, also known as *ulimits*, are set according to guidelines in Table 1. If ulimit values are not set correctly, you might experience server instability or a failure of the server to respond.

Table 1. User limits (ulimit) values

User limit type	Setting	Value	Command to query value
Maximum size of core files created	core	Unlimited	ulimit -Hc
Maximum size of a data segment for a process	data	Unlimited	ulimit -Hd
Maximum file size	fsize	Unlimited	ulimit -Hf

User limit type	Setting	Value	Command to query value
Maximum number of open files	nofile	65536	ulimit -Hn
Maximum amount of processor time in seconds	cpu	Unlimited	ulimit -Ht
Maximum number of user processes	nproc	16384	ulimit -Hu

If you need to modify any user limit values, follow the instructions in the documentation for your operating system.

## Installing on Linux systems

Complete the following steps to install Linux x86\_64 on the server system.

### Before you begin

The operating system will be installed on the internal hard disks. Configure the internal hard disks by using a hardware RAID 1 array. For example, if you are configuring a small system, the two 300 GB internal disks are mirrored in RAID 1 so that a single 300 GB disk appears available to the operating system installer.

### Procedure

1. Install Red Hat Enterprise Linux Version 7.1 or later, according to the manufacturer instructions. Obtain a bootable DVD that contains Red Hat Enterprise Linux Version 7.1 and start your system from this DVD. See the following guidance for installation options. If an item is not mentioned in the following list, leave the default selection.
  - a. After you start the DVD, choose Install or upgrade an existing system from the menu.
  - b. On the Welcome screen, select Test this media & install Red Hat Enterprise Linux 7.1.
  - c. Select your language and keyboard preferences.
  - d. Select your location to set the correct time zone.
  - e. Select Software Selection and then on the next screen, select Server with GUI.
  - f. From the installation summary page, click Installation Destination and verify the following items:
    - The local 300 GB disk is selected as the installation target.
    - Under Other Storage Options, Automatically configure partitioning is selected.
Click Done.
  - g. Click Begin Installation. After the installation starts, set the root password for your root user account.

After the installation is completed, restart the system and log in as the root user. Issue the `df` command to verify your basic partitioning. For example, on a test system, the initial partitioning produced the following result:

```
[root@tvapp02]# df -h
Filesystem      Size  Used Avail Use% Mounted on
/dev/mapper/rhel-root  50G  3.0G  48G   6% /
devtmpfs        32G   0    32G   0% /dev
tmpfs           32G  92K   32G   1% /dev/shm
tmpfs           32G  8.8M  32G   1% /run
tmpfs           32G   0    32G   0% /sys/fs/cgroup
/dev/mapper/rhel-home 220G  37M  220G   1% /home
/dev/sda1       497M 124M  373M  25% /boot
```

2. Configure your TCP/IP settings according to the operating system installation instructions.

For optimal throughput and reliability, consider bonding multiple network ports together. This can be accomplished by creating a Link Aggregation Control Protocol (LACP) network connection, which aggregates several subordinate ports into a single logical connection. The preferred method is to use a bond mode of 802.3ad, miimon setting of 100, and a `xmit_hash_policy` setting of layer3+4.

Restriction: To use an LACP network connection, you must have a network switch that supports LACP.

For additional instructions about configuring bonded network connections with Red Hat Enterprise Linux Version 7, see [Create a Channel Bonding Interface](#).

3. Open the `/etc/hosts` file and complete the following actions:
  - o Update the file to include the IP address and host name for the server. For example:

```
192.0.2.7  server.yourdomain.com  server
```



- o Verify that the file contains an entry for localhost with an address of 127.0.0.1. For example:

```
127.0.0.1 localhost
```

4. Install components that are required for the server installation. Complete the following steps to create a Yellowdog Updater Modified (YUM) repository and install the prerequisite packages.

- a. Mount your Red Hat Enterprise Linux installation DVD to a system directory. For example, to mount it to the /mnt directory, issue the following command:

```
mount -t iso9660 -o ro /dev/cdrom /mnt
```

- b. Verify that the DVD mounted by issuing the mount command. You should see output similar to the following example:

```
/dev/sr0 on /mnt type iso9660
```

- c. Change to the YUM repository directory by issuing the following command:

```
cd /etc/yum/repos.d
```

If the repos.d directory does not exist, create it.

- d. List directory contents:

```
ls rhel-source.repo
```

- e. Rename the original repo file by issuing the mv command. For example:

```
mv rhel-source.repo rhel-source.repo.orig
```

- f. Create a new repo file by using a text editor. For example, to use the vi editor, issue the following command:

```
vi rhel71_dvd.repo
```

- g. Add the following lines to the new repo file. The baseurl parameter specifies your directory mount point:

```
[rhel71_dvd]
name=DVD Redhat Enterprise Linux 7.1
baseurl=file:///mnt
enabled=1
gpgcheck=0
```

- h. Install the prerequisite package ksh.x86\_64, by issuing the yum command. For example:

```
yum install ksh.x86_64
```

Exception: You do not need to install the compat-libstdc++-33-3.2.3-69.el6.i686 and libstdc++.i686 libraries for Red Hat Enterprise Linux Version 7.1.

5. When the software installation is complete, you can restore the original YUM repository values by completing the following steps:

- a. Unmount the Red Hat Enterprise Linux installation DVD by issuing the following command:

```
umount /mnt
```

- b. Change to the YUM repository directory by issuing the following command:

```
cd /etc/yum/repos.d
```

- c. Rename the repo file that you created:

```
mv rhel71_dvd.repo rhel71_dvd.repo.orig
```

- d. Rename the original file to the original name:

```
mv rhel-source.repo.orig rhel-source.repo
```

6. Determine whether kernel parameter changes are required. Complete the following steps:

- a. Use the sysctl -a command to list the parameter values.
- b. Analyze the results by using the guidelines in Table 1 to determine whether any changes are required.
- c. If changes are required, set the parameters in the /etc/sysctl.conf file. The file changes are applied when the system is started.

Tip: Automatically adjust kernel parameter settings and eliminate the need for manual updates to these settings. On Linux, the DB2® database software automatically adjusts interprocess communication (IPC) kernel parameter values to the preferred settings. For more information about kernel parameter settings, search for Linux kernel parameters in the IBM DB2 Version 11.1 Knowledge Center.

Table 1. Linux kernel parameter optimum settings

Parameter	Description
kernel.shmni	The maximum number of segments.
kernel.shmmax	The maximum size of a shared memory segment (bytes). This parameter must be set before automatically starting the IBM Spectrum Protect™ server on system startup.
kernel.shmall	The maximum allocation of shared memory pages (pages).
kernel.sem	(SEMMSL) The maximum semaphores per array.
There are four values for the kernel.sem parameter.	(SEMMNS) The maximum semaphores per system.
	(SEMOPM) The maximum operations per semaphore call.
	(SEMMNI) The maximum number of arrays.
kernel.msgmni	The maximum number of system-wide message queues.
kernel.msgmax	The maximum size of messages (bytes).
kernel.msgmnb	The default maximum size of queue (bytes).
kernel.randomize_va_space	The kernel.randomize_va_space parameter configures the use of memory ASLR for the kernel. Disable ASLR because it can cause errors for the DB2 software. To learn more details about the Linux ASLR and DB2, see technote 1365583.
vm.swappiness	The vm.swappiness parameter defines whether the kernel can swap application memory out of physical random access memory (RAM). For more information about kernel parameters, see the DB2 product information.
vm.overcommit_memory	The vm.overcommit_memory parameter influences how much virtual memory the kernel permits allocating. For more information about kernel parameters, see the DB2 product information.

7. Open firewall ports to communicate with the server. Complete the following steps:

- a. Determine the zone that is used by the network interface. The zone is public, by default.

Issue the following command:

```
# firewall-cmd --get-active-zones
public
interfaces: ens4f0
```

- b. To use the default port address for communications with the server, open TCP/IP port 1500 in the Linux firewall.

Issue the following command:

```
firewall-cmd --zone=public --add-port=1500/tcp --permanent
```

If you want to use a value other than the default, you can specify a number in the range 1024 - 32767. If you open a port other than the default, you will need to specify that port when you run the configuration script.

- c. If you plan to use this system as a hub, open port 11090, which is the default port for secure (https) communications.

Issue the following command:

```
firewall-cmd --zone=public --add-port=11090/tcp --permanent
```

d. Reload the firewall definitions for the changes to take effect.

Issue the following command:

```
firewall-cmd --reload
```

8. Verify that user process resource limits, also known as *ulimits*, are set according to guidelines in Table 2. If ulimit values are not set correctly, you might experience server instability or a failure of the server to respond.

Table 2. User limits (ulimit) values

User limit type	Setting	Value	Command to query value
Maximum size of core files created	core	Unlimited	ulimit -Hc
Maximum size of a data segment for a process	data	Unlimited	ulimit -Hd
Maximum file size	FSIZE	Unlimited	ulimit -Hf
Maximum number of open files	nfile	65536	ulimit -Hn
Maximum amount of processor time in seconds	cpu	Unlimited	ulimit -Ht
Maximum number of user processes	nproc	16384	ulimit -Hu

If you need to modify any user limit values, follow the instructions in the documentation for your operating system.

## Installing on Windows systems

Install Microsoft Windows Server 2012 Standard Edition on the server system and prepare the system for installation and configuration of the IBM Spectrum Protect™ server.

### Procedure

1. Install Microsoft Windows Server 2012 R2 Standard Edition, according to the manufacturer instructions.
2. Change the Windows account control policies by completing the following steps.
  - a. Open the Local Security Policy editor by running secpol.msc.
  - b. Click Local Policies > Security Options and ensure that the following User Account Control policies are disabled:
    - Admin Approval Mode for the Built-in Administrator account
    - Run all administrators in Admin Approval Mode
3. Configure your TCP/IP settings according to installation instructions for the operating system.
4. Apply Windows updates and enable optional features by completing the following steps:
  - a. Apply the latest Windows 2012 R2 updates.
  - b. Install and enable the Windows 2012 R2 feature Microsoft .NET Framework 3.5 from the Windows Server Manager.
  - c. If required, update the FC and Ethernet HBA device drivers to newer levels.
  - d. Install the multipath I/O driver that is appropriate for the disk system that you are using.
5. Open the default TCP/IP port, 1500, for communications with the IBM Spectrum Protect server. For example, issue the following command:

```
netsh advfirewall firewall add rule name="Backup server port 1500"  
dir=in action=allow protocol=TCP localport=1500
```

6. On the Operations Center hub server, open the default port for secure (https) communications with the Operations Center. The port number is 11090. For example, issue the following command:

```
netsh advfirewall firewall add rule name="Operations Center port 11090"  
dir=in action=allow protocol=TCP localport=11090
```

## Configuring multipath I/O

You can enable and configure multipathing for disk storage. Use the documentation that is provided with your hardware for detailed instructions.

- AIX systems
- Linux systems
- Windows systems

## AIX systems

---

### Procedure

---

1. Determine the Fibre Channel port address that you must use for the host definition on the disk subsystem. Issue the `lscfg` command for every port.

- o On small and medium systems, issue the following commands:

```
lscfg -vps -l fcs0 | grep "Network Address"
lscfg -vps -l fcs1 | grep "Network Address"
```

- o On large systems, issue the following commands:

```
lscfg -vps -l fcs0 | grep "Network Address"
lscfg -vps -l fcs1 | grep "Network Address"
lscfg -vps -l fcs2 | grep "Network Address"
lscfg -vps -l fcs3 | grep "Network Address"
```

2. Ensure that the following AIX® file sets are installed:

- o `devices.common.IBM.mpio.rte`
- o `devices.fcp.disk.array.rte`
- o `devices.fcp.disk.rte`

3. Issue the `cfgmgr` command to have AIX rescan the hardware and discover available disks. For example:

```
cfgmgr
```

4. To list the available disks, issue the following command:

```
lsdev -Ccdisk
```

You should see output similar to the following:

```
hdisk0 Available 00-00-00 SAS Disk Drive
hdisk1 Available 00-00-00 SAS Disk Drive
hdisk2 Available 01-00-00 SAS Disk Drive
hdisk3 Available 01-00-00 SAS Disk Drive
hdisk4 Available 06-01-02 MPIO IBM 2076 FC Disk
hdisk5 Available 07-01-02 MPIO IBM 2076 FC Disk
...
```

5. Use the output from the `lsdev` command to identify and list device IDs for each disk device.

For example, a device ID could be `hdisk4`. Save the list of device IDs to use when you create file systems for the IBM Spectrum Protect™ server.

6. Correlate the SCSI device IDs to specific disk LUNs from the disk system by listing detailed information about all physical volumes in the system. Issue the following command:

```
lspv -u
```

On an IBM® Storwize® system, the following information is an example of what is shown for each device:

```
hdisk4 00f8cf083fd97327 None active
33213600507630081010578000000000003004214503IBMfcp
```

In the example, `6005076300810105780000000000030` is the UID for the volume, as reported by the Storwize management interface.

To verify disk size in megabytes and compare the value with what is listed for the system, issue the following command:

```
bootinfo -s hdisk4
```

## Linux systems

---

## Procedure

1. Edit the `/etc/multipath.conf` file to enable multipathing for Linux hosts. If the `multipath.conf` file does not exist, you can create it by issuing the following command:

```
mpathconf --enable
```

The following parameters were set in `multipath.conf` for testing on an IBM Storwize® system:

```
defaults {
    user_friendly_names no
}

devices {
    device {
        vendor "IBM "
        product "2145"
        path_grouping_policy group_by_prio
        user_friendly_names no
        path_selector "round-robin 0"
        prio "alua"
        path_checker "tur"
        failback "immediate"
        no_path_retry 5
        rr_weight uniform
        rr_min_io_rq "1"
        dev_loss_tmo 120
    }
}
```

2. Set the multipath option to start when the system is started. Issue the following commands:

```
systemctl enable multipathd.service
systemctl start multipathd.service
```

3. To verify that disks are visible to the operating system and are managed by multipath, issue the following command:

```
multipath -l
```

4. Ensure that each device is listed and that it has as many paths as you expect. You can use size and device ID information to identify which disks are listed.

For example, the following output shows that a 2 TB disk has two path groups and four active paths. The 2 TB size confirms that the disk corresponds to a pool file system. Use part of the long device ID number (12, in this example) to search for the volume on the disk-system management interface.

```
[root@tapsrv01 code]# multipath -l
36005076802810c509800000000000012 dm-43 IBM,2145
 size=2.0T features='1 queue_if_no_path' hwhandler='0' wp=rw
|-+- policy='round-robin 0' prio=0 status=active
| |- 2:0:1:18 sdcw 70:64 active undef running
| `-- 4:0:0:18 sdgb 131:112 active undef running
`--+- policy='round-robin 0' prio=0 status=enabled
   |- 1:0:1:18 sdat 66:208 active undef running
   `-- 3:0:0:18 sddy 128:0 active undef running
```

- a. If needed, correct disk LUN host assignments and force a bus rescan. For example:

```
echo "- - -" > /sys/class/scsi_host/host0/scan
echo "- - -" > /sys/class/scsi_host/host1/scan
echo "- - -" > /sys/class/scsi_host/host2/scan
```

You can also restart the system to rescan disk LUN host assignments.

- b. Confirm that disks are now available for multipath I/O by reissuing the `multipath -l` command.

5. Use the multipath output to identify and list device IDs for each disk device.

For example, the device ID for your 2 TB disk is `36005076802810c509800000000000012`.

Save the list of device IDs to use in the next step.

## Windows systems

## Procedure

---

1. Ensure that the Multipath I/O feature is installed. If needed, install additional vendor-specific multipath drivers.
2. To verify that disks are visible to the operating system and are managed by multipath I/O, issue the following command:

```
c:\program files\IBM\SDDDSM\datapath.exe query device
```

3. Review the multipath output and ensure that each device is listed and that it has as many paths as you expect. You can use size and device serial information to identify which disks are listed.

For example, by using part of the long device serial number (34, in this example) you can search for the volume on the disk-system management interface. The 2 TB size confirms that the disk corresponds to a storage pool file system.

```
DEV#: 4 DEVICE NAME: Disk5 Part0 TYPE: 2145 POLICY: OPTIMIZED
SERIAL: 60050763008101057800000000000034 LUN SIZE: 2.0TB
=====
Path# Adapter/Hard Disk State Mode Select Errors
0 Scsi Port2 Bus0/Disk5 Part0 OPEN NORMAL 0 0
1 Scsi Port2 Bus0/Disk5 Part0 OPEN NORMAL 27176 0
2 Scsi Port3 Bus0/Disk5 Part0 OPEN NORMAL 28494 0
3 Scsi Port3 Bus0/Disk5 Part0 OPEN NORMAL 0 0
```

4. Create a list of disk device IDs by using the serial numbers that are returned from the multipath output in the previous step.

For example, the device ID for your 2 TB disk is 60050763008101057800000000000034

Save the list of device IDs to use in the next step.

5. To bring new disks online and clear the read-only attribute, run diskpart.exe with the following commands. Repeat for each of the disks:

```
diskpart
select Disk 1
online disk
attribute disk clear readonly
select Disk 2
online disk
attribute disk clear readonly
< ... >
select Disk 49
online disk
attribute disk clear readonly
exit
```

## Creating the user ID for the server

---

Create the user ID that owns the IBM Spectrum Protect™ server instance. You specify this user ID when you create the server instance during initial configuration of the server.

### About this task



---

You can specify only lowercase letters (a-z), numerals (0-9), and the underscore character ( \_ ) for the user ID. The user ID and group name must comply with the following rules:

- The length must be 8 characters or fewer.
- The user ID and group name cannot start with *ibm*, *sql*, *sys*, or a numeral.
- The user ID and group name cannot be *user*, *admin*, *guest*, *public*, *local*, or any SQL reserved word.

## Procedure

---

1. Use operating system commands to create a user ID.
  - o   Create a group and user ID in the home directory of the user that owns the server instance.

For example, to create the user ID `tsminst1` in group `tsmsrvs` with a password of `tsminst1`, issue the following commands from an administrative user ID:



```
mkgroup id=1001 tsmsrvrs
mkuser id=1002 pgrp=tsmsrvrs home=/home/tsminst1 tsminst1
passwd tsminst1
```

#### Linux

```
groupadd tsmsrvrs
useradd -d /home/tsminst1 -m -g tsmsrvrs -s /bin/bash tsminst1
passwd tsminst1
```

Log off, and then log in to your system. Change to the user account that you created. Use an interactive login program, such as telnet, so that you are prompted for the password and can change it if necessary.

- o **Windows** Create a user ID and then add the new ID to the Administrators group. For example, to create the user ID `tsminst1`, issue the following command:

```
net user tsminst1 * /add
```

After you create and verify a password for the new user, add the user ID to the Administrators group by issuing the following commands:

```
net localgroup Administrators tsminst1 /add
net localgroup DB2ADMNS tsminst1 /add
```

2. Log off the new user ID.

## Preparing file systems for the server

---

You must complete file system configuration for the disk storage to be used by the server.

- Preparing file systems on AIX systems  
You must create volume groups, logical volumes, and file systems for the server by using the AIX® Logical Volume Manager.
- Preparing file systems on Linux systems  
You must format ext4 or xfs file systems on each of the disk LUNs to be used by the IBM Spectrum Protect server.
- Preparing file systems on Windows systems  
You must format New Technology File System (NTFS) file systems on each of the disk LUNs to be used by the IBM Spectrum Protect server.

## Preparing file systems on AIX systems

---

You must create volume groups, logical volumes, and file systems for the server by using the AIX® Logical Volume Manager.

### Procedure

---

1. Increase the queue depth and maximum transfer size for all of the available *hdiskX* disks. Issue the following commands for each disk:

```
chdev -l hdisk4 -a max_transfer=0x100000
chdev -l hdisk4 -a queue_depth=32
chdev -l hdisk4 -a reserve_policy=no_reserve
chdev -l hdisk4 -a algorithm=round_robin
```

Do not run these commands for operating system internal disks, for example, *hdisk0*.

2. Create volume groups for the IBM Spectrum Protect™ database, active log, archive log, database backup, and storage pool. Issue the `mkvg` command, specifying the device IDs for corresponding disks that you previously identified. For example, if the device names *hdisk4*, *hdisk5*, and *hdisk6* correspond to database disks, include them in the database volume group and so on.  
System size: The following commands are based on the medium system configuration. For small and large systems, you must adjust the syntax as required.

```
mkvg -S -y tsmdb hdisk2 hdisk3 hdisk4
mkvg -S -y tsmactlog hdisk5
mkvg -S -y tsmarchlog hdisk6
mkvg -S -y tsmdbback hdisk7 hdisk8 hdisk9 hdisk10
mkvg -S -y tsmstgpool hdisk11 hdisk12 hdisk13 hdisk14 ... hdisk49
```

- Determine the physical volume names and the number of free physical partitions to use when you create logical volumes. Issue the `lsvg` for each volume group that you created in the previous step.

For example:

```
lsvg -p tsmdb
```

The output is similar to the following. The *FREE PPs* column represents the free physical partitions:

```
tsmdb:
PV_NAME  PV STATE  TOTAL PPs  FREE PPs  FREE DISTRIBUTION
hdisk4   active    1631       1631      327..326..326..326..326
hdisk5   active    1631       1631      327..326..326..326..326
hdisk6   active    1631       1631      327..326..326..326..326
```

- Create logical volumes in each volume group by using the `mklv` command. The volume size, volume group, and device names vary, depending on the size of your system and variations in your disk configuration.

For example, to create the volumes for the IBM Spectrum Protect database on a medium system, issue the following commands:

```
mklv -y tsmdb00 -t jfs2 -u 1 -x 1631 tsmdb 1631 hdisk2
mklv -y tsmdb01 -t jfs2 -u 1 -x 1631 tsmdb 1631 hdisk3
mklv -y tsmdb02 -t jfs2 -u 1 -x 1631 tsmdb 1631 hdisk4
```

- Format file systems in each logical volume by using the `crfs` command.

For example, to format file systems for the database on a medium system, issue the following commands:

```
crfs -v jfs2 -d tsmdb00 -p rw -a logname=INLINE -a options=rbrw
-a agblksize=4096 -m /tsminst1/TSMdbspace00 -A yes
crfs -v jfs2 -d tsmdb01 -p rw -a logname=INLINE -a options=rbrw
-a agblksize=4096 -m /tsminst1/TSMdbspace01 -A yes
crfs -v jfs2 -d tsmdb02 -p rw -a logname=INLINE -a options=rbrw
-a agblksize=4096 -m /tsminst1/TSMdbspace02 -A yes
```

- Mount all of the newly created file systems by issuing the following command:

```
mount -a
```

- List all file systems by issuing the `df` command. Verify that file systems are mounted at the correct LUN and correct mount point. Also, verify the available space.

The following example of command output shows that the amount of used space is typically 1%:

```
tapsrv07> df -g /tsminst1/*
Filesystem      GB blocks  Free    %Used  Iused  %Iused  Mounted on
/dev/tsmact00   195.12    194.59  1%      4      1%      /tsminst1/TSMalog
```

- Verify that the user ID you created in *Creating the user ID for the server* has read and write access to the directories for the IBM Spectrum Protect server.

## Preparing file systems on Linux systems

---

You must format ext4 or xfs file systems on each of the disk LUNs to be used by the IBM Spectrum Protect™ server.

### Procedure

---

- Using the list of device IDs that you generated previously, issue the `mkfs` command to create and format a file system for each storage LUN device. Specify the device ID in the command. See the following examples. For the database, format ext4 file systems:

```
mkfs -t ext4 -T largefile -m 2 /dev/mapper/36005076802810c50980000000000012
```

For storage pool LUNs, format xfs file systems:

```
mkfs -t xfs /dev/mapper/3600507630081010578000000000002c3
```

You might issue the `mkfs` command as many as 50 times, depending on how many different devices you have.

- Create mount point directories for file systems.



Issue the `mkdir` command for each directory that you must create. Use the directory values that you recorded in the planning worksheets.

For example, to create the server instance directory by using the default value, issue the following command:

```
mkdir /tsminst1
```

Repeat the `mkdir` command for each file system.

3. Add an entry in the `/etc/fstab` file for each file system so that file systems are mounted automatically when the server is started.

For example:

```
/dev/mapper/36005076802810c50980000000000012 /tsminst1/TSMdbspace00 ext4 defaults 0 0
```

4. Mount the file systems that you added to the `/etc/fstab` file by issuing the `mount -a` command.
5. List all file systems by issuing the `df` command. Verify that file systems are mounted at the correct LUN and correct mount point. Also, verify the available space.

The following example on an IBM® Storwize® system shows that the amount of used space is typically 1%:

```
[root@tapsrv04 ~]# df -h /tsminst1/*
Filesystem                                Size  Used Avail Use% Mounted on
/dev/mapper/36005076300810105780000000000003 134G  188M 132G   1% /tsminst1/TSMalog
```

6. Verify that the user ID you created in *Creating the user ID for the server* has read and write access to the directories for IBM Spectrum Protect.

## Preparing file systems on Windows systems

---

You must format New Technology File System (NTFS) file systems on each of the disk LUNs to be used by the IBM Spectrum Protect™ server.

### Procedure

---

1. Create mount point directories for file systems.

Issue the `md` command for each directory that you must create. Use the directory values that you recorded in the planning worksheets. For example, to create the server instance directory by using the default value, issue the following command:

```
md c:\tsminst1
```

Repeat the `md` command for each file system.

2. Create a volume for every disk LUN that is mapped to a directory under the server instance directory by using the Windows volume manager.

Go to *Server Manager > File and Storage Services* and complete the following steps for each disk that corresponds to the LUN mapping that was created in the previous step:

- a. Bring the disk online.
- b. Initialize the disk to the GPT basic type, which is the default.
- c. Create a simple volume that occupies all of the space on the disk. Format the file system by using NTFS, and assign a label that matches the purpose of the volume, such as `TSMfile00`. Do not assign the new volume to a drive letter. Instead, map the volume to a directory under the instance directory, such as `C:\tsminst1\TSMfile00`.

Tip: Determine the volume label and directory mapping labels based on the size of the disk that is reported.

3. Verify that file systems are mounted at the correct LUN and correct mount point. List all file systems by issuing the `mountvol` command and then review the output. For example:

```
\\?\Volume{8ffb9678-3216-474c-a021-20e420816a92}\
C:\tsminst1\TSMdbspace00\
```

4. After the disk configuration is complete, restart the system.

### What to do next

---

You can confirm the amount of free space for each volume by using Windows Explorer.

## Installing the server and Operations Center

---

Use the IBM® Installation Manager graphical wizard to install the components.

- Installing on AIX and Linux systems  
Install the IBM Spectrum Protect™ server and the Operations Center on the first server system.
- Installing on Windows systems  
Install the IBM Spectrum Protect server and the Operations Center on the first server system.

## Installing on AIX® and Linux systems

---

Install the IBM Spectrum Protect™ server and the Operations Center on the first server system.

### Before you begin

---

Verify that the operating system is set to the language that you require. By default, the language of the operating system is the language of the installation wizard.

### Procedure

---

1. **AIX** Verify that the required RPM files are installed on your system.

See Installing prerequisite RPM files for the graphical wizard for details.

2. Before you download the installation package, verify that you have enough space to store the installation files when they are extracted from the product package. For space requirements, see the download document at technote 4042992.
3. Go to Passport Advantage® and download the package file to an empty directory of your choice.
4. Ensure that executable permission is set for the package. If necessary, change the file permissions by issuing the following command:

```
chmod a+x package_name.bin
```

5. Extract the package by issuing the following command:

```
./package_name.bin
```

where *package\_name* is the name of the downloaded file.

6. **AIX** Ensure that the following command is enabled so that the wizards work properly:

```
lsuser
```

By default, the command is enabled.

7. Change to the directory where you placed the executable file.
8. Start the installation wizard by issuing the following command:

```
./install.sh
```

When you select the packages to install, choose both the server and Operations Center.

### What to do next

---

- If errors occur during the installation process, the errors are recorded in log files that are stored in the IBM Installation Manager logs directory.

To view installation log files from the Installation Manager tool, click File > View Log. To collect these log files from the Installation Manager tool, click Help > Export Data for Problem Analysis.

- After you install the server and before you customize it for your use, go to the IBM Spectrum Protect support site. Click Support and downloads and apply any applicable fixes.
- Installing prerequisite RPM files for the graphical wizard  
RPM files are required for the IBM Installation Manager graphical wizard.

#### Related tasks:

- [Other methods for installing IBM Spectrum Protect components \(AIX\)](#)
- [Other methods for installing IBM Spectrum Protect components \(Linux\)](#)

# Installing on Windows systems

---

Install the IBM Spectrum Protect™ server and the Operations Center on the first server system.

## Before you begin

---

Make sure that the following prerequisites are met:

- Verify that the operating system is set to the language that you require. By default, the language of the operating system is the language of the installation wizard.
- Ensure that the user ID that you plan to use during the installation is a user with local Administrator authority.

## Procedure

---

1. Before you download the installation package, verify that you have enough space to store the installation files when they are extracted from the product package. For space requirements, see the download document at technote 4042993.
2. Go to Passport Advantage® and download the package file to an empty directory of your choice.
3. Change to the directory where you placed the executable file.
4. Double-click the executable file to extract to the current directory.
5. In the directory where the installation files were extracted, start the installation wizard by double-clicking the install.bat file. When you select the packages to install, choose both the server and Operations Center.

## What to do next

---

- If errors occur during the installation process, the errors are recorded in log files that are stored in the IBM® Installation Manager logs directory.

To view installation log files from the Installation Manager tool, click File > View Log. To collect these log files from the Installation Manager tool, click Help > Export Data for Problem Analysis.

- After you install the server and before you customize it for your use, go to the IBM Spectrum Protect support site. Click Support and downloads and apply any applicable fixes.

### Related tasks:

 Other methods for installing IBM Spectrum Protect components

# Configuring the server and the Operations Center

---

After you install the components, complete the configuration for the IBM Spectrum Protect™ server and the Operations Center.

- **Configuring the server instance**  
Use the IBM Spectrum Protect server instance configuration wizard to complete the initial configuration of the server.
- **Installing the backup-archive client**  
As a best practice, install the IBM Spectrum Protect backup-archive client on the server system so that the administrative command-line client and scheduler are available.
- **Setting options for the server**  
Review the server options file that is installed with the IBM Spectrum Protect server to verify that the correct values are set for your system.
- **Configuring secure communications with Transport Layer Security**  
To encrypt data and secure communications in your environment, Secure Sockets Layer (SSL) or Transport Layer Security (TLS) is enabled on the IBM Spectrum Protect server and backup-archive client. An SSL certificate is used to verify communication requests between the server and client.
- **Configuring the Operations Center**  
After you install the Operations Center, complete the following configuration steps to start managing your storage environment.
- **Registering the product license**  
To register your license for the IBM Spectrum Protect product, use the REGISTER LICENSE command.
- **Configuring data deduplication**  
Create a directory-container storage pool and at least one directory to use inline data deduplication.
- **Defining data retention rules for your business**  
After you create a directory-container storage pool for data deduplication, update the default server policy to use the new

storage pool. The Add Storage Pool wizard opens the Services page in the Operations Center to complete this task.

- Defining schedules for server maintenance activities  
Create schedules for each server maintenance operation by using the DEFINE SCHEDULE command in the Operations Center command builder.
- Defining client schedules  
Use the Operations Center to create schedules for client operations.

## Configuring the server instance

---

Use the IBM Spectrum Protect™ server instance configuration wizard to complete the initial configuration of the server.

### Before you begin

---

Ensure that the following requirements are met:

**AIX** | **Linux**

- The system where you installed IBM Spectrum Protect must have the X Window System client. You must also be running an X Window System server on your desktop.
- The system must have the Secure Shell (SSH) protocol enabled. Ensure that the port is set to the default value, 22, and that the port is not blocked by a firewall. You must enable password authentication in the `sshd_config` file in the `/etc/ssh/` directory. Also, ensure that the SSH daemon service has access rights to connect to the system by using the `localhost` value.
- You must be able to log in to IBM Spectrum Protect with the user ID that you created for the server instance, by using the SSH protocol. When you use the wizard, you must provide this user ID and password to access that system.
- If you changed any settings in the preceding steps, restart the server before you proceed with the configuration wizard.

**Windows**

Verify that the remote registry service is started by completing the following steps:

1. Click Start > Administrative Tools > Services. In the Services window, select Remote Registry. If it is not started, click Start.
2. Ensure that port 137, 139, and 445 are not blocked by a firewall:
  - a. Click Start > Control Panel > Windows Firewall.
  - b. Select Advanced Settings.
  - c. Select Inbound Rules.
  - d. Select New Rule.
  - e. Create a port rule for TCP ports 137, 139, and 445 to allow connections for domain and private networks.
3. Configure the user account control by accessing the local security policy options and completing the following steps.
  - a. Click Start > Administrative Tools > Local Security Policy. Expand Local Policies > Security Options.
  - b. If not already enabled, enable the built-in administrator account by selecting Accounts: Administrator account status > Enable > OK.
  - c. If not already disabled, disable user account control for all Windows administrators by selecting User Account Control: Run all administrators in Admin Approval Mode > Disable > OK.
  - d. If not already disabled, disable the User Account Control for the built-in Administrator account by selecting User Account Control: Admin Approval Mode for the Built-in Administrator Account > Disable > OK.
4. If you changed any settings in the preceding steps, restart the server before you proceed with the configuration wizard.

### About this task

---

The wizard can be stopped and restarted, but the server is not operational until the entire configuration process is complete.

### Procedure

---

1. Start the local version of the wizard.
  - o **AIX** | **Linux** Open the `dsmicfgx` program in the `/opt/tivoli/tsm/server/bin` directory. This wizard can be only run as a root user.
  - o **Windows** Click Start > All Programs > IBM Spectrum Protect > Configuration Wizard.
2. Follow the instructions to complete the configuration. Use the information that you recorded in Planning worksheets during IBM Spectrum Protect system set up to specify directories and options in the wizard.

**AIX** | **Linux**

On the Server Information window, set the server to start automatically by using the instance user ID when the system boots.

**Windows**

By using the configuration wizard, the server is set to start automatically when rebooted.

## Installing the backup-archive client

As a best practice, install the IBM Spectrum Protect™ backup-archive client on the server system so that the administrative command-line client and scheduler are available.

### Procedure

To install the backup-archive client, follow the installation instructions for your operating system.

- Installing the UNIX and Linux backup-archive clients
- Installing the Windows backup-archive client

## Setting options for the server

Review the server options file that is installed with the IBM Spectrum Protect™ server to verify that the correct values are set for your system.

### Procedure

1. Go to the server instance directory and open the dsmserv.opt file.
2. Review the values in the following table and verify your server option settings, based on system size.

Server option	Small system value	Medium system value	Large system value
ACTIVELOGDIRECTORY	Directory path that was specified during configuration	Directory path that was specified during configuration	Directory path that was specified during configuration
ACTIVELOGSIZE	131072	131072	262144
ARCHLOGCOMPRESS	Yes	No	No
ARCHLOGDIRECTORY	Directory path that was specified during configuration	Directory path that was specified during configuration	Directory path that was specified during configuration
COMMMETHOD	TCP/IP	TCP/IP	TCP/IP
COMMTIMEOUT	3600	3600	3600
DEDUPREQUIRESBACKUP	No	No	No
DEVCONFIG	devconf.dat	devconf.dat	devconf.dat
EXPINTERVAL	0	0	0
IDLETIMEOUT	60	60	60
MAXSESSIONS	250	500	1000
NUMOPENVOLSALLOWED	20	20	20
TCPADMINPORT	1500	1500	1500
TCPPORT	1500	1500	1500
VOLUMEHISTORY	volhist.dat	volhist.dat	volhist.dat

Update server option settings if necessary, to match the values in the table. To make updates, close the dsmserv.opt file and use the SETOPT command from the administrative command-line interface to set the options.

For example, to update the IDLETIMEOUT option to 60, issue the following command:

```
setopt idletimeout 60
```

3. To configure secure communications for the server, clients, and the Operations Center, verify the options in the following table.

Server option	All system sizes
SSLFIPSMODE	NO

Server option	All system sizes
TCPSPORT	Specify the port number on which the server waits for requests for TCP/IP and SSL-enabled sessions from the client.
TCPADMINPORT	Specify the port address on which the server waits for requests for TCP/IP and SSL-enabled sessions from the command-line administrative client.

If any of the option values must be updated, edit the dsmserv.opt file by using the following guidelines:

- Remove the asterisk at the beginning of a line to enable an option.
- On each line, enter only one option and the specified value for the option.
- If an option occurs in multiple entries in the file, the server uses the last entry.

Save your changes and close the file. If you edit the dsmserv.opt file directly, you must restart the server for the changes to take effect.

**Related reference:**

- 🔗 [Server options reference](#)
- 🔗 [SETOPT \(Set a server option for dynamic update\)](#)

## Configuring secure communications with Transport Layer Security

To encrypt data and secure communications in your environment, Secure Sockets Layer (SSL) or Transport Layer Security (TLS) is enabled on the IBM Spectrum Protect™ server and backup-archive client. An SSL certificate is used to verify communication requests between the server and client.

### About this task

Beginning with IBM Spectrum Protect Version 8.1.2, SSL is enabled by default, and the IBM Spectrum Protect server and backup-archive client are automatically configured to communicate with each other by using the TLS 1.2 protocol.

As shown in the following figure, you can manually configure secure communications between the server and backup-archive client by setting options in the server and client options files, and then transferring the self-signed certificate that is generated on the server to the client. Alternatively, you can obtain and transfer a unique certificate that is signed by a certificate authority (CA).



For more information about configuring the server and clients for SSL or TLS communications, see [Configuring storage agents, servers, clients, and the Operations Center to connect to the server by using SSL](#).

## Configuring the Operations Center

After you install the Operations Center, complete the following configuration steps to start managing your storage environment.

### Before you begin

When you connect to the Operations Center for the first time, you must provide the following information:

- Connection information for the server that you want to designate as a hub server
- Login credentials for an administrator ID that is defined for that server

### Procedure

1. Designate the hub server. In a web browser, enter the following address:

```
https://hostname:secure_port/oc
```

where:

- *hostname* represents the name of the computer where the Operations Center is installed
- *secure\_port* represents the port number that the Operations Center uses for HTTPS communication on that computer

For example, if your host name is `tsm.storage.mylocation.com` and you are using the default secure port for the Operations Center, which is `11090`, the address is:

```
https://tsm.storage.mylocation.com:11090/oc
```

When you log in to the Operations Center for the first time, a wizard guides you through an initial configuration to set up a new administrator with system authority on the server.

2. Set up secure communications between the Operations Center and the hub server by configuring the Secure Sockets Layer (SSL) protocol.

Follow the instructions in [Securing communications between the Operations Center and the hub server](#).

3. Optional: To receive a daily email report that summarizes system status, configure your email settings in the Operations Center.

Follow the instructions in [Tracking system status by using email reports](#).

- [Securing communications between the Operations Center and the hub server](#)  
To secure communications between the Operations Center and the hub server, add the Transport Layer Security (TLS) certificate of the hub server to the truststore file of the Operations Center.

## Registering the product license

---

To register your license for the IBM Spectrum Protect™ product, use the REGISTER LICENSE command.

### About this task

---

Licenses are stored in enrollment certificate files, which contain licensing information for the product. The enrollment certificate files are on the installation media, and are placed on the server during installation. When you register the product, the licenses are stored in a NODELOCK file within the current directory.

### Procedure

---

Register a license by specifying the name of the enrollment certificate file that contains the license. To use the Operations Center command builder for this task, complete the following steps.

1. Open the Operations Center.
2. Open the Operations Center command builder by hovering over the settings icon  and clicking Command Builder.
3. Issue the REGISTER LICENSE command. For example, to register a base IBM Spectrum Protect license, issue the following command:

```
register license file=tsmbasic.lic
```

### What to do next

---

Save the installation media that contains your enrollment certificate files. You might need to register your license again if, for example, one of the following conditions occur:

- The server is moved to a different computer.
- The NODELOCK file is corrupted. The server stores license information in the NODELOCK file, which is in the directory from which the server is started.
-  If you change the processor chip that is associated with the server on which the server is installed.

#### Related reference:

[REGISTER LICENSE \(Register a new license\)](#)

## Configuring data deduplication

---

Create a directory-container storage pool and at least one directory to use inline data deduplication.

## Before you begin

---

Use the storage pool directory information that you recorded in Planning worksheets for this task.

## Procedure

---

1. Open the Operations Center.
2. On the Operations Center menu bar, hover over Storage.
3. From the list that is displayed, click Storage Pools.
4. Click the +Storage Pool button.
5. Complete the steps in the Add Storage Pool wizard:
  - o To use inline data deduplication, select a Directory storage pool under Container-based storage.
  - o When you configure directories for the directory-container storage pool, specify the directory paths that you created for storage during system setup.
6. After you configure the new directory-container storage pool, click Close & View Policies to update a management class and start using the storage pool.

## Defining data retention rules for your business

---

After you create a directory-container storage pool for data deduplication, update the default server policy to use the new storage pool. The Add Storage Pool wizard opens the Services page in the Operations Center to complete this task.

## Procedure

---

1. On the Services page of the Operations Center, select the STANDARD domain and click Details.
2. On the Summary page for the policy domain, click the Policy Sets tab. The Policy Sets page indicates the name of the active policy set and lists all of the management classes for that policy set.
3. Click the Configure toggle, and make the following changes:
  - o Change the backup destination for the STANDARD management class to the directory-container storage pool.
  - o Change the value for the Backups column to No limit.
  - o Change the retention period. Set the Keep Extra Backups column to 30 days or more, depending on your business requirements.
4. Save your changes and click the Configure toggle again so that the policy set is no longer editable.
5. Activate the policy set by clicking Activate.

### Related tasks:

Specifying rules for backing up and archiving client data

## Defining schedules for server maintenance activities

---

Create schedules for each server maintenance operation by using the DEFINE SCHEDULE command in the Operations Center command builder.

## About this task

---

Schedule server maintenance operations to run after client backup operations. You can control the timing of schedules by setting the start time in combination with the duration time for each operation.

The following example shows how you can schedule server maintenance processes in combination with the client backup schedule for a multisite disk solution.

Operation	Schedule
Client backup	Starts at 22:00.
Node replication	Starts at 08:00, or 10 hours after the beginning of the client backup.



Operation	Schedule
Processing for database and disaster recovery files	<ul style="list-style-type: none"> <li>Database backup starts at 11:00, or 13 hours after the beginning of the client backup. This process runs until completion.</li> <li>Device configuration information and volume history backup starts at 17:00, or 6 hours after the start of the database backup.</li> <li>Volume history deletion starts at 20:00, or 9 hours after the start of the database backup.</li> </ul>
Inventory expiration	Starts at 12:00, or 14 hours after the beginning of the client backup window. This process runs until completion.

## Procedure

After you configure the device class for the database backup operations, create schedules for database backup and other required maintenance operations by using the DEFINE SCHEDULE command. Depending on the size of your environment, you might need to adjust the start times for each schedule in the example.

1. Define a device class for the backup operations. For example, use the DEFINE DEVCLASS command to create a device class that is named DBBACK\_FILEDEV:

```
define devclass dbback_filedev devtype=file
    directory=db_backup_directories
```

where *db\_backup\_directories* is a list of the directories that you created for the database backup.

**AIX** **Linux** For example, if you have four directories for database backups, starting with /tsminst1/TSMbkup00, issue the following command:

```
define devclass dbback_filedev devtype=file
    directory=/tsminst1/TSMbkup00,
    /tsminst1/TSMbkup01,/tsminst1/TSMbkup02,
    /tsminst1/TSMbkup03"
```

**Windows** For example, if you have four directories for database backups, starting with C:\tsminst1\TSMbkup00, issue the following command:

```
define devclass dbback_filedev devtype=file
    directory="c:\tsminst1\TSMbkup00,
    c:\tsminst1\TSMbkup01,c:\tsminst1\TSMbkup02,
    c:\tsminst1\TSMbkup03"
```

2. Set the device class for automatic database backup operations. Use the SET DBRECOVERY command to specify the device class that you created in the preceding step. For example, if the device class is dbback\_filedev, issue the following command:

```
set dbrecovery dbback_filedev
```

3. Create schedules for the maintenance operations by using the DEFINE SCHEDULE command. See the following table for the required operations with examples of the commands.

Tip: You create the schedule for replication separately in a later step, when you use the Operations Center to configure replication.

Operation	Example command
Back up the database.	<p>Create a schedule to run the BACKUP DB command. If you are configuring a small system, set the COMPRESS parameter to YES. For example, on a small system, issue the following command to create a backup schedule that uses the new device class:</p> <pre>define schedule DBBACKUP type=admin cmd="backup db     devclass=dbback_filedev type=full numstreams=3     wait=yes     compress=yes" active=yes desc="Back up the     database."     startdate=today starttime=11:00:00 duration=45     durunits=minutes</pre>

Operation	Example command
Back up the device configuration information.	Create a schedule to run the BACKUP DEVCONFIG command:  <pre>define schedule DEVCONFIGBKUP type=admin cmd="backup devconfig   filenames=devconfig.dat" active=yes desc="Backup the device configuration file." startdate=today starttime=17:00:00 duration=45 durunits=minutes</pre>
Back up the volume history.	Create a schedule to run the BACKUP VOLHISTORY command:  <pre>define schedule VOLHISTBKUP type=admin cmd="backup volhistory   filenames=volhist.dat" active=yes desc="Back up the volume history." startdate=today starttime=17:00:00 duration=45 durunits=minutes</pre>
Remove older versions of database backups that are no longer required.	Create a schedule to run the DELETE VOLHISTORY command:  <pre>define schedule DELVOLHIST type=admin cmd="delete volhistory   type=dbb todate=today-6 totime=now" active=yes desc="Remove old database backups." startdate=today starttime=20:00:00 duration=45 durunits=minutes</pre>
Remove objects that exceed their allowed retention.	Create a schedule to run the EXPIRE INVENTORY command. Set the RESOURCE parameter based on the system size that you are configuring: <ul style="list-style-type: none"> <li>o Small systems: 10</li> <li>o Medium systems: 30</li> <li>o Large systems: 40</li> </ul> For example, on a medium-sized system, issue the following command to create a schedule that is named EXPINVENTORY:  <pre>define schedule EXPINVENTORY type=admin cmd="expire inventory   wait=yes resource=30 duration=120" active=yes desc="Remove expired objects." startdate=today starttime=12:00:00 duration=45 durunits=minutes</pre>

## What to do next

After you create schedules for the server maintenance tasks, you can view them in the Operations Center by completing the following steps:

1. On the Operations Center menu bar, hover over Servers.
2. Click Maintenance.

### Related reference:

[DEFINE SCHEDULE](#) (Define a schedule for an administrative command)

## Defining client schedules

Use the Operations Center to create schedules for client operations.

### Procedure

1. On the Operations Center menu bar, hover over Clients.
2. Click Schedules.

3. Click +Schedule.
4. Complete the steps in the Create Schedule wizard. Set client backup schedules to start at 22:00, based on the server maintenance activities that you scheduled in Defining schedules for server maintenance activities.

## Installing and configuring backup-archive clients

---

Following the successful setup of your IBM Spectrum Protect™ server system, install and configure client software to begin backing up data.

### Procedure

---

To install the backup-archive client, follow the installation instructions for your operating system.

- Installing the UNIX and Linux backup-archive clients
- Installing the Windows backup-archive client

### What to do next

---

Register and assign your clients to schedules.

- Registering and assigning clients to schedules  
Add and register your clients through the Operations Center by using the Add Client wizard.
- Installing the client management service  
Install the client management service for backup-archive clients that run on Linux and Windows operating systems. The client management service collects diagnostic information about backup-archive clients and makes the information available to the Operations Center for basic monitoring capability.

## Registering and assigning clients to schedules

---

Add and register your clients through the Operations Center by using the Add Client wizard.

### Before you begin

---

Determine whether the client requires an administrative user ID with client owner authority over the client node. To determine which clients require an administrative user ID, see technote 7048963.

Restriction: For some types of clients, the client node name and the administrative user ID must match. You cannot authenticate those clients by using the Lightweight Directory Access Protocol authentication method that was introduced in V7.1.7. For details about this authentication method, sometimes referred to as integrated mode, see Authenticating users by using an Active Directory database.

### Procedure

---

To register a client, complete one of the following actions.

- If the client requires an administrative user ID, register the client by using the REGISTER NODE command and specify the USERID parameter:

```
register node node_name password userid=node_name
```

where *node\_name* specifies the node name and *password* specifies the node password. For details, see Register a node.

- If the client does not require an administrative user ID, register the client by using the Operations Center Add Client wizard. Complete the following steps:
  - a. On the Operations Center menu bar, click Clients.
  - b. In the Clients table, click +Client.
  - c. Complete the steps in the Add Client wizard:
    - i. Specify that redundant data can be eliminated on both the client and server. In the Client-side data deduplication area, select the Enable check box.
    - ii. In the Configuration window, copy the TCPSEVERADDRESS, TCPPOINT, NODENAME, and DEDUPLICATION option values.  
Tip: Record the option values and keep them in a safe place. After you complete the client registration and install the software on the client node, use the values to configure the client.

- iii. Follow the instructions in the wizard to specify the policy domain, schedule, and option set.
- iv. Set how risks are displayed for the client by specifying the at-risk setting.
- v. Click Add Client.

## Installing the client management service

---

Install the client management service for backup-archive clients that run on Linux and Windows operating systems. The client management service collects diagnostic information about backup-archive clients and makes the information available to the Operations Center for basic monitoring capability.

### Procedure

---

Install the client management service on the same computer as the backup-archive client by completing the following steps:

1. Download the installation package for the client management service from an IBM® download site such as IBM Passport Advantage® or IBM Fix Central. Look for a file name that is similar to `<version>-IBM_Spectrum_Protect-CMS-operating_system.bin`.
  2. Create a directory on the client system that you want to manage, and copy the installation package there.
  3. Extract the contents of the installation package file.
  4. Run the installation batch file from the directory where you extracted the installation and associated files. This is the directory that you created in step 2.
  5. To install the client management service, follow the instructions in the IBM Installation Manager wizard. If IBM Installation Manager is not already installed on the client system, you must select both IBM Installation Manager and IBM Spectrum Protect™ Client Management Services.
- Verifying that the client management service is installed correctly  
Before you use the client management service to collect diagnostic information about a backup-archive client, you can verify that the client management service is correctly installed and configured.
  - Configuring the Operations Center to use the client management service  
If you did not use the default configuration for the client management service, you must configure the Operations Center to access the client management service.

#### Related tasks:

- [🔗 Configuring the client management service for custom client installations](#)

## Verifying that the client management service is installed correctly

---

Before you use the client management service to collect diagnostic information about a backup-archive client, you can verify that the client management service is correctly installed and configured.

### Procedure

---

On the client system, at the command line, run the following commands to view the configuration of the client management service:

- On Linux client systems, issue the following command:

```
client_install_dir/cms/bin/CmsConfig.sh list
```

where `client_install_dir` is the directory where the backup-archive client is installed. For example, with the default client installation, issue the following command:

```
/opt/tivoli/tsm/cms/bin/CmsConfig.sh list
```

The output is similar to the following text:

```
Listing CMS configuration
```

```
server1.example.com:1500 NO_SSL HOSTNAME  
Capabilities: [LOG_QUERY]  
  Opt Path: /opt/tivoli/tsm/client/ba/bin/dsm.sys
```

```
Log File: /opt/tivoli/tsm/client/ba/bin/dsmerror.log  
en_US MM/dd/yyyy HH:mm:ss Windows-1252
```

```
Log File: /opt/tivoli/tsm/client/ba/bin/dsmsched.log
en_US MM/dd/yyyy HH:mm:ss Windows-1252
```

- On Windows client systems, issue the following command:

```
client_install_dir\cms\bin\CmsConfig.bat list
```

where *client\_install\_dir* is the directory where the backup-archive client is installed. For example, with the default client installation, issue the following command:

```
C:"Program Files"\Tivoli\TSM\cms\bin\CmsConfig.bat list
```

The output is similar to the following text:

```
Listing CMS configuration

server1.example.com:1500 NO_SSL HOSTNAME
Capabilities: [LOG_QUERY]
  Opt Path: C:\Program Files\Tivoli\TSM\baclient\dsm.opt

  Log File: C:\Program Files\Tivoli\TSM\baclient\dsmerror.log
  en_US MM/dd/yyyy HH:mm:ss Windows-1252

  Log File: C:\Program Files\Tivoli\TSM\baclient\dmsched.log
  en_US MM/dd/yyyy HH:mm:ss Windows-1252
```

If the client management service is correctly installed and configured, the output displays the location of the error log file. The output text is extracted from the following configuration file:

- On Linux client systems:

```
client_install_dir/cms/Liberty/usr/servers/cmsServer/client-configuration.xml
```

- On Windows client systems:

```
client_install_dir\cms\Liberty\usr\servers\cmsServer\client-configuration.xml
```

If the output does not contain any entries, you must configure the client-configuration.xml file. For instructions to configure this file, see [Configuring the client management service for custom client installations](#). You can use the CmsConfig verify command to verify that a node definition is correctly created in the client-configuration.xml file.

## Configuring the Operations Center to use the client management service

---

If you did not use the default configuration for the client management service, you must configure the Operations Center to access the client management service.

### Before you begin

---

Ensure that the client management service is installed and started on the client system. Verify whether the default configuration is used. The default configuration is not used if either of the following conditions is met:

- The client management service does not use the default port number, 9028.
- The backup-archive client is not accessed by the same IP address as the client system where the backup-archive client is installed. For example, a different IP address might be used in the following situations:
  - The computer system has two network cards. The backup-archive client is configured to communicate on one network, while the client management service communicates on the other network.
  - The client system is configured with the Dynamic Host Configuration Protocol (DHCP). As a result, the client system is dynamically assigned an IP address, which is saved on the server during the previous backup-archive client operation. When the client system is restarted, the client system might be assigned a different IP address. To ensure that the Operations Center can always find the client system, you specify a fully qualified domain name.

### Procedure

---

To configure the Operations Center to use the client management service, complete the following steps:

1. On the Clients page of the Operations Center, select the client.

2. Click Details > Properties.
3. In the Remote diagnostics URL field in the General section, specify the URL for the client management service on the client system. The address must start with `https`. The following table shows examples of the remote diagnostics URL.

Type of URL	Example
With DNS host name and default port, 9028	<code>https://server.example.com</code>
With DNS host name and non-default port	<code>https://server.example.com:1599</code>
With IP address and non-default port	<code>https://192.0.2.0:1599</code>

4. Click Save.

## What to do next

---

You can access client diagnostic information such as client log files from the Diagnosis tab in the Operations Center.

## Configuring the second server

---

After you complete the configuration for the first server in your system, configure the second server.

### Procedure

---

Complete the instructions in the following sections:

1. Configure a second server that is the same as the first server by completing the instructions in the following sections:
  - a. Setting up the system
  - b. Installing the server and Operations Center

Only one server in the multisite disk solution is configured as the hub server, so you do not need to install the Operations Center on the second server. When you select the installation packages to install on the second server, do not select the Operations Center.

- c. Configuring the server and the Operations Center

Skip the tasks for configuring the Operations Center.

- d. Installing and configuring backup-archive clients
2. Configuring SSL communications between the hub server and a spoke server
3. Adding the second server as a spoke
4. Enabling replication

## Configuring SSL communications between the hub server and a spoke server

---

To secure communications between the hub server and a spoke server by using the Transport Layer Security (TLS) protocol, you must define the certificate of the spoke server to the hub server. You must also configure the Operations Center to monitor the spoke server.

### Procedure

---

1. On the spoke server, change to the directory of the spoke server instance.
2. Specify the required `cert256.arm` certificate as the default certificate in the key database file of the spoke server. Issue the following command:

```
gsk8capicmd_64 -cert -setdefault -db cert.kdb -stashed
-label "TSM Server SelfSigned SHA Key"
```

3. Verify the certificates in the key database file of the spoke server. Issue the following command:

```
gsk8capicmd_64 -cert -list -db cert.kdb -stashed
```

4. Securely transfer the `cert256.arm` file of the spoke server to the hub server.
5. On the hub server, change to the directory of the hub server instance.

6. Define the spoke server certificate to the hub server. Issue the following command from the hub server instance directory, where *spoke\_servername* is the name of the spoke server, and *spoke\_cert256.arm* is the file name of the spoke server certificate:

```
gsk8capicmd_64 -cert -add -db cert.kdb -stashed -format ascii  
-label spoke_servername -file spoke_cert256.arm
```

The spoke server does not require the hub server certificate for hub-to-spoke communication. However, other server configurations that require cross-defined servers do require the spoke server to have the hub server certificate.

7. Restart the hub server and the spoke server.
8. For the hub server, issue the DEFINE SERVER command, according to the following example:

```
DEFINE SERVER spoke_servername HLA=spoke_address  
LLA=spoke_SSLTCPADMINPort SERVERPA=spoke_serverpassword
```

Tip: By default, server communication is encrypted except when the server is sending or receiving object data. Object data is sent and received by using TCP/IP. By choosing not to encrypt the object data, server performance is similar to communication over a TCP/IP session and the session is secure. To encrypt all communication with the specified server, even when the server is sending and receiving object data, specify the SSL=YES parameter on the DEFINE SERVER command.

9. On the Operations Center menu bar, click Servers.

In the table on the Servers page, the spoke server that you defined in step 8 typically has a status of "Unmonitored." Depending on the setting for the status refresh interval, you might not see the spoke server immediately.

10. Click the spoke server to highlight the item, and in the table menu bar, click Monitor Spoke.

**Related reference:**

- [DEFINE SERVER \(Define a server for server-to-server communications\)](#)
- [QUERY OPTION \(Query server options\)](#)

## Adding the second server as a spoke

---

After you configure both servers in your environment, add the second server as a spoke to the hub server.

### Procedure

---

1. Open the Operations Center.
2. In the Operations Center menu bar, click Servers.
3. Complete one of the following steps:
  - o Click the server to highlight it, and in the table menu bar, click Monitor Spoke.
  - o If the server that you want to add is not shown in the table, click +Spoke.
4. Complete the steps in the spoke configuration wizard.

## Enabling replication

---

To protect your data, enable node replication in addition to protecting your storage pools.

### Procedure

---

To enable node replication for all of the clients that are registered to the source server, complete the following steps

1. Open the Operations Center.
2. On the Operations Center menu bar, hover over Storage and click Replication.
3. On the Replication page, click +Server Pair.
4. Complete the steps in the Add Server Pair wizard:
  - o Set the source server as the first server that you configured for the multisite disk solution. The target server is the second server.
  - o Set the node replication schedule to start 10 hours after the client backup window, based on the server maintenance activities that you scheduled in Defining schedules for server maintenance activities.
  - o The wizard sets up storage pool protection schedules for you, based on the amount of data that you are protecting and when client replication is scheduled.

## What to do next

---

If you plan to set up mutual replication between the two sites, run the Add Server Pair wizard again and set the second server as the source and the first server as the target.

## Completing the implementation

---

After the IBM Spectrum Protect™ solution is configured and running, test backup operations and set up monitoring to ensure that everything runs smoothly.

### Procedure

---

1. Test backup operations to verify that your data is protected in the way that you expect.
  - a. On the Clients page of the Operations Center, select the clients that you want to back up, and click Back Up.
  - b. On the Servers page of the Operations Center, select the server for which you want to back up the database. Click Back Up, and follow the instructions in the Back Up Database window.
  - c. Verify that the backup operations completed successfully with no warning or error messages.  
Tip: Alternatively, you can use the backup-archive client GUI to back up client data and you can backup the server database by issuing BACKUP DB command from an administrative command-line.
2. Set up monitoring for your solution by following the instructions in Monitoring a multisite disk solution.

## Monitoring a multisite disk solution

---

After you implement a multisite disk solution with IBM Spectrum Protect™, monitor the solution to ensure correct operation. By monitoring the solution daily and periodically, you can identify existing and potential issues. The information that you gather can be used to troubleshoot problems and optimize system performance.

### About this task

---

The preferred way to monitor a solution is by using the Operations Center, which provides overall and detailed system status in a graphical user interface. In addition, you can configure the Operations Center to generate a daily email report that summarizes system status.

In some cases, you might want to use advanced monitoring tools to complete specific monitoring or troubleshooting tasks.

Tip: If you plan to diagnose issues with backup-archive clients on Linux or Windows operating systems, install IBM Spectrum Protect client management services on each computer where a backup-archive client is installed. In this way, you can ensure that the Diagnose button is available in the Operations Center for diagnosing issues with backup-archive clients. To install the client management service, follow the instructions in Installing the client management service.

### Procedure

---

1. Complete daily monitoring tasks. For instructions, see Daily monitoring checklist.
2. Complete periodic monitoring tasks. For instructions, see Periodic monitoring checklist.
3. To verify that your IBM Spectrum Protect solution complies with licensing requirements, follow the instructions in Verifying license compliance.
4. To set up Operations Center to generate email status reports, see Tracking system status by using email reports

## What to do next

---

Resolve any issues that you detect. To resolve an issue by changing the configuration of your solution, follow the instructions in Managing operations for a multisite disk solution. The following resources are also available:

- To resolve performance issues, see Performance.
- To resolve other types of issues, see Troubleshooting.

## Daily monitoring checklist

---

To ensure that you are completing the daily monitoring tasks for your IBM Spectrum Protect™ solution, review the daily monitoring checklist.



Complete the daily monitoring tasks from the Operations Center Overview page. You can access the Overview page by opening the Operations Center and clicking Overviews.

The following figure shows the location for completing each task.









Tip: To run administrative commands for advanced monitoring tasks, use the Operations Center command builder. The command builder provides a type-ahead function to guide you as you enter commands. To open the command builder, go to the Operations Center Overview page. On the menu bar, hover over the settings icon  and click Command Builder.





The following table lists the daily monitoring tasks and provides instructions for completing each task.

Table 1. Daily monitoring tasks

Task	Basic procedures	Advanced procedures and troubleshooting information
<p><b>1</b> Determine whether clients are at risk of being unprotected due to failed or missed backup operations.</p>	<p>To verify whether clients are at risk, in the Clients area, look for an At risk notification. To view details, click the Clients area.</p> <p>If you installed the client management service on a backup-archive client, you can view and analyze the client error and schedule logs by completing the following steps:</p> <ol style="list-style-type: none"> <li>1. In the Clients table, select the client and click Details.</li> <li>2. To diagnose an issue, click Diagnosis.</li> </ol>	<p>For clients that do not have the client management service installed, access the client system to review the client error logs.</p>
<p><b>2</b> Determine whether client-related or server-related errors require attention.</p>	<p>To determine the severity of any reported alerts, in the Alerts area, hover over the columns.</p>	<p>To view additional information about alerts, complete the following steps:</p> <ol style="list-style-type: none"> <li>1. Click the Alerts area.</li> <li>2. In the Alerts table, select an alert.</li> <li>3. In the Activity Log pane, review the messages. The pane displays related messages that were issued before and after the selected alert occurred.</li> </ol>

Task	Basic procedures	Advanced procedures and troubleshooting information
<p><b>3</b> Determine whether servers that are managed by the Operations Center are available to provide data protection services to clients.</p>	<ol style="list-style-type: none"> <li>1. To verify whether servers are at risk, in the Servers area, look for an Unavailable notification.</li> <li>2. To view additional information, click the Servers area.</li> <li>3. Select a server in the Servers table and click Details.</li> </ol>	<p>Tip: If you detect an issue that is related to server properties, update the server properties:</p> <ol style="list-style-type: none"> <li>1. In the Servers table, select a server and click Details.</li> <li>2. To update server properties, click Properties.</li> </ol>
<p><b>4</b> Determine whether sufficient space is available for the server inventory, which consists of the server database, active log, and archive log.</p>	<ol style="list-style-type: none"> <li>1. Click the Servers area.</li> <li>2. In the Status column of the table, view the status of the server and resolve any issues: <ul style="list-style-type: none"> <li>o Normal  Sufficient space is available for the server database, active log, and archive log.</li> <li>o Critical  Insufficient space is available for the server database, active log, or archive log. You must add space immediately, or the data protection services that are provided by the server will be interrupted.</li> <li>o Warning  The server database, active log, or archive log is running out of space. If this condition persists, you must add space.</li> <li>o Unavailable  Status cannot be obtained. Ensure that the server is running, and that there are no network issues. This status is also shown if the monitoring administrator ID is locked or otherwise unavailable on the server. This ID is named IBM-OC-hub_server_name.</li> <li>o Unmonitored  Unmonitored servers are defined to the hub server, but are not configured for management by the Operations Center. To configure an unmonitored server, select the server, and click Monitor Spoke.</li> </ul> </li> </ol>	<p>You can also look for related alerts on the Alerts page. For additional instructions about troubleshooting, see Resolving server problems.</p>

Task	Basic procedures	Advanced procedures and troubleshooting information
<p><b>5</b> Verify server database backup operations.</p>	<p>To determine when a server was most recently backed up, complete the following steps:</p> <ol style="list-style-type: none"> <li>1. Click the Servers area.</li> <li>2. In the Servers table, review the Last Database Backup column.</li> </ol>	<p>To obtain more detailed information about backup operations, complete the following steps:</p> <ol style="list-style-type: none"> <li>1. In the Servers table, select a row and click Details.</li> <li>2. In the DB Backup area, hover over the check marks to review information about backup operations.</li> </ol> <p>If a database was not backed up recently (for example, in the last 24 hours), you can start a backup operation:</p> <ol style="list-style-type: none"> <li>1. On the Operations Center Overview page, click the Servers area.</li> <li>2. In the table, select a server and click Back Up.</li> </ol> <p>To determine whether the server database is configured for automatic backup operations, complete the following steps:</p> <ol style="list-style-type: none"> <li>1. On the menu bar, hover over the settings icon  and click Command Builder.</li> <li>2. Issue the QUERY DB command: <pre>query db f=d</pre> </li> <li>3. In the output, review the Full Device Class Name field. If a device class is specified, the server is configured for automatic database backups.</li> </ol>
<p><b>6</b> Monitor other server maintenance tasks. Server maintenance tasks can include running administrative command schedules, maintenance scripts, and related commands.</p>	<p>To search for information about processes that failed because of server issues, complete the following steps:</p> <ol style="list-style-type: none"> <li>1. Click Servers &gt; Maintenance.</li> <li>2. To obtain the two-week history of a process, view the History column.</li> <li>3. To obtain more information about a scheduled process, hover over the check box that is associated with the process.</li> </ol>	<p>For more information about monitoring processes and resolving issues, see the Operations Center online help.</p>
<p><b>7</b> Verify that the amount of data that was recently sent to and from servers is within the expected range.</p>	<ul style="list-style-type: none"> <li>• To obtain an overview of activity in the last 24 hours, view the Activity area.</li> <li>• To compare activity in the last 24 hours with activity in the previous 24 hours, review the figures in the Current and Previous areas.</li> </ul>	<ul style="list-style-type: none"> <li>• If more data was sent to the server than you expected, determine which clients are backing up more data and investigate the cause. It is possible that client-side data deduplication is not working correctly.</li> <li>• If less data was sent to the server than you expected, investigate whether client backup operations are proceeding on schedule.</li> </ul>

Task	Basic procedures	Advanced procedures and troubleshooting information
<p>8 Verify that storage pools are available to back up client data.</p>	<ol style="list-style-type: none"> <li>1. If problems are indicated in the Storage &amp; Data Availability area, click Pools to view the details: <ul style="list-style-type: none"> <li>o If the Critical  status is displayed, insufficient space is available in the storage pool, or its access status is unavailable.</li> <li>o If the Warning  status is displayed, the storage pool is running out of space, or its access status is read-only.</li> </ul> </li> <li>2. To view the used, free, and total space for your selected storage pool, hover over the entries in the Capacity Used column.</li> </ol>	<p>To view the storage-pool capacity that was used over the past two weeks, select a row in the Storage Pools table and click Details.</p>
<p>9 Verify that storage devices are available for backup operations.</p>	<p>In the Storage &amp; Data Availability area, in the Volumes section, under the capacity bars, review the status that is reported next to Devices. If a Critical  or Warning  status is displayed for any device, investigate the issue. To view details, click Devices.</p>	<p>Disk devices might have a critical or warning status for the following reasons:</p> <ul style="list-style-type: none"> <li>• For DISK device classes, volumes might be offline or have a read-only access status. The Disk Storage column of the Disk Devices table shows the state of volumes.</li> <li>• For FILE device classes that are not shared, directories might be offline. Also, insufficient free space might be available for allocating scratch volumes. The Disk Storage column of the Disk Devices table shows the state of directories.</li> <li>• For FILE device classes that are shared, drives might be unavailable. A drive is unavailable if it is offline, if it stopped responding to the server, or if its path is offline. Other columns of the Disk Devices table show the state of the drives and paths.</li> </ul>

Task	Basic procedures	Advanced procedures and troubleshooting information
<p><b>10</b> Monitor node replication processes.</p>	<ol style="list-style-type: none"> <li>1. To obtain the overall status of node replication processes, view the Replication area on the Operations Center Overview page.</li> <li>2. To view information about each replicated server pair, click the Replication area.</li> <li>3. To view the amount of data that was replicated over the last two weeks and the speed of replication, select a server pair and click Details.</li> <li>4. To view replication information for a client, on the Operations Center Overview page, click Clients. View the information in the Replication Workload column.</li> </ol>	<p>For advanced monitoring, view information about running and ended node replication processes by using commands:</p> <ol style="list-style-type: none"> <li>1. On the Operations Center Overview page, hover over the settings icon  and click Command Builder.</li> <li>2. Issue the QUERY REPLICATION command. For instructions, see QUERY REPLICATION (Query node replication processes). If the replication operation was completed successfully, the <code>Total Files To Replicate</code> value matches the <code>Total Files Replicated</code> value.</li> </ol> <p>To display messages that are related to a node replication process on a source or target replication server, complete the following steps:</p> <ol style="list-style-type: none"> <li>1. On the Operations Center Overview page, click Servers.</li> <li>2. Select the source or target replication server and click Details: <ul style="list-style-type: none"> <li>o To view active tasks, click Active Tasks, select the task, and verify that the Running status is displayed. For details, view the related activity logs.</li> <li>o To view completed tasks, click Completed Tasks, select the task, and ensure that the Completed status is displayed. For details, view the related activity logs.</li> </ul> </li> </ol>

## Periodic monitoring checklist

To help ensure that your solution operates correctly, complete the tasks in the periodic monitoring checklist. Schedule periodic tasks frequently enough so that you can detect potential issues before they become problematic.



Tip: To run administrative commands for advanced monitoring tasks, use the Operations Center command builder. The command builder provides a type-ahead function to guide you as you enter commands. To open the command builder, go to the Operations Center Overview page. On the menu bar, hover over the settings icon  and click Command Builder.

Table 1. Periodic monitoring tasks

Task	Basic procedures	Advanced procedures and troubleshooting
------	------------------	---

Task	Basic procedures	Advanced procedures and troubleshooting
Monitor system performance.	<p>Determine the length of time that is required for client backup operations:</p> <ol style="list-style-type: none"> <li>1. On the Operations Center Overview page, click Clients. Find the server that is associated with the client.</li> <li>2. Click Servers. Select the server and click Details.</li> <li>3. To view the duration of completed tasks in the last 24 hours, click Completed Tasks.</li> <li>4. To view the duration of tasks that were completed more than 24 hours ago, use the QUERY ACTLOG command. Follow the instructions in QUERY ACTLOG (Query the activity log).</li> <li>5. If the duration of client backup operations is increasing and the reasons are not clear, investigate the cause.</li> </ol> <p>If you installed the client management service on a backup-archive client, you can diagnose performance issues for the backup-archive client by completing the following steps:</p> <ol style="list-style-type: none"> <li>1. On the Operations Center Overview page, click Clients.</li> <li>2. Select a backup-archive client and click Details.</li> <li>3. To retrieve client logs, click Diagnosis.</li> </ol>	<p>For instructions about reducing the time that it takes for the client to back up data to the server, see Resolving common client performance problems.</p> <p>Look for performance bottlenecks. For instructions, see Identifying performance bottlenecks.</p> <p>For information about identifying and resolving other performance issues, see Performance.</p>
Determine the disk savings that are provided by data deduplication.	<ol style="list-style-type: none"> <li>1. On the Operations Center Overview page, click Pools.</li> <li>2. Select a pool and click Quick Look.</li> <li>3. In the Data Deduplication area, view the Space saved row.</li> </ol>	<p>For advanced monitoring, to obtain detailed statistics about the data-deduplication process for a specific directory-container storage pool or cloud-container storage pool, complete the following steps:</p> <ol style="list-style-type: none"> <li>1. On the Operations Center Overview page, hover over the settings icon  and click Command Builder.</li> <li>2. Obtain a statistical report by issuing the GENERATE DEDUPSTATS command. Follow the instructions in GENERATE DEDUPSTATS (Generate data deduplication statistics for a directory-container storage pool).</li> <li>3. View the statistical report by issuing the QUERY DEDUPSTATS command. Follow the instructions in QUERY DEDUPSTATS (Query data deduplication statistics).</li> </ol>

Task	Basic procedures	Advanced procedures and troubleshooting
<p>Verify that current backup files for device configuration and volume history information are saved.</p>	<p>Access your storage locations to ensure that the files are available. The preferred method is to save the backup files to two locations.</p> <p>To locate the volume history and device configuration files, complete the following steps:</p> <ol style="list-style-type: none"> <li>1. On the Operations Center Overview page, hover over the settings icon  and click Command Builder.</li> <li>2. To locate the volume history and device configuration files, issue the following commands: <ul style="list-style-type: none"> <li><code>query option volhistory</code></li> <li><code>query option devconfig</code></li> </ul> </li> <li>3. In the output, review the Option Setting column to find the file locations.</li> </ol> <p>If a disaster occurs, both the volume history file and the device configuration file are required to restore the server database.</p>	

Task	Basic procedures	Advanced procedures and troubleshooting
<p>Determine whether sufficient space is available for the instance directory file system.</p>	<p>Verify that at least 20% of free space is available in the instance directory file system. Take the action that is appropriate for your operating system:</p> <ul style="list-style-type: none"> <li> <p><b>AIX</b> To view available space in the file system, on the operating system command line, issue the following command:</p> <pre>df -g instance_directory</pre> <p>where <i>instance_directory</i> specifies the instance directory.</p> </li> <li> <p><b>Linux</b> To view available space in the file system, on the operating system command line, issue the following command:</p> <pre>df -h instance_directory</pre> <p>where <i>instance_directory</i> specifies the instance directory.</p> </li> <li> <p><b>Windows</b> In the Windows Explorer program, right-click the file system and click Properties. View the capacity information.</p> </li> </ul> <p>The preferred location of the instance directory depends on the operating system where the server is installed:</p> <ul style="list-style-type: none"> <li> <p><b>AIX</b>   <b>Linux</b> /home/tsminst1/tsminst1</p> </li> <li> <p><b>Windows</b> C:\tsminst1</p> </li> </ul> <p>Tip: If you completed a planning worksheet, the location of the instance directory is recorded in the worksheet.</p>	
<p>Identify unexpected client activity.</p>	<p>To monitor client activity to determine whether data volumes exceed expected amounts, complete the following steps:</p> <ol style="list-style-type: none"> <li>On the Operations Center Overview page, click the Clients area.</li> <li>To view activity over the past two weeks, double-click any client.</li> <li>To view the number of bytes sent to the client, click the Properties tab.</li> <li>In the Last Session area, view the Sent to client row.</li> </ol>	<p>When you double-click a client in the Clients table, the Activity over 2 Weeks area displays the amount of data that the client sent to the server each day.</p>





Task	Basic procedures	Advanced procedures and troubleshooting
<p>Monitor storage pool growth over time.</p>	<ol style="list-style-type: none"> <li>1. On the Operations Center Overview page, click the Pools area.</li> <li>2. To view the capacity that was used over the last two weeks, select a pool and click Details.</li> </ol>	<p>Tips:</p> <ul style="list-style-type: none"> <li>• To specify the time period that must elapse before all deduplicated extents are removed from a directory-container storage pool or cloud-container storage pool after they are no longer referenced by the inventory, complete the following steps: <ol style="list-style-type: none"> <li>1. On the Storage Pools page of the Operations Center, select the storage pool.</li> <li>2. Click Details &gt; Properties.</li> <li>3. Specify the duration in the <code>Delay period for container reuse</code> field.</li> </ol> </li> <li>• To determine data deduplication performance for directory-container and cloud-container storage pools, use the <code>GENERATE DEDUPSTATS</code> command.</li> <li>• To view data deduplication statistics for a storage pool, complete the following steps: <ol style="list-style-type: none"> <li>1. On the Storage Pools page of the Operations Center, select the storage pool.</li> <li>2. Click Details &gt; Properties.</li> </ol> </li> </ul> <p>Alternatively, use the <code>QUERY EXTENTUPDATES</code> command to display information about updates to data extents in directory-container or cloud-container storage pools. The command output can help you determine which data extents are no longer referenced and which ones are eligible to be deleted from the system. In the output, monitor the number of data extents that are eligible to be deleted from the system. This metric has a direct correlation to the amount of free space that will be available within the container storage pool.</p> <ul style="list-style-type: none"> <li>• To display the amount of physical space that is occupied by a file space after the removal of the data deduplication savings, use the <code>select * from occupancy</code> command. The command output includes the <code>LOGICAL_MB</code> value. <code>LOGICAL_MB</code> is the amount of space that is used by the file space.</li> </ul>
<p>Evaluate the timing of client schedules. Ensure that the start and end times of client schedules meet your business needs.</p>	<p>On the Operations Center Overview page, click Clients &gt; Schedules.</p> <p>In the Schedules table, the Start column displays the configured start time for the scheduled operation. To see when the most recent operation was started, hover over the clock icon.</p>	<p>Tip: You can receive a warning message if a client operation runs longer than expected. Complete the following steps:</p> <ol style="list-style-type: none"> <li>1. On the Operations Center Overview page, hover over Clients and click Schedules.</li> <li>2. Select a schedule and click Details.</li> <li>3. View the details of a schedule by clicking the blue arrow next to the row.</li> <li>4. In the Run time alert field, specify the time when a warning message will be issued if the scheduled operation is not completed.</li> <li>5. Click Save.</li> </ol>

Task	Basic procedures	Advanced procedures and troubleshooting
Evaluate the timing of maintenance tasks. Ensure that the start and end times of maintenance tasks meet your business needs.	<p>On the Operations Center Overview page, click Servers &gt; Maintenance.</p> <p>In the Maintenance table, review the information in the Last Run Time column. To see when the last maintenance task was started, hover over the clock icon.</p>	<p>Tip: If a maintenance task is running too long, change the start time or the maximum run time. Complete the following steps:</p> <ol style="list-style-type: none"> <li>1. On the Operations Center Overview page, hover over the settings icon  and click Command Builder.</li> <li>2. To change the start time or maximum run time for a task, issue the UPDATE SCHEDULE command. For instructions, see UPDATE SCHEDULE (Update a client schedule).</li> </ol>

**Related reference:**

QUERY ACTLOG (Query the activity log)

 UPDATE STGPOOL (Update a storage pool)

 QUERY EXTENTUPDATES (Query updated data extents)

## Verifying license compliance

Verify that your IBM Spectrum Protect™ solution complies with the provisions of your licensing agreement. By verifying compliance regularly, you can track trends in data growth or processor value unit (PVU) usage. Use this information to plan for future license purchasing.

### About this task

The method that you use to verify that your solution complies with license terms varies depending on the provisions of your IBM Spectrum Protect licensing agreement.

#### Front-end capacity licensing

The front-end model determines license requirements based on the amount of primary data that is reported as being backed up by clients. Clients include applications, virtual machines, and systems.

#### Back-end capacity licensing

The back-end model determines license requirements based on the terabytes of data that are stored in primary storage pools and repositories.

Tips:

- To ensure the accuracy of front-end and back-end capacity estimates, install the most recent version of the client software on each client node.
- The front-end and back-end capacity information in the Operations Center is for planning and estimation purposes.

#### PVU licensing

The PVU model is based on the use of PVUs by server devices.

Important: The PVU calculations that are provided by IBM Spectrum Protect are considered estimates and are not legally binding. The PVU licensing information that is reported by IBM Spectrum Protect is not considered an acceptable substitute for the IBM® License Metric Tool.



For the most recent information about licensing models, see the information about product details and licenses at the IBM Spectrum Protect product family website. If you have questions or concerns about licensing requirements, contact your IBM Spectrum Protect software provider.

## Procedure

To monitor license compliance, complete the steps that correspond to the provisions of your licensing agreement.

Tip: The Operations Center provides an email report that summarizes front-end and back-end capacity usage. Reports can be sent automatically to one or more recipients regularly. To configure and manage email reports, click Reports on the Operations Center menu bar.

Option	Description
--------	-------------

Option	Description
<b>Front-end model</b>	<p>a. On the Operations Center menu bar, hover over the settings icon  and click Licensing.</p> <p>The front-end capacity estimate is displayed on the Front-end Usage page.</p> <p>b. If a value is displayed in the Not Reporting column, click the number to identify clients that did not report capacity usage.</p> <p>c. To estimate capacity for clients that did not report capacity usage, go to the following FTP site, which provides measuring tools and instructions:</p> <p><code>ftp://public.dhe.ibm.com/storage/tivoli-storage-management/front_end_capacity_measurement_tools</code></p> <p>To measure front-end capacity by script, complete the instructions in the most recently available licensing guide.</p> <p>d. Add the Operations Center estimate and any estimates that you obtained by using a script.</p> <p>e. Verify that the estimated capacity complies with your licensing agreement.</p>
<b>Back-end model</b>	<p>Restriction: If the source and target replication servers do not use the same policy settings, you cannot use the Operations Center to monitor back-end capacity usage for replicated clients. For information about how to estimate capacity usage for these clients, see technote 1656476.</p> <p>a. On the Operations Center menu bar, hover over the settings icon  and click Licensing.</p> <p>b. Click the Back-end tab.</p> <p>c. Verify that the estimated amount of data complies with your licensing agreement.</p>
<b>PVU model</b>	For information about how to assess compliance with PVU licensing terms, see <a href="#">Assessing compliance with the PVU licensing model</a> .

## Tracking system status by using email reports

Set up the Operations Center to generate email reports that summarize system status. You can configure a mail server connection, change report settings, and optionally create custom SQL reports.

### Before you begin

Before you set up email reports, ensure that the following requirements are met:

- A Simple Mail Transfer Protocol (SMTP) host server is available to send and receive reports by email. The SMTP server must be configured as an open mail relay. You must also ensure that the IBM Spectrum Protect™ server that sends email messages has access to the SMTP server. If the Operations Center is installed on a separate computer, that computer does not require access to the SMTP server.
- To set up email reports, you must have system privilege for the server.
- To specify the recipients, you can enter one or more email addresses or administrator IDs. If you plan to enter an administrator ID, the ID must be registered on the hub server and must have an email address associated with it. To specify an email address for an administrator, use the EMAILADDRESS parameter of the UPDATE ADMIN command.

### About this task

You can configure the Operations Center to send a general operations report, a license compliance report, and one or more custom reports, which use SQL SELECT statements to query managed servers.

### Procedure

To set up and manage email reports, complete the following steps:

1. On the Operations Center menu bar, click Reports.
2. If an email server connection is not yet configured, click Configure Mail Server and complete the fields. After you configure the mail server, the general operations report and license compliance report are enabled.
3. To change report settings, select a report, click Details, and update the form.

- Optional: To add a custom SQL report, click + Report, and complete the fields.  
Tip: To immediately run and send a report, select the report and click Send.

## Results

---

Enabled reports are sent according to the specified settings.

**Related reference:**

[UPDATE ADMIN](#) (Update an administrator)

## Managing operations for a multisite disk solution

---

Use this information to manage operations for a multisite disk solution with IBM Spectrum Protect™ that includes a server and uses data deduplication for multiple locations.

- **Managing the Operations Center**  
The Operations Center provides web and mobile access to status information about the IBM Spectrum Protect environment. You can use the Operations Center to monitor multiple servers and to complete some administrative tasks. The Operations Center also provides web access to the IBM Spectrum Protect command line.
- **Protecting applications, virtual machines, and systems**  
The server protects data for clients, which can include applications, virtual machines, and systems. To start protecting client data, register the client node with the server and select a backup schedule to protect the client data.
- **Managing data storage**  
Manage your data for efficiency and add supported devices and media to the server to store client data.
- **Managing replication**  
Use replication to recover data at a disaster recovery site and to maintain the same level of files on the source and target servers. You can manage replication at the node level. You can also protect data at the storage-pool level.
- **Securing the server**  
Secure the IBM Spectrum Protect server and data by controlling access to servers and client nodes, encrypting data, and maintaining secure access levels and passwords.
- **Stopping and starting the server**  
Before you complete maintenance or reconfiguration tasks, stop the server. Then, start the server in maintenance mode. When you are finished with the maintenance or reconfiguration tasks, restart the server in production mode.
- **Planning to upgrade the server**  
When a fix pack or interim fix becomes available, you can upgrade the IBM Spectrum Protect server to take advantage of product improvements. Servers and clients can be upgraded at different times. Ensure that you complete the planning steps before you upgrade the server.
- **Preparing for an outage or system update**  
Prepare IBM Spectrum Protect to maintain your system in a consistent state during a planned power outage or system update.
- **Implementing a disaster recovery plan**  
Implement a disaster recovery strategy to recover your applications if a disaster occurs and to ensure high server availability.
- **Recovering from data loss or system outages**  
You can use IBM Spectrum Protect to recover data that was lost when a disaster or system outage occurred. You can recover directory-container storage pools, client data, and databases.

## Managing the Operations Center

---

The Operations Center provides web and mobile access to status information about the IBM Spectrum Protect™ environment. You can use the Operations Center to monitor multiple servers and to complete some administrative tasks. The Operations Center also provides web access to the IBM Spectrum Protect command line.

- **Adding and removing spoke servers**  
In a multiple-server environment, you can connect the other servers, called *spoke servers*, to the hub server.
- **Starting and stopping the web server**  
The web server of the Operations Center runs as a service and starts automatically. You might have to stop and start the web server, for example, to make configuration changes.
- **Restarting the initial configuration wizard**  
You might need to restart the initial configuration wizard of the Operations Center, for example, to make configuration changes.

- Changing the hub server  
You can use the Operations Center to remove the hub server of IBM Spectrum Protect, and configure another hub server.
- Restoring the configuration to the preconfiguration state  
If certain problems occur, you might want to restore the Operations Center configuration to the preconfigured state where the IBM Spectrum Protect servers are not defined as hub or spoke servers.

## Adding and removing spoke servers

---

In a multiple-server environment, you can connect the other servers, called *spoke servers*, to the hub server.

### About this task

---

The spoke servers send alerts and status information to the hub server. The Operations Center shows you a consolidated view of alerts and status information for the hub server and any spoke servers.

- Adding a spoke server  
After you configure the hub server for the Operations Center, you can add one or more spoke servers to the hub server.
- Removing a spoke server  
You can remove a spoke server from the Operations Center.

## Adding a spoke server

---

After you configure the hub server for the Operations Center, you can add one or more spoke servers to the hub server.

### Before you begin

---

Communication between the spoke server and the hub server must be secured by using the Transport Layer Security (TLS) protocol. To secure communication, add the certificate of the spoke server to the truststore file of the hub server.

### Procedure

---

1. In the Operations Center menu bar, click Servers. The Servers page opens.

In the table on the Servers page, a server might have a status of "Unmonitored." This status means that although an administrator defined this server to the hub server by using the DEFINE SERVER command, the server is not yet configured as a spoke server.

2. Complete one of the following steps:
  - Click the server to highlight it, and in the table menu bar, click Monitor Spoke.
  - If the server that you want to add is not shown in the table, and secure SSL/TLS communication is not required, click + Spoke in the table menu bar.
3. Provide the necessary information, and complete the steps in the spoke configuration wizard.  
Tip: If the event-record retention period of the server is less than 14 days, the period is automatically reset to 14 days if you configure the server as a spoke server.

## Removing a spoke server

---

You can remove a spoke server from the Operations Center.

### About this task

---

You might need to remove a spoke server in the following situations, for example:

- You want to move the spoke server from one hub server to another hub server.
- You want to decommission the spoke server.

### Procedure

---

To remove the spoke server from the group of servers that are managed by the hub server, complete the following steps:

1. From the IBM Spectrum Protect™ command line, issue the following command on the hub server:

```
QUERY MONITORSETTINGS
```

2. From the output of the command, copy the name that is in the Monitored Group field.
3. Issue the following command on the hub server, where *group\_name* represents the name of the monitored group, and *member\_name* represents the name of the spoke server:

```
DELETE GRPMEMBER group_name member_name
```

4. Optional: If you want to move the spoke server from one hub server to another hub server, do **not** complete this step. Otherwise, you can disable alerting and monitoring on the spoke server by issuing the following commands on the spoke server:

```
SET STATUSMONITOR OFF  
SET ALERTMONITOR OFF
```

5. Optional: If the spoke server definition is used for other purposes, such as enterprise configuration, command routing, storing virtual volumes, or library management, do **not** complete this step. Otherwise, you can delete the spoke server definition on the hub server by issuing the following command on the hub server:

```
DELETE SERVER spoke_server_name
```

## Starting and stopping the web server

---

The web server of the Operations Center runs as a service and starts automatically. You might have to stop and start the web server, for example, to make configuration changes.

### Procedure

---

1. Stop the web server.
  - o **AIX** From the */installation\_dir/ui/utls* directory, where *installation\_dir* represents the directory where the Operations Center is installed, issue the following command:

```
./stopserver.sh
```

- o **Linux** Issue the following command:

```
service opscenter.rc stop
```

- o **Windows** From the Services window, stop the IBM Spectrum Protect™ Operations Center service.

2. Start the web server.

- o **AIX** From the */installation\_dir/ui/utls* directory, where *installation\_dir* represents the directory where the Operations Center is installed, issue the following command:

```
./startserver.sh
```

- o **Linux** Issue the following commands:

Start the server:

```
service opscenter.rc start
```

Restart the server:

```
service opscenter.rc restart
```

Determine whether the server is running:

```
service opscenter.rc status
```

- o **Windows** From the Services window, start the IBM Spectrum Protect Operations Center service.

## Restarting the initial configuration wizard

---

You might need to restart the initial configuration wizard of the Operations Center, for example, to make configuration changes.

## Before you begin

---

To change the following settings, use the Settings page in the Operations Center rather than restarting the initial configuration wizard:

- The frequency at which status data is refreshed
- The duration that alerts remain active, inactive, or closed
- The conditions that indicate that clients are at risk

The Operations Center help includes more information about how to change these settings.

## About this task

---

To restart the initial configuration wizard, you must delete a properties file that includes information about the hub server connection. However, any alerting, monitoring, at-risk, or multiserver settings that were configured for the hub server are not deleted. These settings are used as the default settings in the configuration wizard when the wizard restarts.

## Procedure

---

1. Stop the Operations Center web server.
  2. On the computer where the Operations Center is installed, go to the following directory, where *installation\_dir* represents the directory in which the Operations Center is installed:
    - o **AIX** | **Linux** *installation\_dir*/ui/Liberty/usr/servers/guiServer
    - o **Windows** *installation\_dir*\ui\Liberty\usr\servers\guiServer
- For example:
- o **AIX** | **Linux** /opt/tivoli/tsm/ui/Liberty/usr/servers/guiServer
  - o **Windows** c:\Program Files\Tivoli\TSM\ui\Liberty\usr\servers\guiServer
3. In the guiServer directory, delete the serverConnection.properties file.
  4. Start the Operations Center web server.
  5. Open the Operations Center.
  6. Use the configuration wizard to reconfigure the Operations Center. Specify a new password for the monitoring administrator ID.
  7. On any spoke servers that were previously connected to the hub server, update the password for the monitoring administrator ID by issuing the following command from the IBM Spectrum Protect™ command-line interface:

```
UPDATE ADMIN IBM-OC-hub_server_name new_password
```

Restriction: Do not change any other settings for this administrator ID. After you specify the initial password, this password is managed automatically by the Operations Center.

## Changing the hub server

---

You can use the Operations Center to remove the hub server of IBM Spectrum Protect™, and configure another hub server.

## Procedure

---

1. Restart the initial configuration wizard of the Operations Center. As part of this procedure, you delete the existing hub server connection.
2. Use the wizard to configure the Operations Center to connect to the new hub server.

### Related tasks:

Restarting the initial configuration wizard

## Restoring the configuration to the preconfiguration state

---

If certain problems occur, you might want to restore the Operations Center configuration to the preconfigured state where the IBM Spectrum Protect™ servers are not defined as hub or spoke servers.

## Procedure

---

To restore the configuration, complete the following steps:

1. Stop the Operations Center web server.
2. Unconfigure the hub server by completing the following steps:
  - a. On the hub server, issue the following commands:

```
SET MONITORINGADMIN ""
SET MONITOREDSEVERGROUP ""
SET STATUSMONITOR OFF
SET ALERTMONITOR OFF
REMOVE ADMIN IBM-OC-hub_server_name
```

Tip: *IBM-OC-hub\_server\_name* represents the monitoring administrator ID that was automatically created when you initially configured the hub server.

- b. Reset the password for the hub server by issuing the following command on the hub server:

```
SET SERVERPASSWORD ""
```

Attention: Do not complete this step if the hub server is configured with other servers for other purposes, such as library sharing, exporting and importing of data, or node replication.

3. Unconfigure any spoke servers by completing the following steps:
  - a. On the hub server, to determine whether any spoke servers remain as members of the server group, issue the following command:

```
QUERY SERVERGROUP IBM-OC-hub_server_name
```

Tip: *IBM-OC-hub\_server\_name* represents the name of the monitored server group that was automatically created when you configured the first spoke server. This server group name is also the same as the monitoring administrator ID that was automatically created when you initially configured the hub server.

- b. On the hub server, to delete spoke servers from the server group, issue the following command for each spoke server:

```
DELETE GRPMEMBER IBM-OC-hub_server_name spoke_server_name
```

- c. After all spoke servers are deleted from the server group, issue the following commands on the hub server:

```
DELETE SERVERGROUP IBM-OC-hub_server_name
SET MONITOREDSEVERGROUP ""
```

- d. On each spoke server, issue the following commands:

```
REMOVE ADMIN IBM-OC-hub_server_name
SETOPT PUSHSTATUS NO
SET ALERTMONITOR OFF
SET STATUSMONITOR OFF
```

- e. On each spoke server, delete the definition of the hub server by issuing the following command:

```
DELETE SERVER hub_server_name
```

Attention: Do not complete this step if the definition is used for other purposes, such as library sharing, exporting and importing of data, or node replication.

- f. On the hub server, delete the definition of each spoke server by issuing the following command:

```
DELETE SERVER spoke_server_name
```

Attention: Do not complete this step if the server definition is used for other purposes, such as library sharing, exporting and importing of data, or node replication.

4. Restore the default settings on each server by issuing the following commands:

```
SET STATUSREFRESHINTERVAL 5
SET ALERTUPDATEINTERVAL 10
SET ALERTACTIVEDURATION 480
SET ALERTINACTIVEDURATION 480
SET ALERTCLOSEDDURATION 60
SET STATUSATRISKINTERVAL TYPE=AP INTERVAL=24
SET STATUSATRISKINTERVAL TYPE=VM INTERVAL=24
SET STATUSATRISKINTERVAL TYPE=SY INTERVAL=24
SET STATUSSKIPASFAILURE YES TYPE=ALL
```

5. Restart the initial configuration wizard of the Operations Center.

#### Related tasks:



Restarting the initial configuration wizard  
Starting and stopping the web server

## Protecting applications, virtual machines, and systems

---

The server protects data for clients, which can include applications, virtual machines, and systems. To start protecting client data, register the client node with the server and select a backup schedule to protect the client data.

- **Adding clients**  
After you implement a data protection solution with IBM Spectrum Protect, you can expand the solution by adding clients.
- **Managing client operations**  
You can evaluate and resolve errors that are related to a backup-archive client by using the Operations Center, which provides suggestions for resolving errors. For errors on other types of clients, you must examine the error logs on the client and review the product documentation.
- **Managing client upgrades**  
When a fix pack or interim fix becomes available for a client, you can upgrade the client to take advantage of product improvements. Servers and clients can be upgraded at different times and can be at different levels with some restrictions.
- **Decommissioning a client node**  
If a client node is no longer required, you can start a process to remove it from the production environment. For example, if a workstation was backing up data to the IBM Spectrum Protect server, but the workstation is no longer used, you can decommission the workstation.
- **Deactivating data to free storage space**  
In some cases, you can deactivate data that is stored on the IBM Spectrum Protect server. When you run the deactivation process, any backup data that was stored before the specified date and time is deactivated and will be deleted as it expires. In this way, you can free space on the server.

## Adding clients

---

After you implement a data protection solution with IBM Spectrum Protect™, you can expand the solution by adding clients.

### About this task

---

The procedure describes basic steps for adding a client. For more specific instructions about configuring clients, see the documentation for the product that you install on the client node. You can have the following types of client nodes:

#### Application client nodes

Application client nodes include email servers, databases, and other applications. For example, any of the following applications can be an application client node:

- IBM Spectrum Protect Snapshot
- IBM Spectrum Protect for Databases
- IBM Spectrum Protect for Enterprise Resource Planning
- IBM Spectrum Protect for Mail
- IBM Spectrum Protect for Virtual Environments

#### System client nodes

System client nodes include workstations, network-attached storage (NAS) file servers, and API clients.

#### Virtual machine client nodes

Virtual machine client nodes consist of an individual guest host within a hypervisor. Each virtual machine is represented as a file space.

## Procedure

---

To add a client, complete the following steps:

1. Select the software to install on the client node and plan the installation. Follow the instructions in [Selecting the client software and planning the installation](#).
2. Specify how to back up and archive client data. Follow the instructions in [Specifying rules for backing up and archiving client data](#).
3. Specify when to back up and archive client data. Follow the instructions in [Scheduling backup and archive operations](#).
4. To allow the client to connect to the server, register the client. Follow the instructions in [Registering clients](#).

- To start protecting a client node, install and configure the selected software on the client node. Follow the instructions in *Installing and configuring clients*.

## Selecting the client software and planning the installation

Different types of data require different types of protection. Identify the type of data that you must protect and select the appropriate software.

### About this task

The preferred practice is to install the backup-archive client on all client nodes so that you can configure and start the client acceptor on the client node. The client acceptor is designed to efficiently run scheduled operations.

The client acceptor runs schedules for the following products: the backup-archive client, IBM Spectrum Protect™ for Databases, IBM Spectrum Protect for Enterprise Resource Planning, IBM Spectrum Protect for Mail, and IBM Spectrum Protect for Virtual Environments. If you install a product for which the client acceptor does not run schedules, you must follow the configuration instructions in the product documentation to ensure that scheduled operations can occur.

### Procedure

Based on your goal, select the products to install and review the installation instructions.

Tip: If you install the client software now, you must also complete the client configuration tasks that are described in *Installing and configuring clients* before you can use the client.

Goal	Product and description	Installation instructions
Protect a file server or workstation	The backup-archive client backs up and archives files and directories from file servers and workstations to storage. You can also restore and retrieve backup versions and archived copies of files.	<ul style="list-style-type: none"> <li>Backup-archive client requirements</li> <li>Installing the UNIX and Linux backup-archive clients</li> <li>Installing the Windows backup-archive client</li> </ul>
Protect applications with snapshot backup and restore capabilities	IBM Spectrum Protect Snapshot protects data with integrated, application-aware snapshot backup and restore capabilities. You can protect data that is stored by IBM DB2® database software and SAP, Oracle, Microsoft Exchange, and Microsoft SQL Server applications.	<ul style="list-style-type: none"> <li>Installing and upgrading IBM Spectrum Protect Snapshot for UNIX and Linux</li> <li>Installing and upgrading IBM Spectrum Protect Snapshot for VMware</li> <li>Installing and upgrading IBM Spectrum Protect Snapshot for Windows</li> </ul>
Protect an email application on an IBM Domino® server	IBM Spectrum Protect for Mail: Data Protection for IBM® Domino automates data protection so that backups are completed without shutting down IBM Domino servers.	<ul style="list-style-type: none"> <li>Installation of Data Protection for IBM Domino on a UNIX, AIX, or Linux system (V7.1.0)</li> <li>Installation of Data Protection for IBM Domino on a Windows system (V7.1.0)</li> </ul>
Protect an email application on a Microsoft Exchange server	IBM Spectrum Protect for Mail: Data Protection for Microsoft Exchange Server automates data protection so that backups are completed without shutting down Microsoft Exchange servers.	Installing, upgrading, and migrating IBM Spectrum Protect for Mail: Data Protection for Microsoft Exchange Server
Protect an IBM DB2 database	The application programming interface (API) of the backup-archive client can be used to back up DB2 data to the IBM Spectrum Protect server.	Installing the IBM Spectrum Protect backup-archive clients (UNIX, Linux, and Windows)
Protect an IBM Informix® database	The API of the backup-archive client can be used to back up Informix data to the IBM Spectrum Protect server.	Installing the IBM Spectrum Protect backup-archive clients (UNIX, Linux, and Windows)
Protect a Microsoft SQL database	IBM Spectrum Protect for Databases: Data Protection for Microsoft SQL Server protects Microsoft SQL data.	Installing Data Protection for SQL Server on Windows Server Core

Goal	Product and description	Installation instructions
Protect an Oracle database	IBM Spectrum Protect for Databases: Data Protection for Oracle protects Oracle data.	Data Protection for Oracle installation
Protect an SAP environment	IBM Spectrum Protect for Enterprise Resource Planning: Data Protection for SAP provides protection that is customized for SAP environments. The product is designed to improve the availability of SAP database servers and reduce administration workload.	<ul style="list-style-type: none"> <li>Installing IBM Spectrum Protect for Enterprise Resource Planning: Data Protection for SAP for DB2</li> <li>Installing IBM Spectrum Protect for Enterprise Resource Planning: Data Protection for SAP for Oracle</li> </ul>
Protect a virtual machine	<p>IBM Spectrum Protect for Virtual Environments provides protection that is tailored for Microsoft Hyper-V and VMware virtual environments. You can use IBM Spectrum Protect for Virtual Environments to create incremental forever backups that are stored on a centralized server, create backup policies, and restore virtual machines or individual files.</p> <p>Alternatively, use the backup-archive client to back up and restore a full VMware or Microsoft Hyper-V virtual machine. You can also back up and restore files or directories from a VMware virtual machine.</p>	<ul style="list-style-type: none"> <li>Installing Data Protection for Microsoft Hyper-V</li> <li>Installing and upgrading Data Protection for VMware</li> <li>Installing the IBM Spectrum Protect backup-archive clients (UNIX, Linux, and Windows)</li> </ul>

Tip: To use the client for space management, you can install IBM Spectrum Protect for Space Management or IBM Spectrum Protect HSM for Windows.

## Specifying rules for backing up and archiving client data

Before you add a client, ensure that appropriate rules are specified for backing up and archiving the client data. During the client registration process, you assign the client node to a policy domain, which has the rules that control how and when client data is stored.

### Before you begin

Determine how to proceed:

- If you are familiar with the policies that are configured for your solution and you know that they do not require changes, continue with Scheduling backup and archive operations.
- If you are not familiar with the policies, follow the steps in this procedure.

### About this task

Policies affect how much data is stored over time, and how long data is retained and available for clients to restore. To meet objectives for data protection, you can update the default policy and create your own policies. A policy includes the following rules:

- How and when files are backed up and archived to server storage
- The number of copies of a file and the length of time copies are kept in server storage

During the client registration process, you assign a client to a *policy domain*. The policy for a specific client is determined by the rules in the policy domain to which the client is assigned. In the policy domain, the rules that are in effect are in the active *policy set*.

When a client backs up or archives a file, the file is bound to a management class in the active policy set of the policy domain. A *management class* is the key set of rules for managing client data. The backup and archive operations on the client use the settings in the default management class of the policy domain unless you further customize policy. A policy can be customized by defining more management classes and assigning their use through client options.

Client options can be specified in a local, editable file on the client system and in a client option set on the server. The options in the client option set on the server can override or add to the options in the local client option file.

## Procedure

---

1. Review the policies that are configured for your solution by following the instructions in Viewing policies.
2. If you need to make minor changes to meet data retention requirements, follow the instructions in Editing policies.
3. Optional: If you need to create policy domains or make extensive changes to policies to meet data retention requirements, see Customizing policies.

## Viewing policies

---

View policies to determine whether they must be edited to meet your requirements.

## Procedure

---

1. To view the active policy set for a policy domain, complete the following steps:
  - a. On the Services page of the Operations Center, select a policy domain and click Details.
  - b. On the Summary page for the policy domain, click the Policy Sets tab.
2. To view inactive policy sets for a policy domain, complete the following steps:
  - a. On the Policy Sets page, click the Configure toggle. You can now view and edit the policy sets that are inactive.
  - b. Scroll through the inactive policy sets by using the forward and back arrows. When you view an inactive policy set, the settings that differentiate the inactive policy set from the active policy set are highlighted.
  - c. Click the Configure toggle. The policy sets are no longer editable.

## Editing policies

---

To change the rules that apply to a policy domain, edit the active policy set for the policy domain. You can also activate a different policy set for a domain.

## Before you begin

---

Changes to policy can affect data retention. Ensure that you continue to back up data that is essential to your organization so that you can restore that data if a disaster occurs. Also, ensure that your system has sufficient storage space for planned backup operations.

## About this task

---

You edit a policy set by changing one or more management classes within the policy set. If you edit the active policy set, the changes are not available to clients unless you reactivate the policy set. To make the edited policy set available to clients, activate the policy set.

Although you can define multiple policy sets for a policy domain, only one policy set can be active. When you activate a different policy set, it replaces the currently active policy set.

To learn about preferred practices for defining policies, see Customizing policies.

## Procedure

---

1. On the Services page of the Operations Center, select a policy domain and click Details.
2. On the Summary page for the policy domain, click the Policy Sets tab.

The Policy Sets page indicates the name of the active policy set and lists all of the management classes for that policy set.

3. Click the Configure toggle. The policy set is editable.
4. Optional: To edit a policy set that is not active, click the forward and back arrows to locate the policy set.
5. Edit the policy set by completing any of the following actions:

Option	Description
--------	-------------

Option	Description
<b>Add a management class</b>	a. In the Policy Sets table, click +Management Class. b. To specify the rules for backing up and archiving data, complete the fields in the Add Management Class window. c. To make the management class the default management class, select the Make default check box. d. Click Add.
<b>Delete a management class</b>	In the Management Class column, click -. Tip: To delete the default management class, you must first assign a different management class as the default.
<b>Make a management class the default management class</b>	In the Default column for the management class, click the radio button. Tip: The default management class manages client files when another management class is not assigned to, or appropriate for managing, a file. To ensure that clients can always back up and archive files, choose a default management class that contains rules for both backing up and archiving files.
<b>Modify a management class</b>	To change the properties of a management class, update the fields in the table.

6. Click Save.

Attention: When you activate a new policy set, data might be lost. Data that is protected under one policy set might not be protected under another policy set. Therefore, before you activate a policy set, ensure that the differences between the previous policy set and the new policy set do not cause data to be lost.

7. Click Activate. A summary of the differences between the active policy set and the new policy set is displayed. Ensure that the changes in the new policy set are consistent with your data retention requirements by completing the following steps:
- Review the differences between corresponding management classes in the two policy sets, and consider the consequences for client files. Client files that are bound to management classes in the active policy set will be bound to the management classes with the same names in the new policy set.
  - Identify management classes in the active policy set that do not have counterparts in the new policy set, and consider the consequences for client files. Client files that are bound to these management classes will be managed by the default management class in the new policy set.
  - If the changes to be implemented by the policy set are acceptable, select the I understand that these updates can cause data loss check box and click Activate.

## Scheduling backup and archive operations

Before you register a new client with the server, ensure that a schedule is available to specify when backup and archive operations take place. During the registration process, you assign a schedule to the client.

### Before you begin

Determine how to proceed:

- If you are familiar with the schedules that are configured for the solution and you know that they do not require modification, continue with Registering clients.
- If you are not familiar with the schedules or the schedules require modification, follow the steps in this procedure.

### About this task

Typically, backup operations for all clients must be completed daily. Carefully schedule client and server workloads to achieve the best performance for your storage environment. To avoid the overlap of client and server operations, consider scheduling client backup and archive operations so that they run at night. If client and server operations overlap or are not given enough time and resources to be processed, you might experience decreased system performance, failed operations, and other issues.

### Procedure

- Review available schedules by hovering over Clients on the Operations Center menu bar. Click Schedules.
- Optional: Modify or create a schedule by completing the following steps:

Option	Description
--------	-------------

Option	Description
<b>Modify a schedule</b>	<ol style="list-style-type: none"> <li>In the Schedules view, select the schedule and click Details.</li> <li>On the Schedule Details page, view details by clicking the blue arrows at the beginning of the rows.</li> <li>Modify the settings in the schedule, and click Save.</li> </ol>
<b>Create a schedule</b>	In the Schedules view, click +Schedule and complete the steps to create a schedule.

- Optional: To configure schedule settings that are not visible in the Operations Center, use a server command. For example, you might want to schedule a client operation that backs up a specific directory and assigns it to a management class other than the default.
  - On the Overview page of the Operations Center, hover over the settings icon  and click Command Builder.
  - Issue the DEFINE SCHEDULE command to create a schedule or the UPDATE SCHEDULE command to modify a schedule. For details about the commands, see DEFINE SCHEDULE (Define a schedule for an administrative command) or UPDATE SCHEDULE (Update a client schedule).

**Related tasks:**

- [Tuning the schedule for daily operations](#)

## Registering clients

Register a client to ensure that the client can connect to the server, and the server can protect client data.

### Before you begin

Determine whether the client requires an administrative user ID with client owner authority over the client node. To determine which clients require an administrative user ID, see technote 7048963.

Restriction: For some types of clients, the client node name and the administrative user ID must match. You cannot authenticate those clients by using the Lightweight Directory Access Protocol authentication method that was introduced in V7.1.7. For details about this authentication method, sometimes referred to as integrated mode, see Authenticating users by using an Active Directory database.

### Procedure

To register a client, complete one of the following actions.

- If the client requires an administrative user ID, register the client by using the REGISTER NODE command and specify the USERID parameter:

```
register node node_name password userid=node_name
```

where *node\_name* specifies the node name and *password* specifies the node password. For details, see Register a node.

- If the client does not require an administrative user ID, register the client by using the Operations Center Add Client wizard. Complete the following steps:
  - On the Operations Center menu bar, click Clients.
  - In the Clients table, click +Client.
  - Complete the steps in the Add Client wizard:
    - Specify that redundant data can be eliminated on both the client and server. In the Client-side data deduplication area, select the Enable check box.
    - In the Configuration window, copy the TCPSEVERADDRESS, TCPPOINT, NODENAME, and DEDUPLICATION option values.

Tip: Record the option values and keep them in a safe place. After you complete the client registration and install the software on the client node, use the values to configure the client.
    - Follow the instructions in the wizard to specify the policy domain, schedule, and option set.
    - Set how risks are displayed for the client by specifying the at-risk setting.
    - Click Add Client.

**Related reference:**

- [Tcpserveraddress option](#)
- [Tcppoint option](#)
- [Nodename option](#)

## Installing and configuring clients

To start protecting a client node, you must install and configure the selected software.

### Procedure

If you already installed the software, start at step 2.

1. Take one of the following actions:

- To install software on an application or client node, follow the instructions.

Software	Link to instructions
IBM Spectrum Protect™ backup-archive client	<ul style="list-style-type: none"> <li>▪ Installing the UNIX and Linux backup-archive clients</li> <li>▪ Installing the Windows backup-archive client</li> </ul> <p>For information about manual deployment of client updates from the server, see the following documents:</p> <ul style="list-style-type: none"> <li>▪ For IBM Spectrum Protect 8.1.2 or later servers, see technote 2004596.</li> <li>▪ For IBM® Tivoli® Storage Manager V7.1 servers and IBM Spectrum Protect V8.1.0 and V8.1.1 servers, see technote 1673299.</li> </ul>
IBM Spectrum Protect for Databases	<ul style="list-style-type: none"> <li>▪ Data Protection for Oracle installation</li> <li>▪ Installing Data Protection for SQL Server on Windows Server Core</li> </ul>
IBM Spectrum Protect for Mail	<ul style="list-style-type: none"> <li>▪ Installation of Data Protection for IBM Domino on a UNIX, AIX, or Linux system (V7.1.0)</li> <li>▪ Installation of Data Protection for IBM Domino on a Windows system (V7.1.0)</li> <li>▪ Installing, upgrading, and migrating IBM Spectrum Protect for Mail: Data Protection for Microsoft Exchange Server</li> </ul>
IBM Spectrum Protect Snapshot	<ul style="list-style-type: none"> <li>▪ Installing and upgrading IBM Spectrum Protect Snapshot for UNIX and Linux</li> <li>▪ Installing and upgrading IBM Spectrum Protect Snapshot for VMware</li> <li>▪ Installing and upgrading IBM Spectrum Protect Snapshot for Windows</li> </ul>
IBM Spectrum Protect for Enterprise Resource Planning	<ul style="list-style-type: none"> <li>▪ Installing IBM Spectrum Protect for Enterprise Resource Planning: Data Protection for SAP for DB2®</li> <li>▪ Installing IBM Spectrum Protect for Enterprise Resource Planning: Data Protection for SAP for Oracle</li> </ul>

- To install software on a virtual machine client node, follow the instructions for the selected backup type.

Backup type	Link to instructions
If you plan to create full VMware backups of virtual machines, install and configure the IBM Spectrum Protect backup-archive client.	<ul style="list-style-type: none"> <li>▪ Installing the UNIX and Linux backup-archive clients</li> <li>▪ Installing the Windows backup-archive client</li> </ul>
If you plan to create incremental forever full backups of virtual machines, install and configure IBM Spectrum Protect for Virtual Environments and the backup-archive client on the same client node or on different client nodes.	<ul style="list-style-type: none"> <li>▪ IBM Spectrum Protect for Virtual Environments online product documentation</li> </ul> <p>Tip: You can obtain the software for IBM Spectrum Protect for Virtual Environments and the backup-archive client in the IBM Spectrum Protect for Virtual Environments installation package.</p>

2. To allow the client to connect to the server, add or update the values for the TCPSERVERADDRESS, TCPPOINT, and NODENAME options in the client options file. Use the values that you recorded when you registered the client (Registering clients).

- For clients that are installed on an AIX®, Linux, or Mac OS X operating system, add the values to the client system-options file, dsm.sys.
- For clients that are installed on a Windows operating system, add the values to the dsm.opt file.

- By default, the options files are in the installation directory.
3. If you installed a backup-archive client on a Linux or Windows operating system, install the client management service on the client. Follow the instructions in [Installing the client management service](#).
  4. Configure the client to run scheduled operations. Follow the instructions in [Configuring the client to run scheduled operations](#).
  5. Optional: Configure communications through a firewall. Follow the instructions in [Configuring client/server communications through a firewall](#).
  6. Run a test backup to verify that data is protected as you planned. For example, for a backup-archive client, complete the following steps:
    - a. On the Clients page of the Operations Center, select the client that you want to back up, and click Back Up.
    - b. Verify that the backup completes successfully and that there are no warning or error messages.
  7. Monitor the results of the scheduled operations for the client in the Operations Center.

## What to do next

---

To change what is getting backed up from the client, follow the instructions in [Modifying the scope of a client backup](#).

## Configuring the client to run scheduled operations

---

You must configure and start a client scheduler on the client node. The client scheduler enables communication between the client and server so that scheduled operations can occur. For example, scheduled operations typically include backing up files from a client.

### About this task

---

The preferred method is to install the backup-archive client on all client nodes so that you can configure and start the client acceptor on the client node. The client acceptor is designed to efficiently run scheduled operations. The client acceptor manages the client scheduler so that the scheduler runs only when required:

- When it is time to query the server about the next scheduled operation
- When it is time to start the next scheduled operation

By using the client acceptor, you can reduce the number of background processes on the client and help to avoid memory retention problems.

The client acceptor runs schedules for the following products: the backup-archive client, IBM Spectrum Protect™ for Databases, IBM Spectrum Protect for Enterprise Resource Planning, IBM Spectrum Protect for Mail, and IBM Spectrum Protect for Virtual Environments. If you installed a product for which the client acceptor does not run schedules, follow the configuration instructions in the product documentation to ensure that scheduled operations can occur.

If your business uses a third-party scheduling tool as standard practice, you can use that scheduling tool as an alternative to the client acceptor. Typically, third-party scheduling tools start client programs directly by using operating system commands. To configure a third-party scheduling tool, see the product documentation.

## Procedure

---

To configure and start the client scheduler by using the client acceptor, follow the instructions for the operating system that is installed on the client node:

AIX® and Oracle Solaris

- a. From the backup-archive client GUI, click Edit > Client Preferences.
- b. Click the Web Client tab.
- c. In the Managed Services Options field, click Schedule. If you also want the client acceptor to manage the web client, click the Both option.
- d. To ensure that the scheduler can start unattended, in the `dsm.sys` file, set the `passwordaccess` option to `generate`.
- e. To store the client node password, issue the following command and enter the client node password when prompted:

```
dsmc query sess
```

- f. Start the client acceptor by issuing the following command on the command line:



```
/usr/bin/dsmcad
```

- g. To enable the client acceptor to start automatically after a system restart, add the following entry to the system startup file (typically, `/etc/inittab`):

```
tsm::once:/usr/bin/dsmcad > /dev/null 2>&1 # Client Acceptor Daemon
```

## Linux

- From the backup-archive client GUI, click Edit > Client Preferences.
- Click the Web Client tab.
- In the Managed Services Options field, click Schedule. If you also want the client acceptor to manage the web client, click the Both option.
- To ensure that the scheduler can start unattended, in the `dsm.sys` file, set the `passwordaccess` option to `generate`.
- To store the client node password, issue the following command and enter the client node password when prompted:

```
dsmc query sess
```

- f. Start the client acceptor by logging in with the root user ID and issuing the following command:

```
service dsmcad start
```

- g. To enable the client acceptor to start automatically after a system restart, add the service by issuing the following command at a shell prompt:

```
# chkconfig --add dsmcad
```

## MAC OS X

- In the backup-archive client GUI, click Edit > Client Preferences.
- To ensure that the scheduler can start unattended, click Authorization, select Password Generate, and click Apply.
- To specify how services are managed, click Web Client, select Schedule, click Apply, and click OK.
- To ensure that the generated password is saved, restart the backup-archive client.
- Use the IBM Spectrum Protect Tools for Administrators application to start the client acceptor.

## Windows

- In the backup-archive client GUI, click Utilities > Setup Wizard > Help me configure the Client Scheduler. Click Next.
- Read the information on the Scheduler Wizard page and click Next.
- On the Scheduler Task page, select Install a new or additional scheduler and click Next.
- On the Scheduler Name and Location page, specify a name for the client scheduler that you are adding. Then, select Use the Client Acceptor daemon (CAD) to manage the scheduler and click Next.
- Enter the name that you want to assign to this client acceptor. The default name is Client Acceptor. Click Next.
- Complete the configuration by stepping through the wizard.
- Update the client options file, `dsm.opt`, and set the `passwordaccess` option to `generate`.
- To store the client node password, issue the following command at the command prompt:

```
dsmc query sess
```

Enter the client node password when prompted.

- Start the client acceptor service from the Services Control page. For example, if you used the default name, start the Client Acceptor service. Do not start the scheduler service that you specified on the Scheduler Name and Location page. The scheduler service is started and stopped automatically by the client acceptor service as needed.

## Configuring client/server communications through a firewall

---

If a client must communicate with a server through a firewall, you must enable client/server communications through the firewall.

### Before you begin

---

If you used the Add Client wizard to register a client, find the option values in the client options file that you obtained during that process. You can use the values to specify ports.

### About this task

---

Attention: Do not configure a firewall in a way that might cause termination of sessions that are in use by a server or storage agent. Termination of a valid session can cause unpredictable results. Processes and sessions might appear to stop due to input/output errors. To help exclude sessions from timeout restrictions, configure known ports for IBM Spectrum Protect™ components. Ensure that the KEEPALIVE server option remains set to the default value of YES. In this way, you can help to ensure that client/server communication is uninterrupted. For instructions about setting the KEEPALIVE server option, see KEEPALIVE.

## Procedure

---

Open the following ports to allow access through the firewall:

TCP/IP port for the backup-archive client, command-line administrative client, and the client scheduler

Specify the port by using the tcpport option in the client options file. The tcpport option in the client options file must match the TCPSPORT option in the server options file. The default value is 1500. If you decide to use a value other than the default, specify a number in the range 1024 - 32767.

HTTP port to enable communication between the web client and remote workstations

Specify the port for the remote workstation by setting the httpport option in the client options file of the remote workstation. The default value is 1581.

TCP/IP ports for the remote workstation

The default value of 0 (zero) causes two free port numbers to be randomly assigned to the remote workstation. If you do not want the port numbers to be randomly assigned, specify values by setting the webports option in the client options file of the remote workstation.

TCP/IP port for administrative sessions

Specify the port on which the server waits for requests for administrative client sessions. The value of the client tcpadminport option must match the value of the TCPADMINPORT server option. In this way, you can secure administrative sessions within a private network.

## Managing client operations

---

You can evaluate and resolve errors that are related to a backup-archive client by using the Operations Center, which provides suggestions for resolving errors. For errors on other types of clients, you must examine the error logs on the client and review the product documentation.

### About this task

---

In some cases, you can resolve client errors by stopping and starting the client acceptor. If client nodes or administrator IDs are locked, you can resolve the issue by unlocking the client node or administrator ID, and then resetting the password.

For detailed instructions about identifying and resolving client errors, see Resolving client problems.

- Evaluating errors in client error logs  
You can resolve client errors by obtaining suggestions from the Operations Center or by reviewing error logs on the client.
- Stopping and restarting the client acceptor  
If you change the configuration of your solution, you must restart the client acceptor on all client nodes where a backup-archive client is installed.
- Resetting passwords  
If a password for a client node or an administrator ID is lost or forgotten, you can reset the password. Multiple attempts to access the system with an incorrect password can cause a client node or administrator ID to be locked. You can take steps to resolve the issue.
- Modifying the scope of a client backup  
When you set up client backup operations, the preferred practice is to exclude objects that you do not require. For example, you typically want to exclude temporary files from a backup operation.

## Evaluating errors in client error logs

---

You can resolve client errors by obtaining suggestions from the Operations Center or by reviewing error logs on the client.

### Before you begin

---

To resolve errors in a backup-archive client on a Linux or Windows operating system, ensure that the client management service is installed and started. For installation instructions, see [Installing the client management service](#). For instructions about verifying the installation, see [Verifying that the client management service is installed correctly](#).

## Procedure

---

To diagnose and resolve client errors, take one of the following actions:

- If the client management service is installed on the client node, complete the following steps:
  1. On the Operations Center Overview page, click Clients and select the client.
  2. Click Details.
  3. On the client Summary page, click the Diagnosis tab.
  4. Review the retrieved log messages.

Tips:

- To show or hide the Client Logs pane, double-click the Client Logs bar.
- To resize the Client Logs pane, click and drag the Client Logs bar.

If suggestions are displayed on the Diagnosis page, select a suggestion. In the Client Logs pane, client log messages to which the suggestion relates are highlighted.

5. Use the suggestions to resolve the problems that are indicated by the error messages.

Tip: Suggestions are provided for only a subset of client messages.
- If the client management service is not installed on the client node, review the error logs for the installed client.

## Stopping and restarting the client acceptor

---

If you change the configuration of your solution, you must restart the client acceptor on all client nodes where a backup-archive client is installed.

### About this task

---

In some cases, you can resolve client scheduling problems by stopping and restarting the client acceptor. The client acceptor must be running to ensure that scheduled operations can occur on the client. For example, if you change the IP address or domain name of the server, you must restart the client acceptor.

## Procedure

---

Follow the instructions for the operating system that is installed on the client node:

AIX and Oracle Solaris

- To stop the client acceptor, complete the following steps:
  - a. Determine the process ID for the client acceptor by issuing the following command on the command line:

```
ps -ef | grep dsmcad
```

Review the output. In the following sample output, 6764 is the process ID for the client acceptor:

```
root 6764 1 0 16:26:35 ? 0:00 /usr/bin/dsmcad
```

- b. Issue the following command on the command line:

```
kill -9 PID
```

where *PID* specifies the process ID for the client acceptor.

- To start the client acceptor, issue the following command on the command line:

```
/usr/bin/dsmcad
```

Linux

- To stop the client acceptor (and not restart it), issue the following command:

```
# service dsmcad stop
```

- To stop and restart the client acceptor, issue the following command:

```
# service dsmscad restart
```

## MAC OS X

Click Applications > Utilities > Terminal.

- To stop the client acceptor, issue the following command:

```
/bin/launchctl unload -w com.ibm.tivoli.dsmscad
```

- To start the client acceptor, issue the following command:

```
/bin/launchctl load -w com.ibm.tivoli.dsmscad
```

## Windows

- To stop the client acceptor service, complete the following steps:
  - a. Click Start > Administrative Tools > Services.
  - b. Double-click the client acceptor service.
  - c. Click Stop and OK.
- To restart the client acceptor service, complete the following steps:
  - a. Click Start > Administrative Tools > Services.
  - b. Double-click the client acceptor service.
  - c. Click Start and OK.

### Related reference:

[Resolving client scheduling problems](#)

## Resetting passwords

---

If a password for a client node or an administrator ID is lost or forgotten, you can reset the password. Multiple attempts to access the system with an incorrect password can cause a client node or administrator ID to be locked. You can take steps to resolve the issue.

### Procedure

---

To resolve password issues, take one of the following actions:

- If a backup-archive client is installed on a client node, and the password is lost or forgotten, complete the following steps:
  1. Generate a new password by issuing the UPDATE NODE command:

```
update node node_name new_password forcepwnreset=yes
```

where *node\_name* specifies the client node and *new\_password* specifies the password that you assign.

2. Inform the client node owner about the changed password. When the owner of the client node logs in with the specified password, a new password is generated automatically. That password is unknown to users to enhance security.  
Tip: The password is generated automatically if you previously set the passwordaccess option to *generate* in the client options file.

- If an administrator is locked out because of password issues, complete the following steps:
  1. To provide the administrator with access to the server, issue the UNLOCK ADMIN command. For instructions, see UNLOCK ADMIN (Unlock an administrator).
  2. Set a new password by using the UPDATE ADMIN command:

```
update admin admin_name new_password forcepwnreset=yes
```

where *admin\_name* specifies the name of the administrator and *new\_password* specifies the password that you assign.

- If a client node is locked, complete the following steps:
  1. Determine why the client node is locked and whether it must be unlocked. For example, if the client node is decommissioned, the client node is being removed from the production environment. You cannot reverse the decommission operation, and the client node remains locked. A client node also might be locked if the client data is the subject of a legal investigation.
  2. If you must unlock a client node, use the UNLOCK NODE command. For instructions, see UNLOCK NODE (Unlock a client node).

3. Generate a new password by issuing the UPDATE NODE command:

```
update node node_name new_password forcepwreset=yes
```

where *node\_name* specifies the name of the node and *new\_password* specifies the password that you assign.

4. Inform the client node owner about the changed password. When the owner of the client node logs in with the specified password, a new password is generated automatically. That password is unknown to users to enhance security.

Tip: The password is generated automatically if you previously set the passwordaccess option to `generate` in the client options file.

## Modifying the scope of a client backup

---

When you set up client backup operations, the preferred practice is to exclude objects that you do not require. For example, you typically want to exclude temporary files from a backup operation.

### About this task

---

When you exclude unnecessary objects from backup operations, you get better control of the amount of storage space that is required for backup operations, and the cost of storage. Depending on your licensing package, you also might be able to limit licensing costs.

### Procedure

---

How you modify the scope of backup operations depends on the product that is installed on the client node:

- For a backup-archive client, you can create an include-exclude list to include or exclude a file, groups of files, or directories from backup operations. To create an include-exclude list, follow the instructions in [Creating an include-exclude list](#).

To ensure consistent use of an include-exclude list for all clients of one type, you can create a client option set on the server that contains the required options. Then, you assign the client option set to each of the clients of the same type. For details, see [Controlling client operations through client option sets](#).

- For a backup-archive client, you can specify the objects to include in an incremental backup operation by using the domain option. Follow the instructions in [Domain client option](#).
- For other products, to define which objects are included in and excluded from backup operations, follow the instructions in the product documentation.

## Managing client upgrades

---

When a fix pack or interim fix becomes available for a client, you can upgrade the client to take advantage of product improvements. Servers and clients can be upgraded at different times and can be at different levels with some restrictions.

### Before you begin

---

1. Review the client/server compatibility requirements in [technote 1053218](#). If your solution includes servers or clients at a level that is earlier than V7.1, review the guidelines to ensure that client backup and archive operations are not disrupted.
2. Verify system requirements for the client in [IBM Spectrum Protect™ Supported Operating Systems](#).
3. If the solution includes storage agents or library clients, review the information about storage-agent and library-client compatibility with servers that are configured as library managers. See [technote 1302789](#).

If you plan to upgrade a library manager and a library client, you must upgrade the library manager first.

### Procedure

---

To upgrade the software, complete the instructions that are listed in the following table.

Software	Link to instructions
IBM Spectrum Protect backup-archive client	<ul style="list-style-type: none"><li>• <a href="#">Upgrading the backup-archive client</a></li></ul>

Software	Link to instructions
IBM Spectrum Protect Snapshot	<ul style="list-style-type: none"> <li>Installing and upgrading IBM Spectrum Protect Snapshot for UNIX and Linux</li> <li>Installing and upgrading IBM Spectrum Protect Snapshot for VMware</li> <li>Installing and upgrading IBM Spectrum Protect Snapshot for Windows</li> </ul>
IBM Spectrum Protect for Databases	<ul style="list-style-type: none"> <li>Upgrading Data Protection for SQL Server</li> <li>Data Protection for Oracle installation</li> <li>Installing, upgrading, and migrating IBM Spectrum Protect for Mail: Data Protection for Microsoft Exchange Server</li> </ul>
IBM Spectrum Protect for Enterprise Resource Planning	<ul style="list-style-type: none"> <li>Upgrading IBM Spectrum Protect for Enterprise Resource Planning: Data Protection for SAP for DB2®</li> <li>Upgrading IBM Spectrum Protect for Enterprise Resource Planning: Data Protection for SAP for Oracle</li> </ul>
IBM Spectrum Protect for Mail	<ul style="list-style-type: none"> <li>Installation of Data Protection for IBM Domino on a UNIX, AIX, or Linux system (V7.1.0)</li> <li>Installation of Data Protection for IBM Domino on a Windows system (V7.1.0)</li> <li>Installing, upgrading, and migrating IBM Spectrum Protect for Mail: Data Protection for Microsoft Exchange Server</li> </ul>
IBM Spectrum Protect for Virtual Environments	<ul style="list-style-type: none"> <li>Installing and upgrading Data Protection for VMware</li> <li>Installing Data Protection for Microsoft Hyper-V</li> </ul>

## Decommissioning a client node

If a client node is no longer required, you can start a process to remove it from the production environment. For example, if a workstation was backing up data to the IBM Spectrum Protect™ server, but the workstation is no longer used, you can decommission the workstation.

### About this task

When you start the decommission process, the server locks the client node to prevent it from accessing the server. Files that belong to the client node are gradually deleted, and then the client node is deleted. You can decommission the following types of client nodes:

#### Application client nodes

Application client nodes include email servers, databases, and other applications. For example, any of the following applications can be an application client node:

- IBM Spectrum Protect Snapshot
- IBM Spectrum Protect for Databases
- IBM Spectrum Protect for Enterprise Resource Planning
- IBM Spectrum Protect for Mail
- IBM Spectrum Protect for Virtual Environments

#### System client nodes

System client nodes include workstations, network-attached storage (NAS) file servers, and API clients.

#### Virtual machine client nodes

Virtual machine client nodes consist of an individual guest host within a hypervisor. Each virtual machine is represented as a file space.

The simplest method for decommissioning a client node is to use the Operations Center. The decommission process runs in the background. If the client is configured to replicate client data, the Operations Center automatically removes the client from replication on the source and target replication servers before it decommissions the client.

Tip: Alternatively, you can decommission a client node by issuing the `DECOMMISSION NODE` or `DECOMMISSION VM` command. You might want to use this method in the following cases:

- To schedule the decommission process for the future or to run a series of commands by using a script, specify the decommission process to run in the background.
- To monitor the decommission process for debugging purposes, specify the decommission process to run in the foreground. If you run the process in the foreground, you must wait for the process to be completed before you continue with other tasks.

## Procedure

---

Take one of the following actions:

- To decommission a client in the background by using the Operations Center, complete the following steps:
  1. On the Operations Center Overview page, click Clients and select the client.
  2. Click More > Decommission.
- To decommission a client node by using an administrative command, complete the following steps:
  1. Determine whether the client node is configured for node replication by issuing the QUERY NODE command. For example, if the client node is named AUSTIN, run the following command:

```
query node austin format=detailed
```

Review the Replication State output field.

2. If the client node is configured for replication, remove the client node from replication by issuing the REMOVE REPLNODE command. For example, if the client node is named AUSTIN, issue the following command:

```
remove replnode austin
```

3. Take one of the following actions:

- To decommission an application or system client node in the background, issue the DECOMMISSION NODE command. For example, if the client node is named AUSTIN, issue the following command:

```
decommission node austin
```

- To decommission an application or system client node in the foreground, issue the DECOMMISSION NODE command and specify the `wait=yes` parameter. For example, if the client node is named AUSTIN, issue the following command:

```
decommission node austin wait=yes
```

- To decommission a virtual machine in the background, issue the DECOMMISSION VM command. For example, if the virtual machine is named AUSTIN, the file space is 7, and the file space name is specified by the file space ID, issue the following command:

```
decommission vm austin 7 nametype=fsid
```

If the virtual machine name includes one or more spaces, enclose the name in double quotation marks. For example:

```
decommission vm "austin 2" 7 nametype=fsid
```

- To decommission a virtual machine in the foreground, issue the DECOMMISSION VM command and specify the `wait=yes` parameter. For example, issue the following command:

```
decommission vm austin 7 nametype=fsid wait=yes
```

If the virtual machine name includes one or more spaces, enclose the name in double quotation marks. For example:

```
decommission vm "austin 2" 7 nametype=fsid wait=yes
```

## What to do next

---

Watch for error messages, which might be displayed in the user interface or in the command output, immediately after you run the process.

You can verify that the client node is decommissioned:

1. On the Operations Center Overview page, click Clients.
2. In the Clients table, in the At risk column, review the state:
  - A DECOMMISSIONED state specifies that the node is decommissioned.

- o A null value specifies that the node is not decommissioned.
  - o A PENDING state specifies that the node is being decommissioned, or the decommission process failed.
- Tip: If you want to determine the status of a pending decommission process, issue the following command:

```
query process
```

3. Review the command output:

- o If status is provided for the decommission process, the process is in progress. For example:

```
query process
```

Process Number	Process Description	Process Status
3	DECOMMISSION NODE	Number of backup objects deactivated for node NODE1: 8 objects deactivated.

- o If no status is provided for the decommission process, and you did not receive an error message, the process is incomplete. A process can be incomplete if files that are associated with the node are not yet deactivated. After the files are deactivated, run the decommission process again.
- o If no status is provided for the decommission process, and you receive an error message, the process failed. Run the decommission process again.

**Related reference:**

- [DECOMMISSION NODE \(Decommission a client node\)](#)
- [DECOMMISSION VM \(Decommission a virtual machine\)](#)
- [QUERY NODE \(Query nodes\)](#)
- [REMOVE REPLNODE \(Remove a client node from replication\)](#)

## Deactivating data to free storage space

In some cases, you can deactivate data that is stored on the IBM Spectrum Protect™ server. When you run the deactivation process, any backup data that was stored before the specified date and time is deactivated and will be deleted as it expires. In this way, you can free space on the server.

### About this task

Some application clients always save data to the server as active backup data. Because active backup data is not managed by inventory expiration policies, the data is not deleted automatically, and uses server storage space indefinitely. To free the storage space that is used by obsolete data, you can deactivate the data.

When you run the deactivation process, all active backup data that was stored before the specified date becomes inactive. The data is deleted as it expires and cannot be restored. The deactivation feature applies only to application clients that protect Oracle databases.

### Procedure

1. From the Operations Center Overview page, click Clients.
2. In the Clients table, select one or more clients and click More > Clean Up.  
Command-line method: Deactivate data by using the DEACTIVATE DATA command.

**Related reference:**

- [DEACTIVATE DATA \(Deactivate data for a client node\)](#)

## Managing data storage

Manage your data for efficiency and add supported devices and media to the server to store client data.

- Auditing a storage pool container  
Audit a storage pool container to check for inconsistencies between database information and a container in a storage pool.
- Managing inventory capacity  
Manage the capacity of the database, active log, and archive logs to ensure that the inventory is sized for the tasks, based on the status of the logs.



- Managing memory and processor usage  
Ensure that you manage memory requirements and processor usage to ensure that the server can complete data processes such as backup and data deduplication. Consider the impact on performance when you complete certain processes.
- Tuning scheduled activities  
Schedule maintenance tasks daily to ensure that your solution operates correctly. By tuning your solution, you maximize server resources and effectively use different functions available within your solution.

**Related reference:**

[Types of storage pools](#)

## Auditing a storage pool container

---

Audit a storage pool container to check for inconsistencies between database information and a container in a storage pool.

### About this task

---

You audit a storage pool container in the following situations:

- When you issue the QUERY DAMAGED command and a problem is detected
- When the server displays messages about damaged data extents
- Your hardware reports an issue and error messages that are associated with the storage pool container are displayed

### Procedure

---

1. To audit a storage pool container, issue the AUDIT CONTAINER command. For example, issue the following command to audit a container, 000000000000076c.dcf:

```
audit container c:\tsm-storage\07\000000000000076c.dcf
```

2. Review the output from the ANR4891I message for information about any damaged data extents.

### What to do next

---

If you detect problems with the storage pool container, you can restore data based on your configuration. You can repair the contents in the storage pool by using the REPAIR STGPOOL command.

Restriction: You can repair the contents of the storage pool only if you protected the storage pool by using the PROTECT STGPOOL command.

**Related reference:**

[AUDIT CONTAINER](#) (Verify the consistency of database information for a directory-container storage pool)

[QUERY DAMAGED](#) (Query damaged data in a directory-container or cloud-container storage pool)

## Managing inventory capacity

---

Manage the capacity of the database, active log, and archive logs to ensure that the inventory is sized for the tasks, based on the status of the logs.

### Before you begin

---

The active and archive logs have the following characteristics:

- The active log can be a maximum size of 512 GB. For more information about sizing the active log for your system, see [Planning the storage arrays](#).
- The archive log size is limited to the size of the file system that it is installed on. The archive log size is not maintained at a predefined size like the active log. Archive log files are automatically deleted after they are no longer needed.

As a best practice, you can optionally create an archive failover log to store archive log files when the archive log directory is full.

Check the Operations Center to determine the component of the inventory that is full. Ensure that you stop the server before you increase the size of one of the inventory components.

### Procedure

---

- To increase the size of the database, complete the following steps:
  - Create one or more directories for the database on separate drives or file systems.
  - Issue the EXTEND DBSPACE command to add the directory or directories to the database. The directories must be accessible to the instance user ID of the database manager. By default, data is redistributed across all database directories and space is reclaimed.
  - Tips:
    - The time that is needed to complete redistribution of data and reclaiming of space is variable, depending on the size of your database. Make sure that you plan adequately.
    - Ensure that the directories that you specify are the same size as existing directories to ensure a consistent degree of parallelism for database operations. If one or more directories for the database are smaller than the others, they reduce the potential for optimized parallel prefetching and distribution of the database.
  - Halt and restart the server to fully use the new directories.
  - Reorganize the database if necessary. Index and table reorganization for the server database can help to avoid unexpected database growth and performance issues. For more information about reorganizing the database, see technote 1683633.

- To decrease the size of the database for V7.1 servers and later, issue the following DB2® commands from the server instance directory:  
 Restriction: The commands can increase I/O activity, and might affect server performance. To minimize performance problems, wait until one command is completed before you issue the next command. The DB2 commands can be issued when the server is running.

```
db2 connect to tsmdb1
db2 set schema tsmdb1
db2 ALTER TABLESPACE USERSPACE1 REDUCE MAX
db2 ALTER TABLESPACE IDXSPACE1 REDUCE MAX
db2 ALTER TABLESPACE LARGEIDXSPACE1 REDUCE MAX
db2 ALTER TABLESPACE LARGESPAC1 REDUCE MAX
db2 ALTER TABLESPACE REPLTBLSPACE1 REDUCE MAX
db2 ALTER TABLESPACE REPLIDXSPACE1 REDUCE MAX
db2 ALTER TABLESPACE ARCHOBJDATASPACE REDUCE MAX
db2 ALTER TABLESPACE ARCHOBJIDXSPACE REDUCE MAX
db2 ALTER TABLESPACE BACKOBJDATASPACE REDUCE MAX
db2 ALTER TABLESPACE BACKOBJIDXSPACE REDUCE MAX
db2 ALTER TABLESPACE BFABFDATASPACE REDUCE MAX
db2 ALTER TABLESPACE BFABFIDXSPACE REDUCE MAX
db2 ALTER TABLESPACE BFBFEXTDATASPACE REDUCE MAX
db2 ALTER TABLESPACE BFBFEXTIDXSPACE REDUCE MAX
db2 ALTER TABLESPACE DEDUPTBLSPACE1 REDUCE MAX
db2 ALTER TABLESPACE DEDUPIIDXSPACE1 REDUCE MAX
db2 ALTER TABLESPACE DEDUPTBLSPACE2 REDUCE MAX
db2 ALTER TABLESPACE DEDUPIIDXSPACE2 REDUCE MAX
db2 ALTER TABLESPACE DEDUPTBLSPACE3 REDUCE MAX
db2 ALTER TABLESPACE DEDUPIIDXSPACE3 REDUCE MAX
db2 ALTER TABLESPACE DEDUPTBLSPACE4 REDUCE MAX
db2 ALTER TABLESPACE DEDUPIIDXSPACE4 REDUCE MAX
db2 ALTER TABLESPACE DEDUPTBLSPACE5 REDUCE MAX
db2 ALTER TABLESPACE DEDUPIIDXSPACE5 REDUCE MAX
```

- To increase or decrease the size of the active log, complete the following steps:
  1. Ensure that the location for the active log has enough space for the increased log size. If a log mirror exists, its location must also have enough space for the increased log size.
  2. Halt the server.
  3. In the dsmserv.opt file, update the ACTIVELOGSIZE option to the new size of the active log, in megabytes. The size of an active log file is based on the value of the ACTIVELOGSIZE option. Guidelines for space requirements are in the following table:

Table 1. How to estimate volume and file space requirements

ACTIVELOGSize option value	Reserve this much free space in the active log directory, in addition to the ACTIVELOGSize space
16 GB - 128 GB	5120 MB
129 GB - 256 GB	10240 MB
257 GB - 512 GB	20480 MB

To change the active log to its maximum size of 512 GB, enter the following server option:

```
activelogsiz 524288
```

4. If you plan to use a new active log directory, update the directory name that is specified in the `ACTIVELOGDIRECTORY` server option. The new directory must be empty and must be accessible to the user ID of the database manager.
  5. Restart the server.
- Compress the archive logs to reduce the amount of space that is required for storage. Enable dynamic compression of the archive log by issuing the following command:

```
setopt archlogcompress yes
```

Restriction: Use caution when you enable the `ARCHLOGCOMPRESS` server option on systems with sustained high volume usage and heavy workloads. Enabling this option in this system environment can cause delays in archiving log files from the active log file system to the archive log file system. This delay can cause the active log file system to run out of space. Be sure to monitor the available space in the active log file system after archive log compression is enabled. If the active log directory file system usage nears out of space conditions, the `ARCHLOGCOMPRESS` server option must be disabled. You can use the `SETOPT` command to disable archive log compression immediately without halting the server.

**Related reference:**

- [ACTIVELOGSIZE](#) server option
- [EXTEND DBSPACE](#) (Increase space for the database)
- [SETOPT](#) (Set a server option for dynamic update)

## Managing memory and processor usage

---

Ensure that you manage memory requirements and processor usage to ensure that the server can complete data processes such as backup and data deduplication. Consider the impact on performance when you complete certain processes.

### Before you begin

---

- Ensure that your configuration uses the required hardware and software. For more information, see *IBM Spectrum Protect™ Supported Operating Systems*.
- For more information about managing resources such as the database and recovery log, see *Planning the storage arrays*.
- Add more system memory to determine whether there is a performance improvement. Monitor memory usage regularly to determine whether more memory is required.

### Procedure

---

1. Release memory from the file system cache where possible.
2. To manage the system memory that is used by each server on a system, use the `DBMEMPERCENT` server option. Limit the percentage of system memory that can be used by the database manager of each server. If all servers are equally important, use the same value for each server. If one server is a production server and other servers are test servers, set the value for the production server to a higher value than the test servers.
3. Set the user data limit and private memory for the database to ensure that private memory is not exhausted. Exhausting private memory can result in errors, less than optimal performance, and instability.

## Tuning scheduled activities

---

Schedule maintenance tasks daily to ensure that your solution operates correctly. By tuning your solution, you maximize server resources and effectively use different functions available within your solution.

### Procedure

---

1. Monitor system performance regularly to ensure that client backup and server maintenance tasks are completing successfully. Follow the instructions in *Monitoring a multisite disk solution*.
2. Optional: If the monitoring information shows that the server workload increased, review the planning information. Review whether the capacity of the system is adequate in the following cases:
  - The number of clients increases
  - The amount of data that is being backed up increases
  - The amount of time that is available for backups changes
3. Determine whether your solution is performing at the level you expect. Review the client schedules to check whether tasks are completing within the scheduled time frame:
  - a. On the *Clients* page of the *Operations Center*, select the client.

- b. Click Details.
  - c. From the client Summary page, review the Backed up and Replicated activity to identify any risks.
- Adjust the time and frequency of client backup operations, if necessary.
4. Schedule enough time for the following maintenance tasks to complete successfully within a 24-hour period:
    - a. Protect storage pools.
    - b. Replicate node data.
    - c. Back up the database.
    - d. Run expiration processing to remove client backups and archive file copies from server storage.

Tip: Schedule maintenance tasks to start at an appropriate time and in the correct sequence. For example, schedule replication tasks after client backups complete successfully.

- Moving clients from one server to another  
To avoid running out of space on a server or to resolve workload issues, you might have to move client nodes from one server to another.

**Related concepts:**

[Performance](#)

**Related tasks:**

Defining schedules for server maintenance activities

[Deduplicating data \(V7.1.1\)](#)

## Managing replication

Use replication to recover data at a disaster recovery site and to maintain the same level of files on the source and target servers. You can manage replication at the node level. You can also protect data at the storage-pool level.

- Replication compatibility  
Before you set up replication operations with IBM Spectrum Protect, you must ensure that the source and target replication servers are compatible for replication.
- Enabling node replication  
You can enable node replication to protect your data.
- Protecting data in directory-container storage pools  
Protect data in directory-container storage pools to reduce node replication time and to enable repair of data in directory-container storage pools.
- Modifying replication settings  
Modify replication settings in the Operations Center. Change settings such as the number of replication sessions, replication rules, the data that you want to replicate, the replication schedule, and the replication workload.
- Setting different retention policies for the source server and target server  
You can set policies on the target replication server that manage the replicated client-node data differently than on the source server. For example, you can maintain a different number of versions of files on the source and the target servers.

## Replication compatibility

Before you set up replication operations with IBM Spectrum Protect™, you must ensure that the source and target replication servers are compatible for replication.

Table 1. Replication compatibility of server versions

Source replication server version	Compatible versions for the target replication server
V6.3.0 - V6.3.2	V6.3.0 - V6.3.2
V6.3.3	V6.3.3 or later V6.3 levels
V6.3.4 or later V6.3 levels	V6.3.4 or later
V7.1	V7.1 or later
V7.1.1	V7.1 or later
V7.1.3	V7.1.3 or later
V7.1.4	V7.1.3 or later
V7.1.5	V7.1.3 or later

Source replication server version	Compatible versions for the target replication server
V7.1.6	V7.1.3 or later
V7.1.7	V7.1.3 or later
V8.1	V7.1.3 or later
V8.1.1	V7.1.3 or later
V8.1.2	V7.1.3 or later

## Enabling node replication

---

You can enable node replication to protect your data.

### Before you begin

---

Ensure that the source and target servers are compatible for replication.

### About this task

---

Replicate the client node to replicate all client data, including metadata. By default, node replication is disabled when you start the server for the first time.

Tips:

- To reduce replication processing time, protect the storage pool before you replicate client nodes. When node replication is started, the data extents that are already replicated through storage pool protection are skipped.
- Replication requires increased amounts of memory and sufficient bandwidth to complete processing. Size the database and its logs to ensure that transactions can complete.

### Procedure

---

To enable node replication, complete the following steps in the Operations Center:

- a. On the Servers page, click Details.
- b. On the Details page, click Properties.
- c. In the Replication section, select Enabled in the Outbound replication field.
- d. Click Save.

### What to do next

---

Complete the following actions:

1. To verify that replication was successful, review the Daily monitoring checklist.
2.  If the IBM Spectrum Protect server replicates nodes to a remote server, determine whether Aspera® Fast Adaptive Secure Protocol (FASP®) technology can improve data throughput to the remote server. Follow the instructions in Determining whether Aspera FASP technology can optimize data transfer in your system environment.

**Related reference:**

Replication compatibility

## Protecting data in directory-container storage pools

---

Protect data in directory-container storage pools to reduce node replication time and to enable repair of data in directory-container storage pools.

### Before you begin

---

Ensure that at least one directory-container storage pool exists on the target replication server. When you enable replication in the Operations Center, you can schedule storage pool protection. To configure replication and enable storage pool protection, complete the following steps:

1. On the Operations Center menu bar, hover over Storage and click Replication.
2. On the Replication page, click Server Pair.
3. Complete the steps in the Add Server Pair wizard.

## About this task

---

Protecting a directory-container storage pool backs up data extents to another storage pool, and can improve performance for node replication. When node replication is started, the data extents that are already backed up through storage pool protection are skipped, which reduces the replication processing time. You can schedule the protection of storage pools several times a day to keep up with changes to data.

By protecting a storage pool, you do not use resources that replicate existing data and metadata, which improves server performance. You must use directory-container storage pools if you want to protect and back up the storage pool only.

Alternative protection strategy: As an alternative to using replication, you can protect data in directory-container storage pools by copying the data to container-copy storage pools. Data in container-copy storage pools is stored on tape volumes. Tape copies that are stored offsite provide additional disaster recovery protection in a replicated environment.

## Procedure

---

1. Alternatively, to enable storage pool protection, you can use the PROTECT STGPOOL command from the source server to back up data extents in a directory-container storage pool. For example, to protect a directory-container storage pool that is named POOL1 issue the following command:

```
protect stgpool pool1
```

As part of the operation of the PROTECT STGPOOL command, damaged extents in the target storage pool are repaired. To be repaired, extents must already be marked as damaged on the target server. For example, an AUDIT CONTAINER command might identify damage in the target storage pool before the PROTECT STGPOOL command is issued.

2. Optional: If damaged extents were repaired in the target storage pool and you protect multiple source storage pools in one target storage pool, complete the following steps to ensure a complete repair:
  - a. Issue the PROTECT STGPOOL command for all source storage pools to repair as much of the damage as possible.
  - b. Issue the PROTECT STGPOOL command again for all source storage pools. For this second operation, use the FORCERECONCILE=YES parameter. This step ensures that any repairs from other source pools are properly recognized for all source storage pools.

## Results

---

If a directory-container storage pool is protected, you can repair the storage pool if damage occurs, by using the REPAIR STGPOOL command.

Restriction: If you replicate client nodes but do not protect the directory-container storage pool, you cannot repair the storage pool.

## What to do next

---

Complete the following actions:

1. To view replication workload status, follow the instructions in the Daily monitoring checklist.
2. **Linux** If the IBM Spectrum Protect server replicates nodes to a remote server, determine whether Aspera® Fast Adaptive Secure Protocol (FASP®) technology can improve data throughput to the remote server. Follow the instructions in Determining whether Aspera FASP technology can optimize data transfer in your system environment.

### Related reference:

- [Repairing and recovering data](#)
- [AUDIT CONTAINER \(Verify the consistency of database information for a directory-container storage pool\)](#)
- [PROTECT STGPOOL \(Protect storage pool data\)](#)

### Related information:

- [Directory-container storage pools FAQs](#)
- [Cloud-container storage pools FAQs](#)

## Modifying replication settings

---

Modify replication settings in the Operations Center. Change settings such as the number of replication sessions, replication rules, the data that you want to replicate, the replication schedule, and the replication workload.

## About this task

You might need to customize your replication settings in the following scenarios:

- Changes to data priorities
- Changes to replication rules
- Requirement for a different server to be the target server
- Scheduled processes that negatively affect server performance

## Procedure

Use the Operations Center to modify replication settings.

Task	Procedure
Change a replication rule.	<ol style="list-style-type: none"><li>On the Servers page, click Details.</li><li>On the Details page, click Properties.</li><li>In the Replication section, choose the replication rule that you want to apply: Default archive rule, Default backup rule, or Default space-management rule.</li><li>Click Save.</li></ol>
Specify the duration that replication records are retained.	<ol style="list-style-type: none"><li>On the Servers page, click Details.</li><li>On the Details page, click Properties.</li><li>In the Replication section, enter the number of days that replication records must be retained in the Retain replication history field. Alternatively, select the Do not retain check box if you do not require replication records.</li><li>Click Save.</li></ol>
Specify a target replication server.	<ol style="list-style-type: none"><li>On the Servers page, click Details.</li><li>On the Details page, click Properties.</li><li>In the Replication section, specify the target server.</li><li>Click Save.</li></ol>
Cancel a replication process.	<ol style="list-style-type: none"><li>On the Servers page, click Active tasks.</li><li>Select the process or session that you want to cancel.</li><li>Click Cancel.</li></ol>

## Setting different retention policies for the source server and target server

You can set policies on the target replication server that manage the replicated client-node data differently than on the source server. For example, you can maintain a different number of versions of files on the source and the target servers.

## Procedure

1. From the source replication server, validate the replication configuration and verify that the source replication server can communicate with the target replication server by issuing the VALIDATE REPLICATION command. For example, validate the configuration by using the name of one client node that is being replicated:

```
validate replication node1 verifyconnection=yes
```

2. From the source replication server, issue the VALIDATE REPLPOLICY command to review the differences between the policies on the source and target replication servers. For example, to display the differences between the policies on the source server and the target server, CVT\_SRV2, issue the following command from the source server:

```
validate replpolicy cvt_srv2
```

3. Update the policies on the target server if necessary.

Tip: You can use the Operations Center to modify the policies on the target server. Follow the instructions in Editing policies.

For example, to maintain inactive versions of files for a shorter time on the target server than on the source server, reduce the Backups setting in the management classes that apply to replicated client data.

4. Enable the target replication server to use its policies to manage the replicated client-node data by issuing the SET DISSIMILARPOLICIES command on the source server. For example, to enable the policies on the target replication server, CVT\_SRV2, issue the following command on the source server:

```
set dissimilarpolicies cvt_srv2 on
```

The next time that the replication process runs, the policies on the target replication server are used to manage the replicated client-node data.

Tip: If you configure replication by using the Operations Center and the policies on the source and target replication servers do not match, the policy that is specified for the source replication server is used. If you enabled the policies on the target replication server by using the SET DISSIMILARPOLICIES command, the policy that is specified for the target replication server is used. If the target replication server does not have the policy that is used by the node on the source replication server, the STANDARD policy is used.

**Related reference:**

[EXPORT POLICY](#) (Export policy information)

[SET DISSIMILARPOLICIES](#) (Enable the policies on the target replication server to manage replicated data)

[VALIDATE REPLICATION](#) (Validate replication for a client node)

[VALIDATE REPLPOLICY](#) (Verify the policies on the target replication server)

## Securing the server

---

Secure the IBM Spectrum Protect™ server and data by controlling access to servers and client nodes, encrypting data, and maintaining secure access levels and passwords.

- Security concepts  
You can protect IBM Spectrum Protect from security risks by using communication protocols, securing passwords, and providing different access levels for administrators.
- Managing administrators  
An administrator who has system authority can complete any task with the IBM Spectrum Protect server, including assigning authority levels to other administrators. To complete some tasks, you must be granted authority by being assigned one or more authority levels.
- Changing password requirements  
You can change the minimum password limit, password length, password expiration, and enable or disable authentication for IBM Spectrum Protect.
- Securing IBM Spectrum Protect on the system  
Protect the system where the IBM Spectrum Protect server runs to prevent unauthorized access.

## Security concepts

---

You can protect IBM Spectrum Protect™ from security risks by using communication protocols, securing passwords, and providing different access levels for administrators.

## Transport Layer Security

---

You can use the Secure Sockets Layer (SSL) or the Transport Layer Security (TLS) protocol to provide transport layer security for a secure connection between servers, clients, and storage agents. If you send data between the server, client, and storage agent, use SSL or TLS to encrypt the data.

Tip: Any IBM Spectrum Protect documentation that indicates "SSL" or to "select SSL" applies to TLS.

SSL is provided by the Global Security Kit (GSKit) that is installed with the IBM Spectrum Protect server that the server, client, and storage agent use.

Restriction: Do not use the SSL or TLS protocols for communications with a DB2® database instance that is used by any IBM Spectrum Protect servers.



Each server, client, or storage agent that enables SSL must use a trusted self-signed certificate or obtain a unique certificate that is signed by a certificate authority (CA). You can use your own certificates or purchase certificates from a CA. Either certificate must be installed and added to the key database on the IBM Spectrum Protect server, client, or storage agent. The certificate is verified by the SSL client or server that requests or initiates the SSL communication. Some CA certificates are preinstalled in the key databases, by default.

SSL is set up independently on the IBM Spectrum Protect server, client, and storage agent.

## Authority levels

With each IBM Spectrum Protect server, different administrative authority levels are available that determine the tasks that an administrator can complete.

After registration, an administrator must be granted authority by being assigned one or more administrative authority levels. An administrator with system authority can complete any task with the server and assign authority levels to other administrators by using the GRANT AUTHORITY command. Administrators with policy, storage, or operator authority can complete subsets of tasks.

An administrator can register other administrator IDs, grant levels of authority to them, rename IDs, remove IDs, and lock and unlock them from the server.

An administrator can control access to specific client nodes for root user IDs and non-root user IDs. By default, a non-root user ID cannot back up data on the node. Use the UPDATE NODE command to change the node settings to enable backup.

## Passwords

By default, the server automatically uses password authentication. With password authentication, all users must enter a password when they access the server.

Use Lightweight Directory Access Protocol (LDAP) to apply stricter requirements for passwords. For more information, see [Managing passwords and logon procedures \(V7.1.1\)](#).

Table 1. Password authentication characteristics

Characteristic	More information
Case-sensitivity	Not case-sensitive.
Default password expiration	90 days.  The expiration period begins when an administrator ID or client node is first registered to the server. If the password is not changed within this period, the password must be changed the next time that the user accesses the server.
Invalid password attempts	You can set a limit on consecutive invalid password attempts for all client nodes. When the limit is exceeded, the server locks the node.
Password length	The administrator can specify a minimum length.

## Session security

Session security is the level of security that is used for communication among IBM Spectrum Protect client nodes, administrative clients, and servers and is set by using the SESSIONSECURITY parameter.

The SESSIONSECURITY parameter can be set to one of the following values:

- The STRICT value enforces the highest level of security for communication between IBM Spectrum Protect servers, nodes, and administrators.
- The TRANSITIONAL value specifies that the existing communication protocol is used while you update your IBM Spectrum Protect software to V8.1.2 or later. This is the default. When SESSIONSECURITY=TRANSITIONAL, stricter security settings are automatically enforced as higher versions of the TLS protocol are used and as the software is updated to V8.1.2 or later. After a node, administrator, or server meets the requirements for the STRICT value, session security is automatically updated to the STRICT value, and the entity can no longer authenticate by using a previous version of the client or earlier TLS protocols.

For more information about the SESSIONSECURITY parameter values, see the following commands.

Table 2. Commands used to set the SESSIONSECURITY parameter

Entity	Command
Client nodes	<ul style="list-style-type: none"> <li>REGISTER NODE</li> <li>UPDATE NODE</li> </ul>
Administrators	<ul style="list-style-type: none"> <li>REGISTER ADMIN</li> <li>UPDATE ADMIN</li> </ul>
Servers	<ul style="list-style-type: none"> <li>DEFINE SERVER</li> <li>UPDATE SERVER</li> </ul>

Administrators that authenticate by using the DSMADMC command, DSMC command, or dsm program cannot authenticate by using an earlier version after authenticating by using V8.1.2 or later. To resolve authentication issues for administrators, see the following tips:

Tips:

- Ensure that all IBM Spectrum Protect software that the administrator account uses to log on is upgraded to V8.1.2 or later. If an administrator account logs on from multiple systems, ensure that the server's certificate is installed on each system.
- After an administrator authenticates to a V8.1.2 or later server by using a V8.1.2 or later client, the administrator can authenticate only on clients or servers that are using V8.1.2 or later. An administrator command can be issued from any system.
- If necessary, create a separate administrator account to use only with clients and servers that are using V8.1.1 or earlier software.

Enforce the highest level of security for communication with the IBM Spectrum Protect server by ensuring that all nodes, administrators, and servers use STRICT session security. You can use the SELECT command to determine which servers, nodes, and administrators are using TRANSITIONAL session security and should be updated to use STRICT session security.

**Related tasks:**

[↗ Securing communications](#)

## Managing administrators

An administrator who has system authority can complete any task with the IBM Spectrum Protect™ server, including assigning authority levels to other administrators. To complete some tasks, you must be granted authority by being assigned one or more authority levels.

### Procedure

Complete the following tasks to modify administrator settings.

Task	Procedure
Add an administrator.	<p>To add an administrator, ADMIN1, with system authority and specify a password, complete the following steps:</p> <ol style="list-style-type: none"> <li>Register the administrator and specify Pa\$#\$twO as the password by issuing the following command: <pre>register admin admin1 Pa\$#\$twO</pre> </li> <li>Grant system authority to the administrator by issuing the following command: <pre>grant authority admin1 classes=system</pre> </li> </ol>

Task	Procedure
Change administrative authority.	Change the authority level for an administrator, ADMIN1. <ul style="list-style-type: none"> <li>Grant system authority to the administrator by issuing the following command:               <pre>grant authority admin1 classes=system</pre> </li> <li>Revoke system authority for the administrator by issuing the following command:               <pre>revoke authority admin1 classes=system</pre> </li> </ul>
Remove administrators.	Remove an administrator, ADMIN1, from accessing the IBM Spectrum Protect server by issuing the following command: <pre>remove admin admin1</pre>
Temporarily prevent access to the server.	Lock or unlock an administrator by using the LOCK ADMIN or UNLOCK ADMIN command.

## Changing password requirements

You can change the minimum password limit, password length, password expiration, and enable or disable authentication for IBM Spectrum Protect™.

### About this task

By enforcing password authentication and managing password restrictions, you protect your data and your servers from potential security risks.

### Procedure

Complete the following tasks to change password requirements for IBM Spectrum Protect servers.

Table 1. Authentication tasks for IBM Spectrum Protect servers

Task	Procedure
Set a limit for invalid password attempts.	a. On the Servers page in the Operations Center, select the server. b. Click Details, and then click the Properties tab. c. Set the number of invalid attempts in the Invalid sign-on attempt limit field.  The default value at installation is 0.
Set a minimum length for passwords.	a. On the Servers page in the Operations Center, select the server. b. Click Details and then click the Properties tab. c. Set the number of characters in the Minimum password length field.
Set the expiration period for passwords.	a. On the Servers page in the Operations Center, select the server. b. Click Details and then click the Properties tab. c. Set the number of days in the Password common expiration field.

Task	Procedure
Disable password authentication.	<p>By default, the server automatically uses password authentication. With password authentication, all users must enter a password to access the server.</p> <p>You can disable password authentication only for passwords that authenticate with the server (LOCAL). By disabling password authentication, you increase the security risk for the server.</p>
Set a default authentication method.	<p>Issue the SET DEFAULTAUTHENTICATION command. For example, to use the server as the default authentication method, issue the following command:</p> <pre>set defaultauthentication local</pre> <p>To update one client node to authenticate with the server, include AUTHENTICATION=LOCAL in the UPDATE NODE command:</p> <pre>update node authentication=local</pre>

**Related concepts:**

- 🔗 [Authenticating IBM Spectrum Protect users by using an LDAP server](#)
- 🔗 [Managing passwords and logon procedures \(V7.1.1\)](#)

## Securing IBM Spectrum Protect on the system

Protect the system where the IBM Spectrum Protect™ server runs to prevent unauthorized access.

### Procedure

Ensure that unauthorized users cannot access the directories for the server database and the server instance. Keep the access settings for these directories that you configured during implementation.

- Restricting user access to the server  
Authority levels determine what an administrator can do with the IBM Spectrum Protect server. An administrator with system authority can complete any task with the server. Administrators with policy, storage, or operator authority can complete subsets of tasks.
- Limiting access through port restrictions  
Limit access to the server by applying port restrictions.

## Restricting user access to the server

Authority levels determine what an administrator can do with the IBM Spectrum Protect™ server. An administrator with system authority can complete any task with the server. Administrators with policy, storage, or operator authority can complete subsets of tasks.

### Procedure

1. After you register an administrator by using the REGISTER ADMIN command, use the GRANT AUTHORITY command to set the administrator's authority level. For details about setting and changing authority, see [Managing administrators](#).
2. To control the authority of an administrator to complete some tasks, use the following two server options:
  - a. You can select the authority level that an administrator must have to issue QUERY and SELECT commands with the QUERYAUTH server option. By default, no authority level is required. You can change the requirement to one of the authority levels, including system.
  - b. You can specify that system authority is required for commands that cause the server to write to an external file with the REQSYSAUTHOUTFILE server option. By default, system authority is required for such commands.
3. You can restrict data backup on a client node to only root user IDs or authorized users. For example, to limit backups to the root user ID, issue the REGISTER NODE or UPDATE NODE command and specify the BACKUPINITIATION=root parameter:

```
update node backupinitiation=root
```

# Limiting access through port restrictions

Limit access to the server by applying port restrictions.

## About this task

You might have to restrict access to specific servers, based on your security requirements. The IBM Spectrum Protect™ server can be configured to listen on four TCP/IP ports: two that can be used for either regular TCP/IP protocols or Secure Sockets Layer (SSL)/Transport Layer Security (TLS) protocols and two that can be used only for the SSL/TLS protocol.

## Procedure

You can set the server options to specify the port that you require, as listed in Table 1.

Table 1. Server options and port access

Server option	Port access
TCPPORT	Specifies the port number on which the server TCP/IP communication driver is to wait for requests for client sessions. This port listens for both TCP/IP and SSL-enabled sessions. The default value is 1500.
TCPADMINPORT	Specifies the port number on which the server TCP/IP communication driver is to wait for requests for sessions other than client sessions. This port listens for both TCP/IP and SSL-enabled sessions. The default is the value of TCPPORT.  Use this option to separate administrative client traffic from regular client traffic that uses the TCPPORT and SSLTCPPORT options.
SSLTCPPORT	Specifies the SSL TCP/IP port address for a server. This port listens for SSL-enabled sessions only. A default port value is not available.
SSLTCPADMINPORT	Specifies the port address on which the server TCP/IP communication driver waits for requests for SSL-enabled sessions. A default port value is not available.  Use this option to separate administrative client traffic from regular client traffic that uses the TCPPORT and SSLTCPPORT options.

### Related reference:

Planning firewall access

## Stopping and starting the server

Before you complete maintenance or reconfiguration tasks, stop the server. Then, start the server in maintenance mode. When you are finished with the maintenance or reconfiguration tasks, restart the server in production mode.

### Before you begin

You must have system or operator privilege to stop and start the IBM Spectrum Protect™ server.

- Stopping the server  
Before you stop the server, prepare the system by ensuring that all database backup operations are completed, and all other processes and sessions are ended. In this way, you can safely shut down the server and ensure that data is protected.
- Starting the server for maintenance or reconfiguration tasks  
Before you begin server maintenance or reconfiguration tasks, start the server in maintenance mode. When you start the server in maintenance mode, you disable operations that might disrupt your maintenance or reconfiguration tasks.

## Stopping the server

Before you stop the server, prepare the system by ensuring that all database backup operations are completed, and all other processes and sessions are ended. In this way, you can safely shut down the server and ensure that data is protected.

### About this task

When you issue the HALT command to stop the server, the following actions occur:

- All processes and client node sessions are canceled.
- All current transactions are stopped. (The transactions will be rolled back when the server is restarted.)

## Procedure

---

To prepare the system and stop the server, complete the following steps:

1. Prevent new client node sessions from starting by issuing the DISABLE SESSIONS command:

```
disable sessions all
```

2. Determine whether any client node sessions or processes are in progress by completing the following steps:
  - a. On the Overview page of the Operations Center, view the Activity area for the total numbers of processes and sessions that are currently active. If numbers differ significantly from the usual numbers that are displayed during your daily storage-management routine, view other status indicators in the Operations Center to check whether there is a problem.
  - b. View the graph in the Activity area to compare the amount of network traffic over the following periods:
    - The current period, that is, the most recent 24-hour period
    - The previous period, that is, the 24 hours before the current periodIf the graph for the previous period represents the expected amount of traffic, significant differences on the graph for the current period might indicate a problem.
  - c. On the Servers page, select a server for which you want to view processes and sessions, and click Details. If the server is not registered as a hub or spoke server in the Operations Center, obtain information about processes by using administrative commands. Issue the QUERY PROCESS command to query processes and obtain information about sessions by issuing the QUERY SESSION command.
3. Wait until the client node sessions are completed or cancel them. To cancel processes and sessions, complete the following steps:
  - On the Servers page, select a server for which you want to view processes and sessions, and click Details.
  - Click the Active Tasks tab, and select one or more processes, sessions, or a combination of both that you want to cancel.
  - Click Cancel.
  - If the server is not registered as a hub or spoke server in the Operations Center, cancel sessions by using administrative commands. Issue the CANCEL SESSION command to cancel a session and cancel processes by using the CANCEL PROCESS command.

Tip: If the process that you want to cancel is waiting for a tape volume to be mounted, the mount request is canceled. For example, if you issue an EXPORT, IMPORT, or MOVE DATA command, the command might initiate a process that requires a tape volume to be mounted. However, if a tape volume is being mounted by an automated library, the cancel operation might not take effect until the mount process is complete. Depending on your system environment, this could take several minutes.
4. Stop the server by issuing the HALT command:

```
halt
```

## Starting the server for maintenance or reconfiguration tasks

---

Before you begin server maintenance or reconfiguration tasks, start the server in maintenance mode. When you start the server in maintenance mode, you disable operations that might disrupt your maintenance or reconfiguration tasks.

### About this task

---

Start the server in maintenance mode by running the DSMSERV utility with the MAINTENANCE parameter.

The following operations are disabled in maintenance mode:

- Administrative command schedules
- Client schedules
- Reclamation of storage space on the server
- Inventory expiration
- Migration of storage pools

In addition, clients are prevented from starting sessions with the server.

Tips:

- You do not have to edit the server options file, `dmserv.opt`, to start the server in maintenance mode.
- While the server is running in maintenance mode, you can manually start the storage-space reclamation, inventory expiration, and storage-pool migration processes.

## Procedure

---

To start the server in maintenance mode, issue the following command:

```
dmserv maintenance
```

Tip: To view a video about starting the server in maintenance mode, see [Starting a server in maintenance mode](#).

## What to do next

---

To resume server operations in production mode, complete the following steps:

1. Shut down the server by issuing the HALT command:

```
halt
```

2. Start the server by using the method that you use in production mode. Follow the instructions for your operating system:
  - o **AIX** Starting the server instance
  - o **Linux** Starting the server instance
  - o **Windows** Starting the server instance

Operations that were disabled during maintenance mode are reenabled.

## Planning to upgrade the server

---

When a fix pack or interim fix becomes available, you can upgrade the IBM Spectrum Protect™ server to take advantage of product improvements. Servers and clients can be upgraded at different times. Ensure that you complete the planning steps before you upgrade the server.

## About this task

---

Follow these guidelines:

- The preferred method is to upgrade the server by using the installation wizard. After you start the wizard, in the IBM Installation Manager window, click the Update icon; do not click the Install or Modify icon.
- If upgrades are available for both the server component and the Operations Center component, select the check boxes to upgrade both components.

## Procedure

---

1. Review the list of fix packs and interim fixes. See technote 1239415.
2. Review product improvements, which are described in readme files.  
Tip: When you obtain the installation package file from the IBM Spectrum Protect support site, you can also access the readme file.
3. Ensure that the version that you upgrade your server to is compatible with other components, such as storage agents and library clients. See technote 1302789.
4. If your solution includes servers or clients at a level that is earlier than V7.1, review the guidelines to ensure that client backup and archive operations are not disrupted. See technote 1053218.
5. Review the upgrade instructions. Ensure that you back up the server database, the device configuration information, and the volume history file.

## What to do next

---

To install a fix pack or interim fix, follow the instructions for your operating system:

- **AIX** Installing an IBM Spectrum Protect server fix pack
- **Linux** Installing an IBM Spectrum Protect server fix pack

- **Windows** Installing an IBM Spectrum Protect server fix pack

**Related information:**

[Upgrade and Migration Process - Frequently Asked Questions](#)

## Preparing for an outage or system update

---

Prepare IBM Spectrum Protect™ to maintain your system in a consistent state during a planned power outage or system update.

### About this task

---

Ensure that you schedule activities regularly to manage, protect, and maintain the server.

### Procedure

---

1. Cancel processes and sessions that are in progress by completing the following steps:
  - a. In the Operations Center, on the Servers page, select a server for which you want to view processes and sessions, and click Details.
  - b. Click the Active Tasks tab, and select one or more processes, sessions, or a combination of both that you want to cancel.
  - c. Click Cancel.
2. Stop the server by issuing the HALT command:

```
halt
```

Tip: You can issue the halt command from the Operations Center by hovering over the Settings icon and clicking Command Builder. Then, select the server, type `halt`, and press Enter.

## Implementing a disaster recovery plan

---

Implement a disaster recovery strategy to recover your applications if a disaster occurs and to ensure high server availability.

### About this task

---

Determine your disaster recovery requirements by identifying the business priorities for client node recovery, the systems that you use to recover data, and whether client nodes have connectivity to a recovery server. Use replication and storage pool protection to protect data. You must also determine how often directory-container storage pools are protected.

- **Completing recovery drills**  
Schedule disaster recovery drills to prepare for audits that certify the recoverability of the IBM Spectrum Protect server and to ensure that data can be restored and operations can resume after an outage. A drill also helps you ensure that all data can be restored and operations resumed before a critical situation occurs.

## Recovering from data loss or system outages

---

You can use IBM Spectrum Protect™ to recover data that was lost when a disaster or system outage occurred. You can recover directory-container storage pools, client data, and databases.

### Before you begin

---

Schedule client and server workloads to achieve the best performance for your storage environment. Issue the PROTECT STGPOOL and REPLICATE NODE commands as part of the schedule. Protect the storage pool before you replicate the client node. When node replication is started, the data extents that are already replicated through storage pool protection are skipped, which reduces replication processing time.

### Procedure

---

Use the following recovery methods based on the component that you must recover.

Component to recover	Procedure	More information
----------------------	-----------	------------------



Component to recover	Procedure	More information
Directory-container storage pool	<p>To recover directory-container storage pools, complete the following steps:</p> <ol style="list-style-type: none"> <li>a. Scan for damaged data extents in the directory-container storage pool by using the AUDIT CONTAINER command and specifying the ACTION=SCANALL parameter.</li> <li>b. Repair damaged data extents in the directory-container storage pool by using the REPAIR STGPOOL command. Restriction: You can repair a storage pool only if the storage pool is protected.</li> <li>c. Remove damaged data extents by using the AUDIT CONTAINER command and specifying the ACTION=REMOVEDAMAGED parameter.</li> </ol>	Repairing storage pools
Client data	<p>Prerequisites:</p> <ul style="list-style-type: none"> <li>• The source replication server, the target replication server, and the client must be at the V7.1 level or later. If any of the servers are at an earlier level, automatic failover is disabled and you must rely on manual failover.</li> </ul> <p>Manually configure the client to automatically fail over to the target server for data recovery.</p> <p>If you enabled the client for automated client failover, you can recover the data by using automatic failover function. You can verify that the userreplicationfailover option is either not in the client options file or is set to <i>yes</i>. Recover data from the target server when the source server is unavailable due to an outage by using automatic failover.</p> <p>Tip:</p> <ul style="list-style-type: none"> <li>• Use the SET FAILOVERHLADDRESS command to specify the IP address for the replication server during failover, if the address is different from the IP address that is specified for the replication process.</li> </ul>	<ul style="list-style-type: none"> <li>• Recovering damaged data from a replicated copy</li> <li>• SET FAILOVERHLADDRESS (Set a failover high level address)</li> </ul>

Component to recover	Procedure	More information
Database	<p>Prerequisites:</p> <ul style="list-style-type: none"> <li>To restore the database after a disaster, you must have a copy of the current device configuration file. The device configuration file cannot be recreated.</li> <li>Ensure that you have a backed up version of the database.</li> </ul> <p>Restore the IBM Spectrum Protect database to the most current state or to a specific point in time by using the DSMSEV RESTORE DB server utility.</p>	DSMSERV RESTORE DB (Restore the database)

- Restoring the database  
You might have to restore the IBM Spectrum Protect database after a disaster. You can restore the database to the most current state or to a specified point in time. You must have full, incremental, or snapshot database backup volumes to restore the database.
- Recovering damaged data from a replicated copy  
If a source replication server is unavailable, you can recover damaged data from a replicated copy that is stored on the target replication server.
- Repairing storage pools  
If a disaster or system outage occurred, you can repair deduplicated data extents in a directory-container storage pool.

**Related reference:**

- [AUDIT CONTAINER](#) (Verify the consistency of database information for a directory-container storage pool)
- [DSMSERV RESTORE DB](#) (Restore the database)

## Restoring the database

You might have to restore the IBM Spectrum Protect™ database after a disaster. You can restore the database to the most current state or to a specified point in time. You must have full, incremental, or snapshot database backup volumes to restore the database.

### Before you begin

If the database and recovery log directories are lost, re-create them before you issue the DSMSEV RESTORE DB server utility. For example, use the following commands:

```

AIX Linux
mkdir /tsmdb001
mkdir /tsmdb002
mkdir /tsmdb003
mkdir /activelog
mkdir /archlog
mkdir /archfaillog

```

**Windows**

```

mkdir e:\tsm\db001
mkdir f:\tsm\db001
mkdir g:\tsm\db001
mkdir h:\tsm\activelog
mkdir i:\tsm\archlog
mkdir j:\tsm\archfaillog

```

**Restrictions:**

- To restore the database to its latest version, you must locate the archive log directory. If you are cannot locate the directory, you can restore the database only to a point in time.

- You cannot use Secure Sockets Layer (SSL) for database restore operations.
- If the release level of the database backup is different from the release level of the server that is being restored, you cannot restore the server database. For example, if you are using a Version 8.1 server and you try to restore a Version 7.1 database, an error occurs.

## About this task

---

Point-in-time restore operations are typically used for situations such as disaster recovery or to remove the effects of errors that can cause inconsistencies in the database. To recover the database to the time when the database was lost, recover the database to its latest version.

## Procedure

---

Use the DSMSEV RESTORE DB server utility to restore the database. Depending on the version of the database that you want to restore, choose one of the following methods:

- Restore a database to its latest version. For example, use the following command:

```
dsmserv restore db
```

- Restore a database to a point in time. For example, to restore the database to a backup series that was created on 19 April 2015, use the following command:

```
dsmserv restore db todate=04/19/2015
```

## What to do next

---

If you restored the database and directory-container storage pools exist on the server, you must identify inconsistencies between the database and the file system.

1. If you restored the database to a point in time and you did not delay reuse of the directory-container storage pool, you must audit all the containers. To audit all containers, issue the following command:

```
audit container stgpool
```

2. If the server cannot identify containers on the system, complete the following steps to display a list of containers:
  - a. From an administrative client, issue the following command:

```
select container_name from containers
```

- b. From the file system, issue the following command for the storage pool directory on the source server:

Tip: The storage pool directory is displayed in the command output:

**AIX** | **Linux**

```
[root@source]$ ls -l
```

**Windows**

```
c:\source_stgpool\dir\00>dir
```

- c. Compare the containers that are listed on the file system and the server.
- d. Issue the AUDIT CONTAINER command and specify the container that is missing from the server output. Specify the ACTION=REMOVEDAMAGED parameter to delete the container.
- e. To ensure that the containers are deleted on the file system, review the messages that are displayed.

### Related tasks:

[Replicating client node data after a database restore \(V7.1.1\)](#)

### Related reference:

[AUDIT CONTAINER](#) (Verify the consistency of database information for a directory-container storage pool)

[DSMSERV RESTORE DB](#) (Restore the database)

## Recovering damaged data from a replicated copy

---

If a source replication server is unavailable, you can recover damaged data from a replicated copy that is stored on the target replication server.

## Before you begin

---

The server name that you specify with the SET REPLSERVER command must match the name of an existing server definition. It must also be the name of the server to be used as the target replication server. If the server name specified by this command does not match the server name of an existing server definition, the command fails.

Tip:

- Use care when you change or remove a target replication server. If you change a target replication server, client-node data that is replicated is sent to a different target replication server. If you remove a target replication server, client node data is not replicated.

## Procedure

---

1. Verify the replication status of the data on the target server. The replication status indicates whether the most recent backup was replicated to the secondary server.
2. Restore data from a target replication server by setting the source replication server as the target replication server. For example, if you want to set the source replication server as the target replication server, server1, issue the following command:

```
set replserver server1
```

## What to do next

---

When you restore the IBM Spectrum Protect™ database on a source replication server, replication is automatically disabled. Before you re-enable replication, determine whether copies of data that are on the target replication server are needed.

### Related tasks:

[↗ Replicating client node data after a database restore \(V7.1.1\)](#)

## Repairing storage pools

---

If a disaster or system outage occurred, you can repair deduplicated data extents in a directory-container storage pool.

## Before you begin

---

Identify inconsistencies between the database and the directory-container storage pool by using the AUDIT CONTAINER command. By identifying the damaged data extents in the directory-container storage pool, you can determine what data extents to repair.

Before you repair a storage pool, ensure that the storage pool is protected by using the PROTECT STGPOOL command.

## Procedure

---

1. To repair a directory-container storage pool, use the REPAIR STGPOOL command. For example, to repair a storage pool, STGPOOL1, issue the following command:

```
repair stgpool stgpool1
```

2. If the damaged storage pool is specified as a target storage pool on the PROTECT STGPOOL command for one or more source storage pools, issue the PROTECT STGPOOL command for all source storage pools.
3. To ensure that all damaged data is identified and repaired from other source storage pools, issue the PROTECT STGPOOL command again from all source storage pools and specify the FORCERECONCILE=YES parameter.
4. To remove objects that refer to damaged data, issue the AUDIT CONTAINER command and specify the ACTION=REMOVEDAMAGED parameter.
5. If the damaged storage pool is a target storage pool for node replication from one or more source servers, issue the REPLICATE NODE command again from all source servers.
6. When the damage is repaired, issue the PROTECT STGPOOL command to ensure that the storage pool is protected to another directory-container storage pool.

## What to do next

---

Ensure that no damaged data extents are displayed in the output by using the QUERY DAMAGED command.

### Related reference:

- 🔗 [Repairing and recovering data](#)
- 🔗 [AUDIT CONTAINER \(Verify the consistency of database information for a directory-container storage pool\)](#)
- 🔗 [QUERY DAMAGED \(Query damaged data in a directory-container or cloud-container storage pool\)](#)
- 🔗 [REPAIR STGPPOOL \(Repair a directory-container storage pool\)](#)

## Tape solution

This data protection solution provides storage to tape media, a flexible and affordable option for long-term data retention.

- **Planning for a tape-based data protection solution**  
Plan for a data protection solution that includes disk-to-disk-to-tape and disk-to-tape backup operations to optimize storage.
- **Implementation of a tape-based data protection solution**  
Implement the tape-based solution, which uses disk-to-disk-to-tape backup and disk staging to optimize storage. By implementing the tape solution, you can enable long-term data retention and achieve low-cost scalability.
- **Monitoring a tape solution**  
After you implement an IBM Spectrum Protect tape-based solution, monitor the solution to ensure correct operation. By monitoring the solution daily and periodically, you can identify existing and potential issues. The information that you gather can be used to troubleshoot problems and optimize system performance.
- **Managing operations for a tape solution**  
Use this information to manage operations for a tape implementation for an IBM Spectrum Protect server.

## Planning for a tape-based data protection solution

Plan for a data protection solution that includes disk-to-disk-to-tape and disk-to-tape backup operations to optimize storage.

### Planning roadmap

Plan for the tape solution by reviewing the architecture layout in Figure 1 and then completing the roadmap tasks that follow the diagram.

Figure 1. Tape solution

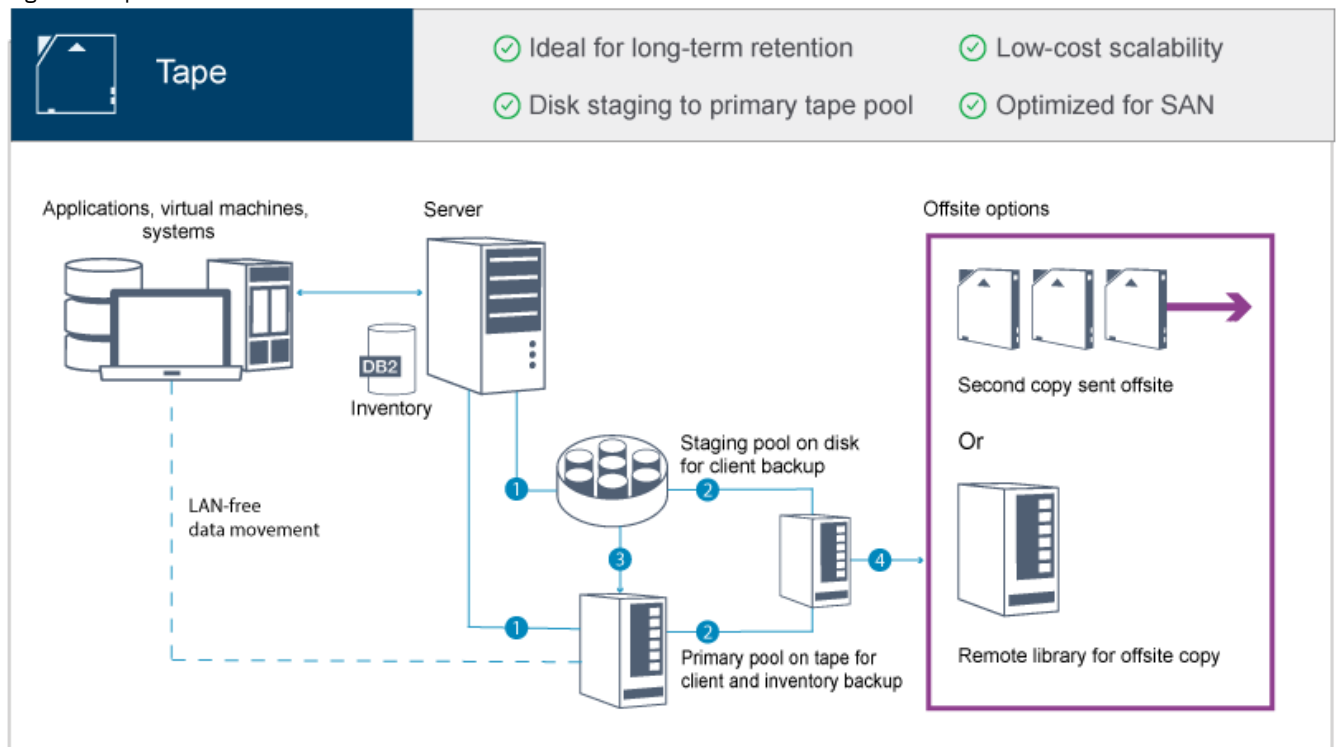

In this data protection configuration, the server uses both disk and tape storage hardware. Storage pool staging is used, in which client data is initially stored in disk storage pools and then later migrated to tape storage pools. For disaster recovery, tape

volumes can be stored offsite. Offsite options include physically moving a second copy offsite by a courier or electronically vaulting copies offsite to a remote library.

Tip: The described solution does not include node replication. However, if you want to use node replication to back up a storage pool from disk to disk, ensure that the replication operation is completed before data is migrated from disk to tape. You can also use node replication to back up a storage pool on a local tape device to a copy storage pool on a local tape device.

To plan for a tape-based solution, complete the following tasks:

1. Meet system requirements for hardware and software.
2. Record values for your system configuration in the planning worksheets.
3. Plan for disk storage.
4. Plan for tape storage.
5. Plan for security.

## Tape planning requirements

---

Before you implement a tape solution, review the general guidelines about system requirements. Determine whether to back up data to disk or tape, or a combination of both.

### Network bandwidth

The network must have sufficient bandwidth for the expected data transfers between the client and the server, and for the cross-site restore operations that are required for disaster recovery. Use a storage area network (SAN) for data transfers among the server, disk devices, and tape devices. For more information, see [Hardware requirements](#).

### Data migration

Migrate all data from disk to tape daily. Specify a FILE device class for disk-based storage pools. Schedule migration to control when processing occurs. To prevent automatic migration based on the migration threshold, specify a value of 100 for the HIGHMIG parameter and 0 for the LOWMIG parameter when you issue the DEFINE STGPPOOL command. You must keep at least 20% of the tape drives available for restore operations. To use up to 80% of available tape drives and improve throughput performance, specify the MIGPROCESS parameter.

Consider the following information based on the type of data that is migrated:

- Use tape to back up data from clients that have large objects, such as databases.  
Tip: Check with your tape-drive manufacturer for guidance about the size of the database that is suitable to write to tape.
- Use disk to back up data from clients that have smaller objects.
- To back up data directly to tape, use LAN-free data movement. For more information, see [Configuring LAN-free data movement](#).
- Do not back up virtual machines to tape. Use a separate disk-based storage pool that does not migrate to a tape-based storage pool. For more information about virtual machine support, see [technote 1239546](#).

### Storage pool capacity

Maintain enough storage pool capacity to allow for 2 days of client backups and a buffer of 20%. You might have to schedule full backups over a few days to ensure that you have enough storage pool space.

### Tape drives

Review the manufacturer specifications and estimate the capacity of a tape drive. Determine the amount of space that is required for backup and migration operations. Reserve 20% of tape drives for restore operations.

### Related reference:

[MIGRATE STGPPOOL \(Migrate storage pool to next storage pool\)](#)

## System requirements for a tape-based solution

---

Hardware and software requirements are provided for a tape-based storage solution that has a data ingestion rate of 14 TB per hour.

Review the information to determine the hardware and software requirements for your storage environment. You might have to make adjustments based on your system size.

- **Hardware requirements**  
Hardware requirements for your IBM Spectrum Protect™ solution are based on system size. Choose equivalent or better components than those items that are listed to ensure optimum performance for your environment.

- Software requirements  
Documentation for the IBM Spectrum Protect tape-based solution includes installation and configuration tasks for IBM® AIX®, Linux, and Microsoft Windows operating systems. You must meet the minimum software requirements that are listed.

## Hardware requirements

Hardware requirements for your IBM Spectrum Protect™ solution are based on system size. Choose equivalent or better components than those items that are listed to ensure optimum performance for your environment.

For more information about planning disk devices, see Planning for disk storage.

For more information about planning tape devices, see Planning for tape storage.

The following table includes minimum hardware requirements for the server and storage. If you are using local partitions (LPARs) or work partitions (WPARs), adjust the network requirements to take account of the partition sizes. The figures in the table are based on a data ingestion rate of 14 TB per hour.

Hardware component	System requirements
Server processor	<p><b>AIX</b> 8 processor cores, 3.42 GHz or faster. For example, use a POWER8® processor-based server.</p> <p><b>Linux</b>   <b>Windows</b> 16 processor cores, 2.0 GHz or faster. For example, use an Intel Xeon processor.</p>
Server memory	64 GB RAM.
Network	<p>The following sizing manages approximately 14 TB of data per hour:</p> <ul style="list-style-type: none"> <li>• 10 Gb Ethernet (a minimum of four ports)</li> <li>• 8 Gb Fibre Channel adapter (a minimum of four ports)</li> </ul> <p>The number of ports depends on the percentage of daily data ingestion to disk storage pools versus tape storage.</p> <p>Use separate Fibre Channel adapters for tape and disk data.</p>

Hardware component	System requirements
Storage	<p data-bbox="433 184 483 212">Disk</p> <p data-bbox="500 216 1455 275">Based on the amount of data that you are writing to disk, specify the number of disks that you require.</p> <p data-bbox="500 300 1430 359">Ensure that the sequential input/output (I/O) throughput of the storage area network (SAN) matches the I/O throughput for the network in the previous row.</p> <p data-bbox="500 384 1503 506">For example, if you must back up 10 TB of data in a four-hour window, the throughput is approximately 700 MB per second. In this case, the server requires a front-end network (client-to-server path) that supports a minimum throughput of 700 MB per second. The back-end SAN (the server-to-storage device path) also must support a minimum throughput of 700 MB per second.</p> <p data-bbox="500 531 1159 558">To calculate the required disk speed, use the following formulas:</p> $\frac{\text{(Total amount of daily data ingestion - amount of daily data ingestion directly to tape)}}{\text{(Number of hours for daily client backup operations)}} = \text{Megabytes of data ingestion to disk per hour}$ $\frac{\text{(Megabytes of data ingestion to disk per hour)}}{\text{(3600 seconds per hour)}} = \text{Megabytes of data ingestion per second that must be supported by the disk technology}$ <p data-bbox="433 835 483 863">Tape</p> <p data-bbox="500 867 1503 1010">Select the tape technology that best fits your business requirements. For example, use IBM Linear Tape-Open (LTO) or IBM TS1150 tape drives. Ensure that you have sufficient mount points for client backup operations and for migration. For more information about planning tape storage, see <a href="#">Planning for tape storage</a>. For a list of supported tape devices, see <a href="#">IBM® Support Portal for IBM Spectrum Protect</a>.</p> <p data-bbox="500 1014 1146 1041">Tip: To optimize data movement, use LAN-free data movement.</p>
SAN I/O adapters	<p data-bbox="433 1087 1503 1146">Segregate disk and tape I/O. For more information about selecting an adapter, see the documentation for <a href="#">Brocade hardware products</a> and for <a href="#">IBM Storwize® storage solutions</a>.</p> <p data-bbox="433 1171 483 1199">Disk</p> <p data-bbox="500 1203 769 1230">Use at least two adapters.</p> <p data-bbox="433 1255 483 1283">Tape</p> <p data-bbox="500 1287 769 1314">Use at least two adapters.</p>

## Estimating space requirements for the Operations Center

Hardware requirements for the Operations Center are included in the preceding table, except for the database and archive log space (inventory) that the Operations Center uses to hold records for managed clients.

If you do not plan to install the Operations Center on the same system as the IBM Spectrum Protect server, you can estimate system requirements separately. To calculate system requirements for the Operations Center, see the system requirements calculator in technote 1641684.

Managing the Operations Center on the IBM Spectrum Protect server is a workload that requires extra space for database operations on both the hub server and any spoke servers. The amount of space on the hub server for the archive log is larger if the hub server is monitoring one or more spoke servers. Review the following guidelines to estimate how much space your IBM Spectrum Protect server requires.

### Database space for the Operations Center

The Operations Center uses approximately 4.4 GB of database space for every 1000 clients that are monitored on that server. This calculation applies to both hub servers and spoke servers within a configuration.

For example, consider a hub server with 2000 clients that also manages three spoke servers, each with 1000 clients. This configuration has a total of 5000 clients across the four servers. Each of the spoke servers requires 4.4 GB of database space. If the spoke servers are at IBM Spectrum Protect Version 8.1.2 or later, the hub server requires 8.8 GB of database space for monitoring only its 2000 clients:



$$(4.4 \text{ GB} \times 2) = 8.8 \text{ GB}$$

#### Database space for managed data

*Managed data* is the amount of data that is protected, including the amount of data for all retained versions.

- For client types that perform incremental-forever backups, the following formula can be used to estimate the total managed data:

$$\text{Front-end} + (\text{front-end} \times \text{change rate} \times (\text{retention} - 1))$$

For example, if you back up 100 TB of front-end data, use a 30-day retention period, and have a 5% change rate, calculate your total managed data by using the following figures:

$$100 \text{ TB} + (100 \text{ TB} \times 0.05 \times (30-1)) = 245 \text{ TB total managed data}$$

- For client types that perform full backups every day, the following formula can be used to estimate the total managed data:

$$\text{Front-end} \times \text{retention} \times (1 + \text{change rate})$$

For example, if you back up 10 TB of front-end data, use a 30-day retention period, and have a 3% change rate, calculate your total managed data by using the following figures:

$$10 \text{ TB} \times 30 \times (1 + .03) = 309 \text{ TB total managed data}$$

Unstructured data, average object size: 4 MB

Structured data, average object size: 128 MB

Unstructured data, number of objects =

$$(245 \text{ TB} \times 1024 \times 1024) / 4 \text{ MB} = 64225280$$

Structured data, number of objects =

$$(309 \text{ TB} \times 1024 \times 1024) / 128 \text{ MB} = 2531328$$

Total number of objects: 66756608

Managed data cost (1 KB per object) =

$$(66756608 \text{ KB}) / (1024 \times 1024) = 63.66 \text{ GB}$$

Plan for 20% of additional space so that database systems are not at 100% capacity:

$$\text{Database total physical storage requirements} = (\text{managed data space} + \text{Operations Center space}) \times (1.20)$$

For this example, you would calculate the space by using the following figures:

$$(66.33 \text{ GB} + 8.4 \text{ GB}) \times 1.20 = 76.41 \text{ GB}$$

#### Archive log space

The Operations Center uses approximately 18 GB of archive log space every 24 hours, per server, for every 1000 clients monitored on that server. Additionally, for every 1000 clients that are monitored on spoke servers, additional archive log space is used on the hub server. For spoke servers at V8.1.2 or later, this added amount is 1.2 GB of archive log space on the hub server per 1000 clients monitored every 24 hours.

For example, consider a hub server with 2000 clients that also manages three spoke servers, each with 1000 clients. This configuration has a total of 5000 clients across the four servers. You can calculate the archive log space for the hub server by using the following formula:

$$((18 \text{ GB} \times 2) + (1.2 \text{ GB} \times 3)) = 39.6 \text{ GB of archive log space}$$

These estimates are based on the default status collection interval of 5 minutes. If you reduce the collection interval from once every 5 minutes to once every 3 minutes, the space requirements increase. The following examples show the approximate increase in the log space requirements with a collection interval of once every 3 minutes for a configuration in which V8.1.2 or later spoke servers are monitored:

- Hub server: In the range 39.6 GB - 66 GB

- Each spoke server: In the range 18 GB - 30 GB

Allocate archive log space so that you can support the Operations Center without affecting server operations.

## Software requirements

Documentation for the IBM Spectrum Protect™ tape-based solution includes installation and configuration tasks for IBM® AIX®, Linux, and Microsoft Windows operating systems. You must meet the minimum software requirements that are listed.

For information about software requirements for IBM lin\_tape device drivers, refer to the IBM Tape Device Drivers Installation and User's Guide.

### AIX systems

Type of software	Minimum software requirements
Operating system	IBM AIX 7.1  For more information about operating system requirements, see AIX: Minimum system requirements for AIX systems.
Gunzip utility	The gunzip utility must be available on your system before you install or upgrade the IBM Spectrum Protect server. Ensure that the gunzip utility is installed and the path to it is set in the PATH environment variable.
File system type	JFS2 file systems  AIX systems can cache a large amount of file system data, which can reduce memory that is required for server and IBM DB2® processes. To avoid paging with the AIX server, use the rbrw mount option for the JFS2 file system. Less memory is used for the file system cache and more is available for IBM Spectrum Protect.  Do not use the file system mount options, Concurrent I/O (CIO), and Direct I/O (DIO), for file systems that contain the IBM Spectrum Protect database, logs, or storage pool volumes. These options can cause performance degradation of many server operations. IBM Spectrum Protect and DB2 can still use DIO where it is beneficial to do so, but IBM Spectrum Protect does not require the mount options to selectively take advantage of these techniques.
Other software	Korn Shell (ksh)

### Linux systems

Type of software	Minimum software requirements
Operating system	Red Hat Enterprise Linux 7 (x86_64)
Libraries	GNU C libraries, Version 2.3.3-98.38 or later that is installed on the IBM Spectrum Protect system. Red Hat Enterprise Linux Servers: <ul style="list-style-type: none"> <li>• libaio</li> <li>• libstdc++.so.6 (32-bit and 64-bit packages are required)</li> <li>• numactl.x86_64</li> </ul>
File system type	Format database-related file systems with ext3 or ext4.  For storage pool-related file systems, use XFS.
Other software	Korn Shell (ksh)

### Windows systems

Type of software	Minimum software requirements
Operating system	Microsoft Windows Server 2012 R2 (64-bit) or Windows Server 2016

Type of software	Minimum software requirements
File system type	NTFS
Other software	<p>Windows 2012 R2 or Windows 2016 with .NET Framework 3.5 is installed and enabled.</p> <p>The following User Account Control policies must be disabled:</p> <ul style="list-style-type: none"> <li>User Account Control: Admin Approval Mode for the Built-in Administrator account</li> <li>User Account Control: Run all administrators in Admin Approval Mode</li> </ul>

## Planning worksheets

Use the planning worksheets to record values that you use to set up your system and configure the IBM Spectrum Protect™ server. Use the best practice default values that are listed in the worksheets.

Each worksheet helps you prepare for different parts of the system configuration by using best practice values:

### Server system preconfiguration

Use the preconfiguration worksheets to plan for the file systems and directories that you create when you configure file systems for IBM Spectrum Protect during system setup. All directories that you create for the server must be empty.

### Server configuration

Use the configuration worksheets when you configure the server. Default values are suggested for most items, except where noted.

Table 1. Worksheet for preconfiguration of a server system

Item	Default value	Your value	Minimum directory size	More information
TCP/IP port address for communications with the server	1500		Not applicable.	<p>Ensure that this port is available when you install and configure the operating system.</p> <p>The port number can be a number in the range 1024 - 32767.</p>
Directory for the server instance	<p><b>AIX</b>   <b>Linux</b> /home/tsminst1/tsminst1</p> <p><b>Windows</b> C:\tsminst1</p>		<p><b>AIX</b> 50 GB.</p> <p><b>Linux</b>   <b>Windows</b> 25 GB.</p>	If you change the value for the server instance directory from the default, also modify the DB2® instance owner value in Table 2.
Directory for server installation	<ul style="list-style-type: none"> <li><b>AIX</b>   <b>Linux</b> /</li> <li><b>Windows</b> C:</li> </ul>		<p><b>AIX</b> Available space that is required for the directory: 5 GB.</p> <p><b>Linux</b>   <b>Windows</b> Minimum space that is required for the directory: 30 GB</p>	
Directory for server installation	/usr		<b>AIX</b> Available space that is required for the directory: 5 GB.	
Directory for server installation	<b>AIX</b> /var		<b>AIX</b> Available space that is required for the directory: 5 GB.	

Item	Default value	Your value	Minimum directory size	More information
Directory for server installation	<b>AIX</b> /tmp		<b>AIX</b> Available space that is required for the directory: 5 GB.	
Directory for server installation	<b>AIX</b> /opt		<b>AIX</b> Available space that is required for the directory: 10 GB.	
Directory for the active log	<b>AIX</b>   <b>Linux</b> /tsminst1/TSMalog <b>Windows</b> C:\tsminst1\TSMalog		128 GB.	When you create the active log during the initial configuration of the server, set the size to 128 GB.
Directory for the archive log	<b>AIX</b>   <b>Linux</b> /tsminst1/TSMarchlog <b>Windows</b> C:\tsminst1\TSMarchlog		3 TB.	
Directories for the database	<b>AIX</b>   <b>Linux</b> /tsminst1/TSMdbspace00 /tsminst1/TSMdbspace01 /tsminst1/TSMdbspace02 /tsminst1/TSMdbspace03 <b>Windows</b> C:\tsminst1\TSMdbspace00 C:\tsminst1\TSMdbspace01 C:\tsminst1\TSMdbspace02 C:\tsminst1\TSMdbspace03		For instructions about calculating space requirements, see Hardware requirements.	Create four file systems for the database.
Directories for storage	<b>AIX</b>   <b>Linux</b> /tsminst1/TSMfile00 /tsminst1/TSMfile01 /tsminst1/TSMfile02 /tsminst1/TSMfile03 ... <b>Windows</b> C:\tsminst1\TSMfile00 C:\tsminst1\TSMfile01 C:\tsminst1\TSMfile02 C:\tsminst1\TSMfile03 ...		Determine the minimum total capacity for all directories by using the following calculation:  Daily percentage of ingested data that is written to disk + 20% = Minimum total capacity	The preferred method is to define at least one directory for each tape device.

Table 2. Worksheet for IBM Spectrum Protect configuration

Item	Default value	Your value	More information
DB2 instance owner	tsminst1		If you changed the value for the server instance directory in Table 1 from the default, also modify the value for the DB2 instance owner.
DB2 instance owner password	<b>AIX</b>   <b>Linux</b> passwd <b>Windows</b> pAssWOrd		Select a different value for the instance owner password than the default. Ensure that you record this value in a secure location.
Primary group for the DB2 instance owner	<b>AIX</b>   <b>Linux</b> tsmsrvrs		
Server name	The default value for the server name is the system host name.		

Item	Default value	Your value	More information
Server password	passwOrd		Select a different value for the server password than the default. Ensure that you record this value in a secure location.
Administrator ID: user ID for the server instance	admin		
Administrator ID password	passwOrd		Select a different value for the administrator password than the default. Ensure that you record this value in a secure location.
Schedule start time	23:00		<p>The default schedule start time begins the client workload phase, which is predominantly the client backup and archive activities. During the client workload phase, server resources support client operations. Normally, these operations are completed during the nightly schedule window.</p> <p>Schedules for server maintenance operations are defined to begin 10 hours after the start of the client backup window.</p> <p>In this guide, the suggested time to start client backup operations is 23:00.</p>

Table 3. Worksheet for tape configuration

Item	Default value	Your value	More information
Robotic device files	<p>IBM® devices with an IBM tape device driver:</p> <ul style="list-style-type: none"> <li>• <b>AIX</b> /dev/smcX</li> <li>• <b>Linux</b> /dev/IBMchangerX</li> <li>• <b>Windows</b> ChangerX</li> </ul> <p>Non-IBM devices with an IBM Spectrum Protect device driver:</p> <ul style="list-style-type: none"> <li>• <b>AIX</b> /dev/lbX</li> <li>• <b>Linux</b> /dev/tsm SCSI/lbX</li> <li>• <b>Windows</b> lbA.B.C.D</li> </ul>		<p>To manually define the library device files, use the following commands:</p> <ul style="list-style-type: none"> <li>• DEFINE LIBRARY</li> <li>• DEFINE DRIVE</li> <li>• DEFINE PATH</li> </ul> <p>For SCSI, you can use the PERFORM LIBACTION command to define all drives and their paths for a single library in one step. To use this command to define all drives and paths, the SANDISCOVERY option must be supported and enabled.</p>

Item	Default value	Your value	More information
Tape drives	<p>IBM devices with an IBM tape device driver:</p> <ul style="list-style-type: none"> <li>• <b>AIX</b> /dev/rmtX</li> <li>• <b>Linux</b> /dev/IBMtapeX</li> <li>• <b>Windows</b> TapeX</li> </ul> <p>Non-IBM devices with an IBM Spectrum Protect device driver:</p> <ul style="list-style-type: none"> <li>• <b>AIX</b> /dev/mtX</li> <li>• <b>Linux</b> /dev/tsm SCSI/mtX</li> <li>• <b>Windows</b> mtA.B.C.D</li> </ul>		

## Planning for disk storage

Choose the most effective storage technology for IBM Spectrum Protect™ components to ensure efficient server performance and operations.

Storage hardware devices have different capacity and performance characteristics, which determine how they can be used effectively with IBM Spectrum Protect. For general guidance about selecting the appropriate storage hardware and setup for your solution, review the following guidelines.

Database, active log, and archive log

- Use a solid-state disk (SSD) or a fast, 15,000 rpm disk for the IBM Spectrum Protect database and active log.
- When you create arrays for the database, use RAID level 5.
- Use separate disks for archive log and database backup storage.

Storage pool

Use RAID level 6 for storage pool arrays to add protection against double drive failures when you use large disk types.

- Planning the storage arrays  
Prepare for disk storage configuration by planning for RAID arrays and volumes, according to the size of your IBM Spectrum Protect system.

## Planning for tape storage

Determine which tape devices to use and how to configure them. To optimize system performance, plan to use fast, high-capacity tape devices. Provision enough tape drives to meet your business requirements.

- Supported tape devices and libraries  
The server can use a wide range of tape devices and libraries. Select tape devices and libraries that meet your business requirements.
- Supported tape device configurations  
Review the information about local area networks (LAN) and storage area networks (SAN). To optimize data movement, plan to configure LAN-free data movement. In addition, consider whether to use library sharing.
- Required definitions for tape storage devices  
Before the IBM Spectrum Protect™ server can use a tape device, you must configure the device to the operating system and to the server. As part of the planning process, determine which definitions are required for your tape storage devices.
- Planning the storage pool hierarchy  
Plan the storage pool hierarchy to ensure that data is migrated daily from disk to tape. The migration releases space on the disk device and moves the data to tape for long-term retention. In this way, you can take advantage of the scalability, cost efficiency, and security features of tape storage.
- Offsite data storage  
To facilitate data recovery and as part of your disaster recovery strategy, store tape copies offsite.

## Supported tape devices and libraries

The server can use a wide range of tape devices and libraries. Select tape devices and libraries that meet your business requirements.

For a list of supported devices and valid device class formats, see the website for your operating system:

- **AIX** | **Windows** Supported devices for AIX and Windows
- **Linux** Supported devices for Linux

For more information about storage devices and storage objects, see *Types of storage devices*.

Each device that is defined to IBM Spectrum Protect™ is associated with one *device class*. The device class specifies the device type and media management information, such as recording format, estimated capacity, and labeling prefixes.

A *device type* identifies a device as a member of a group of devices that share similar media characteristics. For example, the LTO device type applies to all generations of LTO tape drives.

A device class for a tape drive must also specify a library. A *physical library* is a collection of one or more drives that share similar media-mounting requirements. That is, the drive can be mounted by an operator or by an automated mounting mechanism.

A *library object definition* specifies the library type and other characteristics that are associated with that library type.

The following table lists the preferred library types for an IBM Spectrum Protect Version 8.1.2 tape solution.

Table 1. Library types for an IBM Spectrum Protect 8.1.2 tape solution

Library type	Description	More information
SCSI	<p>A SCSI library is controlled through a SCSI interface, attached either directly to the server's host by using SCSI cabling or by a storage area network. A robot or other mechanism automatically handles tape volume mounts and dismounts.</p> <p>If you create different drive types for a SCSI library, you create multiple logical libraries that cannot be split between different types of drives. A SCSI library can contain drives of mixed technologies, including LTO Ultrium and digital linear tape (DLT) drives. For example:</p> <ul style="list-style-type: none"><li>• The Oracle StorageTek L700 library</li><li>• The IBM® 3592 tape device</li></ul>	<p>Configuring libraries for use by a server</p> <p>Restrictions apply when you mix different generations of media and drives. For more information, see:</p> <ul style="list-style-type: none"><li>• Mixing generations of 3592 drives and media in a single library</li><li>• Mixing LTO drives and media in a library</li></ul>
Shared	<p>Shared libraries are logical libraries that are represented by SCSI. The library is controlled by the IBM Spectrum Protect server that is configured as a library manager.</p> <p>IBM Spectrum Protect servers that use the SHARED library type are library clients to the library manager server. Shared libraries reference a library manager.</p>	

## Supported tape device configurations

Review the information about local area networks (LAN) and storage area networks (SAN). To optimize data movement, plan to configure LAN-free data movement. In addition, consider whether to use library sharing.

Select the device configuration that meets your business requirements.

- LAN-based and LAN-free data movement  
You can move data between clients and storage devices that are attached to a local area network (LAN), or to storage devices that are attached to a storage area network (SAN), known as LAN-free data movement.
- Library sharing  
You can optimize the efficiency of your tape solution by configuring library sharing. Library sharing allows multiple IBM Spectrum Protect™ servers to use the same tape library and drives on a storage area network (SAN) and to improve backup and recovery performance and tape hardware utilization.

- LAN-free data movement  
IBM Spectrum Protect provides the capability for a client, through a storage agent, to directly back up and restore data to a tape library on a SAN. This type of data movement is also known as LAN-free data movement.
- Mixed device types in libraries  
IBM Spectrum Protect supports mixing different device types within a single automated library, if the library can distinguish among the different media for the different device types. To simplify the configuration process, do not plan to mix different device types within a library. If you must mix device types, review the restrictions.

## LAN-based and LAN-free data movement

---

You can move data between clients and storage devices that are attached to a local area network (LAN), or to storage devices that are attached to a storage area network (SAN), known as LAN-free data movement.

In a conventional LAN configuration, one or more tape libraries are associated with a single IBM Spectrum Protect™ server. LAN-free data movement makes LAN bandwidth available for other uses and decreases the load on the IBM Spectrum Protect server.

In a LAN configuration, client data, email, terminal connection, application program, and device control information must be handled by the same network. Device control information and client backup and restore data flow across the LAN.

A SAN is a dedicated storage network that can improve system performance.

By using IBM Spectrum Protect in a SAN, you benefit from the following functions:

- Sharing storage devices among multiple IBM Spectrum Protect servers.  
Restriction: A storage device with the GENERICTAPE device type cannot be shared among servers.
- Moving IBM Spectrum Protect client data directly to storage devices (LAN-free data movement) by configuring a storage agent on the client system.

In a SAN, you can share tape drives and libraries that are supported by the IBM Spectrum Protect server, including most SCSI tape devices.

When IBM Spectrum Protect servers share a SCSI tape, one server, the *library manager*, owns and controls the device. The storage agents, along with other IBM Spectrum Protect servers that share this library are *library clients*. A library client requests shared library resources, such as drives or media, from the library manager, but uses the resources independently. The library manager coordinates the access to these resources. IBM Spectrum Protect servers that are defined as library clients use server-to-server communications to contact the library manager and request device service. Data moves over the SAN between each server and the storage device.

Requirement: If you define a library manager server that is shared with the IBM Spectrum Protect server, the SANDISCOVERY option must be set to ON. By default, this option is set to OFF.

IBM Spectrum Protect servers use the following features when sharing an automated library:

### Partitioning of the volume inventory

The inventory of media volumes in the shared library is partitioned among servers. Either one server owns a particular volume, or the volume is in the global scratch pool. No server owns the scratch pool.

### Serialized drive access

Only one server accesses each tape drive at a time. Drive access is serialized. IBM Spectrum Protect controls drive access so that servers do not dismount other servers' volumes or write to drives where other servers mount their volumes.

### Serialized mount access

The library autochanger completes a single mount or dismount operation at a time. The library manager completes all mount operations to provide this serialization.

## Library sharing

---

You can optimize the efficiency of your tape solution by configuring library sharing. Library sharing allows multiple IBM Spectrum Protect™ servers to use the same tape library and drives on a storage area network (SAN) and to improve backup and recovery performance and tape hardware utilization.

When IBM Spectrum Protect servers share a library, one server is set up as the library manager and controls library operations such as mount and dismount. The library manager also controls volume ownership and the library inventory. Other servers are set up as library clients and use server-to-server communications to contact the library manager and request resources.

Library clients must be at the same or an earlier version than the library manager server. A library manager cannot support library clients that are at a later version. For more information, see Storage-agent and library-client compatibility with an IBM Spectrum



Protect server.

## LAN-free data movement

IBM Spectrum Protect™ provides the capability for a client, through a storage agent, to directly back up and restore data to a tape library on a SAN. This type of data movement is also known as LAN-free data movement.

Restriction: Centera storage devices cannot be targets for LAN-free operations.

Figure 1 shows a SAN configuration in which a client directly accesses a tape to read or write data.

Figure 1. LAN-free data movement

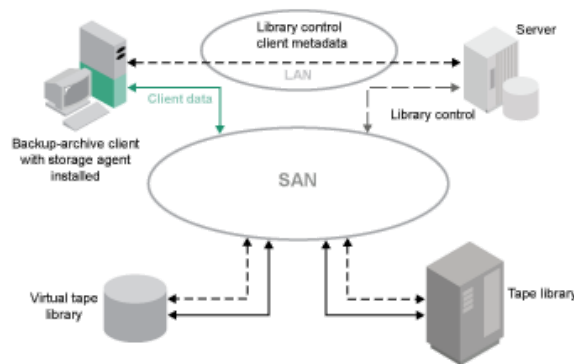

LAN-free data movement requires the installation of a storage agent on the client system. The server maintains the database and recovery log, and acts as the library manager to control device operations. The storage agent on the client handles the data transfer to the device on the SAN. This implementation frees up bandwidth on the LAN that would otherwise be used for client data movement.

## Mixed device types in libraries

IBM Spectrum Protect™ supports mixing different device types within a single automated library, if the library can distinguish among the different media for the different device types. To simplify the configuration process, do not plan to mix different device types within a library. If you must mix device types, review the restrictions.

Libraries with this capability are models that have built-in mixed drives, or that support the addition of mixed drives. For information about specific models, see the manufacturer's documentation. To learn about libraries that were tested on IBM Spectrum Protect with mixed device types, see the information for your operating system:

- IBM Spectrum Protect Supported Devices for AIX®, HP-UX, Solaris, and Windows

- IBM Spectrum Protect Supported Devices for Linux

For example, you can have LTO Ultrium drives and IBM TS4500 drives in a single library that is defined to the IBM Spectrum Protect server.

- Different media generations in a library  
The IBM Spectrum Protect server allows mixed device types in an automated library, but the mixing of different generations of the same type of drive is generally not supported. New drives cannot write to the older media formats, and old drives cannot read new formats. LTO Ultrium drives are an exception to this rule.
- Mixed media and storage pools  
You can optimize the efficiency of your tape solution by not mixing media formats in a storage pool. Instead of mixing formats, map each unique media format to a separate storage pool by using its own device class. This restriction also applies to LTO formats.

## Different media generations in a library

---

The IBM Spectrum Protect™ server allows mixed device types in an automated library, but the mixing of different generations of the same type of drive is generally not supported. New drives cannot write to the older media formats, and old drives cannot read new formats. LTO Ultrium drives are an exception to this rule.

If the new drive technology cannot write to media that is formatted by older generation drives, the older media must be marked read-only to avoid problems for server operations. Also, the older drives must be removed from the library, or the definitions of the older drives must be removed from the server. For example, the IBM Spectrum Protect server does not support the use of Oracle StorageTek 9940A drives with 9940B drives in combination with other device types in a single library.

In general, IBM Spectrum Protect does not support mixing generations of LTO Ultrium drives and media. However, the following mixtures are supported:

- LTO Ultrium Generation 3 (LTO-3) with LTO Ultrium Generation 4 (LTO-4)
- LTO Ultrium Generation 4 (LTO-4) with LTO Ultrium Generation 5 (LTO-5)
- LTO Ultrium Generation 5 (LTO-5) with LTO Ultrium Generation 6 (LTO-6)
- LTO Ultrium Generation 6 (LTO-6) with LTO Ultrium Generation 7 (LTO-7)

The server supports these mixtures because the different drives can read and write to the different media. If you plan to upgrade all drives to Generation 4 (or Generation 5, 6, or 7), you must delete all existing LTO Ultrium drive definitions and the paths that are associated with them. Then, you can define the new Generation 4 (or Generation 5, 6, or 7) drives and paths.

Restrictions that apply to mixing LTO Ultrium tape drives and media

- LTO-5 drives can read only LTO-3 media. If you are mixing LTO-3 with LTO-5 drives and media in a single library, you must mark the LTO-3 media as read-only. You must check out all LTO-3 scratch volumes.
- LTO-6 drives can read only LTO-4 media. If you are mixing LTO-4 with LTO-6 drives and media in a single library, you must mark the LTO-4 media as read-only. You must check out all LTO-4 scratch volumes.
- LTO-7 drives can read only LTO-5 media. If you are mixing LTO-5 with LTO-7 drives and media in a single library, you must mark the LTO-5 media as read-only. You must check out all LTO-5 scratch volumes.

Restrictions that apply to mixed generation LTO Ultrium tape drives in a library

You must use tape cartridges that are an earlier generation than the tape drive. A later generation tape drive can read and write data to an earlier generation tape cartridge. For an example, if a library has LTO-7 and LTO-6 tape drives, you must use LTO-6 tape cartridges. Both the LTO-7 and LTO-6 tape drives can read and write data to LTO-6 tape cartridges.

Restrictions that apply to mixed generation LTO Ultrium tape cartridges in a library

You must use a tape cartridge that is the same generation as the tape drive, or one generation earlier. For example, if a library has LTO-7 tape drives, you can use LTO-7 tape cartridges or mixed LTO-7 and LTO-6 tape cartridges. If this library has LTO-7, LTO-6, and LTO-5 tape cartridges, you must change the access mode to READONLY for the LTO-5 tape cartridges.

To learn about additional considerations when you mix LTO Ultrium generations, see [Defining LTO device classes](#).

When you use IBM Spectrum Protect, you cannot mix drives that are 3592, TS1130, TS1140, TS1150, and later drive generations. Use one of three special configurations. For details, see [Defining 3592 device classes](#).

If you plan to encrypt volumes in a library, do not mix media generations in the library.

## Mixed media and storage pools

You can optimize the efficiency of your tape solution by not mixing media formats in a storage pool. Instead of mixing formats, map each unique media format to a separate storage pool by using its own device class. This restriction also applies to LTO formats.

Multiple storage pools and their device classes of different types can point to the same library that can support them as described in Different media generations in a library.

You can migrate to a new generation of a media type within the same storage pool by following these steps:

1. Replace all older drives with the newer generation drives within the library. The drives should be mixed.
2. Mark the existing volumes with the older formats read-only if the new drive cannot append those tapes in the old format. If the new drive can write to the existing media in their old format, this is not necessary, but Step 1 is still required. If it is necessary to keep different drive generations that are read but not write compatible within the same library, use separate storage pools for each.

## Required definitions for tape storage devices

Before the IBM Spectrum Protect™ server can use a tape device, you must configure the device to the operating system and to the server. As part of the planning process, determine which definitions are required for your tape storage devices.

Tip: You can use the PERFORM LIBACTION command to simplify the process when you add devices to SCSI and VTL library types.

Table 1 summarizes the definitions that are required for different device types.

Table 1. Required definitions for storage devices

Device	Device types	Required definitions			
		Library	Drive	Path	Device class
Magnetic disk	DISK	—	—	—	Yes <sup>1</sup>
	FILE <sup>2</sup>	—	—	—	Yes
	<div style="display: flex; align-items: center;"> <div style="background-color: #800040; color: white; padding: 2px 5px; margin-right: 5px;">AIX</div> <div style="background-color: #800040; color: white; padding: 2px 5px; margin-right: 5px;">Windows</div> <div>CENTERA</div> </div> <div style="display: flex; align-items: center; margin-top: 5px;"> <div style="background-color: #800040; color: white; padding: 2px 5px; margin-right: 5px;">Linux</div> <div>CENTERA <sup>3</sup></div> </div>	—	—	—	Yes
Tape	<ul style="list-style-type: none"> <li>3590</li> <li>3592</li> <li>DLT</li> <li>LTO</li> <li>NAS</li> <li>VOLSAFE</li> </ul> <div style="display: flex; align-items: center; margin-top: 5px;"> <div style="background-color: #800040; color: white; padding: 2px 5px; margin-right: 5px;">AIX</div> <div style="background-color: #800040; color: white; padding: 2px 5px; margin-right: 5px;">Windows</div> <div>GENERICTAPE</div> </div> <div style="margin-top: 5px;">ECARTRIDGE <sup>4</sup></div>	Yes	Yes	Yes	Yes
Removable media (file system)	REMOVABLEFILE	Yes	Yes	Yes	Yes

1. The DISK device class exists at installation and cannot be changed.
2. FILE libraries, drives, and paths are required for sharing with storage agents.
3. 

Linux

 The CENTERA device type is available only for Linux x86\_64 systems.
4. The ECARTRIDGE device type is for Oracle StorageTek cartridge tape drives such as 9840 and T10000 drives.

## Planning the storage pool hierarchy

Plan the storage pool hierarchy to ensure that data is migrated daily from disk to tape. The migration releases space on the disk device and moves the data to tape for long-term retention. In this way, you can take advantage of the scalability, cost efficiency, and security features of tape storage.

## Before you begin

The storage pool hierarchy helps to manage the flow of data. To understand the data flow, review Figure 1. Figure 1. Tape solution

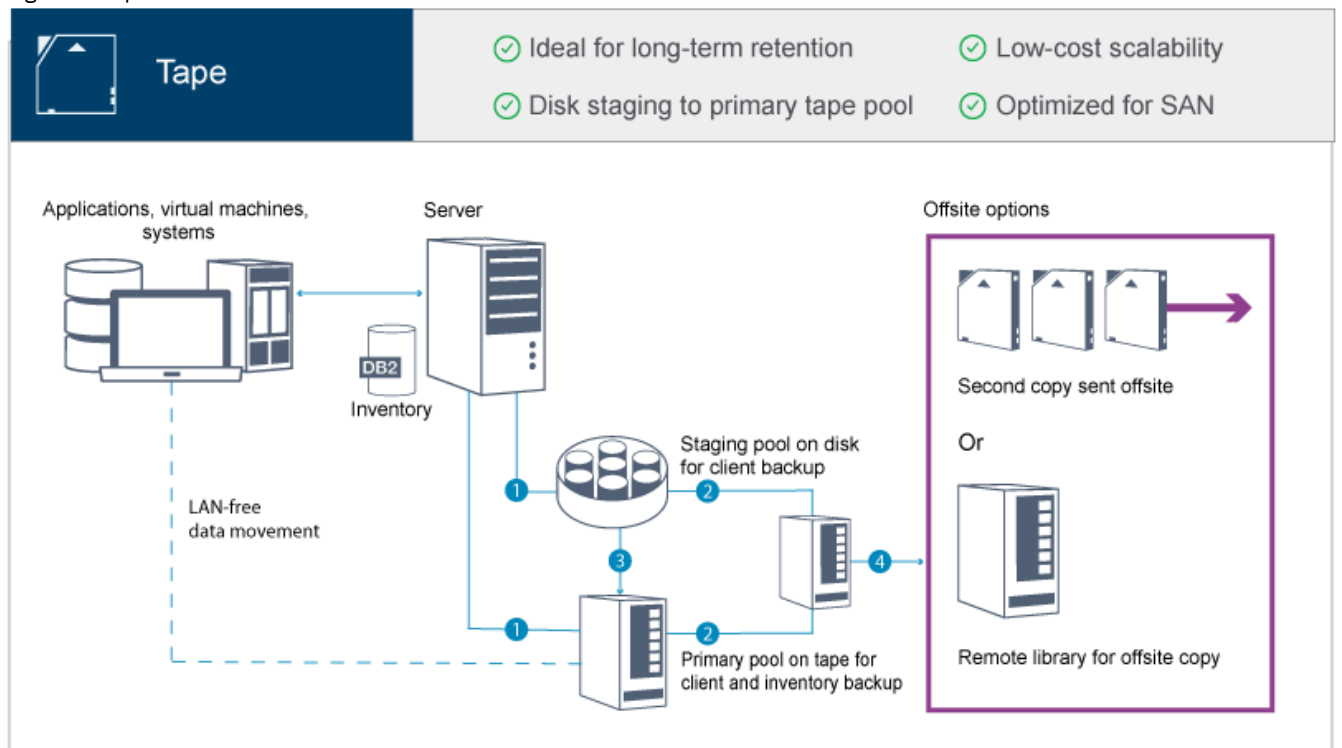

The following steps correspond to the numbers in the figure:

1. The server receives data from clients (applications, virtual machines, or systems) and stores the data on primary storage pools. Depending on the client type, the data is stored on a primary storage pool on disk or tape.
2. The data on disk and tape is backed up to a copy storage pool on tape.
3. Data in the primary storage pool on disk is migrated daily to the primary storage pool on tape.
4. Data from the copy storage pool on tape is moved offsite to support long-term retention and disaster recovery.

## Procedure

To plan the storage pool hierarchy, answer the following questions:

- a. Which clients should back up data to disk, and which clients should back up data to tape?
  - o The preferred method is to back up clients that host large objects, such as databases, to tape.
  - o The preferred method is to back up all other clients to disk.
  - o Virtual machine (VM) clients can be backed up to disk or tape. The preferred method is to back up a VM client to a separate disk storage pool, which is not migrated to tape. If you must migrate a VM client to tape, create a smaller disk storage pool to hold the VMware control files. This smaller disk storage pool cannot be allowed to migrate to tape. For more information about backing up a VM client to tape, see Tape media guidelines and technote 1239546.

Tip: If many clients must back up data to a single storage pool, consider using a storage pool on disk because you can specify many mount points. You can specify a maximum value of 999 for the MAXNUMMP parameter on the REGISTER NODE command.

- b. What are the considerations for specifying the capacity of disk-based storage pools?

At minimum, plan enough capacity to store data from a single day of backup operations. The preferred method is to plan enough capacity to store data from two days' worth of backup operations and add a 20% buffer.

- c. What are the considerations for specifying the device class for the disk-based storage pool?

The preferred method is to specify a FILE device class. Set the MOUNTLIMIT parameter to 4000. Also, ensure that the node has a sufficiently high number of mount points, which you can specify by using the MAXNUMMP parameter on the REGISTER NODE command.

- d. Should data deduplication be specified for the disk storage pool?

No, because the data is stored on disk for only one day before the data is migrated to tape.

e. Should automatic migration of data be specified based on a migration threshold?

No. Instead, plan to schedule daily migration by using the `MIGRATE STGPOOL` command. (To prevent automatic migration based on the migration threshold, specify a value of 100 for the `HIGHMIG` parameter and 0 for the `LOWMIG` parameter when you issue the `DEFINE STGPOOL` command.)

f. Should a migration delay be specified?

The preferred method is to specify migration from disk to tape daily, and not specify a migration delay, which requires additional planning. For more information about migration delays, see *Migrating files in a storage pool hierarchy*.

g. How can the number of tape drives be calculated?

- i. Determine the native data transfer rate of the drive by reviewing the manufacturer's documentation. To obtain an estimate of the sustained data transfer rate in your storage environment, subtract 30% from the native data transfer rate.
- ii. Calculate the required rate of data ingestion by the server. Then, divide that figure by the sustained data transfer rate of a single tape device. The result is the minimum number of drives to support data ingestion.
- iii. Calculate the number of mount points that are required by clients that back up data to tape, including those clients that use multiple sessions. You can distribute the mount points over the backup window, keeping in mind that clients are likely backing up large objects, which might use most of the window.
- iv. Calculate the performance requirements *and* mount points that are required for maintenance tasks, such as disk-to-tape migration and tape-to-tape copies. By backing up data to tape, you can avoid migration processing, but making tape-to-tape copies will double the tape drive requirement.
- v. Calculate the number of additional drives that might be required, for example:
  - If a tape drive malfunctions, the issue impacts the number of available mount points and the ingestion rate. Consider provisioning spare drives. For example, if you require five tape drives for normal operations, consider provisioning two spare drives.
  - Restore and retrieve operations might require additional tape drives if you plan to run the operations simultaneously with data ingestion and maintenance operations. If necessary, provision additional tape drives and ensure that they are unused when you start the restore or retrieve operations.

h. What alternatives are available for optimizing restore operations?

You can use collocation to improve system performance and optimize data organization. Collocation can reduce the number of volumes that must be accessed when a large amount of data must be restored:

- For disk-based storage pools, the preferred method is to use collocation by node. The server stores the data for the node on as few volumes as possible.
- For tape-based storage pools, the preferred method is to use collocation by group. Collocation by group results in a reduction of unused tape capacity, which allows for more collocated data on individual tapes.

For more information about collocation, see *Optimizing operations by enabling collocation of client files*.

If you are an experienced system administrator, you might plan additional actions to optimize restore operations. See *Optimizing restore operations for clients, File backup techniques, and MOVE NODEDATA (Move data by node in a sequential access storage pool)*.

## Offsite data storage

---

To facilitate data recovery and as part of your disaster recovery strategy, store tape copies offsite.

Use the disaster recovery manager (DRM) function to configure and automatically generate a disaster recovery plan that contains the information, scripts, and procedures that are required to automatically restore the server and recover client data after a disaster. Choose from one of the following offsite data storage options as a disaster recovery strategy to protect tape copies:

**Offsite vaulting from a single production site**

Storage volumes, such as tape cartridges and media volumes, are vaulted at an offsite location. A courier transports the data from the offsite storage facility to the recovery site. If a disaster occurs, the volumes are sent back to the production site after hardware and the IBM Spectrum Protect™ server are restored.

**Offsite vaulting with a recovery site**

A courier moves storage volumes from the production site to an offsite storage facility. By having a dedicated recovery site, you can reduce recovery time compared to the single production site. However, this option increases the cost of disaster recovery because more hardware and software must be maintained. For example, the recovery site must have compatible tape devices and IBM Spectrum Protect server software. Before the production site can be recovered, the hardware and software at the recovery site must be set up and running.

## Electronic vaulting

To use electronic vaulting as a disaster recovery strategy, the recovery site must have a running IBM Spectrum Protect server. Critical data is vaulted electronically from the production site to the recovery site. DRM is also used for offsite vaulting of noncritical data. Electronic vaulting moves critical data offsite faster and more frequently than traditional courier methods. Recovery time is reduced because critical data is already stored at the recovery site. However, because the recovery site runs continuously, the cost of the disaster recovery strategy is more expensive than offsite vaulting.

### Related concepts:

Preparing for and recovering from a disaster by using DRM

## Planning for security

Plan to protect the security of systems in the IBM Spectrum Protect™ solution with access and authentication controls, and consider encrypting data and password transmission.

- Planning for administrator roles  
Define the authority levels that you want to assign to administrators who have access to the IBM Spectrum Protect solution.
- Planning for secure communications  
Plan for protecting communications among the IBM Spectrum Protect solution components.
- Planning for storage of encrypted data  
Determine whether your company requires stored data to be encrypted, and choose the method that best suits your needs.
- Planning firewall access  
Determine the firewalls that are set and the ports that must be open for the IBM Spectrum Protect solution to work.

## Planning for administrator roles

Define the authority levels that you want to assign to administrators who have access to the IBM Spectrum Protect™ solution.

You can assign one of the following levels of authority to administrators:

### System

Administrators with system authority have the highest level of authority. Administrators with this level of authority can complete any task. They can manage all policy domains and storage pools, and grant authority to other administrators.

### Policy

Administrators who have policy authority can manage all of the tasks that are related to policy management. This privilege can be unrestricted, or can be restricted to specific policy domains.

### Storage

Administrators who have storage authority can allocate and control storage resources for the server.

### Operator

Administrators who have operator authority can control the immediate operation of the server and the availability of storage media such as tape libraries and drives.

The scenarios in Table 1 provide examples about why you might want to assign varying levels of authority so that administrators can perform tasks:

Table 1. Scenarios for administrator roles

Scenario	Type of administrator ID to set up
An administrator at a small company manages the server and is responsible for all server activities.	<ul style="list-style-type: none"><li>• System authority: 1 administrator ID</li></ul>
An administrator for multiple servers also manages the overall system. Several other administrators manage their own storage pools.	<ul style="list-style-type: none"><li>• System authority on all servers: 1 administrator ID for the overall system administrator</li><li>• Storage authority for designated storage pools: 1 administrator ID for each of the other administrators</li></ul>
An administrator manages 2 servers. Another person helps with the administration tasks. Two assistants are responsible for helping to ensure that important systems are backed up. Each assistant is responsible for monitoring the scheduled backups on one of the IBM Spectrum Protect servers.	<ul style="list-style-type: none"><li>• System authority on both servers: 2 administrator IDs</li><li>• Operator authority: 2 administrator IDs for the assistants with access to the server that each person is responsible for</li></ul>

### Related tasks:

Managing administrators

## Planning for secure communications

Plan for protecting communications among the IBM Spectrum Protect™ solution components.

Determine the level of protection that is required for your data, based on regulations and business requirements under which your company operates.

If your business requires a high level of security for passwords and data transmission, plan on implementing secure communication with Transport Layer Security (TLS) or Secure Sockets Layer (SSL) protocols.

TLS and SSL provide secure communications between the server and client, but can affect system performance. To improve system performance, use TLS for authentication without encrypting object data. To specify whether the server uses TLS 1.2 for the entire session or only for authentication, see the SSL client option for client-to-server communication, and the UPDATE SERVER=SSL parameter for server-to-server communication. Beginning in V8.1.2, TLS is used for authentication by default. If you decide to use TLS to encrypt entire sessions, use the protocol only for sessions where it is necessary and add processor resources on the server to manage the increase in network traffic. You can also try other options. For example, some networking devices such as routers and switches provide the TLS or SSL function.

You can use TLS and SSL to protect some or all of the different possible communication paths, for example:

- Operations Center: browser to hub; hub to spoke
- Client to server
- Server to server: node replication

### Related tasks:

Configuring secure communications with Transport Layer Security

## Planning for storage of encrypted data

Determine whether your company requires stored data to be encrypted, and choose the method that best suits your needs.

Table 1. Selecting a data encryption method

Business requirement	Encryption method	Additional information
Protect data at the client level.	IBM Spectrum Protect™ client encryption	You can encrypt data at the file level by using an include/exclude list. In this way, you can maintain a high degree of control over which data is encrypted. Extra computing resources are required at the client that might affect the performance of backup and restore processes. For more information about this method, see IBM Spectrum Protect client encryption.
Protect data in storage pool volumes on a tape drive.	Application method	When you use the Application method, IBM Spectrum Protect manages the encryption keys to protect data in storage pool volumes. You must take extra care to secure database backups because the encryption keys are stored in the server database. Without access to database backups and matching encryption keys, you cannot restore your data. You cannot use this method to encrypt database backups, exported data, or backup sets. For more information about the Application method, see Tape encryption methods.
Protect data on a tape drive.	Library method	When you use the Library method, the library manages encryption keys. You can encrypt both data in storage pools and other data on a tape drive. You can control which volumes are encrypted by using their bar code serial numbers. For more information about the Library method, see Tape encryption methods.
Protect data on a tape drive.	System method	When you use the System method, a device driver or the AIX operating system manages encryption. This encryption method is available only on the AIX® operating system. You can encrypt both data in storage pools and other data on a tape drive. For more information about the System method, see Tape encryption methods.

## Planning firewall access

Determine the firewalls that are set and the ports that must be open for the IBM Spectrum Protect™ solution to work.

Table 1 describes the ports that are used by the server, client, and Operations Center.

Table 1. Ports that are used by the server, client, and Operations Center

Item	Default	Direction	Description
Base port (TCPPOINT)	1500	Outbound/inbound	Each server instance requires a unique port. You can specify an alternative port number. The TCPPOINT option listens for both TCP/IP and SSL-enabled sessions from the client. You can use the TCPADMINPORT option and ADMINONCLIENTPORT option to set port values for administrative client traffic.
SSL-only port (SSLTCPPOINT)	No default	Outbound/inbound	This port is used if you want to restrict communication on the port to SSL-enabled sessions only. A server can support both SSL and non-SSL communication by using the TCPPOINT or TCPADMINPORT options.
SMB	45	Inbound/outbound	This port is used by configuration wizards that communicate by using native protocols with multiple hosts.
SSH	22	Inbound/outbound	This port is used by configuration wizards that communicate by using native protocols with multiple hosts.
SMTP	25	Outbound	This port is used to send email alerts from the server.
Replication	No default	Outbound/inbound	The port and protocol for the outbound port for replication are set by the DEFINE SERVER command that is used to set up replication.  The inbound ports for replication are the TCP ports and SSL ports are specified for the source server on the DEFINE SERVER command.
Client schedule port	Client port: 1501	Outbound	The client listens on the port that is named and communicates the port number to the server. The server contacts the client if server prompted scheduling is used. You can specify an alternative port number in the client options file.
Long-running sessions	KEEPALIVE setting: YES	Outbound	When the KEEPALIVE option is enabled, keepalive packets are sent during client/server sessions to prevent the firewall software from closing long-running, inactive connections.
Operations Center	HTTPS: 11090	Inbound	These ports are used for the Operations Center web browser. You can specify an alternative port number.
Client management service port	Client port: 9028	Inbound	If you plan to use IBM Spectrum Protect client management services, the client management service port must be accessible from the Operations Center. Ensure that firewalls cannot prevent connections. The client management service uses the TCP port of the server for the client node for authentication by using an administrative session.

**Related tasks:**

- 🔗 [Collecting diagnostic information with IBM Spectrum Protect client management services](#)

**Related reference:**

- 🔗 [ADMINONCLIENTPORT server option](#)
- 🔗 [DEFINE SERVER \(Define a server for server-to-server communications\)](#)
- 🔗 [TCPADMINPORT server option](#)
- 🔗 [TCPPOINT server option](#)

## Implementation of a tape-based data protection solution

Implement the tape-based solution, which uses disk-to-disk-to-tape backup and disk staging to optimize storage. By implementing the tape solution, you can enable long-term data retention and achieve low-cost scalability.





## Tape

✓ Ideal for long-term retention

✓ Low-cost scalability

✓ Disk staging to primary tape pool

✓ Optimized for SAN

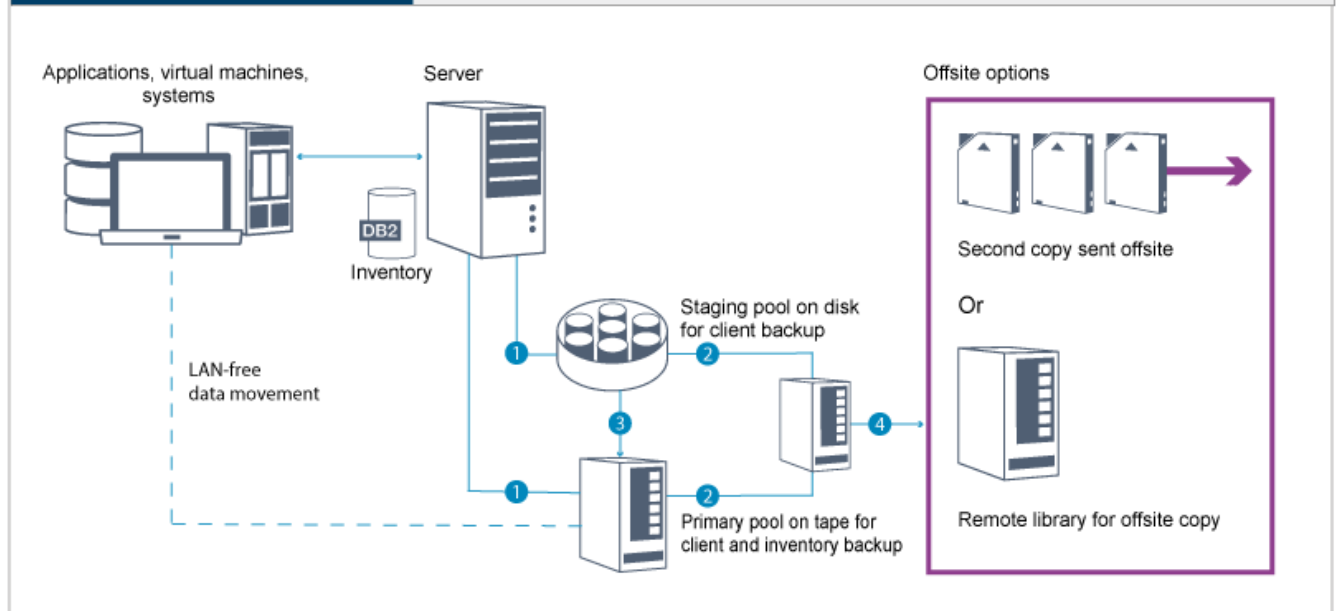

Tip: The described solution does not include node replication. However, if you want to use node replication to back up a storage pool from disk to disk, ensure that the replication operation is completed before data is migrated from disk to tape. You can also use node replication to back up a storage pool on a local tape device to a copy storage pool on a local tape device.

## Implementation roadmap

The following steps are required to set up a tape-based solution.

1. Set up the system.
2. Install the server and the Operations Center.
3. Configure the server and the Operations Center.
4. Attach tape devices for the server.
5. Configure tape libraries for use by the server.
6. Set up a storage pool hierarchy.
7. Install and configure clients.
8. Configure LAN-free data movement.
9. Select an encryption method and configure encryption.
10. Set up tape storage operations.
11. Complete the implementation.

## Setting up the system

To set up the system, you must first configure your disk storage hardware and the server system for IBM Spectrum Protect™.

### About this task

Tip: Procedures for setting up the server and the disk storage system are described. To get started with setting up tape devices, see [Attaching tape devices for the server](#).

- **Configuring the storage hardware**  
To optimize disk storage, review the guidelines for setting up disk storage with IBM Spectrum Protect. Then, provide a connection between the server and the disk storage devices and complete other configuration tasks.
- **Installing the server operating system**  
Install the operating system on the server system and ensure that IBM Spectrum Protect server requirements are met. Adjust operating system settings as directed.
- **Configuring multipath I/O**  
You can enable and configure multipathing for disk storage. Use the documentation that is provided with your hardware for

detailed instructions.

- Creating the user ID for the server  
Create the user ID that owns the IBM Spectrum Protect server instance. You specify this user ID when you create the server instance during initial configuration of the server.
- Preparing file systems for the server  
You must complete file system configuration for the disk storage to be used by the server.

## Configuring the storage hardware

---

To optimize disk storage, review the guidelines for setting up disk storage with IBM Spectrum Protect. Then, provide a connection between the server and the disk storage devices and complete other configuration tasks.

### Before you begin

---

For guidelines about setting up disk storage, see Checklist for storage pools on DISK or FILE

### Procedure

---

1. Provide a connection between the server and the storage devices by following these guidelines:
  - Use a switch or direct connection for Fibre Channel connections.
  - Consider the number of ports that are connected and account for the amount of bandwidth that is needed.
  - Consider the number of ports on the server and the number of host ports on the disk system that are connected.
2. Verify that device drivers and firmware for the server system, adapters, and operating system are current and at the recommended levels.
3. Configure storage arrays. Make sure that you planned properly to ensure optimal performance. For more information, see Planning for disk storage.
4. Ensure that the server system has access to disk volumes that are created. Complete the following steps:
  - a. If the system is connected to a Fibre Channel switch, zone the server to see the disks.
  - b. Map all of the volumes to tell the disk system that this specific server is allowed to see each disk.
5. Ensure that tape and disk devices use different Host Bus Adapter (HBA) ports. Control tape and disk I/O by using the SAN.

#### Related tasks:

Configuring multipath I/O

## Installing the server operating system

---

Install the operating system on the server system and ensure that IBM Spectrum Protect™ server requirements are met. Adjust operating system settings as directed.

- Installing on AIX systems  
Complete the following steps to install AIX® on the server system.
- Installing on Linux systems  
Complete the following steps to install Linux x86\_64 on the server system.
- Installing on Windows systems  
Install Microsoft Windows Server 2012 Standard Edition on the server system and prepare the system for installation and configuration of the IBM Spectrum Protect server.

## Installing on AIX systems

---

Complete the following steps to install AIX® on the server system.

### Procedure

---

1. Install AIX Version 7.1, TL4, SP2, or later according to the manufacturer instructions.
2. Configure your TCP/IP settings according to the operating system installation instructions.
3. Open the /etc/hosts file and complete the following actions:
  - Update the file to include the IP address and host name for the server. For example:

```
192.0.2.7 server.yourdomain.com server
```

- o Verify that the file contains an entry for localhost with an address of 127.0.0.1. For example:

```
127.0.0.1 localhost
```

4. Enable AIX I/O completion ports by issuing the following command:

```
chdev -l iocp0 -P
```

Server performance can be affected by the Olson time zone definition.

5. To optimize performance, change your system time zone format from Olson to POSIX. Use the following command format to update the time zone setting:

```
chtz=local_timezone,date/time,date/time
```

For example, if you lived in Tucson, Arizona, where Mountain Standard Time is used, you would issue the following command to change to the POSIX format:

```
chtz MST7MDT,M3.2.0/2:00:00,M11.1.0/2:00:00
```

6. Add an entry in the .profile of the instance user so that the following environment is set:

```
export MALLOCOPTIONS=multiheap:16
```

7. Set the system to create full application core files. Issue the following command:

```
chdev -l sys0 -a fullcore=true -P
```

8. For communications with the server and Operations Center, make sure that the following ports are open on any firewalls that might exist:

- o For communications with the server, open port 1500.
- o For secure communications with the Operations Center, open port 11090 on the hub server.

If you are not using the default port values, make sure that the ports that you are using are open.

9. Enable TCP high-performance enhancements. Issue the following command:

```
no -p -o rfc1323=1
```

10. For optimal throughput and reliability, bond four 10 Gb Ethernet ports together. Use the System Management Interface Tool (SMIT) to bond the ports together by using Etherchannel. The following settings were used during testing:

```
mode          8023ad
auto_recovery yes          Enable automatic recovery after failover
backup_adapter NONE       Adapter used when whole channel fails
hash_mode     src_dst_port Determines how outgoing adapter is chosen
interval      long        Determines interval value for IEEE
                        802.3ad mode
mode          8023ad      EtherChannel mode of operation
netaddr      0            Address to ping
no_loss_failover yes     Enable lossless failover after ping
                        failure
num_retries   3            Times to retry ping before failing
retry_time    1            Wait time (in seconds) between pings
use_alt_addr  no          Enable Alternate EtherChannel Address
use_jumbo_frame no       Enable Gigabit Ethernet Jumbo Frames
```

11. Verify that user process resource limits, also known as *ulimits*, are set according to guidelines in Table 1. If ulimit values are not set correctly, you might experience server instability or a failure of the server to respond.

Table 1. User limits (ulimit) values

User limit type	Setting	Value	Command to query value
Maximum size of core files created	core	Unlimited	ulimit -Hc
Maximum size of a data segment for a process	data	Unlimited	ulimit -Hd
Maximum file size	fsize	Unlimited	ulimit -Hf
Maximum number of open files	nofile	65536	ulimit -Hn

User limit type	Setting	Value	Command to query value
Maximum amount of processor time in seconds	cpu	Unlimited	<code>ulimit -Ht</code>
Maximum number of user processes	nproc	16384	<code>ulimit -Hu</code>

If you need to modify any user limit values, follow the instructions in the documentation for your operating system.

## Installing on Linux systems

Complete the following steps to install Linux x86\_64 on the server system.

### Before you begin

The operating system will be installed on the internal hard disks. Configure the internal hard disks by using a hardware RAID 1 array. For example, if you are configuring a small system, the two 300 GB internal disks are mirrored in RAID 1 so that a single 300 GB disk appears available to the operating system installer.

### Procedure

1. Install Red Hat Enterprise Linux Version 7.1 or later, according to the manufacturer instructions. Obtain a bootable DVD that contains Red Hat Enterprise Linux Version 7.1 and start your system from this DVD. See the following guidance for installation options. If an item is not mentioned in the following list, leave the default selection.
  - a. After you start the DVD, choose Install or upgrade an existing system from the menu.
  - b. On the Welcome screen, select Test this media & install Red Hat Enterprise Linux 7.1.
  - c. Select your language and keyboard preferences.
  - d. Select your location to set the correct time zone.
  - e. Select Software Selection and then on the next screen, select Server with GUI.
  - f. From the installation summary page, click Installation Destination and verify the following items:
    - The local 300 GB disk is selected as the installation target.
    - Under Other Storage Options, Automatically configure partitioning is selected.

Click Done.
  - g. Click Begin Installation. After the installation starts, set the root password for your root user account.

After the installation is completed, restart the system and log in as the root user. Issue the `df` command to verify your basic partitioning. For example, on a test system, the initial partitioning produced the following result:

```
[root@tvapp02]# df -h
Filesystem      Size  Used Avail Use% Mounted on
/dev/mapper/rhel-root  50G  3.0G  48G   6% /
devtmpfs        32G   0    32G   0% /dev
tmpfs           32G  92K   32G   1% /dev/shm
tmpfs           32G  8.8M   32G   1% /run
tmpfs           32G   0    32G   0% /sys/fs/cgroup
/dev/mapper/rhel-home 220G  37M  220G   1% /home
/dev/sdal       497M 124M  373M  25% /boot
```

2. Configure your TCP/IP settings according to the operating system installation instructions.

For optimal throughput and reliability, consider bonding multiple network ports together. This can be accomplished by creating a Link Aggregation Control Protocol (LACP) network connection, which aggregates several subordinate ports into a single logical connection. The preferred method is to use a bond mode of 802.3ad, miimon setting of 100, and a `xmit_hash_policy` setting of layer3+4.

Restriction: To use an LACP network connection, you must have a network switch that supports LACP.

For additional instructions about configuring bonded network connections with Red Hat Enterprise Linux Version 7, see [Create a Channel Bonding Interface](#).

3. Open the `/etc/hosts` file and complete the following actions:
  - o Update the file to include the IP address and host name for the server. For example:

```
192.0.2.7  server.yourdomain.com  server
```
  - o Verify that the file contains an entry for localhost with an address of 127.0.0.1. For example:

```
127.0.0.1  localhost
```

4. Install components that are required for the server installation. Complete the following steps to create a Yellowdog Updater Modified (YUM) repository and install the prerequisite packages.

a. Mount your Red Hat Enterprise Linux installation DVD to a system directory. For example, to mount it to the /mnt directory, issue the following command:

```
mount -t iso9660 -o ro /dev/cdrom /mnt
```

b. Verify that the DVD mounted by issuing the mount command. You should see output similar to the following example:

```
/dev/sr0 on /mnt type iso9660
```

c. Change to the YUM repository directory by issuing the following command:

```
cd /etc/yum/repos.d
```

If the repos.d directory does not exist, create it.

d. List directory contents:

```
ls rhel-source.repo
```

e. Rename the original repo file by issuing the mv command. For example:

```
mv rhel-source.repo rhel-source.repo.orig
```

f. Create a new repo file by using a text editor. For example, to use the vi editor, issue the following command:

```
vi rhel71_dvd.repo
```

g. Add the following lines to the new repo file. The baseurl parameter specifies your directory mount point:

```
[rhel71_dvd]
name=DVD Redhat Enterprise Linux 7.1
baseurl=file:///mnt
enabled=1
gpgcheck=0
```

h. Install the prerequisite package ksh.x86\_64, by issuing the yum command. For example:

```
yum install ksh.x86_64
```

Exception: You do not need to install the compat-libstdc++-33-3.2.3-69.el6.i686 and libstdc++.i686 libraries for Red Hat Enterprise Linux Version 7.1.

5. When the software installation is complete, you can restore the original YUM repository values by completing the following steps:

a. Unmount the Red Hat Enterprise Linux installation DVD by issuing the following command:

```
umount /mnt
```

b. Change to the YUM repository directory by issuing the following command:

```
cd /etc/yum/repos.d
```

c. Rename the repo file that you created:

```
mv rhel71_dvd.repo rhel71_dvd.repo.orig
```

d. Rename the original file to the original name:

```
mv rhel-source.repo.orig rhel-source.repo
```

6. Determine whether kernel parameter changes are required. Complete the following steps:

a. Use the sysctl -a command to list the parameter values.

b. Analyze the results by using the guidelines in Table 1 to determine whether any changes are required.

c. If changes are required, set the parameters in the /etc/sysctl.conf file. The file changes are applied when the system is started.

Tip: Automatically adjust kernel parameter settings and eliminate the need for manual updates to these settings. On Linux, the DB2® database software automatically adjusts interprocess communication (IPC) kernel parameter values to the preferred settings. For more information about kernel parameter settings, search for Linux kernel parameters in the IBM DB2 Version 11.1 Knowledge Center.

Table 1. Linux kernel parameter optimum settings

Parameter	Description
kernel.shmmni	The maximum number of segments.
kernel.shmmax	The maximum size of a shared memory segment (bytes). This parameter must be set before automatically starting the IBM Spectrum Protect™ server on system startup.
kernel.shmall	The maximum allocation of shared memory pages (pages).
kernel.sem	(SEMMSL) The maximum semaphores per array.
There are four values for the kernel.sem parameter.	(SEMMNS) The maximum semaphores per system.
	(SEMOPM) The maximum operations per semaphore call.
	(SEMMNI) The maximum number of arrays.
kernel.msgmni	The maximum number of system-wide message queues.
kernel.msgmax	The maximum size of messages (bytes).
kernel.msgmnb	The default maximum size of queue (bytes).
kernel.randomize_va_space	The kernel.randomize_va_space parameter configures the use of memory ASLR for the kernel. Disable ASLR because it can cause errors for the DB2 software. To learn more details about the Linux ASLR and DB2, see technote 1365583.
vm.swappiness	The vm.swappiness parameter defines whether the kernel can swap application memory out of physical random access memory (RAM). For more information about kernel parameters, see the DB2 product information.
vm.overcommit_memory	The vm.overcommit_memory parameter influences how much virtual memory the kernel permits allocating. For more information about kernel parameters, see the DB2 product information.

7. Open firewall ports to communicate with the server. Complete the following steps:

- a. Determine the zone that is used by the network interface. The zone is public, by default.

Issue the following command:

```
# firewall-cmd --get-active-zones
public
  interfaces: ens4f0
```

- b. To use the default port address for communications with the server, open TCP/IP port 1500 in the Linux firewall.

Issue the following command:

```
firewall-cmd --zone=public --add-port=1500/tcp --permanent
```

If you want to use a value other than the default, you can specify a number in the range 1024 - 32767. If you open a port other than the default, you will need to specify that port when you run the configuration script.

- c. If you plan to use this system as a hub, open port 11090, which is the default port for secure (https) communications.

Issue the following command:

```
firewall-cmd --zone=public --add-port=11090/tcp --permanent
```

- d. Reload the firewall definitions for the changes to take effect.

Issue the following command:

```
firewall-cmd --reload
```

- Verify that user process resource limits, also known as *ulimits*, are set according to guidelines in Table 2. If ulimit values are not set correctly, you might experience server instability or a failure of the server to respond.

Table 2. User limits (ulimit) values

User limit type	Setting	Value	Command to query value
Maximum size of core files created	core	Unlimited	<code>ulimit -Hc</code>
Maximum size of a data segment for a process	data	Unlimited	<code>ulimit -Hd</code>
Maximum file size	fsize	Unlimited	<code>ulimit -Hf</code>
Maximum number of open files	nofile	65536	<code>ulimit -Hn</code>
Maximum amount of processor time in seconds	cpu	Unlimited	<code>ulimit -Ht</code>
Maximum number of user processes	nproc	16384	<code>ulimit -Hu</code>

If you need to modify any user limit values, follow the instructions in the documentation for your operating system.

## Installing on Windows systems

Install Microsoft Windows Server 2012 Standard Edition on the server system and prepare the system for installation and configuration of the IBM Spectrum Protect™ server.

### Procedure

- Install Microsoft Windows Server 2012 R2 Standard Edition, according to the manufacturer instructions.
- Change the Windows account control policies by completing the following steps.
  - Open the Local Security Policy editor by running `secpol.msc`.
  - Click Local Policies > Security Options and ensure that the following User Account Control policies are disabled:
    - Admin Approval Mode for the Built-in Administrator account
    - Run all administrators in Admin Approval Mode
- Configure your TCP/IP settings according to installation instructions for the operating system.
- Apply Windows updates and enable optional features by completing the following steps:
  - Apply the latest Windows 2012 R2 updates.
  - Install and enable the Windows 2012 R2 feature Microsoft .NET Framework 3.5 from the Windows Server Manager.
  - If required, update the FC and Ethernet HBA device drivers to newer levels.
  - Install the multipath I/O driver that is appropriate for the disk system that you are using.
- Open the default TCP/IP port, 1500, for communications with the IBM Spectrum Protect server. For example, issue the following command:

```
netsh advfirewall firewall add rule name="Backup server port 1500"  
dir=in action=allow protocol=TCP localport=1500
```

- On the Operations Center hub server, open the default port for secure (https) communications with the Operations Center. The port number is 11090. For example, issue the following command:

```
netsh advfirewall firewall add rule name="Operations Center port 11090"  
dir=in action=allow protocol=TCP localport=11090
```

## Configuring multipath I/O

You can enable and configure multipathing for disk storage. Use the documentation that is provided with your hardware for detailed instructions.

- AIX systems  
Complete the following steps to enable and configure multipathing for disk storage.
- Linux systems  
Complete the following steps to enable and configure multipathing for disk storage.

- Windows systems  
Complete the following steps to enable and configure multipathing for disk storage.

## AIX systems

---

Complete the following steps to enable and configure multipathing for disk storage.

### Procedure

---

1. Determine the Fibre Channel port address that you must use for the host definition on the disk subsystem. Issue the `lscfg` command for every port.

- On small and medium systems, issue the following commands:

```
lscfg -vps -l fcs0 | grep "Network Address"  
lscfg -vps -l fcs1 | grep "Network Address"
```

- On large systems, issue the following commands:

```
lscfg -vps -l fcs0 | grep "Network Address"  
lscfg -vps -l fcs1 | grep "Network Address"  
lscfg -vps -l fcs2 | grep "Network Address"  
lscfg -vps -l fcs3 | grep "Network Address"
```

2. Ensure that the following AIX® file sets are installed:

- `devices.common.IBM.mpio.rte`
- `devices.fcp.disk.array.rte`
- `devices.fcp.disk.rte`

3. Issue the `cfgmgr` command to have AIX rescan the hardware and discover available disks. For example:

```
cfgmgr
```

4. To list the available disks, issue the following command:

```
lsdev -Ccdisk
```

You should see output similar to the following:

```
hdisk0 Available 00-00-00 SAS Disk Drive  
hdisk1 Available 00-00-00 SAS Disk Drive  
hdisk2 Available 01-00-00 SAS Disk Drive  
hdisk3 Available 01-00-00 SAS Disk Drive  
hdisk4 Available 06-01-02 MPIO IBM 2076 FC Disk  
hdisk5 Available 07-01-02 MPIO IBM 2076 FC Disk  
...
```

5. Use the output from the `lsdev` command to identify and list device IDs for each disk device.

For example, a device ID could be `hdisk4`. Save the list of device IDs to use when you create file systems for the IBM Spectrum Protect™ server.

6. Correlate the SCSI device IDs to specific disk LUNs from the disk system by listing detailed information about all physical volumes in the system. Issue the following command:

```
lspv -u
```

On an IBM® Storwize® system, the following information is an example of what is shown for each device:

```
hdisk4 00f8cf083fd97327 None active  
33213600507630081010578000000000003004214503IBMfcp
```

In the example, `6005076300810105780000000000030` is the UID for the volume, as reported by the Storwize management interface.

To verify disk size in megabytes and compare the value with what is listed for the system, issue the following command:

```
bootinfo -s hdisk4
```

## Linux systems

---



Complete the following steps to enable and configure multipathing for disk storage.

## Procedure

1. Edit the `/etc/multipath.conf` file to enable multipathing for Linux hosts. If the `multipath.conf` file does not exist, you can create it by issuing the following command:

```
mpathconf --enable
```

The following parameters were set in `multipath.conf` for testing on an IBM Storwize® system:

```
defaults {
    user_friendly_names no
}

devices {
    device {
        vendor "IBM "
        product "2145"
        path_grouping_policy group_by_prio
        user_friendly_names no
        path_selector "round-robin 0"
        prio "alua"
        path_checker "tur"
        failback "immediate"
        no_path_retry 5
        rr_weight uniform
        rr_min_io_rq "1"
        dev_loss_tmo 120
    }
}
```

2. Set the multipath option to start when the system is started. Issue the following commands:

```
systemctl enable multipathd.service
systemctl start multipathd.service
```

3. To verify that disks are visible to the operating system and are managed by multipath, issue the following command:

```
multipath -l
```

4. Ensure that each device is listed and that it has as many paths as you expect. You can use size and device ID information to identify which disks are listed.

For example, the following output shows that a 2 TB disk has two path groups and four active paths. The 2 TB size confirms that the disk corresponds to a pool file system. Use part of the long device ID number (12, in this example) to search for the volume on the disk-system management interface.

```
[root@tapsrv01 code]# multipath -l
36005076802810c509800000000000012 dm-43 IBM,2145
size=2.0T features='1 queue_if_no_path' hwhandler='0' wp=rw
|+- policy='round-robin 0' prio=0 status=active
| |- 2:0:1:18 sdcw 70:64 active undef running
| `-- 4:0:0:18 sdgb 131:112 active undef running
`+- policy='round-robin 0' prio=0 status=enabled
  |- 1:0:1:18 sdat 66:208 active undef running
  `-- 3:0:0:18 sddy 128:0 active undef running
```

- a. If needed, correct disk LUN host assignments and force a bus rescan. For example:

```
echo "- - -" > /sys/class/scsi_host/host0/scan
echo "- - -" > /sys/class/scsi_host/host1/scan
echo "- - -" > /sys/class/scsi_host/host2/scan
```

You can also restart the system to rescan disk LUN host assignments.

- b. Confirm that disks are now available for multipath I/O by reissuing the `multipath -l` command.

5. Use the multipath output to identify and list device IDs for each disk device.

For example, the device ID for your 2 TB disk is `36005076802810c509800000000000012`.

Save the list of device IDs to use in the next step.

## Windows systems

---

Complete the following steps to enable and configure multipathing for disk storage.

### Procedure

---

1. Ensure that the Multipath I/O feature is installed. If needed, install additional vendor-specific multipath drivers.
2. To verify that disks are visible to the operating system and are managed by multipath I/O, issue the following command:

```
c:\program files\IBM\SDDDSM\datapath.exe query device
```

3. Review the multipath output and ensure that each device is listed and that it has as many paths as you expect. You can use size and device serial information to identify which disks are listed.

For example, by using part of the long device serial number (34, in this example) you can search for the volume on the disk-system management interface. The 2 TB size confirms that the disk corresponds to a storage pool file system.

```
DEV#: 4 DEVICE NAME: Disk5 Part0 TYPE: 2145 POLICY: OPTIMIZED
SERIAL: 60050763008101057800000000000034 LUN SIZE: 2.0TB
=====
Path# Adapter/Hard Disk State Mode Select Errors
0 Scsi Port2 Bus0/Disk5 Part0 OPEN NORMAL 0 0
1 Scsi Port2 Bus0/Disk5 Part0 OPEN NORMAL 27176 0
2 Scsi Port3 Bus0/Disk5 Part0 OPEN NORMAL 28494 0
3 Scsi Port3 Bus0/Disk5 Part0 OPEN NORMAL 0 0
```

4. Create a list of disk device IDs by using the serial numbers that are returned from the multipath output in the previous step.

For example, the device ID for your 2 TB disk is 60050763008101057800000000000034

Save the list of device IDs to use in the next step.

5. To bring new disks online and clear the read-only attribute, run diskpart.exe with the following commands. Repeat for each of the disks:

```
diskpart
select Disk 1
online disk
attribute disk clear readonly
select Disk 2
online disk
attribute disk clear readonly
< ... >
select Disk 49
online disk
attribute disk clear readonly
exit
```

## Creating the user ID for the server

---

Create the user ID that owns the IBM Spectrum Protect™ server instance. You specify this user ID when you create the server instance during initial configuration of the server.

### About this task



---

You can specify only lowercase letters (a-z), numerals (0-9), and the underscore character ( \_ ) for the user ID. The user ID and group name must comply with the following rules:

- The length must be 8 characters or fewer.
- The user ID and group name cannot start with *ibm*, *sql*, *sys*, or a numeral.
- The user ID and group name cannot be *user*, *admin*, *guest*, *public*, *local*, or any SQL reserved word.

### Procedure

---

1. Use operating system commands to create a user ID.
  - o   Create a group and user ID in the home directory of the user that owns the server instance.

For example, to create the user ID `tsminst1` in group `tsmsrvrs` with a password of `tsminst1`, issue the following commands from an administrative user ID:

#### AIX

```
mkgroup id=1001 tsmsrvrs
mkuser id=1002 pgrp=tsmsrvrs home=/home/tsminst1 tsminst1
passwd tsminst1
```

#### Linux

```
groupadd tsmsrvrs
useradd -d /home/tsminst1 -m -g tsmsrvrs -s /bin/bash tsminst1
passwd tsminst1
```

Log off, and then log in to your system. Change to the user account that you created. Use an interactive login program, such as `telnet`, so that you are prompted for the password and can change it if necessary.

- o **Windows** Create a user ID and then add the new ID to the Administrators group. For example, to create the user ID `tsminst1`, issue the following command:

```
net user tsminst1 * /add
```

After you create and verify a password for the new user, add the user ID to the Administrators group by issuing the following commands:

```
net localgroup Administrators tsminst1 /add
net localgroup DB2ADMNS tsminst1 /add
```

2. Log off the new user ID.

## Preparing file systems for the server

---

You must complete file system configuration for the disk storage to be used by the server.

- Preparing file systems on AIX systems  
You must create volume groups, logical volumes, and file systems for the server by using the AIX® Logical Volume Manager.
- Preparing file systems on Linux systems  
You must format `ext4` or `xfs` file systems on each of the disk LUNs to be used by the IBM Spectrum Protect server.
- Preparing file systems on Windows systems  
You must format New Technology File System (NTFS) file systems on each of the disk LUNs to be used by the IBM Spectrum Protect server.

## Preparing file systems on AIX systems

---

You must create volume groups, logical volumes, and file systems for the server by using the AIX® Logical Volume Manager.

### Procedure

---

1. Increase the queue depth and maximum transfer size for all of the available `hdiskX` disks. Issue the following commands for each disk:

```
chdev -l hdisk4 -a max_transfer=0x100000
chdev -l hdisk4 -a queue_depth=32
chdev -l hdisk4 -a reserve_policy=no_reserve
chdev -l hdisk4 -a algorithm=round_robin
```

Do not run these commands for operating system internal disks, for example, `hdisk0`.

2. Create volume groups for the IBM Spectrum Protect™ database, active log, archive log, database backup, and storage pool. Issue the `mkvg` command, specifying the device IDs for corresponding disks that you previously identified. For example, if the device names `hdisk4`, `hdisk5`, and `hdisk6` correspond to database disks, include them in the database volume group and so on.  
System size: The following commands are based on the medium system configuration. For small and large systems, you must adjust the syntax as required.

```
mkvg -S -y tsmdb hdisk2 hdisk3 hdisk4
mkvg -S -y tsmactlog hdisk5
```

```
mkvg -S -y tsmarchlog hdisk6
mkvg -S -y tsmdbback hdisk7 hdisk8 hdisk9 hdisk10
mkvg -S -y tsmstgpool hdisk11 hdisk12 hdisk13 hdisk14 ... hdisk49
```

- Determine the physical volume names and the number of free physical partitions to use when you create logical volumes. Issue the `lsvg` for each volume group that you created in the previous step.

For example:

```
lsvg -p tsmdb
```

The output is similar to the following. The *FREE PPs* column represents the free physical partitions:

```
tsmdb:
PV_NAME  PV STATE  TOTAL PPs  FREE PPs  FREE DISTRIBUTION
hdisk4   active    1631       1631      327..326..326..326..326
hdisk5   active    1631       1631      327..326..326..326..326
hdisk6   active    1631       1631      327..326..326..326..326
```

- Create logical volumes in each volume group by using the `mklv` command. The volume size, volume group, and device names vary, depending on the size of your system and variations in your disk configuration.

For example, to create the volumes for the IBM Spectrum Protect database on a medium system, issue the following commands:

```
mklv -y tsmdb00 -t jfs2 -u 1 -x 1631 tsmdb 1631 hdisk2
mklv -y tsmdb01 -t jfs2 -u 1 -x 1631 tsmdb 1631 hdisk3
mklv -y tsmdb02 -t jfs2 -u 1 -x 1631 tsmdb 1631 hdisk4
```

- Format file systems in each logical volume by using the `crfs` command.

For example, to format file systems for the database on a medium system, issue the following commands:

```
crfs -v jfs2 -d tsmdb00 -p rw -a logname=INLINE -a options=rbrw
-a agblksize=4096 -m /tsminst1/TSMdbspace00 -A yes
crfs -v jfs2 -d tsmdb01 -p rw -a logname=INLINE -a options=rbrw
-a agblksize=4096 -m /tsminst1/TSMdbspace01 -A yes
crfs -v jfs2 -d tsmdb02 -p rw -a logname=INLINE -a options=rbrw
-a agblksize=4096 -m /tsminst1/TSMdbspace02 -A yes
```

- Mount all of the newly created file systems by issuing the following command:

```
mount -a
```

- List all file systems by issuing the `df` command. Verify that file systems are mounted at the correct LUN and correct mount point. Also, verify the available space.

The following example of command output shows that the amount of used space is typically 1%:

```
tapsrv07> df -g /tsminst1/*
Filesystem      GB blocks  Free    %Used  Iused  %Iused  Mounted on
/dev/tsmact00   195.12    194.59  1%      4       1%      /tsminst1/TSMalog
```

- Verify that the user ID that you created in Creating the user ID for the server has read and write access to the directories for the server.

## Preparing file systems on Linux systems

You must format ext4 or xfs file systems on each of the disk LUNs to be used by the IBM Spectrum Protect™ server.

### Procedure

- Using the list of device IDs that you generated previously, issue the `mkfs` command to create and format a file system for each storage LUN device. Specify the device ID in the command. See the following examples. For the database, format ext4 file systems:

```
mkfs -t ext4 -T largefile -m 2 /dev/mapper/36005076802810c50980000000000012
```

For storage pool LUNs, format xfs file systems:

```
mkfs -t xfs /dev/mapper/3600507630081010578000000000002c3
```

You might issue the `mkfs` command as many as 50 times, depending on how many different devices you have.

2. Create mount point directories for file systems.

Issue the `mkdir` command for each directory that you must create. Use the directory values that you recorded in the planning worksheets.

For example, to create the server instance directory by using the default value, issue the following command:

```
mkdir /tsminst1
```

Repeat the `mkdir` command for each file system.

3. Add an entry in the `/etc/fstab` file for each file system so that file systems are mounted automatically when the server is started.

For example:

```
/dev/mapper/36005076802810c50980000000000012 /tsminst1/TSMdbspace00 ext4 defaults 0 0
```

4. Mount the file systems that you added to the `/etc/fstab` file by issuing the `mount -a` command.
5. List all file systems by issuing the `df` command. Verify that file systems are mounted at the correct LUN and correct mount point. Also, verify the available space.

The following example on an IBM® Storwize® system shows that the amount of used space is typically 1%:

```
[root@tapsrv04 ~]# df -h /tsminst1/*
Filesystem                                Size  Used Avail Use% Mounted on
/dev/mapper/36005076300810105780000000000003 134G  188M 132G  1%  /tsminst1/TSMalog
```

6. Verify that the user ID that you created in Creating the user ID for the server has read and write access to the directories for the IBM Spectrum Protect server.

## Preparing file systems on Windows systems

---

You must format New Technology File System (NTFS) file systems on each of the disk LUNs to be used by the IBM Spectrum Protect™ server.

### Procedure

---

1. Create mount point directories for file systems.

Issue the `md` command for each directory that you must create. Use the directory values that you recorded in the planning worksheets. For example, to create the server instance directory by using the default value, issue the following command:

```
md c:\tsminst1
```

Repeat the `md` command for each file system.

2. Create a volume for every disk LUN that is mapped to a directory under the server instance directory by using the Windows volume manager.

Go to Server Manager > File and Storage Services and complete the following steps for each disk that corresponds to the LUN mapping that was created in the previous step:

- a. Bring the disk online.
- b. Initialize the disk to the GPT basic type, which is the default.
- c. Create a simple volume that occupies all of the space on the disk. Format the file system by using NTFS, and assign a label that matches the purpose of the volume, such as `TSMfile00`. Do not assign the new volume to a drive letter. Instead, map the volume to a directory under the instance directory, such as `C:\tsminst1\TSMfile00`.

Tip: Determine the volume label and directory mapping labels based on the size of the disk that is reported.

3. Verify that file systems are mounted at the correct LUN and correct mount point. List all file systems by issuing the `mountvol` command and then review the output. For example:

```
\\?\Volume{8ffb9678-3216-474c-a021-20e420816a92}\
C:\tsminst1\TSMdbspace00\
```

4. After the disk configuration is complete, restart the system.

### What to do next

---

You can confirm the amount of free space for each volume by using Windows Explorer.

# Installing the server and Operations Center

---

Use the IBM® Installation Manager graphical wizard to install the components.

- Installing on AIX and Linux systems  
Install the IBM Spectrum Protect™ server and the Operations Center on the same system.
- Installing on Windows systems  
Install the IBM Spectrum Protect server and the Operations Center on the same system.

## Installing on AIX® and Linux systems

---

Install the IBM Spectrum Protect™ server and the Operations Center on the same system.

### Before you begin

---

Verify that the operating system is set to the language that you require. By default, the language of the operating system is the language of the installation wizard.

### Procedure

---

1. **AIX** Verify that the required RPM files are installed on your system.

See Installing prerequisite RPM files for the graphical wizard for details.

2. Before you download the installation package, verify that you have enough space to store the installation files when they are extracted from the product package. For space requirements, see the download document at technote 4042992.
3. Go to Passport Advantage® and download the package file to an empty directory of your choice.
4. Ensure that executable permission is set for the package. If necessary, change the file permissions by issuing the following command:

```
chmod a+x package_name.bin
```

5. Extract the package by issuing the following command:

```
./package_name.bin
```

where *package\_name* is the name of the downloaded file.

6. **AIX** Ensure that the following command is enabled so that the wizards work properly:

```
lsuser
```

By default, the command is enabled.

7. Change to the directory where you placed the executable file.
8. Start the installation wizard by issuing the following command:

```
./install.sh
```

When you select the packages to install, choose both the server and Operations Center.

### What to do next

---

- If errors occur during the installation process, the errors are recorded in log files that are stored in the IBM Installation Manager logs directory.  
  
To view installation log files from the Installation Manager tool, click File > View Log. To collect these log files from the Installation Manager tool, click Help > Export Data for Problem Analysis.
- After you install the server and before you customize it for your use, go to the IBM Spectrum Protect support site. Click Support and downloads and apply any applicable fixes.
- Installing prerequisite RPM files for the graphical wizard  
RPM files are required for the IBM Installation Manager graphical wizard.

# Installing on Windows systems

---

Install the IBM Spectrum Protect™ server and the Operations Center on the same system.

## Before you begin

---

Make sure that the following prerequisites are met:

- Verify that the operating system is set to the language that you require. By default, the language of the operating system is the language of the installation wizard.
- Ensure that the user ID that you plan to use during the installation is a user with local Administrator authority.

## Procedure

---

1. Before you download the installation package, verify that you have enough space to store the installation files when they are extracted from the product package. For space requirements, see the download document at technote 4042993.
2. Go to Passport Advantage® and download the package file to an empty directory of your choice.
3. Change to the directory where you placed the executable file.
4. Double-click the executable file to extract to the current directory.
5. In the directory where the installation files were extracted, start the installation wizard by double-clicking the install.bat file. When you select the packages to install, choose both the server and Operations Center.

## What to do next

---

- If errors occur during the installation process, the errors are recorded in log files that are stored in the IBM® Installation Manager logs directory.

To view installation log files from the Installation Manager tool, click File > View Log. To collect these log files from the Installation Manager tool, click Help > Export Data for Problem Analysis.

- After you install the server and before you customize it for your use, go to the IBM Spectrum Protect support site. Click Support and downloads and apply any applicable fixes.

# Configuring the server and the Operations Center

---

After you install the components, complete the configuration for the IBM Spectrum Protect™ server and the Operations Center.

- **Configuring the server instance**  
Use the IBM Spectrum Protect server instance configuration wizard to complete the initial configuration of the server.
- **Installing the backup-archive client**  
As a best practice, install the IBM Spectrum Protect backup-archive client on the server system so that the administrative command-line client and scheduler are available.
- **Setting options for the server**  
Review the server options file that is installed with the IBM Spectrum Protect server to verify that the correct values are set for your system.
- **Security concepts**  
You can protect IBM Spectrum Protect from security risks by using communication protocols, securing passwords, and providing different access levels for administrators.
- **Configuring the Operations Center**  
After you install the Operations Center, complete the following configuration steps to start managing your storage environment.
- **Registering the product license**  
To register your license for the IBM Spectrum Protect product, use the REGISTER LICENSE command.
- **Defining data retention rules for your business**  
After you create a directory-container storage pool for data deduplication, update the default server policy to use the new storage pool. The Add Storage Pool wizard opens the Services page in the Operations Center to complete this task.
- **Defining schedules for server maintenance activities**  
Create schedules for each server maintenance operation by using the DEFINE SCHEDULE command in the Operations Center command builder.
- **Defining client schedules**  
Use the Operations Center to create schedules for client operations.

## Configuring the server instance

---

Use the IBM Spectrum Protect™ server instance configuration wizard to complete the initial configuration of the server.

### Before you begin

---

Ensure that the following requirements are met:

**AIX** | **Linux**

- The system where you installed IBM Spectrum Protect must have the X Window System client. You must also be running an X Window System server on your desktop.
- The system must have the Secure Shell (SSH) protocol enabled. Ensure that the port is set to the default value, 22, and that the port is not blocked by a firewall. You must enable password authentication in the `sshd_config` file in the `/etc/ssh/directory`. Also, ensure that the SSH daemon service has access rights to connect to the system by using the `localhost` value.
- You must be able to log in to IBM Spectrum Protect with the user ID that you created for the server instance, by using the SSH protocol. When you use the wizard, you must provide this user ID and password to access that system.
- If you changed any settings in the preceding steps, restart the server before you proceed with the configuration wizard.

**Windows** Verify that the remote registry service is started by completing the following steps:

1. Click Start > Administrative Tools > Services. In the Services window, select Remote Registry. If it is not started, click Start.
2. Ensure that port 137, 139, and 445 are not blocked by a firewall:
  - a. Click Start > Control Panel > Windows Firewall.
  - b. Select Advanced Settings.
  - c. Select Inbound Rules.
  - d. Select New Rule.
  - e. Create a port rule for TCP ports 137, 139, and 445 to allow connections for domain and private networks.
3. Configure the user account control by accessing the local security policy options and completing the following steps.
  - a. Click Start > Administrative Tools > Local Security Policy. Expand Local Policies > Security Options.
  - b. If not already enabled, enable the built-in administrator account by selecting Accounts: Administrator account status > Enable > OK.
  - c. If not already disabled, disable user account control for all Windows administrators by selecting User Account Control: Run all administrators in Admin Approval Mode > Disable > OK.
  - d. If not already disabled, disable the User Account Control for the built-in Administrator account by selecting User Account Control: Admin Approval Mode for the Built-in Administrator Account > Disable > OK.
4. If you changed any settings in the preceding steps, restart the server before you proceed with the configuration wizard.

### About this task

---

The wizard can be stopped and restarted, but the server is not operational until the entire configuration process is complete.

### Procedure

---

1. Start the local version of the wizard.
  - o **AIX** | **Linux** Open the `dsmicfgx` program in the `/opt/tivoli/tsm/server/bin` directory. This wizard can be only run as a root user.
  - o **Windows** Click Start > All Programs > IBM Spectrum Protect > Configuration Wizard.
2. Follow the instructions to complete the configuration. Use the information that you recorded in Planning worksheets during IBM Spectrum Protect system setup to specify directories and options in the wizard.

**AIX** | **Linux** On the Server Information window, set the server to start automatically by using the instance user ID when the system boots.

**Windows** By using the configuration wizard, the server is set to start automatically when rebooted.

## Installing the backup-archive client

---

As a best practice, install the IBM Spectrum Protect™ backup-archive client on the server system so that the administrative command-line client and scheduler are available.



## Procedure

To install the backup-archive client, follow the installation instructions for your operating system.

- Installing the UNIX and Linux backup-archive clients
- Installing the Windows backup-archive client

## Setting options for the server

Review the server options file that is installed with the IBM Spectrum Protect™ server to verify that the correct values are set for your system.

## Procedure

1. Go to the server instance directory and open the dsmserv.opt file.
2. Review the values in the following table and verify your server option settings, based on system size.

Server option	Value
ACTIVELOGDIRECTORY	Directory path that was specified during configuration
ACTIVELOGSIZE	131072
ARCHLOGCOMPRESS	No
ARCHLOGDIRECTORY	Directory path that was specified during configuration
COMMMETHOD	TCPIP
COMMTIMEOUT	3600
DEVCONFIG	devconf.dat
EXPINTERVAL	0
IDLETIMEOUT	60
MAXSESSIONS	500
NUMOPENVOLSALLOWED	20
TCPADMINPORT	1500
TCPPORT	1500
VOLUMEHISTORY	volhist.dat

Update server option settings if necessary, to match the values in the table. To make updates, close the dsmserv.opt file and use the SETOPT command from the administrative command-line interface to set the options.

For example, to update the IDLETIMEOUT option to 60, issue the following command:

```
setopt idletimeout 60
```

3. To configure secure communications for the server, clients, and the Operations Center, verify the options in the following table.

Server option	All system sizes
SSLDISABLELEGACYTLS	YES
SSLFIPSMODE	NO
SSLTCPPORT	Specify the SSL port number. The server TCP/IP communication driver waits for requests on this port for SSL-enabled sessions from the client.
SSLTCPADMINPORT	Specify the port address on which the server waits for requests for SSL-enabled sessions from the command-line administrative client.
SSLTLS12	YES

If any of the option values must be updated, edit the dsmserv.opt file by using the following guidelines:

- Remove the asterisk at the beginning of a line to enable an option.

- On each line, enter only one option and the specified value for the option.
  - If an option occurs in multiple entries in the file, the server uses the last entry.
- Save your changes and close the file. If you edit the dsmserv.opt file directly, you must restart the server for the changes to take effect.

## Security concepts

---

You can protect IBM Spectrum Protect™ from security risks by using communication protocols, securing passwords, and providing different access levels for administrators.

### Transport Layer Security

---

You can use the Secure Sockets Layer (SSL) or the Transport Layer Security (TLS) protocol to provide transport layer security for a secure connection between servers, clients, and storage agents. If you send data between the server, client, and storage agent, use SSL or TLS to encrypt the data.

Tip: Any IBM Spectrum Protect documentation that indicates "SSL" or to "select SSL" applies to TLS.

SSL is provided by the Global Security Kit (GSKit) that is installed with the IBM Spectrum Protect server that the server, client, and storage agent use.

Restriction: Do not use the SSL or TLS protocols for communications with a DB2® database instance that is used by any IBM Spectrum Protect servers.

Each server, client, or storage agent that enables SSL must use a trusted self-signed certificate or obtain a unique certificate that is signed by a certificate authority (CA). You can use your own certificates or purchase certificates from a CA. Either certificate must be installed and added to the key database on the IBM Spectrum Protect server, client, or storage agent. The certificate is verified by the SSL client or server that requests or initiates the SSL communication. Some CA certificates are preinstalled in the key databases, by default.

SSL is set up independently on the IBM Spectrum Protect server, client, and storage agent.

### Authority levels

---

With each IBM Spectrum Protect server, different administrative authority levels are available that determine the tasks that an administrator can complete.

After registration, an administrator must be granted authority by being assigned one or more administrative authority levels. An administrator with system authority can complete any task with the server and assign authority levels to other administrators by using the GRANT AUTHORITY command. Administrators with policy, storage, or operator authority can complete subsets of tasks.

An administrator can register other administrator IDs, grant levels of authority to them, rename IDs, remove IDs, and lock and unlock them from the server.

An administrator can control access to specific client nodes for root user IDs and non-root user IDs. By default, a non-root user ID cannot back up data on the node. Use the UPDATE NODE command to change the node settings to enable backup.

### Passwords

---

By default, the server automatically uses password authentication. With password authentication, all users must enter a password when they access the server.

Use Lightweight Directory Access Protocol (LDAP) to apply stricter requirements for passwords. For more information, see [Managing passwords and logon procedures \(V7.1.1\)](#).

Table 1. Password authentication characteristics

Characteristic	More information
Case-sensitivity	Not case-sensitive.

Characteristic	More information
Default password expiration	90 days.  The expiration period begins when an administrator ID or client node is first registered to the server. If the password is not changed within this period, the password must be changed the next time that the user accesses the server.
Invalid password attempts	You can set a limit on consecutive invalid password attempts for all client nodes. When the limit is exceeded, the server locks the node.
Password length	The administrator can specify a minimum length.

## Session security

Session security is the level of security that is used for communication among IBM Spectrum Protect client nodes, administrative clients, and servers and is set by using the SESSIONSECURITY parameter.

The SESSIONSECURITY parameter can be set to one of the following values:

- The STRICT value enforces the highest level of security for communication between IBM Spectrum Protect servers, nodes, and administrators.
- The TRANSITIONAL value specifies that the existing communication protocol is used while you update your IBM Spectrum Protect software to V8.1.2 or later. This is the default. When SESSIONSECURITY=TRANSITIONAL, stricter security settings are automatically enforced as higher versions of the TLS protocol are used and as the software is updated to V8.1.2 or later. After a node, administrator, or server meets the requirements for the STRICT value, session security is automatically updated to the STRICT value, and the entity can no longer authenticate by using a previous version of the client or earlier TLS protocols.

For more information about the SESSIONSECURITY parameter values, see the following commands.

Table 2. Commands used to set the SESSIONSECURITY parameter

Entity	Command
Client nodes	<ul style="list-style-type: none"> <li>• REGISTER NODE</li> <li>• UPDATE NODE</li> </ul>
Administrators	<ul style="list-style-type: none"> <li>• REGISTER ADMIN</li> <li>• UPDATE ADMIN</li> </ul>
Servers	<ul style="list-style-type: none"> <li>• DEFINE SERVER</li> <li>• UPDATE SERVER</li> </ul>

Administrators that authenticate by using the DSMADMC command, DSMC command, or dsm program cannot authenticate by using an earlier version after authenticating by using V8.1.2 or later. To resolve authentication issues for administrators, see the following tips:

Tips:

- Ensure that all IBM Spectrum Protect software that the administrator account uses to log on is upgraded to V8.1.2 or later. If an administrator account logs on from multiple systems, ensure that the server's certificate is installed on each system.
- After an administrator authenticates to a V8.1.2 or later server by using a V8.1.2 or later client, the administrator can authenticate only on clients or servers that are using V8.1.2 or later. An administrator command can be issued from any system.
- If necessary, create a separate administrator account to use only with clients and servers that are using V8.1.1 or earlier software.

Enforce the highest level of security for communication with the IBM Spectrum Protect server by ensuring that all nodes, administrators, and servers use STRICT session security. You can use the SELECT command to determine which servers, nodes, and administrators are using TRANSITIONAL session security and should be updated to use STRICT session security.

- **Configuring secure communications with Transport Layer Security**  
To encrypt data and secure communications in your environment, Secure Sockets Layer (SSL) or Transport Layer Security

(TLS) is enabled on the IBM Spectrum Protect server and backup-archive client. An SSL certificate is used to verify communication requests between the server and client.

**Related tasks:**

[↗ Securing communications](#)

## Configuring the Operations Center

---

After you install the Operations Center, complete the following configuration steps to start managing your storage environment.

### Before you begin

---

When you connect to the Operations Center for the first time, you must provide the following information:

- Connection information for the server that you want to designate as a hub server
- Login credentials for an administrator ID that is defined for that server

### Procedure

---

1. Designate the hub server. In a web browser, enter the following address:

```
https://hostname:secure_port/oc
```

where:

- *hostname* represents the name of the computer where the Operations Center is installed
- *secure\_port* represents the port number that the Operations Center uses for HTTPS communication on that computer

For example, if your host name is `tsm.storage.mylocation.com` and you are using the default secure port for the Operations Center, which is `11090`, the address is:

```
https://tsm.storage.mylocation.com:11090/oc
```

When you log in to the Operations Center for the first time, a wizard guides you through an initial configuration to set up a new administrator with system authority on the server.

2. Set up secure communications between the Operations Center and the hub server by configuring the Secure Sockets Layer (SSL) protocol.

Follow the instructions in [Securing communications between the Operations Center and the hub server](#).

3. Optional: To receive a daily email report that summarizes system status, configure your email settings in the Operations Center.

Follow the instructions in [Tracking system status by using email reports](#).

- Securing communications between the Operations Center and the hub server  
To secure communications between the Operations Center and the hub server, add the Transport Layer Security (TLS) certificate of the hub server to the truststore file of the Operations Center.

## Registering the product license

---

To register your license for the IBM Spectrum Protect™ product, use the `REGISTER LICENSE` command.

### About this task

---

Licenses are stored in enrollment certificate files, which contain licensing information for the product. The enrollment certificate files are on the installation media, and are placed on the server during installation. When you register the product, the licenses are stored in a `NODELOCK` file within the current directory.

### Procedure

---

Register a license by specifying the name of the enrollment certificate file that contains the license. To use the Operations Center command builder for this task, complete the following steps.

1. Open the Operations Center.
2. Open the Operations Center command builder by hovering over the settings icon  and clicking Command Builder.
3. Issue the REGISTER LICENSE command. For example, to register a base IBM Spectrum Protect license, issue the following command:

```
register license file=tsmbasic.lic
```

## What to do next

---

Save the installation media that contains your enrollment certificate files. You might need to register your license again if, for example, one of the following conditions occur:

- The server is moved to a different computer.
- The NODELOCK file is corrupted. The server stores license information in the NODELOCK file, which is in the directory from which the server is started.
-  If you change the processor chip that is associated with the server on which the server is installed.

## Defining data retention rules for your business

---

After you create a directory-container storage pool for data deduplication, update the default server policy to use the new storage pool. The Add Storage Pool wizard opens the Services page in the Operations Center to complete this task.

### Procedure

---

1. On the Services page of the Operations Center, select the STANDARD domain and click Details.
2. On the Summary page for the policy domain, click the Policy Sets tab. The Policy Sets page indicates the name of the active policy set and lists all of the management classes for that policy set.
3. Click the Configure toggle, and make the following changes:
  - Change the backup destination for the STANDARD management class to the directory-container storage pool.
  - Change the value for the Backups column to No limit.
  - Change the retention period. Set the Keep Extra Backups column to 30 days or more, depending on your business requirements.
4. Save your changes and click the Configure toggle again so that the policy set is no longer editable.
5. Activate the policy set by clicking Activate.

## Defining schedules for server maintenance activities

---

Create schedules for each server maintenance operation by using the DEFINE SCHEDULE command in the Operations Center command builder.

### About this task

---

Schedule server maintenance operations to run after client backup operations. You can control the timing of schedules by setting the start time in combination with the duration time for each operation.

The following figure provides an example of how to plan maintenance operations.  
Figure 1. Daily schedule of server operations for a tape solution

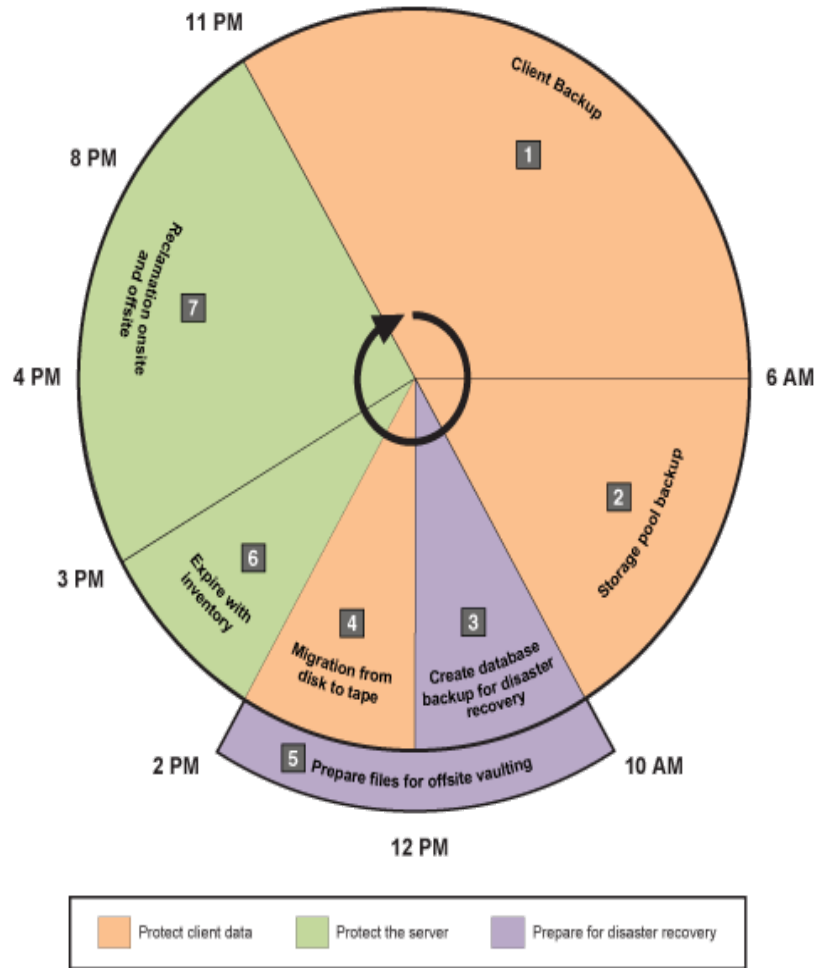

The following table shows how you can schedule server maintenance processes in combination with the client backup schedule for a tape solution.

Operation	Schedule
Client backup	Starts at 11 PM.
Storage pool backup	Starts at 6 AM.
Processing for database and disaster recovery files	<ul style="list-style-type: none"> <li>The database backup operation starts at 10 AM, or 11 hours after the beginning of the client backup operation. This process runs until completion.</li> <li>Device configuration information and volume history backup operations start at 5 PM, or 7 hours after the start of the database backup operation.</li> <li>Volume history deletion starts at 8 PM, or 10 hours after the start of the database backup operation.</li> </ul>
Preparation of files for offsite vaulting	Starts at 10 AM, at the same time as processing for the database and disaster recovery files.
Migration from disk to tape	Starts at 12 PM, or 2 hours after the start of the database backup operation.
Inventory expiration	Starts at 2 PM, or 15 hours after the beginning of the client backup operation. This process runs until completion.
Space reclamation	Starts at 3 PM, or 16 hours after the beginning of the client backup operation.

## Procedure

After you configure the device class for the database backup operations, create schedules for database backup and other required maintenance operations by using the DEFINE SCHEDULE command. Depending on the size of your environment, you might need to adjust the start times for each schedule in the example.

1. Define a device class for the backup operation before you create the schedule for database backups. Use the DEFINE DEVCLASS command to create a device class that is named LTOTAPE:

```
define devclass ltotape devtype=lto library=ltolib
```

2. Set the device class for automatic database backups. Use the SET DBRECOVERY command to specify the device class that you created for the database backup in the preceding step. For example, if the device class is LTOTAPE, issue the following command:

```
set dbrecovery ltotape
```

3. Create schedules for the maintenance operations by using the DEFINE SCHEDULE command. See the following table for the required operations with examples of the commands.

Operation	Example commands and additional information
Back up storage pools.	<p>Create a schedule to run the BACKUP STGPOOL command. For example, issue the following command to create a backup schedule for a primary storage pool that is named PRIMARY_POOL. The pool will be backed up to a copy storage pool, COPYSTG:</p> <pre>define schedule BACKUPSTGPOOL type=administrative cmd="backup stgpool primary_pool copystg" active=yes starttime=06:00 period=1</pre>
Back up the database.	<p>Create a schedule to run the BACKUP DB command. For example, issue the following command to create a backup schedule that uses the new device class:</p> <pre>define schedule DBBACKUP type=admin cmd="backup db devclass=ltotape type=full numstreams=3 wait=yes compress=yes" active=yes desc="Back up the database." startdate=today starttime=10:00:00 duration=45 durunits=minutes</pre>
Replicate nodes.	<p>Optionally, use node replication to protect client data by backing the data up to a secondary server. For instructions, see Replicating client data to another server. Ensure that node replication is completed before migration operations begin.</p>

Operation	Example commands and additional information
Migrate data from disk to tape daily.	<p>Create a schedule for storage pool migration.</p> <p>For example, if a disk storage pool is named DISKPOOL and the next storage pool is TAPEPOOL, you can schedule storage pool migration by issuing the following command:</p> <pre>define schedule stgpool_migration type=administrative cmd="migrate stgpool diskpool lomig=0" active=yes description="migrate disk storagepool to tapepool" startdate=today starttime=12:00 duration=2 durunits=hours period=1 perunits=days</pre> <p>To maximize throughput, you can specify the number of parallel processes to use for migrating files by completing the following steps:</p> <ol style="list-style-type: none"> <li>For the tape storage pool, ensure that collocation is enabled. To verify whether collocation is enabled, run the QUERY STGPOOL command. Verify that a value of GROUP, NODE, or FILESPACE is specified in the COLLOCATE field. If a value of GROUP, NODE, or FILESPACE is not specified, use the UPDATE STGPOOL command to specify COLLOCATE=GROUP, COLLOCATE=NODE, or COLLOCATE=FILESPACE, depending on your system configuration.</li> <li>For the disk storage pool, use the DEFINE STGPOOL or UPDATE STGPOOL command to specify a value for the MIGPROCESS parameter. For example, if you have 12 tape drives, specify MIGPROCESS=10. In this way, a maximum of 10 tape drives are used for migration processes. Two drives are reserved for other tasks, such as restore, database backup, and client backup operations.</li> </ol>
Prepare files for offsite vaulting.	<ol style="list-style-type: none"> <li>Move tape volumes offsite by following the instructions in Moving backup media.</li> <li>Create the disaster recovery plan file by issuing the PREPARE command on the source server: <pre>prepare</pre> </li> <li>Ensure that all volumes that are required for disaster recovery are included in the recovery plan file. For more information, see Preparing for and recovering from a disaster by using DRM.</li> </ol>
Back up the device configuration information.	<p>Create a schedule to run the BACKUP DEVCONFIG command:</p> <pre>define schedule DEVCONFIGBKUP type=admin cmd="backup devconfig filenames=devconfig.dat" active=yes desc="Backup the device configuration file." startdate=today starttime=17:00:00 duration=45 durunits=minutes</pre>
Back up the volume history.	<p>Create a schedule to run the BACKUP VOLHISTORY command:</p> <pre>define schedule VOLHISTBKUP type=admin cmd="backup volhistory filenames=volhist.dat" active=yes desc="Back up the volume history." startdate=today starttime=17:00:00 duration=45 durunits=minutes</pre>



Operation	Example commands and additional information
Remove older versions of database backups that are no longer required.	<p>Create a schedule to run the DELETE VOLHISTORY command:</p> <pre>define schedule DELVOLHIST type=admin cmd="delete volhistory   type=dbb todate=today-6 totime=now" active=yes desc="Remove   old database backups." startdate=today starttime=20:00:00 duration=45 durunits=minutes</pre>
Remove objects that exceed their allowed retention.	<p>Create a schedule to run the EXPIRE INVENTORY command.</p> <p>Set the RESOURCE parameter based on the system size that you are configuring to be equal to the number of processor cores that you specified for your system.</p> <p>For example, issue the following command to create a schedule that is named EXPINVENTORY:</p> <pre>define schedule EXPINVENTORY type=admin cmd="expire inventory   wait=yes resource=8 duration=120" active=yes desc="Remove expired   objects." startdate=today starttime=14:00:00 duration=1 durunits=hours</pre>
Reclaim space.	<p>Create a schedule to run the RECLAIM STGPOOL command.</p> <p>For example, issue the following command to create a schedule that is named RECLAIM:</p> <pre>define schedule RECLAIM type=admin cmd="reclaim stgpool tapepool duration=60" startdate=today starttime=15:00:00 duration=5 durunits=hours</pre> <p>Tip: To maximize throughput, you can specify the number of parallel processes to use for reclaiming space. Update the tape storage pool by using the UPDATE STGPOOL command and specify a value for the RECLAIMPROCESS parameter. For example, if you have 12 tape drives, specify RECLAIMPROCESS=5. Because two drives are used for each reclamation process, the total number of drives that can be used for reclamation is 10. Two drives are reserved for backup operations.</p>

## What to do next

After you create schedules for the server maintenance tasks, you can view them in the Operations Center by completing the following steps:

1. On the Operations Center menu bar, hover over Servers.
  2. Click Maintenance.
- Moving backup media  
To recover from a disaster, you need database backup volumes, copy storage pool volumes, and additional files. To stay prepared for a disaster, you must complete daily tasks.

### Related reference:

- [UPDATE STGPOOL \(Update a storage pool\)](#)
- [DEFINE SCHEDULE \(Define a schedule for an administrative command\)](#)
- [DEFINE STGPOOL \(Define a volume in a storage pool\)](#)

## Defining client schedules

Use the Operations Center to create schedules for client operations.

## Procedure

---

1. On the Operations Center menu bar, hover over Clients.
2. Click Schedules.
3. Click +Schedule.
4. Complete the steps in the Create Schedule wizard. Set client backup schedules to start at 22:00, based on the server maintenance activities that you scheduled in Defining schedules for server maintenance activities.

## Attaching tape devices for the server

---

Before the server can use a tape device, you must attach the device to your server system and install the appropriate tape device driver.

### About this task

---

To optimize system performance, use fast, high-capacity tape devices. Provision enough tape drives to meet your business requirements.

Attach tape devices on their own host bus adapter (HBA), not shared with other devices types such as disk. IBM® tape drives have some special requirements for HBAs and associated drivers.

- **AIX** | **Linux** Attaching an automated library device to your system  
You can attach an automated library device to your system to store your data on tapes.
- Selecting a tape device driver  
To use tape devices with IBM Spectrum Protect™ you must install the appropriate tape device driver.
- **AIX** | **Linux** Special file names for tape devices  
A special file name for a tape device is required for the IBM Spectrum Protect server to work with tape, medium changer, or removable media devices.
- Installing and configuring tape device drivers  
Before you can use tape devices with IBM Spectrum Protect, you must install the correct tape device driver.

## Attaching an automated library device to your system

---

You can attach an automated library device to your system to store your data on tapes.

### About this task

---

Before you attach an automated library device, consider the following restrictions:

- Attached devices must be on their own Host Bus Adapter (HBA).
- An HBA must not be shared with other device types, such as a disk.
- For multiport Fibre Channel HBAs, devices must be attached on their own port. These ports must not be shared with other device types.
- IBM® tape drives have some special requirements on HBA and associated drivers. For more information about devices, see the website for your operating system:
  - IBM Spectrum Protect™ Supported Devices for AIX®
  - IBM Spectrum Protect Supported Devices for Linux and Windows

## Procedure

---

To use the Fibre Channel (FC) adapter, complete the following steps:

1. Install the FC adapter and associated drivers.
  2. Install the appropriate device drivers for attached medium changer devices.
- **AIX** | **Linux** Setting the library mode  
For the IBM Spectrum Protect server to access a SCSI library, the tape device must be set for the appropriate mode.

#### Related concepts:

Selecting a tape device driver

## Selecting a tape device driver

---

To use tape devices with IBM Spectrum Protect™ you must install the appropriate tape device driver.

- IBM tape device drivers  
IBM® tape device drivers are available for most IBM labeled tape devices.
- IBM Spectrum Protect tape device drivers  
The IBM Spectrum Protect server provides tape device drivers.

### Related reference:

Installing and configuring tape device drivers

## IBM tape device drivers

---

IBM® tape device drivers are available for most IBM labeled tape devices.

You can download IBM tape device drivers from the Fix Central website:

1. Go to the Fix Central website: [Fix Central website](#).
2. Click Select product.
3. Select System Storage for the Product Group menu.
4. Select Tape systems for the System Storage menu.
5. Select Tape drivers and software for the Tape systems menu.
6. Select Tape device drivers for the Tape drivers and software menu. In addition to tape drivers, you also get access to tools such as the IBM Tape Diagnostic Tool (ITDT).
7. Select your operating system for the Platform menu.

AIX | Windows

For the most up-to-date list of devices and operating-system levels that are supported by IBM tape device drivers, see the IBM Spectrum Protect™ Supported Devices website at [Supported devices for AIX and Windows](#).

Linux

For the most up-to-date list of tape devices and operating-system levels that are supported by IBM tape device drivers, see the IBM Spectrum Protect Supported Devices website at [Supported devices for Linux](#).

IBM tape device drivers support only some Linux kernel levels. For information about supported kernel levels, see the Fix Central website.

## IBM Spectrum Protect tape device drivers

---

The IBM Spectrum Protect™ server provides tape device drivers.

An IBM Spectrum Protect tape device driver is installed with the server.

AIX

You can use the generic SCSI tape device driver that is provided by the IBM® AIX® operating system to work with tape devices that are not supported by the IBM Spectrum Protect device driver. If the AIX generic SCSI tape device driver is used, the GENERICTAPE device class must be set to the device type that is specified in the DEFINE DEVCLASS command.

For the following tape devices, you can choose whether to install the IBM Spectrum Protect tape device driver or the native device driver for your operating system:

- ECART
- LTO (not from IBM)

All SCSI-attached libraries that contain tape drives from the list must use the IBM Spectrum Protect changer driver.

Tape device drivers that are acquired from other hardware vendors can be used if they are associated with the GENERICTAPE device class. Generic device drivers are not supported in write-one read-many (WORM) device classes.

Linux

You can use the IBM Spectrum Protect Passthru device driver. IBM Spectrum Protect Passthru device drivers require the Linux SCSI generic (sg) device driver along with the Linux operating system to install the kernels.

For example, you can install the IBM Spectrum Protect Passthru device driver for the following tape devices:

- ECART
- LTO (not from IBM)

All SCSI-attached libraries that contain tape drives that are not IBM labeled from the list must also use the IBM Spectrum Protect Passthru device driver.

You cannot use the generic SCSI tape (st) device driver that is provided by the Linux operating system. Therefore, the GENERICTAPE device type is not supported for the DEFINE DEVCLASS command.

**Windows** You can select a Windows Hardware Qualification Lab certified native device driver instead of the IBM Spectrum Protect device driver. The Windows Hardware Qualification Lab certified native device driver can be used only for devices that have a non-IBM label and for non-IBM tape drives. For the Windows Hardware Qualification Lab certified native device driver, you can select either the IBM Spectrum Protect SCSI passthru device driver or the Windows native tape device driver. If the SCSI passthru device driver is used, the device class on the DEFINE DEVCLASS command cannot be GENERICTAPE. If the native device driver is used, the device class must be GENERICTAPE.

## Special file names for tape devices

A special file name for a tape device is required for the IBM Spectrum Protect™ server to work with tape, medium changer, or removable media devices.

**AIX** When a device is configured successfully, a logical file name is returned. Table 1 specifies the name of the device, also called a special file name, that corresponds to the drive or library. You can use the SMIT operating system command to get the device special file name. In the examples, *x* specifies an integer, 0 or greater.

Table 1. Device examples

Device	Device example	Logical file name
Tape drives that can be used by the IBM Spectrum Protect device driver	/dev/mtx	mtx
Tape drives that can be used by the IBM tape device driver	/dev/rmtx	rmtx
Tape drives that can be used by the IBM AIX® generic tape device driver	/dev/rmtx	rmtx
Library devices that can be used by the IBM Spectrum Protect device driver	/dev/lbx	lbx
Library devices that can be used by the IBM tape device driver	/dev/smcx	smcx

**Linux** When a device is configured successfully, a logical file name is returned. Table 2 specifies the name of the device, also called the special file name, that corresponds to the drive or library. In the examples, *x* specifies an integer, 0 or greater.

Table 2. Device examples

Device	Device example	Logical file name
Tape drives that can be used by the IBM Spectrum Protect passthru device driver	/devtmscsi/mtx	mtx
Tape drives that can be used by the IBM lin_tape device driver	/devIBMtapex	IBMtapex
Library devices that can be used by the IBM Spectrum Protect passthru device driver	/devtmscsi/lbx	lbx
Library devices that can be used by the IBM lin_tape device driver	/devIBMchangerx	IBMchangerx

**Windows** When a device is configured successfully, a logical file name is returned. Table 3 specifies the name of the device, also called the special file name, that corresponds to the drive or library. In the examples, *a*, *b*, *c*, *d*, and *x* specify an integer, 0 or greater, where:

- *a* specifies the target ID.
- *b* specifies the LUN.
- *c* specifies the SCSI bus ID.
- *d* specifies the port ID.

Table 3. Device examples

Device	Device example	Converted device name
Tape drives that are supported by the IBM Spectrum Protect device driver	mta.b.c.d	mta.b.c.d
Tape drives that are supported by the IBM Spectrum Protect passthru device driver	mta.b.c.d	mta.b.c.d
Tape drives that are supported by the IBM device driver	Tapex	mta.b.c.d
Library devices that are supported by the IBM Spectrum Protect device driver	lb.a.b.c.d	lba.b.c.d
Library devices that are supported by the IBM Spectrum Protect passthru device driver	lba.b.c.d	lba.b.c.d
Library devices that are supported by the IBM device driver	Changerx	lba.b.c.d

## Installing and configuring tape device drivers

Before you can use tape devices with IBM Spectrum Protect™, you must install the correct tape device driver.

IBM Spectrum Protect supports all devices that are supported by IBM® tape device drivers. However, IBM Spectrum Protect does not support all the operating-system levels that are supported by IBM tape device drivers.

- Installing and configuring IBM device drivers for IBM tape devices  
Install and configure an IBM tape device driver to use an IBM tape device.
- **AIX** Configuring tape device drivers on AIX systems  
Review the instructions to install and configure non-IBM tape device drivers on AIX® systems.
- **Linux** Configuring tape device drivers on Linux systems  
Review the following topics when you install and configure tape device drivers on Linux systems.
- **Windows** Configuring tape device drivers on Windows systems  
Review the instructions to install and configure drivers for tape devices and libraries on Windows systems.

## Installing and configuring IBM device drivers for IBM tape devices

Install and configure an IBM® tape device driver to use an IBM tape device.

### About this task

For instructions about installing and configuring IBM tape device drivers, see the *IBM Tape Device Drivers Installation and User's Guide*.

**AIX** After you complete the installation procedure in the *IBM Tape Device Drivers Installation and User's Guide*, different messages are issued, depending on the device driver that you are installing. If you are installing the device driver for an IBM tape drive or library, the following messages are returned:

```
rmtx Available
```

or

```
smcx Available
```

Note the value of x, which is assigned by the IBM tape device driver. To determine the special file name of your device, issue one of the following commands:

- For tape drives, `ls -l /dev/rmt*`
- For tape libraries, `ls -l /dev/smc*`

The file name might have more characters at the end to indicate different operating characteristics, but these characters are not needed by IBM Spectrum Protect™. For IBM device drivers, use the base file name in the DEVICE parameter of the DEFINE PATH command to assign a device to a drive (/dev/rmtx) or a library (/dev/smcx).

After you install the device driver, you can use the System Management Interface Tool (SMIT) to configure non-IBM tape drives and tape libraries. Complete the following steps:

1. Run the SMIT program.
2. Click Devices.

3. Click IBM Spectrum Protect Devices.
4. Click Fibre Channel SAN Attached devices.
5. Click Discover Devices Supported by IBM Spectrum Protect. Wait for the discovery process to be completed.
6. Go back to the Fibre Channel SAN Attached devices menu, and click List Attributes of a Discovered Device.

**Linux** After you complete the installation procedure in the *IBM Tape Device Drivers Installation and User's Guide*, different messages are issued, depending on the device driver that you are installing. If you are installing the device driver for an IBM LTO or 3592 device, the following messages are returned:

```
IBMtapex Available
```

or

```
IBMChangerx Available
```

Note the value of x, which is assigned by the IBM tape device driver. To determine the special file name of your device, issue one of the following commands:

- For tape drives, `ls -l /dev/IBMtape*`
- For tape libraries, `ls -l /dev/IBMChange*`

The file name might have more characters at the end to indicate different operating characteristics, but these characters are not needed by IBM Spectrum Protect. For IBM device drivers, use the base file name in the DEVICE parameter of the DEFINE PATH command to assign a device to a drive (/dev/IBMtapex) or a library (/dev/IBMChangerx).

Restriction: The device type of this class must not be GENERICTAPE.

**Windows** For Windows operating systems, IBM Spectrum Protect provides two device drivers:

Passthru device driver

If the tape device manufacturer provides a SCSI device driver, install the IBM Spectrum Protect passthru device driver.

SCSI device driver for tape devices

If the tape device manufacturer does not provide a SCSI device driver, install the IBM Spectrum Protect SCSI device driver for tape devices. The driver file name is tsm SCSI64.sys.

For instructions about installing and configuring IBM tape device drivers, see the *IBM Tape Device Drivers Installation and User's Guide*. After you install the IBM tape device driver, the server specifies a special file name, TapeX, for IBM tape drives, or ChangerY, for IBM medium changers. For an IBM Spectrum Protect SCSI device driver or an IBM Spectrum Protect passthru device driver, you can issue the Windows operating system command, regedit, to verify the device special file name and driver. The IBM Spectrum Protect server also provides a utility to check the device for the Windows operating system. The utility, tsm dlst, is packaged with the server package. To use the utility, complete the following steps:

1. Ensure that the host bus adapter application programming interface (API) is installed.
2. To obtain device information from the host system, type:

```
tsmdlst
```

- **AIX Linux** Multipath I/O access with IBM tape devices  
Multipath I/O is a technique that uses different paths to access the same physical device, for example through multiple host bus adapters (HBA) or switches. The use of the multipath technique helps to ensure that a single point of failure does not occur.

**Related concepts:**

Multipath I/O access with IBM tape devices

**AIX**

## Configuring tape device drivers on AIX systems

Review the instructions to install and configure non-IBM® tape device drivers on AIX® systems.

### About this task

For instructions about installing and configuring IBM tape device drivers, see the *IBM Tape Device Drivers Installation and User's Guide*.

- **AIX** SCSI and Fibre Channel devices  
The IBM Spectrum Protect device definition menus and prompts in SMIT allow for the management of both SCSI and Fibre

Channel (FC) attached devices.

- **AIX** Configuring IBM Spectrum Protect device drivers for autochangers  
Use the following procedure to configure IBM Spectrum Protect device drivers for autochangers for non-IBM libraries.
- **AIX** Configuring IBM Spectrum Protect device drivers for tape drives  
Use the following procedure to configure IBM Spectrum Protect device drivers for autochangers for vendor-acquired libraries.
- **AIX** Configuring Fibre Channel SAN-attached devices  
To configure a Fibre Channel SAN-attached device, complete the procedure.

**AIX**

## SCSI and Fibre Channel devices

---

The IBM Spectrum Protect™ device definition menus and prompts in SMIT allow for the management of both SCSI and Fibre Channel (FC) attached devices.

The main menu for IBM Spectrum Protect has two options:

SCSI attached devices

Use this option to configure SCSI devices that are connected to a SCSI adapter in the host.

Fibre channel system area network (SAN) attached devices

Use this option to configure devices that are connected to an FC adapter in the host. Choose one of the following attributes:

List attributes of a discovered device

Lists attributes of a device that is known to the current ODM database.

- FC Port ID:

The 24-bit FC Port ID(N(L)\_Port or F(L)\_Port). This is the address identifier that is unique within the associated topology where the device is connected. In the switch or fabric environments, it can be determined by the switch, with the upper 2 bytes, which are not zero. In a Private Arbitrated Loop, it is the Arbitrated Loop Physical Address(AL\_PA), with the upper 2 bytes being zero. Consult with your FC vendors to find out how an AL\_PA or a Port ID is assigned.

- Mapped LUN ID:

An FC to SCSI bridge (also, called a converter, router, or gateway) box. Consult with your bridge vendors about how LUNs are mapped. You should not change LUN Mapped IDs.

- WW Name:

The worldwide name of the port to which the device is attached. It is the 64-bit unique identifier that is assigned by vendors of FC components such as bridges or native FC devices. Consult with your FC vendors to find out the WWN of a port.

- Product ID:

The product ID of a device. Consult with your device vendors to determine the product ID.

Discover devices supported by IBM Spectrum Protect

This option discovers devices on an FC SAN that are supported by IBM Spectrum Protect and makes them available. If a device is added to or removed from an existing SAN environment, rediscover devices by selecting this option. Devices must be discovered first so that current values of device attributes are shown in the List Attributes of a Discovered Device option. Supported devices on FC SAN are tape drives, and autochangers. The IBM Spectrum Protect device driver ignores all other device types, such as disk.

Remove all defined devices

This option removes all FC SAN-attached IBM Spectrum Protect devices whose state is `DEFINED` in the ODM database. If necessary, rediscover devices by selecting the `Discover Devices Supported by IBM Spectrum Protect` option after the removal of all defined devices.

Remove a device

This option removes a single FC SAN-attached IBM Spectrum Protect device whose state is `DEFINED` in the ODM database. If necessary, rediscover the device by selecting the `Discover Devices Supported by IBM Spectrum Protect` option after removal of a defined device.

**AIX**

## Configuring IBM Spectrum Protect device drivers for autochangers

---

Use the following procedure to configure IBM Spectrum Protect™ device drivers for autochangers for non-IBM libraries.

### Procedure

---

Run the SMIT program to configure the device driver for each autochanger or robot:

1. Select Devices.
2. Select IBM Spectrum Protect Devices.
3. Select Library/MediumChanger.
4. Select Add a Library/MediumChanger.
5. Select the IBM Spectrum Protect-SCSI-LB for any IBM Spectrum Protect supported library.
6. Select the parent adapter to which you are connecting the device. This number is listed in the form: 00-0X, where X is the slot number location of the SCSI adapter card.
7. When prompted, enter the CONNECTION address of the device that you are installing. The connection address is a two-digit number. The first digit is the SCSI ID (the value you recorded on the worksheet). The second digit is the device's SCSI logical unit number (LUN), which is usually zero, unless otherwise noted. The SCSI ID and LUN must be separated by a comma (.). For example, a connection address of 4, 0 has a SCSI ID=4 and a LUN=0.
8. Click DO.

You receive a message (logical file name) of the form `lbX Available`. Note the value of X, which is a number that is assigned automatically by the system. Use this information to complete the Device Name field on your worksheet.

For example, if the message is `lb0 Available`, the Device Name field is `/dev/lb0` on the worksheet. Always use the `/dev/` prefix with the name provided by SMIT.

AIX

## Configuring IBM Spectrum Protect device drivers for tape drives

---

Use the following procedure to configure IBM Spectrum Protect™ device drivers for autochangers for vendor-acquired libraries.

### Procedure

---

**Important:** IBM Spectrum Protect cannot overwrite `tar` or `dd` tapes, but `tar` or `dd` can overwrite IBM Spectrum Protect tapes.

**Restriction:** Tape drives can be shared only when the drive is not defined or the server is not started. The `MKSYSB` command does not work when both IBM Spectrum Protect and AIX® are sharing the same drive or drives. To use the operating system's native tape device driver with a SCSI drive, the device must be configured to AIX first and then configured to IBM Spectrum Protect. See your AIX documentation regarding these native device drivers.

Run the SMIT program to configure the device driver for each drive (including drives in libraries) as follows:

1. Select Devices.
2. Select IBM Spectrum Protect Devices.
3. Select Tape Drive.
4. Select Add a Tape Drive.
5. Select the IBM Spectrum Protect-SCSI-MT for any supported tape drive.
6. Select the adapter to which you are connecting the device. This number is listed in the form: 00-0X, where X is the slot number location of the SCSI adapter card.
7. When prompted, enter the CONNECTION address of the device you are installing. The connection address is a two-digit number. The first digit is the SCSI ID (the value you recorded on the worksheet). The second digit is the device's SCSI logical unit number (LUN), which is usually zero, unless otherwise noted. The SCSI ID and LUN must be separated by a comma (.). For example, a connection address of 4, 0 has a SCSI ID=4 and a LUN=0.
8. Click DO. You receive a message:

If you are configuring the device driver for a tape device (other than an IBM® tape drive), you receive a message (logical file name) of the form `mtX Available`. Note the value of X, which is a number that is assigned automatically by the system. Use this information to complete the Device Name field on the worksheet.

For example, if the message is `mt0 Available`, the Device Name field is `/dev/mt0` on the worksheet. Always use the `/dev/` prefix with the name provided by SMIT.



## Configuring Fibre Channel SAN-attached devices

To configure a Fibre Channel SAN-attached device, complete the procedure.

### Procedure

1. Run the SMIT program.
2. Select Devices.
3. Select IBM Spectrum Protect™ Devices.
4. Select Fibre Channel SAN Attached devices.
5. Select Discover Devices Supported by IBM Spectrum Protect. The discovery process can take some time.
6. Go back to the Fibre Channel menu, and select List Attributes of a Discovered Device.
7. Note the three-character device identifier, which you use when you define a path to the device to IBM Spectrum Protect. For example, if a tape drive has the identifier `mt2`, specify `/dev/mt2` as the device name.

### Linux

## Configuring tape device drivers on Linux systems

Review the following topics when you install and configure tape device drivers on Linux systems.

- **Linux** Configuring IBM Spectrum Protect passthru drivers for tape devices and libraries  
To use the IBM Spectrum Protect Linux Passthru driver, you must complete the following steps.
- **Linux** Installing zSeries Linux Fibre Channel adapter (zfcp) device drivers  
The zSeries Linux Fibre Channel adapter (zfcp) device driver is a special adapter driver on the IBM® zSeries system.
- **Linux** Information about your system's SCSI devices  
Information about the devices seen by your system is available in the file `/proc/scsi/scsi`. This file contains a list of every detected SCSI device.
- **Linux** Preventing tape labels from being overwritten  
The IBM Spectrum Protect Passthru device driver uses the Linux SCSI generic device driver (sg) to control and operate tape devices that are attached on the system. If the Linux generic SCSI tape device driver (st) is loaded to the kernel and configures attached tape devices, conflicts can arise over how a device is managed because the generic sg driver and the st driver can both control the same device.

### Linux

## Configuring IBM Spectrum Protect passthru drivers for tape devices and libraries

To use the IBM Spectrum Protect™ Linux Passthru driver, you must complete the following steps.

### Procedure

1. Verify that the device is connected to your system, and is powered on and active.
2. Verify that the device is correctly detected by your system by issuing this command:

```
cat /proc/scsi/scsi
```

3. Ensure that both the IBM Spectrum Protect device driver package (tsmscsi) and the storage server package are installed.
4. There are two driver configuration methods available in the IBM Spectrum Protect device driver package: `autoconf` and `tsmscsi`. Both of these methods complete the following tasks:
  - Load the Linux SCSI generic driver (sg) to the kernel.
  - Create necessary special files for the Passthru driver.
  - Create device information files for tape devices (`/dev/tsmscsi/mtinfo`) and libraries (`/dev/tsmscsi/lbinfo`).
5. Run the configuration method that you prefer (`autoconf` or `tsmscsi`) for the IBM Spectrum Protect Passthru driver.
  - To run the `autoconf` configuration method, issue the following command:

```
autoconf
```

- To run the `tsmscsi` configuration method, complete the following steps:

- a. Copy the two sample configuration files that are in the installation directory from *mt.conf.smp* and *lb.conf.smp* to *mt.conf* and *lb.conf*, respectively.
  - b. Edit the *mt.conf* and *lb.conf* files. Add one stanza (as shown in the example at the start of the file) for each SCSI target, ID, and LUN combination. Each combination of SCSI target, ID, and LUN entries correspond to a tape drive or library you want configured. Make sure that the files meet these requirements:
    - Remove the example that is at the start of the files.
    - There must be a new line between each stanza.
    - There must be one new line after the last stanza.
    - Ensure that there are no number signs (#) in either file.
  - c. Run the *tmsmcsi* script from the device driver installation directory.
6. Verify that the device is configured properly by viewing the text files for tape devices (*/dev/tmsmcsi/mtinfo*) and libraries (*/dev/tmsmcsi/lbinfo*).
  7. Determine the special file names for the tape drives and libraries:
    - To determine the names for tape devices, issue the following command:
 

```
> ls /dev/tmsmcsi/mt*
```
    - To determine the names for libraries, issue the following command:
 

```
> ls /dev/tmsmcsi/lb*
```

This information helps you identify which of the */dev/tmsmcsi/mtx* and */dev/tmsmcsi/lbx* special file names to provide the server when you issue a DEFINE PATH command.

## What to do next

---

If you restart the host system, you must rerun the *autoconf* or *tmsmcsi* script to reconfigure IBM Spectrum Protect devices. If you restart the IBM Spectrum Protect server instance, you do not have to reconfigure devices. In general, the Linux SCSI generic driver is preinstalled to the kernel. To verify that the driver is in the kernel, issue the following command:

```
> lsmod | grep sg
```

If the driver is not in the kernel, issue the *modprobe sg* command to load the *sg* driver into the kernel.

Linux

## Installing zSeries Linux Fibre Channel adapter (zfcp) device drivers

---

The zSeries Linux Fibre Channel adapter (zfcp) device driver is a special adapter driver on the IBM® zSeries system.

### About this task

---

IBM Spectrum Protect™ and IBM tape device drivers can run on zSeries platforms with Linux operating systems in 64-bit environments, and support most original equipment manufacturer (OEM) and IBM tape devices with Fibre Channel interfaces.

For more information about the *zfcp* driver, see the IBM Redpaper™, *Getting Started with zSeries Fibre Channel Protocol*, which is available at IBM Redbooks®.

### Procedure

---

1. Load the *qdio* module.
2. Install the *zfcp* driver.
3. Map the Fibre Channel Protocol (FCP) and configure the *zfcp* driver.
4. Install and configure the IBM tape device driver.

Linux

## Information about your system's SCSI devices

---

Information about the devices seen by your system is available in the file */proc/scsi/scsi*. This file contains a list of every detected SCSI device.

The following device information is available: the host number, channel number, SCSI ID, Logical Unit number, vendor, firmware level, type of device, and the SCSI mode. For example, if a system contains some StorageTek and IBM® libraries, a SAN Gateway,

and some Quantum DLT drives, the `/proc/scsi/scsi` file will look similar to this:

```
Attached devices:
Host: scsi2 Channel: 00 Id: 00 Lun: 00
  Vendor: STK      Model: 9738      Rev: 2003
  Type:  Medium Changer      ANSI SCSI revision: 02
Host: scsi2 Channel: 00 Id: 01 Lun: 02
  Vendor: PATHLIGHT Model: SAN Gateway  Rev: 32aC
  Type: Unknown      ANSI SCSI revision: 03
Host: scsi2 Channel: 00 Id: 01 Lun: 02
  Vendor: QUANTUM  Model: DLT7000      Rev: 2560
  Type: Sequential-Access  ANSI SCSI revision: 02
Host: scsi2 Channel: 00 Id: 01 Lun: 04
  Vendor: IBM      Model: 7337      Rev: 1.63
  Type:  Medium Changer      ANSI SCSI revision: 02
```

Linux

## Preventing tape labels from being overwritten

The IBM Spectrum Protect™ Passthru device driver uses the Linux SCSI generic device driver (`sg`) to control and operate tape devices that are attached on the system. If the Linux generic SCSI tape device driver (`st`) is loaded to the kernel and configures attached tape devices, conflicts can arise over how a device is managed because the generic `sg` driver and the `st` driver can both control the same device.

### About this task

If the `st` driver controls devices that are used by IBM Spectrum Protect, IBM Spectrum Protect internal tape labels can be overwritten and data can be lost. If an application uses the `st` driver to control devices and the non-rewind option is not specified, tapes are automatically rewound following completion of an operation. The auto-rewind operation relocates the tape header position to the beginning of the tape. If the tape remains loaded in the drive, the next non-IBM Spectrum Protect write operation overwrites the IBM Spectrum Protect tape label because the label is at the beginning of the tape.

To prevent IBM Spectrum Protect labels from being overwritten, which can result in data loss, ensure that only the IBM Spectrum Protect Passthru driver controls devices that are used by IBM Spectrum Protect. Remove the `st` driver from the kernel or, if the driver is used by some applications on the system, delete the special files that correspond to IBM Spectrum Protect devices so that the `st` driver can no longer control them.

If you are using the IBM tape device driver to control devices on your system, you might encounter the same issues with device driver control conflicts. Review your IBM tape documentation to determine how to resolve this issue and prevent data loss.

#### Remove the `st` driver

If no other applications on the system use `st` devices, remove the `st` driver from the kernel. Issue the following command to unload the `st` driver:

```
rmmod st
```

#### Delete device special files that correspond to IBM Spectrum Protect devices

If there are applications that require use of the `st` driver, delete the special files that correspond to IBM Spectrum Protect devices. These special files are generated by the `st` driver. When they are eliminated, the `st` driver can no longer control the corresponding IBM Spectrum Protect devices. Device special file names for tape drives appear in the `/dev/` directory. Their names have the form `/dev/[n]st[0-1024][l][m][a]`.

List the `st` drive special file names and IBM Spectrum Protect device special file names by using the `ls` command. Based on the output of the device sequences, you can find devices in the `st` devices list matching those in the IBM Spectrum Protect devices list. The `rm` command can then be used to delete `st` devices.

Issue the following commands to list the `st` and IBM Spectrum Protect devices:

```
ls -l /dev/*st*
ls -l /dev/tmsmcs/mt*
```

Delete the `st` devices with the `rm` command:

```
rm /dev/*st*
```

Windows

## Configuring tape device drivers on Windows systems

---

Review the instructions to install and configure drivers for tape devices and libraries on Windows systems.

- **Windows** Preparing to use the IBM Spectrum Protect passthru driver for tape devices and libraries  
To use the IBM Spectrum Protect Windows passthru device driver for tape devices and libraries, you must install the driver and obtain the device names for the server to use.
- **Windows** Configuring the IBM Spectrum Protect SCSI driver for tape devices and libraries  
If the manufacturer of a tape drive or tape library does not provide a SCSI device driver, you must install the IBM Spectrum Protect SCSI device driver.

**Windows**

## Preparing to use the IBM Spectrum Protect passthru driver for tape devices and libraries

---

To use the IBM Spectrum Protect™ Windows passthru device driver for tape devices and libraries, you must install the driver and obtain the device names for the server to use.

### Before you begin

---

1. Determine whether the manufacturer of the tape device or tape library provides a device driver.
2. If the manufacturer provides a device driver package, download the package and install it.
3. Configure the SCSI device driver by following the manufacturer's instructions.

### Procedure

---

1. Install the IBM Spectrum Protect passthru device driver.
2. Obtain the device names that the server must use by taking one of the following actions:
  - On the server, run the QUERY SAN command. The output shows all devices names and their associated device serial numbers.
  - In the server directory, run the tsmdlst.exe utility. The output shows all devices names, their associated serial numbers, and associated device locations.
  - At the Windows system command prompt, run the regedit command. From the output, obtain the device file names based on the device locations. The location consists of the port ID, SCSI bus ID, LUN ID, and SCSI target ID. The IBM Spectrum Protect device file name has a format of mtA.B.C.C for tape drives and lbA.B.C.D for tape libraries, where:
    - A is the SCSI target ID.
    - B is the LUN ID.
    - C is the SCSI bus ID.
    - D is the port ID.

**Windows**

## Configuring the IBM Spectrum Protect SCSI driver for tape devices and libraries

---

If the manufacturer of a tape drive or tape library does not provide a SCSI device driver, you must install the IBM Spectrum Protect™ SCSI device driver.

### About this task

---

The IBM Spectrum Protect SCSI device driver file name is tsm SCSI64.sys.

### Procedure

---

1. Locate the device in the Device Manager console (devmgmt.msc) and select it. Tape drives are listed under Tape drives, and medium changers are under Medium Changers.
2. Configure the device for use by the tsm SCSI64.sys device driver:
  - a. Right-click the device and click Update Driver Software.

- b. Click Browse my computer for driver software.
3. Click Let me pick from a list of device drivers on my computer.
4. Click Next.
5. Select the appropriate option:
  - a. For a tape drive, select IBM Spectrum Protect for Tape Drives.
  - b. For a medium changer, select IBM Spectrum Protect for Medium Changers.
6. Click Next.
7. Click Close.
8. Verify that the device was configured correctly for the tsm SCSI64 device driver:
  - a. Right-click on the device and click Properties.
  - b. Click the Driver tab and Driver Details. The Driver Details window shows the device driver that is controlling the device.

## Configuring libraries for use by a server

---

To use a library or libraries for storage for an IBM Spectrum Protect™ server, you must first set up the devices on the server system.

### Before you begin

---

1. Attach devices to the server hardware. Follow the instructions in Attaching an automated library device to your system.
2. Select the tape device drivers. Follow the instructions in Selecting a tape device driver.
3. Install and configure the tape device drivers. Follow the instructions in Installing and configuring tape device drivers.
4. Determine the device names that are needed to define the library to the server. Follow the instructions in Special file names for tape devices.

### Procedure

---

1. Define the library and the path from the server to the library. Follow the instructions in Defining libraries.
2. Define the drives in the library. Follow the instructions in Defining drives.

For SCSI libraries, you can use the `PERFORM LIBACTION` command to define drives and paths for a library in one step, instead of completing both steps 2 and 3. To use the `PERFORM LIBACTION` command to define drives and paths for a library, the `SANDISCOVERY` option must be supported and enabled.

3. Define a path from the server to each drive by using the `DEFINE PATH` command.
4. Define a device class. Follow the instructions in Defining tape device classes.

Device classes specify the recording formats for drives and classify them according to type. Use the default value, `FORMAT=DRIVE` as the recording format only if all the drives that are associated with the device class can read and write to all of the media.

For example, you have a mix of Ultrium Generation 3 and Ultrium Generation 4 drives, but you have only Ultrium Generation 3 media. You can specify `FORMAT=DRIVE` because both the Generation 4 and Generation 3 drives can read from and write to Generation 3 media.

5. Define a storage pool by using the `DEFINE STGPOOL` command.

Consider the following key choices for defining storage pools:

- o Scratch volumes are empty volumes that are available for use. If you specify a value for the maximum number of scratch volumes in the storage pool, the server can choose from the scratch volumes available in the library.

If you do not allow scratch volumes, you must complete the extra step of explicitly defining each volume to be used in the storage pool. Also, specify the `MAXSCRATCH=0` parameter when you define the storage pool so that scratch volumes are not used.

- o The default setting for primary storage pools is collocation by group. The default for copy storage pools and active-data pools is disablement of collocation. The server uses *collocation* to keep all files that belong to a group of client nodes, a single client node, a client file space, or a group of client file spaces on a minimal number of volumes. If collocation is disabled for a storage pool and clients begin storing data, you cannot easily change the data in the pool so that it is collocated.

6. Check in and label library volumes. Follow the instructions in Checking volumes into an automated library and Labeling tape volumes.

Ensure that enough volumes in the library are available to the server. Keep enough labeled volumes on hand so that you do not run out during an operation such as client backup. Label extra scratch volumes for any potential recovery operations that you might have later.

The procedures for checking in and labeling volumes are the same whether the library contains drives of a single device type, or drives of multiple device types. You can use the CHECKIN LIBVOLUME command to check in volumes that are already labeled. Or, if you want to label and check in volumes with one step, issue the LABEL LIBVOLUME command.

Libraries with multiple device types: If your library has drives of multiple device types, and you defined two libraries to the IBM Spectrum Protect server, the two defined libraries represent one physical library. You must check in tape volumes separately to each defined library. Ensure that you check in volumes to the correct IBM Spectrum Protect library.

## What to do next

---

Verify your device definitions to ensure that everything is configured correctly. Use a QUERY command to review information about each storage object.

When you review the results of the QUERY DRIVE command, verify that the device type for the drive is what you expect. If a path is not defined, the drive device type is listed as UNKNOWN and if the wrong path is used, GENERIC\_TAPE or another device type is shown. This step is especially important when you are using mixed media.

Optionally, configure library sharing. Follow the instructions in [Configuring library sharing](#).

- [Defining tape devices](#)  
Before you can back up or migrate data to tape, you must define a tape device to the IBM Spectrum Protect.
- [Configuring library sharing](#)  
Multiple IBM Spectrum Protect servers can share storage devices by using a storage area network (SAN). You set up one server as the library manager and the other servers as library clients.

### Related reference:

- [CHECKIN LIBVOLUME](#) (Check a storage volume into a library)
- [DEFINE STGPPOOL](#) (Define a volume in a storage pool)
- [LABEL LIBVOLUME](#) (Label a library volume)
- [PERFORM LIBACTION](#) (Define or delete all drives and paths for a library)

## Defining tape devices

---

Before you can back up or migrate data to tape, you must define a tape device to the IBM Spectrum Protect™.

- [Defining libraries and drives](#)  
A tape library can include one or more tape drives. Learn how to define libraries, drives, and paths to the IBM Spectrum Protect server.
- [Defining tape device classes](#)  
A device class defines a set of characteristics that are used by a set of volumes that can be created in a storage pool. You must define a device class for a tape device to ensure that the server can use the device.

## Defining libraries and drives

---

A tape library can include one or more tape drives. Learn how to define libraries, drives, and paths to the IBM Spectrum Protect™ server.

- [Defining libraries](#)  
Before you can use a drive, you must define the library to which the drive belongs.
- [Defining drives](#)  
To inform the server about a drive that can be used to access storage volumes, issue the DEFINE DRIVE command, followed by the DEFINE PATH command.

## Defining libraries

---

Before you can use a drive, you must define the library to which the drive belongs.

## Procedure

---

1. Define the library by using the DEFINE LIBRARY command.

For example, if you have an IBM TS3500 tape library, you can define a library that is named ROBOTMOUNT by using the following command:

```
define library robotmount libtype=scsi
```

If you require library sharing or LAN-free data movement, see the following information:

- o Configuring library sharing
- o Configuring LAN-free data movement

2. Define a path from the server to the library by using the DEFINE PATH command. When you specify the DEVICE parameter, enter the device special file name. This name is required by the server to communicate with tape drives, medium changer, and removable media devices. For more information about device special file names, see [Special file names for tape devices](#).

```
define path server1 robotmount srctype=server desttype=library  
device=/dev/lb0
```

### Linux

```
define path server1 robotmount srctype=server desttype=library  
device=/dev/tmscsi/lb0
```

### Windows

```
define path server1 robotmount srctype=server desttype=library  
device=lb0.0.1.0
```

- Defining SCSI libraries on a SAN

For a library type of SCSI on a SAN, the server can track the library's serial number. With the serial number, the server can confirm the identity of the device when you define the path or when the server uses the device.

### Related reference:

[DEFINE LIBRARY \(Define a library\)](#)

[DEFINE PATH \(Define a path\)](#)

## Defining drives

---

To inform the server about a drive that can be used to access storage volumes, issue the DEFINE DRIVE command, followed by the DEFINE PATH command.

### Before you begin

---

A *drive object* represents a drive mechanism within a library that uses removable media. For devices with multiple drives, including automated libraries, you must define each drive separately and associate it with a library. Drive definitions can include such information as the element address for drives in SCSI, how often a tape drive is cleaned, and whether the drive is online.

IBM Spectrum Protect™ supports tape drives that can be stand-alone or that can be part of an automated library. The preferred method is to configure the tape solution by using automated libraries.

### About this task

---

When you issue the DEFINE DRIVE command, you must provide some or all of the following information:

#### Library name

The name of the library in which the drive is located.

#### Drive name

The name that is assigned to the drive.

#### Serial number

The serial number of the drive. The serial number parameter applies only to drives in SCSI. With the serial number, the server can confirm the identity of the device when you define the path or when the server uses the device.

You can specify the serial number if you choose. The default is to enable the server to obtain the serial number from the drive itself at the time that the path is defined. If you specify the serial number, the server confirms that the serial number is correct when you define the path to the drive. When you define the path, you can set the AUTODETECT=YES parameter to enable the server to correct the serial number if the number that it detects does not match what you entered when you defined the drive. As a best practice, specify the AUTODETECT=YES parameter to automatically update the serial number for the drive in the database when the path is defined.

Depending on the capabilities of the drive, the server might not be able to automatically detect the serial number. In this case, the server does not record a serial number for the device, and is not able to confirm the identity of the device when you define the path or when the server uses the device. See [Impacts of device changes on the SAN](#).

#### Element address

The element address of the drive. The ELEMENT parameter applies only to drives in SCSI libraries. The element address is a number that indicates the physical location of a drive within an automated library. The server needs the element address to connect the physical location of the drive to the drive's SCSI address. The server can obtain the element address from the drive when you define the path, or you can specify the element number when you define the drive. As a best practice, specify the ELEMENT=AUTODETECT parameter for the server to automatically detect the element number when the path to the drive is defined.

Depending on the capabilities of the library, the server might not be able to automatically detect the element address. In this case, you must supply the element address when you define the drive, if the library has more than one drive. To obtain the element address, go to the [IBM® Support Portal for IBM Spectrum Protect](#).

Tip: IBM tape device drivers and non-IBM tape device drivers generate different device files and formats:

- For IBM, device names begin with rmt followed by an integer, for example, /dev/rmt0.
- For IBM Spectrum Protect tape device drivers, tape device names begin with mt followed by an integer, for example /dev/mt0.

You must use the correct device file when you define a path.

## Procedure

---

1. Assign a drive to a library by issuing the DEFINE DRIVE command.
2. To make the drive usable by the server, issue the DEFINE PATH command.

For examples about configuring libraries, paths, and drives, see [Example: Configure a SCSI or virtual tape library with a single drive device type](#) and [Example: Configure a SCSI or virtual tape library with multiple drive device types](#).

## Defining tape device classes

---

A device class defines a set of characteristics that are used by a set of volumes that can be created in a storage pool. You must define a device class for a tape device to ensure that the server can use the device.

### Before you begin



---

You must define libraries and drives to the server before you define device classes.

### About this task

---

For a list of supported devices and valid device class formats, see the [IBM Spectrum Protect™ Supported Devices website](#) for your operating system:

-   Supported devices for AIX and Windows
-  Supported devices for Linux

You can define multiple device classes for each device type. For example, you might want to specify different attributes for different storage pools that use the same type of tape drive. Variations might be required that are not specific to the device, but rather to how you want to use the device (for example, mount retention or mount limit).

Guidelines:

- One device class can be associated with multiple storage pools, but each storage pool is associated with only one device class.



- SCSI libraries can include tape drives of more than one device type. When you define the device class in this environment, you must declare a value for the FORMAT parameter.

For more information, see Mixed device types in libraries.

## Procedure

To define a device class, use the DEFINE DEVCLASS command with the DEVTYPE parameter, which assigns a device type to the device class.

## Results

If you include the DEVCONFIG option in the dsmserv.opt file, the files that you specify with that option are automatically updated with the results of the DEFINE DEVCLASS, UPDATE DEVCLASS, and DELETE DEVCLASS commands.

- Defining LTO device classes  
To prevent problems when you mix different generations of LTO drives and media in a single library, review the restrictions. Also, review the restrictions for LTO drive encryption.
- Defining 3592 device classes  
Device class definitions for 3592, TS1130, TS1140, TS1150, and later devices include parameters for faster volume-access speeds and drive encryption. To prevent problems when mixing different generations of 3592 and TS1130 and later drives in a library, review the guidelines.

### Related reference:

- [DEFINE DEVCLASS \(Define a device class\)](#)
- [QUERY DEVCLASS \(Display information on one or more device classes\)](#)
- [UPDATE DEVCLASS \(Update a device class\)](#)

## Defining LTO device classes

To prevent problems when you mix different generations of LTO drives and media in a single library, review the restrictions. Also, review the restrictions for LTO drive encryption.

- Mixing LTO drives and media in a library  
When you mix different generations of LTO drives and media, you must consider the read/write capabilities of each generation. The preferred method is to configure a different device class for each generation of media.
- Mount limits in LTO mixed-media environments  
In a mixed-media library, in which multiple device classes point to the same library, compatible drives are shared between storage pools. Ensure that you set an appropriate value for the MOUNTLIMIT parameter in each of the device classes.
- Enabling and disabling drive encryption for LTO Generation 4 or later tape drives  
IBM Spectrum Protect™ supports the three types of drive encryption that are available with LTO Generation 4 or later drives: Application, System, and Library. These methods are defined through the hardware.

## Mixing LTO drives and media in a library

When you mix different generations of LTO drives and media, you must consider the read/write capabilities of each generation. The preferred method is to configure a different device class for each generation of media.

## About this task

If you are considering mixing different generations of LTO media and drives, review the following restrictions:

Table 1. Read/write capabilities for different generations of LTO drives

Drives	Generation 1 media	Generation 2 media	Generation 3 media	Generation 4 media	Generation 5 media	Generation 6 media	Generation 7 media
Generation 1	Read/write access	n/a	n/a	n/a	n/a	n/a	n/a
Generation 2	Read/write access	Read/write access	n/a	n/a	n/a	n/a	n/a

Drives	Generation 1 media	Generation 2 media	Generation 3 media	Generation 4 media	Generation 5 media	Generation 6 media	Generation 7 media
Generation 3	Read-only access	Read/write access	Read/write access	n/a	n/a	n/a	n/a
Generation 4	n/a	Read-only access	Read/write access	Read/write access	n/a	n/a	n/a
Generation 5	n/a	n/a	Read-only access	Read/write access	Read/write access	n/a	n/a
Generation 6	n/a	n/a	n/a	Read-only access	Read/write access	Read/write access	n/a
Generation 7	n/a	n/a	n/a	n/a	Read access	Read/write access	Read/write access

## Example

If you are mixing different types of drives and media, configure different device classes: one for each type of media. To specify the media type, use the `FORMAT` parameter in each of the device class definitions. (Do not specify `FORMAT=DRIVE`.) For example, if you are mixing Ultrium Generation 5 and Ultrium Generation 6 drives, specify `FORMAT=ULTRIUM5C` (or `ULTRIUM5`) for the Ultrium Generation 5 device class, and `FORMAT=ULTRIUM6C` (or `ULTRIUM6`) for the Ultrium Generation 6 device class.

In this example, both device classes can point to the same library with Ultrium Generation 5 and Ultrium Generation 6 drives. The drives are shared between the two storage pools. One storage pool uses the first device class and Ultrium Generation 5 media exclusively. The other storage pool uses the second device class and Ultrium Generation 6 media exclusively. Because the two storage pools share a single library, Ultrium Generation 5 media can be mounted on Ultrium Generation 6 drives as they become available during mount point processing.

If you mix older read-only media generations with newer read/write media in a single library, you must mark the read-only media as read-only and check out all read-only scratch media. For example, if you are mixing Ultrium Generation 4 with Ultrium Generation 6 drives and media in a single library, you must mark the Generation 4 media as read-only. In addition, you must check out all Generation 4 scratch volumes.

## Mount limits in LTO mixed-media environments

In a mixed-media library, in which multiple device classes point to the same library, compatible drives are shared between storage pools. Ensure that you set an appropriate value for the `MOUNTLIMIT` parameter in each of the device classes.

For example, in a mixed media library that contains Ultrium Generation 1 and Ultrium Generation 2 drives and media, Ultrium Generation 1 media can be mounted in Ultrium Generation 2 drives.

Consider the example of a mixed library that consists of the following drives and media:

- Four LTO Ultrium Generation 1 drives and LTO Ultrium Generation 1 media
- Four LTO Ultrium Generation 2 drives and LTO Ultrium Generation 2 media

You created the following device classes:

- LTO Ultrium Generation 1 device class `LTO1CLASS` specifying `FORMAT=ULTRIUMC`
- LTO Ultrium Generation 2 device class `LTO2CLASS` specifying `FORMAT=ULTRIUM2C`

You also created the following storage pools:

- LTO Ultrium Generation 1 storage pool `LTO1POOL` based on device class `LTO1CLASS`
- LTO Ultrium Generation 2 storage pool `LTO2POOL` based on device class `LTO2CLASS`

The number of mount points available for use by each storage pool is specified in the device class by using the `MOUNTLIMIT` parameter. The `MOUNTLIMIT` parameter in the `LTO2CLASS` device class must be set to 4 to match the number of available drives that can mount only LTO2 media. The `MOUNTLIMIT` parameter in the `LTO1CLASS` device class must be set to a value that is greater than the number of available drives (5 or possibly 6) to adjust for the fact that Ultrium Generation 1 media can be mounted in Ultrium Generation 2 drives. The optimal value for `MOUNTLIMIT` depends on workload and storage pool access patterns.

Monitor and adjust the MOUNTLIMIT setting to suit changing workloads. If the MOUNTLIMIT for LTO1POOL is set too high, mount requests for the LTO2POOL might be delayed or fail because the Ultrium Generation 2 drives are used to satisfy Ultrium Generation 1 mount requests. In the worst scenario, too much competition for Ultrium Generation 2 drives might cause mounts for Generation 2 media to fail with the following message:

```
ANR8447E No drives are currently available in the library.
```

If the MOUNTLIMIT value for LTO1POOL is not set high enough, mount requests that might be satisfied by LTO Ultrium Generation 2 drives are delayed.

Restriction: Restrictions apply when you mix Ultrium Generation 1 with Ultrium Generation 2 or Generation 3 drives because of how mount points are allocated. For example, processes that require multiple mount points that include both Ultrium Generation 1 and Ultrium Generation 2 volumes might try to reserve Ultrium Generation 2 drives only, even when one mount can be satisfied by an available Ultrium Generation 1 drive. Processes that behave in this manner include the MOVE DATA and BACKUP STGPOOL commands. These processes wait until the required number of mount points can be satisfied with Ultrium Generation 2 drives.

**Related reference:**

➤ [BACKUP STGPOOL](#) (Back up primary storage pool data to a copy storage pool)

➤ [DEFINE DEVCLASS](#) (Define a device class)

➤ [MOVE DATA](#) (Move files on a storage pool volume)

## Enabling and disabling drive encryption for LTO Generation 4 or later tape drives

---

IBM Spectrum Protect™ supports the three types of drive encryption that are available with LTO Generation 4 or later drives: Application, System, and Library. These methods are defined through the hardware.

### About this task

---

The DRIVEENCRYPTION parameter on the DEFINE DEVCLASS command specifies whether drive encryption is allowed for IBM and HP LTO Generation 4 or later, Ultrium 4, and Ultrium 4C formats. This parameter ensures IBM Spectrum Protect compatibility with hardware encryption settings for empty volumes. You cannot use this parameter for storage pool volumes that are full or are filling.

IBM Spectrum Protect supports the Application method of encryption with IBM and HP LTO-4 or later drives. Only IBM LTO-4 or later supports the System and Library methods. The Library method of encryption can be used only if your system hardware (for example, IBM TS3500) supports it.

Restriction: You cannot use drive encryption with write-once, read-many (WORM) media.

The Application method is defined through the hardware. To use the Application method, in which IBM Spectrum Protect generates and manages encryption keys, set the DRIVEENCRYPTION parameter to ON. This action enables data encryption for empty volumes. If the parameter is set to ON and the hardware is configured for another encryption method, backup operations fail.

### Procedure

---

The following simplified example shows the steps that you would take to enable and disable data encryption for empty volumes in a storage pool:

1. Define a library by issuing the DEFINE LIBRARY command:

```
define library 3584 libtype=SCSI
```

2. Define a device class, LTO\_ENCRYPT, by issuing the DEFINE DEVCLASS command and specifying IBM Spectrum Protect as the key manager:

```
define devclass lto_encrypt library=3584 devtype=lto driveencryption=on
```

3. Define a storage pool by issuing the DEFINE STGPOOL command:

```
define stgpool lto_encrypt_pool lto_encrypt
```

4. To disable encryption on new volumes, set the DRIVEENCRYPTION parameter to OFF. The default value is ALLOW. Drive encryption for empty volumes is allowed if another method of encryption is enabled.

**Related concepts:**

Tape encryption methods

## Defining 3592 device classes

Device class definitions for 3592, TS1130, TS1140, TS1150, and later devices include parameters for faster volume-access speeds and drive encryption. To prevent problems when mixing different generations of 3592 and TS1130 and later drives in a library, review the guidelines.

- **Mixing generations of 3592 drives and media in a single library**  
For optimal performance, do not mix generations of 3592 media in a single library. Media problems can result when different drive generations are mixed. For example, IBM Spectrum Protect™ might not be able to read a volume's label.
- **Controlling data-access speeds for 3592 volumes**  
You can optimize the storage capacity and improve data-access speeds when you create volumes. By partitioning data into storage pools that have volumes, you can specify the scale capacity percentage to provide maximum storage capacity, or to provide fast access to the volume.
- **Enabling and disabling 3592 Generation 2 and later drive encryption**  
With IBM Spectrum Protect, you can use the following types of drive encryption with drives that are 3592 Generation 2 and later: Application, System, and Library. These methods are defined through the hardware.

## Mixing generations of 3592 drives and media in a single library

For optimal performance, do not mix generations of 3592 media in a single library. Media problems can result when different drive generations are mixed. For example, IBM Spectrum Protect™ might not be able to read a volume's label.

### About this task

The following table shows read/write interoperability for drive generations.

Drives	Generation 1 format	Generation 2 format	Generation 3 format	Generation 4 format	Generation 5 format
Generation 1	Read/write access	n/a	n/a	n/a	n/a
Generation 2	Read/write access	Read/write access	n/a	n/a	n/a
Generation 3	Read-only access	Read/write access	Read/write access	n/a	n/a
Generation 4	n/a	Read only	Read/write access	Read/write access	n/a
Generation 5	n/a	n/a	Read access	Read/write access	Read/write access

If you must mix generations of drives in a library, review the example and restrictions to help prevent problems.

Table 1. Mixing generations of drives

Library type	Example and restrictions

Library type	Example and restrictions
SCSI	<p>Define a new storage pool and device class for the latest drive generation. For example, suppose that you have a storage pool and device class for 3592-2. The storage pool contains all the media that were written in Generation 2 format. Suppose that the value of the FORMAT parameter in the device class definition is set to 3952-2 (not DRIVE). You add Generation 3 drives to the library. Complete the following steps:</p> <ol style="list-style-type: none"> <li>1. In the new device-class definition for the Generation 3 drives, set the value of the FORMAT parameter to 3592-3 or 3592-3C. Do not specify DRIVE.</li> <li>2. In the definition of the storage pool that is associated with Generation 2 drives, update the MAXSCRATCH parameter to 0, for example: <pre>update stgpool genpool2 maxscratch=0</pre> </li> </ol> <p>This method allows both generations to use their optimal format and minimizes potential media problems that can result from mixing generations. However, it does not resolve all media issues. For example, competition for mount points and mount failures might result. (To learn more about mount point competition in the context of 3592 drives and media, see Defining 3592 device classes.)</p> <p>Restriction: The following list describes media restrictions:</p> <ul style="list-style-type: none"> <li>• CHECKIN LIBVOL: The issue is using the CHECKLABEL=YES option. If the label is written in a Generation 3 or later format, and you specify the CHECKLABEL=YES option, drives of previous generations fail by using this command. To avoid the issue, specify CHECKLABEL=BARCODE.</li> <li>• LABEL LIBVOL: When the server tries to use drives of a previous generation to read the label that is written in a Generation 3 or later format, the LABEL LIBVOL command fails unless OVERWRITE=YES is specified. Verify that the media that is being labeled with OVERWRITE=YES does not have any active data.</li> <li>• CHECKOUT LIBVOL: When IBM Spectrum Protect verifies the label (CHECKLABEL=YES) as a Generation 3 or later format, and read drives of previous generations, the command fails. To avoid this issue, specify CHECKLABEL=NO.</li> </ul>

**Related reference:**

- [CHECKIN LIBVOLUME \(Check a storage volume into a library\)](#)
- [CHECKOUT LIBVOLUME \(Check a storage volume out of a library\)](#)
- [LABEL LIBVOLUME \(Label a library volume\)](#)
- [UPDATE STGPOOL \(Update a storage pool\)](#)

## Controlling data-access speeds for 3592 volumes

You can optimize the storage capacity and improve data-access speeds when you create volumes. By partitioning data into storage pools that have volumes, you can specify the scale capacity percentage to provide maximum storage capacity, or to provide fast access to the volume.

### About this task

To reduce media capacity, specify the SCALECAPACITY parameter when you define the device class by using the DEFINE DEVCLASS command or when you update the device class by using the UPDATE DEVCLASS command.

Specify a percentage value of 20, 90, or 100. A value of 20 percent provides the fastest access time, and 100 percent provides the largest storage capacity. For example, if you specify a scale capacity of 20 for a 3592 device class without compression, a 3592 volume in that device class would store 20 percent of its full capacity of 300 GB, or about 60 GB.

Scale capacity takes effect only when data is first written to a volume. Updates to the device class for scale capacity do not affect volumes that already have data written to them until the volume is returned to scratch status.

**Related reference:**

- [DEFINE DEVCLASS \(Define a device class\)](#)
- [UPDATE DEVCLASS \(Update a device class\)](#)

# Enabling and disabling 3592 Generation 2 and later drive encryption

---

With IBM Spectrum Protect™, you can use the following types of drive encryption with drives that are 3592 Generation 2 and later: Application, System, and Library. These methods are defined through the hardware.

## About this task

---

The DRIVEENCRYPTION parameter on the DEFINE DEVCLASS command specifies whether drive encryption is allowed for drives that are 3592 Generation 2 and later. Use this parameter to ensure IBM Spectrum Protect compatibility with hardware encryption settings for empty volumes. You cannot use this parameter for storage pool volumes that are full or are filling.

- To use the Application method, in which IBM Spectrum Protect generates and manages encryption keys, set the DRIVEENCRYPTION parameter to ON. This enables the encryption of data for empty volumes. If the parameter is set to ON and if the hardware is configured for another encryption method, backup operations fail.
- To use the Library or System methods of encryption, set the parameter to ALLOW. This specifies that IBM Spectrum Protect is not the key manager for drive encryption, but allows the hardware to encrypt the volume's data through one of the other methods. Specifying this parameter does not automatically encrypt volumes. Data can be encrypted only by specifying the ALLOW parameter and configuring the hardware to use one of these methods.

The DRIVEENCRYPTION parameter is optional. The default value is to allow the Library or System methods of encryption.

## Procedure

---

The following simplified example shows how to encrypt data for empty volumes in a storage pool, by using IBM Spectrum Protect as the key manager:

1. Define a library by issuing the DEFINE LIBRARY command. For example, issue the following command:

```
define library 3584 libtype=SCSI
```

2. Define a device class, 3592\_ENCRYPT, by issuing the DEFINE DEVCLASS command and specifying the value ON for the DRIVEENCRYPTION parameter. For example, issue the following command:

```
define devclass 3592_encrypt library=3584 devtype=3592 driveencryption=on
```

3. Define a storage pool. For example, issue the following command:

```
define stgpool 3592_encrypt_pool 3592_encrypt
```

## What to do next

---

To disable any method of encryption on new volumes, set the DRIVEENCRYPTION parameter to OFF. If the hardware is configured to encrypt data through either the Library or System method and DRIVEENCRYPTION is set to OFF, backup operations fail.

## Configuring library sharing

---

Multiple IBM Spectrum Protect™ servers can share storage devices by using a storage area network (SAN). You set up one server as the library manager and the other servers as library clients.

## Before you begin

---

Ensure that your systems meet licensing requirements for library sharing. An entitlement for IBM Spectrum Protect for SAN is required for each IBM Spectrum Protect server that is configured as a library client or a library manager in a SAN environment.

## About this task

---

With LAN-free data movement, IBM Spectrum Protect client systems can directly access storage devices that are defined to an IBM Spectrum Protect server. Storage agents are installed and configured on the client systems to perform the data movement.

To set up library sharing, you must define one IBM Spectrum Protect server as the library manager for your shared library configuration. Then, you define other IBM Spectrum Protect servers as library clients that communicate and request storage

resources from the library manager. The library manager server must be at the same version or a later version as the server or servers that are defined as library clients.

## Procedure

---

To complete the following steps to share library resources on a SAN among IBM Spectrum Protect servers, complete the following steps:

1. Set up server-to-server communications.

To share a storage device on a SAN, define servers to each other by using the cross-define function. Each server must have a unique name.

2. Define a shared library and set up tape devices on the server systems.

Use the procedure that is described in [Configuring libraries for use by a server](#) to define a library for use in the shared environment. Modify the procedure to define the library as shared, by specifying the SHARED=YES parameter for the DEFINE LIBRARY command.

3. Define the library manager server.
4. Define the shared library on the server that is the library client.
5. From the library manager server, define paths from the library client to each drive that the library client can access. The device name must reflect the way that the library client system recognizes the tape device. A path from the library manager to each tape drive must be defined in order for the library client to use the drive.

To avoid problems, ensure that all drive path definitions that are defined for the library manager are also defined for each library client.

For example, if the library manager defines three tape drives, the library client must also define three tape drives. To limit the number of tape drives that a library client can use at a time, use the MOUNTLIMIT parameter of the device class on the library client.

6. Define device classes for the shared library.



The preferred method is to make the device class names the same on both servers to avoid confusion when you define multiple device classes with the same device type and library parameters. Some operations, such as database backup, use the device class name to identify the data for backup.

The device class parameters that are specified on the library manager override the parameters that are specified for the library client. If the device class names are different, the library manager uses the parameters that are specified in a device class that matches the device type that is specified for the library client.

7. Define a storage pool for the shared library.
8. Repeat the steps to configure another server as a library client.

-  Example: Library sharing for AIX and Linux servers  
To learn how to set up a SCSI library sharing environment for servers that run on AIX® or Linux systems, review the sample procedure.
- Example: Library sharing for Windows servers  
To learn how to set up a library sharing environment for servers that run on Windows systems, review the sample procedure.

### Related reference:

-  [DEFINE DEVCLASS](#) (Define a device class)
-  [DEFINE LIBRARY](#) (Define a library)
-  [DEFINE STGPOOL](#) (Define a volume in a storage pool)



## Example: Library sharing for AIX and Linux servers

---

To learn how to set up a SCSI library sharing environment for servers that run on AIX® or Linux systems, review the sample procedure.

### About this task

---

In this example, a library manager server named ASTRO and a library client named JUDY are configured. To help clarify where each step is performed, the commands are preceded by the server name from which the command is issued. Most commands are issued from the library client.

For SCSI libraries, define the library by specifying the `libtype=scsi` parameter.

## Procedure

1. To set up ASTRO as the library manager server, define a shared SCSI library named SANGROUP. For example:

```
astro> define library sangroup libtype=scsi shared=yes
```

Then complete the rest of the steps as described in Example: Configure a SCSI or virtual tape library with a single drive device type to configure the library.

Tip: You can use the `PERFORM LIBACTION` command to define drives and paths for a library in one step.

2. Define ASTRO as the library manager server by issuing the `DEFINE SERVER` command.

```
judy> define server astro serverpassword=secret hladdress=192.0.2.24  
lladdress=1777 crossdefine=yes
```

3. Define the shared library SANGROUP by issuing the `DEFINE LIBRARY` command. You must use the library manager server name in the `PRIMARYLIBMANAGER` parameter, and use `LIBTYPE=SHARED`.

```
judy> define library sangroup libtype=shared primarylibmanager=astro
```

Ensure that the library name is the same as the library name on the library manager.

4. Define paths from the library manager, ASTRO, to two drives in the shared library by issuing the `DEFINE PATH` command.

**AIX**

```
astro> define path judy drivea srctype=server desttype=drive  
library=sangroup device=/dev/rmt6  
astro> define path judy driveb srctype=server desttype=drive  
library=sangroup device=/dev/rmt7
```

**Linux**

```
astro> define path judy drivea srctype=server desttype=drive  
library=sangroup device=/dev/IBMtape6  
astro> define path judy driveb srctype=server desttype=drive  
library=sangroup device=/dev/IBMtape7
```

5. Define all device classes that are associated with the shared library. **AIX**

```
judy> define devclass tape library=sangroup devtype=lto
```

**Linux**

```
judy> define devclass tape library=sangroup devtype=lto
```

The following parameters for the device class definition must be the same on the library client and the library manager:

- o LIBRARY
- o DRIVEENCRYPTION
- o WORM
- o FORMAT

6. Define a storage pool that is named BACKTAPE for the shared library to use. Issue the `DEFINE STGPOOL` command.

```
judy> define stgpool backtape tape maxscratch=50
```

## What to do next

Repeat the procedure to define more library clients to your library manager.

### Related reference:

- [DEFINE DEVCLASS \(Define a device class\)](#)
- [DEFINE DRIVE \(Define a drive to a library\)](#)
- [DEFINE LIBRARY \(Define a library\)](#)
- [DEFINE PATH \(Define a path\)](#)
- [DEFINE STGPOOL \(Define a volume in a storage pool\)](#)

**Windows**



## Example: Library sharing for Windows servers

---

To learn how to set up a library sharing environment for servers that run on Windows systems, review the sample procedure.

### About this task

---

In this example, a library manager server named ASTRO and a library client named JUDY are configured.

For SCSI libraries, define the library by specifying the `libtype=scsi` parameter.

- **Windows** Setting up the library manager server  
You must set up the library manager server in order to configure the IBM Spectrum Protect servers to share SAN-connected devices.
- **Windows** Setting up the library client servers  
You must set up one or more library client servers to configure the IBM Spectrum Protect servers to share SAN-connected devices.

**Windows**

### Setting up the library manager server

---

You must set up the library manager server in order to configure the IBM Spectrum Protect™ servers to share SAN-connected devices.

### Procedure

---

The following procedure is an example of how to set up an IBM Spectrum Protect server that is named ASTRO as a library manager:

1. Ensure that the library manager server is running:
  - a. Start the Windows Services Management Console (`services.msc`).
  - b. Select the service. For example, `TSM Server1`.
  - c. If the service is not running, right-click the service name and click Start.
2. Obtain the library and drive information for the shared library device:
  - a. Run the `tsmdlst.exe` utility. The utility is in the `\Program Files\Tivoli\TSM\server` directory.
3. Define a library whose library type is SCSI. For example:

```
define library sangroup libtype=scsi shared=yes
```

This example uses the default for the library's serial number, which is to have the server obtain the serial number from the library itself at the time that the path is defined. Depending on the capabilities of the library, the server might not be able to automatically detect the serial number. In this case, the server does not record a serial number for the device, and is not able to confirm the identity of the device when you define the path or when the server uses the device.

4. Define the path from the server to the library.

```
define path astro sangroup srctype=server desttype=library  
device=lb0.0.0.2
```

If you did not include the serial number when you defined the library, the server now queries the library to obtain this information. If you did include the serial number when you defined the library, the server verifies what you defined and issues a message if there is a mismatch.

5. Define the drives in the library.

```
define drive sangroup drivea  
define drive sangroup driveb
```

This example uses the default for the drive's serial number, which is to have the server obtain the serial number from the drive itself at the time that the path is defined. Depending on the capabilities of the drive, the server might not be able to automatically detect the serial number. In this case, the server does not record a serial number for the device, and is not able to confirm the identity of the device when you define the path or when the server uses the device.

This example also uses the default for the drive's element address, which is to have the server obtain the element number from the drive itself at the time that the path is defined.

The element address is a number that indicates the physical location of a drive within an automated library. The server needs the element address to connect the physical location of the drive to the drive's SCSI address. You can have the server obtain the element number from the drive itself at the time that the path is defined, or you can specify the element number when you define the drive.

Depending on the capabilities of the library, the server might not be able to automatically detect the element address. In this case, you must supply the element address when you define the drive. Element numbers for many libraries are available at IBM® Support Portal for IBM Spectrum Protect.

6. Define the path from the server to each of the drives.

```
define path astro drivea srctype=server desttype=drive library=sangroup
device=mt0.1.0.2
define path astro driveb srctype=server desttype=drive library=sangroup
device=mt0.2.0.2
```

If you did not include the serial number or element address when you defined the drive, the server now queries the drive or the library to obtain this information.

7. Define at least one device class.

```
define devclass tape devtype=dlt library=sangroup
```

8. Check in the library inventory. The following example checks all volumes into the library inventory as scratch volumes. The server uses the name on the bar code label as the volume name.

```
checkin libvolume sangroup search=yes status=scratch
checklabel=barcode
```

9. Set up a storage pool for the shared library with a maximum of 50 scratch volumes.

```
define stgpool backtape tape
description='storage pool for shared sangroup' maxscratch=50
```

**Related reference:**

- [CHECKIN LIBVOLUME \(Check a storage volume into a library\)](#)
- [DEFINE DEVCLASS \(Define a device class\)](#)
- [DEFINE DRIVE \(Define a drive to a library\)](#)
- [DEFINE LIBRARY \(Define a library\)](#)
- [DEFINE PATH \(Define a path\)](#)
- [DEFINE STGPOOL \(Define a volume in a storage pool\)](#)

Windows

## Setting up the library client servers

---

You must set up one or more library client servers to configure the IBM Spectrum Protect™ servers to share SAN-connected devices.

### Before you begin

---

Ensure that a library manager server is defined.

### About this task

---

You must define the library manager server. Use the following procedure as an example of how to set up an IBM Spectrum Protect server that is named JUDY as a library client.

### Procedure

---

1. Ensure that the library manager server is running:
  - a. Start the Windows Services Management Console (services.msc).
  - b. Select the service. For example, TSM Server1.

- c. If the service is not running, right-click and select Start.
2. Obtain the library and drive information for the shared library device:
  - a. Run the `tsmdlst.exe` utility. The utility is in the `\Program Files\Tivoli\TSM\server` directory.
3. Define the shared library, SANGROUP, and identify the library manager. Ensure that the library name is the same as the library name on the library manager.

```
define library sangroup libtype=shared primarylibmanager=astro
```

4. Define the paths from the library client server to each of the drives by issuing commands on the administrative client:

```
define path judy drivea srctype=server desttype=drive library=sangroup
device=mt0.1.0.3
define path judy driveb srctype=server desttype=drive library=sangroup
device=mt0.2.0.3
```

5. Define at least one device class by issuing commands from the library client:

```
define devclass tape devtype=dlt mountretention=1 mountwait=10
library=sangroup
```

Set the parameters for the device class the same on the library client as on the library manager. Making the device class names the same on both servers is also a good practice, but is not required.

The device class parameters that are specified on the library manager server override those specified for the library client. This is true whether or not the device class names are the same on both servers. If the device class names are different, the library manager uses the parameters specified in a device class that matches the device type specified for the library client.

If a library client requires a setting that is different from what is specified in the library manager's device class (for example, a different mount limit), complete the following steps:

- a. Create an additional device class on the library manager server. Specify the parameter settings that you want the library client to use.
  - b. Create a device class on the library client with the same name and device type as the new device class you created on the library server.
6. Define the storage pool, BACKTAPE, that will use the shared library:

```
define stgpool backtape tape
description='storage pool for shared sangroup' maxscratch=50
```

7. Repeat this procedure to define additional servers as library clients.

**Related reference:**

- [DEFINE DEVCLASS \(Define a device class\)](#)
- [DEFINE LIBRARY \(Define a library\)](#)
- [DEFINE PATH \(Define a path\)](#)
- [DEFINE STGPOOL \(Define a volume in a storage pool\)](#)

## Setting up a storage pool hierarchy

---

As part of the implementation process, you must set up a storage pool hierarchy. Set up at least one primary storage pool on disk and one primary storage pool on tape. Ensure that data is migrated from disk to tape daily.

### Before you begin

---

1. Ensure that you reviewed the information in Planning the storage pool hierarchy.
2. Ensure that appropriate rules, also known as *policies*, are specified for backing up client data. Follow the instructions in Specifying rules for backing up and archiving client data.
3. Ensure that a policy is assigned to each node. For instructions about assigning a policy when you register a node, see Registering clients.

### Procedure

---

To set up a storage pool hierarchy, complete the following steps:

1. Define a primary storage pool for the tape device by issuing the DEFINE STGPOOL command.

For example, define a primary storage pool, TAPE1, with a device class of LTO, and enable group collocation. Set the maximum number of scratch volumes that the server can request for this storage pool to 999. Issue the following command:

```
define stgpool tape1 lto pooltype=primary collocate=group
maxscratch=999
```

2. Define the drives, paths, and libraries for the primary storage pool on tape. Follow the instructions in Defining tape devices.
3. Define a primary storage pool for the disk device by issuing the DEFINE STGPOOL command.

For example, define a storage pool, DISK1, with a device class of FILE. Ensure that data can be migrated to the tape storage pool, TAPE1, but prevent automatic migration by specifying 100 for the HIGHMIG parameter and 0 for the LOWMIG parameter. Prevent reclamation by specifying 100 for the RECLAIM parameter. Enable node collocation. Set the maximum number of scratch volumes that the server can request for this storage pool to 9999. Use the MIGPROCESS parameter to specify the number of migration processes. The value of the MIGPROCESS parameter should equal the number of drives in the library minus the number of drives that are reserved for restore operations. Issue the following command:

```
define stgpool disk1 file pooltype=primary nextstgpool=tape1
highmig=100 lowmig=0 reclaim=100 collocate=node maxscratch=9999 migprocess=5
```

For more information about how to set up migration from disk to tape, see Migrating disk storage pools.

## What to do next

---

A storage pool hierarchy includes only primary storage pools. After you set up the storage pool hierarchy, complete the following steps:

1. Create a copy storage pool on a tape device. For instructions, see DEFINE STGPOOL (Define a copy storage pool assigned to sequential access devices).
2. Back up the tape-based primary storage pool to the copy storage pool by using the BACKUP STGPOOL command. For instructions, see BACKUP STGPOOL (Back up primary storage pool data to a copy storage pool).
3. To ensure that data can be recovered in a disaster, set up a procedure for moving tape volumes from the copy storage pool to an offsite location. For instructions, see Preparing for and recovering from a disaster by using DRM.

### Related reference:

- [CHECKIN LIBVOLUME](#) (Check a storage volume into a library)
- [DEFINE STGPOOL](#) (Define a volume in a storage pool)

## Protecting applications, virtual machines, and systems

---

The server protects data for clients, which can include applications, virtual machines, and systems.

- Adding clients  
Following the successful setup of your IBM Spectrum Protect™ server, install and configure client software to begin backing up data.

## Configuring LAN-free data movement

---

You can configure the IBM Spectrum Protect™ client and server so that the client, through a storage agent, can move data directly to storage on a SAN. This function, called LAN-free data movement, is provided by the IBM Spectrum Protect for SAN product.

### Procedure

---

To configure LAN-free data movement, complete the following steps. For details, see the documentation for IBM Spectrum Protect for SAN.

1. Verify the network connection.
2. Establish communications among the client, storage agent, and the server.
3. Install and configure software on client systems.
4. Configure devices on the server for the storage agent to access.
5. Configure IBM Spectrum Protect policies for LAN-free data movement for the client.
6. If you are using shared FILE storage, install and configure IBM® TotalStorage SAN File System or IBM Spectrum Scale™.

**Windows** Restriction: If an IBM Spectrum Scale volume is formatted by an AIX® server, the Windows system uses TCP/IP to transfer data and not the storage area network.

7. Define paths from the storage agent to drives.
8. Start the storage agent and verify the LAN-free configuration.

## What to do next

---

To help you tune the use of your LAN and SAN resources, you can control the path that data transfers take for clients with the capability of LAN-free data movement. Control the path by using the UPDATE NODE command. For each client, you can select one of the following settings for data read and write operations. Specify data read operations by using the DATAREADPATH parameter and data write operations by using the DATAWRITEPATH parameter. The parameter is optional. The default value is ANY.

### LAN (LAN path only)

Specify the LAN value if either of the following conditions is true:

- You want to back up or restore a small amount of data.
- The client does not have SAN connectivity.

### LANFREE (LAN-free path only)

Specify the LANFREE value if the client and server are on the same SAN, and any of the following conditions are true:

- You want to back up or restore a large amount of data.
- You want to offload the server processing load to the client.
- You want to relieve LAN congestion.

### ANY (Any available path)

A LAN-free path is used if one is available. If a LAN-free path is unavailable, the data is moved by using the LAN.

- Validating your LAN-free configuration  
After you configure an IBM Spectrum Protect client for LAN-free data movement, you can verify the configuration and server definitions by using the VALIDATE LANFREE command.

## Tape encryption methods

---

Deciding on the encryption method to use depends on how you want to manage your data.

It is critical to secure client data, especially when that data is sensitive. To ensure that data in onsite and offsite volumes is protected, IBM tape encryption technology is available.

IBM tape technology supports different methods of drive encryption for the following devices:

- IBM 3592 Generation 2 and Generation 3
- IBM Linear Tape-Open (LTO) Generation 4 and Generation 5

The methods of drive encryption that you can use with IBM Spectrum Protect™ are set up at the hardware level. IBM Spectrum Protect cannot control or change which encryption method is used in the hardware configuration. If the hardware is set up for the Application method, IBM Spectrum Protect can turn encryption on or off depending on the DRIVEENCRYPTION value on the device class.

To encrypt all data in a particular logical library or to encrypt data on more than just storage pool volumes, use the Library or System method. If the encryption key manager is set up to share keys, the Library and System methods can share the encryption key, which allows the two methods to be interchanged. IBM Spectrum Protect cannot share or use encryption keys between the Application method and either the Library or the System methods of encryption.

Table 1. Encryption methods

Encryption method	Description
-------------------	-------------

Encryption method	Description
Application encryption	<p>With application-managed encryption, you can create dedicated storage pools that contain encrypted volumes only. This way, you can use storage pool hierarchies and policies to manage the way data is encrypted.</p> <p>Encryption keys are managed by the application, in this case, IBM Spectrum Protect. IBM Spectrum Protect generates and stores the keys in the server database. Data is encrypted during write operations, when the encryption key is passed from the server to the drive. Data is decrypted for read operations.</p> <p>To encrypt storage pool volumes and eliminate some encryption processing on your system, enable the Application method. Use application-managed encryption only for storage pool volumes. Other volumes, such as backup-set tapes, export volumes, and database backups, are not encrypted by using the Application method.</p> <p>Requirement: When application encryption is enabled, you must take extra care to secure database backups because the encryption keys that are used to encrypt and decrypt data are stored in the server database. To restore your data, you must have the correct database backup and corresponding encryption keys to access your information. Ensure that you back up the database frequently and safeguard the backups to prevent data loss or theft. Anyone who has access to both the database backup and the encryption keys has access to your data.</p>
Library encryption	<p>With library-managed encryption, you can control which volumes are encrypted by using their serial numbers. You can specify a range or set of volumes to encrypt.</p> <p>Encryption keys are managed by the library. Keys are stored in an encryption key manager and provided to the drive. If you set up the hardware to use library-managed encryption, you can use this method by issuing the DEFINE DEVCLASS command and specifying the DRIVEENCRYPTION=ALLOW parameter.</p> <p>Restriction: Only certain IBM libraries support IBM LTO-4 and later encryption. For details, see Configuring tape drive encryption.</p>
System encryption	<p>System-managed encryption is available only on the AIX® operating system. Encryption keys that are provided to the drive are managed by the device driver or operating system and stored in an encryption key manager. If the hardware is set up to use system encryption, you can use this method by issuing the DEFINE DEVCLASS command and specifying the DRIVEENCRYPTION=ALLOW parameter.</p>

To determine whether a volume is encrypted and which method was used, issue the QUERY VOLUME command and specify the FORMAT=DETAILED parameter.

- **Configuring tape drive encryption**  
You can use drive encryption to protect tapes that contain critical or sensitive data, for example, tapes that contain confidential financial information. Drive encryption can be useful when you move tapes from the IBM Spectrum Protect server environment to an onsite or offsite location.

## Controlling tape storage operations

Device class definitions for tapes include parameters that allow you to control storage operations.

- How IBM Spectrum Protect fills volumes  
The DEFINE DEVCLASS command has an optional ESTCAPACITY parameter that indicates the estimated capacity for sequential volumes that are associated with the device class. IBM Spectrum Protect™ uses the estimated capacity of volumes to determine the estimated capacity of a storage pool, and the estimated percent utilized.
- Specifying the estimated capacity of tape volumes  
IBM Spectrum Protect also uses estimated capacity to determine when to begin the reclamation of storage pool volumes.
- Specifying recording formats for tape media  
You can specify the recording format that is used by IBM Spectrum Protect to write data to tape media. If you plan to mix generations of drives, or different drive types, within a library, you must specify a recording format for each drive generation and each drive type. In this way, the server can differentiate between the drive generations and drive types.
- Associating library objects with device classes  
A library contains the drives that can be used to mount the volume. Only one library can be associated with a device class. However, multiple device classes can reference the same library.
- Controlling media-mount operations for tape devices  
By using device class definitions, you can control the number of mounted volumes, the amount of time a volume remains mounted, and the amount of time that the IBM Spectrum Protect server waits for a drive to become available.
- Preempting operations  
The server can preempt server or client operations for a higher priority operation when a mount point is in use and no others are available, or access to a specific volume is required. When an operation is preempted, it is canceled.
- Impacts of device changes on the SAN  
The SAN environment can shift dramatically due to device or cabling changes. The dynamic nature of the SAN can cause static definitions to fail or become unpredictable.
- **Windows** Displaying device information  
You can display information about devices that are connected to the server by using the device information utility (tsmdlst).
- Write-once, read-many tape media  
Write-once, read-many (WORM) media help to prevent accidental or deliberate deletion of critical data. However, IBM Spectrum Protect imposes certain restrictions and guidelines to follow when you use WORM media.
- **Windows** Troubleshooting problems with devices  
You can troubleshoot errors that occur when you configure or use devices with IBM Spectrum Protect.

## How IBM Spectrum Protect fills volumes

---

The DEFINE DEVCLASS command has an optional ESTCAPACITY parameter that indicates the estimated capacity for sequential volumes that are associated with the device class. IBM Spectrum Protect™ uses the estimated capacity of volumes to determine the estimated capacity of a storage pool, and the estimated percent utilized.

If the ESTCAPACITY parameter is not specified, IBM Spectrum Protect uses a default value that is based on the recording format that is specified for the device class by using the FORMAT parameter.

If you specify an estimated capacity that exceeds the actual capacity of the volume in the device class, IBM Spectrum Protect updates the estimated capacity of the volume when the volume becomes full. When IBM Spectrum Protect reaches the end of the volume, it updates the capacity to match the amount that is written to the volume.

You can either accept the default estimated capacity for the device class, or explicitly specify an estimated capacity. An accurate estimated capacity value is not required, but is useful. IBM Spectrum Protect uses the estimated capacity of volumes to determine the estimated capacity of a storage pool, and the estimated percent that is used. You might want to change the estimated capacity if on or both of the following conditions are true:

- The default estimated capacity is inaccurate because of data compression.
- You have volumes of nonstandard size.

### Related reference:

- [DEFINE DEVCLASS \(Define a device class\)](#)
- [UPDATE DEVCLASS \(Update a device class\)](#)

## Specifying the estimated capacity of tape volumes

---

IBM Spectrum Protect™ also uses estimated capacity to determine when to begin the reclamation of storage pool volumes.

## About this task

---

For tape device classes, the default values selected by the server depend on the recording format that is used to write data to the volume. You can either accept the default for a device type or specify a value.

To specify estimated capacity for tape volumes, use the ESTCAPACITY parameter when you define the device class or update its definition.

**Related reference:**

[DEFINE DEVCLASS](#) (Define a device class)

[UPDATE DEVCLASS](#) (Update a device class)

## Specifying recording formats for tape media

---

You can specify the recording format that is used by IBM Spectrum Protect™ to write data to tape media. If you plan to mix generations of drives, or different drive types, within a library, you must specify a recording format for each drive generation and each drive type. In this way, the server can differentiate between the drive generations and drive types.

## About this task

---

To specify a recording format, use the FORMAT parameter when you define the device class or update its definition.

If all drives associated with that device class are identical, specify FORMAT=DRIVE. The server selects the highest format that is supported by the drive on which a volume is mounted.

If some drives associated with the device class support a higher density format than others, specify a format that is compatible with all drives.

If drives in a single SCSI library use different tape technologies (for example, DLT and LTO Ultrium), specify a unique value for the FORMAT parameter in each device class definition.

For a configuration example, see Example: Configure a SCSI or virtual tape library with multiple drive device types.

The recording format that the server uses for a volume is selected when data is first written to the volume. Updating the FORMAT parameter does not affect media that already contain data until those media are rewritten from the beginning. This process might happen after a volume is reclaimed or deleted, or after all of the data on the volume expires.

**Related reference:**

[DEFINE DEVCLASS](#) (Define a device class)

[UPDATE DEVCLASS](#) (Update a device class)

## Associating library objects with device classes

---

A library contains the drives that can be used to mount the volume. Only one library can be associated with a device class. However, multiple device classes can reference the same library.

## About this task

---

To associate a device class with a library, use the LIBRARY parameter when you define a device class or update its definition.

**Related reference:**

[DEFINE DEVCLASS](#) (Define a device class)

[UPDATE DEVCLASS](#) (Update a device class)

## Controlling media-mount operations for tape devices

---

By using device class definitions, you can control the number of mounted volumes, the amount of time a volume remains mounted, and the amount of time that the IBM Spectrum Protect™ server waits for a drive to become available.

- Controlling the number of simultaneously mounted volumes  
When you set a mount limit for a device class, you must consider the number of storage devices that are connected to your



system. You must also consider whether you use the simultaneous-write function, whether you associate multiple device classes with a single library, and the number of processes that run at the same time.

- Controlling the amount of time that a volume remains mounted  
You can control the amount of time that a mounted volume remains mounted after its last I/O activity. If a volume is used frequently, you can improve performance by setting a longer mount retention period to avoid unnecessary mount and dismount operations.
- Controlling the amount of time that the server waits for a drive  
You can specify the maximum amount of time, in minutes, that the IBM Spectrum Protect server waits for a drive to become available for the current mount request.

## Controlling the number of simultaneously mounted volumes

---

When you set a mount limit for a device class, you must consider the number of storage devices that are connected to your system. You must also consider whether you use the simultaneous-write function, whether you associate multiple device classes with a single library, and the number of processes that run at the same time.

### About this task

---

When you select a mount limit for a device class, consider the following issues:

- How many storage devices are connected to your system?

Do not specify a mount limit value that is greater than the number of associated available drives in your installation. If the server tries to mount as many volumes as specified by the mount limit and no drives are available for the required volume, an error occurs and client sessions might end. (This restriction does not apply when the DRIVES parameter is specified.)

If you are sharing library resources on a SAN among IBM Spectrum Protect™ servers, you must limit the number of tape drives that a library client can use at a time. To allow multiple library client servers use a library simultaneously specify the MOUNTLIMIT parameter when you define or update the device class on the library client. For more information about configuring library sharing, see [Configuring library sharing](#).

- Are you using the simultaneous-write function to primary storage pools, copy storage pools, and active-data pools?

Specify a mount limit value that provides enough mount points to support writing data simultaneously to the primary storage pool and all associated copy storage pools and active-data pools.

- Are you associating multiple device classes with a single library?

A device class that is associated with a library can use any drive in the library that is compatible with the device class' device type. Because you can associate more than one device class with a library, a single drive in the library can be used by more than one device class. IBM Spectrum Protect ensures that two operations cannot use the same drive simultaneously by using two different device classes.

- How many IBM Spectrum Protect processes do you want to run at the same time, by using devices in this device class?

IBM Spectrum Protect automatically cancels some processes to run other, higher priority processes. If the server is using all available drives in a device class to complete higher priority processes, lower-priority processes must wait until a drive becomes available. For example, IBM Spectrum Protect cancels the process for a client that backs up directly to tape if the drive is needed for a server migration or tape reclamation process. IBM Spectrum Protect cancels a tape reclamation process if the drive is needed for a client restore operation. For more information, see [Preempting operations](#).

If processes are often canceled by other processes, consider whether you can make more drives available for IBM Spectrum Protect use. Otherwise, review your scheduling of operations to reduce the contention for drives.

This consideration also applies to the simultaneous-write function. You must have enough drives available to allow for a successful simultaneous-write operation.

To specify the maximum number of volumes that can be simultaneously mounted, use the MOUNTLIMIT parameter when you define the device class or update its definition.

#### Related reference:

[DEFINE DEVCLASS](#) (Define a device class)

[UPDATE DEVCLASS](#) (Update a device class)

## Controlling the amount of time that a volume remains mounted

---

You can control the amount of time that a mounted volume remains mounted after its last I/O activity. If a volume is used frequently, you can improve performance by setting a longer mount retention period to avoid unnecessary mount and dismount operations.

### About this task

---

If mount operations are being handled by manual, operator-assisted activities, you might want to specify a long mount retention period. For example, if only one operator supports your entire operation on a weekend, then define a long mount retention period so that the operator is not being asked to mount volumes every few minutes.

To control the amount of time a mounted volume remains mounted, use the MOUNTRETENTION parameter when you define the device class or update its definition. For example, if the mount retention value is 60, and a mounted volume remains idle for 60 minutes, the server dismounts the volume.

While IBM Spectrum Protect™ has a volume mounted, the drive is allocated to IBM Spectrum Protect and cannot be used for anything else. If you need to free the drive for other uses, you can cancel IBM Spectrum Protect operations that are using the drive and then dismount the volume. For example, you can cancel server migration or backup operations. For information on how to cancel processes and dismount volumes, see [Managing server requests for volumes](#)

#### Related reference:

[DEFINE DEVCLASS](#) (Define a device class)

[UPDATE DEVCLASS](#) (Update a device class)

## Controlling the amount of time that the server waits for a drive

---

You can specify the maximum amount of time, in minutes, that the IBM Spectrum Protect™ server waits for a drive to become available for the current mount request.

### About this task

---

To control the wait time for a drive to become available for a mount request, use the MOUNTWAIT parameter when you define or update a device class.

#### Related reference:

[DEFINE DEVCLASS](#) (Define a device class)

[UPDATE DEVCLASS](#) (Update a device class)

## Preempting operations

---

The server can preempt server or client operations for a higher priority operation when a mount point is in use and no others are available, or access to a specific volume is required. When an operation is preempted, it is canceled.

You can use the QUERY MOUNT command to see the status of the volume for the mount point.

By default, preemption is enabled on the server. To disable preemption, specify the NOPREEMPT option in the server options file. If you specify this option, the BACKUP DB command, and the export and import commands are the only operations that can preempt other operations.

- Mount point preemption  
If a high-priority operation requires a mount point that is in a specific device class and all the mount points in the device class are in use, the high-priority operation can preempt a mount point from a lower-priority operation.
- Volume access preemption  
If a high-priority operation requires access to a specific volume and that volume is in use, the high-priority operation can preempt the lower-priority operation for that volume.

#### Related reference:

[BACKUP DB](#) (Back up the database)

[QUERY MOUNT](#) (Display information on mounted sequential access volumes)

## Mount point preemption

---

If a high-priority operation requires a mount point that is in a specific device class and all the mount points in the device class are in use, the high-priority operation can preempt a mount point from a lower-priority operation.

Mount points can be preempted only when the device class of the operation preempting and the operation that is being preempted is the same.

The following high-priority operations can preempt other operations for a mount point.

- Database backup operations
- Retrieve, restore, or HSM recall operations that are initiated by clients
- Restore operations by using a remote data mover
- Export operations
- Import operations
- Operations to generate backup sets

The following server operations cannot preempt other operations or be preempted:

- Audit a volume
- Restore data from a copy or active-data pool
- Prepare a recovery plan file
- Store data by using a remote data mover

The following operations can be preempted and are listed in order of priority, from highest priority to lowest priority. The server selects the lowest priority operation to preempt, for example, identify duplicates.

- Replicate nodes
- Back up data to a copy storage pool
- Copy active data to an active data pool
- Move data on a storage pool volume
- Migrate data from disk to sequential media
- Migrate data from sequential media to sequential media
- Back up, archive, or HSM migrate operations that are initiated by clients
- Reclaim volumes in a sequential-access storage pool
- Identify duplicates

## Volume access preemption

---

If a high-priority operation requires access to a specific volume and that volume is in use, the high-priority operation can preempt the lower-priority operation for that volume.

For example, if a restore request requires access to a volume in use by a reclamation operation and a drive is available, the reclamation operation is canceled.

The following high-priority operations can preempt operations for access to a specific volume:

- Database backup operations
- Retrieve, restore, or HSM recall operations that are initiated by clients
- Restore operations by using a remote data mover
- Export operations
- Import operations
- Operations to generate backup sets

The following operations cannot preempt other operations or be preempted:

- Audit volume
- Restore data from a copy or active-data pool
- Prepare a recovery plan
- Store data by using a remote data mover

The following operations can be preempted, and are listed in order of priority, from highest priority to lowest priority. The server selects the lowest priority operation to preempt, for example, identify duplicates.

- Replicate nodes
- Back up data to a copy storage pool
- Copy active data to an active data pool
- Move data on a storage pool volume
- Migrate data from disk to sequential media
- Migrate data from sequential media to sequential media
- Back up, archive, or HSM migrate data that is initiated by client
- Reclaim volumes in a sequential-access storage pool
- Identify duplicates

## Impacts of device changes on the SAN

---

The SAN environment can shift dramatically due to device or cabling changes. The dynamic nature of the SAN can cause static definitions to fail or become unpredictable.

Device IDs that are assigned by the SAN and known to the server or storage agent can be altered due to bus resets or other environmental changes. For example, the server might know a device X as *rmt0* (on AIX®), based on the original path specification to the server and original configuration of the LAN. However, some event in the SAN, for example, the addition of new device Y, causes device X to be assigned *rmt1*. When the server tries to access device X by using *rmt0*, either the access fails or the wrong target device is accessed. The server attempts to recover from changes to devices on the SAN by using device serial numbers to confirm the identity of devices it contacts.

When you define a drive or library, you have the option of specifying the serial number for that device. If you do not specify the serial number when you define the device, the server obtains the serial number when you define the path for the device. In either case, the server then has the device serial number in its database and can use it to confirm the identity of a device for operations.

When the server uses drives and libraries on a SAN, the server attempts to verify that the correct device is used. The server contacts the device by using the device name in the path that you defined for it. The server then requests the serial number from the device, and compares that serial number with the serial number that is stored in the server database for that device.

If the serial number does not match, the server begins the process of discovery on the SAN, attempting to find the device with the matching serial number. If the server finds the device with the matching serial number, it corrects the definition of the path in the server's database by updating the device name in that path. The server issues a message with information about the change that is made to the device. Then, the server proceeds to use the device.

To determine when device changes on the SAN affect the IBM Spectrum Protect™ server, you can monitor the activity log for messages. The following messages are related to serial numbers:

- ANR8952 through ANR8958
- ANR8961 through ANR8968
- ANR8974 through ANR8975

Restriction: Some devices cannot report their serial numbers to applications such as the IBM Spectrum Protect server. If the server cannot obtain the serial number from a device, the server cannot help the system to recover from a device location change on the SAN.

Windows

## Displaying device information

---

You can display information about devices that are connected to the server by using the device information utility (tsmdlst).

### Before you begin

---

- Ensure that the HBA API is installed. The HBA API is required to run the device information utility.
- Ensure that the tape device driver is installed and configured.

### Procedure

---

1. From a command prompt, change to the `server` subdirectory of the server installation directory, for example, `C:\Program Files\Tivoli\TSM\server`.
2. Run the `tsmdlst.exe` executable file.

**Related reference:**

[QUERY SAN](#) (Query the devices on the SAN)

[tsmdlst](#) (Display information about devices)

## Write-once, read-many tape media

---

Write-once, read-many (WORM) media help to prevent accidental or deliberate deletion of critical data. However, IBM Spectrum Protect™ imposes certain restrictions and guidelines to follow when you use WORM media.

You can use the following types of WORM media with IBM Spectrum Protect:

- IBM® 3592, all supported generations
- IBM LTO-3 and all supported generations
- HP LTO-3 and all supported generations
- Quantum LTO-3 and all supported generations
- Quantum SDLT 600, Quantum DLT V4, and Quantum DLT S4
- StorageTek VolSafe
- Sony AIT50 and AIT100

Tips:

- A storage pool can consist of either WORM or RW media, but not both.
- To avoid wasting tape after a restore or import operation, do not use WORM tapes for database backup or export operations.
- WORM-capable drives  
To use WORM media in a library, all the drives in the library must be WORM-capable. A mount will fail if a WORM cartridge is mounted in a read/write (RW) drive.
- Check-in of WORM media  
The type of WORM media determines whether the media label needs to be read during check-in.
- Restrictions on WORM media  
You cannot use pre-labeled WORM media with the LTO or ECARTRIDGE device class.
- Mount failures with WORM media  
If WORM tape media are loaded into a drive for a read-write (RW) device-class mount, it will cause a mount failure. Similarly, if RW tape media are loaded into a drive for a WORM device-class mount, the mount will fail.
- Relabeling WORM media  
You cannot relabel a WORM cartridge if it contains data. This applies to Sony AIT WORM, LTO WORM, SDLT WORM, DLT WORM, and IBM 3592 cartridges. The label on a VolSafe volume should be overwritten only once and only if the volume does not contain usable, deleted, or expired data.
- Removing private WORM volumes from a library  
If you perform an action on a WORM volume (for example, if you delete file spaces) and the server does not mark the volume as full, the volume is returned to scratch status. If a WORM volume is not marked as full and you delete it from a storage pool, the volume remains private. To remove a private WORM volume from a library, you must issue the CHECKOUT LIBVOLUME command.
- Creation of DLT WORM volumes  
DLT WORM volumes can be converted from read/write (RW) volumes.
- Support for short and normal 3592 WORM tapes  
IBM Spectrum Protect supports both short and normal 3592 WORM tapes. For best results, define them in separate storage pools
- Querying a device class for the WORM-parameter setting  
You can determine the setting of the WORM parameter for a device class by using the QUERY DEVCLASS command. The output contains a field, labeled WORM, and a value (YES or NO).

## WORM-capable drives

---

To use WORM media in a library, all the drives in the library must be WORM-capable. A mount will fail if a WORM cartridge is mounted in a read/write (RW) drive.

However, a WORM-capable drive can be used as a RW drive if the WORM parameter in the device class is set to NO. Any type of library can have both WORM and RW media if *all* of the drives are WORM enabled. The only exception to this rule is NAS-attached libraries in which WORM tape media cannot be used.

**Related reference:**

- [DEFINE DEVCLASS](#) (Define a device class)
- [UPDATE DEVCLASS](#) (Update a device class)

## Check-in of WORM media

---

The type of WORM media determines whether the media label needs to be read during check-in.

Library changers cannot identify the difference between standard read/write (RW) tape media and the following types of WORM tape media:

- VolSafe
- Sony AIT
- LTO
- SDLT
- DLT

To determine the type of WORM media that is being used, a volume must be loaded into a drive. Therefore, when you check in one of these types of WORM volumes, you must use the CHECKLABEL=YES option on the CHECKIN LIBVOLUME command.

If they provide support for WORM media, IBM® 3592 library changers can detect whether a volume is WORM media without loading the volume into a drive. Specifying CHECKLABEL=YES is not required. Verify with your hardware vendors that your 3592 drives and libraries provide the required support.

**Related reference:**

- [CHECKIN LIBVOLUME](#) (Check a storage volume into a library)

## Restrictions on WORM media

---

You cannot use pre-labeled WORM media with the LTO or ECARTRIDGE device class.

You cannot use WORM media with IBM Spectrum Protect™ specified as the drive-encryption key manager for the following drives:

- IBM® LTO-5, LTO-6, and later
- HP LTO-5, LTO-6, and later
- Oracle StorageTek T10000B
- Oracle StorageTek T10000C
- Oracle StorageTek T10000D

## Mount failures with WORM media

---

If WORM tape media are loaded into a drive for a read-write (RW) device-class mount, it will cause a mount failure. Similarly, if RW tape media are loaded into a drive for a WORM device-class mount, the mount will fail.

## Relabeling WORM media

---

You cannot relabel a WORM cartridge if it contains data. This applies to Sony AIT WORM, LTO WORM, SDLT WORM, DLT WORM, and IBM® 3592 cartridges. The label on a VolSafe volume should be overwritten only once and only if the volume does not contain usable, deleted, or expired data.

Issue the LABEL LIBVOLUME command only once for VolSafe volumes. You can guard against overwriting the label by using the OVERWRITE=NO option on the LABEL LIBVOLUME command.

**Related reference:**

- [LABEL LIBVOLUME](#) (Label a library volume)

## Removing private WORM volumes from a library

---

If you perform an action on a WORM volume (for example, if you delete file spaces) and the server does not mark the volume as full, the volume is returned to scratch status. If a WORM volume is not marked as full and you delete it from a storage pool, the

volume remains private. To remove a private WORM volume from a library, you must issue the CHECKOUT LIBVOLUME command.

**Related reference:**

[CHECKOUT LIBVOLUME](#) (Check a storage volume out of a library)

## Creation of DLT WORM volumes

DLT WORM volumes can be converted from read/write (RW) volumes.

If you have SDLT-600, DLT-V4, or DLT-S4 drives and you want to enable them for WORM media, upgrade the drives by using V30 or later firmware available from Quantum. You can also use DLTIce software to convert unformatted RW volumes or blank volumes to WORM volumes.

In SCSI libraries, the IBM Spectrum Protect™ server creates scratch DLT WORM volumes automatically when the server cannot locate any scratch WORM volumes in a library's inventory. The server converts available unformatted or blank RW scratch volumes or empty RW private volumes to scratch WORM volumes. The server also rewrites labels on newly created WORM volumes by using the label information on the existing RW volumes.

## Support for short and normal 3592 WORM tapes

IBM Spectrum Protect™ supports both short and normal 3592 WORM tapes. For best results, define them in separate storage pools

## Querying a device class for the WORM-parameter setting

You can determine the setting of the WORM parameter for a device class by using the QUERY DEVCLASS command. The output contains a field, labeled WORM, and a value (YES or NO).

**Related reference:**

[QUERY DEVCLASS](#) (Display information on one or more device classes)

Windows

## Troubleshooting problems with devices

You can troubleshoot errors that occur when you configure or use devices with IBM Spectrum Protect™.

### About this task

Use Table 1 to find a solution to the device-related problem.

Table 1. Resolving device problems

Symptom	Problem	Solution
Conflicts with other applications.	IBM Spectrum Protect requires a storage area network to share devices.	Set up a storage area network. Attention: Data loss can occur if multiple IBM Spectrum Protect servers use the same device. Define or use a device with only one IBM Spectrum Protect server.  AIX   Linux Other applications can access IBM Spectrum Protect devices, by using a SCSI tape driver.
Labeling fails.	A device for labeling volumes cannot be used at the same time that the server uses the device for other processes.	You cannot overwrite existing volumes in a storage pool.  You must resolve any hardware issues before you label a volume.
	Incorrect or incomplete license registration.	Register the license for the device support that was purchased.

Symptom	Problem	Solution
Conflicts among device drivers.	IBM Spectrum Protect issues messages about I/O errors when you define or use a sequential access device.	Windows device drivers and drivers that are provided by other applications can interfere with the IBM Spectrum Protect device driver if the IBM Spectrum Protect driver is not started first. To check on the order that device drivers are started by the system, complete the following steps: <ol style="list-style-type: none"> <li>1. Click Control Panel.</li> <li>2. Click Devices. Device drivers and their startup types are listed.</li> </ol>
I/O errors	When you try to define or use a tape device, there might be device-driver conflicts. Windows device drivers and drivers that are provided by other applications can interfere with the IBM Spectrum Protect device driver if it is not started first.	

## Completing the implementation

After the IBM Spectrum Protect™ solution is configured and running, test backup operations and set up monitoring to ensure that everything runs smoothly.

### Procedure

1. Test backup operations to verify that your data is protected in the way that you expect.
  - a. On the Clients page of the Operations Center, select the clients that you want to back up, and click Back Up.
  - b. On the Servers page of the Operations Center, select the server for which you want to back up the database. Click Back Up, and follow the instructions in the Back Up Database window.
  - c. Verify that the backup operations completed successfully with no warning or error messages.  
Tip: Alternatively, you can use the backup-archive client GUI to back up client data and you can backup the server database by issuing BACKUP DB command from an administrative command-line.
2. Set up monitoring for your solution by following the instructions in Monitoring a tape solution.

## Monitoring a tape solution

After you implement an IBM Spectrum Protect™ tape-based solution, monitor the solution to ensure correct operation. By monitoring the solution daily and periodically, you can identify existing and potential issues. The information that you gather can be used to troubleshoot problems and optimize system performance.

### About this task

The preferred way to monitor a solution is by using the Operations Center, which provides overall and detailed system status in a graphical user interface. In addition, you can configure the Operations Center to generate email reports that summarize system status.

### Procedure

1. Complete daily monitoring tasks. For instructions, see Daily monitoring checklist.
2. Complete periodic monitoring tasks. For instructions, see Periodic monitoring checklist.
3. Verify that your system complies with licensing requirements. For instructions, see Verifying license compliance.
4. Optional: Set up email reports of system status. For instructions, see Tracking system status by using email reports

## Daily monitoring checklist



To ensure that you are completing the daily monitoring tasks for your IBM Spectrum Protect™ solution, review the daily monitoring checklist.

Complete the daily monitoring tasks from the Operations Center Overview page. You can access the Overview page by opening the Operations Center and clicking Overviews.

The following figure shows the location for completing each task.

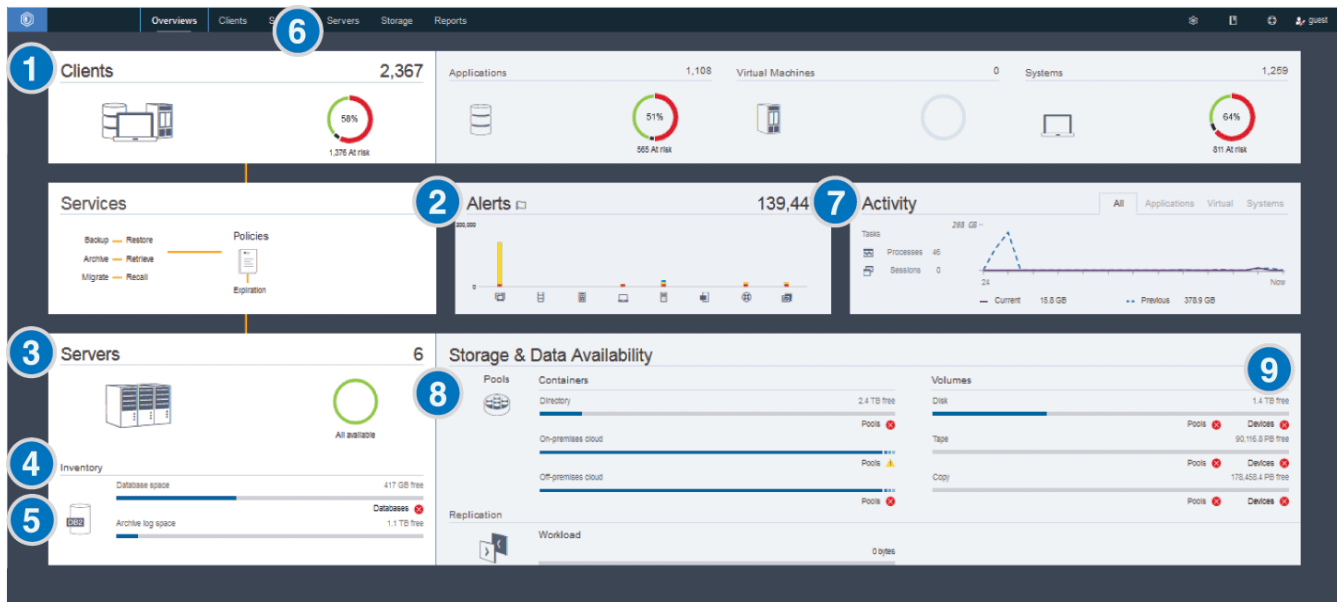







Tip: To run administrative commands for advanced monitoring tasks, use the Operations Center command builder. The command builder provides a type-ahead function to guide you as you enter commands. To open the command builder, go to the Operations Center Overview page. On the menu bar, hover over the settings icon  and click Command Builder.





The following table lists the daily monitoring tasks and provides instructions for completing each task.

Table 1. Daily monitoring tasks

Task	Basic procedures	Advanced procedures and troubleshooting information
<p><b>1</b> Determine whether clients are at risk of being unprotected due to failed or missed backup operations.</p>	<p>To verify whether clients are at risk, in the Clients area, look for an At risk notification. To view details, click the Clients area.</p> <p>If you installed the client management service on a backup-archive client, you can view and analyze the client error and schedule logs by completing the following steps:</p> <ol style="list-style-type: none"> <li>1. In the Clients table, select the client and click Details.</li> <li>2. To diagnose an issue, click Diagnosis.</li> </ol>	<p>For clients that do not have the client management service installed, access the client system to review the client error logs.</p>
<p><b>2</b> Determine whether client-related or server-related errors require attention.</p>	<p>To determine the severity of any reported alerts, in the Alerts area, hover over the columns.</p>	<p>To view additional information about alerts, complete the following steps:</p> <ol style="list-style-type: none"> <li>1. Click the Alerts area.</li> <li>2. In the Alerts table, select an alert.</li> <li>3. In the Activity Log pane, review the messages. The pane displays related messages that were issued before and after the selected alert occurred.</li> </ol>

Task	Basic procedures	Advanced procedures and troubleshooting information
<p><b>3</b> Determine whether servers that are managed by the Operations Center are available to provide data protection services to clients.</p>	<ol style="list-style-type: none"> <li>1. To verify whether servers are at risk, in the Servers area, look for an Unavailable notification.</li> <li>2. To view additional information, click the Servers area.</li> <li>3. Select a server in the Servers table and click Details.</li> </ol>	<p>Tip: If you detect an issue that is related to server properties, update the server properties:</p> <ol style="list-style-type: none"> <li>1. In the Servers table, select a server and click Details.</li> <li>2. To update server properties, click Properties.</li> </ol>
<p><b>4</b> Determine whether sufficient space is available for the server inventory, which consists of the server database, active log, and archive log.</p>	<ol style="list-style-type: none"> <li>1. Click the Servers area.</li> <li>2. In the Status column of the table, view the status of the server and resolve any issues: <ul style="list-style-type: none"> <li>o Normal  Sufficient space is available for the server database, active log, and archive log.</li> <li>o Critical  Insufficient space is available for the server database, active log, or archive log. You must add space immediately, or the data protection services that are provided by the server will be interrupted.</li> <li>o Warning  The server database, active log, or archive log is running out of space. If this condition persists, you must add space.</li> <li>o Unavailable  Status cannot be obtained. Ensure that the server is running, and that there are no network issues. This status is also shown if the monitoring administrator ID is locked or otherwise unavailable on the server. This ID is named IBM-OC-hub_server_name.</li> <li>o Unmonitored  Unmonitored servers are defined to the hub server, but are not configured for management by the Operations Center. To configure an unmonitored server, select the server, and click Monitor Spoke.</li> </ul> </li> </ol>	<p>You can also look for related alerts on the Alerts page. For additional instructions about troubleshooting, see Resolving server problems.</p>

Task	Basic procedures	Advanced procedures and troubleshooting information
<p><b>5</b> Verify server database backup operations.</p>	<p>To determine when a server was most recently backed up, complete the following steps:</p> <ol style="list-style-type: none"> <li>1. Click the Servers area.</li> <li>2. In the Servers table, review the Last Database Backup column.</li> </ol>	<p>To obtain more detailed information about backup operations, complete the following steps:</p> <ol style="list-style-type: none"> <li>1. In the Servers table, select a row and click Details.</li> <li>2. In the DB Backup area, hover over the check marks to review information about backup operations.</li> </ol> <p>If a database was not backed up recently (for example, in the last 24 hours), you can start a backup operation:</p> <ol style="list-style-type: none"> <li>1. On the Operations Center Overview page, click the Servers area.</li> <li>2. In the table, select a server and click Back Up.</li> </ol> <p>To determine whether the server database is configured for automatic backup operations, complete the following steps:</p> <ol style="list-style-type: none"> <li>1. On the menu bar, hover over the settings icon  and click Command Builder.</li> <li>2. Issue the QUERY DB command: <pre>query db f=d</pre> </li> <li>3. In the output, review the Full Device Class Name field. If a device class is specified, the server is configured for automatic database backups.</li> </ol>
<p><b>6</b> Monitor other server maintenance tasks. Server maintenance tasks can include running administrative command schedules, maintenance scripts, and related commands.</p>	<p>To search for information about processes that failed because of server issues, complete the following steps:</p> <ol style="list-style-type: none"> <li>1. Click Servers &gt; Maintenance.</li> <li>2. To obtain the two-week history of a process, view the History column.</li> <li>3. To obtain more information about a scheduled process, hover over the check box that is associated with the process.</li> </ol>	<p>For more information about monitoring processes and resolving issues, see the Operations Center online help.</p>
<p><b>7</b> Verify that the amount of data that was recently sent to and from servers is within the expected range.</p>	<ul style="list-style-type: none"> <li>• To obtain an overview of activity in the last 24 hours, view the Activity area.</li> <li>• To compare activity in the last 24 hours with activity in the previous 24 hours, review the figures in the Current and Previous areas.</li> </ul>	<ul style="list-style-type: none"> <li>• If more data was sent to the server than you expected, determine which clients are backing up more data and investigate the cause. It is possible that client-side data deduplication is not working correctly.</li> <li>• If less data was sent to the server than you expected, investigate whether client backup operations are proceeding on schedule.</li> </ul>

Task	Basic procedures	Advanced procedures and troubleshooting information
<p>8 Verify that storage pools are available to back up client data.</p>	<ol style="list-style-type: none"> <li>If problems are indicated in the Storage &amp; Data Availability area, click Pools to view the details: <ul style="list-style-type: none"> <li>If the Critical  status is displayed, insufficient space is available in the storage pool, or its access status is unavailable.</li> <li>If the Warning  status is displayed, the storage pool is running out of space, or its access status is read-only.</li> </ul> </li> <li>To view the used, free, and total space for your selected storage pool, hover over the entries in the Capacity Used column.</li> </ol>	<p>To view the storage-pool capacity that was used over the past two weeks, select a row in the Storage Pools table and click Details.</p>
<p>9 Verify that storage devices are available for backup operations.</p>	<p>In the Storage &amp; Data Availability area, in the Volumes section, under the capacity bars, review the status that is reported next to Devices. If a Critical  or Warning  status is displayed for any device, investigate the issue. To view details, click Devices.</p>	<p>Tape devices might have a warning or critical status if drives are unavailable. A drive is unavailable if it is offline, if it stopped responding to the server, or if its path is offline. A tape device might also have a critical status if the library is offline. Other columns of the Tape Devices table show the state of the library robotics, drives, and paths.</p> <p>To resolve issues with tape drives that have a critical state, you can take the drive offline if you need to use it for another activity, such as maintenance. To take a drive offline, complete the following steps:</p> <ol style="list-style-type: none"> <li>On the Operations CenterStorage page, and select Tape Devices.</li> <li>To view more information about a tape library, select a row and click Details.</li> <li>To take a drive offline, select the tape drive and click Offline.</li> </ol> <p>For tape backup operations, verify that sufficient scratch tapes are available. If you are not certain whether the number of available scratch tapes is sufficient, open the details notebook to view tape usage and an estimate of scratch tape availability. To open the details notebook, select a library in the table and click Details.</p>

## Periodic monitoring checklist

To help ensure that operations run correctly, complete the tasks in the periodic monitoring checklist. Schedule periodic tasks frequently enough so that you can detect potential issues before they become problematic.

Tip: To run administrative commands for advanced monitoring tasks, use the Operations Center command builder. The command builder provides a type-ahead function to guide you as you enter commands. To open the command builder, go to the Operations Center Overview page. On the menu bar, hover over the settings icon  and click Command Builder.

Table 1. Periodic monitoring tasks

Task	Basic procedures	Advanced procedures and troubleshooting
------	------------------	---

Task	Basic procedures	Advanced procedures and troubleshooting
Monitor system performance.	<p>Determine the length of time that is required for client backup operations:</p> <ol style="list-style-type: none"> <li>1. On the Operations Center Overview page, click Clients. Find the server that is associated with the client.</li> <li>2. Click Servers. Select the server and click Details.</li> <li>3. To view the duration of completed tasks in the last 24 hours, click Completed Tasks.</li> <li>4. To view the duration of tasks that were completed more than 24 hours ago, use the QUERY ACTLOG command. For information about this command, see QUERY ACTLOG (Query the activity log).</li> <li>5. If the duration of client backup operations is increasing and the reasons are not clear, investigate the cause.</li> </ol> <p>If you installed the client management service on a backup-archive client, you can diagnose performance issues for the backup-archive client by completing the following steps:</p> <ol style="list-style-type: none"> <li>1. On the Operations Center Overview page, click Clients.</li> <li>2. Select a backup-archive client and click Details.</li> <li>3. To retrieve client logs, click Diagnosis.</li> </ol>	<p>Limit the time for client backup operations to 8 - 12 hours. Ensure that client schedules do not overlap with server maintenance tasks.</p> <p>For instructions about reducing the time that it takes for the client to back up data to the server, see Resolving common client performance problems.</p> <p>Look for performance bottlenecks. For instructions, see Identifying performance bottlenecks.</p> <p>For information about identifying and resolving other performance issues, see Performance.</p>

Task	Basic procedures	Advanced procedures and troubleshooting
<p>Verify that current backup files for device configuration and volume history information are saved.</p>	<p>Access your storage locations to ensure that the files are available. The preferred method is to save the backup files to two locations.</p> <p>To locate the volume history and device configuration files, complete the following steps:</p> <ol style="list-style-type: none"> <li>1. On the Operations Center Overview page, hover over the settings icon and click Command Builder.</li> <li>2. To locate the volume history and device configuration files, issue the following commands: <ul style="list-style-type: none"> <li><code>query option volhistory</code></li> <li><code>query option devconfig</code></li> </ul> </li> <li>3. In the output, review the Option Setting column to find the file locations.</li> </ol> <p>If a disaster occurs, both the volume history file and the device configuration file are required to restore the server database.</p>	

Task	Basic procedures	Advanced procedures and troubleshooting
<p>Determine whether sufficient space is available in the directory for the server instance.</p>	<p>Verify that at least 50 GB of free space is available in the directory for the server instance. Take the action that is appropriate for your operating system:</p> <ul style="list-style-type: none"> <li> <p><b>AIX</b> To view available space in the file system, on the operating system command line, issue the following command:</p> <pre>df -g instance_directory</pre> <p>where <i>instance_directory</i> specifies the instance directory.</p> </li> <li> <p><b>Linux</b> To view available space in the file system, on the operating system command line, issue the following command:</p> <pre>df -h instance_directory</pre> <p>where <i>instance_directory</i> specifies the instance directory.</p> </li> <li> <p><b>Windows</b> In the Windows Explorer program, right-click the file system and click Properties. View the capacity information.</p> </li> </ul> <p>The preferred location of the instance directory depends on the operating system where the server is installed:</p> <ul style="list-style-type: none"> <li> <p><b>AIX</b>   <b>Linux</b> /home/tsminst1/tsminst1</p> </li> <li> <p><b>Windows</b> C:\tsminst1</p> </li> </ul> <p>Tip: If you completed a planning worksheet, the location of the instance directory is recorded in the worksheet.</p>	
<p>Identify unexpected client activity.</p>	<p>To monitor client activity to determine whether data volumes exceed expected amounts, complete the following steps:</p> <ol style="list-style-type: none"> <li>1. On the Operations Center Overview page, click the Clients area.</li> <li>2. To view activity over the past two weeks, double-click any client.</li> <li>3. To view the number of bytes sent to the client, click the Properties tab.</li> <li>4. In the Last Session area, view the Sent to client row.</li> </ol>	<p>When you double-click a client in the Clients table, the Activity over 2 Weeks area displays the amount of data that the client sent to the server each day.</p>

Task	Basic procedures	Advanced procedures and troubleshooting
<p>Monitor storage pool growth over time.</p>	<ol style="list-style-type: none"> <li>1. On the Operations Center Overview page, click the Pools area.</li> <li>2. To view the capacity that was used over the last two weeks, select a pool and click Details.</li> </ol>	<p>Tips:</p> <ul style="list-style-type: none"> <li>• To specify the time period that must elapse before all deduplicated extents are removed from a directory-container storage pool or cloud-container storage pool after they are no longer referenced by the inventory, complete the following steps: <ol style="list-style-type: none"> <li>1. On the Storage Pools page of the Operations Center, select the storage pool.</li> <li>2. Click Details &gt; Properties.</li> <li>3. Specify the duration in the <code>Delay period for container reuse</code> field.</li> </ol> </li> <li>• To determine data deduplication performance for directory-container and cloud-container storage pools, use the <code>GENERATE DEDUPSTATS</code> command.</li> <li>• To view data deduplication statistics for a storage pool, complete the following steps: <ol style="list-style-type: none"> <li>1. On the Storage Pools page of the Operations Center, select the storage pool.</li> <li>2. Click Details &gt; Properties.</li> </ol> <p>Alternatively, use the <code>QUERY EXTENTUPDATES</code> command to display information about updates to data extents in directory-container or cloud-container storage pools. The command output can help you determine which data extents are no longer referenced and which ones are eligible to be deleted from the system. In the output, monitor the number of data extents that are eligible to be deleted from the system. This metric has a direct correlation to the amount of free space that is available within the container storage pool.</p> </li> <li>• To display the amount of physical space that is occupied by a file space after the removal of the data deduplication savings, use the <code>select * from occupancy</code> command. The command output includes the <code>LOGICAL_MB</code> value. <code>LOGICAL_MB</code> is the amount of space that is used by the file space.</li> </ul>
<p>Monitor and maintain tape devices.</p>	<p>Monitor your environment for hardware errors on tape drives and tape libraries. For instructions, see <a href="#">Monitoring tape alert messages for hardware errors</a>.</p> <p>Monitor media compatibility to prevent errors on tape drives. For instructions, see <a href="#">Preventing errors caused by media incompatibility</a>.</p> <p>Monitor cleaning messages for tape drives. For instructions, see <a href="#">Operations with cleaner cartridges</a>.</p>	



Task	Basic procedures	Advanced procedures and troubleshooting
Evaluate the timing of client schedules. Ensure that the start and end times of client schedules do not overlap with server maintenance tasks. Limit the time for client backup operations to 8 - 12 hours.	<p>On the Operations Center Overview page, click Clients &gt; Schedules.</p> <p>In the Schedules table, the Start column displays the configured start time for the scheduled operation. To see when the most recent operation was started, hover over the clock icon.</p>	<p>Tip: You can receive a warning message if a client operation runs longer than expected. Complete the following steps:</p> <ol style="list-style-type: none"> <li>1. On the Operations Center Overview page, hover over Clients and click Schedules.</li> <li>2. Select a schedule and click Details.</li> <li>3. View the details of a schedule by clicking the blue arrow next to the row.</li> <li>4. In the Run time alert field, specify the time when a warning message will be issued if the scheduled operation is not completed.</li> <li>5. Click Save.</li> </ol>
Evaluate the timing of maintenance tasks. Ensure that the start and end times of maintenance tasks do not overlap with client schedules.	<p>On the Operations Center Overview page, click Servers &gt; Maintenance.</p> <p>In the Maintenance table, review the information in the Last Run Time column. To see when the last maintenance task was started, hover over the clock icon.</p>	<p>The preferred method is to ensure that each maintenance task runs to completion before the next maintenance task starts. Examples of maintenance tasks include inventory expiration, copying of storage pools, space reclamation, and database backup.</p> <p>Tip: If a maintenance task is running too long, change the start time or the maximum runtime. Complete the following steps:</p> <ol style="list-style-type: none"> <li>1. On the Operations Center Overview page, hover over the settings icon and click Command Builder.</li> <li>2. To change the start time or maximum runtime for a task, issue the UPDATE SCHEDULE command. For information about this command, see UPDATE SCHEDULE (Update a client schedule).</li> </ol>

- **Monitoring tape alert messages for hardware errors**  
Tape alert messages are generated by tape and library devices to report hardware errors. These messages help to determine problems that are not related to the IBM Spectrum Protect server.
- **Preventing errors caused by media incompatibility**  
By monitoring and resolving media compatibility issues, you can prevent errors in an IBM Spectrum Protect tape-based solution. A new drive might have a limited ability to use media formats that are supported by a previous version of the drive. Often, a new drive can read but not write to the previous media format.
- **Operations with cleaner cartridges**  
To ensure that tape drives are cleaned when necessary, and to avoid issues with tape storage, follow the guidelines.

## Monitoring tape alert messages for hardware errors

Tape alert messages are generated by tape and library devices to report hardware errors. These messages help to determine problems that are not related to the IBM Spectrum Protect™ server.

### About this task

A log page is created and can be retrieved at any time or at a specific time such as when a drive is dismounted.

A tape alert message can have one of the following severity levels:

- Informational (for example, trying to load a cartridge type that is not supported)
- Warning (for example, a hardware failure is predicted)
- Critical (for example, there is a problem with the tape and data is at risk)

Tape alert messages are turned off by default.

## Procedure

---

- To enable tape alert messages, issue the SET TAPEALERTMSG command and specify the ON value: `set tapealertmsg on`
- To check whether tape alert messages are enabled, issue the QUERY TAPEALERTMSG command: `query tapealertmsg`

## Preventing errors caused by media incompatibility

---

By monitoring and resolving media compatibility issues, you can prevent errors in an IBM Spectrum Protect™ tape-based solution. A new drive might have a limited ability to use media formats that are supported by a previous version of the drive. Often, a new drive can read but not write to the previous media format.

### About this task

---

By default, existing volumes with a status of `FILLING` remain in that state after a drive upgrade. In some cases, you might want to continue to use a previous drive to fill these volumes. This preserves read/write capability for the existing volumes until they are reclaimed. If you choose to upgrade all of the drives in a library, verify that the media formats are supported by the new hardware. Unless you plan to use only the most current media with your new drive, you need to be aware of any compatibility issues. For migration instructions, see Migrating data to upgraded drives.

To use a new drive with media that it can read but not write to, issue the UPDATE VOLUME command to set the access for those volumes to read-only. This prevents errors that are caused by read/write incompatibility. For example, a new drive might eject media that is written in a format that the drive does not support as soon as the media is loaded into the drive. Or a new drive might fail the first write command to media partially written in a format that the drive does not support.

When data on the read-only media expires and the volume is reclaimed, replace it with media that is fully compatible with the new drive. Errors can be generated if a new drive is unable to correctly calibrate a volume that is written when you use a previous format. To avoid this problem, ensure that the original drive is in good working order and at current microcode levels.

## Operations with cleaner cartridges

---

To ensure that tape drives are cleaned when necessary, and to avoid issues with tape storage, follow the guidelines.

### Monitoring the cleaning process

If a cleaner cartridge is checked in to a library, and a drive must be cleaned, the server dismounts the data volume and runs the cleaning operation. If the cleaning operation fails or is canceled, or if no cleaner cartridge is available, you might not be aware that the drive needs cleaning. Monitor cleaning messages for these problems to ensure that drives are cleaned as needed. If necessary, issue the CLEAN DRIVE command to have the server try the cleaning again, or manually load a cleaner cartridge into the drive.

### Using multiple cleaner cartridges

The server uses a cleaner cartridge for the number of cleanings that you specify when you check in the cleaner cartridge. If you check in two or more cleaner cartridges, the server uses only one of the cartridges until the designated number of cleanings for that cartridge is reached. Then, the server uses the next cleaner cartridge. If you check in two or more cleaner cartridges and issue two or more CLEAN DRIVE commands concurrently, the server uses multiple cartridges at the same time and decrements the remaining cleanings on each cartridge.

### Related reference:

- 🔗 [AUDIT LIBRARY](#) (Audit volume inventories in an automated library)
- 🔗 [CHECKIN LIBVOLUME](#) (Check a storage volume into a library)
- 🔗 [CLEAN DRIVE](#) (Clean a drive)
- 🔗 [LABEL LIBVOLUME](#) (Label a library volume)
- 🔗 [QUERY LIBVOLUME](#) (Query a library volume)

## Verifying license compliance

---

Verify that your IBM Spectrum Protect™ solution complies with the provisions of your licensing agreement. By verifying compliance regularly, you can track trends in data growth or processor value unit (PVU) usage. Use this information to plan for future license purchasing.

## About this task

The method that you use to verify that your solution complies with license terms varies depending on the provisions of your IBM Spectrum Protect licensing agreement.

### Front-end capacity licensing

The front-end model determines license requirements based on the amount of primary data that is reported as being backed up by clients. Clients include applications, virtual machines, and systems.

### Back-end capacity licensing

The back-end model determines license requirements based on the terabytes of data that are stored in primary storage pools and repositories.

Tips:

- To ensure the accuracy of front-end and back-end capacity estimates, install the most recent version of the client software on each client node.
- The front-end and back-end capacity information in the Operations Center is for planning and estimation purposes.

### PVU licensing

The PVU model is based on the use of PVUs by server devices.



Important: The PVU calculations that are provided by IBM Spectrum Protect are considered estimates and are not legally binding. The PVU licensing information that is reported by IBM Spectrum Protect is not considered an acceptable substitute for the IBM® License Metric Tool.

For the most recent information about licensing models, see the information about product details and licenses at the IBM Spectrum Protect product family website. If you have questions or concerns about licensing requirements, contact your IBM Spectrum Protect software provider.

## Procedure

To monitor license compliance, complete the steps that correspond to the provisions of your licensing agreement.

Tip: The Operations Center provides an email report that summarizes front-end and back-end capacity usage. Reports can be sent automatically to one or more recipients regularly. To configure and manage email reports, click Reports on the Operations Center menu bar.

Option	Description
<b>Front-end model</b>	<p>a. On the Operations Center menu bar, hover over the settings icon  and click Licensing.</p> <p>The front-end capacity estimate is displayed on the Front-end Usage page.</p> <p>b. If a value is displayed in the Not Reporting column, click the number to identify clients that did not report capacity usage.</p> <p>c. To estimate capacity for clients that did not report capacity usage, go to the following FTP site, which provides measuring tools and instructions:</p> <p><code>ftp://public.dhe.ibm.com/storage/tivoli-storage-management/front_end_capacity_measurement_tools</code></p> <p>To measure front-end capacity by script, complete the instructions in the most recently available licensing guide.</p> <p>d. Add the Operations Center estimate and any estimates that you obtained by using a script.</p> <p>e. Verify that the estimated capacity complies with your licensing agreement.</p>
<b>Back-end model</b>	<p>Restriction: If the source and target replication servers do not use the same policy settings, you cannot use the Operations Center to monitor back-end capacity usage for replicated clients. For information about how to estimate capacity usage for these clients, see technote 1656476.</p> <p>a. On the Operations Center menu bar, hover over the settings icon  and click Licensing.</p> <p>b. Click the Back-end tab.</p> <p>c. Verify that the estimated amount of data complies with your licensing agreement.</p>

Option	Description
<b>PVU model</b>	For information about how to assess compliance with PVU licensing terms, see <a href="#">Assessing compliance with the PVU licensing model</a> .

## Tracking system status by using email reports

Set up the Operations Center to generate email reports that summarize system status. You can configure a mail server connection, change report settings, and optionally create custom SQL reports.

### Before you begin

Before you set up email reports, ensure that the following requirements are met:

- A Simple Mail Transfer Protocol (SMTP) host server is available to send and receive reports by email. The SMTP server must be configured as an open mail relay. You must also ensure that the IBM Spectrum Protect™ server that sends email messages has access to the SMTP server. If the Operations Center is installed on a separate computer, that computer does not require access to the SMTP server.
- To set up email reports, you must have system privilege for the server.
- To specify the recipients, you can enter one or more email addresses or administrator IDs. If you plan to enter an administrator ID, the ID must be registered on the hub server and must have an email address associated with it. To specify an email address for an administrator, use the EMAILADDRESS parameter of the UPDATE ADMIN command.

### About this task

You can configure the Operations Center to send a general operations report, a license compliance report, and one or more custom reports, which use SQL SELECT statements to query managed servers.

### Procedure

To set up and manage email reports, complete the following steps:

1. On the Operations Center menu bar, click Reports.
2. If an email server connection is not yet configured, click Configure Mail Server and complete the fields. After you configure the mail server, the general operations report and license compliance report are enabled.
3. To change report settings, select a report, click Details, and update the form.
4. Optional: To add a custom SQL report, click + Report, and complete the fields.  
Tip: To immediately run and send a report, select the report and click Send.

### Results

Enabled reports are sent according to the specified settings.

### What to do next

The general operations report includes an attachment. To find more detailed information, expand the sections in the attachment.

If you cannot view the image in a report, you might be using an email client that converts HTML to another format. For information about restrictions, see the Operations Center online help.

## Managing operations for a tape solution

Use this information to manage operations for a tape implementation for an IBM Spectrum Protect™ server.

- **Managing the Operations Center**  
The Operations Center provides web and mobile access to status information about the IBM Spectrum Protect environment.
- **Managing client operations**  
You can resolve client errors, manage client upgrades, and decommission client nodes that are no longer required. To free storage space on the server, you can deactivate obsolete data that is stored by application clients.

- **Managing data storage**  
Manage your data for efficiency and add supported devices and media to the server to store client data.
- **Managing tape devices**  
Routine tape operations include preparing tape volumes for use, controlling how and when volumes are reused, and ensuring that sufficient volumes are available. You also must respond to operator requests and manage libraries, drives, disks, paths, and data movers.
- **Managing tape drives**  
You can query, update, and delete tape drives. You can also clean tape drives and configure tape drive encryption and data validation.
- **Securing the IBM Spectrum Protect server**  
Secure the IBM Spectrum Protect server and data by controlling access to servers and client nodes, encrypting data, and maintaining secure access levels and passwords.
- **Stopping and starting the server**  
Before you complete maintenance or reconfiguration tasks, stop the server. Then, start the server in maintenance mode. When you are finished with the maintenance or reconfiguration tasks, restart the server in production mode.
- **Planning to upgrade the server**  
When a fix pack or interim fix becomes available, you can upgrade the IBM Spectrum Protect server to take advantage of product improvements. Servers and clients can be upgraded at different times. Ensure that you complete the planning steps before you upgrade the server.
- **Preparing for an outage or system update**  
Prepare IBM Spectrum Protect to maintain your system in a consistent state during a planned power outage or system update.
- **Preparing for and recovering from a disaster by using DRM**  
IBM Spectrum Protect provides a disaster recovery manager (DRM) function to recover your server and client data during a disaster.

## Managing the Operations Center

---

The Operations Center provides web and mobile access to status information about the IBM Spectrum Protect™ environment.

### About this task

---

You can use the Operations Center to monitor multiple servers and to complete some administrative tasks. The Operations Center also provides web access to the IBM Spectrum Protect command line. For more information about managing the Operations Center, see [Managing the Operations Center](#).

## Managing client operations

---

You can resolve client errors, manage client upgrades, and decommission client nodes that are no longer required. To free storage space on the server, you can deactivate obsolete data that is stored by application clients.

### About this task

---

In some cases, you can resolve client errors by stopping and starting the client acceptor. If client nodes or administrator IDs are locked, you can resolve the issue by unlocking the client node or administrator ID, and then resetting the password.

For detailed instructions about identifying and resolving client errors, see [Resolving client problems](#).

For instructions about adding clients, see [Protecting applications, virtual machines, and systems](#).

- **Evaluating errors in client error logs**  
You can resolve client errors by obtaining suggestions from the Operations Center or by reviewing error logs on the client.
- **Stopping and restarting the client acceptor**  
If you change the configuration of your solution, you must restart the client acceptor on all client nodes where a backup-archive client is installed.
- **Resetting passwords**  
If a password for a client node or an administrator ID is lost or forgotten, you can reset the password. Multiple attempts to access the system with an incorrect password can cause a client node or administrator ID to be locked. You can take steps to resolve the issue.
- **Managing client upgrades**  
When a fix pack or interim fix becomes available for a client, you can upgrade the client to take advantage of product

improvements. Servers and clients can be upgraded at different times and can be at different levels with some restrictions.

- Decommissioning a client node

If a client node is no longer required, you can start a process to remove it from the production environment. For example, if a workstation was backing up data to the IBM Spectrum Protect server, but the workstation is no longer used, you can decommission the workstation.

- Deactivating data to free storage space

In some cases, you can deactivate data that is stored on the IBM Spectrum Protect server. When you run the deactivation process, any backup data that was stored before the specified date and time is deactivated and will be deleted as it expires. In this way, you can free space on the server.

## Evaluating errors in client error logs

---

You can resolve client errors by obtaining suggestions from the Operations Center or by reviewing error logs on the client.

### Before you begin

---

Optionally, to resolve errors in a backup-archive client on a Linux or Windows operating system, ensure that the client management service is installed and started. For installation instructions, see [Installing the client management service](#).

### Procedure

---

To diagnose and resolve client errors, take one of the following actions:

- If the client management service is installed on the client node, complete the following steps:
  1. On the Operations Center Overview page, click Clients and select the client.
  2. Click Details.
  3. On the client Summary page, click the Diagnosis tab.
  4. Review the retrieved log messages.

Tips:

- To show or hide the Client Logs pane, double-click the Client Logs bar.
- To resize the Client Logs pane, click and drag the Client Logs bar.

If suggestions are displayed on the Diagnosis page, select a suggestion. In the Client Logs pane, client log messages to which the suggestion relates are highlighted.

5. Use the suggestions to resolve the problems that are indicated by the error messages.

Tip: Suggestions are provided for only a subset of client messages.

- If the client management service is not installed on the client node, review the error logs for the installed client.

## Stopping and restarting the client acceptor

---

If you change the configuration of your solution, you must restart the client acceptor on all client nodes where a backup-archive client is installed.

### About this task

---

In some cases, you can resolve client scheduling problems by stopping and restarting the client acceptor. The client acceptor must be running to ensure that scheduled operations can occur on the client. For example, if you change the IP address or domain name of the server, you must restart the client acceptor.

### Procedure

---

Follow the instructions for the operating system that is installed on the client node:

AIX and Oracle Solaris

- To stop the client acceptor, complete the following steps:
  - a. Determine the process ID for the client acceptor by issuing the following command on the command line:

```
ps -ef | grep dsmscad
```

Review the output. In the following sample output, 6764 is the process ID for the client acceptor:

```
root 6764 1 0 16:26:35 ? 0:00 /usr/bin/dsmcad
```

b. Issue the following command on the command line:

```
kill -9 PID
```

where *PID* specifies the process ID for the client acceptor.

- To start the client acceptor, issue the following command on the command line:

```
/usr/bin/dsmcad
```

#### Linux

- To stop the client acceptor (and not restart it), issue the following command:

```
# service dsmcad stop
```

- To stop and restart the client acceptor, issue the following command:

```
# service dsmcad restart
```

#### MAC OS X

Click Applications > Utilities > Terminal.

- To stop the client acceptor, issue the following command:

```
/bin/launchctl unload -w com.ibm.tivoli.dsmcad
```

- To start the client acceptor, issue the following command:

```
/bin/launchctl load -w com.ibm.tivoli.dsmcad
```

#### Windows

- To stop the client acceptor service, complete the following steps:
  - a. Click Start > Administrative Tools > Services.
  - b. Double-click the client acceptor service.
  - c. Click Stop and OK.
- To restart the client acceptor service, complete the following steps:
  - a. Click Start > Administrative Tools > Services.
  - b. Double-click the client acceptor service.
  - c. Click Start and OK.

#### Related reference:

[Resolving client scheduling problems](#)

## Resetting passwords

---

If a password for a client node or an administrator ID is lost or forgotten, you can reset the password. Multiple attempts to access the system with an incorrect password can cause a client node or administrator ID to be locked. You can take steps to resolve the issue.

### Procedure

---

To resolve password issues, take one of the following actions:

- If a backup-archive client is installed on a client node, and the password is lost or forgotten, complete the following steps:
  1. Generate a new password by issuing the UPDATE NODE command:

```
update node node_name new_password forcepwreset=yes
```

where *node\_name* specifies the client node and *new\_password* specifies the password that you assign.

2. Inform the client node owner about the changed password. When the owner of the client node logs in with the specified password, a new password is generated automatically. That password is unknown to users to enhance security.

Tip: The password is generated automatically if you previously set the passwordaccess option to *generate* in the client options file.

- If an administrator is locked out because of password issues, complete the following steps:
  1. To provide the administrator with access to the server, issue the UNLOCK ADMIN command. For instructions, see UNLOCK ADMIN (Unlock an administrator).
  2. Set a new password by using the UPDATE ADMIN command:

```
update admin admin_name new_password forcepwnreset=yes
```

where *admin\_name* specifies the name of the administrator and *new\_password* specifies the password that you assign.

- If a client node is locked, complete the following steps:
  1. Determine why the client node is locked and whether it must be unlocked. For example, if the client node is decommissioned, the client node is being removed from the production environment. You cannot reverse the decommission operation, and the client node remains locked. A client node also might be locked if the client data is the subject of a legal investigation.
  2. If you must unlock a client node, use the UNLOCK NODE command. For instructions, see UNLOCK NODE (Unlock a client node).
  3. Generate a new password by issuing the UPDATE NODE command:

```
update node node_name new_password forcepwnreset=yes
```

where *node\_name* specifies the name of the node and *new\_password* specifies the password that you assign.

4. Inform the client node owner about the changed password. When the owner of the client node logs in with the specified password, a new password is generated automatically. That password is unknown to users to enhance security.

Tip: The password is generated automatically if you previously set the passwordaccess option to *generate* in the client options file.

## Managing client upgrades

When a fix pack or interim fix becomes available for a client, you can upgrade the client to take advantage of product improvements. Servers and clients can be upgraded at different times and can be at different levels with some restrictions.

### Before you begin

1. Review the client/server compatibility requirements in technote 1053218. If your solution includes servers or clients at a level that is earlier than V7.1, review the guidelines to ensure that client backup and archive operations are not disrupted.
2. Verify system requirements for the client in IBM Spectrum Protect™ Supported Operating Systems.
3. If the solution includes storage agents or library clients, review the information about storage-agent and library-client compatibility with servers that are configured as library managers. See technote 1302789.

If you plan to upgrade a library manager and a library client, you must upgrade the library manager first.

### Procedure

To upgrade the software, complete the instructions that are listed in the following table.

Software	Link to instructions
IBM Spectrum Protect backup-archive client	<ul style="list-style-type: none"> <li>• Upgrading the backup-archive client</li> </ul>
IBM Spectrum Protect Snapshot	<ul style="list-style-type: none"> <li>• Installing and upgrading IBM Spectrum Protect Snapshot for UNIX and Linux</li> <li>• Installing and upgrading IBM Spectrum Protect Snapshot for VMware</li> <li>• Installing and upgrading IBM Spectrum Protect Snapshot for Windows</li> </ul>
IBM Spectrum Protect for Databases	<ul style="list-style-type: none"> <li>• Upgrading Data Protection for SQL Server</li> <li>• Data Protection for Oracle installation</li> <li>• Installing, upgrading, and migrating IBM Spectrum Protect for Mail: Data Protection for Microsoft Exchange Server</li> </ul>



Software	Link to instructions
IBM Spectrum Protect for Enterprise Resource Planning	<ul style="list-style-type: none"> <li>Upgrading IBM Spectrum Protect for Enterprise Resource Planning: Data Protection for SAP for DB2®</li> <li>Upgrading IBM Spectrum Protect for Enterprise Resource Planning: Data Protection for SAP for Oracle</li> </ul>
IBM Spectrum Protect for Mail	<ul style="list-style-type: none"> <li>Installation of Data Protection for IBM Domino on a UNIX, AIX, or Linux system (V7.1.0)</li> <li>Installation of Data Protection for IBM Domino on a Windows system (V7.1.0)</li> <li>Installing, upgrading, and migrating IBM Spectrum Protect for Mail: Data Protection for Microsoft Exchange Server</li> </ul>
IBM Spectrum Protect for Virtual Environments	<ul style="list-style-type: none"> <li>Installing and upgrading Data Protection for VMware</li> <li>Installing Data Protection for Microsoft Hyper-V</li> </ul>

## Decommissioning a client node

If a client node is no longer required, you can start a process to remove it from the production environment. For example, if a workstation was backing up data to the IBM Spectrum Protect™ server, but the workstation is no longer used, you can decommission the workstation.

### About this task

When you start the decommission process, the server locks the client node to prevent it from accessing the server. Files that belong to the client node are gradually deleted, and then the client node is deleted. You can decommission the following types of client nodes:

#### Application client nodes

Application client nodes include email servers, databases, and other applications. For example, any of the following applications can be an application client node:

- IBM Spectrum Protect Snapshot
- IBM Spectrum Protect for Databases
- IBM Spectrum Protect for Enterprise Resource Planning
- IBM Spectrum Protect for Mail
- IBM Spectrum Protect for Virtual Environments

#### System client nodes

System client nodes include workstations, network-attached storage (NAS) file servers, and API clients.

#### Virtual machine client nodes

Virtual machine client nodes consist of an individual guest host within a hypervisor. Each virtual machine is represented as a file space.

The simplest method for decommissioning a client node is to use the Operations Center. The decommission process runs in the background. If the client is configured to replicate client data, the Operations Center automatically removes the client from replication on the source and target replication servers before it decommissions the client.

Tip: Alternatively, you can decommission a client node by issuing the `DECOMMISSION NODE` or `DECOMMISSION VM` command. You might want to use this method in the following cases:

- To schedule the decommission process for the future or to run a series of commands by using a script, specify the decommission process to run in the background.
- To monitor the decommission process for debugging purposes, specify the decommission process to run in the foreground. If you run the process in the foreground, you must wait for the process to be completed before you continue with other tasks.

## Procedure

Take one of the following actions:

- To decommission a client in the background by using the Operations Center, complete the following steps:
  1. On the Operations Center Overview page, click Clients and select the client.
  2. Click More > Decommission.
- To decommission a client node by using an administrative command, take one of the following actions:
  - To decommission an application or system client node in the background, issue the DECOMMISSION NODE command. For example, if the client node is named AUSTIN, issue the following command:

```
decommission node austin
```

- To decommission an application or system client node in the foreground, issue the DECOMMISSION NODE command and specify the `wait=yes` parameter. For example, if the client node is named AUSTIN, issue the following command:

```
decommission node austin wait=yes
```

- To decommission a virtual machine in the background, issue the DECOMMISSION VM command. For example, if the virtual machine is named AUSTIN, the file space is 7, and the file space name is specified by the file space ID, issue the following command:

```
decommission vm austin 7 nametype=fsid
```

If the virtual machine name includes one or more spaces, enclose the name in double quotation marks. For example:

```
decommission vm "austin 2" 7 nametype=fsid
```

- To decommission a virtual machine in the foreground, issue the DECOMMISSION VM command and specify the `wait=yes` parameter. For example, issue the following command:

```
decommission vm austin 7 nametype=fsid wait=yes
```

If the virtual machine name includes one or more spaces, enclose the name in double quotation marks. For example:

```
decommission vm "austin 2" 7 nametype=fsid wait=yes
```

## What to do next

Watch for error messages, which might be displayed in the user interface or in the command output, immediately after you run the process.

You can verify that the client node is decommissioned:

1. On the Operations Center Overview page, click Clients.
2. In the Clients table, in the At risk column, review the state:
  - A DECOMMISSIONED state specifies that the node is decommissioned.
  - A null value specifies that the node is not decommissioned.
  - A PENDING state specifies that the node is being decommissioned, or the decommission process failed.

Tip: If you want to determine the status of a pending decommission process, issue the following command:

```
query process
```

3. Review the command output:

- If status is provided for the decommission process, the process is in progress. For example:

```
query process
```

Process Number	Process Description	Process Status
3	DECOMMISSION NODE	Number of backup objects deactivated for node NODE1: 8 objects deactivated.

- If no status is provided for the decommission process, and you did not receive an error message, the process is incomplete. A process can be incomplete if files that are associated with the node are not yet deactivated. After the files are deactivated, run the decommission process again.
- If no status is provided for the decommission process, and you receive an error message, the process failed. Run the decommission process again.

### Related reference:

[DECOMMISSION NODE \(Decommission a client node\)](#)

## Deactivating data to free storage space

---

In some cases, you can deactivate data that is stored on the IBM Spectrum Protect™ server. When you run the deactivation process, any backup data that was stored before the specified date and time is deactivated and will be deleted as it expires. In this way, you can free space on the server.

### About this task

---

Some application clients always save data to the server as active backup data. Because active backup data is not managed by inventory expiration policies, the data is not deleted automatically, and uses server storage space indefinitely. To free the storage space that is used by obsolete data, you can deactivate the data.

When you run the deactivation process, all active backup data that was stored before the specified date becomes inactive. The data is deleted as it expires and cannot be restored. The deactivation feature applies only to application clients that protect Oracle databases.

### Procedure

---

1. From the Operations Center Overview page, click Clients.
2. In the Clients table, select one or more clients and click More > Clean Up.  
Command-line method: Deactivate data by using the DEACTIVATE DATA command.

**Related reference:**

[🔗](#) DEACTIVATE DATA (Deactivate data for a client node)

## Managing data storage

---

Manage your data for efficiency and add supported devices and media to the server to store client data.

- **Managing inventory capacity**  
Manage the capacity of the database, active log, and archive logs to ensure that the inventory is sized for the tasks, based on the status of the logs.
- **Tuning scheduled activities**  
Schedule maintenance tasks daily to ensure that your solution operates correctly. By tuning your solution, you maximize server resources and effectively use different functions available within your solution.
- **Optimizing operations by enabling collocation of client files**  
Collocation of client files reduces the number of volume mounts that are required when users restore, retrieve, or recall many files from a storage pool. Collocation thus reduces the amount of time that is required for these operations.

**Related reference:**

[🔗](#) Types of storage pools

## Managing inventory capacity

---

Manage the capacity of the database, active log, and archive logs to ensure that the inventory is sized for the tasks, based on the status of the logs.

### Before you begin

---

The active and archive logs have the following characteristics:

- The active log can be a maximum size of 512 GB. For more information about sizing the active log for your system, see Planning the storage arrays.
- The archive log size is limited to the size of the file system that it is installed on. The archive log size is not maintained at a predefined size like the active log. Archive log files are automatically deleted after they are no longer needed.

As a best practice, you can optionally create an archive failover log to store archive log files when the archive log directory is full.

Check the Operations Center to determine the component of the inventory that is full. Ensure that you stop the server before you increase the size of one of the inventory components.

## Procedure

- To increase the disk space for the database, complete the following steps:
  - Create one or more directories for the database on separate drives or file systems.
  - Issue the EXTEND DBSPACE command to add the directory or directories to the database. The directories must be accessible to the instance user ID of the database manager. By default, data is redistributed across all database directories and space is reclaimed.

Tips:

  - The time that is needed to complete redistribution of data and reclaiming of space is variable, depending on the size of your database. Make sure that you plan adequately.
  - Ensure that the directories that you specify are the same size as existing directories to ensure a consistent degree of parallelism for database operations. If one or more directories for the database are smaller than the others, they reduce the potential for optimized parallel prefetching and distribution of the database.
  - Halt and restart the server to fully use the new directories.
  - Reorganize the database if necessary. Index and table reorganization for the server database can help to avoid unexpected database growth and performance issues. For more information about reorganizing the database, see technote 1683633.
- To decrease the size of the database for V7.1 servers and later, see the information in technote 1683633. Restriction: The commands can increase I/O activity, and might affect server performance. To minimize performance problems, wait until one command is completed before you issue the next command. The DB2® commands can be issued when the server is running.
- To increase or decrease the size of the active log, complete the following steps:
  1. Ensure that the location for the active log has enough space for the increased log size.
  2. Halt the server.
  3. In the dsmserv.opt file, update the ACTIVELOGSIZE option to the new size of the active log, in megabytes. The size of an active log file is based on the value of the ACTIVELOGSIZE option. Guidelines for space requirements are in the following table:

Table 1. How to estimate volume and file space requirements

ACTIVELOGSize option value	Reserve this much free space in the active log directory, in addition to the ACTIVELOGSize space
16 GB - 128 GB	5120 MB
129 GB - 256 GB	10240 MB
257 GB - 512 GB	20480 MB

To change the active log to its maximum size of 512 GB, enter the following server option:

```
activelogsiz 524288
```

4. If you plan to use a new active log directory, update the directory name that is specified in the ACTIVELOGDIRECTORY server option. The new directory must be empty and must be accessible to the user ID of the database manager.
  5. Restart the server.
- Compress the archive logs to reduce the amount of space that is required for storage. Enable dynamic compression of the archive log by issuing the following command:

```
setopt archlogcompress yes
```

Restriction: Use caution when you enable the ARCHLOGCOMPRESS server option on systems with sustained high volume usage and heavy workloads. Enabling this option in this system environment can cause delays in archiving log files from the active log file system to the archive log file system. This delay can cause the active log file system to run out of space. Be sure to monitor the available space in the active log file system after archive log compression is enabled. If the active log directory file system usage nears out of space conditions, the ARCHLOGCOMPRESS server option must be disabled. You can use the SETOPT command to disable archive log compression immediately without halting the server.

### Related reference:

- [ACTIVELOGSIZE server option](#)
- [EXTEND DBSPACE \(Increase space for the database\)](#)
- [SETOPT \(Set a server option for dynamic update\)](#)

## Tuning scheduled activities

Schedule maintenance tasks daily to ensure that your solution operates correctly. By tuning your solution, you maximize server resources and effectively use different functions available within your solution.

### Procedure

1. Monitor system performance regularly to ensure that backup and maintenance tasks are completing successfully. For more information about monitoring, see [Monitoring a tape solution](#).
2. If the monitoring information shows that the server workload increased, you might need to review the planning information. Review whether the capacity of the system is adequate in the following cases:
  - o The number of clients increases
  - o The amount of data that is being backed up increases
  - o The amount of time that is available for backups changes
3. Determine whether your solution has performance issues. Review the client schedules to check whether tasks are completing within the scheduled time frame:
  - a. On the Clients page of the Operations Center, select the client.
  - b. Click Details.
  - c. From the client Summary page, review the Backed up and Replicated activity to identify any risks.Adjust the time and frequency of client backup operations, if necessary.
4. Schedule enough time for the following maintenance tasks to complete successfully within a 24-hour period:
  - a. Back up the database
  - b. Run expiration to remove client backups and archive file copies from server storage.

#### Related concepts:

[Performance](#)

#### Related tasks:

[Deduplicating data \(V7.1.1\)](#)

## Optimizing operations by enabling collocation of client files

Collocation of client files reduces the number of volume mounts that are required when users restore, retrieve, or recall many files from a storage pool. Collocation thus reduces the amount of time that is required for these operations.

### About this task

With collocation enabled, the server tries to keep files on a minimal number of sequential-access storage volumes. The files can belong to a single client node, a group of client nodes, a client file space, or a group of file spaces. You can set collocation for each sequential-access storage pool when you define or update the pool.

Figure 1 shows an example of collocation by client node with three clients, each having a separate volume that contains that client's data.

Figure 1. Example of collocation enabled by node

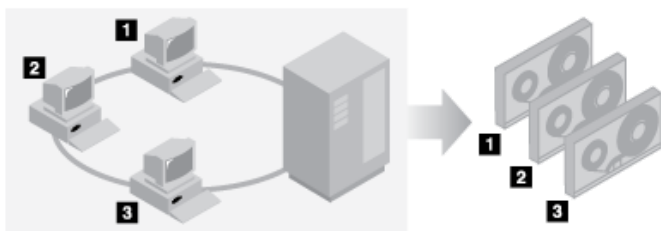

Figure 2 shows an example of collocation by group of client nodes. Three groups are defined, and the data for each group is stored on separate volumes.

Figure 2. Example of collocation enabled by node collocation group

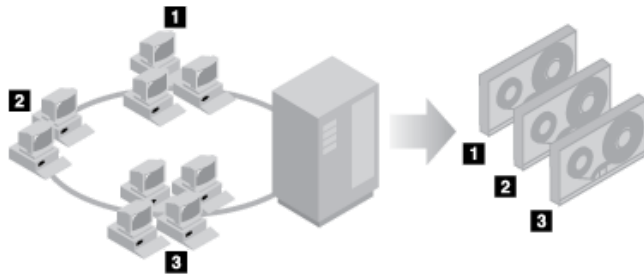
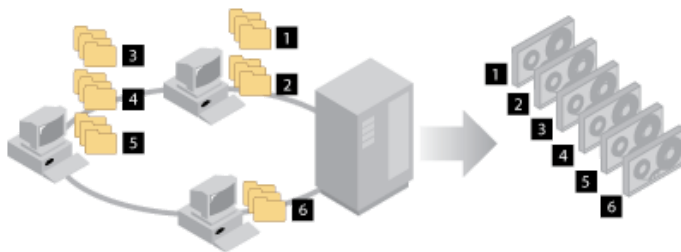

Figure 3 shows an example of collocation by file space group. Six groups are defined. Each group contains data from file spaces that belong to a single node. The data for each group is stored on a separate volume.

Figure 3. Example of collocation enabled by file space collocation group



When collocation is disabled, the server tries to use all available space on each volume before it selects a new volume. While this process provides better use of individual volumes, user files can become scattered across many volumes. Figure 4 shows an example of collocation that is disabled, with three clients that share space on single volume.

Figure 4. Example of collocation disabled

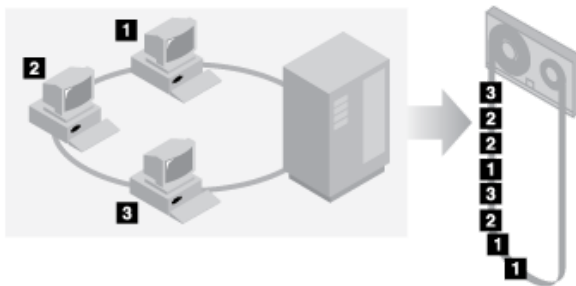

With collocation disabled, more media mount operations might be required to mount volumes when users restore, retrieve, or recall many files.

Collocation by group is the IBM Spectrum Protect™ system default for primary sequential-access storage pools. The default for copy storage pools is no collocation.

- Effects of collocation on operations  
The effect of collocation on resources and system performance depends on the type of operation that is being run.
- Selecting volumes with collocation enabled  
Volume selection depends on whether collocation is by group, node, or file space.
- Selecting volumes with collocation disabled  
When collocation is disabled, the server attempts to use all available space in a storage volume before it accesses another volume.
- Collocation settings  
After you define a storage pool, you can change the collocation setting by updating the storage pool. The change in collocation for the pool does not affect files that are already stored in the pool.
- Collocation of copy storage pools  
Using collocation on copy storage pools requires special consideration. Collocation of copy storage pools, especially by node or file space, results in more partially filled volumes and potentially unnecessary offsite reclamation activity.

- Planning for and enabling collocation  
Understanding the effects of collocation can help reduce the number of media mounts, make better use of space on sequential volumes, and improve the efficiency of server operations.

## Effects of collocation on operations

The effect of collocation on resources and system performance depends on the type of operation that is being run.

Table 1 summarizes the effects of collocation on operations.

Table 1. Effect of collocation on operations

Operation	Collocation enabled	Collocation disabled
Backing up, archiving, or migrating client files	More media mounts to collocate files.	Fewer media mounts are required.
Restoring, retrieving, or recalling client files	Large numbers of files can be restored, retrieved, or recalled more quickly because files are on fewer volumes.	Multiple mounts of media might be required for a single user because files might be spread across multiple volumes.  More than one user's files can be stored on the same sequential-access storage volume. For example, if two users try to recover a file that is on the same volume, the second user is forced to wait until the first user's files are recovered.
Storing data on tape	The server attempts to use all available tape volumes to separate user files before it uses all available space on every tape volume.	The server attempts to use all available space on each tape volume before the server use another tape volume.
Media mount operations	More mount operations are required when user files are backed up, archived, or migrated from client nodes directly to sequential-access volumes.  More mount operations are required during reclamation and storage pool migration.  More volumes are managed because volumes are not fully used.	More mount operations are required during restore, retrieve, and recall of client files.
Generating backup sets	Less time is spent searching database entries, and fewer mount operations are required.	More time is spent searching database entries and fewer mount operations are required.

When collocation is enabled for a group, single client node, or file space, all the data that belongs to the group, the node, or the file space is moved or copied by one server process. For example, if data is collocated by group, all data for all nodes that belong to the same collocation group is migrated by the same process.

When collocating data, the IBM Spectrum Protect™ server tries to keep files together on a minimal number of sequential-access storage volumes. However, when the server is backing up data to volumes in a sequential-access storage pool, the backup process has priority over collocation settings. As a result, the server completes the backup operation, but might not be able to collocate the data.

For example, suppose that you are collocating by node and you specify that a node can use two mount points on the server. Suppose also that the data that is backed up from the node can easily fit on one tape volume. During backup, the server might mount two tape volumes, and the node's data might be distributed across two tapes, rather than one. If you enable collocation, the following server operations use one server process:

- Moving data from random-access and sequential-access volumes
- Moving node data from sequential-access volumes
- Backing up a random-access or sequential-access storage pool

- Restoring a sequential-access storage pool
- Reclaiming space in a sequential-access storage pool or offsite volumes
- Migrating data from a random-access storage pool

When you migrate data from a random-access disk storage pool to a sequential-access storage pool, and collocation is by node or file space, nodes or file spaces are automatically selected for migration based on the amount of data to be migrated. The node or file space with the most data is migrated first. If collocation is by group, all nodes in the storage pool are evaluated to determine which node has the most data. The node with the most data is migrated first along with all the data for all the nodes that belong to that collocation group. This process occurs, regardless of how much data is stored in the file spaces of nodes and regardless of whether the low migration threshold was reached.

However, when you migrate collocated data from a sequential-access storage pool to another sequential-access storage pool, the server orders the volumes according to the date when the volume was last accessed. The volume with the earliest access date is migrated first, and the volume with the latest access date is migrated last.

One reason to collocate by group is that individual client nodes often do not have sufficient data to fill high-capacity tape volumes. Collocating data by groups of nodes can reduce unused tape capacity by putting more collocated data on individual tapes. Also, collocating data by groups of file spaces reduces the unused tape to a greater degree.

The data that belongs to all the nodes in the same collocation group are migrated by the same process. Therefore, collocation by group can reduce the number of times that a volume to be migrated must be mounted. Collocation by group can also minimize database scanning and reduce tape passes during data transfer from one sequential-access storage pool to another.

## Selecting volumes with collocation enabled

Volume selection depends on whether collocation is by group, node, or file space.

Table 1 shows how the IBM Spectrum Protect™ server selects the first volume when collocation is enabled for a storage pool at the client-node, collocation-group, and file-space level.

Table 1. How the server selects volumes when collocation is enabled

Volume Selection Order	When collocation is by group	When collocation is by node	When collocation is by file space
1	A volume that already contains files from the collocation group to which the client belongs	A volume that already contains files from the same client node	A volume that already contains files from the same file space of that client node
2	An empty predefined volume	An empty predefined volume	An empty predefined volume
3	An empty scratch volume	An empty scratch volume	An empty scratch volume
4	A volume with the most available free space among volumes that already contain data	A volume with the most available free space among volumes that already contain data	A volume that contains data from the same client node
5	Not applicable	Not applicable	A volume with the most available free space among volumes that already contain data

When the server must continue to store data on a second volume, it uses the following selection order to acquire more space:

1. An empty predefined volume
2. An empty scratch volume
3. A volume with the most available free space among volumes that already contain data
4. Any available volume in the storage pool

When collocation is by client node or file space, the server tries to provide the best use of individual volumes and minimizes file mixing from different clients or file spaces on volumes. This configuration is depicted in Figure 1, which shows that volume selection is *horizontal*, where all available volumes are used before all available space on each volume is used. A, B, C, and D represent files from four different client nodes.

Tips:

1. If collocation is by node and the node has multiple file spaces, the server does not attempt to collocate those file spaces.



2. If collocation is by file space and a node has multiple file spaces, the server attempts to put data for different file spaces on different volumes.

Figure 1. Using all available sequential-access storage volumes with collocation enabled at the node or file space level

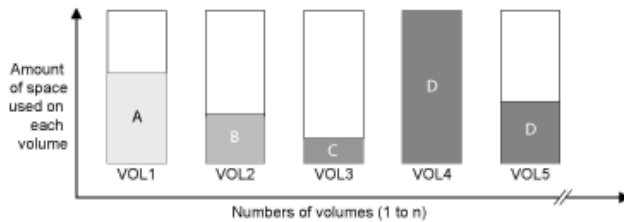

Collocation can be by file space group or node group. When collocation is by node group (node collocation group), the server tries to collocate data from nodes that belong to the same collocation group. A file space collocation group uses the same methods as a node collocation group, but can use more space because of the granularity of file space sizes. As shown in Figure 2, data for the following groups of nodes was collocated:

- Group 1 consists of nodes A, B, and C
- Group 2 consists of nodes D and E
- Group 3 consists of nodes F, G, H, and I

Whenever possible, the IBM Spectrum Protect server collocates data that belongs to a group of nodes on a single tape, as represented by Group 2 in the figure. Data for a single node can also be spread across several tapes that are associated with a group (Group 1 and 2). If the nodes in the collocation group have multiple file spaces, the server does not attempt to collocate those file spaces.

Figure 2. Using all available sequential-access storage volumes with collocation enabled at the group level

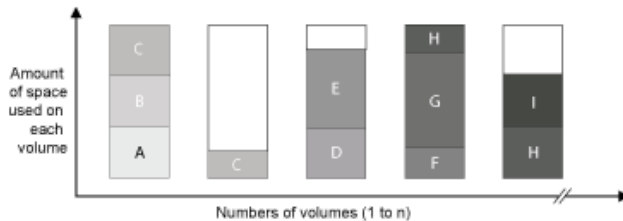

Normally, the IBM Spectrum Protect server always writes data to the current filling volume for the operation that is running. However, occasionally you might notice more than one filling volume in a collocated storage pool. Having more than one filling volume in a collocated storage pool can occur if different server processes or client sessions try to store data into the collocated pool at the same time. In this situation, IBM Spectrum Protect allocates a volume for each process or session that needs a volume so that both operations are completed as quickly as possible.

## Selecting volumes with collocation disabled

When collocation is disabled, the server attempts to use all available space in a storage volume before it accesses another volume.

When you store client files in a sequential-access storage pool where collocation is disabled, the server selects a volume by using the following selection order:

1. A previously used sequential volume with available space (a volume with the most amount of data is selected first)
2. An empty volume

When the server needs to continue to store data on a second volume, it attempts to select an empty volume. If no empty volume exists, the server attempts to select any remaining available volume in the storage pool.

Figure 1 shows that volume use is vertical when collocation is disabled. In this example, fewer volumes are used because the server attempts to use all available space by mixing client files on individual volumes. A, B, C, and D represent files from four different client nodes.

Figure 1. Using all available space on sequential-access volumes with collocation disabled

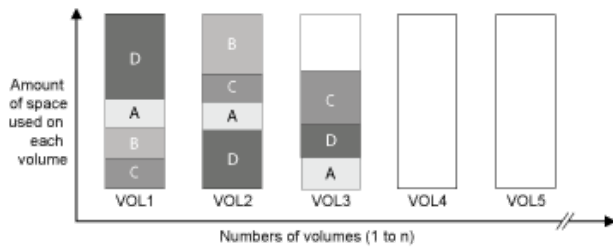

## Collocation settings

After you define a storage pool, you can change the collocation setting by updating the storage pool. The change in collocation for the pool does not affect files that are already stored in the pool.

For example, if collocation is off for a storage pool and you turn it on, from then on client files that are stored in the pool are collocated. Files that were previously stored in the storage pool are not moved to collocate them. As volumes are reclaimed, the data in the pool tends to become more collocated. You can also use the MOVE DATA or MOVE NODEDATA commands to move data to new volumes to increase collocation. Moving data to new volumes causes an increase in the processing time and the volume mount activity.

Tip: A mount wait can occur or take longer than usual when collocation by file space is enabled and a node has a volume that contains multiple file spaces. If a volume is eligible to receive data, IBM Spectrum Protect™ waits for that volume.

## Collocation of copy storage pools

Using collocation on copy storage pools requires special consideration. Collocation of copy storage pools, especially by node or file space, results in more partially filled volumes and potentially unnecessary offsite reclamation activity.

Primary storage pools play a different recovery role than copy storage pools. Normally, you use primary storage pools to recover data to clients directly. In a disaster, when both clients and the server are lost, you might use offsite copy storage pool volumes to recover the primary storage pools. The types of recovery scenarios can help you to determine whether to use collocation on your copy storage pools.

Collocation typically results in partially filled volumes when you collocate by node or by file space. However, partially filled volumes are less prevalent when you collocate by group. Partially filled volumes might be acceptable for primary storage pools because the volumes remain available and can be filled during the next migration process. However, partially filled volumes might be unacceptable for copy storage pools whose storage pool volumes are taken offsite immediately. If you use collocation for copy storage pools, you must make the following decisions:

- Taking more partially filled volumes offsite, which increases the reclamation activity when the reclamation threshold is lowered or reached.
- Leaving these partially filled volumes onsite until they fill and risk not having an offsite copy of the data on these volumes.
- Whether to collocate by group to use as much tape capacity as possible.

When collocation is disabled for a copy storage pool, typically only a few partially filled volumes remain after data is backed up to the copy storage pool.

Consider your options carefully before you use collocation for copy storage pools, and whether to use simultaneous write. If you do not use simultaneous write and you use collocation for your primary storage pools, you might want to disable collocation for copy storage pools. Collocation of copy storage pools might be desirable if you have few clients with each of them having large amounts of incremental backup data each day. For collocation with simultaneous write, you must ensure that the collocation settings are identical for the primary storage pools and copy storage pools.

## Planning for and enabling collocation

Understanding the effects of collocation can help reduce the number of media mounts, make better use of space on sequential volumes, and improve the efficiency of server operations.

### About this task

Table 1 lists the four collocation options that you can specify on the DEFINE STGPOOL and UPDATE STGPOOL commands. The table also shows the effects of collocation on data that belongs to nodes that are and are not members of collocation groups.

Table 1. Collocation options and the effects on node data

Collocation option	If a node is not defined as a member of a collocation group	If a node is defined as a member of a collocation group
<b>No</b>	The data for the node is not collocated.	The data for the node is not collocated.
<b>Group</b>	The server stores the data for the node on as few volumes in the storage pool as possible.	The server stores the data for the node and for other nodes that belong to the same collocation group on as few volumes as possible.
<b>Node</b>	The server stores the data for the node on as few volumes as possible.	The server stores the data for the node on as few volumes as possible.
<b>File space</b>	The server stores the data for the node's file space on as few volumes as possible. If a node has multiple file spaces, the server stores the data for different file spaces on different volumes in the storage pool.	The server stores the data for the node's file space on as few volumes as possible. If a node has multiple file spaces, the server stores the data for different file spaces on different volumes in the storage pool.

Table 2. Collocation group options and effects on file space data

Collocation option	If a file space is not defined as a member of a collocation group	If a file space is defined as a member of a collocation group
<b>No</b>	The data for the file space is not collocated.	The data for the file space is not collocated.
<b>Group</b>	The server stores the data for the file space on as few volumes in the storage pool as possible.	The server stores the data for the file space and other file spaces that belong to the same collocation group on as few volumes as possible.
<b>Node</b>	The server stores the data for the node on as few volumes as possible.	The server stores the data for the node on as few volumes as possible.
<b>File space</b>	The server stores the data for the node's file space on as few volumes as possible. If a node has multiple file spaces, the server stores the data for different file spaces on different volumes in the storage pool.	The server stores the data for the file spaces on as few volumes as possible. If a node has multiple file spaces, the server stores the data for different file spaces on different volumes in the storage pool.

## Procedure

To determine whether and how to collocate data, complete the following steps:

1. Determine how to organize data, whether by client node, group of client nodes, or file space. To collocate by group, you must decide how to group nodes:
  - o If the goal is to save space, you might want to group small nodes together to better use tapes.
  - o If the goal is potentially faster client restores, group nodes together so that they fill as many tapes as possible. By grouping nodes together, the individual node data is distributed across two or more tapes and that more tapes can be mounted simultaneously during a multi-session no-query restore operation.
  - o If the goal is to departmentalize data, you can group nodes by department.
2. To collocate groups, complete the following steps:
  - a. Define collocation groups with the DEFINE COLLOGROUP command.
  - b. Add client nodes to the collocation groups with the DEFINE COLLOCMEMBER command.

The following query commands are available to help in collocating groups:

QUERY COLLOGROUP

Displays the collocation groups that are defined on the server.

QUERY NODE

Displays the collocation group, if any, to which a node belongs.

QUERY NODEDATA

Displays information about the data for one or more nodes in a sequential-access storage pool.

QUERY STGPOOL

Displays information about the location of client data in a sequential-access storage pool and the amount of space a node occupies in a volume.

You can also use IBM Spectrum Protect™ server scripts or PerlL scripts to display information that can be useful in defining collocation groups.

3. Specify how data must be collocated in a storage pool by issuing the DEFINE STGPOOL or UPDATE STGPOOL command and specifying the COLLOCATE parameter.

## What to do next

---

Tip: To reduce the number of media mounts, use space on sequential volumes more efficiently, and enable collocation, complete the following steps:

- Define a storage pool hierarchy and policy to require that backed-up, archived, or space-managed files are initially stored in disk storage pools.

When files are migrated from a disk storage pool, the server attempts to migrate all files that belong to the client node or collocation group that is using the most disk space in the storage pool. This process works well with the collocation option because the server tries to place all of the files from a particular client on the same sequential-access storage volume.

- Use scratch volumes for sequential-access storage pools to allow the server to select new volumes for collocation.
- Specify the client option COLLOCATEBYFILESPEC to limit the number of tapes to which objects associated with one file specification are written. This collocation option makes collocation by the server more efficient; it does not override collocation by file space or collocation by node.

## Managing tape devices

---

Routine tape operations include preparing tape volumes for use, controlling how and when volumes are reused, and ensuring that sufficient volumes are available. You also must respond to operator requests and manage libraries, drives, disks, paths, and data movers.

- **Preparing removable media**  
You must prepare removable media before it can be used to store data. Typical preparation tasks include labeling and checking in volumes.
- **Managing volume inventory**  
You can manage volume inventory by controlling the server's access to volumes, by reusing tapes, and by reusing volumes that are used for database backup and export operations. You can also manage inventory by maintaining a supply of scratch volumes.
- **Partially written volumes**  
Partially written volumes are always private volumes, even if their status was scratch before the server mounted them. The server tracks the original status of scratch volumes and returns them to scratch status when they are empty.
- **Operations with shared libraries**  
Shared libraries are logical libraries that are represented physically by SCSI libraries. The physical library is controlled by the IBM Spectrum Protect server that is configured as a library manager. IBM Spectrum Protect servers that use the SHARED library type are library clients to the IBM Spectrum Protect library manager server.
- **Managing server requests for volumes**  
IBM Spectrum Protect displays requests and status messages to all administrative command-line clients that are started in console mode. These request messages often have a time limit. Successful server operations must be completed within the time limit that is specified; otherwise, the operation times out.

## Preparing removable media

---

You must prepare removable media before it can be used to store data. Typical preparation tasks include labeling and checking in volumes.

### About this task

---

When IBM Spectrum Protect™ accesses a removable media volume, it verifies the volume name in the label header to ensure that the correct volume is accessed.

Tape volumes must be labeled before the server can use them.

### Procedure

---

To prepare a volume for use, complete the following steps:

1. Label the volume by issuing the LABEL LIBVOLUME command.
2. For automated libraries, check the volume into the library. For instructions, see Checking volumes into an automated library.  
Tip: When you use the LABEL LIBVOLUME command with drives in an automated library, you can label and check in the volumes with one command.
3. If the storage pool cannot contain scratch volumes (MAXSCRATCH=0), identify the volume to IBM Spectrum Protect by name so that the volume can be accessed later.

If the storage pool can contain scratch volumes (MAXSCRATCH is set to a non-zero value), skip this step.

- Labeling tape volumes  
You must label tape volumes before the server can use them.
- Checking volumes into an automated library  
You can check in a volume to an automated library by using the CHECKIN LIBVOLUME command.

## Labeling tape volumes

---

You must label tape volumes before the server can use them.

### About this task

---

For automated libraries, you are prompted to insert the volume in the entry/exit slot of the library. If no convenience input/output (I/O) station is available, insert the volume into an empty slot. You can label the volumes when you check them in or before you check them in.

### Procedure

---

To label tape volumes before you check them in, complete the following steps:

1. Label tape volumes by issuing the LABEL LIBVOLUME command. For example, to name a library volume VOLUME1 in a library that is named LIBRARY 1, issue the following command:

```
label libvolume library1 volume1
```

Requirement: At least one drive must be available. The drive cannot be used by another IBM Spectrum Protect™ process. If a drive is idle, the drive is considered to be unavailable.

2. To overwrite an existing label, specify the OVERWRITE=YES parameter. By default, the LABEL LIBVOLUME command does not overwrite an existing label.
- Labeling volumes in a SCSI library  
You can label volumes individually or use IBM Spectrum Protect to search the library for volumes and label the found volumes.

#### Related tasks:

Labeling new volumes by using AUTOLABEL

#### Related reference:

[LABEL LIBVOLUME \(Label a library volume\)](#)

## Checking volumes into an automated library

---

You can check in a volume to an automated library by using the CHECKIN LIBVOLUME command.

### Before you begin

---

To automatically label tapes before you check them in, issue the DEFINE LIBRARY command and specify the AUTOLABEL=YES parameter. By using the AUTOLABEL parameter, you eliminate the need to prelabel a set of tapes.

### About this task

---

Each volume that is used by a server for any purpose must have a unique name. This requirement applies to all volumes, whether the volumes are used for storage pools, or used for operations such as database backup or export. The requirement also applies to volumes that are in different libraries but that are used by the same server.

Tips:

- Do not use a single library for volumes that have bar code labels and volumes that do not have bar code labels. Bar code scanning can take a long time for unlabeled volumes.
- The server accepts only tapes that are labeled with IBM® standard labels.
- Any volume that has a bar code that begins with CLN is treated as a cleaning tape.
- If a volume has an entry in volume history, you cannot check it in as a scratch volume.

## Procedure

---

1. To check a storage volume into a library, issue the CHECKIN LIBVOLUME command.  
Tip: The command always runs as a background process. Wait for the CHECKIN LIBVOLUME process to complete processing before you define volumes, or the defining process fails. You can save time by checking in volumes as part of the labeling operation.
  2. Name the library and specify whether the volume is a private volume or a scratch volume. Depending on whether you use scratch volumes or private volumes, complete one of the following steps:
    - If you use only scratch volumes, ensure that enough scratch volumes are available. For example, you might need to label more volumes. As volumes are used, you might also need to increase the number of scratch volumes that are allowed in the storage pool that you defined for this library.
    - If you want to use private volumes in addition to or instead of scratch volumes in the library, define volumes to the storage pool by using the DEFINE VOLUME command. You must label and check in the volumes that you define.
- Checking a single volume into a SCSI library  
You can check in a single volume by issuing the CHECKIN LIBVOLUME command and specifying the SEARCH=NO parameter. IBM Spectrum Protect™ requests that the mount operator load the volume into the entry/exit port of the library.
  - Checking in volumes from library storage slots  
When you have many volumes to check in and you want to avoid issuing a CHECKIN LIBVOLUME command for each volume, you can search storage slots for new volumes. The server finds volumes that have not yet been added to the volume inventory.
  - Checking in volumes from library entry/exit ports  
You can search all slots of bulk entry/exit ports for labeled volumes and the server can check them in automatically.
  - Checking in volumes by using library bar code readers  
You can save time when you check in volumes to libraries that have bar code readers by using the characters on the bar code labels as names for the volumes.
  - Checking in volumes by using a bar code reader  
You can save time when you check in volumes by using a bar code reader, if your library has one.
  - Checking volumes into a full library with swapping  
If no empty slots are available in the library when you are checking in volumes, the check-in operation fails unless you enable *swapping*. If you enable swapping and the library is full, the server selects a volume to eject and then checks in the volume that you requested.
  - **Windows** Private volumes and scratch volumes  
To optimize tape storage, review the information about private volumes and scratch volumes. Use private volumes and scratch volumes appropriately.
  - **Windows** Element addresses for library storage slots  
An element address is a number that indicates the physical location of a storage slot or drive within an automated library.

### Related tasks:

Labeling tape volumes

## Checking a single volume into a SCSI library

---

You can check in a single volume by issuing the CHECKIN LIBVOLUME command and specifying the SEARCH=NO parameter. IBM Spectrum Protect™ requests that the mount operator load the volume into the entry/exit port of the library.

## Procedure

---

1. Issue the CHECKIN LIBVOLUME command.

For example, to check in volume VOL001, enter the following command:

```
checkin libvolume tapelib vol001 search=no status=scratch
```

2. Respond to the prompt from the server.

- If the library has an entry/exit port, you are prompted to insert a tape into the entry/exit port.
- If the library does not have an entry/exit port, you are prompted to insert a tape into one of the slots in the library. Element addresses identify these slots. For example, the server finds that the first empty slot is at element address 5. The following message is returned:

```
ANR8306I 001: Insert 8MM volume VOL001 R/W in slot with element
address 5 of library TAPELIB within 60 minutes; issue 'REPLY' along
with the request ID when ready.
```

If you do not know the location of element address 5 in the library, check the worksheet for the device. To find the worksheet, review the documentation for your library. After you insert the volume as requested, respond to the message from an IBM Spectrum Protect administrative client. Issue the REPLY command, followed by the request number (the number at the beginning of the mount request) for example:

```
reply 1
```

Tip: Element addresses are sometimes numbered starting with a number other than 1. Check the worksheet to be sure. If no worksheet is listed for your device in IBM® Support Portal for IBM Spectrum Protect, see the documentation for your library.

If you specify a wait time of 0 by using the optional WAITTIME parameter on the CHECKIN LIBVOLUME command, a REPLY command is not required. The default wait time is 60 minutes.

## Checking in volumes from library storage slots

---

When you have many volumes to check in and you want to avoid issuing a CHECKIN LIBVOLUME command for each volume, you can search storage slots for new volumes. The server finds volumes that have not yet been added to the volume inventory.

### Procedure

---

1. Open the library and place the new volumes in unused slots. For example, for a SCSI device, open the library access door, place all of the new volumes in unused slots, and close the door.
2. If the volumes are not labeled, use the LABEL LIBVOLUME command to label the volume.
3. Issue the CHECKIN LIBVOLUME command with the SEARCH=YES parameter.

#### Related reference:

[CHECKIN LIBVOLUME \(Check a storage volume into a library\)](#)

## Checking in volumes from library entry/exit ports

---

You can search all slots of bulk entry/exit ports for labeled volumes and the server can check them in automatically.

### Before you begin

---

Issue the LABEL LIBVOLUME command to label volumes that are not labeled.

### About this task

---

For SCSI libraries, the server scans all of the entry/exit ports in the library for volumes. If a volume is found that contains a valid volume label, it is checked in automatically.

### Procedure

---

Issue the CHECKIN LIBVOLUME command and specify the SEARCH=BULK parameter.

- To load a tape in a drive and read the label, specify the CHECKLABEL=YES parameter. After the server reads the label, the server moves the tape from the drive to a storage slot.
- To have the server use the bar code reader to verify external labels on tapes, specify the CHECKLABEL=BARCODE parameter. When bar code reading is enabled, the server reads the label and moves the tape from the entry/exit port to a

storage slot.

## Checking in volumes by using library bar code readers

---

You can save time when you check in volumes to libraries that have bar code readers by using the characters on the bar code labels as names for the volumes.

### About this task

---

The server reads the bar code labels and uses the information to write the internal media labels. For volumes that have no bar code labels, the server mounts the volumes in a drive and attempts to read the internal, recorded label.

### Procedure

---

Issue the CHECKIN LIBVOLUME command with the CHECKLABEL=BARCODE parameter. For example, to use a bar code reader to search a library that is named TAPELIB and check in a scratch tape, issue the following command:

```
checkin libvolume tapelib search=yes status=scratch checklabel=barcode
```

## Checking in volumes by using a bar code reader

---

You can save time when you check in volumes by using a bar code reader, if your library has one.

### About this task

---

When you check in a volume, you can specify whether the media labels are read during check-in processing. When label-checking is on, IBM Spectrum Protect™ mounts each volume to read the internal label and checks in a volume only if it is correctly labeled. Label-checking can prevent future errors when volumes are used in storage pools, but also increases processing time at check-in.

If a volume has no bar code label, IBM Spectrum Protect mounts the volumes in a drive and attempts to read the recorded label.

### Procedure

---

To check in volumes by using a bar code reader, issue the CHECKIN LIBVOLUME command and specify CHECKLABEL=BARCODE. For example, to use the bar code reader to check in all volumes as scratch volumes in a library that is named TAPELIB, issue the following command:

```
checkin libvolume tapelib search=yes status=scratch checklabel=barcode
```

**Related tasks:**

Preparing removable media

**Related reference:**

[CHECKIN LIBVOLUME \(Check a storage volume into a library\)](#)

## Checking volumes into a full library with swapping

---

If no empty slots are available in the library when you are checking in volumes, the check-in operation fails unless you enable *swapping*. If you enable swapping and the library is full, the server selects a volume to eject and then checks in the volume that you requested.

### About this task

---

The server selects the volume to eject by checking first for any available scratch volume, then for the volume that is least frequently mounted. The server ejects the volume that it selects for the swap operation from the library and replaces the ejected volume with the volume that is being checked in.

### Procedure

---

To swap volumes if an empty library slot is not available to check in a volume, issue the CHECKIN LIBVOLUME command and specify the SWAP=YES parameter. For example, to check in a volume that is named VOL1 into a library that is named AUTO and



specify swapping, issue the following command:

```
checkin libvolume auto voll swap=yes
```

**Related tasks:**

Managing a full library with an overflow location

**Related reference:**

[CHECKIN LIBVOLUME](#) (Check a storage volume into a library)

## Private volumes and scratch volumes

To optimize tape storage, review the information about private volumes and scratch volumes. Use private volumes and scratch volumes appropriately.

Private volumes cannot be overwritten when a scratch mount is requested. You cannot check in a volume with scratch status when that volume is used by a storage pool, to export data, to back up a database or to back up to a backup set volume.

Partially written volumes are always private volumes. Volumes have a status of either scratch or private, but when IBM Spectrum Protect™ stores data on them, their status becomes private.

Table 1. Private volume and scratch volume uses

Type of volume	When to use
Private volumes	Use private volumes to regulate the volumes that are used by individual storage pools, and to manually control the volumes. To define private volumes, issue the DEFINE VOLUME command. For database restore, memory dumps, or loads, or for server import operations, you must specify private volumes.
Scratch volumes	In some cases, you can simplify volume management by using scratch volumes. You can use scratch volumes in the following circumstances: <ul style="list-style-type: none"><li>• When you do not need to define each storage pool volume.</li><li>• When you want to take advantage of the automation of robotic devices.</li><li>• When different storage pools share an automated library, and the storage pools can dynamically acquire volumes from the scratch volumes in the library. The volumes do not have to be preallocated to the storage pools.</li></ul>

**Related tasks:**

Changing the status of a volume in an automated library

**Related reference:**

[CHECKIN LIBVOLUME](#) (Check a storage volume into a library)

[DELETE VOLUME](#) (Delete a storage pool volume)

## Element addresses for library storage slots

An element address is a number that indicates the physical location of a storage slot or drive within an automated library.

If a library has entry/exit ports, you can add and remove media by using the ports. If no entry/exit port exists, you must load tapes into storage slots.

If you load tapes into storage slots, you must reply to mount requests that identify storage slots with element addresses. If you specify a wait time of 0 on the CHECKIN LIBVOLUME command or the LABEL LIBVOLUME command, you do not need to reply to a mount request.

For element addresses, see the device manufacturer's documentation or go to the IBM® Support Portal for IBM Spectrum Protect™ and search for element addresses.

**Related reference:**

- [CHECKIN LIBVOLUME](#) (Check a storage volume into a library)
- [LABEL LIBVOLUME](#) (Label a library volume)

## Managing volume inventory

---

You can manage volume inventory by controlling the server's access to volumes, by reusing tapes, and by reusing volumes that are used for database backup and export operations. You can also manage inventory by maintaining a supply of scratch volumes.

### About this task

---

Each volume that is used by a server must have a unique name, whether the volumes are used for storage pools, or used for operations such as database backup or export. Volumes that are in different libraries but that are used by the same server must also have a unique name.

- **Controlling access to volumes**  
You can use different methods to control access to volumes.
- **Reusing tapes**  
To ensure an adequate supply of tapes, you can expire old files, reclaim volumes, and delete volumes that reach end of life. You can also maintain a supply of scratch volumes.
- **Maintaining a supply of scratch volumes**  
You must set the maximum number of scratch volumes for a storage pool high enough for the expected usage.
- **AIX Linux Maintaining a supply of volumes in a library that contains WORM media**  
For libraries that contain Write Once Read Many (WORM) media, you can prevent cancellation of data storage transactions by maintaining a supply of scratch or new private volumes in the library. Canceled transactions can cause WORM media to be wasted.
- **Manage the volume inventory in automated libraries**  
The IBM Spectrum Protect™ server uses a library volume inventory to track scratch and private volumes that are available in an automated library. You must ensure that the inventory is consistent with the volumes that are physically in the library.

## Controlling access to volumes

---

You can use different methods to control access to volumes.

### Procedure

---

To control access to volumes, take any of the following actions:

- To prevent the server from mounting a volume, issue the UPDATE VOLUME command and specify the ACCESS=UNAVAILABLE parameter.
- To make volumes unavailable and send them offsite for protection, use a copy storage pool or an active-data storage pool.
- You can back up primary storage pools to a copy storage pool and then send the copy storage pool volumes offsite.
- You can copy active versions of client backup data to active-data storage pools, and then send the volumes offsite.
- You can track copy storage pool volumes and active-data pool volumes by changing their access mode to offsite, and updating the volume history to identify their location.

**Related reference:**

- [UPDATE VOLUME](#) (Update a storage pool volume)

## Reusing tapes

---

To ensure an adequate supply of tapes, you can expire old files, reclaim volumes, and delete volumes that reach end of life. You can also maintain a supply of scratch volumes.

### About this task

---

Over time, media age, and you might not need some of the backup data that is stored on the media. You can define server policies to determine how many backup versions are retained and how long they are retained. You can use expiration processing to delete files that you no longer require. You can keep the data that you require on the media. When you no longer require the data, you can then reclaim and reuse the media.

## Procedure

---

1. Delete unnecessary client data by regularly running expiration processing. Expiration processing deletes data that is no longer valid either because it exceeds the retention specifications in the policy or because users or administrators deleted the active versions of the data.
2. Reuse volumes in storage pools by running reclamation processing.

Reclamation processing consolidates any unexpired data by moving it from multiple volumes onto fewer volumes. The media can then be returned to the storage pool and reused.

3. Reuse volumes that contain outdated database backups or exported data that is no longer required by deleting volume history.

Before the server can reuse volumes that are tracked in the volume history, you must delete the volume information from the volume history file by issuing the DELETE VOLHISTORY command.

Tip: If your server uses the disaster recovery manager (DRM) function, the volume information is automatically deleted during MOVE DRMEDIA command processing.

4. Determine when tape volumes reach end of life. You can use the server to display statistics about volumes, including the number of write operations that are completed on the media and the number of write errors. Private volumes and scratch volumes display the following statistical data:

#### Private volumes

For media initially defined as private volumes, the server maintains this statistical data, even as the volume is reclaimed. You can compare the information with the number of write operations and write errors that are recommended by the manufacturer.

#### Scratch volumes

For media initially defined as scratch volumes, the server overwrites this statistical data each time the volumes are reclaimed.

5. Reclaim any valid data from volumes that reach end of life. If the volumes are in automated libraries, check them out of the volume inventory. Delete private volumes from the database with the DELETE VOLUME command.
6. Ensure that volumes are available for tape rotation so that the storage pool does not run out of space. You can use the Operations Center to monitor the availability of scratch volumes. Ensure that the number of scratch volumes is high enough to meet demand. For more information, see [Maintaining a supply of volumes in a library that contains WORM media](#). WORM media: Write Once Read Many (WORM) drives can waste media when the server cancels transactions because volumes are unavailable to complete the backup operation. After the server writes to WORM volumes, the space on the volumes cannot be reused, even if the transactions are canceled (for example, if a backup is canceled because of a shortage of media in the device). To minimize wasted WORM media, complete the following actions:
  - a. Ensure that the maximum number of scratch volumes for the device storage pool is at least equal to the number of storage slots in the library.
  - b. Check enough volumes into the device's volume inventory for the expected load.

If most backup operations are for small files, controlling the transaction size can affect how WORM platters are used.

Smaller transactions mean that less space is wasted when a transaction such as a backup operation must be canceled.

Transaction size is controlled by a server option, TXNGROUPMAX, and a client option, TXNBYTELIMIT.

#### Related tasks:

[Migrating data to upgraded drives](#)

[Managing server requests for volumes](#)

#### Related reference:

[DELETE VOLHISTORY](#) (Delete sequential volume history information)

[DELETE VOLUME](#) (Delete a storage pool volume)

[EXPIRE INVENTORY](#) (Manually start inventory expiration processing)

[Txnbytelimit option](#)

[TXNGROUPMAX server option](#)

---

## Maintaining a supply of scratch volumes

---

You must set the maximum number of scratch volumes for a storage pool high enough for the expected usage.

### About this task

---

When you define a storage pool, you must specify the maximum number of scratch volumes that the storage pool can use. The server automatically requests a scratch volume when needed. When the number of scratch volumes that the server is using for the storage pool exceeds the specified maximum, the storage pool can run out of space.

## Procedure

---

When a storage pool needs more than the maximum number of scratch volumes, you can take one or both of the following actions:

1. Increase the maximum number of scratch volumes by issuing the UPDATE STGPOOL command and specifying the MAXSCRATCH parameter.
2. Make volumes available for reuse by running expiration processing and reclamation to consolidate data onto fewer volumes.
  - a. Issue the EXPIRE INVENTORY command to run expiration processing.

Tip: By default this process automatically runs every day. You can also specify the EXPINTERVAL server option in the server options file, dsmserv.opt, to run expiration processing automatically. A value of 0 means that you must use the EXPIRE INVENTORY command to run expiration processing.
  - b. Issue the RECLAIM STGPOOL command to run reclamation processing.

Tip: You can also specify reclamation thresholds when you define the storage pool by using the DEFINE STGPOOL command and specifying the RECLAIMPROCESS parameter.

## What to do next

---

If you need more volumes for future backup operations, label more scratch volumes by using the LABEL LIBVOLUME command.

### Related tasks:

Maintaining a supply of scratch volumes in an automated library

### Related reference:

- [EXPIRE INVENTORY](#) (Manually start inventory expiration processing)
- [LABEL LIBVOLUME](#) (Label a library volume)
- [RECLAIM STGPOOL](#) (Reclaim volumes in a sequential-access storage pool)
- [UPDATE STGPOOL](#) (Update a storage pool)

## Maintaining a supply of volumes in a library that contains WORM media

---

For libraries that contain Write Once Read Many (WORM) media, you can prevent cancellation of data storage transactions by maintaining a supply of scratch or new private volumes in the library. Canceled transactions can cause WORM media to be wasted.

## About this task

---

IBM Spectrum Protect™ cancels a transaction if volumes, either private or scratch, are unavailable to complete the data storage operation. After IBM Spectrum Protect begins a transaction by writing to a WORM volume, the written space on the volume cannot be reused, even if the transaction is canceled.

For example, if you have WORM volumes that hold 2.6 GB each and a client starts to back up a 12 GB file. If IBM Spectrum Protect cannot acquire a fifth scratch volume after four volumes are full, IBM Spectrum Protect cancels the backup operation. The four volumes that IBM Spectrum Protect already filled cannot be reused.

To minimize cancellation of transactions, you must have enough volumes available in the library to manage expected client operations such as backups.

## Procedure

---

1. Ensure that the storage pool that is associated with the library has sufficient scratch volumes. Issue the UPDATE STGPOOL command and specify the MAXSCRATCH parameter.
2. To manage the expected load, check in a sufficient number of scratch or private volumes to the library by issuing the CHECKIN LIBVOLUME command.
3. To control transaction size, specify the TXNGROUPMAX server option and the TXNBYTELIMIT client option. If your clients tend to store small files, controlling the transaction size can affect how WORM volumes are used. Smaller transactions waste less space when a transaction such as a backup must be canceled.

### Related reference:

- CHECKIN LIBVOLUME (Check a storage volume into a library)
- UPDATE STGPOOL (Update a storage pool)
- Txnbytelimit option
- TXNGROUPMAX server option

## Manage the volume inventory in automated libraries

---

The IBM Spectrum Protect™ server uses a library volume inventory to track scratch and private volumes that are available in an automated library. You must ensure that the inventory is consistent with the volumes that are physically in the library.

The library volume inventory is separate from the inventory of volumes for each storage pool. To add a volume to a library volume inventory, you check in a volume to that IBM Spectrum Protect library.

A list of volumes in the library volume inventory might not be identical to a list of volumes in the storage pool inventory for the device. For example, you can check in scratch volumes to the library but you cannot define them to a storage pool. If scratch volumes are not selected for backup operations, you can define private volumes to a storage pool but you cannot check them into the volume inventory for the device.

To ensure that the volume inventory for the server library remains accurate, check out volumes to physically remove the volumes from a SCSI library. When you check out a volume that is used by a storage pool, the volume remains in the storage pool. If you must mount the volume when it is checked out, a message to the mount operator's console is displayed with a request to check in the volume. If the check-in operation is unsuccessful, the server marks the volume as unavailable.

When a volume is in the library volume inventory, you can change the status of the volume from scratch to private.

To check whether the volume inventory for the server library is consistent with the volumes that are physically in the library, you can audit the library. The inventory can become inaccurate if volumes are moved in and out of the library without informing the server by using volume check-in or check-out operations.

- Changing the status of a volume in an automated library  
You can change the status of a volume from private to scratch or from scratch to private.
- Removing volumes from an automated library  
You can remove volumes from an automated library if you exported data to a volume and want to import the data to another system. You might also want to remove volumes to create space for new volumes.
- Maintaining a supply of scratch volumes in an automated library  
When you define a storage pool that is associated with an automated library, you can specify a maximum number of scratch volumes equal to the physical capacity of the library. If the server is using a greater number of scratch volumes for the storage pool, you must ensure that enough volumes are available.
- Managing a full library with an overflow location  
As the demand for storage grows, the number of volumes that you need for a storage pool might exceed the physical capacity of an automated library. To make space available for new volumes and to monitor existing volumes, you can define an overflow location for a storage pool.
- Auditing the volume inventory in a library  
You can audit an automated library to ensure that the library volume inventory is consistent with the volumes that are physically in the library. You might want to audit a library if the library volume inventory is distorted due to manual movement of volumes in the library or to database problems.

### Related tasks:

Checking volumes into an automated library

### Related reference:

- AUDIT LIBRARY (Audit volume inventories in an automated library)

## Changing the status of a volume in an automated library

---

You can change the status of a volume from private to scratch or from scratch to private.

### Procedure

---

To change the status of a volume, issue the UPDATE LIBVOLUME command. For example, to change the status of a volume that is named VOL1 to a private volume, issue the following command:

```
update libvolume lib1 vol1 status=private
```

Restrictions:

- You cannot change the status of a volume from private to scratch if the volume belongs to a storage pool or is defined in the volume history file.
- Private volumes must be administrator-defined volumes with either no data or invalid data. They cannot be partially written volumes that contain active data. Volume statistics are lost when volume statuses are modified.

## Removing volumes from an automated library

---

You can remove volumes from an automated library if you exported data to a volume and want to import the data to another system. You might also want to remove volumes to create space for new volumes.

### About this task

---

By default, the server mounts the volume that you check out and verifies the internal label. When the label is verified, the server removes the volume from the library volume inventory, and then moves it to the entry/exit port or convenience I/O station of the library. If the library does not have an entry/exit port, the server requests that the mount operator remove the volume from a slot or device within the library.

### Procedure

---

- To remove a volume from an automated library, issue the CHECKOUT LIBVOLUME command.
- For automated libraries with multiple entry/exit ports, issue the CHECKOUT LIBVOLUME command and specify the REMOVE=BULK parameter. The server ejects the volume to the next available entry/exit port.

### What to do next

---

If you check out a volume that is defined in a storage pool and the server must access the volume later, the server requests that the volume be checked in. To return volumes to a library, issue the CHECKIN LIBVOLUME command.

**Related reference:**

- [CHECKIN LIBVOLUME \(Check a storage volume into a library\)](#)
- [CHECKOUT LIBVOLUME \(Check a storage volume out of a library\)](#)

## Maintaining a supply of scratch volumes in an automated library

---

When you define a storage pool that is associated with an automated library, you can specify a maximum number of scratch volumes equal to the physical capacity of the library. If the server is using a greater number of scratch volumes for the storage pool, you must ensure that enough volumes are available.

### Procedure

---

If the number of scratch volumes that the server is using for the storage pool exceeds the number that is specified in the storage pool definition, complete the following steps:

1. Add scratch volumes to the library by issuing the CHECKIN LIBVOLUME command.  
Tip: You might have to use an overflow location to move volumes out of the library to make room for these scratch volumes. For more information, see [Managing a full library with an overflow location](#).
2. Increase the maximum number of scratch volumes that can be added to a storage pool by issuing the UPDATE STGPOOL command and specifying the MAXSCRATCH parameter.

### What to do next

---

You might need more volumes for future recovery operations, so consider labeling and setting aside extra scratch volumes.

**Related tasks:**

[Maintaining a supply of scratch volumes](#)

## Managing a full library with an overflow location

---

As the demand for storage grows, the number of volumes that you need for a storage pool might exceed the physical capacity of an automated library. To make space available for new volumes and to monitor existing volumes, you can define an overflow location for a storage pool.

## About this task

---

The server tracks the volumes that are moved to the overflow area and makes storage slots available for new volumes.

## Procedure

---

1. Create a volume overflow location. Define or update the storage pool that is associated with the automated library by issuing the `DEFINE STGPOOL` or `UPDATE STGPOOL` command and specifying the `OVFLOCATION` parameter. For example, to create an overflow location that is named `ROOM2948` for a storage pool that is named `ARCHIVEPOOL`, issue the following command:

```
update stgpool archivepool ovflocation=Room2948
```

2. When you need to create space in the library for scratch volumes, move full volumes to the overflow location by issuing the `MOVE MEDIA` command. For example, to move all full volumes in the specified storage pool out of the library, issue the following command:

```
move media * stgpool=archivepool
```

3. Check in scratch volumes as needed.

Restriction: If a volume has an entry in the volume history file, you cannot check it in as a scratch volume. For more information, see [Checking volumes into an automated library](#).

4. Identify the empty scratch tapes in the overflow location by issuing the `QUERY MEDIA` command. For example, issue the following command:

```
query media * stg=* whereovflocation=Room2948 wherestatus=empty
```

5. If the server requests additional volumes, locate and check in volumes from the overflow location.

To find volumes in an overflow location, issue the `QUERY MEDIA` command. You can also use the `QUERY MEDIA` command to generate commands by checking in volumes.

For example, to list the volumes in the overflow location, and at the same time generate the commands to check those volumes into the library, issue a command that is similar to the following example:

```
query media format=cmd stgpool=archivepool whereovflocation=Room2948  
cmd="checkin libvol autolib &vol status=private"  
cmdfilename="\storage\move\media\checkin.vols"
```

### Tips:

- o Mount requests from the server include the location of the volumes.
- o To specify the number of days that must elapse before the volumes are eligible for processing, issue the `UPDATE STGPOOL` command and specify the `REUSEDELAY` parameter.
- o The file that contains the generated commands can be run by using the `IBM Spectrum Protect™ MACRO` command.

### Related reference:

- [MOVE MEDIA \(Move sequential-access storage pool media\)](#)
- [QUERY MEDIA \(Query sequential-access storage pool media\)](#)
- [UPDATE STGPOOL \(Update a storage pool\)](#)

## Auditing the volume inventory in a library

---

You can audit an automated library to ensure that the library volume inventory is consistent with the volumes that are physically in the library. You might want to audit a library if the library volume inventory is distorted due to manual movement of volumes in the library or to database problems.

## Procedure

---

1. Ensure that no volumes are mounted in the library drives. If any volumes are mounted in the `IDLE` state, issue the `DISMOUNT VOLUME` command to dismount them.

2. Audit the volume inventory by issuing the AUDIT LIBRARY command. Take one of the following actions:
  - o If the library has a bar code reader, you can save time by using the bar code reader to identify volumes. For example, to audit the TAPELIB library by using its bar code reader, issue the following command:
 

```
audit library tapelib checklabel=barcode
```
  - o If the library does not have a bar code reader, issue the AUDIT LIBRARY command without specifying CHECKLABEL=BARCODE. The server mounts each volume to verify the label. After the label is verified, the server completes auditing any remaining volumes.

## Results

The server deletes missing volumes from the inventory and updates the locations of volumes that moved since the last audit.

Restriction: The server cannot add new volumes to the inventory during an audit operation.

**Related tasks:**

Labeling tape volumes

**Related reference:**

[AUDIT LIBRARY \(Audit volume inventories in an automated library\)](#)

[DISMOUNT VOLUME \(Dismount a volume by volume name\)](#)

## Partially written volumes

Partially written volumes are always private volumes, even if their status was scratch before the server mounted them. The server tracks the original status of scratch volumes and returns them to scratch status when they are empty.

Except for volumes in automated libraries, the server is unaware of a scratch volume until after the volume is mounted. Then, the volume status changes to private, and the volume is automatically defined as part of the storage pool for which the mount request was made.

**Related tasks:**

Changing the status of a volume in an automated library

## Operations with shared libraries

Shared libraries are logical libraries that are represented physically by SCSI libraries. The physical library is controlled by the IBM Spectrum Protect™ server that is configured as a library manager. IBM Spectrum Protect servers that use the SHARED library type are library clients to the IBM Spectrum Protect library manager server.

The library client contacts the library manager when the library manager starts and the storage device initializes, or after a library manager is defined to a library client. The library client confirms that the contacted server is the library manager for the named library device. The library client also compares drive definitions with the library manager for consistency. The library client contacts the library manager for each of the following operations:

**Volume mount**

A library client sends a request to the library manager for access to a particular volume in the shared library device. For a scratch volume, the library client does not specify a volume name. If the library manager cannot access the requested volume, or if scratch volumes are unavailable, the library manager denies the mount request. If the mount is successful, the library manager returns the name of the drive where the volume is mounted.

**Volume release**

When a library client no longer needs to access a volume, it notifies the library manager that the volume can be returned to a scratch volume. The library manager database is updated with the new location for the volume, which is now in the inventory of the library server. The volume is deleted from the volume inventory of the library client.

Table 1 shows the interaction between library clients and the library manager in processing IBM Spectrum Protect operations.

Table 1. How SAN-enabled servers process IBM Spectrum Protect operations

Operation (Command)	Library manager	Library client



<b>Operation (Command)</b>	<b>Library manager</b>	<b>Library client</b>
Query library volumes  (QUERY LIBVOLUME)	Displays the volumes that are checked into the library. For private volumes, the owner server is also displayed.	Not applicable.
Check in and check out library volumes  (CHECKIN LIBVOLUME, CHECKOUT LIBVOLUME)	Sends the commands to the library device.	Not applicable.  When a check-in operation is required because of a client restore operation, a request is sent to the library manager server.
Move media and move DRM media  (MOVE MEDIA, MOVE DRMEDIA)	Valid only for volumes that are used by the library manager server.	Requests that the library manager server completes the operation. Generates a check-out process on the library manager server.
Audit library inventory  (AUDIT LIBRARY)	Synchronizes the inventory with the library device.	Synchronizes the inventory with the library manager server.
Label a library volume  (LABEL LIBVOLUME)	Labels and checks in volumes.	Not applicable.
Dismount a volume  (DISMOUNT VOLUME)	Sends the request to the library device.	Requests that the library manager server completes the operation.
Query a volume  (QUERY VOLUME)	Checks whether the volume is owned by the requesting library client and checks whether the volume is in the library device.	Requests that the library manager server completes the operation.

## Managing server requests for volumes

IBM Spectrum Protect™ displays requests and status messages to all administrative command-line clients that are started in console mode. These request messages often have a time limit. Successful server operations must be completed within the time limit that is specified; otherwise, the operation times out.

### About this task

For automated libraries, use the CHECKIN LIBVOLUME and LABEL LIBVOLUME commands to insert cartridges into slots. If you specify a value for the WAITTIME parameter, a reply message is displayed. If the value of the parameter is 0, no reply is required. When you issue the CHECKOUT LIBVOLUME command, you must insert cartridges into slots and, in all cases, a reply message is displayed.

## Procedure

The following table provides information about how to handle different server media tasks.

Task	Details
Use the administrative client for mount messages	<p>The server sends mount request status messages to the server console and to all administrative command-line clients in mount mode or console mode.</p> <p>To start an administrative command-line client in mount mode, issue the <code>dsmadm -mountmode</code> command on the administrative command-line client.</p>
Receive messages about automated libraries	<p>You can view mount messages and error messages about automated libraries on administrative command-line clients in mount mode or console mode. Mount messages are sent to the library and not to an operator. Messages about problems with the library are sent to the mount message queue.</p>
Get information about pending operator requests	<p>To get information about pending operator requests, issue the <code>QUERY REQUEST</code> command or view the mount message queue on an administrative command-line client that is started in mount mode. When you issue the <code>QUERY REQUEST</code> command, the server displays requested actions and the amount of time that is remaining before the requests time out.</p>
Reply to operator requests	<p>When the server requires an explicit reply to a completed mount request, use the <code>REPLY</code> command.</p> <p>The <code>request_number</code> parameter specifies the request identification number that tells the server which pending operator request is completed. This three-digit number is always displayed as part of the request message.</p>
Cancel an operator request	<p>To cancel a mount request for a library, issue the <code>CANCEL REQUEST</code> command. For most requests that are associated with automated SCSI libraries, an operator must complete a hardware or system action to cancel the requested mount. For such requests, the <code>CANCEL REQUEST</code> command is not accepted by the server.</p> <p>The <code>CANCEL REQUEST</code> command must include the request identification number. This number is included in the request message.</p> <p>If you want to mark the requested volume as <code>UNAVAILABLE</code>, issue the <code>CANCEL REQUEST</code> command and specify the <code>PERMANENT</code> parameter. If you specify the <code>PERMANENT</code> parameter, the server does not try to mount the requested volume again. This is useful if, for example, the volume is at a remote site or is otherwise unavailable.</p>
Respond to a volume check-in request	<p>If the server cannot find a particular volume to mount in an automated library, the server requests that the operator check in the volume.</p> <p>If the requested volume is available, place the volume in the library and check it in. For more information, see <a href="#">Checking volumes into an automated library</a>.</p> <p>If the requested volume is unavailable, update the access mode of the volume by issuing the <code>UPDATE VOLUME</code> command and specifying the <code>ACCESS=UNAVAILABLE</code> parameter. Then, cancel the check-in request by using the <code>CANCEL REQUEST</code> command. Do not cancel the client process that caused the request. Use the <code>QUERY REQUEST</code> command to obtain the ID of the request that you want to cancel.</p> <p>If you do not respond to the check-in request from the server within the mount-wait period that is specified for the device class for the storage pool, the server marks the volume as unavailable.</p>
Determine which volumes are mounted	<p>For a report about all volumes that are currently mounted for use by the server, issue the <code>QUERY MOUNT</code> command. The report shows which volumes are mounted, which drives accessed them, and whether the volumes are in use.</p>

Task	Details
Dismount idle volumes	<p>When a volume is idle, the server keeps it mounted for a time that is specified by the mount retention parameter for the device class. Using a mount retention value can reduce the access time when volumes are used repeatedly.</p> <p>To dismount an idle volume from the drive where it is mounted, issue the DISMOUNT VOLUME command.</p> <p>For information about setting mount retention times, see Controlling the amount of time that a volume remains mounted.</p>

**Related reference:**

[QUERY REQUEST](#) (Query one or more pending mount requests)

## Managing tape drives

You can query, update, and delete tape drives. You can also clean tape drives and configure tape drive encryption and data validation.

- **Updating drives**  
You can change the attributes of a drive definition to take a drive offline or reconfigure it.
- **Data validation during read/write operations to tape**  
To validate data and identify data that is corrupted, you can use a feature that is called logical block protection. If you use logical block protection, IBM Spectrum Protect inserts a cyclic redundancy check (CRC) value at the end of each logical block of data while it is written to tape.
- **Cleaning tape drives**  
You can use the server to manage tape-drive cleaning. The server can control how tape drives in SCSI libraries are cleaned.
- **Tape drive replacement**  
If you replace a drive in a tape library that is defined to IBM Spectrum Protect, you must delete the drive and path definitions for the old drive and define the new drive and path.

## Updating drives

You can change the attributes of a drive definition to take a drive offline or reconfigure it.

### About this task

You can change the following attributes of a drive:

- The element address, if the drive is in a SCSI
- The cleaning frequency
- The drive status: online or offline

**Restriction:** If a drive is in use, you cannot change the element number or the device name. For instructions about taking drives offline, see Taking tape drives offline.

If a volume is mounted in the drive but the volume is idle, it can be explicitly dismounted. For instructions about dismounting idle volumes, see Managing server requests for volumes.

### Procedure

- Change the element address of a drive by issuing the UPDATE DRIVE command. For example, in a library that is named AUTO, change the element address of DRIVE3 to 119 by issuing the following command:

```
update drive auto drive3 element=119
```

- Change the device name of a drive by issuing the UPDATE PATH command. For example, to change the device name of a drive that is named DRIVE3, issue the following command: **AIX**

```
update path server1 drive3 srctype=server desttype=drive library=scsilib
device=/dev/rmt0
```

**Linux**

```
update path server1 drive3 srctype=server desttype=drive library=scsilib
device=/dev/IBMtape0
```

#### Windows

```
update path server1 drive3 srctype=server desttype=drive library=scsilib
device=mt3.0.0.0
```

- Taking tape drives offline

You can take a tape drive offline while it is in use. For example, you might take a drive offline to complete maintenance.

#### Related reference:

[UPDATE DRIVE \(Update a drive\)](#)

[UPDATE PATH \(Change a path\)](#)

## Data validation during read/write operations to tape

---

To validate data and identify data that is corrupted, you can use a feature that is called logical block protection. If you use logical block protection, IBM Spectrum Protect™ inserts a cyclic redundancy check (CRC) value at the end of each logical block of data while it is written to tape.

With logical block protection, you can identify errors that occur when data is written to tape and during data transfer from the tape drive to IBM Spectrum Protect through the storage area network. Drives that support logical block protection validate data during read and write operations. The IBM Spectrum Protect server validates data during read operations.

If validation by the drive fails during write operations, the failure can indicate that data was corrupted during transfer to tape. In this case, the IBM Spectrum Protect server fails the write operation. You must restart the operation to continue. If validation by the drive fails during read operations, the failure can indicate that the tape media is corrupted. If validation by the IBM Spectrum Protect server fails during read operations, the failure can indicate that data was corrupted during transfer from the tape drive, and the server tries the operation again. If validation fails consistently, the IBM Spectrum Protect server issues an error message that indicates hardware or connection problems.

If logical block protection is disabled on a tape drive, or the drive does not support logical block protection, the IBM Spectrum Protect server can read protected data. However, the data is not validated.

Logical block protection is superior to the CRC validation that you can specify when you define or update a storage pool. When you specify CRC validation for a storage pool, data is validated only during volume auditing operations. Errors are identified after the data is written to tape.

#### Restrictions:

- You cannot use logical block protection for sequential data such as backup sets and database backups.
- CRC checking impacts performance because more processor usage is required on both the client and server to calculate and compare CRC values.
- For a scratch volume, if you specify logical block protection for read/write operations (LBPROTECT=READWRITE), do not change the parameter value at any time after data is written to the volume. Changing the parameter value during the life of the volume on the IBM Spectrum Protect server is not supported.
- Drives that support logical block protection  
Logical block protection is available only for 3592, LTO, and ECARTRIDGE device types. Capable 3592 drives include IBM TS1130, TS1140, and later generations. Capable LTO drives include IBM LTO-5 and supported LTO-6 drives. Capable Oracle StorageTek drives include drives with the T10000C and T10000D format.
- Enabling and disabling logical block protection  
You can specify logical block protection for read and write operations, or only for write operations. You can also disable logical block protection. By default, logical block protection is disabled because of performance effects that result from cyclic redundancy check (CRC) validation on the server and the tape drive.
- Read/write operations to volumes with logical block protection  
Read/write operations to empty or filling volumes depend on whether the volumes have logical block protection. Protected and unprotected data blocks cannot be mixed on the same volume.
- Storage pool management in a tape library  
To mix protected and unprotected data in a library, you must create different device classes and different storage pools to separate the data. If a device class is associated with protected data, you can specify logical block protection for read and write operations or for write operations only.

## Drives that support logical block protection

---

Logical block protection is available only for 3592, LTO, and ECARTRIDGE device types. Capable 3592 drives include IBM TS1130, TS1140, and later generations. Capable LTO drives include IBM LTO-5 and supported LTO-6 drives. Capable Oracle StorageTek drives include drives with the T10000C and T10000D format.

The following table shows the media and the formats that you can use with drives that support logical block protection.

Drive	Tape media	Drive formats
IBM TS1130	3592 Generation 2	3592-3 and 3592-3C
IBM TS1140	3592 Generation 2 3592 Generation 3	Generation 2: 3592-3 and 3592-3C Generation 3: 3592-4 and 3592-4C
IBM TS1150	3592 Generation 3 3592 Generation 4	Generation 4: 3592-5 and 3592-5C
IBM LTO-5	LTO-5	Ultrium 5 and Ultrium 5C
IBM LTO-6	LTO-6 LTO-5	Ultrium 6 and Ultrium 6C Ultrium 5 and Ultrium 5C
IBM LTO-7	LTO-7 LTO-6	Ultrium 7 and Ultrium 7C Ultrium 6 and Ultrium 6C
Oracle T10000C	Oracle StorageTek T10000 T2	T10000C and T10000C-C
Oracle T10000D	Oracle StorageTek T10000 T2	T10000D and T10000D-C

Tips:

- To enable logical block protection for a tape volume and then reuse the volume to back up data, you must enable logical block protection for the device class and the drive.
- If you have a 3592, LTO, or Oracle StorageTek drive that is not capable of logical block protection, you can upgrade the drive with firmware that provides logical block protection.

Logical block protection is available for drives that are in SCSI libraries. For the most current information about support for logical block protection, see technote 1568108.

To use logical block protection for write operations, all drives in the library must support logical block protection. If a drive is not capable of logical block protection, volumes that have read/write access are not mounted. However, the server can use the drive to mount volumes that have read-only access. The protected data is read and validated by the IBM Spectrum Protect™ server if logical block protection is enabled for read/write operations.

## Enabling and disabling logical block protection

---

You can specify logical block protection for read and write operations, or only for write operations. You can also disable logical block protection. By default, logical block protection is disabled because of performance effects that result from cyclic redundancy check (CRC) validation on the server and the tape drive.

### About this task

---

Read/write operations to empty or filling volumes depend on whether the volumes have logical block protection. Protected and unprotected data blocks cannot be mixed on the same volume. If you change the setting for logical block protection, the change applies only to empty volumes. Filling and full volumes maintain their status of logical block protection until they are empty and ready to be refilled. For example, if you disable logical block protection and the server selects a volume that is associated with a device class that has logical block protection, the server continues writing protected data to the volume.

Restriction: Logical block protection is available only for certain device types. For more information, see Drives that support logical block protection.

## Procedure

---

1. To enable logical block protection for the 3592, LTO, and ECARTRIDGE device types, issue the DEFINE DEVCLASS or the UPDATE DEVCLASS command and specify the LBPROTECT parameter. For example, to specify logical block protection during read and write operations for a 3592 device class that is named 3592\_lbprotect, issue the following command:

```
define devclass 3592_lbprotect library=3594 lbprotect=readwrite
```

Tips:

- o If you update the value of the LBPROTECT parameter from NO to READWRITE or WRITEONLY and the server selects a filling volume without logical block protection for write operations, the server issues a message each time the volume is mounted. The message indicates that data is written to the volume without logical block protection. To prevent this message from displaying or to have IBM Spectrum Protect™ write data only with logical block protection, update the access of filling volumes without logical block protection to read-only.
  - o To improve performance, do not specify the CRCDATA parameter on the DEFINE STGPOOL or UPDATE STGPOOL command.
  - o When data is validated during read operations by both the drive and by the IBM Spectrum Protect server, it can slow server performance during restore and retrieve operations. To reduce the time that is required for restore and retrieve operations, change the setting of the LBPROTECT parameter from READWRITE to WRITEONLY. After data is restored or retrieved, you can reset the LBPROTECT parameter to READWRITE.
2. To disable logical block protection, issue the DEFINE DEVCLASS or the UPDATE DEVCLASS command and specify the LBPROTECT=NO parameter.

Restriction: If logical block protection is disabled, the server does not write to an empty tape with logical block protection. However, if a filling volume with logical block protection is selected, the server continues to write to the volume with logical block protection. To prevent the server from writing to tapes with logical block protection, change the access of filling volumes with logical block protection to read-only. When data is read, the CRC results are not checked by the drive or server.

If a disaster occurs and the disaster recovery site does not have drives that support logical block protection, you must specify the LBPROTECT=NO parameter. If the tape drives are used for write operations, you must change the volume access for volumes with protected data to read-only to prevent the server from using the volumes.

If the server must enable logical block protection, the server issues an error message that indicates that the drive does not support logical block protection.

## What to do next

---

To determine whether a volume has logical block protection, issue the QUERY VOLUME command and review the value in the Logical Block Protection field.

**Related reference:**

- [DEFINE DEVCLASS \(Define a device class\)](#)
- [DEFINE STGPOOL \(Define a volume in a storage pool\)](#)
- [QUERY VOLUME \(Query storage pool volumes\)](#)
- [UPDATE DEVCLASS \(Update a device class\)](#)
- [UPDATE STGPOOL \(Update a storage pool\)](#)

## Read/write operations to volumes with logical block protection

---

Read/write operations to empty or filling volumes depend on whether the volumes have logical block protection. Protected and unprotected data blocks cannot be mixed on the same volume.

If you use the UPDATE DEVCLASS command to change the setting for logical block protection, the change applies only to empty volumes. Filling and full volumes maintain their status of logical block protection until they are empty and ready to be refilled.

For example, suppose that you change the value of the LBPROTECT parameter from READWRITE to NO. If the server selects a volume that is associated with the device class and that has logical block protection, the server continues writing protected data to the volume.

Tips:

- If a drive does not support logical block protection, volumes with logical block protection for write operations cannot be mounted. To prevent the server from mounting the protected volumes for write operations, change the volume access to

read-only. Also, disable logical block protection to prevent the server from enabling the feature on the tape drive.

- If a drive does not support logical block protection, and logical block protection is disabled, the server reads data from protected volumes. However, the data is not validated by the server and the tape drive.

**Related reference:**

- [QUERY VOLUME](#) (Query storage pool volumes)
- [UPDATE DEVCLASS](#) (Update a device class)

## Storage pool management in a tape library

---

To mix protected and unprotected data in a library, you must create different device classes and different storage pools to separate the data. If a device class is associated with protected data, you can specify logical block protection for read and write operations or for write operations only.

To define device classes and storage pools for a TS3500 library that has LTO-5 drives, for protected and unprotected data, you can issue a series of commands as shown in the following example:

```
define library 3584 libtype=scsi
define devclass lbprotect library=3584 devicetype=lto lbprotect=readwrite
define devclass normal library=3584 devicetype=lto lbprotect=no
define stgpool lbprotect_pool lbprotect maxscratch=10
define stgpool normal_pool normal maxscratch=10
```

**Related reference:**

- [DEFINE DEVCLASS](#) (Define a device class)
- [DEFINE LIBRARY](#) (Define a library)
- [DEFINE STGPOOL](#) (Define a volume in a storage pool)

## Cleaning tape drives

---

You can use the server to manage tape-drive cleaning. The server can control how tape drives in SCSI libraries are cleaned.

### About this task

---

You must have system privilege or unrestricted storage privilege to clean tape drives. For automated libraries, you can automate cleaning by specifying the frequency of cleaning operations and checking a cleaner cartridge into the library volume inventory. IBM Spectrum Protect™ mounts the cleaner cartridge as specified. There are special considerations if you plan to use server-controlled drive cleaning with a SCSI library that provides automatic drive cleaning support in its device hardware.

**Tip:** If an automated tape library supports library-drive cleaning, ensure that the feature is enabled.

You can prevent premature wear on the read/write heads of drives by using the library cleaning functions that are available from your device manufacturer.

Drives and libraries from manufacturers differ in how they manage cleaner cartridges, and how they report the presence of a cleaner cartridge in a drive. The device driver might not be able to open a drive that contains a cleaner cartridge. Sense codes and error codes that are issued by devices for drive cleaning vary. Library-drive cleaning is usually not known to applications. Therefore, IBM Spectrum Protect might not always detect the cleaner cartridges in drives and might not be able to determine when cleaning begins.

Some devices require a small amount of idle time between mount requests to start drive cleaning. However, IBM Spectrum Protect tries to minimize the idle time for a drive. The result might be to prevent the library drive cleaning from functioning effectively. If this happens, use IBM Spectrum Protect to control drive cleaning. You can set the frequency to match the cleaning recommendations from the manufacturer.

- **Methods for cleaning tape drives**  
Over time, the read heads on tapes can get dirty, which can cause read and write operations to fail. To prevent these issues, enable tape cleaning. You can enable tape cleaning from the drive or from IBM Spectrum Protect.
- **Configuring the server for drive cleaning in an automated library**  
When you configure server-controlled drive cleaning in an automated library, you can specify how often you want the drives to be cleaned.
- **Resolving errors that are related to drive cleaning**  
While moving cartridges within a library, you might place a data cartridge where a cleaner cartridge should be. Review the

process that the server completes and the messages that are issued so that you can resolve the issue.

## Methods for cleaning tape drives

---

Over time, the read heads on tapes can get dirty, which can cause read and write operations to fail. To prevent these issues, enable tape cleaning. You can enable tape cleaning from the drive or from IBM Spectrum Protect™.

You can choose to use the library-drive cleaning method or the IBM Spectrum Protect drive-cleaning method, but not both. Some SCSI libraries provide automatic drive cleaning. Select the library-drive cleaning method if it is available. If it is unavailable or causes issues, use IBM Spectrum Protect to control library drive cleaning.

### Library drive-cleaning method

The library drive-cleaning method provides several advantages for automated tape libraries that use this function:

- Reduces the burden on the IBM Spectrum Protect administrator to physically manage cartridge cleaning.
- Improves cleaning cartridge usage rates. Most tape libraries track the number of times that drives can be cleaned based on hardware indicators. IBM Spectrum Protect uses a raw count.
- Reduces unnecessary cleaning. Modern tape drives do not have to be cleaned at fixed intervals and can detect and request when cleaning is required.

Manufacturers who provide a library drive-cleaning method recommend its use to prevent premature wear on the read/write heads of the drives. Drives and libraries from different manufacturers differ in how they manage cleaner cartridges and how they report the presence of a cleaner cartridge in a drive. The device driver might not be able to open a drive that contains a cleaner cartridge. Sense codes and error codes that are issued by devices for drive cleaning vary. Library drive cleaning is usually transparent to all applications. However, IBM Spectrum Protect might not always detect cleaner cartridges in drives and might not be able to determine when cleaning begins.

### IBM Spectrum Protect drive cleaning method

Some devices require a small amount of idle time between mount requests to start drive cleaning. However, IBM Spectrum Protect tries to minimize the idle time for a drive. The result might be to prevent the library drive cleaning from functioning effectively. If this happens, try using IBM Spectrum Protect to control drive cleaning. Set the frequency to match the cleaning recommendations from the manufacturer.

If IBM Spectrum Protect controls the drive-cleaning process, disable the library drive-cleaning function to prevent problems. If the library drive-cleaning function is enabled, some devices automatically move any cleaner cartridge that is found in the library to slots in the library that are dedicated to cleaner cartridges. You cannot check a cleaner cartridge into the IBM Spectrum Protect library inventory until you disable the library drive-cleaning function.

To enable cleaning from the drive, follow the instructions that are provided by the drive manufacturer. To enable cleaning by using IBM Spectrum Protect, see *Configuring the server for drive cleaning in an automated library*.

## Configuring the server for drive cleaning in an automated library

---

When you configure server-controlled drive cleaning in an automated library, you can specify how often you want the drives to be cleaned.

### Before you begin

---

Determine how often the drive must be cleaned. This step is required so that you can specify an appropriate value for the CLEANFREQUENCY parameter on the DEFINE DRIVE or UPDATE DRIVE command. For example, to clean a drive after 100 GB of data is processed on the drive, you would specify CLEANFREQUENCY=100.

For guidelines about cleaning frequency, see the drive manufacturer's documentation. If the documentation provides guidelines for cleaning frequency in terms of hours of use, convert the value to a gigabyte value by completing the following steps:

1. Use the bytes-per-second value for the drive to determine a gigabytes-per-hour value.
2. Multiply the gigabytes-per-hour value by the recommended hours of use between cleanings.
3. Use the result as the cleaning frequency value.

You can either specify a value for the CLEANFREQUENCY parameter or specify ASNEEDED to clean the drive as needed. Restrictions:



1. For IBM® 3592 drives, you must specify a numerical value for the CLEANFREQUENCY parameter. By using the cleaning frequency that is listed in the product documentation, you will not overclean the drives.
2. The CLEANFREQUENCY=ASNEEDED parameter value does not work for all tape drives. To determine whether a drive supports this function, see the information for your operating system:
  - o [AIX](#) | [Windows](#) Supported devices for AIX and Windows
  - o [Linux](#) Supported devices for Linux

In the technote, click the drive name to view detailed information. If the ASNEEDED value is not supported, specify the number of gigabytes.

## Procedure

---

To configure server-controlled drive cleaning in an automated library, complete the following steps:

Define or update the drives in the library, by using the CLEANFREQUENCY parameter in the DEFINE DRIVE or UPDATE DRIVE command. For example, to clean a drive that is named DRIVE1 after 100 GB of data is processed, issue the following command:

```
update drive autolib1 drive1 cleanfrequency=100
```

## Results

---

After the cleaner cartridge is checked in, the server mounts the cleaner cartridge in a drive when the drive needs cleaning. The server uses that cleaner cartridge for the number of specified cleanings. For more information, see Operations with cleaner cartridges.

## What to do next

---

Check the cleaner cartridge into the library volume inventory by following the instructions in Checking a cleaner cartridge into a library.

- [Checking a cleaner cartridge into a library](#)  
To enable automatic tape-drive cleaning, you must check a cleaner cartridge into the volume inventory of the automated library.
- [Operations with cleaner cartridges](#)  
To ensure that tape drives are cleaned when necessary, and to avoid issues with tape storage, follow the guidelines.

### Related reference:

[DEFINE DRIVE](#) (Define a drive to a library)

[UPDATE DRIVE](#) (Update a drive)

## Checking a cleaner cartridge into a library

---

To enable automatic tape-drive cleaning, you must check a cleaner cartridge into the volume inventory of the automated library.

## About this task

---

When you check a cleaner cartridge into a library, ensure that it is correctly identified to the server as a cleaner cartridge. Ensure that a cleaner cartridge is not in a slot that is detected by the search process. Errors and delays of 15 minutes or more might indicate that a cleaner cartridge is improperly placed.

The preferred method is to check in cleaner cartridges individually. If you have to check in both data cartridges and cleaner cartridges, place the data cartridges in the library and check them in first. Then, check the cleaner cartridge in to the library.

## Procedure

---

To check a cleaner cartridge into a library, issue the CHECKIN LIBVOLUME command. For example, to check in a cleaner cartridge that is named AUTOLIB1, issue the following command:

```
checkin libvolume autolib1 cleanv status=cleaner cleanings=10  
checklabel=no
```

The server requests that the cartridge is placed in the entry/exit port, or into a specific slot.

### Related reference:

➤ CHECKIN LIBVOLUME (Check a storage volume into a library)

## Operations with cleaner cartridges

---

To ensure that tape drives are cleaned when necessary, and to avoid issues with tape storage, follow the guidelines.

### Monitoring the cleaning process

If a cleaner cartridge is checked in to a library, and a drive must be cleaned, the server dismounts the data volume and runs the cleaning operation. If the cleaning operation fails or is canceled, or if no cleaner cartridge is available, you might not be aware that the drive needs cleaning. Monitor cleaning messages for these problems to ensure that drives are cleaned as needed. If necessary, issue the CLEAN DRIVE command to have the server try the cleaning again, or manually load a cleaner cartridge into the drive.

### Using multiple cleaner cartridges

The server uses a cleaner cartridge for the number of cleanings that you specify when you check in the cleaner cartridge. If you check in two or more cleaner cartridges, the server uses only one of the cartridges until the designated number of cleanings for that cartridge is reached. Then, the server uses the next cleaner cartridge. If you check in two or more cleaner cartridges and issue two or more CLEAN DRIVE commands concurrently, the server uses multiple cartridges at the same time and decrements the remaining cleanings on each cartridge.

### Related reference:

- AUDIT LIBRARY (Audit volume inventories in an automated library)
- CHECKIN LIBVOLUME (Check a storage volume into a library)
- CLEAN DRIVE (Clean a drive)
- LABEL LIBVOLUME (Label a library volume)
- QUERY LIBVOLUME (Query a library volume)

## Resolving errors that are related to drive cleaning

---

While moving cartridges within a library, you might place a data cartridge where a cleaner cartridge should be. Review the process that the server completes and the messages that are issued so that you can resolve the issue.

When a drive needs cleaning, the server loads what its database shows as a cleaner cartridge into the drive. The drive then moves to a READY state, and IBM Spectrum Protect™ detects that the cartridge is a data cartridge. The server completes the following steps:

1. The server attempts to read the internal tape label of the data cartridge.
2. The server ejects the cartridge from the drive and moves it back to the home slot of the cleaner cartridge within the library. If the eject operation fails, the server marks the drive offline and issues a message that the cartridge is still in the drive.
3. The server checks out the cleaner cartridge to avoid selecting it for another drive cleaning request. The cleaner cartridge remains in the library but no longer appears in the IBM Spectrum Protect library inventory.
4. By using the internal tape label, the server checks the volume name against the current library inventory, storage pool volumes, and the volume history file.
  - If the volume name is not found in the library inventory, a data cartridge might be checked in as a cleaner cartridge by mistake. When the volume is checked out, you do not have to take further action.
  - If the volume name is found in the library inventory, the server issues messages that manual intervention and a library audit are required. To resolve the issue, follow the instructions in Auditing the volume inventory in a library.

## Tape drive replacement

---

If you replace a drive in a tape library that is defined to IBM Spectrum Protect™, you must delete the drive and path definitions for the old drive and define the new drive and path.

Replacing drive and path definitions is required even if you are exchanging one drive for another of the same type, with the same logical address, physical address, SCSI ID, and port number. Device alias names can change when you change your drive connections.

If the new drive is an upgrade that supports a new media format, you might be required to define a new logical library, device class, and storage pool. Procedures for setting up a policy for a new drive in a multiple-drive library vary, depending on the types of drives and media in the library.

- Deleting tape drives  
You can delete tape drives from a library. For example, you can delete a drive that you no longer use, or a drive that you want to replace.
- Replacing drives with others of the same type  
To add a drive that supports the same media formats as the drive it replaces, you must define a new drive and path.
- Migrating data to upgraded drives  
If you upgrade all of the tape drives in a library, you can preserve your existing policy definitions to migrate and expire existing data, and you can use the new drives to store data.

## Deleting tape drives

---

You can delete tape drives from a library. For example, you can delete a drive that you no longer use, or a drive that you want to replace.

### Procedure

---

1. Stop the IBM Spectrum Protect™ server and shut down the operating system.
2. Remove the old drive and follow the manufacturer's instructions to install the new drive.
3. Restart the operating system and the IBM Spectrum Protect server.
4. Delete the path from the server to the drive. For example, to delete a path from SERVER1 to LIB1, issue the following command:

```
delete path server1 lib1 srctype=server desttype=drive
```

5. Delete the drive definition. For example, issue the following command to delete a drive that is named DLT1 from a library device that is named LIB1:

```
delete drive lib1 dlt1
```

#### Related reference:

[DELETE DRIVE \(Delete a drive from a library\)](#)

[DELETE PATH \(Delete a path\)](#)

## Replacing drives with others of the same type

---

To add a drive that supports the same media formats as the drive it replaces, you must define a new drive and path.

### About this task

---

If a library includes only one model of drive and you want to replace a drive, you must replace the drive with the same model drive. If a library includes mixed models of drives and you want to replace a drive, you can replace the drive with any model drive that exists in the library.

### Procedure

---

1. Delete the path and drive definitions for the old drive. For example, to delete a drive that is named DRIVE1 from a library that is named LIB1, enter the following command:

```
delete path server2 drive1 srctype=server desttype=drive library=lib1
delete drive lib1 drive1
```

2. Power off the library, remove the original drive, replace it with the new drive, and power on the library.
3. Refresh the host system to ensure that the system detects the new drive.
4. Define the new drive and path. For example, to define a new drive, DRIVE2, and a path to it from SERVER2, if you are using the IBM Spectrum Protect™ device driver, enter the following commands:

**AIX**

```
define drive lib1 drive2
define path server2 drive2 srctype=server desttype=drive library=lib1
device=/dev/mt0
```

**Linux**

```
define drive lib1 drive2
define path server2 drive2 srctype=server desttype=drive library=lib1
device=/dev/tmscsi/mt0
```

#### Windows

```
define drive lib1 drive2
define path server2 drive2 srctype=server desttype=drive library=lib1
device=mt3.0.0.1
```

Tip: You can use your existing library, device class, and storage pool definitions.

#### Related reference:

- [DELETE DRIVE \(Delete a drive from a library\)](#)
- [DELETE PATH \(Delete a path\)](#)

## Migrating data to upgraded drives

---

If you upgrade all of the tape drives in a library, you can preserve your existing policy definitions to migrate and expire existing data, and you can use the new drives to store data.

### Before you begin

---

The following scenario assumes that you already have a primary storage pool for a DISK device class that is named POOL1.

### Procedure

---

1. To migrate data to a storage pool that is created for the new drives, specify the NEXTSTGPOOL parameter. For example, to migrate data from an existing storage pool, POOL1, to the new storage pool, POOL2, issue the following command:

```
update stgpool pool1 nextstgpool=pool2
```

2. Update the management-class definitions to store data in the DISK storage pool by using the UPDATE MGMTCLASS command.

#### Related reference:

- [DEFINE STGPOOL \(Define a volume in a storage pool\)](#)
- [UPDATE MGMTCLASS \(Update a management class\)](#)
- [UPDATE STGPOOL \(Update a storage pool\)](#)

## Securing the IBM Spectrum Protect server

---

Secure the IBM Spectrum Protect™ server and data by controlling access to servers and client nodes, encrypting data, and maintaining secure access levels and passwords.

- **Managing administrators**  
An administrator who has system authority can complete any task with the IBM Spectrum Protect server, including assigning authority levels to other administrators. To complete some tasks, you must be granted authority by being assigned one or more authority levels.
- **Changing password requirements**  
You can change the minimum password limit, password length, password expiration, and enable or disable authentication for IBM Spectrum Protect.
- **Securing the server on the system**  
Protect the system where the IBM Spectrum Protect server runs to prevent unauthorized access.

## Managing administrators

---

An administrator who has system authority can complete any task with the IBM Spectrum Protect™ server, including assigning authority levels to other administrators. To complete some tasks, you must be granted authority by being assigned one or more authority levels.

### Procedure

---

Complete the following tasks to modify administrator settings.

Task	Procedure
Add an administrator.	<p>To add an administrator, ADMIN1, with system authority and specify a password, complete the following steps:</p> <ol style="list-style-type: none"> <li>Register the administrator and specify Pa\$#\$twO as the password by issuing the following command: <pre>register admin admin1 Pa\$#\$twO</pre> </li> <li>Grant system authority to the administrator by issuing the following command: <pre>grant authority admin1 classes=system</pre> </li> </ol>
Change administrative authority.	<p>Change the authority level for an administrator, ADMIN1.</p> <ul style="list-style-type: none"> <li>Grant system authority to the administrator by issuing the following command: <pre>grant authority admin1 classes=system</pre> </li> <li>Revoke system authority for the administrator by issuing the following command: <pre>revoke authority admin1 classes=system</pre> </li> </ul>
Remove administrators.	<p>Remove an administrator, ADMIN1, from accessing the IBM Spectrum Protect server by issuing the following command:</p> <pre>remove admin admin1</pre>
Temporarily prevent access to the server.	<p>Lock or unlock an administrator by using the LOCK ADMIN or UNLOCK ADMIN command.</p>

**Related concepts:**

Planning for administrator roles

## Changing password requirements

You can change the minimum password limit, password length, password expiration, and enable or disable authentication for IBM Spectrum Protect™.

### About this task

By enforcing password authentication and managing password restrictions, you protect your data and your servers from potential security risks.

### Procedure

Complete the following tasks to change password requirements for IBM Spectrum Protect servers.

Table 1. Authentication tasks for IBM Spectrum Protect servers

Task	Procedure
Set a limit for invalid password attempts.	<ol style="list-style-type: none"> <li>On the Servers page in the Operations Center, select the server.</li> <li>Click Details, and then click the Properties tab.</li> <li>Set the number of invalid attempts in the Invalid sign-on attempt limit field.</li> </ol> <p>The default value at installation is 0.</p>

Task	Procedure
Set a minimum length for passwords.	<ol style="list-style-type: none"> <li>On the Servers page in the Operations Center, select the server.</li> <li>Click Details and then click the Properties tab.</li> <li>Set the number of characters in the Minimum password length field.</li> </ol>
Set the expiration period for passwords.	<ol style="list-style-type: none"> <li>On the Servers page in the Operations Center, select the server.</li> <li>Click Details and then click the Properties tab.</li> <li>Set the number of days in the Password common expiration field.</li> </ol>
Disable password authentication.	<p>By default, the server automatically uses password authentication. With password authentication, all users must enter a password to access the server.</p> <p>You can disable password authentication only for passwords that authenticate with the server (LOCAL). By disabling password authentication, you increase the security risk for the server.</p>
Set a default authentication method.	<p>Issue the SET DEFAULTAUTHENTICATION command. For example, to use the server as the default authentication method, issue the following command:</p> <pre>set defaultauthentication local</pre> <p>To update one client node to authenticate with the server, include AUTHENTICATION=LOCAL in the UPDATE NODE command:</p> <pre>update node authentication=local</pre>

## Securing the server on the system

Protect the system where the IBM Spectrum Protect™ server runs to prevent unauthorized access.

### Procedure

Ensure that unauthorized users cannot access the directories for the server database and the server instance. Keep the access settings for these directories that you configured during implementation.

- Restricting user access to the server  
Authority levels determine what an administrator can do with the IBM Spectrum Protect server. An administrator with system authority can complete any task with the server. Administrators with policy, storage, or operator authority can complete subsets of tasks.

## Stopping and starting the server

Before you complete maintenance or reconfiguration tasks, stop the server. Then, start the server in maintenance mode. When you are finished with the maintenance or reconfiguration tasks, restart the server in production mode.

### Before you begin

You must have system or operator privilege to stop and start the IBM Spectrum Protect™ server.

- Stopping the server  
Before you stop the server, prepare the system by ensuring that all database backup operations are completed, and all other processes and sessions are ended. In this way, you can safely shut down the server and ensure that data is protected.

- Starting the server for maintenance or reconfiguration tasks  
Before you begin server maintenance or reconfiguration tasks, start the server in maintenance mode. When you start the server in maintenance mode, you disable operations that might disrupt your maintenance or reconfiguration tasks.

## Stopping the server

---

Before you stop the server, prepare the system by ensuring that all database backup operations are completed, and all other processes and sessions are ended. In this way, you can safely shut down the server and ensure that data is protected.

### About this task

---

When you issue the HALT command to stop the server, the following actions occur:

- All processes and client node sessions are canceled.
- All current transactions are stopped. (The transactions will be rolled back when the server is restarted.)

### Procedure

---

To prepare the system and stop the server, complete the following steps:

1. Prevent new client node sessions from starting by issuing the DISABLE SESSIONS command:

```
disable sessions all
```

2. Determine whether any client node sessions or processes are in progress by completing the following steps:
  - a. On the Overview page of the Operations Center, view the Activity area for the total numbers of processes and sessions that are currently active. If numbers differ significantly from the usual numbers that are displayed during your daily storage-management routine, view other status indicators in the Operations Center to check whether there is a problem.
  - b. View the graph in the Activity area to compare the amount of network traffic over the following periods:
    - The current period, that is, the most recent 24-hour period
    - The previous period, that is, the 24 hours before the current periodIf the graph for the previous period represents the expected amount of traffic, significant differences on the graph for the current period might indicate a problem.
  - c. On the Servers page, select a server for which you want to view processes and sessions, and click Details. If the server is not registered as a hub or spoke server in the Operations Center, obtain information about processes by using administrative commands. Issue the QUERY PROCESS command to query processes and obtain information about sessions by issuing the QUERY SESSION command.
3. Wait until the client node sessions are completed or cancel them. To cancel processes and sessions, complete the following steps:
  - On the Servers page, select a server for which you want to view processes and sessions, and click Details.
  - Click the Active Tasks tab, and select one or more processes, sessions, or a combination of both that you want to cancel.
  - Click Cancel.
  - If the server is not registered as a hub or spoke server in the Operations Center, cancel sessions by using administrative commands. Issue the CANCEL SESSION command to cancel a session and cancel processes by using the CANCEL PROCESS command.  
Tip: If the process that you want to cancel is waiting for a tape volume to be mounted, the mount request is canceled. For example, if you issue an EXPORT, IMPORT, or MOVE DATA command, the command might initiate a process that requires a tape volume to be mounted. However, if a tape volume is being mounted by an automated library, the cancel operation might not take effect until the mount process is complete. Depending on your system environment, this could take several minutes.
4. Stop the server by issuing the HALT command:

```
halt
```

## Starting the server for maintenance or reconfiguration tasks

---

Before you begin server maintenance or reconfiguration tasks, start the server in maintenance mode. When you start the server in maintenance mode, you disable operations that might disrupt your maintenance or reconfiguration tasks.

## About this task

---

Start the server in maintenance mode by running the DSMSErv utility with the MAINTENANCE parameter.

The following operations are disabled in maintenance mode:

- Administrative command schedules
- Client schedules
- Reclamation of storage space on the server
- Inventory expiration
- Migration of storage pools

In addition, clients are prevented from starting sessions with the server.

Tips:

- You do not have to edit the server options file, `dsmserv.opt`, to start the server in maintenance mode.
- While the server is running in maintenance mode, you can manually start the storage-space reclamation, inventory expiration, and storage-pool migration processes.

## Procedure

---

To start the server in maintenance mode, issue the following command:

```
dsmserv maintenance
```

Tip: To view a video about starting the server in maintenance mode, see [Starting a server in maintenance mode](#).

## What to do next

---

To resume server operations in production mode, complete the following steps:

1. Shut down the server by issuing the HALT command:

```
halt
```

2. Start the server by using the method that you use in production mode. Follow the instructions for your operating system:
  - o **AIX** Starting the server instance
  - o **Linux** Starting the server instance
  - o **Windows** Starting the server instance

Operations that were disabled during maintenance mode are reenabled.

## Planning to upgrade the server

---

When a fix pack or interim fix becomes available, you can upgrade the IBM Spectrum Protect™ server to take advantage of product improvements. Servers and clients can be upgraded at different times. Ensure that you complete the planning steps before you upgrade the server.

## About this task

---

Follow these guidelines:

- The preferred method is to upgrade the server by using the installation wizard. After you start the wizard, in the IBM Installation Manager window, click the Update icon; do not click the Install or Modify icon.
- If upgrades are available for both the server component and the Operations Center component, select the check boxes to upgrade both components.

## Procedure

---

1. Review the list of fix packs and interim fixes. See [technote 1239415](#).
2. Review product improvements, which are described in readme files.

Tip: When you obtain the installation package file from the IBM Spectrum Protect support site, you can also access the readme file.



3. Ensure that the version that you upgrade your server to is compatible with other components, such as storage agents and library clients. See technote 1302789.
4. If your solution includes servers or clients at a level that is earlier than V7.1, review the guidelines to ensure that client backup and archive operations are not disrupted. See technote 1053218.
5. Review the upgrade instructions. Ensure that you back up the server database, the device configuration information, and the volume history file.

## What to do next

---

To install a fix pack or interim fix, follow the instructions for your operating system:

- **AIX** Installing an IBM Spectrum Protect server fix pack
- **Linux** Installing an IBM Spectrum Protect server fix pack
- **Windows** Installing an IBM Spectrum Protect server fix pack

### Related information:

[Upgrade and Migration Process - Frequently Asked Questions](#)

## Preparing for an outage or system update

---

Prepare IBM Spectrum Protect™ to maintain your system in a consistent state during a planned power outage or system update.

### About this task

---

Ensure that you schedule activities regularly to manage, protect, and maintain the server. For information about scheduling activities such as backing up the database, backing up the device configuration file, and backing up the volume history, see [Defining schedules for server maintenance activities](#).

### Procedure

---

1. Cancel processes and sessions that are in progress by completing the following steps:
  - a. In the Operations Center, on the Servers page, select a server for which you want to view processes and sessions, and click Details.
  - b. Click the Active Tasks tab, and select one or more processes, sessions, or a combination of both that you want to cancel.
  - c. Click Cancel.
2. Stop the server by issuing the HALT command:

```
halt
```

Tip: You can issue the halt command from the Operations Center by hovering over the Settings icon and clicking Command Builder. Then, select the server, type `halt`, and press Enter.

### Related reference:

[HALT \(Shut down the server\)](#)

## Preparing for and recovering from a disaster by using DRM

---

IBM Spectrum Protect™ provides a disaster recovery manager (DRM) function to recover your server and client data during a disaster.

DRM tracks the movement of offsite media and registers that information in the IBM Spectrum Protect database. DRM consolidates plans, scripts, and other information in a plan file that is required to recover the IBM Spectrum Protect server when a disaster or unplanned outage occurs.

Restriction: DRM is only available in the IBM Spectrum Protect Extended Edition product.

- **Disaster recovery plan file**  
The disaster recovery plan file contains the information that is required to recover an IBM Spectrum Protect server to the point in time of the last database backup operation that was completed before the plan was created.
- **Recovering the server and client data by using DRM**  
Use the disaster recovery manager (DRM) function to recover the IBM Spectrum Protect server and client data when a disaster occurs.

- Running a disaster recovery drill  
Schedule disaster recovery drills to prepare for audits that certify the recoverability of the IBM Spectrum Protect server and to ensure that data can be restored and operations can resume after an outage. A drill also helps you ensure that all data can be restored and operations resumed before a critical situation occurs.
- Restoring the database  
If you have the disaster recovery manager (DRM) function enabled and you followed the procedure to prepare for a disaster, you can restore the database after a disaster. If you do not have DRM configured, you can still restore the database, provided that you have the required backup files.

## Disaster recovery plan file

The disaster recovery plan file contains the information that is required to recover an IBM Spectrum Protect™ server to the point in time of the last database backup operation that was completed before the plan was created.

The plan is organized into stanzas, which you can separate into multiple files. Each stanza has a begin statement and an end statement.

Table 1. Stanzas in the disaster recovery plan file

Stanza	Information in the stanza
SERVER.REQUIREMENTS	Identifies the database and recovery log storage requirements for the server.
RECOVERY.INSTRUCTIONS.GENERAL	Identifies site-specific instructions that the administrator enters in the file that is identified by the prefix RECOVERY.INSTRUCTIONS.GENERAL. The instructions include the recovery strategy, key contact names, an overview of key applications that are backed up by this server, and other relevant recovery instructions.
RECOVERY.INSTRUCTIONS.OFFSITE	Contains instructions that the administrator enters in the file that is identified by the prefix RECOVERY.INSTRUCTIONS.OFFSITE. The instructions describe the name and location of the offsite vault, and how to contact the vault administrator (for example, a name and phone number).
RECOVERY.INSTRUCTIONS.INSTALL	Contains instructions that the administrator enters in the file that is identified by the prefix RECOVERY.INSTRUCTIONS.INSTALL. The instructions describe how to rebuild the base server and provide the location of the system image backup copies.
RECOVERY.INSTRUCTIONS.DATABASE	Contains instructions that the administrator enters in the file that is identified by the prefix RECOVERY.INSTRUCTIONS.DATABASE. The instructions describe how to prepare for the database recovery. For example, you might enter instructions about how to initialize or load the backup volumes for an automated library. No sample of this stanza is provided.
RECOVERY.INSTRUCTIONS.STGPOOL	Contains instructions that the administrator enters in the file that is identified by the prefix RECOVERY.INSTRUCTIONS.STGPOOL. The instructions include the names of your software applications and the copy storage pool names that contain the backups of these applications. No sample of this stanza is provided.
RECOVERY.VOLUMES.REQUIRED	Provides a list of the database backup and copy storage pool volumes that are required to recover the server. A database backup volume is included if it is part of the most recent database backup series. A copy storage pool volume is included if it is not empty and not marked destroyed.

<b>Stanza</b>	<b>Information in the stanza</b>
RECOVERY.DEVICES.REQUIRED	Provides details about the devices that are required to read the backup volumes.
RECOVERY.SCRIPT.DISASTER.RECOVERY.MODE	Contains a script with the commands that are required to recover the server.
RECOVERY.SCRIPT.NORMAL.MODE	Contains a script with the commands that are required to restore the server primary storage pools.
DB.STORAGEPATHS	Identifies the directories for the IBM Spectrum Protect database.
LICENSE.REGISTRATION	Contains a macro to register your server licenses.
COPYSTGPOOL.VOLUMES.AVAILABLE	Contains a macro to mark copy storage pool volumes that were moved offsite and then moved back onsite. You can use the information as a guide and issue the administrative commands. Alternatively, copy, modify, and run the macro to a file. This macro is started by the RECOVERY.SCRIPT.DISASTER.RECOVERY.MODE script.
COPYSTGPOOL.VOLUMES.DESTROYED	Contains a macro to mark copy storage pool volumes as unavailable if the volumes were onsite at the time of the disaster. These volumes are considered offsite and have not been destroyed in a disaster. You can use the information as a guide and issue the administrative commands from a command line, or you can copy, modify, and run the macro to a file. This macro is started by the RECOVERY.SCRIPT.DISASTER.RECOVERY.MODE script.
PRIMARY.VOLUMES.DESTROYED	Contains a macro to mark primary storage pool volumes as destroyed if the volumes were onsite at the time of disaster. You can use the information as a guide and run the administrative commands from a command line, or you can copy, modify, and run the macro to a file. This macro is started by the RECOVERY.SCRIPT.DISASTER.RECOVERY.MODE script.
PRIMARY.VOLUMES.REPLACEMENT	Contains a macro to identify replacement primary storage pool volumes. You can use the information as a guide and run the administrative commands from a command line, or you can copy, modify, and run the macro to a file. This macro is started by the RECOVERY.SCRIPT.DISASTER.RECOVERY.MODE script.
STGPOOLS.RESTORE	Contains a macro to restore the primary storage pools. You can use the stanza as a guide and run the administrative commands from a command line. You can also copy, modify, and run it to a file. This macro is started by the RECOVERY.SCRIPT.NORMAL.MODE script.
VOLUME.HISTORY.FILE	Contains a copy of the volume history information when the recovery plan was created. The DSMSEV RESTORE DB utility uses the volume history file to determine what volumes are needed to restore the database. The volume history file is used by the RECOVERY.SCRIPT.DISASTER.RECOVERY.MODE script.
DEVICE.CONFIGURATION.FILE	Contains a copy of the server device configuration information when the recovery plan was created. The DSMSEV RESTORE DB utility uses the device configuration file to read the database backup volumes. The device configuration file is used by the RECOVERY.SCRIPT.DISASTER.RECOVERY.MODE script.
DSMSERV.OPT.FILE	Contains a copy of the server options file. This stanza is used by the RECOVERY.SCRIPT.DISASTER.RECOVERY.MODE script.
LICENSE.INFORMATION	Contains a copy of the latest license audit results and the server license terms.

Stanza	Information in the stanza
MACHINE.GENERAL.INFORMATION	Provides information for the server machine, such as its location, which is needed to rebuild the server machine. This stanza is included in the plan file if the machine information is saved in the database by using the DEFINE MACHINE command and specifying the ADSMSERVER=YES.
MACHINE.RECOVERY.INSTRUCTIONS	Provides the recovery instructions about the server machine. This stanza is included in the plan file if the machine recovery instructions are saved in the database.
MACHINE.RECOVERY.CHARACTERISTICS	Provides the hardware and software characteristics for the server machine. This stanza is included in the plan file if the machine characteristics are saved in the database.
MACHINE.RECOVERY.MEDIA	Provides information about the media that are required for rebuilding the machine that contains the server. This stanza is included in the plan file if recovery media information is saved in the database and it is associated with the machine that contains the server.

## Recovering the server and client data by using DRM

Use the disaster recovery manager (DRM) function to recover the IBM Spectrum Protect™ server and client data when a disaster occurs.

### Before you begin

IBM Spectrum Protect is set up to use the Secure Sockets Layer (SSL) protocol for client/server authentication. When you start the server, a digital certificate file, cert.kdb, is created as part of the process. This file includes the server's public key, which allows the client to encrypt data. The digital certificate file cannot be stored in the server database because the Global Security Kit (GSKit) requires a separate file in a certain format.

The master encryption key is stored in a new GSKit-managed key database, dsmkeydb.kdb. If the server has an existing master encryption key, the master encryption key is migrated from the dsmserve.pwd file to the key database, dsmkeydb.kdb. Keep backup copies of the dsmkeydb.kdb and dsmkeydb.sth files. You can configure the BACKUP DB command to back up the master encryption key, or you can manually back up the dsmkeydb.kdb and dsmkeydb.sth files yourself.

1. Keep backup copies of the cert.kdb, cert.sth, and cert256.arm files.
2. If both the original certificate files and any copies are lost or corrupted, generate new certificate files.

### Procedure

1. Get the latest recovery plan.
2. Review the recovery steps that are described in the RECOVERY.INSTRUCTIONS.GENERAL stanza of the plan.
3. Separate the stanzas of the plan file into individual files for general preliminary instructions, IBM Spectrum Protect server recovery scripts, and client recovery instructions.
4. Retrieve all required recovery volumes (as listed in the plan) from the vault.
5. Review the device configuration file to ensure that the hardware configuration at the recovery site is the same as the original site. Any differences must be updated in the device configuration file. The following example configuration changes require updates to the configuration information:
  - o Different device names.
  - o For automated libraries, the requirement of manually placing the database backup volumes in the automated library and updating the configuration information to identify the element within the library. This allows the server to locate the required database backup volumes.
6. Set up replacement hardware for the IBM Spectrum Protect server, including the operating system and the IBM Spectrum Protect base release installation.
7. Run the IBM Spectrum Protect server recovery scripts from the recovery plan. The RECOVERY.SCRIPT.DISASTER.RECOVERY.MODE and RECOVERY.SCRIPT.NORMAL.MODE stanzas contain executable command files that can be used to drive the recovery of the IBM Spectrum Protect server by calling other command files that were generated in the plan. The RECOVERY.SCRIPT.DISASTER.RECOVERY.MODE script recovers the server to the point where clients can begin restores directly from the copy storage pool volumes.

8. Restore the primary storage pools by using the RECOVERY.SCRIPT.NORMAL.MODE script.
9. Start client restore operations in order of highest priority, as defined in your high-level planning.

## What to do next

---

The IBM Spectrum Protect server can now be used for normal server operations. Ensure that all required operations are scheduled. For instructions, see [Defining schedules for server maintenance activities](#) and [Scheduling backup and archive operations](#).

**Related tasks:**

[Repairing and recovering data in directory-container storage pools](#)

**Related reference:**

[PREPARE \(Create a recovery plan file\)](#)

## Running a disaster recovery drill

---

Schedule disaster recovery drills to prepare for audits that certify the recoverability of the IBM Spectrum Protect™ server and to ensure that data can be restored and operations can resume after an outage. A drill also helps you ensure that all data can be restored and operations resumed before a critical situation occurs.

### Before you begin

---

Complete the following tasks:

- Schedule activities regularly to manage, protect, and maintain the server. For more information about scheduling activities, see [Defining schedules for server maintenance activities](#). Ensure that you schedule the following tasks:
  - Backing up the database.
  - Moving media offsite.
  - Backing up the device configuration file, the volume history file, and the dsmserv.opt server options file.
  - **Optional:** Issuing the PREPARE command to create the disaster recovery plan file.

Tip:

When you issue the PREPARE command, the IBM Spectrum Protect disaster recovery manager (DRM) function creates one copy of the disaster recovery plan file.

You can manage offsite disaster recovery without using DRM, however, DRM helps to consolidate plans, scripts, and other information that is required during disaster recovery.

Create multiple copies of the plan for safekeeping. For example, keep copies in print, on a USB flash drive, on disk space that is located offsite, or on a remote server. The disaster recovery plan file is moved offsite daily with the tapes. For more information about DRM, see [Preparing for and recovering from a disaster by using DRM](#).

- Configure the following resources at the disaster recovery site:
  1. A recovery IBM Spectrum Protect server. The server at the disaster recovery site must be at the same level as the server on the production site.
  2. A tape library to store the media that is shipped from the production site. For more information about offsite recovery locations, see [Offsite data storage](#).
  3. Disk storage space for the database, archive log, active logs, and storage pools.
  4. Clients to test restore operations.

### About this task

---

Test the disaster recovery plan and the IBM Spectrum Protect server recoverability often, in an environment that is similar to the production environment.

### Procedure

---

1. Ensure that tapes are available onsite. Issue the QUERY LIBVOLUME command to identify volumes that are checked into an automated library.
2. Back up the database to the onsite tapes by completing the following steps:
  - a. On the Servers page of the Operations Center, select the server whose database you want to back up.
  - b. Click Back Up, and follow the instructions in the Back Up Database window.
3. Copy the following files to the home directory of the server at the recovery site:

- Disaster recovery plan file
  - Volume history file
  - Device configuration file
  - Optional: dsmserve.opt server options file
4. Move the tape to the offsite recovery location.
  5. Restore the server database by using the DSMSERV RESTORE DB utility on the recovery server. For more information about restoring the server database, see Restoring the database.
  6. Issue the UPDATE VOLUME command and specify the ACCESS=DESTROYED parameter to indicate that an entire volume must be restored.
  7. On the recovery server, restore the storage pool volumes by using the RESTORE STGPOOL command.

## What to do next

---

Ensure that you can access the data in the library by auditing a tape volume in the restored storage pool to verify that the data is consistent. Issue the AUDIT VOLUME command to audit a tape volume. For faster performance, audit restored data only.

### Related tasks:

Auditing the volume inventory in a library

### Related reference:

- [AUDIT VOLUME \(Verify database information for a storage pool volume\)](#)
- [DSMSERV RESTORE DB \(Restore the database\)](#)
- [RESTORE STGPOOL \(Restore storage pool data\)](#)

## Restoring the database

---

If you have the disaster recovery manager (DRM) function enabled and you followed the procedure to prepare for a disaster, you can restore the database after a disaster. If you do not have DRM configured, you can still restore the database, provided that you have the required backup files.

## Before you begin

---

If the database and recovery log directories are lost, re-create them before you run the DSMSERV RESTORE DB server utility.

## About this task

---

You can restore the database to its most current state or to a specified point in time. To recover the database to the time when the database was lost, recover the database to its latest version.

Restrictions:

- To restore the database to its latest version, you must locate the archive log directory. If you cannot locate the directory, you can restore the database only to a point in time.
- You cannot use the Secure Sockets Layer (SSL) protocol for database restore operations.
- If the release level of the database backup is different from the release level of the server that is being restored, you cannot restore the server database. For example, if you are using a Version 8.1 server and you try to restore a V7.1 database, an error occurs.

## Procedure

---

Use the DSMSERV RESTORE DB server utility to restore the database. Depending on the version of the database that you want to restore, choose one of the following methods:

- Restore a database to its latest version. For example, use the following command:

```
dsmserve restore db
```

- Restore a database to a point in time. For example, to restore the database to a backup series that was created on 19 April 2017, use the following command:

```
dsmserve restore db todate=04/19/2017
```

### Related reference:

- [DSMSERV RESTORE DB \(Restore the database\)](#)

## Server solution documentation in PDF files

---

Prebuilt PDF files for IBM Spectrum Protect™ documentation are available for you to download.

The following prebuilt PDF files are available for IBM Spectrum Protect data protection solutions:

- Introduction to Data Protection Solutions
- Single-Site Disk Solution Guide
- Multisite Disk Solution Guide
- Tape Solution Guide

For more prebuilt PDF files of server documentation, see the complete list.

## IBM Spectrum Protect servers

---

IBM Spectrum Protect™ servers store and manage backup, archive, and space-managed data for backup-archive clients and other IBM Spectrum Protect and IBM Spectrum Protect Snapshot components.

- **What's new**  
Learn about new features and updates for server components in IBM Spectrum Protect Version 8.1.
- **Installing and upgrading**  
You can install or upgrade individual or multiple components in your enterprise network. Solution documentation is available to help you select a best practice solution, based on your business needs and then install, configure, monitor, and operate that solution.
- **Configuring and managing**  
To complete configuration tasks for the server, review available documentation.
- **Server commands, options, and utilities**  
Use commands to administer and configure the server, options to customize the server, and utilities to perform special tasks when the server is not running.
- **Server documentation in PDF files**  
Prebuilt PDF files for IBM Spectrum Protect documentation are available for you to download.

## What's new

---

Learn about new features and updates for server components in IBM Spectrum Protect™ Version 8.1.

Tip: To view videos about new features and updates, see the Video library.

To read about new features and updates, follow the links in the table.

Release	New features and updates
V8.1.2	<p>Server</p> <ul style="list-style-type: none"><li>• Back up data to Microsoft Azure, a cloud-based object storage system</li><li>• Encrypt client data in a directory-container storage pool</li><li>• Back up a NAS file server to a directory-container storage pool</li><li>• Install IBM Spectrum Protect on the Linux on Power Systems (little endian) operating system</li><li>• Protect your storage environment with an improved security protocol</li><li>• Optimize security with the automatically generated master encryption key</li><li>• Upgrade your IBM Spectrum Protect server to V8.1.2 before you upgrade clients</li><li>• Configure a storage environment by using the Tape Solution Guide</li><li>• Schedule automatic updates for backup-archive clients</li><li>• Deprecated and discontinued server options, commands, and parameters</li></ul> <p>Operations Center Operations Center updates</p>

Release	New features and updates
V8.1.1	<p>Server</p> <ul style="list-style-type: none"> <li>• Install IBM Spectrum Protect on the Linux on Power Systems (little endian) operating system</li> <li>• Install IBM Spectrum Protect on the Microsoft Windows Server 2016 operating system</li> <li>• Use the Quantum Scalar i6 library</li> <li>• Review resolved issues</li> </ul> <p>Operations Center</p> <ul style="list-style-type: none"> <li>• Review resolved issues</li> </ul>
V8.1	<p>Server</p> <ul style="list-style-type: none"> <li>• Meet IBM Spectrum Protect</li> <li>• Secure communications by using the TLS 1.2 protocol</li> <li>• Convert a tape storage pool to a container storage pool</li> <li>• Software upgrade for the server database manager</li> <li>• REGISTER NODE command no longer creates an administrative user ID by default</li> <li>• Optimize user authentication to an Active Directory database</li> <li>• Increased flexibility for protecting and reclaiming tape volumes in container-copy storage pools</li> <li>• Supported operating systems</li> <li>• Monitor the system without using SNMP</li> </ul> <p>Operations Center Operations Center updates</p>

- Operations Center updates  
New features are available in IBM Spectrum Protect Operations Center Version 8.1.2. By using the updated Operations Center, you can back up data to Microsoft Azure cloud storage and benefit from enhanced security enforcement.
- IBM Spectrum Protect server updates  
New features and other changes are available in the IBM Spectrum Protect Version 8.1.2 server.
- Release notes for Version 8.1 server components  
Release notes are available for V8.1 components.
- Readme files for Version 8.1 server components  
Readme files for Version 8.1 fix packs are published in the IBM Software Support website. Updates might be available for server components, including the server itself, device support, and the Operations Center.

**Related information:**

[Version 7 what's new videos](#)

## Operations Center updates

New features are available in IBM Spectrum Protect™ Operations Center Version 8.1.2. By using the updated Operations Center, you can back up data to Microsoft Azure cloud storage and benefit from enhanced security enforcement.

The following enhancements were made to the Operations Center:

- You can use the Add Storage Pool wizard to create cloud-container storage pools that use Microsoft Azure, a cloud-based object storage system, to back up data.
- The Operations Center now provides enhanced security by enforcing the use of Transport Layer Security (TLS) 1.2 encryption for communication between the Operations Center and the hub server.

For more information about these enhancements, see the Operations Center help.

## IBM Spectrum Protect server updates

New features and other changes are available in the IBM Spectrum Protect™ Version 8.1.2 server.



- Back up data to Microsoft Azure, a cloud-based object storage system  
With IBM Spectrum Protect Version 8.1.2, you can configure cloud-container storage pools to use Microsoft Azure, a cloud-based object storage system, to back up and restore data.
- Encrypt client data in a directory-container storage pool  
IBM Spectrum Protect Version 8.1.2 provides enhanced protection for client data. If you used an earlier release of IBM Spectrum Protect to write client data to a directory-container storage pool, you can encrypt the existing client data in the storage pool. You can also enable encryption of new client data before it is written to the storage pool.
- Back up a NAS file server to a directory-container storage pool  
With IBM Spectrum Protect Version 8.1.2, you can back up a file system that belongs to a network-attached storage (NAS) file server to a directory-container storage pool. By using directory-container storage pools, you can reduce the cost of storage hardware, improve server performance, and enhance security.
- Install IBM Spectrum Protect on the Linux on Power Systems (little endian) operating system  
You can install IBM Spectrum Protect Version 8.1.2 on the Linux on Power Systems™ (little endian) operating system. Limited support for this operating system was introduced in V8.1.1, and full support is introduced in V8.1.2. After you install and configure the V8.1.2 server on Linux on Power Systems (little endian), you can back up data to disk devices, cloud object storage, and tape devices.
- Protect your storage environment with an improved security protocol  
IBM Spectrum Protect Version 8.1.2 provides an improved security protocol.
- Optimize security with the automatically generated master encryption key  
Beginning with IBM Spectrum Protect Version 8.1.2, a master encryption key is automatically generated when you start the server if the master encryption key did not previously exist.
- Configure a storage environment by using the Tape Solution Guide  
The documentation set is updated to include the *IBM Spectrum Protect Tape Solution Guide*. By following the instructions in the guide, you can configure a tape-based solution that optimizes storage and supports disaster recovery by ensuring that data is securely backed up to an offsite location.
- Schedule automatic updates for backup-archive clients  
With IBM Spectrum Protect Version 8.1.2, you can schedule deployment of software updates to systems that already have the backup-archive client installed.
- Upgrade your IBM Spectrum Protect server to V8.1.2 before you upgrade clients  
Upgrade your IBM Spectrum Protect servers to Version 8.1.2 before you upgrade the backup-archive clients.
- Deprecated and discontinued server options, commands, and parameters  
Some server options, commands, and parameters are deprecated or no longer available, beginning with IBM Spectrum Protect Version 8.1.2. The behavior of some parameters and options has changed.

## Back up data to Microsoft Azure, a cloud-based object storage system

---

With IBM Spectrum Protect™ Version 8.1.2, you can configure cloud-container storage pools to use Microsoft Azure, a cloud-based object storage system, to back up and restore data.

By configuring cloud-container storage pools to use Azure, you can simplify storage management and secure data by using encryption.

### Related tasks:

Preparing for Azure

Configuring a cloud-container storage pool

### Related reference:

DEFINE STGPOOL (Define a cloud-container storage pool)

UPDATE STGPOOL (Update a cloud-container storage pool)

## Encrypt client data in a directory-container storage pool

---

IBM Spectrum Protect™ Version 8.1.2 provides enhanced protection for client data. If you used an earlier release of IBM Spectrum Protect to write client data to a directory-container storage pool, you can encrypt the existing client data in the storage pool. You can also enable encryption of new client data before it is written to the storage pool.

To enable encryption for an existing directory-container storage pool, issue the UPDATE STGPOOL command and specify ENCRYPT=YES. To enable encryption for a new directory-container storage pool, define the storage pool by using the DEFINE STGPOOL command and specify ENCRYPT=YES.

### Related tasks:

Configuring a directory-container storage pool for data storage

**Related reference:**

DEFINE STGPOOL (Define a directory-container storage pool)  
UPDATE STGPOOL (Update a directory-container storage pool)

## Back up a NAS file server to a directory-container storage pool

---

With IBM Spectrum Protect™ Version 8.1.2, you can back up a file system that belongs to a network-attached storage (NAS) file server to a directory-container storage pool. By using directory-container storage pools, you can reduce the cost of storage hardware, improve server performance, and enhance security.

Directory-container storage pools offer the following advantages:

- You can enable inline data deduplication to eliminate duplicate data while it is written to the storage pool. In this way, you can reduce the need for offline reorganization, improve server performance, and lower costs.
- You can enable inline compression to reduce the amount of space that data occupies.
- You can enable encryption to encrypt client data before it is written to the storage pool.
- You can protect data by using the PROTECT STGPOOL command. You can store a copy of the data in another directory-container storage pool on a target replication server or on tape in a container-copy storage pool. To restore damaged data, you can run the REPAIR STGPOOL command.

**Related tasks:**

Protecting NAS file servers

**Related reference:**

DEFINE STGPOOL (Define a directory-container storage pool)  
REPAIR STGPOOL (Repair a directory-container storage pool)

Linux

## Install IBM Spectrum Protect on the Linux on Power Systems (little endian) operating system

---

You can install IBM Spectrum Protect™ Version 8.1.2 on the Linux on Power Systems™ (little endian) operating system. Limited support for this operating system was introduced in V8.1.1, and full support is introduced in V8.1.2. After you install and configure the V8.1.2 server on Linux on Power Systems (little endian), you can back up data to disk devices, cloud object storage, and tape devices.

The installation packages include the server and license, device driver tools, the Operations Center, and the storage agent. The following restrictions apply:

- You cannot set up a clustered environment.
- You cannot use the QUERY SAN command or the SANDISCOVERY server option to detect devices on a storage area network when the devices are connected to a host bus adapter (HBA) card that is configured by using the N\_Port ID Virtualization (NPIV) method.
- You cannot optimize data transfer to remote servers by enabling Aspera® Fast Adaptive Protocol (FASP®) technology.
- You cannot set up automated cartridge system library software (ACSL) libraries.

**Related tasks:**

Linux: Installing the server

**Related reference:**

Linux: Minimum Linux on Power Systems™ (little endian) server requirements

## Protect your storage environment with an improved security protocol

---

IBM Spectrum Protect™ Version 8.1.2 provides an improved security protocol.

To protect your storage environment from security threats, IBM Spectrum Protect has an improved security protocol that uses Transport Layer Security (TLS) 1.2 to encrypt all communication between the server, storage agent, and clients. A new SESSIONSECURITY parameter determines whether an administrator, node, or server must use the most secure settings to communicate with an IBM Spectrum Protect server. IBM Spectrum Protect servers, clients, and storage agents that use V8.12 or later software are automatically configured to communicate with each other by using the Secure Sockets Layer (SSL) protocol. Certificates are distributed automatically.

For a detailed description of the SESSIONSECURITY parameter, see the command topics for registering and updating administrator IDs, nodes, and servers. For the latest information about V8.1.2 security updates, see technote 2004844.

**Related reference:**

DEFINE SERVER (Define a server for server-to-server communications)  
REGISTER ADMIN (Register an administrator ID)  
REGISTER NODE (Register a node)  
UPDATE ADMIN (Update an administrator)  
UPDATE NODE (Update node attributes)  
UPDATE SERVER (Update a server defined for server-to-server communications)

**Related information:**

What you should know about security before you upgrade the server (AIX)  
What you should know about security before you upgrade the server (Linux)  
What you should know about security before you upgrade the server (Windows)  
Security concepts

## Optimize security with the automatically generated master encryption key

---

Beginning with IBM Spectrum Protect™ Version 8.1.2, a master encryption key is automatically generated when you start the server if the master encryption key did not previously exist.

The newly generated master encryption key is stored in a new key database, dsmkeydb.kdb. If the server has an existing master encryption key, the key is migrated from the dsmserv.pwd file to the new key database. The automatic generation of the master encryption key and its storage in the new key database are designed to enhance system security. Server certificates are still stored in the cert.kdb key database and accessed by the stash file cert.sth.

You must protect both the key databases (cert.kdb and dsmkeydb.kdb) and the stash files (cert.sth and dsmkeydb.sth) that provide access to each of the key databases. By default, the BACKUP DB command protects the master encryption key, but you must remember the database backup password to restore the database. The IBM Spectrum Protect server dsmserv.pwd file, which was used to store the master encryption key in previous releases, is no longer used.

**Related reference:**

BACKUP DB (Back up the database)

**Related information:**

Recovering data by using DRM

## Configure a storage environment by using the Tape Solution Guide

---

The documentation set is updated to include the *IBM Spectrum Protect™ Tape Solution Guide*. By following the instructions in the guide, you can configure a tape-based solution that optimizes storage and supports disaster recovery by ensuring that data is securely backed up to an offsite location.

The guide provides instructions for completing the following tasks:

- Plan and implement a data protection solution that uses one or more tape storage devices to back up data
- Monitor an IBM Spectrum Protect tape solution
- Manage tape devices and tape drives
- Recover data after a disaster or unplanned outage

**Related information:**

 Tape Solution Guide (PDF)

Tape solution overview

Planning, implementing, monitoring, and managing a tape solution

## Schedule automatic updates for backup-archive clients

---

With IBM Spectrum Protect™ Version 8.1.2, you can schedule deployment of software updates to systems that already have the backup-archive client installed.

You can use IBM Spectrum Protect server commands to schedule updates for one or more backup-archive clients. The updates can be fix packs or new releases. This feature was available in previous releases of IBM Spectrum Protect, but an improved procedure is available for V8.1.2.

For more information about automatically deploying client updates from the server, see the following documents:

- For IBM Spectrum Protect V8.1.2 or later servers, see technote 2004596.
- For IBM® Tivoli® Storage Manager V7.1 servers and IBM Spectrum Protect V8.1.0 and V8.1.1 servers, see technote 1673299.

## Upgrade your IBM Spectrum Protect server to V8.1.2 before you upgrade clients

---

Upgrade your IBM Spectrum Protect™ servers to Version 8.1.2 before you upgrade the backup-archive clients.

If you do not upgrade your servers first, communication between servers and clients might be interrupted.

### Related information:

What you should know about security before you upgrade the server (AIX)

What you should know about security before you upgrade the server (Linux)

What you should know about security before you upgrade the server (Windows)

## Deprecated and discontinued server options, commands, and parameters

---

Some server options, commands, and parameters are deprecated or no longer available, beginning with IBM Spectrum Protect™ Version 8.1.2. The behavior of some parameters and options has changed.

Due to security protocol changes, the following updates were made in the product:

- Two SSL-related parameters, VALIDATEPROTOCOL and SSLREQUIRED, are deprecated and ignored. These parameters are replaced by the SESSIONSECURITY parameter.
- Four SSL-related server options, USETLS12, SSLTLS12, SSLHIDELEGACY, and SSLDISABLELEGACYTLS, are no longer available.
- The behavior of the SSL parameter on the DEFINE SERVER and UPDATE SERVER commands changed. SSL is now used to encrypt some communication with the server even if you specify SSL=NO.
- The behavior of the TCPSPORT and TCPADMINPORT options changed. The port number that is specified in the TCPSPORT or TCPADMINPORT option now listens for and accepts both TCP/IP and SSL-enabled sessions. You are no longer required to specify the SSLTCPSPORT or SSLTCPADMINPORT option to allow SSL-enabled sessions from the client.
- The SET AUTHENTICATION, SET REGISTRATION, DELETE KEYRING, QUERY SSLKEYRINGPW, and SET SSLKEYRINGPW commands are no longer available.

### Related reference:

DEFINE SERVER (Define a server for server-to-server communications)

UPDATE SERVER (Update a server defined for server-to-server communications)

## Release notes for Version 8.1 server components

---

Release notes are available for V8.1 components.

- Release notes for IBM Spectrum Protect server Version 8.1  
The IBM Spectrum Protect server V8.1 is available. Compatibility, installation, and other getting-started issues are addressed.
- Release notes for Operations Center Version 8.1  
The Operations Center is a web-based interface that you can use to manage your IBM Spectrum Protect environment. The release notes give you access to the product announcement, known issues, system requirements, installation instructions, and updates.
- Release notes for IBM Spectrum Protect device support Version 8.1  
IBM Spectrum Protect device support for V8.1 is available. Compatibility, installation, and other getting-started issues are addressed.

# Release notes for IBM Spectrum Protect server Version 8.1

---

The IBM Spectrum Protect™ server V8.1 is available. Compatibility, installation, and other getting-started issues are addressed.

## Contents

---

- Description
- Announcement
- Compatibility with earlier versions
- System requirements
- Installing and upgrading IBM Spectrum Protect
- Updates, limitations, and known problems

## Description

---

IBM Spectrum Protect provides automated, centrally scheduled, policy-managed backup, archive, and space-management capabilities for file servers, workstations, virtual machines, and applications.

An authorized program analysis report (APAR) is a request for the correction of a defect in a supported release of a program supplied by IBM. For a list of resolved APARs, see APARs fixed in IBM Spectrum Protect server Version 8.1.

## Announcement

---

The announcement for the IBM Spectrum Protect V8.1 family of products includes the following information:

- Detailed product description, including descriptions of new functions
- Product-positioning statement
- International compatibility information

To search for the product announcement, complete the following steps:

1. Go to the product announcement website.
2. In the Search for field, enter the product identifier (PID) for your product. The PID for IBM Spectrum Protect is 5725-W98.
3. In the Information Type field, select Announcement letters, and click Search.
4. From the Search in list, select Product Number.
5. Optional: In the Refine Your Search pane on the left side of the window, select the country where you reside.
6. In the Sort by section, select Newest first.

## Compatibility with earlier versions

---

For compatibility with earlier versions, see the IBM Spectrum Protect Server-Client Compatibility and Upgrade Considerations.

## System requirements

---

For system requirement information, see the IBM Spectrum Protect Supported Operating Systems.

## Installing and upgrading IBM Spectrum Protect

---

For server installation instructions, see the procedure for your operating system:

IBM AIX®

Installing the server

Linux

Installing the server

Microsoft Windows

Installing the server

For upgrade instructions, see Upgrading to V8.1.

## Updates, limitations, and known problems

---

Updates describe new product information or new product features that become available after product release. Updates, limitations, and known issues are documented in the form of technotes in the support knowledge base of the IBM® Support Portal. By searching the knowledge base, you can find workarounds or solutions to known issues.

#### Updates

##### **REGISTER NODE command no longer creates an administrative user ID by default**

Beginning with IBM Spectrum Protect V8.1, the REGISTER NODE command does not automatically create an administrative user ID that matches the node name. This product update can affect the process of registering client nodes, including but not limited to IBM Spectrum Protect backup-archive client nodes. In some cases, you might have to create an administrative user ID by specifying the USERID parameter on the REGISTER NODE command. For information about the types of clients that are affected, see technote 7048963.

To search for the latest updates, see Updates for IBM Spectrum Protect V8.1.

#### Limitations and known problems

At the time of publication, there were no limitations or known problems.

To search for the latest limitations and known problems, which might include additional items, see Limitations and known problems for IBM Spectrum Protect V8.1.

## Release notes for Operations Center Version 8.1

---

The Operations Center is a web-based interface that you can use to manage your IBM Spectrum Protect™ environment. The release notes give you access to the product announcement, known issues, system requirements, installation instructions, and updates.

### Contents

---

- Description
- Announcement
- Compatibility with the IBM Spectrum Protect server
- System requirements
- Installing or upgrading the Operations Center
- Updates, limitations, and known issues

### Description

---

You can use the Operations Center to take the following actions:

- Identify potential issues with your IBM Spectrum Protect environment
- Monitor key aspects of the storage environment: alerts, clients, servers, policies, storage pools, and storage devices
- Register clients
- Add servers to be monitored
- Back up clients, server databases, and storage pools
- Start storage pool migration and reclamation
- Assign alerts to administrators, and close alerts
- View and cancel server processes and client sessions
- Change client, server, storage pool, and storage device settings
- Create and manage client schedules and view administrative schedules
- Convert primary storage pools to container storage pools
- Copy data from directory-container storage pools to tape
- Configure replication
- Modify policy settings
- Decommission clients and deactivate data
- Create email reports
- View front-end and back-end capacity usage to monitor license compliance
- Issue commands to IBM Spectrum Protect servers

An authorized program analysis report (APAR) is a request for the correction of a defect in a supported release of a program supplied by IBM. For a list of resolved APARs, see APARs fixed in IBM Spectrum Protect Operations Center Version 8.1.

### Announcement

---

The Operations Center is part of the IBM Spectrum Protect V8.1 family of products. The announcement for these products includes the following information:

- Detailed product description, including descriptions of new functions
- Product-positioning statement
- International compatibility information

To search for the product announcement, complete the following steps:

1. Go to the product announcement website.
2. In the Search for field, enter the product identifier (PID) for your product. The PID for IBM Spectrum Protect is 5725-W98.
3. In the Information Type field, select Announcement letters, and click Search.
4. From the Search in list, select Product Number.
5. Optional: In the Refine Your Search pane on the left side of the window, select the country where you reside.
6. In the Sort by section, select Newest first.

---

## Compatibility with the IBM Spectrum Protect server

For compatibility information, see IBM Spectrum Protect server and Operations Center compatibility.

---

## System requirements

For system requirements, see IBM Spectrum Protect Operations Center software and hardware requirements.

---

## Installing or upgrading the Operations Center

For installation instructions, or to upgrade an existing version of the Operations Center, see Installing and upgrading the Operations Center.

---

## Updates, limitations, and known issues

Updates describe new product information or new product features that become available after product release. Updates, limitations, and known issues are documented in the form of technotes in the support knowledge base of the IBM® Support Portal. By searching the knowledge base, you can find workarounds or solutions to known issues.

### Updates

For the latest list of updates, see Search results for updates to Operations Center V8.1.

### Limitations and known issues

- For a list of limitations and known issues, see Limitations and known issues with Operations Center V8.1.
- To search for additional issues that might become known after the product release, see Search results for known issues with Operations Center V8.1.

---

## Release notes for IBM Spectrum Protect device support Version 8.1

IBM Spectrum Protect™ device support for V8.1 is available. Compatibility, installation, and other getting-started issues are addressed.

---

## Contents

- Description
- Announcement
- Supported devices
- Device driver requirements
- Library information
- Updates, limitations, and known problems

---

## Description

This document includes information about IBM Spectrum Protect V8.1 device drivers.

An authorized program analysis report (APAR) is a request for the correction of a defect in a supported release of a program supplied by IBM. For a list of resolved APARs, see APARs Fixed in IBM Spectrum Protect device driver Version 8.1.

## Announcement

---

IBM Spectrum Protect device support for V8.1 is announced as part of the IBM Spectrum Protect family of products announcement. The announcement for these products includes the following information:

- Detailed product description, including descriptions of new functions
- Product-positioning statement
- International compatibility information

To search for the product announcement, complete the following steps:

1. Go to the product announcement website.
2. In the Search for field, enter the product identifier (PID) for your product. The PID for IBM Spectrum Protect is 5725-W98.
3. In the Information Type field, select Announcement letters, and click Search.
4. From the Search in list, select Product Number.
5. Optional: In the Refine Your Search pane on the left side of the window, select the country where you reside.
6. In the Sort by section, select Newest first.

## Supported devices

---

For information about supported devices and hardware for IBM AIX® and Microsoft Windows systems, see Supported devices for AIX and Windows.

For information about supported devices and hardware for Linux systems, see Supported devices for Linux.

## Device driver requirements

---

### Host bus adapter requirements

For best results, connect tape drives and tape libraries to the system on their own host bus adapter. Do not share the host bus adapter with other device types, such as DISK or CD.

### Maximum number of devices that are supported by IBM Spectrum Protect device drivers

For information about the maximum number of devices that IBM Spectrum Protect device drivers can support on each operating system, see technote 1364225.

### Serial Attached SCSI (SAS) device support

SAS devices can be used on some operating systems and architectures. For information about operating systems and architectures for SAS devices, see technote 1396706.

### Running the IBM Spectrum Protect passthru driver with a non-root user ID on Linux operating systems

For information about how a non-root user can use devices with the IBM Spectrum Protect passthru driver on Linux, see technote 1321130. Use option `-g` or `-a` of the device autoconf utility to ensure that non-root users can use devices that are configured with the IBM Spectrum Protect passthru driver. Use option `-g` to add read and write permissions for groups to the SCSI generic driver (`sg`) device files. Use option `-a` to add read and write permissions for all users to the `sg` device files.

## Library information

---

- IBM Spectrum Protect Extended Edition is required for a library with greater than four drives or greater than 48 storage slots.
- The element addresses of the storage slots might not directly correspond to the storage slot numbers. This fact is important because the IBM Spectrum Protect server always references storage slots by element addresses, not storage slot numbers. For element addresses, see the library configuration page for each library.
- For a library with multiple drives, a drive element address is required for the DEFINE and UPDATE DRIVE commands. However, if the library reports drive serial numbers, you can specify `ELEMENT=AUTODETECT`, and the element address is not required.
- For the procedure to configure the autochanger and each drive in the library separately, see Configuring and managing storage devices.

## Updates, limitations, and known problems

---



## Updates

Some devices that were supported by previous releases of IBM Spectrum Protect are no longer supported by the IBM Spectrum Protect V8.1 server. For the latest list of supported devices, see the following links:

- Supported devices for AIX and Windows
- Supported devices for Linux

To search for the latest updates, limitations, and known problems, which might include additional items, see Updates, limitations, and known problems for IBM Spectrum Protect V8.1 device support.

## Readme files for Version 8.1 server components

Readme files for Version 8.1 fix packs are published in the IBM Software Support website. Updates might be available for server components, including the server itself, device support, and the Operations Center.

View IBM Spectrum Protect™ server V8.1 fix pack readme files

## Installing and upgrading

- Implementing an IBM Spectrum Protect solution  
If you are deploying a new IBM Spectrum Protect server environment, consider implementing a best practice configuration.
- Installing and upgrading the server  
The IBM Spectrum Protect server provides backup, archive, and space management services to clients. You can install or upgrade individual or multiple servers in your enterprise network.
- Installing and upgrading the Operations Center  
The Operations Center is the web-based interface for managing your storage environment.

## Implementing an IBM Spectrum Protect solution

If you are deploying a new IBM Spectrum Protect™ server environment, consider implementing a best practice configuration.

IBM Spectrum Protect solution documentation is available to help you select a best practice solution, based on your business needs and then install, configure, monitor, and operate that solution.

For details, see Selecting an IBM Spectrum Protect solution.

## Availability of features by operating system

Most IBM Spectrum Protect™ features are available on all operating systems that are supported for the server.

In the following table, a check mark indicates that a feature is available.

Table 1. Availability of IBM Spectrum Protect features by operating system

Feature	IBM® AIX®	Linux x86_64	Linux on System z®	Linux on Power Systems™ (little endian)	Microsoft Windows
Aspera® Fast Adaptive Secure Protocol (FASP®) technology: Optimize data transfer to a remote server.		✓			
Cloud storage by using Amazon Simple Storage Service (Amazon S3) technology.	✓	✓		✓	✓
Cloud storage by using IBM Cloud Object Storage technology.	✓	✓		✓	✓

Feature	IBM® AIX®	Linux x86_64	Linux on System z®	Linux on Power Systems™ (little endian)	Microsoft Windows
Cloud storage by using IBM SoftLayer® (IBM Bluemix®) technology.	✓	✓		✓	✓
Cloud storage by using Microsoft Azure technology.	✓	✓		✓	✓
Cloud storage by using OpenStack Swift technology.	✓	✓		✓	✓
Data deduplication: Use <i>inline data deduplication</i> to eliminate duplicate data while the data is written to a directory-container storage pool or cloud-container storage pool. By using inline data deduplication, you reduce the need for offline reorganization and can improve server performance and lower the cost of storage hardware.	✓	✓	✓	✓	✓
Data deduplication: Use <i>postprocess data deduplication</i> to eliminate duplicate data from sequential-access disk storage pools. This option can result in longer processing times because the server must identify the data, and then remove it from the storage pool.	✓	✓	✓	✓	✓
Disaster recovery manager (DRM): Prepare a plan for recovering your server and client data if a disaster occurs.	✓	✓	✓	✓	✓
Inline data compression: Compress data as it is written to a cloud-container or directory-container storage pool to reduce the amount of space that the data occupies.	✓	✓	✓	✓	✓
Lightweight Directory Access Protocol (LDAP) authentication: Authenticate users to an Active Directory database on an LDAP server.	✓	✓	✓	✓	✓
Node replication: Incrementally copy data that belongs to backup-archive client nodes from one server to another.	✓	✓	✓	✓	✓
Operations Center: Monitor and manage the storage environment by using the Operations Center, a web-based user interface.	✓	✓	✓	✓	✓

Feature	IBM® AIX®	Linux x86_64	Linux on System z®	Linux on Power Systems™ (little endian)	Microsoft Windows
Protection of directory-container storage pools: Protect data in directory-container storage pools by using the PROTECT STGPPOOL command. You can store a copy of the data in another directory-container storage pool on a target replication server, or store a copy on tape in a container-copy storage pool on the same server.	✓	✓	✓	✓	✓
Storage pool encryption: Encrypt data in cloud-container storage pools.	✓	✓		✓	✓
Storage pool encryption: Encrypt data in directory-container storage pools.	✓	✓	✓	✓	✓
Tape storage: Store data on tape, which provides a flexible and affordable option for long-term data retention.	✓	✓	✓	✓	✓
Transport Layer Security (TLS) 1.2 protocol: Secure communications by using TLS 1.2.	✓	✓	✓	✓	✓

## Installing and upgrading the server

The IBM Spectrum Protect™ server provides backup, archive, and space management services to clients. You can install or upgrade individual or multiple servers in your enterprise network.

- Installing the server on AIX systems
- Installing the server on Linux systems
- Installing the server on Windows systems
- Upgrading the server

## AIX: Installing the server

Installation of the server includes planning, installation, and initial configuration.

- AIX: Planning to install the server  
Install the server software on the computer that manages storage devices and install the client software on every workstation that transfers data to IBM Spectrum Protect™ server-managed storage.
- AIX: Installing the server components  
To install the Version 8.1.2 server components, you can use the installation wizard, the command line in console mode, or silent mode.
- AIX: Taking the first steps after you install IBM Spectrum Protect  
After you install Version 8.1.2, prepare for the configuration. Using the configuration wizard is the preferred method of configuring the IBM Spectrum Protect instance.
- AIX: Installing an IBM Spectrum Protect server fix pack  
IBM Spectrum Protect maintenance updates, which are also referred to as fix packs, bring your server up to the current maintenance level.
- AIX: Reverting from Version 8.1.2 to a previous server  
If you must revert to the previous version of the server after an upgrade, you must have a full database backup from your original version. You must also have the server installation media for your original version and key configuration files. Carefully follow the preparation steps before you upgrade the server. By doing so, it might be possible to revert to the previous version of the IBM Spectrum Protect server with minimal loss of data.

- **AIX: Reference: DB2 commands for IBM Spectrum Protect server databases**  
Use this list as reference when you are directed to issue DB2® commands by IBM® support.
- **AIX: Uninstalling IBM Spectrum Protect**  
You can use the following procedures to uninstall IBM Spectrum Protect. Before you remove IBM Spectrum Protect, ensure that you do not lose your backup and archive data.

## AIX: Planning to install the server

---

Install the server software on the computer that manages storage devices and install the client software on every workstation that transfers data to IBM Spectrum Protect™ server-managed storage.

- **AIX: What you should know first**  
Before installing IBM Spectrum Protect, be familiar with your operating systems, storage devices, communication protocols, and system configurations.
- **AIX: What you should know about security before you install or upgrade the server**  
Before you install IBM Spectrum Protect V8.1.2 or later, review information about the enhanced security features and the requirements for updating your environment.
- **AIX: Planning for optimal performance**  
Before you install the IBM Spectrum Protect server, evaluate the characteristics and configuration of the system to ensure that the server is set up for optimal performance.
- **AIX** **AIX: Minimum system requirements for AIX systems**  
Before you install an IBM Spectrum Protect server on an AIX operating system on a system without data deduplication, review the hardware and software requirements.
- **AIX** **AIX: Compatibility of the IBM Spectrum Protect server with other DB2 products on the system**  
You can install other products that deploy and use DB2® products on the same system as the IBM Spectrum Protect Version 8.1.2 server, with some limitations.
- **AIX: IBM Installation Manager**  
IBM Spectrum Protect uses IBM® Installation Manager, which is an installation program that can use remote or local software repositories to install or update many IBM products.
- **AIX: Worksheets for planning details for the server**  
You can use the worksheets to help you plan the amount and location of storage needed for the IBM Spectrum Protect server. You can also use them to keep track of names and user IDs.
- **AIX: Capacity planning**  
Capacity planning for IBM Spectrum Protect includes managing resources such as the database, the recovery log and the shared resource area. To maximize resources as part of capacity planning, you must estimate space requirements for the database and the recovery log. The shared resource area must have enough space available for each installation or upgrade.
- **AIX: Server naming best practices**  
Use these descriptions as a reference when you install or upgrade an IBM Spectrum Protect server.
- **AIX: Installation directories**  
Installation directories for the IBM Spectrum Protect server include the server, DB2, device, language, and other directories. Each one contains several additional directories.

## AIX: What you should know first

---

Before installing IBM Spectrum Protect™, be familiar with your operating systems, storage devices, communication protocols, and system configurations.

Server maintenance releases, client software, and publications are available from the IBM® Support Portal.

**AIX** **Restriction:** You can install and run the Version 8.1.2 server on a system that already has DB2® installed on it, whether DB2 was installed independently or as part of some other application, with some restrictions. For details, see the compatibility with other DB2 products topic.

Experienced DB2 administrators can choose to perform advanced SQL queries and use DB2 tools to monitor the database. Do not, however, use DB2 tools to change DB2 configuration settings from those that are preset by IBM Spectrum Protect, or alter the DB2 environment for IBM Spectrum Protect in other ways, such as with other products. The V8.1.2 server has been built and tested extensively using the data definition language (DDL) and database configuration that the server deploys.

**Attention:** Do not alter the DB2 software that is installed with IBM Spectrum Protect installation packages and fix packs. Do not install or upgrade to a different version, release, or fix pack of DB2 software because doing so can damage the database.

# AIX: What you should know about security before you install or upgrade the server

---

Before you install IBM Spectrum Protect™ V8.1.2 or later, review information about the enhanced security features and the requirements for updating your environment.

## About this task

---

Security enhancements that were introduced in V8.12 and later enforce stricter security settings. To ensure that communication between servers and clients is not interrupted when you install or upgrade IBM Spectrum Protect software to V8.1.2, follow the procedure.

## Procedure

---

1. Install or upgrade the IBM Spectrum Protect servers to 8.1.2 or later.
2. Install or upgrade the backup-archive clients. For more information, see *Installing and configuring clients*.  
For information about scheduling deployment of client updates from the server, see the following documents:
  - o For IBM Spectrum Protect 8.1.2 or later servers, see technote 2004596.
  - o For IBM® Tivoli® Storage Manager V7.1 servers and IBM Spectrum Protect V8.1.0 and V8.1.1 servers, see technote 1673299.
3. Configure the options for backup-archive clients. For more information, see *Upgrading the IBM Spectrum Protect Server and the IBM Spectrum Protect Client*.

# AIX: Planning for optimal performance

---

Before you install the IBM Spectrum Protect™ server, evaluate the characteristics and configuration of the system to ensure that the server is set up for optimal performance.

## Procedure

---

1. Review AIX: What you should know first.
2. Review each of the following sub-sections.
  - AIX: Planning for the server hardware and the operating system  
Use the checklist to verify that the system where the server is installed meets requirements for hardware and software configuration.
  - AIX: Planning for the server database disks  
Use the checklist to verify that the system where the server is installed meets requirements for hardware and software configuration.
  - AIX: Planning for the server recovery log disks  
Use the checklist to verify that the system where the server is installed meets requirements for hardware and software configuration.
  - AIX: Planning for directory-container and cloud-container storage pools  
Review how your directory-container and cloud-container storage pools are set up to ensure optimal performance.
  - AIX: Planning for storage pools in DISK or FILE device classes  
Use the checklist to review how your disk storage pools are set up. This checklist includes tips for storage pools that use DISK or FILE device classes.
  - AIX: Planning for the correct type of storage technology  
Storage devices have different capacity and performance characteristics. These characteristics affect which devices are better for use with IBM Spectrum Protect.
  - AIX: Applying best practices to the server installation  
Typically, hardware configuration and selection have the most significant effect on the performance of an IBM Spectrum Protect solution. Other factors that affect performance are the operating system selection and configuration, and the configuration of IBM Spectrum Protect.

# AIX: Planning for the server hardware and the operating system

---

Use the checklist to verify that the system where the server is installed meets requirements for hardware and software configuration.

Question	Tasks, characteristics, options, or settings	More information
<p>Does the operating system and hardware meet or exceed requirements?</p> <ul style="list-style-type: none"> <li>• Number and speed of processors</li> <li>• System memory</li> <li>• Supported operating system level</li> </ul>	<p>If you are using the minimum required amount of memory, you can support a minimal workload.</p> <p>You can experiment by adding more system memory to determine whether the performance is improved. Then, decide whether you want to keep the system memory dedicated to the server. Test the memory variations by using the entire daily cycle of the server workload.</p> <p>If you run multiple servers on the system, add the requirements for each server to get the requirements for the system.</p> <p><b>AIX</b> Restriction: Do not use Active Memory™ Expansion (AME). When you use AME, DB2® software uses 4 KB pages instead of 64 KB pages. Each 4 KB page must be decompressed when accessed, and compressed when not needed. When the compression or decompression occurs, DB2 and the server wait for access to the page, which degrades the server performance.</p>	<p>Review operating system requirements at technote 1243309.</p> <p>Additionally, review the guidance in Tuning tasks for operating systems and other applications.</p> <p>For more information about requirements when these features are in use, see the following topics:</p> <ul style="list-style-type: none"> <li>• Checklist for data deduplication</li> <li>• Checklist for node replication</li> </ul> <p>For more information about sizing requirements for the server and storage, see the IBM Spectrum Protect™ Blueprint.</p>
<p>Are disks configured for optimal performance?</p>	<p>The amount of tuning that can be done for different disk systems varies. Ensure that the appropriate queue depths and other disk system options are set.</p>	<p>For more information, see the following topics:</p> <ul style="list-style-type: none"> <li>• "Planning for server database disks"</li> <li>• "Planning for server recovery log disks"</li> <li>• "Planning for storage pools in DISK or FILE device classes"</li> </ul>

Question	Tasks, characteristics, options, or settings	More information
Does the server have enough memory?	<p>Heavier workloads and advanced features such as data deduplication and node replication require more than the minimum system memory that is specified in the system requirements document.</p> <p>For databases that are not enabled for data deduplication, use the following guidelines to specify memory requirements:</p> <ul style="list-style-type: none"> <li>• For databases less than 500 GB, you need 16 GB of memory.</li> <li>• For databases with a size of 500 GB - 1 TB, you need 24 GB of memory.</li> <li>• For databases with a size of 1 TB - 1.5 TB, you need 32 GB of memory.</li> <li>• For databases greater than 1.5 TB, you need 40 GB of memory.</li> </ul> <p>Ensure that you allocate extra space for the active log and the archive log for replication processing.</p>	<p>For more information about requirements when these features are in use, see the following topics:</p> <ul style="list-style-type: none"> <li>• Checklist for data deduplication</li> <li>• Checklist for node replication</li> <li>• Memory requirements</li> </ul>
Does the system have enough host bus adapters (HBAs) to handle the data operations that the IBM Spectrum Protect server must run simultaneously?	<p>Understand what operations require use of HBAs at the same time.</p> <p>For example, a server must store 1 GB/sec of backup data while also doing storage pool migration that requires 0.5 GB/sec capacity to complete. The HBAs must be able to handle all of the data at the speed required.</p>	See Tuning HBA capacity.
Is network bandwidth greater than the planned maximum throughput for backups?	<p>Network bandwidth must allow the system to complete operations such as backups in the time that is allowed or that meets service level commitments.</p> <p>For node replication, network bandwidth must be greater than the planned maximum throughput.</p>	<p>For more information, see the following topics:</p> <ul style="list-style-type: none"> <li>• Tuning network performance</li> <li>• Checklist for node replication</li> </ul>

Question	Tasks, characteristics, options, or settings	More information
Are you using a preferred file system for IBM Spectrum Protect server files?	<p>Use a file system that ensures optimal performance and data availability. The server uses direct I/O with file systems that support the feature. Using direct I/O can improve throughput and reduce processor use. The following list identifies the preferred file system:</p> <ul style="list-style-type: none"> <li> <span style="background-color: #800040; color: white; padding: 2px;">AIX</span> AIX® Use the JFS2 file system with the rbrw option. </li> </ul>	For more information, see Configuring the operating system for disk performance.
Are you planning to configure enough paging space?	<p>Paging space, or swap space, extends the memory that is available for processing. When the amount of free RAM in the system is low, programs or data that is not in use are moved from memory to paging space. This action releases memory for other activities, such as database operations.</p> <p><span style="background-color: #800040; color: white; padding: 2px;">AIX</span> Use a minimum of 32 GB of paging space or 50% of your RAM, whichever value is larger.</p>	

## AIX: Planning for the server database disks

Use the checklist to verify that the system where the server is installed meets requirements for hardware and software configuration.

Question	Tasks, characteristics, options, or settings	More information
----------	--	------------------



Question	Tasks, characteristics, options, or settings	More information
Is the database on fast, low-latency disks?	<p>Do not use the following drives for the IBM Spectrum Protect™ database:</p> <ul style="list-style-type: none"> <li>• Nearline SAS (NL-SAS)</li> <li>• Serial Advanced Technology Attachment (SATA)</li> <li>• Parallel Advanced Technology Attachment (PATA)</li> </ul> <p>Do not use internal disks that are included by default in most server hardware.</p> <p>Enterprise-grade solid-state disks (SSD), with Fibre Channel or SAS interface, offer the best performance.</p> <p>If you plan to use the data deduplication functions of IBM Spectrum Protect, focus on disk performance in terms of I/O operations per second (IOPS).</p>	For more information, see Checklist for data deduplication.
Is the database stored on disks or LUNs that are separate from disks or LUNs that are used for the active log, archive log, and storage pool volumes?	<p>Separation of the server database from other server components helps reduce contention for the same resources by different operations that must run at the same time.</p> <p>Tip: The database and the archive log can share an array when you use solid-state drive (SSD) technology.</p>	
If you are using RAID, do you know how to select the optimal RAID level for your system? Are you defining all LUNs with the same size and type of RAID?	<p>When a system must do large numbers of writes, RAID 10 outperforms RAID 5. However, RAID 10 requires more disks than RAID 5 for the same amount of usable storage.</p> <p>If your disk system is RAID, define all your LUNs with the same size and type of RAID. For example, do not mix 4+1 RAID 5 with 4+2 RAID 6.</p>	
If an option to set the strip size or segment size is available, are you planning to optimize the size when you configure the disk system?	If you can set the strip size or segment size, use 64 KB or 128 KB sizes on disk systems for the database.	The block size that is used for the database varies depending on the table space. Most table spaces use 8 KB blocks, but some use 32 KB blocks.

Question	Tasks, characteristics, options, or settings	More information
<p>Are you planning to create at least four directories, also called storage paths, on four separate LUNs for the database?</p> <p>Create one directory per distinct array on the subsystem. If you have fewer than three arrays, create a separate LUN volume within the array.</p>	<p>Heavier workloads and use of some features require more database storage paths than the minimum requirements.</p> <p>Server operations such as data deduplication drive a high number of input/output operations per second (IOPS) for the database. Such operations perform better when the database has more directories.</p> <p>For server databases that are larger than 2 TB or are expected to grow to that size, use eight directories.</p> <p>Consider planned growth of the system when you determine how many storage paths to create. The server uses the higher number of storage paths more effectively if the storage paths are present when the server is first created.</p> <p>Use the <i>DB2_PARALLEL_IO</i> variable to force parallel I/O to occur on table spaces that have one container, or on table spaces that have containers on more than one physical disk. If you do not set the <i>DB2_PARALLEL_IO</i> variable, I/O parallelism is equal to the number of containers that are used by the table space. For example, if a table space spans four containers, the level of I/O parallelism that is used is 4.</p>	<p>For more information, see the following topics:</p> <ul style="list-style-type: none"> <li>• Checklist for data deduplication</li> <li>• Checklist for node replication</li> </ul> <p>For help with forecasting growth when the server deduplicates data, see technote 1596944.</p> <p>For the most recent information about database size, database reorganization, and performance considerations for IBM Spectrum Protect servers, see technote 1683633.</p> <p>For information about setting the <i>DB2_PARALLEL_IO</i> variable, see Recommended settings for IBM DB2 registry variables.</p>
<p>Are all directories for the database the same size?</p>	<p>Directories that are all the same size ensure a consistent degree of parallelism for database operations. If one or more directories for the database are smaller than the others, they reduce the potential for optimized parallel prefetching.</p> <p>This guideline also applies if you must add storage paths after the initial configuration of the server.</p>	
<p>Are you planning to raise the queue depth of the database LUNs on AIX® systems?</p>	<p>The default queue depth is often too low.</p>	<p>See Configuring AIX systems for disk performance.</p>

## AIX: Planning for the server recovery log disks

Use the checklist to verify that the system where the server is installed meets requirements for hardware and software configuration.

Question	Tasks, characteristics, options, or settings	More information
<p>Are the active log and archive log stored on disks or LUNs that are separate from what is used for the database and storage pool volumes?</p>	<p>Ensure that the disks where you place the active log are not used for other server or system purposes. Do not place the active log on disks that contain the server database, the archive log, or system files such as page or swap space.</p>	<p>Separation of the server database, active log, and archive log helps to reduce contention for the same resources by different operations that must run at the same time.</p>

Question	Tasks, characteristics, options, or settings	More information
Are the logs on disks that have nonvolatile write cache?	Nonvolatile write cache allows data to be written to the logs as fast as possible. Faster write operations for the logs can improve performance for server operations.	
Are you setting the logs to a size that adequately supports the workload?	<p>If you are not sure about the workload, use the largest size that you can.</p> <p><b>Active log</b> The maximum size is 512 GB, set with the ACTIVELOGSIZE server option.</p> <p>Ensure that there is at least 8 GB of free space on the active log file system after the fixed size active logs are created.</p> <p><b>Archive log</b> The size of the archive log is limited by the size of the file system on which it is located, and not by a server option. Make the archive log at least as large as the active log.</p>	<ul style="list-style-type: none"> <li>For log sizing details, see the recovery log information in technote 1421060.</li> <li>For information about sizing when you use data deduplication, see Checklist for data deduplication.</li> </ul>
Are you defining an archive failover log? Are you placing this log on a disk that is separate from the archive log?	The archive failover log is for emergency use by the server when the archive log becomes full. Slower disks can be used for the archive failover log.	<p>Use the ARCHFAILOVERLOGDIRECTORY server option to specify the location of the archive failover log.</p> <p>Monitor the usage of the directory for the archive failover log. If the archive failover log must be used by the server, the space for the archive log might not be large enough.</p>
If you are mirroring the active log, are you using only one type of mirroring?	<p>You can mirror the log by using one of the following methods. Use only one type of mirroring for the log.</p> <ul style="list-style-type: none"> <li>Use the MIRRORLOGDIRECTORY option that is available for the IBM Spectrum Protect™ server to specify a mirror location.</li> <li>Use software mirroring, such as Logical Volume Manager (LVM) on AIX®.</li> <li>Use mirroring in the disk system hardware.</li> </ul>	<p>If you mirror the active log, ensure that the disks for both the active log and the mirror copy have equal speed and reliability.</p> <p>For more information, see Configuring and tuning the recovery log.</p>

## AIX: Planning for directory-container and cloud-container storage pools

Review how your directory-container and cloud-container storage pools are set up to ensure optimal performance.

Question	Tasks, characteristics, options, or settings	More information
----------	--	------------------

Question	Tasks, characteristics, options, or settings	More information
<p>Measured in terms of input/output operations per second (IOPS), are you using fast disk storage for the IBM Spectrum Protect™ database?</p>	<p>Use a high-performance disk for the database. Use solid-state drive technology for data deduplication processing.</p> <p>Ensure that the database has a minimum capability of 3000 IOPS. For each TB of data that is backed up daily (before data deduplication), add 1000 IOPS to this minimum.</p> <p>For example, an IBM Spectrum Protect server that is ingesting 3 TB of data per day would need 6000 IOPS for the database disks:</p> $3000 \text{ IOPS minimum} + 3000 (3 \text{ TB} \times 1000 \text{ IOPS}) = 6000 \text{ IOPS}$	<p>For recommendations about disk selection, see "Planning for server database disks".</p> <p>For more information about IOPS, see the IBM Spectrum Protect Blueprints.</p>
<p>Do you have enough memory for the size of your database?</p>	<p>Use a minimum of 40 GB of system memory for IBM Spectrum Protect servers, with a database size of 100 GB, that are deduplicating data. If the retained capacity of backup data grows, the memory requirement might need to be higher.</p> <p>Monitor memory usage regularly to determine whether more memory is required.</p> <p>Use more system memory to improve caching of database pages. The following memory size guidelines are based on the daily amount of new data that you back up:</p> <ul style="list-style-type: none"> <li>• 128 GB of system memory for daily backups of data, where the database size is 1 - 2 TB</li> <li>• 192 GB of system memory for daily backups of data, where the database size is 2 - 4 TB</li> </ul>	<p>Memory requirements</p>

Question	Tasks, characteristics, options, or settings	More information
<p>Have you properly sized the storage capacity for the database active log and archive log?</p>	<p>Configure the server to have a minimum active log size of 128 GB by setting the ACTIVELOGSIZE server option to a value of 131072.</p> <p>The suggested starting size for the archive log is 1 TB. The size of the archive log is limited by the size of the file system on which it is located, and not by a server option. Ensure that there is at least 10% extra disk space for the file system than the size of the archive log.</p> <p>Use a directory for the database archive logs with an initial free capacity of at least 1 TB. Specify the directory by using the ARCHLOGDIRECTORY server option.</p> <p>Define space for the archive failover log by using the ARCHFAILOVERLOGDIRECTORY server option.</p>	<p>For more information about sizing for your system, see the IBM Spectrum Protect Blueprints.</p>
<p>Is compression enabled for the archive log and database backups?</p>	<p>Enable the ARCHLOGCOMPRESS server option to save storage space.</p> <p>This compression option is different from inline compression. Inline compression is enabled by default with IBM Spectrum Protect V7.1.5 and later.</p> <p>Restriction: Do not use this option if the amount of backed up data exceeds 6 TB per day.</p>	<p>For more information about compression for your system, see the IBM Spectrum Protect Blueprints.</p>
<p>Are the IBM Spectrum Protect database and logs on separate disk volumes (LUNs)?</p> <p>Is the disk that is used for the database configured according to best practices for a transactional database?</p>	<p>The database must not share disk volumes with IBM Spectrum Protect database logs or storage pools, or with any other application or file system.</p>	<p>For more information about server database and recovery log configuration, see Server database and recovery log configuration and tuning.</p>
<p>Are you using a minimum of eight (2.2 GHz or equivalent) processor cores for each IBM Spectrum Protect server that you plan to use with data deduplication?</p>	<p>If you are planning to use client-side data deduplication, verify that client systems have adequate resources available during a backup operation to complete data deduplication processing. Use a processor that is at least the minimum equivalent of one 2.2 GHz processor core per backup process with client-side data deduplication.</p>	<ul style="list-style-type: none"> <li>• Effective planning and use of deduplication</li> <li>• IBM Spectrum Protect Blueprints</li> </ul>

Question	Tasks, characteristics, options, or settings	More information
Did you allocate enough storage space for the database?	<p>For a rough estimate, plan for 100 GB of database storage for every 50 TB of data that is to be protected in deduplicated storage pools. <i>Protected data</i> is the amount of data before data deduplication, including all versions of objects stored.</p> <p>As a best practice, define a new container storage pool exclusively for data deduplication. Data deduplication occurs at the storage-pool level, and all data within a storage pool, except encrypted data, is deduplicated.</p>	
Have you estimated storage pool capacity to configure enough space for the size of your environment?	<p>You can estimate capacity requirements for a deduplicated storage pool by using the following technique:</p> <ol style="list-style-type: none"> <li>1. Estimate the base size of the source data.</li> <li>2. Estimate the daily backup size by using an estimated change and growth rate.</li> <li>3. Determine retention requirements.</li> <li>4. Estimate the total amount of source data by factoring in the base size, daily backup size, and retention requirements.</li> <li>5. Apply the deduplication ratio factor.</li> <li>6. Apply the compression ratio factor.</li> <li>7. Round up the estimate to consider transient storage pool usage.</li> </ol>	For an example of using this technique, see Effective planning and use of deduplication.
Have you distributed disk I/O over many disk devices and controllers?	<p>Use arrays that consist of as many disks as possible, which is sometimes referred to as wide striping. Ensure that you use one database directory per distinct array on the subsystem.</p> <p>Set the <i>DB2_PARALLEL_IO</i> registry variable to enable parallel I/O for each table space used if the containers in the table space span multiple physical disks.</p> <p>When I/O bandwidth is available and the files are large, for example 1 MB, the process of finding duplicates can occupy the resources of an entire processor. When files are smaller, other bottlenecks can occur.</p> <p>Specify eight or more file systems for the deduplicated storage pool device class so that I/O is distributed across as many LUNs and physical devices as possible.</p>	<p>For guidelines about setting up storage pools, see "Planning for storage pools in DISK or FILE device classes".</p> <p>For information about setting the <i>DB2_PARALLEL_IO</i> variable, see Recommended settings for IBM DB2 registry variables.</p>

Question	Tasks, characteristics, options, or settings	More information
Have you scheduled daily operations based on your backup strategy?	<p>The best practice sequence of operations is in the following order:</p> <ol style="list-style-type: none"> <li>1. Client backup</li> <li>2. Storage pool protection</li> <li>3. Node replication</li> <li>4. Database backup</li> <li>5. Expire inventory</li> </ol>	<ul style="list-style-type: none"> <li>• Scheduling data deduplication and node replication processes</li> <li>• Daily operations for directory-container storage pools</li> </ul>
Do you have enough storage to manage the DB2® lock list?	<p>If you deduplicate data that includes large files or large numbers of files concurrently, the process can result in insufficient storage space. When the lock list storage is insufficient, backup failures, data management process failures, or server outages can occur.</p> <p>File sizes greater than 500 GB that are processed by data deduplication are most likely to deplete storage space. However, if many backup operations use client-side data deduplication, this problem can also occur with smaller-sized files.</p>	For information about tuning the DB2 LOCKLIST parameter, see Tuning server-side data deduplication.
Is sufficient bandwidth available to transfer data to an IBM Spectrum Protect server?	<p>To transfer data to an IBM Spectrum Protect server, use client-side or server-side data deduplication and compression to reduce the bandwidth that is required.</p> <p>Use a V7.1.5 server or higher to use inline compression and use a V7.1.6 or later client to enable enhanced compression processing.</p>	For more information, see the enablededup client option.
Have you determined how many storage pool directories to assign to each storage pool?	<p>Assign directories to a storage pool by using the DEFINE STGPOOLDIRECTORY command.</p> <p>Create multiple storage pool directories and ensure that each directory is backed up to a separate disk volume (LUN).</p>	

Question	Tasks, characteristics, options, or settings	More information
<p>Did you allocate enough disk space in the cloud-container storage pool?</p>	<p>To prevent backup failures, ensure that the local directory has enough space. Use the following list as a guide for optimal disk space:</p> <ul style="list-style-type: none"> <li>• For serial-attached SCSI (SAS) and spinning disk, calculate the amount of new data that is expected after daily data reduction (compression and data deduplication). Allocate up to 100 percent of that amount, in terabytes, for disk space.</li> <li>• Provide 3 TB for flash-based storage systems with fast network connections to on-premises, high-performance cloud systems.</li> <li>• Provide 5 TB for solid-state drive (SSD) systems with fast network connections to high-performance cloud systems.</li> </ul>	
<p>Did you select the appropriate type of local storage?</p>	<p>Ensure that data transfers from local storage to cloud finish before the next backup cycle starts.  Tip: Data is removed from local storage soon after it moves to the cloud.  Use the following guidelines:</p> <ul style="list-style-type: none"> <li>• Use flash or SSD for large systems that have high-performing cloud systems. Ensure that you have a dedicated 10 GB wide area network (WAN) link with a high-speed connection to the object storage. For example, use flash or SSD if you have a dedicated 10 GB WAN link plus a high-speed connection to either an IBM® Cloud Object Storage location or to an Amazon Simple Storage Service (Amazon S3) data center.</li> <li>• Use larger capacity 15000 rpm SAS disks for these scenarios: <ul style="list-style-type: none"> <li>◦ Medium-sized systems</li> <li>◦ Slower cloud connections, for example, 1 GB</li> <li>◦ When you use IBM Cloud Object Storage as your service provider across several regions</li> </ul> </li> <li>• For SAS or spinning disk, calculate the amount of new data that is expected after daily data reduction (compression and data deduplication). Allocate up to 100 percent of that amount for disk space, in terabytes.</li> </ul>	



## AIX: Planning for storage pools in DISK or FILE device classes

Use the checklist to review how your disk storage pools are set up. This checklist includes tips for storage pools that use DISK or FILE device classes.

Question	Tasks, characteristics, options, or settings	More information
Can the storage pool LUNs sustain throughput rates for 256 KB sequential reads and writes to adequately handle the workload within the time constraints?	<p>When you are planning for peak loads, consider all the data that you want the server to read or write to the disk storage pools simultaneously. For example, consider the peak flow of data from client backup operations and server data-movement operations such as migration that run at the same time.</p> <p>The IBM Spectrum Protect™ server reads and writes to storage pools predominantly in 256 KB blocks.</p> <p>If the disk system includes the capability, configure the disk system for optimal performance with sequential read/write operations rather than random read/write operations.</p>	For more information, see Analyzing the basic performance of disk systems.
Is the disk configured to use read and write cache?	Use more cache for better performance.	
For storage pools that use FILE device classes, have you determined a good size to use for the storage pool volumes?	Review the information in Optimal number and size of volumes for storage pools that use disk. If you do not have the information to estimate a size for FILE device class volumes, start with volumes that are 50 GB.	Typically, problems arise more frequently when the volumes are too small. Few problems are reported when volumes are larger than needed. When you determine the volume size to use, as a precaution choose a size that might be larger than necessary.
For storage pools that use FILE device classes, are you using preallocated volumes?	<p>Scratch volumes can cause file fragmentation.</p> <p>To ensure that a storage pool does not run out of volumes, set the MAXSCRATCH parameter to a value greater than zero.</p>	<p>Use the DEFINE VOLUME server command to preallocate volumes in the storage pool.</p> <p>Use the DEFINE STGPOOL or UPDATE STGPOOL server command to set the MAXSCRATCH parameter.</p>
For storage pools that use FILE device classes, have you compared the maximum number of client sessions to the number of volumes that are defined?	Always maintain enough usable volumes in the storage pools to allow for the expected peak number of client sessions that run at one time. The volumes might be scratch volumes, empty volumes, or partly filled volumes.	For storage pools that use FILE device classes, only one session or process can write to a volume at the same time.

Question	Tasks, characteristics, options, or settings	More information
<p>For storage pools that use FILE device classes, have you set the MOUNTLIMIT parameter of the device class to a value that is high enough to account for the number of volumes that might be mounted in parallel?</p>	<p>For storage pools that use data deduplication, the MOUNTLIMIT parameter is typically in the range of 500 - 1000.</p> <p>Set the value for MOUNTLIMIT to the maximum number of mount points that are needed for all active sessions. Consider parameters that affect the maximum number of mount points that are needed:</p> <ul style="list-style-type: none"> <li>• The MAXSESSIONS server option, which is the maximum number of IBM Spectrum Protect sessions that can run concurrently.</li> <li>• The MAXNUMMP parameter, which sets the maximum number of mount points that each client node can use.</li> </ul> <p>For example, if the maximum number of client node backup sessions is typically 100 and each of the nodes has MAXNUMMP=2, multiply 100 nodes by the 2 mount points for each node to get the value of 200 for the MOUNTLIMIT parameter.</p>	<p>Use the REGISTER NODE or UPDATE NODE server command to set the MAXNUMMP parameter for client nodes.</p>
<p>For storage pools that use DISK device classes, have you determined how many storage pool volumes to put on each file system?</p>	<p>How you configure the storage for a storage pool that uses a DISK device class depends on whether you are using RAID for the disk system.</p> <p>If you are not using RAID, then configure one file system per physical disk, and define one storage pool volume for each file system.</p> <p>If you are using RAID 5 with <math>n + 1</math> volumes, configure the storage in one of the following ways:</p> <ul style="list-style-type: none"> <li>• Configure <math>n</math> file systems on the LUN and define one storage pool volume per file system.</li> <li>• Configure one file system and <math>n</math> storage pool volumes for the LUN.</li> </ul>	<p>For an example layout that follows this guideline, see Sample layout of server storage pools.</p>
<p>Did you create your storage pools to distribute I/O across multiple file systems?</p>	<p>Ensure that each file system is on a different LUN on the disk system.</p> <p>Typically, having 10 - 30 file systems is a good goal, but ensure that the file systems are no smaller than approximately 250 GB.</p>	<p>For details, see the following topics:</p> <ul style="list-style-type: none"> <li>• Tuning disk storage for the server</li> <li>• Tuning and configuring storage pools and volumes</li> </ul>

## AIX: Planning for the correct type of storage technology

Storage devices have different capacity and performance characteristics. These characteristics affect which devices are better for use with IBM Spectrum Protect™.

### Procedure

Review the following table to help you to choose the correct type of storage technology for the storage resources that the server requires.

Table 1. Storage technology types for IBM Spectrum Protect storage requirements

<b>Storage technology type</b>	<b>Database</b>	<b>Active log</b>	<b>Archive log and archive failover log</b>	<b>Storage pools</b>
<b>Solid-state disk (SSD)</b>	Place the database on SSD in the following circumstances: <ul style="list-style-type: none"> <li>You are using IBM Spectrum Protect data deduplication.</li> <li>You are backing up more than 8 TB of new data daily.</li> </ul>	If you place the IBM Spectrum Protect database on an SSD, as a best practice, place the active log on an SSD. If space is not available, use high-performance disk instead.	Save SSDs for use with the database and active log. The archive log and archive failover logs can be placed on slower storage technology types.	Save SSDs for use with the database and active log. Storage pools can be placed on slower storage technology types.
<b>High-performance disk with the following characteristic s:</b> <ul style="list-style-type: none"> <li><b>15k rpm disk</b></li> <li><b>Fibre Channel or serial-attached SCSI (SAS) interface</b></li> </ul>	Use high-performance disks in the following circumstances: <ul style="list-style-type: none"> <li>The server does not do data deduplication.</li> <li>The server does not do node replication.</li> </ul> Isolate the server database from its logs and storage pools, and from data for other applications.	Use high-performance disks in the following circumstances: <ul style="list-style-type: none"> <li>The server does not do data deduplication.</li> <li>The server does not do node replication.</li> </ul> For performance and availability, isolate the active log from the server database, archive logs, and storage pools.	You can use high-performance disks for the archive log and archive failover logs. For availability, isolate these logs from the database and active log.	Use high-performance disks for storage pools in the following circumstances: <ul style="list-style-type: none"> <li>Data is frequently read.</li> <li>Data is frequently written.</li> </ul> For performance and availability, isolate storage pool data from the server database and logs, and from data for other applications.
<b>Medium-performance or high-performance disk with the following characteristic s:</b> <ul style="list-style-type: none"> <li><b>10k rpm disk</b></li> <li><b>Fibre Channel or SAS interface</b></li> </ul>	If the disk system has a mix of disk technologies, use the faster disks for the database and active log. Isolate the server database from its logs and storage pools, and from data for other applications.	If the disk system has a mix of disk technologies, use the faster disks for the database and active log. For performance and availability, isolate the active log from the server database, archive logs, and storage pools.	You can use medium-performance or high-performance disk for the archive log and archive failover logs. For availability, isolate these logs from the database and active log.	Use medium-performance or high-performance disk for storage pools in the following circumstances: <ul style="list-style-type: none"> <li>Data is frequently read.</li> <li>Data is frequently written.</li> </ul> For performance and availability, isolate storage pool data from the server database and logs, and from data for other applications.

Storage technology type	Database	Active log	Archive log and archive failover log	Storage pools
<b>SATA, network-attached storage</b>	Do not use this storage for the database. Do not place the database on XIV storage systems.	Do not use this storage for the active log.	Use of this slower storage technology is acceptable because these logs are written once and infrequently read.	Use this slower storage technology in the following circumstances: <ul style="list-style-type: none"> <li>• Data is infrequently written, for example written once.</li> <li>• Data is infrequently read.</li> </ul>
<b>Tape and virtual tape</b>				Use for long-term retention or if data is infrequently used.

## AIX: Applying best practices to the server installation

Typically, hardware configuration and selection have the most significant effect on the performance of an IBM Spectrum Protect™ solution. Other factors that affect performance are the operating system selection and configuration, and the configuration of IBM Spectrum Protect.

### Procedure

- The following best practices are the most important for optimal performance and problem prevention.
- Review the table to determine the best practices that apply to your environment.

Best practice	More information
Use fast disks for the server database. Enterprise-grade solid-state disks (SSD), with Fibre Channel or SAS interface, offer the best performance.	Use fast, low-latency disks for the database. Using SSD is essential if you are using data deduplication and node replication. Avoid Serial Advanced Technology Attachment (SATA) and Parallel Advanced Technology Attachment (PATA) disks. For details and more tips, see the following topics: <ul style="list-style-type: none"> <li>◦ "Planning for server database disks"</li> <li>◦ "Planning for the correct type of storage technology"</li> </ul>
Ensure that the server system has enough memory.	Review operating system requirements in technote 1243309. Heavier workloads require more than the minimum requirements. Advanced features such as data deduplication and node replication can require more than the minimum memory that is specified in the system requirements document.  If you plan to run multiple instances, each instance requires the memory that is listed for one server. Multiply the memory for one server by the number of instances that are planned for the system.

Best practice	More information
Separate the server database, the active log, the archive log, and disk storage pools from each other.	<p>Keep all IBM Spectrum Protect storage resources on separate disks. Keep storage pool disks separate from the disks for the server database and logs. Storage pool operations can interfere with database operations when both are on the same disks. Ideally, the server database and logs are also separated from each other. For details and more tips, see the following topics:</p> <ul style="list-style-type: none"> <li>○ "Planning for server database disks"</li> <li>○ "Planning for server recovery log disks"</li> <li>○ "Planning for storage pools in DISK or FILE device classes"</li> </ul>
Use at least four directories for the server database. For larger servers or servers that use advanced features, use eight directories.	<p>Place each directory on a LUN that is isolated from other LUNs and from other applications.</p> <p>A server is considered to be large if its database is larger than 2 TB or is expected to grow to that size. Use eight directories for such servers.</p> <p>See "Planning for server database disks".</p>
If you are using data deduplication, node replication, or both, follow the guidelines for database configuration and other items.	<p>Configure the server database according to the guidelines, because the database is extremely important to how well the server runs when these features are being used. For details and more tips, see the following topics:</p> <ul style="list-style-type: none"> <li>○ Checklist for data deduplication</li> <li>○ Checklist for node replication</li> </ul>
For storage pools that use FILE type device classes, follow the guidelines for the size of storage pool volumes. Typically, 50 GB volumes are best.	<p>Review the information in Optimal number and size of volumes for storage pools that use disk to help you to determine volume size.</p> <p>Configure storage pool devices and file systems based on throughput requirements, not only on capacity requirements.</p> <p>Isolate the storage devices that are used by IBM Spectrum Protect from other applications that have high I/O, and ensure that there is enough throughput to that storage.</p> <p>For more details, see Checklist for storage pools on DISK or FILE.</p>
Schedule IBM Spectrum Protect client operations and server maintenance activities to avoid or minimize overlap of operations.	<p>For more details, see the following topics:</p> <ul style="list-style-type: none"> <li>○ Tuning the schedule for daily operations</li> <li>○ Checklist for server configuration</li> </ul>
Monitor operations constantly.	<p>By monitoring, you can find problems early and more easily identify causes. Keep records of monitoring reports for up to a year to help you identify trends and plan for growth. See Monitoring and maintaining the environment for performance.</p>

## AIX: Minimum system requirements for AIX systems

Before you install an IBM Spectrum Protect™ server on an AIX operating system on a system without data deduplication, review the hardware and software requirements.

### Hardware and software requirements for the IBM Spectrum Protect server installation

These tables list the minimum hardware and software requirements for the installation of an IBM Spectrum Protect server. Use these requirements as a starting point for systems without data deduplication. The optimal IBM Spectrum Protect environment is set up with data deduplication by using the IBM Spectrum Protect Blueprints. For the most current information about system requirements, see technote 1243309.

## Hardware requirements

Table 1 describes the minimum hardware requirements for the server. If the server does not meet the minimum requirements, the installation fails. For more details about planning disk space, see AIX: Capacity planning.

Table 1. Hardware requirements

Type of hardware	Hardware requirements
Hardware	An appropriately configured POWER5 or later systems computer (64-bit)
Disk space	<p>The following minimum values for disk space:</p> <ul style="list-style-type: none"><li>• 5 GB for the installation directory</li><li>• 512 MB for the /var directory</li><li>• 2 GB for the /tmp directory</li><li>• 128 MB in the home directory for the root user.</li><li>• 2 GB for the shared resources area</li></ul> <p>In case a problem arises and any diagnosis is needed, it is optimal to have temporary or other space available on the system for a first failure data capture (FFDC) log or for other temporary uses such as for collecting trace logs.</p> <p>Significant additional disk space is required for database and log files. The size of the database depends on the number of client files to be stored and the method by which the server manages them. The default active log space is 16 GB, the minimum that is needed for most workloads and configurations. When you create the active log, you need at least 64 GB to run replication. If replication and data deduplication are both being used, create an active log of 128 GB. Allocate at least three times the default active log space for the archive log (48 GB). Ensure that you have sufficient resources if you are using data deduplication or expect a heavy client workload.</p> <p>For optimal performance and to facilitate I/O, specify at least two equally sized containers or Logical Unit Numbers (LUNs) for the database. In addition, each active log and archive log needs its own container or LUN.</p> <p>Ensure that you see AIX: Capacity planning for more details about disk space.</p>
Memory	<p>The following are the minimum system memory requirements for servers with databases up to 500 GB, with daily ingestion of no more than 200 GB per day:</p> <ul style="list-style-type: none"><li>• 16 GB for standard server operations without data deduplication and node replication</li><li>• 24 GB for data deduplication or node replication</li><li>• 32 GB for node replication with data deduplication</li></ul> <p>For more specific memory requirements for larger databases and higher ingestion capability, see the IBM Spectrum Protect server memory tuning table.</p> <p>For more specific memory requirements when you are using data deduplication, see the IBM Spectrum Protect Blueprint for your operating system.</p>

## Software requirements

Table 2 describes the minimum software requirements that are needed for a server on an AIX® system.

Table 2. Software requirements

Type of software	Minimum software requirements
------------------	-------------------------------

Type of software	Minimum software requirements
Operating system	<p>AIX 6.1 running in a 64-bit kernel environment with the following additional requirements:</p> <ul style="list-style-type: none"> <li>• AIX 6.1 TL 7 and SP6.</li> <li>• Minimum C++ runtime level with the xIC.rte 12.1.0.1 or later file sets. The file set is automatically upgraded if the level is earlier than 12.1.0.1. The file set is included in the June 2008 fix pack package for IBM® C++ Runtime Environment Components for AIX.</li> </ul> <p>AIX 7.1 running in a 64-bit kernel environment.</p> <ul style="list-style-type: none"> <li>• AIX 7.1 TL 4 and SP2.</li> <li>• Minimum C++ runtime level with the xIC.rte 12.1.0.1 or later file sets. The file set is automatically upgraded if the level is earlier than 12.1.0.1. The file set is included in the June 2008 fix pack package for IBM C++ Runtime Environment Components for AIX.</li> </ul> <p>AIX 7.2 running in a 64-bit kernel environment.</p> <ul style="list-style-type: none"> <li>• AIX 7.2 TL 0 and SP2.</li> <li>• Minimum C++ runtime level with the xIC.rte 13.1.3.1 or later file sets. The file set is automatically upgraded if the level is earlier than 13.1.3.1.</li> </ul> <p>For the latest recommendations about AIX maintenance levels, see technote 21165448</p> <p>To use the N_Port ID Virtualization (NPIV) facility, ensure that you have the following minimum requirements:</p> <ul style="list-style-type: none"> <li>• Virtual I/O Server 2.1.2 or later</li> <li>• AIX 7.1 or later</li> <li>• An HBA adapter supported by the corresponding AIX and Virtual I/O Server</li> </ul>
Communication protocol	A configured communication method.
Processing	Asynchronous I/O must be enabled.
Device drivers	<p>The IBM Spectrum Protect device driver is required for non-IBM drives and tape libraries. The IBM Spectrum Protect device driver package contains device driver tools and ACSLS daemons.</p> <p>For the IBM 3590, 3592, or the Ultrium tape library or drives, the IBM device drivers are required. Install the most current device drivers. You can locate IBM driver packages at Fix Central.</p> <p>Configure the device drivers before you use the server with tape devices.</p>
Gunzip utility	The gunzip utility must be available on your system before you install or upgrade the server. Ensure that the gunzip utility is installed and the path to it is set in the PATH environment variable.
Other software	<p>Korn Shell (ksh) is required. Configure the I/O completion ports (IOCP) on the operating system.</p> <p>To authenticate IBM Spectrum Protect users with a Lightweight Directory Access Protocol (LDAP) server, you must use one of the following directory servers:</p> <ul style="list-style-type: none"> <li>• Microsoft Active Directory (Windows Server 2012, Windows Server 2012 R2)</li> <li>• IBM Security Directory Server V6.3</li> <li>• IBM Security Directory Server V6.4</li> </ul>

AIX

## AIX: Compatibility of the IBM Spectrum Protect server with other DB2 products on the system

You can install other products that deploy and use DB2® products on the same system as the IBM Spectrum Protect™ Version 8.1.2 server, with some limitations.

To install and use other products that use a DB2 product on the same system as the IBM Spectrum Protect server, ensure that the following criteria are met:

Table 1. Compatibility of the IBM Spectrum Protect server with other DB2 products on the system

Criterion	Instructions
Version level	The other products that use a DB2 product must use DB2 version 9 or later. DB2 products include product encapsulation and segregation support beginning with Version 9. Starting with this version, you can run multiple copies of DB2 products, at different code levels, on the same system. For details, see the information about multiple DB2 copies in the DB2 product information.
User IDs and directories	Ensure that the user IDs, fence user IDs, installation location, other directories, and related information are not shared across DB2 installations. Your specifications must be different from the IDs and locations that you used for the IBM Spectrum Protect server installation and configuration. If you used the dsmicfgx wizard to configure the server, these are values that you entered when running the wizard. If you used the manual configuration method, review the procedures that you used if necessary to recall the values that were used for the server.
Resource allocation	<p>Consider the resources and capability of the system compared to the requirements for both the IBM Spectrum Protect server and the other applications that use the DB2 product. To provide sufficient resources for the other DB2 applications, you might have to change the IBM Spectrum Protect server settings so that the server uses less system memory and resources. Similarly, if the workloads for the other DB2 applications compete with the IBM Spectrum Protect server for processor or memory resources, the performance of the server in handling the expected client workload or other server operations might be adversely affected.</p> <p>To segregate resources and provide more capability for the tuning and allocation of processor, memory, and other system resources for multiple applications, consider using logical partition (LPAR), workload partition (WPAR), or other virtual workstation support. For example, run a DB2 application on its own virtualized system.</p>

## AIX: IBM Installation Manager

IBM Spectrum Protect™ uses IBM® Installation Manager, which is an installation program that can use remote or local software repositories to install or update many IBM products.

If the required version of IBM Installation Manager is not already installed, it is automatically installed or upgraded when you install IBM Spectrum Protect. It must remain installed on the system so that IBM Spectrum Protect can be updated or uninstalled later as needed.

The following list contains explanations of some terms that are used in IBM Installation Manager:

### Offering

An installable unit of a software product.

The IBM Spectrum Protect offering contains all of the media that IBM Installation Manager requires to install IBM Spectrum Protect.

### Package

The group of software components that are required to install an offering.

The IBM Spectrum Protect package contains the following components:

- IBM Installation Manager installation program
- IBM Spectrum Protect offering

### Package group

A set of packages that share a common parent directory.

The default package group for the IBM Spectrum Protect package is `IBM Installation Manager`.

### Repository

A remote or local storage area for data and other application resources.

The IBM Spectrum Protect package is stored in a repository on IBM Fix Central.



## Shared resources directory

A directory that contains software files or plug-ins that are shared by packages.

IBM Installation Manager stores installation-related files in the shared resources directory, including files that are used for rolling back to a previous version of IBM Spectrum Protect.

## AIX: Worksheets for planning details for the server

You can use the worksheets to help you plan the amount and location of storage needed for the IBM Spectrum Protect™ server. You can also use them to keep track of names and user IDs.

Item	Space required	Number of directories	Location of directories
The database			
Active log			
Archive log			
Optional: Log mirror for the active log			
Optional: Secondary archive log (failover location for archive log)			

Item	Names and user IDs	Location
The <i>instance user ID</i> for the server, which is the ID you use to start and run the IBM Spectrum Protect server		
The <i>home directory</i> for the server, which is the directory that contains the instance user ID		
The database instance name		
The <i>instance directory</i> for the server, which is a directory that contains files specifically for this server instance (the server options file and other server-specific files)		
The server name, use a unique name for each server		

## AIX: Capacity planning

Capacity planning for IBM Spectrum Protect™ includes managing resources such as the database, the recovery log and the shared resource area. To maximize resources as part of capacity planning, you must estimate space requirements for the database and the recovery log. The shared resource area must have enough space available for each installation or upgrade.

- AIX: Estimating space requirements for the database  
To estimate space requirements for the database, you can use the maximum number of files that can be in server storage at one time or you can use storage pool capacity.
- AIX: Recovery log space requirements  
In IBM Spectrum Protect, the term *recovery log* comprises the active log, the archive log, the active log mirror, and the archive failover log. The amount of space that you require for the recovery log depends on various factors, including, for example, the amount of client activity with the server.
- AIX: Monitoring space utilization for the database and recovery logs  
To determine the amount of used and available active log space, you issue the QUERY LOG command. To monitor space utilization in the database and recovery logs, you can also check the activity log for messages.

- **AIX: Deleting installation rollback files**  
You can delete certain installation files that were saved during the installation process to free space in the shared resource directory. For example, files that might have been required for a rollback operation are types of files that you can delete.

## AIX: Estimating space requirements for the database

---

To estimate space requirements for the database, you can use the maximum number of files that can be in server storage at one time or you can use storage pool capacity.

### About this task

---

Consider using at least 25 GB for the initial database space. Provision file system space appropriately. A database size of 25 GB is adequate for a test environment or a library-manager-only environment. For a production server supporting client workloads, the database size is expected to be larger. If you use random-access disk (DISK) storage pools, more database and log storage space is needed than for sequential-access storage pools.

The maximum size of the IBM Spectrum Protect™ database is 6 TB.

For information about sizing the database in a production environment that is based on the number of files and on storage pool size, see the following topics.

- **AIX: Estimating database space requirements based on the number of files**  
If you can estimate the maximum number of files that might be in server storage at a time, you can use that number to estimate space requirements for the database.
- **AIX: Estimating database space requirements based on storage pool capacity**  
To estimate database space requirements based on storage pool capacity, use a ratio of 1 - 5%. For example, if you require 200 TB of storage pool capacity, the size of your database is expected to be 2 - 10 TB. As a general rule, make your database as large as possible to prevent running out of space. If you run out of database space, server operations and client-store operations can fail.
- **AIX: The database manager and temporary space**  
The IBM Spectrum Protect server database manager manages and allocates system memory and disk space for the database. The amount of database space you require depends on the amount of system memory available and the server workload.

## AIX: Estimating database space requirements based on the number of files

---

If you can estimate the maximum number of files that might be in server storage at a time, you can use that number to estimate space requirements for the database.

### About this task

---

To estimate space requirements that is based on the maximum number of files in server storage, use the following guidelines:

- 600 - 1000 bytes for each stored version of a file, including image backups.  
Restriction: The guideline does not include space that is used during data deduplication.
- 100 - 200 bytes for each cached file, copy storage pool file, active-data pool file, and deduplicated file.
- Additional space is required for database optimization to support varying data-access patterns and to support server back-end processing of the data. The amount of extra space is equal to 50% of the estimate for the total number of bytes for file objects.

In the following example for a single client, the calculations are based on the maximum values in the preceding guidelines. The examples do not take into account that you might use file aggregation. In general, when you aggregate small files, it reduces the amount of required database space. File aggregation does not affect space-managed files.

### Procedure

---

1. Calculate the number of file versions. Add each of the following values to obtain the number of file versions:
  - a. Calculate the number of backed-up files. For example, as many as 500,000 client files might be backed up at a time. In this example, storage policies are set to keep up to three copies of backed up files:

$$500,000 \text{ files} * 3 \text{ copies} = 1,500,000 \text{ files}$$

- b. Calculate the number of archive files. For example, as many as 100,000 client files might be archived copies.
- c. Calculate the number of space-managed files. For example, as many as 200,000 client files might be migrated from client workstations.

Using 1000 bytes per file, the total amount of database space that is required for the files that belong to the client is 1.8 GB:

$$(1,500,000 + 100,000 + 200,000) * 1000 = 1.8 \text{ GB}$$

2. Calculate the number of cached files, copy storage-pool files, active-data pool files, and deduplicated files:
  - a. Calculate the number of cached copies. For example, caching is enabled in a 5 GB disk storage pool. The high migration threshold of the pool is 90% and the low migration threshold of the pool is 70%. Thus, 20% of the disk pool, or 1 GB, is occupied by cached files.

If the average file size is about 10 KB, approximately 100,000 files are in cache at any one time:

$$100,000 \text{ files} * 200 \text{ bytes} = 19 \text{ MB}$$

- b. Calculate the number of copy storage-pool files. All primary storage pools are backed up to the copy storage pool:

$$(1,500,000 + 100,000 + 200,000) * 200 \text{ bytes} = 343 \text{ MB}$$

- c. Calculate the number of active storage-pool files. All the active client-backup data in primary storage pools is copied to the active-data storage pool. Assume that 500,000 versions of the 1,500,000 backup files in the primary storage pool are active:

$$500,000 * 200 \text{ bytes} = 95 \text{ MB}$$

- d. Calculate the number of deduplicated files. Assume that a deduplicated storage pool contains 50,000 files:

$$50,000 * 200 \text{ bytes} = 10 \text{ MB}$$

Based on the preceding calculations, about 0.5 GB of extra database space is required for the client's cached files, copy storage-pool files, active-data pool files, and deduplicated files.

3. Calculate the amount of extra space that is required for database optimization. To provide optimal data access and management by the server, extra database space is required. The amount of extra database space is equal to 50% of the total space requirements for file objects.

$$(1.8 + 0.5) * 50\% = 1.2 \text{ GB}$$

4. Calculate the total amount of database space that is required for the client. The total is approximately 3.5 GB:

$$1.8 + 0.5 + 1.2 = 3.5 \text{ GB}$$

5. Calculate the total amount of database space that is required for all clients. If the client that was used in the preceding calculations is typical and you have 500 clients, for example, you can use the following calculation to estimate the total amount of database space that is required for all clients:

$$500 * 3.5 = 1.7 \text{ TB}$$

## Results

---

Tip: In the preceding examples, the results are estimates. The actual size of the database might differ from the estimate because of factors such as the number of directories and the length of the path and file names. Periodically monitor your database and adjust its size as necessary.

## What to do next

---

During normal operations, the IBM Spectrum Protect™ server might require temporary database space. This space is needed for the following reasons:

- To hold the results of sorting or ordering that are not already being kept and optimized in the database directly. The results are temporarily held in the database for processing.
- To give administrative access to the database through one of the following methods:
  - A DB2® open database connectivity (ODBC) client
  - An Oracle Java™ database connectivity (JDBC) client
  - Structured Query Language (SQL) to the server from an administrative-client command line

Consider using an extra 50 GB of temporary space for every 500 GB of space for file objects and optimization. See the guidelines in the following table. In the example that is used in the preceding step, a total of 1.7 TB of database space is required for file objects and optimization for 500 clients. Based on that calculation, 200 GB is required for temporary space. The total amount of required database space is 1.9 TB.

Database size	Minimum temporary-space requirement
< 500 GB	50 GB
≥ 500 GB and < 1 TB	100 GB
≥ 1 TB and < 1.5 TB	150 GB
≥ 1.5 and < 2 TB	200 GB
≥ 2 and < 3 TB	250 - 300 GB
≥ 3 and < 4 TB	350 - 400 GB

## AIX: Estimating database space requirements based on storage pool capacity

To estimate database space requirements based on storage pool capacity, use a ratio of 1 - 5%. For example, if you require 200 TB of storage pool capacity, the size of your database is expected to be 2 - 10 TB. As a general rule, make your database as large as possible to prevent running out of space. If you run out of database space, server operations and client-store operations can fail.

## AIX: The database manager and temporary space

The IBM Spectrum Protect™ server database manager manages and allocates system memory and disk space for the database. The amount of database space you require depends on the amount of system memory available and the server workload.

The database manager sorts data in a specific sequence, according to the SQL statement that you issue to request the data. Depending on the workload on the server, and if there is more data than the database manager can manage, the data (that is ordered in sequence) is allocated to temporary disk space. Data is allocated to temporary disk space when there is a large result set. The database manager dynamically manages the memory that is used when data is allocated to temporary disk space.

For example, expiration processing can produce a large result set. If there is not enough system memory on the database to store the result set, some of the data is allocated to temporary disk space. During expiration processing, if a node or file space are selected that are too large to process, the database manager cannot sort the data in memory. The database manager must use temporary space to sort data.

To run database operations, consider adding more database space for the following scenarios:

- The database has a small amount of space and the server operation that requires temporary space uses the remaining free space.
- The file spaces are large, or the file spaces have an assigned policy that creates many file versions.
- The IBM Spectrum Protect server must run with limited memory. The database uses the IBM Spectrum Protect server main memory to run database operations. However, if there is insufficient memory available, the IBM Spectrum Protect server allocates temporary space on disk to the database. For example, if 10G of memory is available and database operations require 12G of memory, the database uses temporary space.
- An `out of database space` error is displayed when you deploy an IBM Spectrum Protect server. Monitor the server activity log for messages that are related to database space.

Important: Do not change the DB2 software that is installed with the IBM Spectrum Protect installation packages and fix packs. Do not install or upgrade to a different version, release, or fix pack, of DB2 software to avoid damage to the database.

## AIX: Recovery log space requirements

In IBM Spectrum Protect™, the term *recovery log* comprises the active log, the archive log, the active log mirror, and the archive failover log. The amount of space that you require for the recovery log depends on various factors, including, for example, the amount of client activity with the server.

- **AIX: Active and archive log space**  
When you estimate space requirements for active and archive logs, include some extra space for contingencies such as occasional heavy workloads and failovers.
- **AIX: Active-log mirror space**  
The active log can be mirrored so that the mirrored copy can be used if the active log files cannot be read. There can be only one active log mirror.
- **AIX: Archive-failover log space**  
The archive failover log is used by the server if the archive log directory runs out of space.

## AIX: Active and archive log space

---

When you estimate space requirements for active and archive logs, include some extra space for contingencies such as occasional heavy workloads and failovers.

In IBM Spectrum Protect™ servers V7.1 and later, the active log can be a maximum size of 512 GB. The archive log size is limited to the size of the file system that it is installed on.

Use the following general guidelines when you estimate the size of the active log:

- The suggested starting size for the active log is 16 GB.
- Ensure that the active log is at least large enough for the amount of concurrent activity that the server typically handles. As a precaution, try to anticipate the largest amount of work that the server manages at one time. Provision the active log with extra space that can be used if needed. Consider using 20% of extra space.
- Monitor used and available active log space. Adjust the size of the active log as needed, depending upon factors such as client activity and the level of server operations.
- Ensure that the directory that holds the active log is as large as, or larger than, the size of the active log. A directory that is larger than the active log can accommodate failovers, if they occur.
- Ensure that the file system that contains the active log directory has at least 8 GB of free space for temporary log movement requirements.

The suggested starting size for the archive log is 48 GB.

The archive log directory must be large enough to contain the log files that are generated since the previous full backup. For example, if you perform a full backup of the database every day, the archive log directory must be large enough to hold the log files for all the client activity that occurs during 24 hours. To recover space, the server deletes obsolete archive log files after a full backup of the database. If the archive log directory becomes full and a directory for archive failover logs does not exist, log files remain in the active log directory. This condition can cause the active log directory to fill up and stop the server. When the server restarts, some of the existing active-log space is released.

After the server is installed, you can monitor archive log utilization and the space in the archive log directory. If the space in the archive log directory fills up, it can cause the following problems:

- The server is unable to perform full database backups. Investigate and resolve this problem.
- Other applications write to the archive log directory, exhausting the space that is required by the archive log. Do not share archive log space with other applications including other IBM Spectrum Protect servers. Ensure that each server has a separate storage location that is owned and managed by that specific server.
- **AIX: Example: Estimating active and archive log sizes for basic client-store operations**  
Basic client-store operations include backup, archive, and space management. Log space must be sufficient to handle all store transactions that are in progress at one time.
- **AIX: Example: Estimating active and archive log sizes for clients that use multiple sessions**  
If the client option RESOURCEUTILIZATION is set to a value that is greater than the default, the concurrent workload for the server increases.
- **AIX: Example: Estimating active and archive log sizes for simultaneous write operations**  
If client backup operations use storage pools that are configured for simultaneous write, the amount of log space that is required for each file increases.
- **AIX: Example: Estimating active and archive log sizes for basic client store operations and server operations**  
Migration of data in server storage, identification processes for data deduplication, reclamation, and expiration might run concurrently with client store operations. Administrative tasks such as administrative commands or SQL queries from administrative clients can also run concurrently with client store operations. Server operations and administrative tasks that run concurrently can increase the active log space that is required.
- **AIX: Example: Estimating active and archive log sizes under conditions of extreme variation**  
Problems with running out of active log space can occur if you have many transactions that complete quickly and some

transactions that take much longer to complete. A typical case occurs when many workstation or file-server backup sessions are active and a few very large database server-backup sessions are active. If this situation applies to your environment, you might need to increase the size of the active log so that the work completes successfully.

- AIX: Example: Estimating archive log sizes with full database backups  
The IBM Spectrum Protect server deletes unnecessary files from the archive log only when a full database backup occurs. Consequently, when you estimate the space that is required for the archive log, you must also consider the frequency of full database backups.
- AIX: Example: Estimating active and archive log sizes for data deduplication operations  
If you deduplicate data, you must consider its effects on space requirements for active and archive logs.

## AIX: Example: Estimating active and archive log sizes for basic client-store operations

Basic client-store operations include backup, archive, and space management. Log space must be sufficient to handle all store transactions that are in progress at one time.

To determine the sizes of the active and archive logs for basic client-store operations, use the following calculation:

```
number of clients x files stored during each transaction
x log space needed for each file
```

This calculation is used in the example in the following table.

Table 1. Basic client-store operations

Item	Example values	Description
Maximum number of client nodes that back up, archive, or migrate files concurrently at any time	300	The number of client nodes that back up, archive, or migrate files every night.
Files stored during each transaction	4096	The default value of the server option TXNGROUPMAX is 4096.
Log space that is required for each file	3053 bytes	The value of 3053 bytes for each file in a transaction represents the log bytes that are needed when backing up files from a Windows client where the file names are 12 - 120 bytes.  This value is based on the results of tests performed under laboratory conditions. The tests consisted of backup-archive clients performing backup operations to a random-access disk (DISK) storage pool. DISK pools result in more log use than sequential-access storage pools. Consider a value larger than 3053 bytes if the data being stored has file names that are longer than 12 - 120 bytes.
Active log: Suggested size	19.5 GB <sup>1</sup>	Use the following calculation to determine the size of the active log. One GB equals 1,073,741,824 bytes.  (300 clients x 4096 files stored during each transaction x 3053 bytes for each file) ÷ 1,073,741,824 bytes = 3.5 GB  Increase that amount by the suggested starting size of 16 GB:  3.5 + 16 = 19.5 GB
Archive log: Suggested size	58.5 GB <sup>1</sup>	Because of the requirement to be able to store archive logs across three server database-backup cycles, multiply the estimate for the active log by 3 to estimate the total archive log requirement.  3.5 x 3 = 10.5 GB  Increase that amount by the suggested starting size of 48 GB:  10.5 + 48 = 58.5 GB

Item	Example values	Description
<p><sup>1</sup> The example values in this table are used only to illustrate how the sizes for active logs and archive logs are calculated. In a production environment that does not use deduplication, 16 GB is the suggested minimum size for an active log. The suggested minimum size for an archive log in a production environment that does not use deduplication is 48 GB. If you substitute values from your environment and the results are larger than 16 GB and 48 GB, use your results to size the active log and archive log.</p> <p>Monitor your logs and adjust their size if necessary.</p>		

## AIX: Example: Estimating active and archive log sizes for clients that use multiple sessions

If the client option RESOURCEUTILIZATION is set to a value that is greater than the default, the concurrent workload for the server increases.

To determine the sizes of the active and archive logs when clients use multiple sessions, use the following calculation:

$$\text{number of clients} \times \text{sessions for each client} \times \text{files stored during each transaction} \times \text{log space needed for each file}$$

This calculation is used in the example in the following table.

Table 1. Multiple client sessions

Item	Example values		Description
Maximum number of client nodes that back up, archive, or migrate files concurrently at any time	300	1000	The number of client nodes that back up, archive, or migrate files every night.
Possible sessions for each client	3	3	The setting of the client option RESOURCEUTILIZATION is larger than the default. Each client session runs a maximum of three sessions in parallel.
Files stored during each transaction	4096	4096	The default value of the server option TXNGROUPMAX is 4096.
Log space that is required for each file	3053	3053	<p>The value of 3053 bytes for each file in a transaction represents the log bytes needed when backing up files from a Windows client where the file names are 12 - 120 bytes.</p> <p>This value is based on the results of tests performed under laboratory conditions. Tests consisted of clients performing backup operations to a random-access disk (DISK) storage pool. DISK pools result in more log use than sequential-access storage pools. Consider a value larger than 3053 bytes if the data being stored has file names that are longer than 12 - 120 bytes.</p>

Item	Example values		Description
Active log: Suggested size	26.5 GB <sup>1</sup>	51 GB <sup>1</sup>	<p>The following calculation was used for 300 clients. One GB equals 1,073,741,824 bytes.</p> <p>(300 clients x 3 sessions for each client x 4096 files stored during each transaction x 3053 bytes for each file) ÷ 1,073,741,824 = 10.5 GB</p> <p>Increase that amount by the suggested starting size of 16 GB:</p> <p>10.5 + 16 = 26.5 GB</p> <p>The following calculation was used for 1000 clients. One GB equals 1,073,741,824 bytes.</p> <p>(1000 clients x 3 sessions for each client x 4096 files store during each transaction x 3053 bytes for each file) ÷ 1,073,741,824 = 35 GB</p> <p>Increase that amount by the suggested starting size of 16 GB:</p> <p>35 + 16 = 51 GB</p>
Archive log: Suggested size	79.5 GB <sup>1</sup>	153 GB <sup>1</sup>	<p>Because of the requirement to be able to store archive logs across three server-database backup cycles, the estimate for the active log is multiplied by 3:</p> <p>10.5 x 3 = 31.5 GB</p> <p>35 x 3 = 105 GB</p> <p>Increase those amounts by the suggested starting size of 48 GB:</p> <p>31.5 + 48 = 79.5 GB</p> <p>105 + 48 = 153 GB</p>
<p><sup>1</sup> The example values in this table are used only to illustrate how the sizes for active logs and archive logs are calculated. In a production environment that does not use deduplication, 16 GB is the suggested minimum size for an active log. The suggested minimum size for an archive log in a production environment that does not use deduplication is 48 GB. If you substitute values from your environment and the results are larger than 16 GB and 48 GB, use your results to size the active log and archive log.</p> <p>Monitor your active log and adjust its size if necessary.</p>			

## AIX: Example: Estimating active and archive log sizes for simultaneous write operations

If client backup operations use storage pools that are configured for simultaneous write, the amount of log space that is required for each file increases.

The log space that is required for each file increases by about 200 bytes for each copy storage pool that is used for a simultaneous write operation. In the example in the following table, data is stored to two copy storage pools in addition to a primary storage pool. The estimated log size increases by 400 bytes for each file. If you use the suggested value of 3053 bytes of log space for each file, the total number of required bytes is 3453.

This calculation is used in the example in the following table.

Table 1. Simultaneous write operations

Item	Example values	Description
Maximum number of client nodes that back up, archive, or migrate files concurrently at any time	300	The number of client nodes that back up, archive, or migrate files every night.
Files stored during each transaction	4096	The default value of the server option TXNGROUPMAX is 4096.



Item	Example values	Description
Log space that is required for each file	3453 bytes	3053 bytes plus 200 bytes for each copy storage pool.  The value of 3053 bytes for each file in a transaction represents the log bytes that are needed when backing up files from a Windows client where the file names are 12 - 120 bytes.  This value is based on the results of tests performed under laboratory conditions. The tests consisted of backup-archive clients performing backup operations to a random-access disk (DISK) storage pool. DISK pools result in more log use than sequential-access storage pools. Consider a value larger than 3053 bytes if the data being stored has file names that are longer than 12 - 120 bytes.
Active log: Suggested size	20 GB <sup>1</sup>	Use the following calculation to determine the size of the active log. One GB equals 1,073,741,824 bytes.  (300 clients x 4096 files stored during each transaction x 3453 bytes for each file) ÷ 1,073,741,824 bytes = 4.0 GB  Increase that amount by the suggested starting size of 16 GB: 4 + 16 = 20 GB
Archive log: Suggested size	60 GB <sup>1</sup>	Because of the requirement to be able to store archive logs across three server database-backup cycles, multiply the estimate for the active log by 3 to estimate the archive log requirement: 4 GB x 3 = 12 GB  Increase that amount by the suggested starting size of 48 GB: 12 + 48 = 60 GB
<p><sup>1</sup> The example values in this table are used only to illustrate how the sizes for active logs and archive logs are calculated. In a production environment that does not use deduplication, 16 GB is the suggested minimum size for an active log. The suggested minimum size for an archive log in a production environment that does not use deduplication is 48 GB. If you substitute values from your environment and the results are larger than 16 GB and 48 GB, use your results to size the active log and archive log.</p> <p>Monitor your logs and adjust their size if necessary.</p>		

## AIX: Example: Estimating active and archive log sizes for basic client store operations and server operations

Migration of data in server storage, identification processes for data deduplication, reclamation, and expiration might run concurrently with client store operations. Administrative tasks such as administrative commands or SQL queries from administrative clients can also run concurrently with client store operations. Server operations and administrative tasks that run concurrently can increase the active log space that is required.

For example, migration of files from the random-access (DISK) storage pool to a sequential-access disk (FILE) storage pool uses approximately 110 bytes of log space for each file that is migrated. For example, suppose that you have 300 backup-archive clients and each one of them backs up 100,000 files every night. The files are initially stored on DISK and then migrated to a FILE storage pool. To estimate the amount of active log space that is required for the data migration, use the following calculation. The number of clients in the calculation represents the maximum number of client nodes that back up, archive, or migrate files concurrently at any time.

300 clients x 100,000 files for each client x 110 bytes = 3.1 GB

Add this value to the estimate for the size of the active log that calculated for basic client store operations.

## AIX: Example: Estimating active and archive log sizes under conditions of extreme variation

Problems with running out of active log space can occur if you have many transactions that complete quickly and some transactions that take much longer to complete. A typical case occurs when many workstation or file-server backup sessions are active and a few very large database server-backup sessions are active. If this situation applies to your environment, you might need to increase the size of the active log so that the work completes successfully.

## AIX: Example: Estimating archive log sizes with full database backups

The IBM Spectrum Protect™ server deletes unnecessary files from the archive log only when a full database backup occurs. Consequently, when you estimate the space that is required for the archive log, you must also consider the frequency of full database backups.

For example, if a full database backup occurs once a week, the archive log space must be able to contain the information in the archive log for a full week.

The difference in archive log size for daily and full database backups is shown in the example in the following table.

Table 1. Full database backups

Item	Example values	Description
Maximum number of client nodes that back up, archive, or migrate files concurrently at any time	300	The number of client nodes that back up, archive, or migrate files every night.
Files stored during each transaction	4096	The default value of the server option TXNGROUPMAX is 4096.
Log space that is required for each file	3453 bytes	3053 bytes for each file plus 200 bytes for each copy storage pool.  The value of 3053 bytes for each file in a transaction represents the log bytes needed when backing up files from a Windows client where the file names are 12 - 120 bytes.  This value is based on the results of tests performed under laboratory conditions. Tests consisted of clients performing backup operations to a random-access disk (DISK) storage pool. DISK pools result in more log use than sequential-access storage pools. Consider a value larger than 3053 bytes if the data being stored has file names that are longer than 12 - 120 bytes.
Active log: Suggested size	20 GB <sup>1</sup>	Use the following calculation to determine the size of the active log. One GB equals 1,073,741,824 bytes.  (300 clients x 4096 files per transaction x 3453 bytes per file) ÷ 1,073,741,824 bytes = 4.0 GB  Increase that amount by the suggested starting size of 16 GB:  4 + 16 = 20 GB
Archive log: Suggested size with a full database backup every day	60 GB <sup>1</sup>	Because of the requirement to be able to store archive logs across three backup cycles, multiply the estimate for the active log by 3 to estimate the total archive log requirement:  4 GB x 3 = 12 GB  Increase that amount by the suggested starting size of 48 GB:  12 + 48 = 60 GB

Item	Example values	Description
Archive log: Suggested size with a full database every week	132 GB <sup>1</sup>	<p>Because of the requirement to be able to store archive logs across three server database-backup cycles, multiply the estimate for the active log by 3 to estimate the total archive log requirement. Multiply the result by the number of days between full database backups:</p> $(4 \text{ GB} \times 3) \times 7 = 84 \text{ GB}$ <p>Increase that amount by the suggested starting size of 48 GB:</p> $84 + 48 = 132 \text{ GB}$
<p><sup>1</sup> The example values in this table are used only to illustrate how the sizes for active logs and archive logs are calculated. In a production environment that does not use deduplication, 16 GB is the suggested minimum size for an active log. The suggested starting size for an archive log in a production environment that does not use deduplication is 48 GB. If you substitute values from your environment and the results are larger than 16 GB and 48 GB, use your results to size the active log and archive log.</p> <p>Monitor your logs and adjust their size if necessary.</p>		

## AIX: Example: Estimating active and archive log sizes for data deduplication operations

If you deduplicate data, you must consider its effects on space requirements for active and archive logs.

The following factors affect requirements for active and archive log space:

The amount of deduplicated data

The effect of data deduplication on the active log and archive log space depends on the percentage of data that is eligible for deduplication. If the percentage of data that can be deduplicated is relatively high, more log space is required.

The size and number of extents

Approximately 1,500 bytes of active log space are required for each extent that is identified by a duplicate-identification process. For example, if 250,000 extents are identified by a duplicate-identification process, the estimated size of the active log is 358 MB:

$$250,000 \text{ extents identified during each process} \times 1,500 \text{ bytes for each extent} = 358 \text{ MB}$$

Consider the following scenario. Three hundred backup-archive clients back up 100,000 files each night. This activity creates a workload of 30,000,000 files. The average number of extents for each file is two. Therefore, the total number of extents is 60,000,000, and the space requirement for the archive log is 84 GB:

$$60,000,000 \text{ extents} \times 1,500 \text{ bytes for each extent} = 84 \text{ GB}$$

A duplicate-identification process operates on aggregates of files. An aggregate consists of files that are stored in a given transaction, as specified by the TXNGROUPMAX server option. Suppose that the TXNGROUPMAX server option is set to the default of 4096. If the average number of extents for each file is two, the total number of extents in each aggregate is 8192, and the space required for the active log is 12 MB:

$$8192 \text{ extents in each aggregate} \times 1500 \text{ bytes for each extent} = 12 \text{ MB}$$

The timing and number of the duplicate-identification processes

The timing and number of duplicate-identification processes also affects the size of the active log. Using the 12 MB active-log size that was calculated in the preceding example, the concurrent load on the active log is 120 MB if 10 duplicate-identification processes are running in parallel:

$$12 \text{ MB for each process} \times 10 \text{ processes} = 120 \text{ MB}$$

File size

Large files that are processed for duplicate identification can also affect the size of the active log. For example, suppose that a backup-archive client backs up an 80 GB, file-system image. This object can have a high number of duplicate extents if, for example, the files included in the file system image were backed up incrementally. For example, assume that a file

system image has 1.2 million duplicate extents. The 1.2 million extents in this large file represent a single transaction for a duplicate-identification process. The total space in the active log that is required for this single object is 1.7 GB:

$$1,200,000 \text{ extents} \times 1,500 \text{ bytes for each extent} = 1.7 \text{ GB}$$

If other, smaller duplicate-identification processes occur at the same time as the duplicate-identification process for a single large object, the active log might not have enough space. For example, suppose that a storage pool is enabled for deduplication. The storage pool has a mixture of data, including many relatively small files that range from 10 KB to several hundred KB. The storage pool also has few large objects that have a high percentage of duplicate extents.

To take into account not only space requirements but also the timing and duration of concurrent transactions, increase the estimated size of the active log by a factor of two. For example, suppose that your calculations for space requirements are 25 GB (23.3 GB + 1.7 GB for deduplication of a large object). If deduplication processes are running concurrently, the suggested size of the active log is 50 GB. The suggested size of the archive log is 150 GB.

The examples in the following tables show calculations for active and archive logs. The example in the first table uses an average size of 700 KB for extents. The example in the second table uses an average size of 256 KB. As the examples show, the average deduplicate-extent size of 256 KB indicates a larger estimated size for the active log. To minimize or prevent operational problems for the server, use 256 KB to estimate the size of the active log in your production environment.

Table 1. Average duplicate-extent size of 700 KB

Item	Example values		Description
Size of largest single object to deduplicate	800 GB	4 TB	The granularity of processing for deduplication is at the file level. Therefore, the largest single file to deduplicate represents the largest transaction and a correspondingly large load on the active and archive logs.
Average size of extents	700 KB	700 KB	The deduplication algorithms use a variable block method. Not all deduplicated extents for a given file are the same size, so this calculation assumes an average size for extents.
Extents for a given file	1,198,372 bits	6,135,667 bits	Using the average extent size (700 KB), these calculations represent the total number of extents for a given object.  The following calculation was used for an 800 GB object: $(800 \text{ GB} \div 700 \text{ KB}) = 1,198,372 \text{ bits}$  The following calculation was used for a 4 TB object: $(4 \text{ TB} \div 700 \text{ KB}) = 6,135,667 \text{ bits}$
Active log: Suggested size that is required for the deduplication of a single large object during a single duplicate-identification process	1.7 GB	8.6 GB	The estimated active log space that are needed for this transaction.

Item	Example values		Description
Active log: Suggested total size	66 GB <sup>1</sup>	79.8 GB <sup>1</sup>	<p>After considering other aspects of the workload on the server in addition to deduplication, multiply the existing estimate by a factor of two. In these examples, the active log space required to deduplicate a single large object is considered along with previous estimates for the required active log size.</p> <p>The following calculation was used for multiple transactions and an 800 GB object:</p> $(23.3 \text{ GB} + 1.7 \text{ GB}) \times 2 = 50 \text{ GB}$ <p>Increase that amount by the suggested starting size of 16 GB:</p> $50 + 16 = 66 \text{ GB}$ <p>The following calculation was used for multiple transactions and a 4 TB object:</p> $(23.3 \text{ GB} + 8.6 \text{ GB}) \times 2 = 63.8 \text{ GB}$ <p>Increase that amount by the suggested starting size of 16 GB:</p> $63.8 + 16 = 79.8 \text{ GB}$
Archive log: Suggested size	198 GB <sup>1</sup>	239.4 GB <sup>1</sup>	<p>Multiply the estimated size of the active log by a factor of 3.</p> <p>The following calculation was used for multiple transactions and an 800 GB object:</p> $50 \text{ GB} \times 3 = 150 \text{ GB}$ <p>Increase that amount by the suggested starting size of 48 GB:</p> $150 + 48 = 198 \text{ GB}$ <p>The following calculation was used for multiple transactions and a 4 TB object:</p> $63.8 \text{ GB} \times 3 = 191.4 \text{ GB}$ <p>Increase that amount by the suggested starting size of 48 GB:</p> $191.4 + 48 = 239.4 \text{ GB}$
<p><sup>1</sup> The example values in this table are used only to illustrate how the sizes for active logs and archive logs are calculated. In a production environment that uses deduplication, 32 GB is the suggested minimum size for an active log. The suggested minimum size for an archive log in a production environment that uses deduplication is 96 GB. If you substitute values from your environment and the results are larger than 32 GB and 96 GB, use your results to size the active log and archive log.</p> <p>Monitor your logs and adjust their size if necessary.</p>			

Table 2. Average duplicate-extent size of 256 KB

Item	Example values		Description
Size of largest single object to deduplicate	800 GB	4 TB	The granularity of processing for deduplication is at the file level. Therefore, the largest single file to deduplicate represents the largest transaction and a correspondingly large load on the active and archive logs.

Item	Example values		Description
Average size of extents	256 KB	256 KB	The deduplication algorithms use a variable block method. Not all deduplicated extents for a given file are the same size, so this calculation assumes an average extent size.
Extents for a given file	3,276,800 bits	16,777,216 bits	<p>Using the average extent size, these calculations represent the total number of extents for a given object.</p> <p>The following calculation was used for multiple transactions and an 800 GB object:</p> $(800 \text{ GB} \div 256 \text{ KB}) = 3,276,800 \text{ bits}$ <p>The following calculation was used for multiple transactions and a 4 TB object:</p> $(4 \text{ TB} \div 256 \text{ KB}) = 16,777,216 \text{ bits}$
Active log: Suggested size that is required for the deduplication of a single large object during a single duplicate-identification process	4.5 GB	23.4 GB	The estimated size of the active log space that is required for this transaction.
Active log: Suggested total size	71.6 GB <sup>1</sup>	109.4 GB <sup>1</sup>	<p>After considering other aspects of the workload on the server in addition to deduplication, multiply the existing estimate by a factor of 2. In these examples, the active log space required to deduplicate a single large object is considered along with previous estimates for the required active log size.</p> <p>The following calculation was used for multiple transactions and an 800 GB object:</p> $(23.3 \text{ GB} + 4.5 \text{ GB}) \times 2 = 55.6 \text{ GB}$ <p>Increase that amount by the suggested starting size of 16 GB:</p> $55.6 + 16 = 71.6 \text{ GB}$ <p>The following calculation was used for multiple transactions and a 4 TB object:</p> $(23.3 \text{ GB} + 23.4 \text{ GB}) \times 2 = 93.4 \text{ GB}$ <p>Increase that amount by the suggested starting size of 16 GB:</p> $93.4 + 16 = 109.4 \text{ GB}$

Item	Example values		Description
Archive log: Suggested size	214.8 GB <sup>1</sup>	328.2 GB <sup>1</sup>	<p>The estimated size of the active log multiplied by a factor of 3.</p> <p>The following calculation was used for an 800 GB object:</p> $55.6 \text{ GB} \times 3 = 166.8 \text{ GB}$ <p>Increase that amount by the suggested starting size of 48 GB:</p> $166.8 + 48 = 214.8 \text{ GB}$ <p>The following calculation was used for a 4 TB object:</p> $93.4 \text{ GB} \times 3 = 280.2 \text{ GB}$ <p>Increase that amount by the suggested starting size of 48 GB:</p> $280.2 + 48 = 328.2 \text{ GB}$
<p><sup>1</sup> The example values in this table are used only to illustrate how the sizes for active logs and archive logs are calculated. In a production environment that uses deduplication, 32 GB is the suggested minimum size for an active log. The suggested minimum size for an archive log in a production environment that uses deduplication is 96 GB. If you substitute values from your environment and the results are larger than 32 GB and 96 GB, use your results to size the active log and archive log.</p> <p>Monitor your logs and adjust their size if necessary.</p>			

## AIX: Active-log mirror space

The active log can be mirrored so that the mirrored copy can be used if the active log files cannot be read. There can be only one active log mirror.

Creating a log mirror is a suggested option. If you increase the size of the active log, the log mirror size is increased automatically. Mirroring the log can affect performance because of the doubled I/O activity that is required to maintain the mirror. The additional space that the log mirror requires is another factor to consider when deciding whether to create a log mirror.

If the mirror log directory becomes full, the server issues error messages to the activity log and to the db2diag.log. Server activity continues.

## AIX: Archive-failover log space

The archive failover log is used by the server if the archive log directory runs out of space.

Specifying an archive failover log directory can prevent problems that occur if the archive log runs out of space. If both the archive log directory and the drive or file system where the archive failover log directory is located become full, the data remains in the active log directory. This condition can cause the active log to fill up, which causes the server to halt.

## AIX: Monitoring space utilization for the database and recovery logs

To determine the amount of used and available active log space, you issue the QUERY LOG command. To monitor space utilization in the database and recovery logs, you can also check the activity log for messages.

### Active log

If the amount of available active log space is too low, the following messages are displayed in the activity log:

ANR4531I: IC\_AUTOBACKUP\_LOG\_USED\_SINCE\_LAST\_BACKUP\_TRIGGER

This message is displayed when the active log space exceeds the maximum specified size. The IBM Spectrum Protect™ server starts a full database backup.

To change the maximum log size, halt the server. Open the dsmserv.opt file, and specify a new value for the ACTIVELOGSIZE option. When you are finished, restart the server.

**ANR0297I: IC\_BACKUP\_NEEDED\_LOG\_USED\_SINCE\_LAST\_BACKUP**

This message is displayed when the active log space exceeds the maximum specified size. You must back up the database manually.

To change the maximum log size, halt the server. Open the dsmserv.opt file, and specify a new value for the ACTIVELOGSIZE option. When you are finished, restart the server.

**ANR4529I: IC\_AUTOBACKUP\_LOG\_UTILIZATION\_TRIGGER**

The ratio of used active-log space to available active-log space exceeds the log utilization threshold. If at least one full database backup has occurred, the IBM Spectrum Protect server starts an incremental database backup. Otherwise, the server starts a full database backup.

**ANR0295I: IC\_BACKUP\_NEEDED\_LOG\_UTILIZATION**

The ratio of used active-log space to available active-log space exceeds the log utilization threshold. You must back up the database manually.

## Archive log

---

If the amount of available archive log space is too low, the following message is displayed in the activity log:

**ANR0299I: IC\_BACKUP\_NEEDED\_ARCHLOG\_USED**

The ratio of used archive-log space to available archive-log space exceeds the log utilization threshold. The IBM Spectrum Protect server starts a full automatic database backup.

## Database

---

If the amount of space available for database activities is too low, the following messages are displayed in the activity log:

**ANR2992W: IC\_LOG\_FILE\_SYSTEM\_UTILIZATION\_WARNING\_2**

The used database space exceeds the threshold for database space utilization. To increase the space for the database, use the EXTEND DBSPACE command, the EXTEND DBSPACE command, or the DSMSERV FORMAT utility with the DBDIR parameter.

**ANR1546W: FILESYSTEM\_DBPATH\_LESS\_1GB**

The available space in the directory where the server database files are located is less than 1 GB.

When an IBM Spectrum Protect server is created with the DSMSERV FORMAT utility or with the configuration wizard, a server database and recovery log are also created. In addition, files are created to hold database information used by the database manager. The path specified in this message indicates the location of the database information used by the database manager. If space is unavailable in the path, the server can no longer function.

You must add space to the file system or make space available on the file system or disk.

## AIX: Deleting installation rollback files

---

You can delete certain installation files that were saved during the installation process to free space in the shared resource directory. For example, files that might have been required for a rollback operation are types of files that you can delete.

### About this task

---

To delete the files that are no longer needed, use either the installation graphical wizard or the command line in console mode.

- **AIX: Deleting installation rollback files by using a graphical wizard**  
You can delete certain installation files that were saved during installation process by using the IBM® Installation Manager user interface.
- **AIX: Deleting installation rollback files by using the command line**  
You can delete certain installation files that were saved during the installation process by using the command line.

## AIX: Deleting installation rollback files by using a graphical wizard

---



You can delete certain installation files that were saved during installation process by using the IBM® Installation Manager user interface.

## Procedure

---

1. Open IBM Installation Manager.

**AIX** In the directory where IBM Installation Manager is installed, go to the eclipse subdirectory (for example, /opt/IBM/InstallationManager/eclipse), and issue the following command to start IBM Installation Manager:

```
./IBMIM
```

2. Click File > Preferences.
3. Select Files for Rollback.
4. Click Delete Saved Files and click OK.

## AIX: Deleting installation rollback files by using the command line

---

You can delete certain installation files that were saved during the installation process by using the command line.

### Procedure

---

1. In the directory where IBM® Installation Manager is installed, go to the following subdirectory:
  - o **AIX** eclipse/tools

For example:

- o **AIX** /opt/IBM/InstallationManager/eclipse/tools
2. From the tools directory, issue the following command to start an IBM Installation Manager command line:
    - o **AIX** ./imcl -c
  3. Enter **P** to select Preferences.
  4. Enter **B** to select Files for Rollback.
  5. Enter **D** to Delete the Files for Rollback.
  6. Enter **A** to Apply Changes and Return to Preferences Menu.
  7. Enter **C** to leave the Preference Menu.
  8. Enter **X** to Exit Installation Manager.

## AIX: Server naming best practices

---

Use these descriptions as a reference when you install or upgrade an IBM Spectrum Protect™ server.

### Instance user ID

---

The instance user ID is used as the basis for other names related to the server instance. The instance user ID is also called the instance owner.

For example: tsminst1

The instance user ID is the user ID that must have ownership or read/write access authority to all directories that you create for the database and the recovery log. The standard way to run the server is under the instance user ID. That user ID must also have read/write access to the directories that are used for any FILE device classes.

**AIX**

### Home directory for the instance user ID

---

The home directory can be created when creating the instance user ID, by using the option (-m) to create a home directory if it does not exist already. Depending on local settings, the home directory might have the form: /home/instance\_user\_ID

For example: /home/tsminst1

The home directory is primarily used to contain the profile for the user ID and for security settings.

**AIX**

## Database instance name

---

The database instance name must be the same as the instance user ID under which you run the server instance.

For example: tsminst1

**AIX**

## Instance directory

---

The instance directory is a directory that contains files specifically for a server instance (the server options file and other server-specific files). It can have any name that you want. For easier identification, use a name that ties the directory to the instance name.

You can create the instance directory as a subdirectory of the home directory for the instance user ID. For example:  
`/home/instance_user_ID/instance_user_ID`

The following example places the instance directory in the home directory for user ID tsminst1: `/home/tsminst1/tsminst1`

You can also create the directory in another location, for example: `/tsmsserver/tsminst1`

The instance directory stores the following files for the server instance:

- The server options file, `dsmserv.opt`
- The server key database file, `cert.kdb`, and the `.arm` files (used by clients and other servers to import the Secure Sockets Layer certificates of the server)
- Device configuration file, if the `DEVCONFIG` server option does not specify a fully qualified name
- Volume history file, if the `VOLUMEHISTORY` server option does not specify a fully qualified name
- Volumes for `DEVTYPE=FILE` storage pools, if the directory for the device class is not fully specified, or not fully qualified
- User exits
- Trace output (if not fully qualified)

## Database name

---

The database name is always `TSMDB1`, for every server instance. This name cannot be changed.

## Server name

---

The server name is an internal name for IBM Spectrum Protect, and is used for operations that involve communication among multiple IBM Spectrum Protect servers. Examples include server-to-server communication and library sharing.

**AIX** The server name is also used when you add the server to the Operations Center so that it can be managed using that interface. Use a unique name for each server. For easy identification in the Operations Center (or from a `QUERY SERVER` command), use a name that reflects the location or purpose of the server. Do not change the name of an IBM Spectrum Protect server after it is configured as a hub or spoke server.

If you use the wizard, the default name that is suggested is the host name of the system that you are using. You can use a different name that is meaningful in your environment. If you have more than one server on the system and you use the wizard, you can use the default name for only one of the servers. You must enter a unique name for each server.

**AIX** For example:

- `PAYROLL`
- `SALES`

## Directories for database space and recovery log

---

The directories can be named according to local practices. For easier identification, consider using names that tie the directories to the server instance.

For example, for the archive log:

- **AIX** `/tsminst1_archlog`

## AIX: Installation directories

---

Installation directories for the IBM Spectrum Protect™ server include the server, DB2®, device, language, and other directories. Each one contains several additional directories.

The (/opt/tivoli/tsm/server/bin) is the default directory that contains server code and licensing.

The DB2 product that is installed as part of the installation of the IBM Spectrum Protect server has the directory structure as documented in DB2 information sources. Protect these directories and files as you do the server directories. The default directory is /opt/tivoli/tsm/db2.

You can use US English, German, French, Italian, Spanish, Brazilian Portuguese, Korean, Japanese, traditional Chinese, simplified Chinese, Chinese GBK, Chinese Big5, and Russian.

## AIX: Installing the server components

---

To install the Version 8.1.2 server components, you can use the installation wizard, the command line in console mode, or silent mode.

### About this task

---

Using the IBM Spectrum Protect™ installation software, you can install the following components:

- server  
Tip: The database (DB2®), the Global Security Kit (GSKit) and IBM® Java™ Runtime Environment (JRE) are automatically installed when you select the server component.
- server languages
- license
- devices
- IBM Spectrum Protect for SAN
- Operations Center

**AIX** Allow approximately 30 - 45 minutes to install a V8.1.2 server, using this guide.

- AIX: Obtaining the installation package  
You can obtain the IBM Spectrum Protect installation package from an IBM download site such as Passport Advantage® or IBM Fix Central.
- AIX: Installing IBM Spectrum Protect by using the installation wizard  
You can install the server by using the IBM Installation Manager graphical wizard.
- AIX: Installing IBM Spectrum Protect by using console mode  
You can install IBM Spectrum Protect by using the command line in console mode.
- AIX: Installing IBM Spectrum Protect in silent mode  
You can install or upgrade the server in silent mode. In silent mode, the installation does not send messages to a console but instead stores messages and errors in log files.
- AIX: Installing server language packages  
Translations for the server allow the server to display messages and help in languages other than US English. The translations also allow for the use of locale conventions for date, time, and number formatting.

## AIX: Obtaining the installation package

---

You can obtain the IBM Spectrum Protect™ installation package from an IBM® download site such as Passport Advantage® or IBM Fix Central.

**AIX**

### Before you begin

---

If you plan to download the files, set the system user limit for maximum file size to unlimited to ensure that the files can be downloaded correctly:

1. To query the maximum file size value, issue the following command:

```
ulimit -Hf
```

2. If the system user limit for maximum file size is not set to unlimited, change it to unlimited by following the instructions in the documentation for your operating system.

## Procedure

---

1. Download the appropriate package file from one of the following websites.
  - o Download the server package from Passport Advantage or Fix Central.
  - o For the latest information, updates, and maintenance fixes, go to the IBM Support Portal.
2. If you downloaded the package from an IBM download site, complete the following steps:

**AIX**

- a. Verify that you have enough space to store the installation files when they are extracted from the product package. See the download document for the space requirements:
  - IBM Spectrum Protect technote 4042944
  - IBM Spectrum Protect Extended Edition technote 4042945
  - IBM Spectrum Protect for Data Retention technote 4042946
- b. Download the package file to the directory of your choice. The path must contain no more than 128 characters. Be sure to extract the installation files to an empty directory. Do not extract to a directory that contains previously extracted files, or any other files.
- c. Ensure that executable permission is set for the package. If necessary, change the file permissions by issuing the following command:

```
chmod a+x package_name.bin
```

- d. Extract the package by issuing the following command:

```
./package_name.bin
```

where *package\_name* is the name of the downloaded file, for example:

**AIX**

```
8.1.x.000-IBM-SPSRV-AIX.bin
```

3. **AIX** Ensure that the following command is enabled so that the IBM Spectrum Protect wizards work properly:
  - o **AIX** `lsuser`By default, the command is enabled.
4. Select one of the following methods of installing IBM Spectrum Protect:
  - o AIX: Installing IBM Spectrum Protect by using the installation wizard
  - o AIX: Installing IBM Spectrum Protect by using console mode
  - o AIX: Installing IBM Spectrum Protect in silent mode
5. After you install IBM Spectrum Protect, and before you customize it for your use, go to the IBM Support Portal. Click Support and downloads and apply any applicable fixes.

## AIX: Installing IBM Spectrum Protect by using the installation wizard

---

You can install the server by using the IBM® Installation Manager graphical wizard.

### Before you begin

---

Take the following actions before you start the installation:

- **AIX** If the following RPM files are not installed on your system, you must install them. For instructions, see Installing RPM files for the graphical wizard.
  - o `atk-1.12.3-2.aix5.2.ppc.rpm`
  - o `cairo-1.8.8-1.aix5.2.ppc.rpm`
  - o `expat-2.0.1-1.aix5.2.ppc.rpm`
  - o `fontconfig-2.4.2-1.aix5.2.ppc.rpm`
  - o `freetype2-2.3.9-1.aix5.2.ppc.rpm`
  - o `gettext-0.10.40-6.aix5.1.ppc.rpm`
  - o `glib2-2.12.4-2.aix5.2.ppc.rpm`
  - o `gtk2-2.10.6-4.aix5.2.ppc.rpm`
  - o `libjpeg-6b-6.aix5.1.ppc.rpm`

- o libpng-1.2.32-2.aix5.2.ppc.rpm
- o libtiff-3.8.2-1.aix5.2.ppc.rpm
- o pango-1.14.5-4.aix5.2.ppc.rpm
- o pixman-0.12.0-3.aix5.2.ppc.rpm
- o xcursor-1.1.7-3.aix5.2.ppc.rpm
- o xft-2.1.6-5.aix5.1.ppc.rpm
- o xrender-0.9.1-3.aix5.2.ppc.rpm
- o zlib-1.2.3-3.aix5.1.ppc.rpm
- Verify that the operating system is set to the language that you require. By default, the language of the operating system is the language of the installation wizard.

## Procedure

Install IBM Spectrum Protect™ by using this method:

Option	Description
<b>Installing the software from a downloaded package:</b>	a. Change to the directory where you downloaded the package. b. Start the installation wizard by issuing the following command: <div style="background-color: #800040; color: white; padding: 2px; display: inline-block; margin: 5px 0;">AIX</div> <code>./install.sh</code>

## What to do next

- If errors occur during the installation process, the errors are recorded in log files that are stored in the IBM Installation Manager logs directory.  
  
You can view installation log files by clicking File > View Log from the Installation Manager tool. To collect these log files, click Help > Export Data for Problem Analysis from the Installation Manager tool.
- After you install the server and components, and before you customize it for your use, go to the IBM Support Portal. Click Downloads (fixes and PTFs) and apply any applicable fixes.
- AIX

 After you install a new server, review Taking the first steps after you install IBM Spectrum Protect to learn about configuring your server.
- AIX

**AIX: Installing prerequisite RPM files for the graphical wizard**  
Before you can use the graphical wizard of IBM Installation Manager to install IBM Spectrum Protect, you must ensure that the necessary RPM files are installed.

## AIX: Installing IBM Spectrum Protect by using console mode

You can install IBM Spectrum Protect™ by using the command line in console mode.

### Before you begin

Take the following actions before you start the installation:

- Verify that the operating system is set to the language that you require. By default, the language of the operating system is the language of the installation wizard.

## Procedure

Install IBM Spectrum Protect by using this method:

Option	Description
--------	-------------

Option	Description
Installing the software from a downloaded package:	<p>a. Change to the directory where you downloaded the package.</p> <p>b. Start the installation wizard in console mode by issuing the following command: <code>AIX</code></p> <pre>./install.sh -c</pre> <p>Optional: Generate a response file as part of a console mode installation. Complete the console mode installation options, and in the Summary panel, specify <code>G</code> to generate the responses.</p>

## What to do next

- If errors occur during the installation process, the errors are recorded in log files that are stored in the IBM® Installation Manager logs directory, for example:
  - `AIX` /var/ibm/InstallationManager/logs
- After you install the server and components, and before you customize it for your use, go to the IBM Support Portal. Click Downloads (fixes and PTFs) and apply any applicable fixes.
- `AIX` After you install a new server, review Taking the first steps after you install IBM Spectrum Protect to learn about configuring your server.

## AIX: Installing IBM Spectrum Protect in silent mode

You can install or upgrade the server in silent mode. In silent mode, the installation does not send messages to a console but instead stores messages and errors in log files.

### Before you begin

To provide data input when you use the silent installation method, you can use a response file. The following sample response files are provided in the input directory where the installation package is extracted:

install\_response\_sample.xml

Use this file to install the IBM Spectrum Protect™ components.

update\_response\_sample.xml

Use this file to upgrade the IBM Spectrum Protect components.

These files contain default values that can help you avoid any unnecessary warnings. To use these files, follow the instructions that are provided in the files.

If you want to customize a response file, you can modify the options that are in the file. For information about response files, see Response files.

### Procedure

1. Create a response file. You can modify the sample response file or create your own file.
2. If you install the server and Operations Center in silent mode, create a password for the Operations Center truststore in the response file.

If you are using the install\_response\_sample.xml file, add the password in the following line of the file, where *mypassword* represents the password:

```
<variable name='ssl.password' value='mypassword' />
```

For more information about this password, see Installation checklist

Tip: To upgrade the Operations Center, the truststore password is not required if you are using the update\_response\_sample.xml file.

3. Start the silent installation by issuing the following command from the directory where the installation package is extracted. The value *response\_file* represents the response file path and file name:

◦ `AIX`

```
./install.sh -s -input response_file -acceptLicense
```

## What to do next

- If errors occur during the installation process, the errors are recorded in log files that are stored in the IBM® Installation Manager logs directory, for example:
  - **AIX** /var/ibm/InstallationManager/logs
- After you install the server and components, and before you customize it for your use, go to the IBM Support Portal. Click Downloads (fixes and PTFs) and apply any applicable fixes.
- **AIX** After you install a new server, review Taking the first steps after you install IBM Spectrum Protect to learn about configuring your server.

**AIX**

## AIX: Installing server language packages

Translations for the server allow the server to display messages and help in languages other than US English. The translations also allow for the use of locale conventions for date, time, and number formatting.

### Before you begin

For instructions on installing storage agent language packages, see Language pack configuration for storage agents.

- **AIX: Server language locales**  
Use either the default language package option or select another language package to display server messages and help.
- **AIX: Configuring a language package**  
After you configure a language package, messages and help are shown on the server in languages other than US English. Installation packages are provided with IBM Spectrum Protect™.
- **AIX: Updating a language package**  
You can modify or update a language package by using the IBM® Installation Manager.

## AIX: Server language locales

Use either the default language package option or select another language package to display server messages and help.

**AIX** This language package is automatically installed for the following default language option for IBM Spectrum Protect™ server messages and help:

- **AIX** LANGUAGE en\_US

For languages or locales other than the default, install the language package that your installation requires.

You can use the languages that are shown:

**AIX**

Table 1. Server languages for AIX®

Language	LANGUAGE option value
Chinese, Simplified	zh_CN
Chinese, Simplified (UTF-8)	ZH_CN
Chinese, Traditional (Big5)	Zh_TW
Chinese, Traditional (UTF-8)	ZH_TW
Chinese, Traditional (euc_tw)	zh_TW
English	en_US
English (UTF-8)	EN_US
French	fr_FR
French (UTF-8)	FR_FR
German	de_DE
German (UTF-8)	DE_DE
Italian	it_IT
Italian (UTF-8)	IT_IT

Language	LANGUAGE option value
Japanese, EUC	ja_JP
Japanese, PC	Ja_JP
Japanese, UTF8	JA_JP
Korean	ko_KR
Korean (UTF-8)	KO_KR
Portuguese, Brazilian	pt_BR
Portuguese, Brazilian (UTF-8)	PT_BR
Russian	ru_RU
Russian (UTF-8)	RU_RU
Spanish	es_ES
Spanish (UTF-8)	ES_ES

**AIX** Restriction: For Operations Center users, some characters might not be displayed properly if the web browser does not use the same language as the server. If this problem occurs, set the browser to use the same language as the server.

## AIX: Configuring a language package

---

After you configure a language package, messages and help are shown on the server in languages other than US English. Installation packages are provided with IBM Spectrum Protect™.

### About this task

---

**AIX** To set support for a certain locale, complete one of the following tasks:

- Set the LANGUAGE option in the server options file to the name of the locale that you want to use. For example:
  - **AIX** To use the `it_IT` locale, set the LANGUAGE option to `it_IT`. See AIX: Server language locales.
- **AIX** If you are starting the server in the foreground, set the `LC_ALL` environment variable to match the value that is set in the server options file. For example, to set the environment variable for Italian, enter the following value:

```
export LC_ALL=it_IT
```

If the locale is successfully initialized, it formats the date, time, and number for the server. If the locale is not successfully initialized, the server uses the US English message files and the date, time, and number format.

## AIX: Updating a language package

---

You can modify or update a language package by using the IBM® Installation Manager.

### About this task

---

You can install another language package within the same IBM Spectrum Protect™ instance.

- Use the Modify function of IBM Installation Manager to install another language package.
- Use the Update function of IBM Installation Manager to update to newer versions of the language packages.

Tip: In IBM Installation Manager, the term *update* means to discover and install updates and fixes to installed software packages. In this context, *update* and *upgrade* are synonymous.

## AIX: Taking the first steps after you install IBM Spectrum Protect

---

After you install Version 8.1.2, prepare for the configuration. Using the configuration wizard is the preferred method of configuring the IBM Spectrum Protect™ instance.

### About this task

---



1. Create the directories and user ID for the server instance. See [AIX: Creating the user ID and directories for the server instance](#).
2. Configure a server instance. Select one of the following options:
  - o Use the configuration wizard, the preferred method. See [AIX: Configuring IBM Spectrum Protect by using the configuration wizard](#).
  - o Manually configure the new instance. See [AIX: Configuring the server instance manually](#). Complete the following steps during a manual configuration.
    - a. Set up your directories and create the IBM Spectrum Protect instance. See [AIX: Creating the server instance](#).
    - b. Create a new server options file by copying the sample file to set up communications between the server and clients. See [AIX: Configuring server and client communications](#).
    - c. Issue the DSMSEV FORMAT command to format the database. See [AIX: Formatting the database and log](#).
    - d. Configure your system for database backup. See [AIX: Preparing the database manager for database backup](#).
3. Configure options to control when database reorganization runs. See [AIX: Configuring server options for server database maintenance](#).
4. Start the server instance if it is not already started.
  - o [AIX](#) See [AIX: Starting the server instance](#).
5. Register your license. See [AIX: Registering licenses](#).
6. Prepare your system for database backups. See [AIX: Specifying a device class in preparation for database backups](#).
7. Monitor the server. See [AIX: Monitoring the server](#).

- [AIX: Creating the user ID and directories for the server instance](#)  
Create the user ID for the IBM Spectrum Protect server instance and create the directories that the server instance needs for database and recovery logs.
- [AIX: Configuring the IBM Spectrum Protect server](#)  
After you have installed the server and prepared for the configuration, configure the server instance.
- [AIX: Configuring server options for server database maintenance](#)  
To help avoid problems with database growth and server performance, the server automatically monitors its database tables and reorganizes them when needed. Before starting the server for production use, set server options to control when reorganization runs. If you plan to use data deduplication, ensure that the option to run index reorganization is enabled.
- [AIX](#) [AIX: Starting the server instance](#)  
You can start the server by using the instance user ID, which is the preferred method, or the root user ID.
- [AIX: Stopping the server](#)  
You can stop the server when needed to return control to the operating system. To avoid losing administrative and client node connections, stop the server only after current sessions are completed or canceled.
- [AIX: Registering licenses](#)  
Immediately register any IBM Spectrum Protect licensed functions that you purchase so you do not lose any data after you start server operations, such as backing up your data.
- [AIX: Specifying a device class in preparation for database backups](#)  
To prepare the system for automatic and manual database backups, you must specify the device class to be used.
- [AIX: Running multiple server instances on a single system](#)  
You can create more than one server instance on your system. Each server instance has its own instance directory, and database and log directories.
- [AIX: Monitoring the server](#)  
When you start to use the server in production, monitor the space that is used by the server to ensure that the amount of space is adequate. Adjust the space if needed.

## AIX: Creating the user ID and directories for the server instance

---

Create the user ID for the IBM Spectrum Protect™ server instance and create the directories that the server instance needs for database and recovery logs.

### Before you begin

---

Review the information about planning space for the server before you complete this task. See [AIX: Worksheets for planning details for the server](#).

### Procedure

---

1. Create the user ID that will own the server instance. You use this user ID when you create the server instance in a later step.

[AIX](#)

**AIX** Create a user ID and group that will be the owner of the server instance.

- a. The following commands can be run from an administrative user ID that will set up the user and group. Create the user ID and group in the home directory of the user.

Restriction: In the user ID, only lowercase letters (a-z), numerals (0-9), and the underscore character ( \_ ) can be used. The user ID and group name must comply with the following rules:

- The length must be 8 characters or less.
- The user ID and group name cannot start with *ibm*, *sql*, *sys*, or a numeral.
- The user ID and group name cannot be *user*, *admin*, *guest*, *public*, *local*, or any SQL reserved word.

For example, create user ID `tsminst1` in group `tsmsrvrs`. The following examples show how to create this user ID and group using operating system commands.

**AIX**

```
mkgroup id=1001 tsmsrvrs
mkuser id=1002 pgrp=tsmsrvrs home=/home/tsminst1 tsminst1
passwd tsminst1
```

Restriction: DB2® does not support direct operating system user authentication through LDAP.

- b. Log off, then log in to your system. Change to the user account that you just created. Use an interactive login program, such as telnet, so that you are prompted for the password and can change it if necessary.

2. Create directories that the server requires.

**AIX**

Create empty directories for each item in the table and ensure that the directories are owned by the new user ID you just created. Mount the associated storage to each directory for the active log, archive log, and database directories.

Item	Example commands for creating the directories	Your directories
The <i>instance directory</i> for the server, which is a directory that will contain files specifically for this server instance (the server options file and other server-specific files)	<code>mkdir /tsminst1</code>	
The database directories	<code>mkdir /tsmdb001</code> <code>mkdir /tsmdb002</code> <code>mkdir /tsmdb003</code> <code>mkdir /tsmdb004</code>	
Active log directory	<code>mkdir /tsmlog</code>	
Archive log directory	<code>mkdir /tsmarchlog</code>	
Optional: Directory for the log mirror for the active log	<code>mkdir /tsmlogmirror</code>	
Optional: Secondary archive log directory (failover location for archive log)	<code>mkdir /tsmarchlogfailover</code>	

When a server is initially created by using the DSMSEV FORMAT utility or the configuration wizard, a server database and recovery log are created. In addition, files are created to hold database information that is used by the database manager.

3. Log off the new user ID.

## AIX: Configuring the IBM Spectrum Protect server

After you have installed the server and prepared for the configuration, configure the server instance.

### About this task

Configure an IBM Spectrum Protect™ server instance by selecting one of the following options:

- **AIX: Configuring IBM Spectrum Protect by using the configuration wizard**  
The wizard offers a guided approach to configuring a server. By using the graphical user interface (GUI), you can avoid some

configuration steps that are complex when done manually. Start the wizard on the system where you installed the IBM Spectrum Protect server program.

- AIX: Configuring the server instance manually

After installing IBM Spectrum Protect Version 8.1.2, you can configure IBM Spectrum Protect manually instead of using the configuration wizard.

## AIX: Configuring IBM Spectrum Protect by using the configuration wizard

---

The wizard offers a guided approach to configuring a server. By using the graphical user interface (GUI), you can avoid some configuration steps that are complex when done manually. Start the wizard on the system where you installed the IBM Spectrum Protect™ server program.

### Before you begin

---

Before you begin to use the configuration wizard, you must complete all preceding steps to prepare for the configuration. These steps include installing IBM Spectrum Protect, creating the database and log directories, and creating the directories and user ID for the server instance.

### Procedure

---

1. Ensure that the following requirements are met: **AIX**
  - The system where you installed IBM Spectrum Protect must have the X Window System client. You must also be running an X Window System server on your desktop.
  - The system must have the Secure Shell (SSH) protocol enabled. Ensure that the port is set to the default value, 22, and that the port is not blocked by a firewall. You must enable password authentication in the `sshd_config` file in the `/etc/ssh/` directory. Also, ensure that the SSH daemon service has access rights for connecting to the system by using the `localhost` value.
  - You must be able to log in to IBM Spectrum Protect with the user ID that you created for the server instance, by using the SSH protocol. When you use the wizard, you must provide this user ID and password to access that system.
  - Restart the server before you proceed with the Configuration wizard.
2. Start the local version of the wizard:
  - **AIX** Open the `dsmiCfgx` program in the `/opt/tivoli/tsm/server/bin` directory. This wizard can be only run as a root user.

Follow the instructions to complete the configuration. The wizard can be stopped and restarted, but the server is not operational until the entire configuration process is complete.

## AIX: Configuring the server instance manually

---

After installing IBM Spectrum Protect™ Version 8.1.2, you can configure IBM Spectrum Protect manually instead of using the configuration wizard.

- AIX: Creating the server instance  
Create an IBM Spectrum Protect instance by issuing the `db2icrt` command.
- **AIX** AIX: Configuring server and client communications  
A default sample server options file, `dsmserv.opt.smp`, is created during IBM Spectrum Protect installation in the `/opt/tivoli/tsm/server/bin` directory. You must set up communications between the server and clients by creating a new server options file. To do so, copy the sample file to the directory for the server instance.
- AIX: Formatting the database and log  
Use the `DSMSERV FORMAT` utility to initialize a server instance. No other server activity is allowed while you initialize the database and recovery log.
- AIX: Preparing the database manager for database backup  
To back up the data in the database to IBM Spectrum Protect, you must enable the database manager and configure the IBM Spectrum Protect application programming interface (API).

## AIX: Creating the server instance

---

Create an IBM Spectrum Protect™ instance by issuing the `db2icrt` command.

### About this task

---

You can have one or more server instances on one workstation.

**AIX** Important: Before you run the db2icrt command, verify the following items:

- The home directory for the user (/home/tsminst1) exists. If there is no home directory, you must create it. The instance directory stores the following core files that are generated by the IBM Spectrum Protect server:
  - The server options file, dsmserv.opt
  - The server key database file, cert.kdb, and the .arm files (used by clients and other servers to import the Secure Sockets Layer certificates of the server)
  - Device configuration file, if the DEVCONFIG server option does not specify a fully qualified name
  - Volume history file, if the VOLUMEHISTORY server option does not specify a fully qualified name
  - Volumes for DEVTYPE=FILE storage pools, if the directory for the device class is not fully specified, or not fully qualified
  - User exits
  - Trace output (if not fully qualified)
- A shell configuration file (for example, .profile) exists in the home directory. The root user and instance-user ID must have write permission to this file. For more information, see the DB2® product information. Search for Linux and UNIX environment variable settings.

**AIX**

1. Log in using the root user ID and create an IBM Spectrum Protect instance. The name of the instance must be the same name as the user that owns the instance. Use the db2icrt command and enter the command on one line: **AIX**

```
/opt/tivoli/tsm/db2/instance/db2icrt -a server -u  
instance_name instance_name
```

For example, if your user ID for this instance is tsminst1, use the following command to create the instance. Enter the command on one line. **AIX**

```
/opt/tivoli/tsm/db2/instance/db2icrt -a server -u  
tsminst1 tsminst1
```

Remember: From this point on, use this new user ID when you configure your IBM Spectrum Protect server. Log out of the root user ID and log in under the new instance-user ID.

2. Change the default directory for the database to be the same as the instance directory for the server. If you have multiple servers, log in under the instance ID for each server. Issue this command:

```
db2 update dbm cfg using dftdbpath instance_directory
```

For example, where instance\_directory is the instance user ID:

```
db2 update dbm cfg using dftdbpath /tsminst1
```

3. Modify the library path to use the version of the IBM Global Security Kit (GSKit) that is installed with the server. In the following examples, server\_bin\_directory is a subdirectory of the server installation directory. For example, /opt/tivoli/tsm/server/bin.

- **AIX** Issue the following command, on one line:

```
export LIBPATH=server_bin_directory/dbbkapi:  
/usr/opt/ibm/gsk8_64/lib64:$LIBPATH
```

- You must update the following files to set the library path when DB2 or the server are started:

Bash or Korn shell example:

```
instance_users_home_directory/sqlllib/userprofile
```

C shell example:

```
instance_users_home_directory/sqlllib/usercshrc
```

- Add the following entry to the instance\_users\_home\_directory/sqlllib/userprofile (Bash or Korn shell) file. Each entry is on one line. **AIX**

```
LIBPATH=server_bin_directory/dbbkapi:  
/usr/opt/ibm/gsk8_64/lib64:$LIBPATH
```

```
export LIBPATH
```

Remember: The following entries must be in the library path:

- /usr/local/ibm/gsk8\_64/lib64
  - /opt/ibm/lib
  - /opt/ibm/lib64
  - /usr/lib64
- Add the following entry to the `instance_users_home_directory/sqlplib/usercshrc` (C shell) file, on one line: AIX

```
setenv LIBPATH server_bin_directory/dbbkapi:
/usr/opt/ibm/gsk8_64/lib64:$LIBPATH
```

- Verify the library path settings and that the GSKit is version 8.0.14.43 or later. Issue the following commands:

```
AIX
echo $LIBPATH
gsk8capicmd_64 -version
gsk8ver_64
```

If your GSKit version is not 8.0.14.43 or later, you must reinstall the IBM Spectrum Protect server. The reinstallation ensures that the correct GSKit version is available.

4. Create a new server options file. See AIX: Configuring server and client communications.

AIX

## AIX: Configuring server and client communications

A default sample server options file, `dsmserv.opt.smp`, is created during IBM Spectrum Protect™ installation in the `/opt/tivoli/tsm/server/bin` directory. You must set up communications between the server and clients by creating a new server options file. To do so, copy the sample file to the directory for the server instance.

### About this task

Ensure that you have a server instance directory, for example `/tsminst1`, and copy the sample file to this directory. Name the new file `dsmserv.opt` and edit the options. Complete this set-up before you initialize the server database. Each sample or default entry in the sample options file is a comment, a line beginning with an asterisk (\*). Options are not case-sensitive and one or more blank spaces are allowed between keywords and values.

When editing the options file, follow these guidelines:

- Remove the asterisk at the beginning of the line to activate an option.
- Begin entering the options in any column.
- Enter only one option per line, and the option must be on only one line.
- If you make multiple entries for a keyword, the IBM Spectrum Protect server uses the last entry.

If you change the server options file, you must restart the server for the changes to take effect.

You can specify one or more of the following communication methods:

- TCP/IP Version 4 or Version 6
- Shared memory
- Secure Sockets Layer (SSL)
 

Tip: You can authenticate passwords with the LDAP directory server, or authenticate passwords with the IBM Spectrum Protect server. Passwords that are authenticated with the LDAP directory server can provide enhanced system security.
- AIX AIX: Setting TCP/IP options
 

Select from a range of TCP/IP options for the IBM Spectrum Protect server or retain the default.
- AIX AIX: Setting shared memory options
 

You can use shared memory communications between clients and servers on the same system. To use shared memory, TCP/IP Version 4 must be installed on the system.
- AIX AIX: Setting Secure Sockets Layer options
 

You can add more protection for your data and passwords by using Secure Sockets Layer (SSL).

## AIX: Setting TCP/IP options

Select from a range of TCP/IP options for the IBM Spectrum Protect™ server or retain the default.

## About this task

---

The following is an example of a list of TCP/IP options that you can use to set up your system.

```
commmethod      tcpip
tcpport         1500
tcpwindowsize   0
tcpnodelay      yes
```

Tip: You can use TCP/IP Version 4, Version 6, or both.

### TCPPOINT

The server port address for TCP/IP and SSL communication. The default value is 1500.

#### **AIX** TCPWINDOWSIZE

**AIX** Specifies the size of the TCP/IP buffer that is used when sending or receiving data. The window size that is used in a session is the smaller of the server and client window sizes. Larger window sizes use additional memory but can improve performance.

You can specify an integer from 0 to 2048. To use the default window size for the operating system, specify 0.

### TCPNODELAY

Specifies whether or not the server sends small messages or lets TCP/IP buffer the messages. Sending small messages can improve throughput but increases the number of packets sent over the network. Specify YES to send small messages or NO to let TCP/IP buffer them. The default is YES.

### TCPADMINPORT

Specifies the port number on which the server TCP/IP communication driver is to wait for TCP/IP or SSL-enabled communication requests other than client sessions. The default is the value of TCPPOINT.

### SSLTCPPOINT

(SSL-only) Specifies the Secure Sockets Layer (SSL) port number on which the server TCP/IP communication driver waits for requests for SSL-enabled sessions for the command-line backup-archive client and the command-line administrative client.

### SSLTCPADMINPORT

(SSL-only) Specifies the port address on which the server TCP/IP communication driver waits for requests for SSL-enabled sessions for the command-line administrative client.

## AIX: Setting shared memory options

---

You can use shared memory communications between clients and servers on the same system. To use shared memory, TCP/IP Version 4 must be installed on the system.

## About this task

---

The following example shows a shared memory setting:

```
commmethod      sharedmem
shmport         1510
```

In this example, SHMPORT specifies the TCP/IP port address of a server when using shared memory. Use the SHMPORT option to specify a different TCP/IP port. The default port address is 1510.

COMMETHOD can be used multiple times in the IBM Spectrum Protect™ server options file, with a different value each time. For example, the following example is possible:

```
commmethod tcpip
commmethod sharedmem
```

**AIX** The maximum number of concurrent shared memory sessions is based on available system resources. Each shared memory session uses one shared memory region of up to 4 MB, and four IPCS message queues, depending on the IBM Spectrum Protect client level.

**AIX** If the server and client are not run under the same user ID, then the server must be root. This prevents shared memory communication errors.

## AIX: Setting Secure Sockets Layer options

---

You can add more protection for your data and passwords by using Secure Sockets Layer (SSL).

## Before you begin

---

SSL is the standard technology for creating encrypted sessions between servers and clients. SSL provides a secure channel for servers and clients to communicate over open communication paths. With SSL, the identity of the server is verified through the use of digital certificates.

To ensure better system performance, use SSL only for sessions when it is needed. Consider adding additional processor resources on the IBM Spectrum Protect™ server to manage the increased requirements.

## AIX: Formatting the database and log

---

Use the DSMSEV FORMAT utility to initialize a server instance. No other server activity is allowed while you initialize the database and recovery log.

After you set up server communications, you are ready to initialize the database. Ensure that you log in by using the instance user ID. Do not place the directories on file systems that might run out of space. If certain directories (for example, the archive log) become unavailable or full, the server stops.

For optimal performance and to facilitate I/O, specify at least two equally sized containers or Logical Unit Numbers (LUNs) for the database. In addition, each active log and archive log needs its own container or LUN.

## Setting the exit list handler

---

Set the DB2NOEXITLIST registry variable to ON for each server instance. Log on to the system as the server instance owner and issue this command:

```
db2set -i server_instance_name DB2NOEXITLIST=ON
```

For example: **AIX**

```
db2set -i tsminst1 DB2NOEXITLIST=ON
```

## Initializing a server instance

---

Use the DSMSEV FORMAT utility to initialize a server instance. For example, if the server instance directory is */tsminst1*, issue the following commands: **AIX**

```
cd /tsminst1
dsmserv format dbdir=/tsmdb001 activelogsiz=32768
activelogdirectory=/activelog archlogdirectory=/archlog
archfailoverlogdirectory=/archfaillog mirrorlogdirectory=/mirrorlog
```

Tip: If you specify multiple directories, ensure that the underlying file systems are of equal size to ensure a consistent degree of parallelism for database operations. If one or more directories for the database are smaller than the others, they reduce the potential for optimized parallel prefetching and distribution of the database.

**AIX** Tip: If DB2® does not start after you issue the DSMSEV FORMAT command, you might need to disable the file system mount option NOSUID. If this option is set on the file system that contains the DB2 instance owner directory, or on any file system that contains the DB2 database, active logs, archive logs, failover logs, or mirrored logs, the option must be disabled to start the system.

After you disable the NOSUID option, remount the file system and then start DB2 by issuing the following command:

```
db2start
```

### Related information:

[DSMSEV FORMAT \(Format the database and log\)](#)

## AIX: Preparing the database manager for database backup

---

To back up the data in the database to IBM Spectrum Protect™, you must enable the database manager and configure the IBM Spectrum Protect application programming interface (API).

## About this task

**AIX** Starting with IBM Spectrum Protect V7.1, it is no longer necessary to set the API password during a manual configuration of the server. If you set the API password during the manual configuration process, attempts to back up the database might fail.

If you use the configuration wizard to create an IBM Spectrum Protect server instance, you do not have to complete these steps. If you are configuring an instance manually, complete the following steps before you issue either the BACKUP DB or the RESTORE DB commands.

Attention: If the database is unusable, the entire IBM Spectrum Protect server is unavailable. If a database is lost and cannot be recovered, it might be difficult or impossible to recover data that is managed by that server. Therefore, it is critically important to back up the database.

**AIX** In the following commands, replace the example values with your actual values. The examples use `tsminst1` for the server instance user ID, `/tsminst1` for the server instance directory, and `/home/tsminst1` as the server instance users home directory.

1. Set the IBM Spectrum Protect API environment-variable configuration for the database instance:

- a. Log in by using the `tsminst1` user ID.
- b. When user `tsminst1` is logged in, ensure that the DB2® environment is properly initialized. The DB2 environment is initialized by running the `/home/tsminst1/sqllib/db2profile` script, which normally runs automatically from the profile of the user ID. Ensure the `.profile` file exists in the instance users home directory, for example, `/home/tsminst1/.profile`. If `.profile` does not run the `db2profile` script, add the following lines:

```
if [ -f /home/tsminst1/sqllib/db2profile ]; then
    . /home/tsminst1/sqllib/db2profile
fi
```

- c. In the `instance_directory/sqllib/userprofile` file, add the following lines:

```
DSMI_CONFIG=server_instance_directory/tsmdbmgr.opt
DSMI_DIR=server_bin_directory/dbbkapi
DSMI_LOG=server_instance_directory
export DSMI_CONFIG DSMI_DIR DSMI_LOG
```

where:

- *instance\_directory* is the home directory of the server instance user.
- *server\_instance\_directory* is the server instance directory.
- *server\_bin\_directory* is the server bin directory. The default location is `/opt/tivoli/tsm/server/bin`.

In the `instance_directory/sqllib/usercshrc` file, add the following lines:

```
setenv DSMI_CONFIG=server_instance_directory/tsmdbmgr.opt
setenv DSMI_DIR=server_bin_directory/dbbkapi
setenv DSMI_LOG=server_instance_directory
```

2. Log off and log in again as `tsminst1`, or issue this command:

```
. ~/.profile
```

Tip: Ensure that you enter a space after the initial dot (.) character.

3. Create a file that is named `tsmdbmgr.opt` in the *server\_instance* directory, which is in the `/tsminst1` directory in this example, and add the following line:

```
SERVERNAME TSMDBMGR_TSMINST1
```

Remember: The value for `SERVERNAME` must be consistent in the `tsmdbmgr.opt` and `dsm.sys` files.

4. As root user, add the following lines to the IBM Spectrum Protect API `dsm.sys` configuration file. By default, the `dsm.sys` configuration file is in the following default location:

- o `server_bin_directory/dbbkapi/dsm.sys`

```
servername TSMDBMGR_TSMINST1
commethod tcpip
tcpserveraddr localhost
tcpport 1500
errorlogname /tsminst1/tsmdbmgr.log
nodename $$TSMDBMGR_$$
```

where



- o *servername* matches the *servername* value in the `tsmdbmgr.opt` file.
  - o *commethod* specifies the client API that is used to contact the server for database backup. This value can be `tcpip` or `sharedmem`. For more information about shared memory, see step 5.
  - o *tcpserveraddr* specifies the server address that the client API uses to contact the server for database backup. To ensure that the database can be backed up, this value must be `localhost`.
  - o *tcpport* specifies the port number that the client API uses to contact the server for database backup. Ensure that you enter the same `tcpport` value that is specified in the `dsmserv.opt` server options file.
  - o *errorlogname* specifies the error log where the client API logs errors that are encountered during a database backup. This log is typically in the server instance directory. However, this log can be placed in any location where the instance user ID has write-permission.
  - o *nodename* specifies the node name that the client API uses to connect to the server during a database backup. To ensure that the database can be backed up, this value must be `$_TSMDBMGR_`.
5. Optional: Configure the server to back up the database by using shared memory. In this way, you might be able to reduce the processor load and improve throughput. Complete the following steps:
- a. Review the `dsmserv.opt` file. If the following lines are not in the file, add them:

```
commethod sharedmem
shmport port_number
```

where *port\_number* specifies the port to be used for shared memory.

- b. In the `dsm.sys` configuration file, locate the following lines:

```
commethod tcpip
tcpserveraddr localhost
tcpport port_number
```

Replace the specified lines with the following lines:

```
commethod sharedmem
shmport port_number
```

where *port\_number* specifies the port to be used for shared memory.

## AIX: Configuring server options for server database maintenance

---

To help avoid problems with database growth and server performance, the server automatically monitors its database tables and reorganizes them when needed. Before starting the server for production use, set server options to control when reorganization runs. If you plan to use data deduplication, ensure that the option to run index reorganization is enabled.

### About this task

---

Table and index reorganization requires significant processor resources, active log space, and archive log space. Because database backup takes precedence over reorganization, select the time and duration for reorganization to ensure that the processes do not overlap and reorganization can complete.

**AIX** You can optimize index and table reorganization for the server database. In this way, you can help to avoid unexpected database growth and performance issues. For instructions, see technote 1683633.

If you update these server options while the server is running, you must stop and restart the server before the updated values take effect.

### Procedure

---

1. Modify the server options.

**AIX** Edit the server options file, `dsmserv.opt`, in the server instance directory. Follow these guidelines when you edit the server options file:

- o To enable an option, remove the asterisk at the beginning of the line.
- o Enter an option on any line.
- o Enter only one option per line. The entire option with its value must be on one line.
- o If you have multiple entries for an option in the file, the server uses the last entry.

To view available server options, see the sample file, `dsmserv.opt.smp`, in the `/opt/tivoli/tsm/server/bin` directory.

2. If you plan to use data deduplication, enable the `ALLOWREORGINDEX` server option. Add the following option and value to the server options file:

```
allowreorgindex yes
```

3. Set the REORGBEGINTIME and REORGDURATION server options to control when reorganization starts and how long it runs. Select a time and duration so that reorganization runs when you expect that the server is least busy. These server options control both table and index reorganization processes.
  - a. Set the time for reorganization to start by using the REORGBEGINTIME server option. Specify the time by using the 24-hour system. For example, to set the start time for reorganization as 8:30 p.m., specify the following option and value in the server options file:

```
reorgbegintime 20:30
```

- b. Set the interval during which the server can start reorganization. For example, to specify that the server can start reorganization for four hours after the time set by the REORGBEGINTIME server option, specify the following option and value in the server options file:

```
reorgduration 4
```

4. If the server was running while you updated the server options file, stop and restart the server.

**Related information:**

[ALLOWREORGINDEX](#)

[ALLOWREORGTABLE](#)

[REORGBEGINTIME](#)

[REORGDURATION](#)

AIX

## AIX: Starting the server instance

---

You can start the server by using the instance user ID, which is the preferred method, or the root user ID.

### Before you begin

---

Ensure that you set access permissions and user limits correctly.

**AIX** For instructions, see [Verifying access rights and user limits](#).

### About this task

---

When you start the server by using the instance user ID, you simplify the setup process and avoid potential issues. However, in some cases, it might be necessary to start the server with the root user ID. For example, you might want to use the root user ID to ensure that the server can access specific devices. You can set up the server to start automatically by using either the instance user ID or the root user ID.

**AIX** If you must complete maintenance or reconfiguration tasks, start the server in maintenance mode.

### Procedure

---

To start the server, take one of the following actions:

- Start the server by using the instance user ID.

**AIX** For instructions, see [Starting the server from the instance user ID](#).

- Start the server by using the root user ID.

For instructions about authorizing root user IDs to start the server, see [Authorizing root user IDs to start the server \(V7.1.1\)](#). For instructions about starting the server by using the root user ID, see [Starting the server from the root user ID \(V7.1.1\)](#).

- **AIX** Start the server automatically.

**AIX** For instructions, see [AIX: Automatically starting servers](#).

- **AIX** Start the server in maintenance mode.

For instructions, see [AIX: Starting the server in maintenance mode](#).

## AIX: Verifying access rights and user limits

Before you start the server, verify access rights and user limits.

### About this task

If you do not verify user limits, also known as *ulimits*, you might experience server instability or a failure of the server to respond. You must also verify the system-wide limit for the maximum number of open files. The system-wide limit must be greater than or equal to the user limit.

### Procedure

1. Verify that the server instance user ID has permissions to start the server.
2. For the server instance that you plan to start, ensure that you have authority to read and write files in the server instance directory. Verify that the `dsmserv.opt` file exists in the server instance directory, and that the file includes parameters for the server instance.
3. If the server is attached to a tape drive, medium changer, or removable media device, and you plan to start the server by using the instance user ID, grant read/write access to the instance user ID for these devices. To set permissions, take one of the following actions:

- o If the system is dedicated to IBM Spectrum Protect™ and only the IBM Spectrum Protect administrator has access, make the device special file world-writable. On the operating system command line, issue the following command:

```
chmod +w /dev/rmtX
```

- o If the system has multiple users, you can restrict access by making the IBM Spectrum Protect instance user ID the owner of the special device files. On the operating system command line, issue the following command:

```
chmod u+w /dev/rmtX
```

- o If multiple user instances are running on the same system, change the group name, for example TAPEUSERS, and add each IBM Spectrum Protect instance user ID to that group. Then, change the ownership of the device special files to belong to the group TAPEUSERS, and make them group-writable. On the operating system command line, issue the following command:

```
chmod g+w /dev/rmtX
```

4. Verify the following user limits based on the guidelines in the table.

Table 1. User limit (ulimit) values

User limit type	Preferred value	Command to query value
Maximum size of core files created	Unlimited	<code>ulimit -Hc</code>
Maximum size of a data segment for a process	Unlimited	<code>ulimit -Hd</code>
Maximum file size	Unlimited	<code>ulimit -Hf</code>
Maximum number of open files	65536	<code>ulimit -Hn</code>
Maximum amount of processor time in seconds	Unlimited	<code>ulimit -Ht</code>

To modify user limits, follow the instructions in the documentation for your operating system.

Tip: If you plan to start the server automatically by using a script, you can set the user limits in the script.

5. Ensure that the user limit of maximum user processes (the `nproc` setting) is set to the minimum suggested value of 16384.
  - a. To verify the current user limit, issue the `ulimit -Hu` command by using the instance user ID. For example:

```
[user@Machine ~]$ ulimit -Hu
16384
```

- b. If the limit of maximum user processes is not set to 16384, set the value to 16384.

**AIX** Add the following line to the `/etc/security/limits` file:

```
instance_user_id          -          nproc          16384
```

where `instance_user_id` specifies the server instance user ID.

## AIX: Starting the server from the instance user ID

To start the server from the instance user ID, log in with the instance user ID and issue the appropriate command from the server instance directory.

### Before you begin

Ensure that access rights and user limits are set correctly. For instructions, see [AIX: Verifying access rights and user limits](#).

### Procedure

1. Log in to the system where IBM Spectrum Protect™ is installed by using the instance user ID for the server.
2. If you do not have a user profile that runs the `db2profile` script, issue the following command:

```
. /home/tsminst1/sqlllib/db2profile
```

Tip: For instructions about updating the user ID login script to run the `db2profile` script automatically, see the [DB2®](#) documentation.

3. Start the server by issuing the following command on one line from the server instance directory:

AIX

```
LDR_CNTRL=TEXTPSIZE=64K@DATAPSIZE=64K@STACKPSIZE=64K@SHMPSIZE=64K
usr/bin/dmserv
```

AIX

Ensure that you include a space after `SHMPSIZE=64K`. By starting the server with this command, you enable 64 KB memory pages for the server. This setting helps you optimize server performance.

Tip: The command runs in the foreground so that you can set an administrator ID and connect to the server instance.

AIX

For example, if the name of the server instance is `tsminst1` and the server instance directory is `/tsminst1`, you can start the instance by issuing the following commands:

```
cd /tsminst1
. ~/sqlllib/db2profile
LDR_CNTRL=TEXTPSIZE=64K@DATAPSIZE=64K@STACKPSIZE=64K@SHMPSIZE=64K
usr/bin/dmserv
```

AIX

## AIX: Automatically starting servers

You can configure the server to start automatically at system startup. Use the `rc.dmserv` script, which is provided for this purpose.

### Before you begin

Ensure that access rights and user limits are set correctly.

AIX

For instructions, see [Verifying access rights and user limits](#).

### About this task

The `rc.dmserv` script is in the server installation directory, for example, in the `/opt/tivoli/tsm/server/bin` directory.

AIX

Tip: If you used the configuration wizard, you might have chosen to start the server automatically when the system is restarted. If you selected that choice, an entry for starting the server was added automatically to the `/etc/inittab` file.

### Procedure

If you did not use a wizard to configure the server, add an entry to the `/etc/inittab` file for each server that you want to automatically start:

1. Set the run level to the value that corresponds to multiuser mode with networking enabled. Typically, the run level to use is 2, 3, or 5, depending on the operating system and its configuration. Ensure that the run level in the `/etc/inittab` file matches the run level of the operating system. For more information about multiuser mode and run levels, see the documentation for your operating system.
2. On the `rc.dsmserv` command in the `/etc/inittab` file, specify the instance user ID with the `-u` option, and the location of the server instance directory with the `-i` option. If you want to start more than one server instance automatically, add an entry for each server instance. To verify the syntax, see the documentation for your operating system.  
Tip: To automatically start a server instance with the root user ID, use the `-U` option.

## Example

For example, if the instance owner is `tsm1` and the server instance directory is `/home/tsminst1/tsminst1`, add the following entry to `/etc/inittab`, on one line:

AIX

```
tsm1:2:once:/opt/tivoli/tsm/server/bin/rc.dsmserv -u tsm1  
-i /home/tsminst1/tsminst1 -q >/dev/console 2>&1
```

In this example, the ID for the process is `tsm1`, and the run level is set to 2.

If you have more than one server instance that you want to run, add an entry for each server instance. For example, if you have instance owner IDs `tsm1` and `tsm2`, and instance directories `/home/tsminst1/tsminst1` and `/home/tsminst2/tsminst2`, add the following entries to `/etc/inittab`. Each entry is on one line.

AIX

```
tsm1:2:once:/opt/tivoli/tsm/server/bin/rc.dsmserv -u tsm1  
-i /home/tsminst1/tsminst1 -q >/dev/console 2>&1  
tsm2:2:once:/opt/tivoli/tsm/server/bin/rc.dsmserv -u tsm2  
-i /home/tsminst2/tsminst2 -q >/dev/console 2>&1
```

### Related reference:

[Server startup script: rc.dsmserv](#)

AIX

## AIX: Starting the server in maintenance mode

You can start the server in maintenance mode to avoid disruptions during maintenance and reconfiguration tasks.

### About this task

Start the server in maintenance mode by running the `DSMSERV` utility with the `MAINTENANCE` parameter.

The following operations are disabled in maintenance mode:

- Administrative command schedules
- Client schedules
- Reclamation of storage space on the server
- Inventory expiration
- Migration of storage pools

In addition, clients are prevented from starting sessions with the server.

Tips:

- You do not have to edit the server options file, `dsmserv.opt`, to start the server in maintenance mode.
- While the server is running in maintenance mode, you can manually start the storage-space reclamation, inventory expiration, and storage-pool migration processes.

### Procedure

To start the server in maintenance mode, issue the following command:

```
dsmserv maintenance
```

Tip: To view a video about starting the server in maintenance mode, see [Starting a server in maintenance mode](#).

## What to do next

---

To resume server operations in production mode, complete the following steps:

1. Shut down the server by issuing the HALT command:

```
halt
```

2. Start the server by using the method that you use in production mode.

Operations that were disabled during maintenance mode are reenabled.

## AIX: Stopping the server

---

You can stop the server when needed to return control to the operating system. To avoid losing administrative and client node connections, stop the server only after current sessions are completed or canceled.

### About this task

---

To stop the server, issue the following command from the IBM Spectrum Protect™ command line:

```
halt
```

**AIX** If you cannot connect to the server with an administrative client and you want to stop the server, you must cancel the process by using the kill command with the process ID number (pid). The pid is displayed at initialization. Important: Before you issue the kill command, ensure that you know the correct process ID for the IBM Spectrum Protect server. The `dsmserv.v6lock` file, in the directory from which the server is running, can be used to identify the process ID of the process to kill. To display the file, enter:

```
cat /instance_dir/dsmserv.v6lock
```

**AIX** Issue the following command to stop the server:

```
kill -36 dsmserv_pid
```

where `dsmserv_pid` is the process ID number.

## AIX: Registering licenses

---

Immediately register any IBM Spectrum Protect™ licensed functions that you purchase so you do not lose any data after you start server operations, such as backing up your data.

### About this task

---

Use the REGISTER LICENSE command for this task. See REGISTER LICENSE for more details.

### Example: Register a license

---

Register the base IBM Spectrum Protect license.

```
register license file=tsmbasic.lic
```

## AIX: Specifying a device class in preparation for database backups

---

To prepare the system for automatic and manual database backups, you must specify the device class to be used.

### Before you begin

---

Ensure that you have defined a tape or file device class. For details, see DEFINE DEVCLASS, or search for defining a device class.

### About this task

---

Complete the following steps to set up your system for database backups.

## Procedure

---

1. If you did not use the configuration wizard (dsmicfgx) to configure the server, ensure that you have completed the steps to manually configure the system for database backups.
2. Select the device class to be used for backups of the database. Issue the following command from an IBM Spectrum Protect™ administrative command line.

```
set dbrecovery device_class_name
```

The device class that you specify is used by the database manager for database backups. If you do not specify a device class with the SET DBRECOVERY command, the backup fails.

## Example

---

For example, to specify that the DBBACK device class is to be used, issue this command:

```
set dbrecovery ddback
```

## AIX: Running multiple server instances on a single system

---

You can create more than one server instance on your system. Each server instance has its own instance directory, and database and log directories.

Multiply the memory and other system requirements for one server by the number of instances planned for the system.

**AIX** The set of files for one instance of the server is stored separately from the files used by another server instance on the same system. Use the steps in AIX: Creating the server instance for each new instance, including creation of the new instance user.

To manage the system memory that is used by each server, use the DBMEMPERCENT server option to limit the percentage of system memory. If all servers are equally important, use the same value for each server. If one server is a production server and other servers are test servers, set the value for the production server to a higher value than the test servers.

You can upgrade directly from either V6.3 to V7.1. See the upgrade section (Upgrading to V8.1) for more details. When you upgrade and have multiple servers on your system, you must run the installation wizard only once. The installation wizard collects the database and variables information for all of your original server instances.

If you upgrade from IBM Spectrum Protect V6.3 to V8.1.2 and have multiple servers on your system, all instances that exist in DB2® V9.7 are dropped and recreated in DB2 V11.1. The wizard issues the `db2 upgrade db dbname` command for each database. The database environment variables for each instance on your system are also reconfigured during the upgrade process.

### Related tasks:

[Running multiple server instances on a single system \(V7.1.1\)](#)

## AIX: Monitoring the server

---

When you start to use the server in production, monitor the space that is used by the server to ensure that the amount of space is adequate. Adjust the space if needed.

## Procedure

---

1. Monitor the active log to ensure that the size is correct for the workload that is handled by the server instance.

When the server workload reaches its typical expected level, the space that is used by the active log is 80% - 90% of the space that is available to the active log directory. At that point, you might need to increase the amount of space. Whether you must increase the space depends on the types of transactions in the server workload. Transaction characteristics affect how the active log space is used.

The following transaction characteristics can affect the space usage in the active log:

- The number and size of files in backup operations
  - Clients such as file servers that back up large numbers of small files can cause large numbers of transactions that are completed quickly. The transactions might use a large amount of space in the active log, but for a short time.
  - Clients such as a mail server or a database server that back up large amounts of data in few transactions can cause small numbers of transactions that take a long time to complete. The transactions might use a small amount of space in the active log, but for a long time.
- Network connection types
  - Backup operations that occur over fast network connections cause transactions that complete more quickly. The transactions use space in the active log for a shorter time.
  - Backup operations that occur over relatively slower connections cause transactions that take a longer time to complete. The transactions use space in the active log for a longer time.

If the server is handling transactions with a wide variety of characteristics, the space that is used for the active log might increase and decrease significantly over time. For such a server, you might need to ensure that the active log typically has a smaller percentage of its space used. The extra space allows the active log to grow for transactions that take a long time to complete.

## 2. Monitor the archive log to ensure that space is always available.

Remember: If the archive log becomes full, and the failover archive log becomes full, the active log can become full, and the server stops. The goal is to make enough space available to the archive log so that it never uses all its available space.

You are likely to notice the following pattern:

- a. Initially, the archive log grows rapidly as typical client-backup operations occur.
- b. Database backups occur regularly, either as scheduled or done manually.
- c. After at least two full database backups occur, log pruning occurs automatically. The space that is used by the archive log decreases when the pruning occurs.
- d. Normal client operations continue, and the archive log grows again.
- e. Database backups occur regularly, and log pruning occurs as often as full database backups occur.

With this pattern, the archive log grows initially, decreases, and then might grow again. Over time, as normal operations continue, the amount of space that is used by the archive log should reach a relatively constant level.

If the archive log continues to grow, consider taking one or both of these actions:

- Add space to the archive log. You might need to move the archive log to a different file system.
  - Increase the frequency of full database backups, so that log pruning occurs more frequently.
3. If you defined a directory for the failover archive log, determine whether any logs get stored in that directory during normal operations. If the failover log space is being used, consider increasing the size of the archive log. The goal is that the failover archive log is used only under unusual conditions, not in normal operation.

## AIX: Installing an IBM Spectrum Protect server fix pack

---

IBM Spectrum Protect™ maintenance updates, which are also referred to as fix packs, bring your server up to the current maintenance level.

### Before you begin

---

To install a fix pack or interim fix to the server, install the server at the level on which you want to run it. You do not have to start the server installation at the base release level. For example, if you currently have V8.1.1 installed, you can go directly to the latest fix pack for V8.1. You do not have to start with the V8.1.0 installation if a maintenance update is available.

You must have the IBM Spectrum Protect license package installed. The license package is provided with the purchase of a base release. When you download a fix pack or interim fix from Fix Central, install the server license that is available on the Passport Advantage® website. To display messages and help in a language other than US English, install the language package of your choice.

If you upgrade the server to V8.1.2 or later, and then revert the server to a level that is earlier than V8.1.2, you must restore the database to a point in time before the upgrade. During the upgrade process, complete the required steps to ensure that the database can be restored: back up the database, the volume history file, the device configuration file, and the server options file. For more information, see AIX: Reverting from Version 8.1.2 to a previous server.

If you are using the client management service, ensure that you upgrade it to the same version as the IBM Spectrum Protect server.



Ensure that you retain the installation media from the base release of the installed server. If you installed IBM Spectrum Protect from a downloaded package, ensure that the downloaded files are available. If the upgrade fails, and the server license module is uninstalled, the installation media from the server base release are required to reinstall the license.

Visit the IBM® Support Portal for the following information:

- A list of the latest maintenance and download fixes. Click **Downloads** and apply any applicable fixes.
- Details about obtaining a base license package. Search for **Downloads > Passport Advantage**.
- Supported platforms and system requirements. Search for **IBM Spectrum Protect supported operating systems**.

Ensure that you upgrade the server before you upgrade backup-archive clients. If you do not upgrade the server first, communication between the server and clients might be interrupted.

Attention: Do not alter the DB2® software that is installed with IBM Spectrum Protect installation packages and fix packs. Do not install or upgrade to a different version, release, or fix pack of DB2 software because doing so can damage the database.

## Procedure

---

To install a fix pack or interim fix, complete the following steps:

1. Back up the database. The preferred method is to use a snapshot backup. A snapshot backup is a full database backup that does not interrupt any scheduled database backups. For example, issue the following IBM Spectrum Protect administrative command:

```
backup db type=dbsnapshot devclass=tapeclass
```

2. Back up the device configuration information. Issue the following IBM Spectrum Protect administrative command:

```
backup devconfig filenames=file_name
```

where *file\_name* specifies the name of the file in which to store device configuration information.

3. Save the volume history file to another directory or rename the file. Issue the following IBM Spectrum Protect administrative command:

```
backup volhistory filenames=file_name
```

where *file\_name* specifies the name of the file in which to store the volume history information.

4. Save a copy of the server options file, typically named dmserv.opt. The file is in the server instance directory.
5. Halt the server before installing a fix pack or interim fix. Use the HALT command.
6. Ensure that extra space is available in the installation directory. The installation of this fix pack might require additional temporary disk space in the installation directory of the server. The amount of additional disk space can be as much as that required for installing a new database as part of an IBM Spectrum Protect installation. The IBM Spectrum Protect installation wizard displays the amount of space that is required for installing the fix pack and the available amount. If the required amount of space is greater than the available amount, the installation stops. If the installation stops, add the required disk space to the file system and restart the installation.
7. **AIX** Log in as the root user.
8. Obtain the package file for the fix pack or interim fix that you want to install from the IBM Support Portal, Passport Advantage, or Fix Central.
9. **AIX** Change to the directory where you placed the executable file and complete the following steps.

Tip: The files are extracted to the current directory. Ensure that the executable file is in the directory where you want the extracted files to be located.

- a. Change file permissions by entering the following command:

```
chmod a+x 8.x.x.x-IBM-SPSRV-platform.bin
```

where *platform* denotes the architecture that IBM Spectrum Protect is to be installed on.

- b. Issue the following command to extract the installation files:

```
./8.x.x.x-IBM-SPSRV-platform.bin
```

10. Select one of the following ways of installing IBM Spectrum Protect.

Important: After a fix pack is installed, it is not necessary to go through the configuration again. You can stop after completing the installation, fix any errors, then restart your servers.

Install the IBM Spectrum Protect software by using one of the following methods:

Installation wizard

Follow the instructions for your operating system:

AIX: Installing IBM Spectrum Protect by using the installation wizard

Tip: After you start the wizard, in the IBM Installation Manager window, click the Update icon; do not click the Install or Modify icon.

Command line in console mode

Follow the instructions for your operating system:

AIX: Installing IBM Spectrum Protect by using console mode

Silent mode

Follow the instructions for your operating system:

AIX: Installing IBM Spectrum Protect in silent mode

Tip: If you have multiple server instances on your system, run the installation wizard only once. The installation wizard upgrades all server instances.

## Results

---

Correct any errors that are detected during the installation process.

If you installed the server by using the installation wizard, you can view installation logs by using the IBM Installation Manager tool. Click File > View Log. To collect log files, from the IBM Installation Manager tool, click Help > Export Data for Problem Analysis.

If you installed the server by using console mode or silent mode, you can view error logs in the IBM Installation Manager log directory, for example:

- `AIX /var/ibm/InstallationManager/logs`
- `AIX AIX: Applying a fix pack to IBM Spectrum Protect V8.1.2 in a clustered environment for AIX`  
IBM Spectrum Protect maintenance updates, which are also referred to as fix packs, bring your server up to the current maintenance level. It is possible to apply a fix pack onto a clustered environment for AIX®.

## AIX: Reverting from Version 8.1.2 to a previous server

---

If you must revert to the previous version of the server after an upgrade, you must have a full database backup from your original version. You must also have the server installation media for your original version and key configuration files. Carefully follow the preparation steps before you upgrade the server. By doing so, it might be possible to revert to the previous version of the IBM Spectrum Protect™ server with minimal loss of data.

### Before you begin

---

You must have the following items from the earlier version of the server:

- Server database backup
- Volume history file
- Device configuration file
- Server options file

### About this task

---

Use the same instructions whether you are reverting within releases or to an earlier release, for example, from 8.1.2 to 8.1.1 or from 8.1.2 to 7.1.2. The older version must match the version that you used before the upgrade to V8.1.

Attention: Specify the REUSEDELAY parameter to help prevent backup-archive client data loss when you revert the server to a previous version.

### Steps for reverting to the previous server version

---

#### About this task

Complete the following steps on the system that has the V8.1 server.

## Procedure

1. Halt the server to shut down all server operations by using the HALT command.
2. Remove the database from the database manager, then delete the database and recovery log directories.
  - a. Manually remove the database. One way to remove it is by issuing this command:

```
dsmserv removedb tsmdb1
```

- b. If you must reuse the space that is occupied by the database and recovery log directories, you can now delete these directories.
3. Use the uninstallation program to uninstall the V8.1 server. Uninstallation removes the server and the database manager, with their directories. For details, see [AIX: Uninstalling IBM Spectrum Protect](#).
  4. Stop the cluster service. Reinstall the version of the server program that you were using before the upgrade to V8.1.2. This version must match the version that your server was running when you created the database backup that you restore in a later step. For example, the server was at V7.1.7 before the upgrade, and you intend to use the database backup that was in use on this server. You must install the V7.1.7 fix pack to be able to restore the database backup.
  5. Configure the new server database by using the configuration wizard. To start the wizard, issue the following command:

```
AIX  
. /dsmicfgx
```

6. Ensure that no servers are running in the background.
7. Restore the database to a point in time before the upgrade.
8. Copy the following files to the instance directory.
  - o Device configuration file
  - o Volume history file
  - o The server options file (typically dsmserv.opt)
9. If you enabled data deduplication for any FILE-type storage pools that existed before the upgrade, or if you moved data that existed before the upgrade into new storage pools while using the V8.1.2 server, you must complete additional recovery steps. For more details, see [Additional recovery steps if you created new storage pools or enabled data deduplication](#).
10. If the REUSEDELAY parameter setting on storage pools is less than the age of the database that you restored, restore volumes on any sequential-access storage pools that were reclaimed after that database backup. Use the RESTORE VOLUME command.  
If you do not have a backup of a storage pool, audit the reclaimed volumes by using the AUDIT VOLUME command, with the FIX=YES parameter to resolve inconsistencies. For example:

```
audit volume volume_name fix=yes
```
11. If client backup or archive operations were completed using the V8.1 server, audit the storage pool volumes on which the data was stored.

## [Additional recovery steps if you created new storage pools or enabled data deduplication](#)

If you created new storage pools, turned on data deduplication for any FILE-type storage pools, or did both while your server was running as a V8.1.2 server, you must complete more steps to return to the previous server version.

### Before you begin

To complete this task, you must have a complete backup of the storage pool that was created before the upgrade to V8.1.2.

### About this task

Use this information if you did either or both of the following actions while your server was running as a V8.1.2 server:

- You enabled the data deduplication function for any storage pools that existed before the upgrade to V8.1.2 program. Data deduplication applies only to storage pools that use a FILE device type.
- You created new primary storage pools after the upgrade *and* moved data that was stored in other storage pools into the new storage pools.

Complete these steps after the server is again restored to V7.

## Procedure

- For each storage pool for which you enabled the data deduplication function, restore the entire storage pool by using the RESTORE STGPPOOL command.
- For storage pools that you created after the upgrade, determine what action to take. Data that was moved from existing V8 storage pools into the new storage pools might be lost because the new storage pools no longer exist in your restored V8 server. Possible recovery depends on the type of storage pool:
  - If data was moved from V8 DISK-type storage pools into a new storage pool, space that was occupied by the data that was moved was probably reused. Therefore, you must restore the original V8 storage pools by using the storage pool backups that were created before the upgrade to V8.1.2.  
  
If no data was moved from V8 DISK-type storage pools into a new storage pool, then audit the storage pool volumes in these DISK-type storage pools.
  - If data was moved from V8 sequential-access storage pools into a new storage pool, that data might still exist and be usable in storage pool volumes on the restored V8 server. The data might be usable if the REUSEDELAY parameter for the storage pool was set to a value that prevented reclamation while the server was running as a V8.1.2 server. If any volumes were reclaimed while the server was running as a V8.1.2 server, restore those volumes from storage pool backups that were created before the upgrade to V8.1.2.

## AIX: Reference: DB2 commands for IBM Spectrum Protect server databases

Use this list as reference when you are directed to issue DB2® commands by IBM® support.

### Purpose

After using the wizards to install and configure IBM Spectrum Protect™, you seldom need to issue DB2 commands. A limited set of DB2 commands that you might use or be asked to issue are listed in Table 1. This list is supplemental material only and is not a comprehensive list. There is no implication that an IBM Spectrum Protect administrator will use it on a daily or ongoing basis. Samples of some commands are provided. Details of output are not listed.

For a full explanation of the commands described here and of their syntax, see the DB2 product information.

Table 1. DB2 commands

Command	Description	Example
db2icrt	<p>Creates DB2 instances in the home directory of the instance owner.</p> <p>Tip: The IBM Spectrum Protect configuration wizard creates the instance used by the server and database. After a server is installed and configured through the configuration wizard, the db2icrt command is generally not used.</p> <p><b>AIX</b> This utility is in the DB2DIR/instance directory, where DB2DIR represents the installation location where the current version of the DB2 database system is installed.</p>	<p>Manually create an IBM Spectrum Protect instance. Enter the command on one line:</p> <pre>/opt/tivoli /tnsm/db2/in stance/ db2icrt -a server -u instance_na me instance_na me</pre>
db2set	Displays DB2 variables.	<p>List DB2 variables:</p> <pre>db2set</pre>

Command	Description	Example
CATALOG DATABASE	Stores database location information in the system database directory. The database can be located either on the local workstation or on a remote database partition server. The server configuration wizard takes care of any catalog needed for using the server database. Run this command manually, after a server is configured and running, only if something in the environment changes or is damaged.	Catalog the database:  db2 catalog database tsmdb1
CONNECT TO DATABASE	Connects to a specified database for command-line interface (CLI) use.	Connect to the IBM Spectrum Protect database from a DB2 CLI:  db2 connect to tsmdb1
GET DATABASE CONFIGURATION	Returns the values of individual entries in a specific database configuration file. Important: This command and parameters are set and managed directly by DB2. They are listed here for informational purposes and a means to view the existing settings. Changing these settings might be advised by IBM support or through service bulletins such as APARs or Technical Guidance documents (technotes). Do not change these settings manually. Change them only at the direction of IBM and only through the use of IBM Spectrum Protect server commands or procedures.	Show the configuration information for a database alias:  db2 get db cfg for tsmdb1  Retrieve information in order to verify settings such as database configuration, log mode, and maintenance.  db2 get db config for tsmdb1 show detail
GET DATABASE MANAGER CONFIGURATION	Returns the values of individual entries in a specific database configuration file. Important: This command and parameters are set and managed directly by DB2. They are listed here for informational purposes and a means to view the existing settings. Changing these settings might be advised by IBM support or through service bulletins such as APARs or Technical Guidance documents (technotes). Do not change these settings manually. Change them only at the direction of IBM and only through the use of IBM Spectrum Protect server commands or procedures.	Retrieve configuration information for the database manager:  db2 get dbm cfg
GET HEALTH SNAPSHOT	Retrieves the health status information for the database manager and its databases. The information returned represents a snapshot of the health state at the time the command was issued. IBM Spectrum Protect monitors the state of the database using the health snapshot and other mechanisms that are provided by DB2. There might be cases where the health snapshot or other DB2 documentation indicates that an item or database resource might be in an alert state. Such a case indicates that action must be considered to remedy the situation. IBM Spectrum Protect monitors the condition and responds appropriately. Not all declared alerts by the DB2 database are acted on.	Receive a report on DB2 health monitor indicators:  db2 get health snapshot for database on tsmdb1

Command	Description	Example
GRANT (Database Authorities)	Grants authorities that apply to the entire database rather than privileges that apply to specific objects within the database.	Grant access to the user ID itmuser:  db2 GRANT CONNECT ON DATABASE TO USER itmuser db2 GRANT CREATETAB ON DATABASE TO USER itmuser
RUNSTATS	Updates statistics about the characteristics of a table and associated indexes or statistical views. These characteristics include number of records, number of pages, and average record length.  To see a table, issue this utility after updating or reorganizing the table.  A view must be enabled for optimization before its statistics can be used to optimize a query. A view that is enabled for optimization is known as a statistical view. Use the DB2 ALTER VIEW statement to enable a view for optimization. Issue the RUNSTATS utility when changes to underlying tables substantially affect the rows returned by the view.  Tip: The server configures DB2 to run the RUNSTATS command as needed.	Update statistics on a single table.  db2 runstats on table SCHEMA_NAME .TABLE_NAME with distribution and sampled detailed indexes all
SET SCHEMA	Changes the value of the CURRENT SCHEMA special register, in preparation for issuing SQL commands directly through the DB2 CLI.  Tip: A special register is a storage area that is defined for an application process by the database manager. It is used to store information that can be referenced in SQL statements.	Set the schema for IBM Spectrum Protect:  db2 set schema tsmdb1
START DATABASE MANAGER	Starts the current database manager instance background processes. The server starts and stops the instance and database whenever the server starts and halts.  Important: Allow the server to manage the starting and stopping of the instance and database unless otherwise directed by IBM support.	Start the database manager:  db2start
STOP DATABASE MANAGER	Stops the current database manager instance. Unless explicitly stopped, the database manager continues to be active. This command does not stop the database manager instance if any applications are connected to databases. If there are no database connections, but there are instance attachments, the command forces the instance attachments to stop first. Then, it stops the database manager. This command also deactivates any outstanding database activations before stopping the database manager.  This command is not valid on a client.  The server starts and stops the instance and database whenever the server starts and halts.  Important: Allow the server to manage the starting and stopping of the instance and database unless otherwise directed by IBM support.	Stop the database manager:  db2 stop dbm

## AIX: Uninstalling IBM Spectrum Protect

You can use the following procedures to uninstall IBM Spectrum Protect™. Before you remove IBM Spectrum Protect, ensure that you do not lose your backup and archive data.

## Before you begin

---

Complete the following steps before you uninstall IBM Spectrum Protect:

- Complete a full database backup.
- Save a copy of the volume history and device configuration files.
- Store the output volumes in a safe location.

## About this task

---

You can uninstall IBM Spectrum Protect by using any of the following methods: a graphical wizard, the command line in console mode, or silent mode.

- **AIX: Uninstalling IBM Spectrum Protect by using a graphical wizard**  
You can uninstall IBM Spectrum Protect by using the IBM® Installation Manager installation wizard.
- **AIX: Uninstalling IBM Spectrum Protect in console mode**  
To uninstall IBM Spectrum Protect by using the command line, you must run the uninstallation program of IBM Installation Manager from the command line with the parameter for console mode.
- **AIX: Uninstalling IBM Spectrum Protect in silent mode**  
To uninstall IBM Spectrum Protect in silent mode, you must run the uninstallation program of IBM Installation Manager from the command line with the parameters for silent mode.
- **AIX: Uninstalling and reinstalling IBM Spectrum Protect**  
If you plan to manually reinstall IBM Spectrum Protect instead of using the wizard, there are a number of steps to take to preserve your server instance names and database directories. During an uninstallation, any server instances previously set up are removed, but the database catalogs for those instances still exist.
- **AIX: Uninstalling IBM Installation Manager**  
You can uninstall IBM Installation Manager if you no longer have any products that were installed by IBM Installation Manager.

## What to do next

---

See AIX: Installing the server components for installation steps to reinstall the IBM Spectrum Protect components.

## AIX: Uninstalling IBM Spectrum Protect by using a graphical wizard

---

You can uninstall IBM Spectrum Protect™ by using the IBM® Installation Manager installation wizard.

### Procedure

---

1. Start the Installation Manager.

**AIX** In the directory where the Installation Manager is installed, go to the eclipse subdirectory (for example, /opt/IBM/InstallationManager/eclipse), and issue the following command:

```
./IBMIM
```

2. Click Uninstall.
3. Select IBM Spectrum Protect server, and click Next.
4. Click Uninstall.
5. Click Finish.

## AIX: Uninstalling IBM Spectrum Protect in console mode

---

To uninstall IBM Spectrum Protect™ by using the command line, you must run the uninstallation program of IBM® Installation Manager from the command line with the parameter for console mode.

### Procedure

---

1. In the directory where IBM Installation Manager is installed, go to the following subdirectory:
  - o **AIX** eclipse/tools

For example:

- o `AIX` /opt/IBM/InstallationManager/eclipse/tools
2. From the tools directory, issue the following command:
    - o `AIX` `./imcl -c`
  3. To uninstall, enter 5.
  4. Choose to uninstall from the IBM Spectrum Protect package group.
  5. Enter N for Next.
  6. Choose to uninstall the IBM Spectrum Protect server package.
  7. Enter N for Next.
  8. Enter U for Uninstall.
  9. Enter F for Finish.

## AIX: Uninstalling IBM Spectrum Protect in silent mode

---

To uninstall IBM Spectrum Protect™ in silent mode, you must run the uninstallation program of IBM® Installation Manager from the command line with the parameters for silent mode.

### Before you begin

---

You can use a response file to provide data input to silently uninstall the IBM Spectrum Protect server components. IBM Spectrum Protect includes a sample response file, `uninstall_response_sample.xml`, in the input directory where the installation package is extracted. This file contains default values to help you avoid any unnecessary warnings.

If you want to uninstall all IBM Spectrum Protect components, leave `modify="false"` set for each component in the response file. If you do not want to uninstall a component, set the value to `modify="true"`.

If you want to customize the response file, you can modify the options that are in the file. For information about response files, see Response files.

### Procedure

---

1. In the directory where IBM Installation Manager is installed, go to the following subdirectory:
  - o `AIX` `eclipse/tools`

For example:

- o `AIX` /opt/IBM/InstallationManager/eclipse/tools
2. From the tools directory, issue the following command, where `response_file` represents the response file path, including the file name:

```
AIX
./imcl -input response_file -silent
```

The following command is an example:

```
AIX
./imcl -input /tmp/input/uninstall_response.xml -silent
```

## AIX: Uninstalling and reinstalling IBM Spectrum Protect

---

If you plan to manually reinstall IBM Spectrum Protect™ instead of using the wizard, there are a number of steps to take to preserve your server instance names and database directories. During an uninstallation, any server instances previously set up are removed, but the database catalogs for those instances still exist.

### About this task

---

To manually uninstall and reinstall IBM Spectrum Protect, complete the following steps:

1. `AIX` Make a list of your current server instances before proceeding to the uninstallation. Run the following command:

```
/opt/tivoli/tsm/db2/instance/db2ilist
```

2. Run the following commands for every server instance:

```
AIX
```



```
db2 attach to instance_name
db2 get dbm cfg show detail
db2 detach
```

Keep a record of the database path for each instance.

3. Uninstall IBM Spectrum Protect. See AIX: Uninstalling IBM Spectrum Protect.
4. When you uninstall any supported version of IBM Spectrum Protect, including a fix pack, an instance file is created. The instance file is created to help reinstall IBM Spectrum Protect. Check this file and use the information when you are prompted for the instance credentials when reinstalling. In silent installation mode, you provide these credentials using the `INSTANCE_CRED` variable.

You can find the instance file in the following location:

- o `AIX` /etc/tivoli/tsm/instanceList.obj

5. Reinstall IBM Spectrum Protect. See AIX: Installing the server components.

If the `instanceList.obj` file does not exist, you need to recreate your server instances using the following steps:

- a. Recreate your server instances. See AIX: Creating the server instance.

Tip: The installation wizard configures the server instances but you must verify that they exist. If they do not exist, you must manually configure them.

- b. Catalog the database. Log in to each server instance as the instance user, one at a time, and issue the following commands:

`AIX`

```
db2 catalog database tsmdb1
db2 attach to instance_name
db2 update dbm cfg using dftdbpath instance_directory
db2 detach
```

- c. `AIX` Verify that the server instance was created successfully. Issue this command:

```
/opt/tivoli/tsm/db2/instance/db2ilist
```

- d. Verify that IBM Spectrum Protect recognizes the server instance by listing your directories. Your home directory appears if you did not change it. Your instance directory does appear if you used the configuration wizard. Issue this command:

```
db2 list database directory
```

If you see TSMDB1 listed, you can start the server.

## AIX: Uninstalling IBM Installation Manager

---

You can uninstall IBM® Installation Manager if you no longer have any products that were installed by IBM Installation Manager.

### Before you begin

---

Before you uninstall IBM Installation Manager, you must ensure that all packages that were installed by IBM Installation Manager are uninstalled. Close IBM Installation Manager before you start the uninstall process.

`AIX` To view installed packages, issue the following command from a command line:

```
cd /opt/IBM/InstallationManager/eclipse/tools
./imcl listInstalledPackages
```

### Procedure

---

To uninstall IBM Installation Manager, complete the following steps:

`AIX`

1. Open a command line and change directories to `/var/ibm/InstallationManager/uninstall`.
2. Issue the following command:

```
./uninstall
```

Restriction: You must be logged in to the system as the `root` user ID.

## Linux: Installing the server

---

Installation of the server includes planning, installation, and initial configuration.

- **Linux: Planning to install the server**  
Install the server software on the computer that manages storage devices and install the client software on every workstation that transfers data to IBM Spectrum Protect™ server-managed storage.
- **Linux: Installing the server components**  
To install the Version 8.1.2 server components, you can use the installation wizard, the command line in console mode, or silent mode.
- **Linux: Taking the first steps after you install IBM Spectrum Protect**  
After you install Version 8.1.2, prepare for the configuration. Using the configuration wizard is the preferred method of configuring the IBM Spectrum Protect instance.
- **Linux: Installing an IBM Spectrum Protect server fix pack**  
IBM Spectrum Protect maintenance updates, which are also referred to as fix packs, bring your server up to the current maintenance level.
- **Linux: Reverting from Version 8.1.2 to a previous server**  
If you must revert to the previous version of the server after an upgrade, you must have a full database backup from your original version. You must also have the server installation media for your original version and key configuration files. Carefully follow the preparation steps before you upgrade the server. By doing so, it might be possible to revert to the previous version of the IBM Spectrum Protect server with minimal loss of data.
- **Linux: Reference: DB2 commands for IBM Spectrum Protect server databases**  
Use this list as reference when you are directed to issue DB2® commands by IBM® support.
- **Linux: Uninstalling IBM Spectrum Protect**  
You can use the following procedures to uninstall IBM Spectrum Protect. Before you remove IBM Spectrum Protect, ensure that you do not lose your backup and archive data.

## Linux: Planning to install the server

---

Install the server software on the computer that manages storage devices and install the client software on every workstation that transfers data to IBM Spectrum Protect™ server-managed storage.

- **Linux: What you should know first**  
Before installing IBM Spectrum Protect, be familiar with your operating systems, storage devices, communication protocols, and system configurations.
- **Linux: What you should know about security before you install or upgrade the server**  
Before you install IBM Spectrum Protect V8.1.2 or later, review information about the enhanced security features and the requirements for updating your environment.
- **Linux: Planning for optimal performance**  
Before you install the IBM Spectrum Protect server, evaluate the characteristics and configuration of the system to ensure that the server is set up for optimal performance.
- **Linux** Linux: Minimum system requirements for Linux systems  
To install the IBM Spectrum Protect server on a Linux system, it is necessary to have a minimum level of hardware and software, including a communication method and the most current device driver.
- **Linux** Linux: Compatibility of the IBM Spectrum Protect server with other DB2 products on the system  
You can install other products that deploy and use DB2® products on the same system as the IBM Spectrum Protect Version 8.1.2 server, with some limitations.
- **Linux: IBM Installation Manager**  
IBM Spectrum Protect uses IBM® Installation Manager, which is an installation program that can use remote or local software repositories to install or update many IBM products.
- **Linux: Worksheets for planning details for the server**  
You can use the worksheets to help you plan the amount and location of storage needed for the IBM Spectrum Protect server. You can also use them to keep track of names and user IDs.
- **Linux: Capacity planning**  
Capacity planning for IBM Spectrum Protect includes managing resources such as the database, the recovery log and the shared resource area. To maximize resources as part of capacity planning, you must estimate space requirements for the database and the recovery log. The shared resource area must have enough space available for each installation or upgrade.
- **Linux: Server naming best practices**  
Use these descriptions as a reference when you install or upgrade an IBM Spectrum Protect server.

- Linux: Installation directories  
Installation directories for the IBM Spectrum Protect server include the server, DB2, device, language, and other directories. Each one contains several additional directories.

## Linux: What you should know first

---

Before installing IBM Spectrum Protect™, be familiar with your operating systems, storage devices, communication protocols, and system configurations.

Server maintenance releases, client software, and publications are available from the IBM® Support Portal.

**Linux** Restriction: You can install and run the Version 8.1.2 server on a system that already has DB2® installed on it, whether DB2 was installed independently or as part of some other application, with some restrictions. For details, see the compatibility with other DB2 products topic.

Experienced DB2 administrators can choose to perform advanced SQL queries and use DB2 tools to monitor the database. Do not, however, use DB2 tools to change DB2 configuration settings from those that are preset by IBM Spectrum Protect, or alter the DB2 environment for IBM Spectrum Protect in other ways, such as with other products. The V8.1.2 server has been built and tested extensively using the data definition language (DDL) and database configuration that the server deploys.

Attention: Do not alter the DB2 software that is installed with IBM Spectrum Protect installation packages and fix packs. Do not install or upgrade to a different version, release, or fix pack of DB2 software because doing so can damage the database.

## Linux: What you should know about security before you install or upgrade the server

---

Before you install IBM Spectrum Protect™ V8.1.2 or later, review information about the enhanced security features and the requirements for updating your environment.

### About this task

---

Security enhancements that were introduced in V8.1.2 and later enforce stricter security settings. To ensure that communication between servers and clients is not interrupted when you install or upgrade IBM Spectrum Protect software to V8.1.2, follow the procedure.

### Procedure

---

1. Install or upgrade the IBM Spectrum Protect servers to 8.1.2 or later.
2. Install or upgrade the backup-archive clients. For more information, see *Installing and configuring clients*.  
For information about scheduling deployment of client updates from the server, see the following documents:
  - For IBM Spectrum Protect 8.1.2 or later servers, see technote 2004596.
  - For IBM® Tivoli® Storage Manager V7.1 servers and IBM Spectrum Protect V8.1.0 and V8.1.1 servers, see technote 1673299.
3. Configure the options for backup-archive clients. For more information, see *Upgrading the IBM Spectrum Protect Server and the IBM Spectrum Protect Client*.

## Linux: Planning for optimal performance

---

Before you install the IBM Spectrum Protect™ server, evaluate the characteristics and configuration of the system to ensure that the server is set up for optimal performance.

### Procedure

---

1. Review Linux: What you should know first.
2. Review each of the following sub-sections.
  - Linux: Planning for the server hardware and the operating system  
Use the checklist to verify that the system where the server is installed meets requirements for hardware and software configuration.

- Linux: Planning for the server database disks  
Use the checklist to verify that the system where the server is installed meets requirements for hardware and software configuration.
- Linux: Planning for the server recovery log disks  
Use the checklist to verify that the system where the server is installed meets requirements for hardware and software configuration.
- Linux: Planning for directory-container and cloud-container storage pools  
Review how your directory-container and cloud-container storage pools are set up to ensure optimal performance.
- Linux: Planning for storage pools in DISK or FILE device classes  
Use the checklist to review how your disk storage pools are set up. This checklist includes tips for storage pools that use DISK or FILE device classes.
- Linux: Planning for the correct type of storage technology  
Storage devices have different capacity and performance characteristics. These characteristics affect which devices are better for use with IBM Spectrum Protect.
- Linux: Applying best practices to the server installation  
Typically, hardware configuration and selection have the most significant effect on the performance of an IBM Spectrum Protect solution. Other factors that affect performance are the operating system selection and configuration, and the configuration of IBM Spectrum Protect.

## Linux: Planning for the server hardware and the operating system

Use the checklist to verify that the system where the server is installed meets requirements for hardware and software configuration.

Question	Tasks, characteristics, options, or settings	More information
<p>Does the operating system and hardware meet or exceed requirements?</p> <ul style="list-style-type: none"> <li>• Number and speed of processors</li> <li>• System memory</li> <li>• Supported operating system level</li> </ul>	<p>If you are using the minimum required amount of memory, you can support a minimal workload.</p> <p>You can experiment by adding more system memory to determine whether the performance is improved. Then, decide whether you want to keep the system memory dedicated to the server. Test the memory variations by using the entire daily cycle of the server workload.</p> <p>If you run multiple servers on the system, add the requirements for each server to get the requirements for the system.</p>	<p>Review operating system requirements at technote 1243309.</p> <p>Additionally, review the guidance in Tuning tasks for operating systems and other applications.</p> <p>For more information about requirements when these features are in use, see the following topics:</p> <ul style="list-style-type: none"> <li>• Checklist for data deduplication</li> <li>• Checklist for node replication</li> </ul> <p>For more information about sizing requirements for the server and storage, see the IBM Spectrum Protect™ Blueprint.</p>
<p>Are disks configured for optimal performance?</p>	<p>The amount of tuning that can be done for different disk systems varies. Ensure that the appropriate queue depths and other disk system options are set.</p>	<p>For more information, see the following topics:</p> <ul style="list-style-type: none"> <li>• "Planning for server database disks"</li> <li>• "Planning for server recovery log disks"</li> <li>• "Planning for storage pools in DISK or FILE device classes"</li> </ul>

Question	Tasks, characteristics, options, or settings	More information
Does the server have enough memory?	<p>Heavier workloads and advanced features such as data deduplication and node replication require more than the minimum system memory that is specified in the system requirements document.</p> <p>For databases that are not enabled for data deduplication, use the following guidelines to specify memory requirements:</p> <ul style="list-style-type: none"> <li>• For databases less than 500 GB, you need 16 GB of memory.</li> <li>• For databases with a size of 500 GB - 1 TB, you need 24 GB of memory.</li> <li>• For databases with a size of 1 TB - 1.5 TB, you need 32 GB of memory.</li> <li>• For databases greater than 1.5 TB, you need 40 GB of memory.</li> </ul> <p>Ensure that you allocate extra space for the active log and the archive log for replication processing.</p>	<p>For more information about requirements when these features are in use, see the following topics:</p> <ul style="list-style-type: none"> <li>• Checklist for data deduplication</li> <li>• Checklist for node replication</li> <li>• Memory requirements</li> </ul>
Does the system have enough host bus adapters (HBAs) to handle the data operations that the IBM Spectrum Protect server must run simultaneously?	<p>Understand what operations require use of HBAs at the same time.</p> <p>For example, a server must store 1 GB/sec of backup data while also doing storage pool migration that requires 0.5 GB/sec capacity to complete. The HBAs must be able to handle all of the data at the speed required.</p>	See Tuning HBA capacity.
Is network bandwidth greater than the planned maximum throughput for backups?	<p>Network bandwidth must allow the system to complete operations such as backups in the time that is allowed or that meets service level commitments.</p> <p>For node replication, network bandwidth must be greater than the planned maximum throughput.</p>	<p>For more information, see the following topics:</p> <ul style="list-style-type: none"> <li>• Tuning network performance</li> <li>• Checklist for node replication</li> </ul>

Question	Tasks, characteristics, options, or settings	More information
<p>Are you using a preferred file system for IBM Spectrum Protect server files?</p>	<p>Use a file system that ensures optimal performance and data availability. The server uses direct I/O with file systems that support the feature. Using direct I/O can improve throughput and reduce processor use. The following list identifies the preferred file system:</p> <ul style="list-style-type: none"> <li>• <b>Linux</b> Use either the ext3, ext4, or xfs file system for the database, recovery log, and storage pool data. Use the following file system that is appropriate for your operating system and level: <ul style="list-style-type: none"> <li>◦ For Red Hat Enterprise Linux x86_64, use the ext3, ext4, or xfs file system. If Red Hat Enterprise Linux 6.4 or later is installed, use the ext4 or xfs file system.</li> <li>◦ For SUSE Linux Enterprise Server and for Red Hat Enterprise Linux ppc64, use the ext3 or xfs file system. Using xfs on SUSE Linux Enterprise Server 12 requires kernel-default-3.12.32-33.1.x86_64.rpm or later.</li> </ul> </li> </ul>	<p>For more information, see Configuring the operating system for disk performance.</p>

Question	Tasks, characteristics, options, or settings	More information
Are you planning to configure enough paging space?	<p>Paging space, or swap space, extends the memory that is available for processing. When the amount of free RAM in the system is low, programs or data that is not in use are moved from memory to paging space. This action releases memory for other activities, such as database operations.</p> <p><b>Linux</b> Use a minimum of 32 GB of paging space or 50% of your RAM, whichever value is larger.</p>	
<b>Linux</b> Are you planning to tune the kernel parameters after installation of the server?	<b>Linux</b> You must tune kernel parameters.	<b>Linux</b> See the information about tuning kernel parameters: Linux: Tuning kernel parameters for Linux systems

## Linux: Planning for the server database disks

Use the checklist to verify that the system where the server is installed meets requirements for hardware and software configuration.

Question	Tasks, characteristics, options, or settings	More information
Is the database on fast, low-latency disks?	<p>Do not use the following drives for the IBM Spectrum Protect™ database:</p> <ul style="list-style-type: none"> <li>• Nearline SAS (NL-SAS)</li> <li>• Serial Advanced Technology Attachment (SATA)</li> <li>• Parallel Advanced Technology Attachment (PATA)</li> </ul> <p>Do not use internal disks that are included by default in most server hardware.</p> <p>Enterprise-grade solid-state disks (SSD), with Fibre Channel or SAS interface, offer the best performance.</p> <p>If you plan to use the data deduplication functions of IBM Spectrum Protect, focus on disk performance in terms of I/O operations per second (IOPS).</p>	For more information, see Checklist for data deduplication.

Question	Tasks, characteristics, options, or settings	More information
<p>Is the database stored on disks or LUNs that are separate from disks or LUNs that are used for the active log, archive log, and storage pool volumes?</p>	<p>Separation of the server database from other server components helps reduce contention for the same resources by different operations that must run at the same time.</p> <p>Tip: The database and the archive log can share an array when you use solid-state drive (SSD) technology.</p>	
<p>If you are using RAID, do you know how to select the optimal RAID level for your system? Are you defining all LUNs with the same size and type of RAID?</p>	<p>When a system must do large numbers of writes, RAID 10 outperforms RAID 5. However, RAID 10 requires more disks than RAID 5 for the same amount of usable storage.</p> <p>If your disk system is RAID, define all your LUNs with the same size and type of RAID. For example, do not mix 4+1 RAID 5 with 4+2 RAID 6.</p>	
<p>If an option to set the strip size or segment size is available, are you planning to optimize the size when you configure the disk system?</p>	<p>If you can set the strip size or segment size, use 64 KB or 128 KB sizes on disk systems for the database.</p>	<p>The block size that is used for the database varies depending on the table space. Most table spaces use 8 KB blocks, but some use 32 KB blocks.</p>
<p>Are you planning to create at least four directories, also called storage paths, on four separate LUNs for the database?</p> <p>Create one directory per distinct array on the subsystem. If you have fewer than three arrays, create a separate LUN volume within the array.</p>	<p>Heavier workloads and use of some features require more database storage paths than the minimum requirements.</p> <p>Server operations such as data deduplication drive a high number of input/output operations per second (IOPS) for the database. Such operations perform better when the database has more directories.</p> <p>For server databases that are larger than 2 TB or are expected to grow to that size, use eight directories.</p> <p>Consider planned growth of the system when you determine how many storage paths to create. The server uses the higher number of storage paths more effectively if the storage paths are present when the server is first created.</p> <p>Use the <i>DB2_PARALLEL_IO</i> variable to force parallel I/O to occur on table spaces that have one container, or on table spaces that have containers on more than one physical disk. If you do not set the <i>DB2_PARALLEL_IO</i> variable, I/O parallelism is equal to the number of containers that are used by the table space. For example, if a table space spans four containers, the level of I/O parallelism that is used is 4.</p>	<p>For more information, see the following topics:</p> <ul style="list-style-type: none"> <li>• Checklist for data deduplication</li> <li>• Checklist for node replication</li> </ul> <p>For help with forecasting growth when the server deduplicates data, see technote 1596944.</p> <p>For the most recent information about database size, database reorganization, and performance considerations for IBM Spectrum Protect servers, see technote 1683633.</p> <p>For information about setting the <i>DB2_PARALLEL_IO</i> variable, see Recommended settings for IBM DB2 registry variables.</p>



Question	Tasks, characteristics, options, or settings	More information
Are all directories for the database the same size?	Directories that are all the same size ensure a consistent degree of parallelism for database operations. If one or more directories for the database are smaller than the others, they reduce the potential for optimized parallel prefetching.  This guideline also applies if you must add storage paths after the initial configuration of the server.	
Are you planning to raise the queue depth of the database LUNs on AIX® systems?	The default queue depth is often too low.	See Configuring AIX systems for disk performance.

## Linux: Planning for the server recovery log disks

Use the checklist to verify that the system where the server is installed meets requirements for hardware and software configuration.

Question	Tasks, characteristics, options, or settings	More information
Are the active log and archive log stored on disks or LUNs that are separate from what is used for the database and storage pool volumes?	Ensure that the disks where you place the active log are not used for other server or system purposes. Do not place the active log on disks that contain the server database, the archive log, or system files such as page or swap space.	Separation of the server database, active log, and archive log helps to reduce contention for the same resources by different operations that must run at the same time.
Are the logs on disks that have nonvolatile write cache?	Nonvolatile write cache allows data to be written to the logs as fast as possible. Faster write operations for the logs can improve performance for server operations.	
Are you setting the logs to a size that adequately supports the workload?	If you are not sure about the workload, use the largest size that you can.  Active log The maximum size is 512 GB, set with the ACTIVELOGSIZE server option.  Ensure that there is at least 8 GB of free space on the active log file system after the fixed size active logs are created.  Archive log The size of the archive log is limited by the size of the file system on which it is located, and not by a server option. Make the archive log at least as large as the active log.	<ul style="list-style-type: none"> <li>For log sizing details, see the recovery log information in technote 1421060.</li> <li>For information about sizing when you use data deduplication, see Checklist for data deduplication.</li> </ul>
Are you defining an archive failover log? Are you placing this log on a disk that is separate from the archive log?	The archive failover log is for emergency use by the server when the archive log becomes full. Slower disks can be used for the archive failover log.	Use the ARCHFAILOVERLOGDIRECTORY server option to specify the location of the archive failover log.  Monitor the usage of the directory for the archive failover log. If the archive failover log must be used by the server, the space for the archive log might not be large enough.

Question	Tasks, characteristics, options, or settings	More information
If you are mirroring the active log, are you using only one type of mirroring?	<p>You can mirror the log by using one of the following methods. Use only one type of mirroring for the log.</p> <ul style="list-style-type: none"> <li>• Use the MIRRORLOGDIRECTORY option that is available for the IBM Spectrum Protect™ server to specify a mirror location.</li> <li>• Use software mirroring, such as Logical Volume Manager (LVM) on AIX®.</li> <li>• Use mirroring in the disk system hardware.</li> </ul>	<p>If you mirror the active log, ensure that the disks for both the active log and the mirror copy have equal speed and reliability.</p> <p>For more information, see Configuring and tuning the recovery log.</p>

## Linux: Planning for directory-container and cloud-container storage pools

---

Review how your directory-container and cloud-container storage pools are set up to ensure optimal performance.

Question	Tasks, characteristics, options, or settings	More information
Measured in terms of input/output operations per second (IOPS), are you using fast disk storage for the IBM Spectrum Protect™ database?	<p>Use a high-performance disk for the database. Use solid-state drive technology for data deduplication processing.</p> <p>Ensure that the database has a minimum capability of 3000 IOPS. For each TB of data that is backed up daily (before data deduplication), add 1000 IOPS to this minimum.</p> <p>For example, an IBM Spectrum Protect server that is ingesting 3 TB of data per day would need 6000 IOPS for the database disks:</p> $3000 \text{ IOPS minimum} + 3000 (3 \text{ TB} \times 1000 \text{ IOPS}) = 6000 \text{ IOPS}$	<p>For recommendations about disk selection, see "Planning for server database disks".</p> <p>For more information about IOPS, see the IBM Spectrum Protect Blueprints.</p>

Question	Tasks, characteristics, options, or settings	More information
<p>Do you have enough memory for the size of your database?</p>	<p>Use a minimum of 40 GB of system memory for IBM Spectrum Protect servers, with a database size of 100 GB, that are deduplicating data. If the retained capacity of backup data grows, the memory requirement might need to be higher.</p> <p>Monitor memory usage regularly to determine whether more memory is required.</p> <p>Use more system memory to improve caching of database pages. The following memory size guidelines are based on the daily amount of new data that you back up:</p> <ul style="list-style-type: none"> <li>• 128 GB of system memory for daily backups of data, where the database size is 1 - 2 TB</li> <li>• 192 GB of system memory for daily backups of data, where the database size is 2 - 4 TB</li> </ul>	<p>Memory requirements</p>
<p>Have you properly sized the storage capacity for the database active log and archive log?</p>	<p>Configure the server to have a minimum active log size of 128 GB by setting the ACTIVELOGSIZE server option to a value of 131072.</p> <p>The suggested starting size for the archive log is 1 TB. The size of the archive log is limited by the size of the file system on which it is located, and not by a server option. Ensure that there is at least 10% extra disk space for the file system than the size of the archive log.</p> <p>Use a directory for the database archive logs with an initial free capacity of at least 1 TB. Specify the directory by using the ARCHLOGDIRECTORY server option.</p> <p>Define space for the archive failover log by using the ARCHFAILOVERLOGDIRECTORY server option.</p>	<p>For more information about sizing for your system, see the IBM Spectrum Protect Blueprints.</p>
<p>Is compression enabled for the archive log and database backups?</p>	<p>Enable the ARCHLOGCOMPRESS server option to save storage space.</p> <p>This compression option is different from inline compression. Inline compression is enabled by default with IBM Spectrum Protect V7.1.5 and later.</p> <p>Restriction: Do not use this option if the amount of backed up data exceeds 6 TB per day.</p>	<p>For more information about compression for your system, see the IBM Spectrum Protect Blueprints.</p>

Question	Tasks, characteristics, options, or settings	More information
<p>Are the IBM Spectrum Protect database and logs on separate disk volumes (LUNs)?</p> <p>Is the disk that is used for the database configured according to best practices for a transactional database?</p>	<p>The database must not share disk volumes with IBM Spectrum Protect database logs or storage pools, or with any other application or file system.</p>	<p>For more information about server database and recovery log configuration, see Server database and recovery log configuration and tuning.</p>
<p>Are you using a minimum of eight (2.2 GHz or equivalent) processor cores for each IBM Spectrum Protect server that you plan to use with data deduplication?</p>	<p>If you are planning to use client-side data deduplication, verify that client systems have adequate resources available during a backup operation to complete data deduplication processing. Use a processor that is at least the minimum equivalent of one 2.2 GHz processor core per backup process with client-side data deduplication.</p>	<ul style="list-style-type: none"> <li>• Effective planning and use of deduplication</li> <li>• IBM Spectrum Protect Blueprints</li> </ul>
<p>Did you allocate enough storage space for the database?</p>	<p>For a rough estimate, plan for 100 GB of database storage for every 50 TB of data that is to be protected in deduplicated storage pools. <i>Protected data</i> is the amount of data before data deduplication, including all versions of objects stored.</p> <p>As a best practice, define a new container storage pool exclusively for data deduplication. Data deduplication occurs at the storage-pool level, and all data within a storage pool, except encrypted data, is deduplicated.</p>	
<p>Have you estimated storage pool capacity to configure enough space for the size of your environment?</p>	<p>You can estimate capacity requirements for a deduplicated storage pool by using the following technique:</p> <ol style="list-style-type: none"> <li>1. Estimate the base size of the source data.</li> <li>2. Estimate the daily backup size by using an estimated change and growth rate.</li> <li>3. Determine retention requirements.</li> <li>4. Estimate the total amount of source data by factoring in the base size, daily backup size, and retention requirements.</li> <li>5. Apply the deduplication ratio factor.</li> <li>6. Apply the compression ratio factor.</li> <li>7. Round up the estimate to consider transient storage pool usage.</li> </ol>	<p>For an example of using this technique, see Effective planning and use of deduplication.</p>

Question	Tasks, characteristics, options, or settings	More information
Have you distributed disk I/O over many disk devices and controllers?	<p>Use arrays that consist of as many disks as possible, which is sometimes referred to as wide striping. Ensure that you use one database directory per distinct array on the subsystem.</p> <p>Set the <i>DB2_PARALLEL_IO</i> registry variable to enable parallel I/O for each table space used if the containers in the table space span multiple physical disks.</p> <p>When I/O bandwidth is available and the files are large, for example 1 MB, the process of finding duplicates can occupy the resources of an entire processor. When files are smaller, other bottlenecks can occur.</p> <p>Specify eight or more file systems for the deduplicated storage pool device class so that I/O is distributed across as many LUNs and physical devices as possible.</p>	<p>For guidelines about setting up storage pools, see "Planning for storage pools in DISK or FILE device classes".</p> <p>For information about setting the <i>DB2_PARALLEL_IO</i> variable, see Recommended settings for IBM DB2 registry variables.</p>
Have you scheduled daily operations based on your backup strategy?	<p>The best practice sequence of operations is in the following order:</p> <ol style="list-style-type: none"> <li>1. Client backup</li> <li>2. Storage pool protection</li> <li>3. Node replication</li> <li>4. Database backup</li> <li>5. Expire inventory</li> </ol>	<ul style="list-style-type: none"> <li>• Scheduling data deduplication and node replication processes</li> <li>• Daily operations for directory-container storage pools</li> </ul>
Do you have enough storage to manage the DB2® lock list?	<p>If you deduplicate data that includes large files or large numbers of files concurrently, the process can result in insufficient storage space. When the lock list storage is insufficient, backup failures, data management process failures, or server outages can occur.</p> <p>File sizes greater than 500 GB that are processed by data deduplication are most likely to deplete storage space. However, if many backup operations use client-side data deduplication, this problem can also occur with smaller-sized files.</p>	<p>For information about tuning the DB2 LOCKLIST parameter, see Tuning server-side data deduplication.</p>
Is sufficient bandwidth available to transfer data to an IBM Spectrum Protect server?	<p>To transfer data to an IBM Spectrum Protect server, use client-side or server-side data deduplication and compression to reduce the bandwidth that is required.</p> <p>Use a V7.1.5 server or higher to use inline compression and use a V7.1.6 or later client to enable enhanced compression processing.</p>	<p>For more information, see the <code>enablededup</code> client option.</p>

Question	Tasks, characteristics, options, or settings	More information
<p>Have you determined how many storage pool directories to assign to each storage pool?</p>	<p>Assign directories to a storage pool by using the DEFINE STGPOOLDIRECTORY command.</p> <p>Create multiple storage pool directories and ensure that each directory is backed up to a separate disk volume (LUN).</p>	
<p>Did you allocate enough disk space in the cloud-container storage pool?</p>	<p>To prevent backup failures, ensure that the local directory has enough space. Use the following list as a guide for optimal disk space:</p> <ul style="list-style-type: none"> <li>• For serial-attached SCSI (SAS) and spinning disk, calculate the amount of new data that is expected after daily data reduction (compression and data deduplication). Allocate up to 100 percent of that amount, in terabytes, for disk space.</li> <li>• Provide 3 TB for flash-based storage systems with fast network connections to on-premises, high-performance cloud systems.</li> <li>• Provide 5 TB for solid-state drive (SSD) systems with fast network connections to high-performance cloud systems.</li> </ul>	

Question	Tasks, characteristics, options, or settings	More information
<p>Did you select the appropriate type of local storage?</p>	<p>Ensure that data transfers from local storage to cloud finish before the next backup cycle starts.            Tip: Data is removed from local storage soon after it moves to the cloud.            Use the following guidelines:</p> <ul style="list-style-type: none"> <li>• Use flash or SSD for large systems that have high-performing cloud systems. Ensure that you have a dedicated 10 GB wide area network (WAN) link with a high-speed connection to the object storage. For example, use flash or SSD if you have a dedicated 10 GB WAN link plus a high-speed connection to either an IBM® Cloud Object Storage location or to an Amazon Simple Storage Service (Amazon S3) data center.</li> <li>• Use larger capacity 15000 rpm SAS disks for these scenarios:               <ul style="list-style-type: none"> <li>◦ Medium-sized systems</li> <li>◦ Slower cloud connections, for example, 1 GB</li> <li>◦ When you use IBM Cloud Object Storage as your service provider across several regions</li> </ul> </li> <li>• For SAS or spinning disk, calculate the amount of new data that is expected after daily data reduction (compression and data deduplication). Allocate up to 100 percent of that amount for disk space, in terabytes.</li> </ul>	

## Linux: Planning for storage pools in DISK or FILE device classes

Use the checklist to review how your disk storage pools are set up. This checklist includes tips for storage pools that use DISK or FILE device classes.

Question	Tasks, characteristics, options, or settings	More information
----------	--	------------------

Question	Tasks, characteristics, options, or settings	More information
Can the storage pool LUNs sustain throughput rates for 256 KB sequential reads and writes to adequately handle the workload within the time constraints?	<p>When you are planning for peak loads, consider all the data that you want the server to read or write to the disk storage pools simultaneously. For example, consider the peak flow of data from client backup operations and server data-movement operations such as migration that run at the same time.</p> <p>The IBM Spectrum Protect™ server reads and writes to storage pools predominantly in 256 KB blocks.</p> <p>If the disk system includes the capability, configure the disk system for optimal performance with sequential read/write operations rather than random read/write operations.</p>	For more information, see Analyzing the basic performance of disk systems.
Is the disk configured to use read and write cache?	Use more cache for better performance.	
For storage pools that use FILE device classes, have you determined a good size to use for the storage pool volumes?	Review the information in Optimal number and size of volumes for storage pools that use disk. If you do not have the information to estimate a size for FILE device class volumes, start with volumes that are 50 GB.	Typically, problems arise more frequently when the volumes are too small. Few problems are reported when volumes are larger than needed. When you determine the volume size to use, as a precaution choose a size that might be larger than necessary.
For storage pools that use FILE device classes, are you using preallocated volumes?	<p>Scratch volumes can cause file fragmentation.</p> <p>To ensure that a storage pool does not run out of volumes, set the MAXSCRATCH parameter to a value greater than zero.</p>	<p>Use the DEFINE VOLUME server command to preallocate volumes in the storage pool.</p> <p>Use the DEFINE STGPOOL or UPDATE STGPOOL server command to set the MAXSCRATCH parameter.</p>
For storage pools that use FILE device classes, have you compared the maximum number of client sessions to the number of volumes that are defined?	Always maintain enough usable volumes in the storage pools to allow for the expected peak number of client sessions that run at one time. The volumes might be scratch volumes, empty volumes, or partly filled volumes.	For storage pools that use FILE device classes, only one session or process can write to a volume at the same time.



Question	Tasks, characteristics, options, or settings	More information
For storage pools that use FILE device classes, have you set the MOUNTLIMIT parameter of the device class to a value that is high enough to account for the number of volumes that might be mounted in parallel?	<p>For storage pools that use data deduplication, the MOUNTLIMIT parameter is typically in the range of 500 - 1000.</p> <p>Set the value for MOUNTLIMIT to the maximum number of mount points that are needed for all active sessions. Consider parameters that affect the maximum number of mount points that are needed:</p> <ul style="list-style-type: none"> <li>• The MAXSESSIONS server option, which is the maximum number of IBM Spectrum Protect sessions that can run concurrently.</li> <li>• The MAXNUMMP parameter, which sets the maximum number of mount points that each client node can use.</li> </ul> <p>For example, if the maximum number of client node backup sessions is typically 100 and each of the nodes has MAXNUMMP=2, multiply 100 nodes by the 2 mount points for each node to get the value of 200 for the MOUNTLIMIT parameter.</p>	Use the REGISTER NODE or UPDATE NODE server command to set the MAXNUMMP parameter for client nodes.
For storage pools that use DISK device classes, have you determined how many storage pool volumes to put on each file system?	<p>How you configure the storage for a storage pool that uses a DISK device class depends on whether you are using RAID for the disk system.</p> <p>If you are not using RAID, then configure one file system per physical disk, and define one storage pool volume for each file system.</p> <p>If you are using RAID 5 with <math>n + 1</math> volumes, configure the storage in one of the following ways:</p> <ul style="list-style-type: none"> <li>• Configure <math>n</math> file systems on the LUN and define one storage pool volume per file system.</li> <li>• Configure one file system and <math>n</math> storage pool volumes for the LUN.</li> </ul>	For an example layout that follows this guideline, see Sample layout of server storage pools.
Did you create your storage pools to distribute I/O across multiple file systems?	<p>Ensure that each file system is on a different LUN on the disk system.</p> <p>Typically, having 10 - 30 file systems is a good goal, but ensure that the file systems are no smaller than approximately 250 GB.</p>	<p>For details, see the following topics:</p> <ul style="list-style-type: none"> <li>• Tuning disk storage for the server</li> <li>• Tuning and configuring storage pools and volumes</li> </ul>

## Linux: Planning for the correct type of storage technology

Storage devices have different capacity and performance characteristics. These characteristics affect which devices are better for use with IBM Spectrum Protect™.

### Procedure

Review the following table to help you to choose the correct type of storage technology for the storage resources that the server requires.

Table 1. Storage technology types for IBM Spectrum Protect storage requirements

Storage technology type	Database	Active log	Archive log and archive failover log	Storage pools

<b>Storage technology type</b>	<b>Database</b>	<b>Active log</b>	<b>Archive log and archive failover log</b>	<b>Storage pools</b>
<b>Solid-state disk (SSD)</b>	Place the database on SSD in the following circumstances: <ul style="list-style-type: none"> <li>You are using IBM Spectrum Protect data deduplication.</li> <li>You are backing up more than 8 TB of new data daily.</li> </ul>	If you place the IBM Spectrum Protect database on an SSD, as a best practice, place the active log on an SSD. If space is not available, use high-performance disk instead.	Save SSDs for use with the database and active log. The archive log and archive failover logs can be placed on slower storage technology types.	Save SSDs for use with the database and active log. Storage pools can be placed on slower storage technology types.
<b>High-performance disk with the following characteristics:</b> <ul style="list-style-type: none"> <li><b>15k rpm disk</b></li> <li><b>Fibre Channel or serial-attached SCSI (SAS) interface</b></li> </ul>	Use high-performance disks in the following circumstances: <ul style="list-style-type: none"> <li>The server does not do data deduplication.</li> <li>The server does not do node replication.</li> </ul> Isolate the server database from its logs and storage pools, and from data for other applications.	Use high-performance disks in the following circumstances: <ul style="list-style-type: none"> <li>The server does not do data deduplication.</li> <li>The server does not do node replication.</li> </ul> For performance and availability, isolate the active log from the server database, archive logs, and storage pools.	You can use high-performance disks for the archive log and archive failover logs. For availability, isolate these logs from the database and active log.	Use high-performance disks for storage pools in the following circumstances: <ul style="list-style-type: none"> <li>Data is frequently read.</li> <li>Data is frequently written.</li> </ul> For performance and availability, isolate storage pool data from the server database and logs, and from data for other applications.
<b>Medium-performance or high-performance disk with the following characteristics:</b> <ul style="list-style-type: none"> <li><b>10k rpm disk</b></li> <li><b>Fibre Channel or SAS interface</b></li> </ul>	If the disk system has a mix of disk technologies, use the faster disks for the database and active log. Isolate the server database from its logs and storage pools, and from data for other applications.	If the disk system has a mix of disk technologies, use the faster disks for the database and active log. For performance and availability, isolate the active log from the server database, archive logs, and storage pools.	You can use medium-performance or high-performance disk for the archive log and archive failover logs. For availability, isolate these logs from the database and active log.	Use medium-performance or high-performance disk for storage pools in the following circumstances: <ul style="list-style-type: none"> <li>Data is frequently read.</li> <li>Data is frequently written.</li> </ul> For performance and availability, isolate storage pool data from the server database and logs, and from data for other applications.

Storage technology type	Database	Active log	Archive log and archive failover log	Storage pools
<b>SATA, network-attached storage</b>	Do not use this storage for the database. Do not place the database on XIV storage systems.	Do not use this storage for the active log.	Use of this slower storage technology is acceptable because these logs are written once and infrequently read.	Use this slower storage technology in the following circumstances: <ul style="list-style-type: none"> <li>• Data is infrequently written, for example written once.</li> <li>• Data is infrequently read.</li> </ul>
<b>Tape and virtual tape</b>				Use for long-term retention or if data is infrequently used.

## Linux: Applying best practices to the server installation

Typically, hardware configuration and selection have the most significant effect on the performance of an IBM Spectrum Protect™ solution. Other factors that affect performance are the operating system selection and configuration, and the configuration of IBM Spectrum Protect.

### Procedure

- The following best practices are the most important for optimal performance and problem prevention.
- Review the table to determine the best practices that apply to your environment.

Best practice	More information
Use fast disks for the server database. Enterprise-grade solid-state disks (SSD), with Fibre Channel or SAS interface, offer the best performance.	Use fast, low-latency disks for the database. Using SSD is essential if you are using data deduplication and node replication. Avoid Serial Advanced Technology Attachment (SATA) and Parallel Advanced Technology Attachment (PATA) disks. For details and more tips, see the following topics: <ul style="list-style-type: none"> <li>◦ "Planning for server database disks"</li> <li>◦ "Planning for the correct type of storage technology"</li> </ul>
Ensure that the server system has enough memory.	Review operating system requirements in technote 1243309. Heavier workloads require more than the minimum requirements. Advanced features such as data deduplication and node replication can require more than the minimum memory that is specified in the system requirements document.  If you plan to run multiple instances, each instance requires the memory that is listed for one server. Multiply the memory for one server by the number of instances that are planned for the system.

Best practice	More information
Separate the server database, the active log, the archive log, and disk storage pools from each other.	<p>Keep all IBM Spectrum Protect storage resources on separate disks. Keep storage pool disks separate from the disks for the server database and logs. Storage pool operations can interfere with database operations when both are on the same disks. Ideally, the server database and logs are also separated from each other. For details and more tips, see the following topics:</p> <ul style="list-style-type: none"> <li>o "Planning for server database disks"</li> <li>o "Planning for server recovery log disks"</li> <li>o "Planning for storage pools in DISK or FILE device classes"</li> </ul>
Use at least four directories for the server database. For larger servers or servers that use advanced features, use eight directories.	<p>Place each directory on a LUN that is isolated from other LUNs and from other applications.</p> <p>A server is considered to be large if its database is larger than 2 TB or is expected to grow to that size. Use eight directories for such servers.</p> <p>See "Planning for server database disks".</p>
If you are using data deduplication, node replication, or both, follow the guidelines for database configuration and other items.	<p>Configure the server database according to the guidelines, because the database is extremely important to how well the server runs when these features are being used. For details and more tips, see the following topics:</p> <ul style="list-style-type: none"> <li>o Checklist for data deduplication</li> <li>o Checklist for node replication</li> </ul>
For storage pools that use FILE type device classes, follow the guidelines for the size of storage pool volumes. Typically, 50 GB volumes are best.	<p>Review the information in Optimal number and size of volumes for storage pools that use disk to help you to determine volume size.</p> <p>Configure storage pool devices and file systems based on throughput requirements, not only on capacity requirements.</p> <p>Isolate the storage devices that are used by IBM Spectrum Protect from other applications that have high I/O, and ensure that there is enough throughput to that storage.</p> <p>For more details, see Checklist for storage pools on DISK or FILE.</p>
Schedule IBM Spectrum Protect client operations and server maintenance activities to avoid or minimize overlap of operations.	<p>For more details, see the following topics:</p> <ul style="list-style-type: none"> <li>o Tuning the schedule for daily operations</li> <li>o Checklist for server configuration</li> </ul>
Monitor operations constantly.	<p>By monitoring, you can find problems early and more easily identify causes. Keep records of monitoring reports for up to a year to help you identify trends and plan for growth. See Monitoring and maintaining the environment for performance.</p>

## Linux: Minimum system requirements for Linux systems

To install the IBM Spectrum Protect™ server on a Linux system, it is necessary to have a minimum level of hardware and software, including a communication method and the most current device driver.

These tables list the minimum hardware and software requirements for the installation of an IBM Spectrum Protect server. Use these requirements as a starting point for systems without data deduplication. The optimal IBM Spectrum Protect environment is set up with data deduplication by using the IBM Spectrum Protect Blueprints. For the most current information about system requirements, see technote 1243309.

The IBM Spectrum Protect device driver package does not contain a device driver for this operating system because a SCSI generic device driver is used. Configure the device driver before using the IBM Spectrum Protect server with tape devices. The IBM Spectrum Protect driver package contains driver tools and ACSLS daemons. You can locate IBM® driver packages at the Fix Central website.

Requirements, supported devices, client installation packages, and fixes are available in the IBM Support Portal for IBM Spectrum Protect. After you install IBM Spectrum Protect and before you customize it for your use, go to the website and download and apply any applicable fixes.

- Linux Linux: Minimum Linux X86\_64 server requirements  
 Before you install an IBM Spectrum Protect server on a Linux X86\_64 operating system, review the hardware and software requirements.
- Linux Linux: Minimum Linux on System z server requirements  
 Before you install an IBM Spectrum Protect server on a Linux on System z® operating system, review the hardware and software requirements.
- Linux Linux: Minimum Linux on Power Systems (little endian) server requirements  
 Before you install an IBM Spectrum Protect server on a Linux on Power Systems (little endian) operating system, review the hardware and software requirements.

## Linux: Minimum Linux X86\_64 server requirements

Before you install an IBM Spectrum Protect™ server on a Linux X86\_64 operating system, review the hardware and software requirements.

### Hardware requirements

Table 1 describes the minimum hardware requirements for the server. If the server does not meet the minimum requirements, the installation fails. For more details about planning disk space, see Linux: Capacity planning.

Table 1. Hardware requirements

Type of hardware	Hardware requirements
Server	An AMD64 or Intel EMT-64 processor
Disk space	<p>The following minimum values for disk space:</p> <ul style="list-style-type: none"> <li>5 GB for the installation directory</li> <li>512 MB for the /var directory</li> <li>2 GB for the /tmp directory</li> <li>128 MB in the home directory for the root user.</li> <li>2 GB for the shared resources area</li> </ul> <p>In case a problem arises and any diagnosis is needed, it is optimal to have temporary or other space available on the system for a first failure data capture (FFDC) log or for other temporary uses such as for collecting trace logs.</p> <p>Significant additional disk space is required for database and log files. The size of the database depends on the number of client files to be stored and the method by which the server manages them. The default active log space is 16 GB, the minimum that is needed for most workloads and configurations. When you create the active log, you need at least 64 GB to run replication. If replication and data deduplication are both being used, create an active log of 128 GB. Allocate at least three times the default active log space for the archive log (48 GB). Ensure that you have sufficient resources if you are using data deduplication or expect a heavy client workload.</p> <p>For optimal performance and to facilitate I/O, specify at least two equally sized containers or Logical Unit Numbers (LUNs) for the database. In addition, each active log and archive log needs its own container or LUN.</p> <p>Ensure that you see Linux: Capacity planning for more details about disk space.</p>

Type of hardware	Hardware requirements
Memory	<p>The following minimum values for memory:</p> <ul style="list-style-type: none"> <li>• 16 GB for standard server operations without data deduplication and node replication</li> <li>• 24 GB for data deduplication or node replication</li> <li>• 32 GB for node replication with data deduplication</li> </ul> <p>For more specific memory requirements for larger databases and higher ingestion capability, see the IBM Spectrum Protect server memory tuning table.</p> <p>For more specific memory requirements when you are using data deduplication, see the IBM Spectrum Protect Blueprint for your operating system.</p>

## Software requirements

Table 2 describes the minimum software requirements that are needed for a server on a Linux X86\_64 system.

Table 2. Software requirements

Type of software	Minimum software requirements
Operating system	<p>The IBM Spectrum Protect server on Linux X86_64 requires one of the following operating systems:</p> <ul style="list-style-type: none"> <li>• Red Hat Enterprise Linux 6.7</li> <li>• Red Hat Enterprise Linux 7, including updates</li> <li>• SUSE Linux Enterprise Server 11, Service Pack 4 or later</li> <li>• SUSE Linux Enterprise Server 12</li> </ul>
Libraries	<p>GNU C libraries, Version 2.3.3-98.38 or later, which are installed on the IBM Spectrum Protect system. For SUSE Linux Enterprise Servers:</p> <ul style="list-style-type: none"> <li>• libaio</li> <li>• libstdc++.so.6 at version 4.3 or later (32-bit and 64-bit packages are required)</li> </ul> <p>For Red Hat Enterprise Linux Servers:</p> <ul style="list-style-type: none"> <li>• libaio</li> <li>• libstdc++.so.6 (32 and 64 bit packages are required)</li> <li>• numactl.x86_64</li> </ul> <p>To determine if SELinux is installed and in enforcing mode, take one of the following actions:</p> <ul style="list-style-type: none"> <li>• Check the <code>/etc/sysconfig/selinux</code> file.</li> <li>• Run the <code>sestatus</code> operating system command.</li> <li>• Check the <code>/var/log/messages</code> file for SELinux notices.</li> </ul> <p>To disable SELinux, complete one of the following tasks:</p> <ul style="list-style-type: none"> <li>• Set permissive mode by issuing the <code>setenforce 0</code> command as a superuser.</li> <li>• Modify the <code>/etc/sysconfig/selinux</code> file and restart the machine.</li> </ul>
Communication protocol	<ul style="list-style-type: none"> <li>• TCP/IP Version 4 or Version 6, which is standard with Linux</li> <li>• Shared memory protocol (with IBM Spectrum Protect Linux X86_64 client)</li> </ul>
Processing	<p>Asynchronous I/O must be enabled. On Linux kernels at 2.6 or later, install the libaio library to enable asynchronous I/O.</p>

Type of software	Minimum software requirements
Device drivers	<p>The IBM Spectrum Protect passthru device driver is used for non-IBM® devices. It uses the SCSI passthru interface to communicate with tape devices and tape libraries. The Linux SCSI Generic (sg) device driver is required for tape drives and tape libraries. The IBM Spectrum Protect device driver package contains device driver tools and ACSLS daemons.</p> <p>For the IBM 3590, 3592, or the Ultrium tape library or drives, the IBM device drivers are required. Install the most current device drivers. You can locate IBM driver packages at Fix Central.</p> <p>Configure the device drivers before you use the server with tape devices.</p>
Other software	<p>Korn Shell (ksh) is required. Configure the I/O completion ports (IOCP) on the operating system.</p> <p>To authenticate IBM Spectrum Protect users with a Lightweight Directory Access Protocol (LDAP) server, you must use one of the following directory servers:</p> <ul style="list-style-type: none"> <li>• Microsoft Active Directory (Windows Server 2012, Windows Server 2012 R2)</li> <li>• IBM Security Directory Server V6.3</li> <li>• IBM Security Directory Server V6.4</li> </ul>

## Linux: Minimum Linux on System z server requirements

Before you install an IBM Spectrum Protect™ server on a Linux on System z® operating system, review the hardware and software requirements.

### Hardware requirements

Table 1 describes the minimum hardware requirements that are needed for your IBM Spectrum Protect Linux on System z system. For more details about planning disk space, see Linux: Capacity planning.

Table 1. Hardware requirements

Type of hardware	Hardware requirements
Server	An IBM® zSeries, IBM System z9®, IBM System z10®, or IBM zEnterprise® System (z114 and z196) 64-bit native logical partition (LPAR) or z/VM® guest.
Disk space	<p>The following minimum values for disk space:</p> <ul style="list-style-type: none"> <li>• 5 GB for the installation directory</li> <li>• 512 MB for the /var directory</li> <li>• 2 GB for the /tmp directory</li> <li>• 128 MB in the home directory for the root user.</li> <li>• 2 GB for the shared resources area</li> </ul> <p>In case a problem arises and any diagnosis is needed, it is optimal to have temporary or other space available on the system for a first failure data capture (FFDC) log or for other temporary uses such as for collecting trace logs.</p> <p>Significant additional disk space is required for database and log files. The size of the database depends on the number of client files to be stored and the method by which the server manages them. The default active log space is 16 GB, the minimum that is needed for most workloads and configurations. When you create the active log, you need at least 64 GB to run replication. If replication and data deduplication are both being used, create an active log of 128 GB. Allocate at least three times the default active log space for the archive log (48 GB). Ensure that you have sufficient resources if you are using data deduplication or expect a heavy client workload.</p> <p>For optimal performance and to facilitate I/O, specify at least two equally sized containers or Logical Unit Numbers (LUNs) for the database. In addition, each active log and archive log needs its own container or LUN.</p> <p>Ensure that you see Linux: Capacity planning for more details about disk space.</p>

Type of hardware	Hardware requirements
Memory	<p>The following minimum values for memory:</p> <ul style="list-style-type: none"> <li>• 16 GB for standard server operations without data deduplication and node replication</li> <li>• 24 GB for data deduplication or node replication</li> <li>• 32 GB for node replication with data deduplication</li> </ul> <p>For more specific memory requirements for larger databases and higher ingestion capability, see the IBM Spectrum Protect server memory tuning table.</p> <p>For more specific memory requirements when you are using data deduplication, see the IBM Spectrum Protect Blueprint for your operating system.</p>

## Software requirements

Table 2 describes the minimum software requirements that are needed for your IBM Spectrum Protect Linux on System z system.

Table 2. Software requirements

Type of software	Minimum software requirements
Server	<p>The IBM Spectrum Protect server on Linux on System z (s390x 64-bit architecture) requires one of the following operating systems:</p> <ul style="list-style-type: none"> <li>• Red Hat Enterprise Linux 7.1</li> <li>• SUSE Linux Enterprise Server 12</li> </ul>
Libraries	<p>A GNU C library, Version 2.4-31.43.6, is installed on the IBM Spectrum Protect system.</p> <p>For SUSE Linux Enterprise Servers:</p> <ul style="list-style-type: none"> <li>• libaio</li> <li>• libstdc++.so.6 at version 4.3 or later (32-bit and 64-bit packages are required)</li> <li>• libxlc-1.2.0.0.151119a.s390x or later</li> </ul> <p>For Red Hat Enterprise Linux Servers:</p> <ul style="list-style-type: none"> <li>• libaio</li> <li>• libstdc++.so.6 (32-bit and 64-bit packages are required)</li> <li>• numactl.x86_64</li> <li>• libxlc-1.2.0.0.151119a.s390x or later</li> </ul>
Communication protocol	<ul style="list-style-type: none"> <li>• TCP/IP Version 4 or Version 6, which is standard with Linux</li> <li>• Shared memory protocol (with IBM Spectrum Protect Version 8.1.2 Linux on System z client)</li> </ul>
Processing	<p>Asynchronous I/O must be enabled. On Linux kernels at 2.6 or later, install the libaio library to enable asynchronous I/O.</p>
Other software	<p>Korn Shell (ksh) is required. Configure the I/O completion ports (IOCP) on the operating system.</p> <p>To authenticate IBM Spectrum Protect users with a Lightweight Directory Access Protocol (LDAP) server, you must use one of the following directory servers:</p> <ul style="list-style-type: none"> <li>• Microsoft Active Directory (Windows Server 2012, Windows Server 2012 R2)</li> <li>• IBM Security Directory Server V6.3</li> <li>• IBM Security Directory Server V6.4</li> </ul>

## Linux: Minimum Linux on Power Systems™ (little endian) server requirements



Before you install an IBM Spectrum Protect™ server on a Linux on Power Systems (little endian) operating system, review the hardware and software requirements.

## Hardware requirements

Table 1 describes the minimum hardware requirements for the server. If the server does not meet the minimum requirements, the installation fails. For more details about planning disk space, see Linux: Capacity planning.

Table 1. Hardware requirements

Type of hardware	Hardware requirements
Server	A Linux on Power Systems (little endian) server on an IBM® system, such as one listed on the Linux on IBM Power Systems website.
Disk space	<p>The following minimum disk space:</p> <ul style="list-style-type: none"> <li>• 5 GB for the installation directory</li> <li>• 128 MB in the home directory for the root user.</li> <li>• 2 GB for the shared resources area</li> </ul> <p>In case a problem arises and any diagnosis is needed, it is optimal to have temporary or other space available on the system for a first failure data capture (FFDC) log or for other temporary uses such as for collecting trace logs.</p> <p>Significant additional disk space is required for database and log files. The size of the database depends on the number of client files to be stored and the method by which the server manages them. The default active log space is 16 GB, the minimum that is needed for most workloads and configurations. When you create the active log, you need at least 64 GB to run replication. If replication and data deduplication are both being used, create an active log of 128 GB. Allocate at least three times the default active log space for the archive log (48 GB). Ensure that you have sufficient resources if you are using data deduplication or expect a heavy client workload.</p> <p>For optimal performance and to facilitate I/O, specify at least two equally sized containers or Logical Unit Numbers (LUNs) for the database. In addition, each active log and archive log needs its own container or LUN.</p> <p>Ensure that you see Linux: Capacity planning for more details about disk space.</p>
Memory	<ul style="list-style-type: none"> <li>• 16 GB for standard server operations without data deduplication and node replication</li> <li>• 24 GB for data deduplication or node replication</li> <li>• 32 GB for node replication with data deduplication</li> </ul> <p>For more specific memory requirements for larger databases and higher ingestion capability, see the IBM Spectrum Protect server memory tuning table.</p> <p>For more specific memory requirements when you are using data deduplication, see the IBM Spectrum Protect Blueprint for your operating system.</p>

## Software requirements

Table 2 describes the minimum software requirements that are needed for your system.

Table 2. Software requirements

Type of software	Minimum software requirements
Operating system	The Red Hat Enterprise Linux (RHEL) 7.3 operating system with the PPC64LE architecture.
Libraries	<p>GNU C libraries, Version 2.4-31.30 and later.</p> <p>libaio.so.1 (32-bit and 64-bit packages).</p>
Communication protocol	<ul style="list-style-type: none"> <li>• TCP/IP Version 4 or Version 6, which is standard with Linux</li> <li>• Shared memory protocol (with a Version 8.1.2 client)</li> </ul>
Processing	Asynchronous I/O must be enabled. On Linux kernels at 2.6 or later, install the libaio library to enable asynchronous I/O.

Type of software	Minimum software requirements
Other software	<p>Korn Shell (ksh) is required. Configure the I/O completion ports (IOCP) on the operating system.</p> <p>To authenticate IBM Spectrum Protect users with a Lightweight Directory Access Protocol (LDAP) server, you must use one of the following directory servers:</p> <ul style="list-style-type: none"> <li>• Microsoft Active Directory (Windows Server 2012, Windows Server 2012 R2)</li> <li>• IBM Security Directory Server V6.3</li> <li>• IBM Security Directory Server V6.4</li> </ul>

Restriction: Raw logical volumes are not supported.

Linux

## Linux: Compatibility of the IBM Spectrum Protect server with other DB2 products on the system

You can install other products that deploy and use DB2® products on the same system as the IBM Spectrum Protect™ Version 8.1.2 server, with some limitations.

To install and use other products that use a DB2 product on the same system as the IBM Spectrum Protect server, ensure that the following criteria are met:

Table 1. Compatibility of the IBM Spectrum Protect server with other DB2 products on the system

Criterion	Instructions
Version level	The other products that use a DB2 product must use DB2 version 9 or later. DB2 products include product encapsulation and segregation support beginning with Version 9. Starting with this version, you can run multiple copies of DB2 products, at different code levels, on the same system. For details, see the information about multiple DB2 copies in the DB2 product information.
User IDs and directories	Ensure that the user IDs, fence user IDs, installation location, other directories, and related information are not shared across DB2 installations. Your specifications must be different from the IDs and locations that you used for the IBM Spectrum Protect server installation and configuration. If you used the dsmdir wizard to configure the server, these are values that you entered when running the wizard. If you used the manual configuration method, review the procedures that you used if necessary to recall the values that were used for the server.
Resource allocation	<p>Consider the resources and capability of the system compared to the requirements for both the IBM Spectrum Protect server and the other applications that use the DB2 product. To provide sufficient resources for the other DB2 applications, you might have to change the IBM Spectrum Protect server settings so that the server uses less system memory and resources. Similarly, if the workloads for the other DB2 applications compete with the IBM Spectrum Protect server for processor or memory resources, the performance of the server in handling the expected client workload or other server operations might be adversely affected.</p> <p>To segregate resources and provide more capability for the tuning and allocation of processor, memory, and other system resources for multiple applications, consider using logical partition (LPAR), workload partition (WPAR), or other virtual workstation support. For example, run a DB2 application on its own virtualized system.</p>

## Linux: IBM Installation Manager

IBM Spectrum Protect™ uses IBM® Installation Manager, which is an installation program that can use remote or local software repositories to install or update many IBM products.

If the required version of IBM Installation Manager is not already installed, it is automatically installed or upgraded when you install IBM Spectrum Protect. It must remain installed on the system so that IBM Spectrum Protect can be updated or uninstalled.

later as needed.

The following list contains explanations of some terms that are used in IBM Installation Manager:

**Offering**

An installable unit of a software product.

The IBM Spectrum Protect offering contains all of the media that IBM Installation Manager requires to install IBM Spectrum Protect.

**Package**

The group of software components that are required to install an offering.

The IBM Spectrum Protect package contains the following components:

- IBM Installation Manager installation program
- IBM Spectrum Protect offering

**Package group**

A set of packages that share a common parent directory.

The default package group for the IBM Spectrum Protect package is `IBM Installation Manager`.

**Repository**

A remote or local storage area for data and other application resources.

The IBM Spectrum Protect package is stored in a repository on IBM Fix Central.

**Shared resources directory**

A directory that contains software files or plug-ins that are shared by packages.

IBM Installation Manager stores installation-related files in the shared resources directory, including files that are used for rolling back to a previous version of IBM Spectrum Protect.

## Linux: Worksheets for planning details for the server

---

You can use the worksheets to help you plan the amount and location of storage needed for the IBM Spectrum Protect™ server. You can also use them to keep track of names and user IDs.

Item	Space required	Number of directories	Location of directories
The database			
Active log			
Archive log			
Optional: Log mirror for the active log			
Optional: Secondary archive log (failover location for archive log)			

Item	Names and user IDs	Location
The <i>instance user ID</i> for the server, which is the ID you use to start and run the IBM Spectrum Protect server		
The <i>home directory</i> for the server, which is the directory that contains the instance user ID		
The database instance name		

Item	Names and user IDs	Location
The <i>instance directory</i> for the server, which is a directory that contains files specifically for this server instance (the server options file and other server-specific files)		
The server name, use a unique name for each server		

## Linux: Capacity planning

Capacity planning for IBM Spectrum Protect™ includes managing resources such as the database, the recovery log and the shared resource area. To maximize resources as part of capacity planning, you must estimate space requirements for the database and the recovery log. The shared resource area must have enough space available for each installation or upgrade.

- **Linux: Estimating space requirements for the database**  
To estimate space requirements for the database, you can use the maximum number of files that can be in server storage at one time or you can use storage pool capacity.
- **Linux: Recovery log space requirements**  
In IBM Spectrum Protect, the term *recovery log* comprises the active log, the archive log, the active log mirror, and the archive failover log. The amount of space that you require for the recovery log depends on various factors, including, for example, the amount of client activity with the server.
- **Linux: Monitoring space utilization for the database and recovery logs**  
To determine the amount of used and available active log space, you issue the QUERY LOG command. To monitor space utilization in the database and recovery logs, you can also check the activity log for messages.
- **Linux: Deleting installation rollback files**  
You can delete certain installation files that were saved during the installation process to free space in the shared resource directory. For example, files that might have been required for a rollback operation are types of files that you can delete.

## Linux: Estimating space requirements for the database

To estimate space requirements for the database, you can use the maximum number of files that can be in server storage at one time or you can use storage pool capacity.

### About this task

Consider using at least 25 GB for the initial database space. Provision file system space appropriately. A database size of 25 GB is adequate for a test environment or a library-manager-only environment. For a production server supporting client workloads, the database size is expected to be larger. If you use random-access disk (DISK) storage pools, more database and log storage space is needed than for sequential-access storage pools.

The maximum size of the IBM Spectrum Protect™ database is 6 TB.

For information about sizing the database in a production environment that is based on the number of files and on storage pool size, see the following topics.

- **Linux: Estimating database space requirements based on the number of files**  
If you can estimate the maximum number of files that might be in server storage at a time, you can use that number to estimate space requirements for the database.
- **Linux: Estimating database space requirements based on storage pool capacity**  
To estimate database space requirements based on storage pool capacity, use a ratio of 1 - 5%. For example, if you require 200 TB of storage pool capacity, the size of your database is expected to be 2 - 10 TB. As a general rule, make your database as large as possible to prevent running out of space. If you run out of database space, server operations and client-store operations can fail.
- **Linux: The database manager and temporary space**  
The IBM Spectrum Protect server database manager manages and allocates system memory and disk space for the database. The amount of database space you require depends on the amount of system memory available and the server workload.

# Linux: Estimating database space requirements based on the number of files

If you can estimate the maximum number of files that might be in server storage at a time, you can use that number to estimate space requirements for the database.

## About this task

To estimate space requirements that is based on the maximum number of files in server storage, use the following guidelines:

- 600 - 1000 bytes for each stored version of a file, including image backups.  
Restriction: The guideline does not include space that is used during data deduplication.
- 100 - 200 bytes for each cached file, copy storage pool file, active-data pool file, and deduplicated file.
- Additional space is required for database optimization to support varying data-access patterns and to support server back-end processing of the data. The amount of extra space is equal to 50% of the estimate for the total number of bytes for file objects.

In the following example for a single client, the calculations are based on the maximum values in the preceding guidelines. The examples do not take into account that you might use file aggregation. In general, when you aggregate small files, it reduces the amount of required database space. File aggregation does not affect space-managed files.

## Procedure

1. Calculate the number of file versions. Add each of the following values to obtain the number of file versions:
  - a. Calculate the number of backed-up files. For example, as many as 500,000 client files might be backed up at a time. In this example, storage policies are set to keep up to three copies of backed up files:

$$500,000 \text{ files} * 3 \text{ copies} = 1,500,000 \text{ files}$$

- b. Calculate the number of archive files. For example, as many as 100,000 client files might be archived copies.
- c. Calculate the number of space-managed files. For example, as many as 200,000 client files might be migrated from client workstations.

Using 1000 bytes per file, the total amount of database space that is required for the files that belong to the client is 1.8 GB:

$$(1,500,000 + 100,000 + 200,000) * 1000 = 1.8 \text{ GB}$$

2. Calculate the number of cached files, copy storage-pool files, active-data pool files, and deduplicated files:
  - a. Calculate the number of cached copies. For example, caching is enabled in a 5 GB disk storage pool. The high migration threshold of the pool is 90% and the low migration threshold of the pool is 70%. Thus, 20% of the disk pool, or 1 GB, is occupied by cached files.  
If the average file size is about 10 KB, approximately 100,000 files are in cache at any one time:

$$100,000 \text{ files} * 200 \text{ bytes} = 19 \text{ MB}$$

- b. Calculate the number of copy storage-pool files. All primary storage pools are backed up to the copy storage pool:

$$(1,500,000 + 100,000 + 200,000) * 200 \text{ bytes} = 343 \text{ MB}$$

- c. Calculate the number of active storage-pool files. All the active client-backup data in primary storage pools is copied to the active-data storage pool. Assume that 500,000 versions of the 1,500,000 backup files in the primary storage pool are active:

$$500,000 * 200 \text{ bytes} = 95 \text{ MB}$$

- d. Calculate the number of deduplicated files. Assume that a deduplicated storage pool contains 50,000 files:

$$50,000 * 200 \text{ bytes} = 10 \text{ MB}$$

Based on the preceding calculations, about 0.5 GB of extra database space is required for the client's cached files, copy storage-pool files, active-data pool files, and deduplicated files.

3. Calculate the amount of extra space that is required for database optimization. To provide optimal data access and management by the server, extra database space is required. The amount of extra database space is equal to 50% of the total space requirements for file objects.

$$(1.8 + 0.5) * 50\% = 1.2 \text{ GB}$$

4. Calculate the total amount of database space that is required for the client. The total is approximately 3.5 GB:

$$1.8 + 0.5 + 1.2 = 3.5 \text{ GB}$$

5. Calculate the total amount of database space that is required for all clients. If the client that was used in the preceding calculations is typical and you have 500 clients, for example, you can use the following calculation to estimate the total amount of database space that is required for all clients:

$$500 * 3.5 = 1.7 \text{ TB}$$

## Results

---

Tip: In the preceding examples, the results are estimates. The actual size of the database might differ from the estimate because of factors such as the number of directories and the length of the path and file names. Periodically monitor your database and adjust its size as necessary.

## What to do next

---

During normal operations, the IBM Spectrum Protect™ server might require temporary database space. This space is needed for the following reasons:

- To hold the results of sorting or ordering that are not already being kept and optimized in the database directly. The results are temporarily held in the database for processing.
- To give administrative access to the database through one of the following methods:
  - A DB2® open database connectivity (ODBC) client
  - An Oracle Java™ database connectivity (JDBC) client
  - Structured Query Language (SQL) to the server from an administrative-client command line

Consider using an extra 50 GB of temporary space for every 500 GB of space for file objects and optimization. See the guidelines in the following table. In the example that is used in the preceding step, a total of 1.7 TB of database space is required for file objects and optimization for 500 clients. Based on that calculation, 200 GB is required for temporary space. The total amount of required database space is 1.9 TB.

Database size	Minimum temporary-space requirement
< 500 GB	50 GB
≥ 500 GB and < 1 TB	100 GB
≥ 1 TB and < 1.5 TB	150 GB
≥ 1.5 and < 2 TB	200 GB
≥ 2 and < 3 TB	250 - 300 GB
≥ 3 and < 4 TB	350 - 400 GB

## Linux: Estimating database space requirements based on storage pool capacity

---

To estimate database space requirements based on storage pool capacity, use a ratio of 1 - 5%. For example, if you require 200 TB of storage pool capacity, the size of your database is expected to be 2 - 10 TB. As a general rule, make your database as large as possible to prevent running out of space. If you run out of database space, server operations and client-store operations can fail.

## Linux: The database manager and temporary space

---

The IBM Spectrum Protect™ server database manager manages and allocates system memory and disk space for the database. The amount of database space you require depends on the amount of system memory available and the server workload.

The database manager sorts data in a specific sequence, according to the SQL statement that you issue to request the data. Depending on the workload on the server, and if there is more data than the database manager can manage, the data (that is

ordered in sequence) is allocated to temporary disk space. Data is allocated to temporary disk space when there is a large result set. The database manager dynamically manages the memory that is used when data is allocated to temporary disk space.

For example, expiration processing can produce a large result set. If there is not enough system memory on the database to store the result set, some of the data is allocated to temporary disk space. During expiration processing, if a node or file space are selected that are too large to process, the database manager cannot sort the data in memory. The database manager must use temporary space to sort data.

To run database operations, consider adding more database space for the following scenarios:

- The database has a small amount of space and the server operation that requires temporary space uses the remaining free space.
- The file spaces are large, or the file spaces have an assigned policy that creates many file versions.
- The IBM Spectrum Protect server must run with limited memory. The database uses the IBM Spectrum Protect server main memory to run database operations. However, if there is insufficient memory available, the IBM Spectrum Protect server allocates temporary space on disk to the database. For example, if 10G of memory is available and database operations require 12G of memory, the database uses temporary space.
- An `out of database space` error is displayed when you deploy an IBM Spectrum Protect server. Monitor the server activity log for messages that are related to database space.

Important: Do not change the DB2 software that is installed with the IBM Spectrum Protect installation packages and fix packs. Do not install or upgrade to a different version, release, or fix pack, of DB2 software to avoid damage to the database.

## Linux: Recovery log space requirements

---

In IBM Spectrum Protect™, the term *recovery log* comprises the active log, the archive log, the active log mirror, and the archive failover log. The amount of space that you require for the recovery log depends on various factors, including, for example, the amount of client activity with the server.

- **Linux: Active and archive log space**  
When you estimate space requirements for active and archive logs, include some extra space for contingencies such as occasional heavy workloads and failovers.
- **Linux: Active-log mirror space**  
The active log can be mirrored so that the mirrored copy can be used if the active log files cannot be read. There can be only one active log mirror.
- **Linux: Archive-failover log space**  
The archive failover log is used by the server if the archive log directory runs out of space.

## Linux: Active and archive log space

---

When you estimate space requirements for active and archive logs, include some extra space for contingencies such as occasional heavy workloads and failovers.

In IBM Spectrum Protect™ servers V7.1 and later, the active log can be a maximum size of 512 GB. The archive log size is limited to the size of the file system that it is installed on.

Use the following general guidelines when you estimate the size of the active log:

- The suggested starting size for the active log is 16 GB.
- Ensure that the active log is at least large enough for the amount of concurrent activity that the server typically handles. As a precaution, try to anticipate the largest amount of work that the server manages at one time. Provision the active log with extra space that can be used if needed. Consider using 20% of extra space.
- Monitor used and available active log space. Adjust the size of the active log as needed, depending upon factors such as client activity and the level of server operations.
- Ensure that the directory that holds the active log is as large as, or larger than, the size of the active log. A directory that is larger than the active log can accommodate failovers, if they occur.
- Ensure that the file system that contains the active log directory has at least 8 GB of free space for temporary log movement requirements.

The suggested starting size for the archive log is 48 GB.

The archive log directory must be large enough to contain the log files that are generated since the previous full backup. For example, if you perform a full backup of the database every day, the archive log directory must be large enough to hold the log

files for all the client activity that occurs during 24 hours. To recover space, the server deletes obsolete archive log files after a full backup of the database. If the archive log directory becomes full and a directory for archive failover logs does not exist, log files remain in the active log directory. This condition can cause the active log directory to fill up and stop the server. When the server restarts, some of the existing active-log space is released.

After the server is installed, you can monitor archive log utilization and the space in the archive log directory. If the space in the archive log directory fills up, it can cause the following problems:

- The server is unable to perform full database backups. Investigate and resolve this problem.
- Other applications write to the archive log directory, exhausting the space that is required by the archive log. Do not share archive log space with other applications including other IBM Spectrum Protect servers. Ensure that each server has a separate storage location that is owned and managed by that specific server.
- Linux: Example: Estimating active and archive log sizes for basic client-store operations  
Basic client-store operations include backup, archive, and space management. Log space must be sufficient to handle all store transactions that are in progress at one time.
- Linux: Example: Estimating active and archive log sizes for clients that use multiple sessions  
If the client option RESOURCEUTILIZATION is set to a value that is greater than the default, the concurrent workload for the server increases.
- Linux: Example: Estimating active and archive log sizes for simultaneous write operations  
If client backup operations use storage pools that are configured for simultaneous write, the amount of log space that is required for each file increases.
- Linux: Example: Estimating active and archive log sizes for basic client store operations and server operations  
Migration of data in server storage, identification processes for data deduplication, reclamation, and expiration might run concurrently with client store operations. Administrative tasks such as administrative commands or SQL queries from administrative clients can also run concurrently with client store operations. Server operations and administrative tasks that run concurrently can increase the active log space that is required.
- Linux: Example: Estimating active and archive log sizes under conditions of extreme variation  
Problems with running out of active log space can occur if you have many transactions that complete quickly and some transactions that take much longer to complete. A typical case occurs when many workstation or file-server backup sessions are active and a few very large database server-backup sessions are active. If this situation applies to your environment, you might need to increase the size of the active log so that the work completes successfully.
- Linux: Example: Estimating archive log sizes with full database backups  
The IBM Spectrum Protect server deletes unnecessary files from the archive log only when a full database backup occurs. Consequently, when you estimate the space that is required for the archive log, you must also consider the frequency of full database backups.
- Linux: Example: Estimating active and archive log sizes for data deduplication operations  
If you deduplicate data, you must consider its effects on space requirements for active and archive logs.

## Linux: Example: Estimating active and archive log sizes for basic client-store operations

Basic client-store operations include backup, archive, and space management. Log space must be sufficient to handle all store transactions that are in progress at one time.

To determine the sizes of the active and archive logs for basic client-store operations, use the following calculation:

```
number of clients x files stored during each transaction
x log space needed for each file
```

This calculation is used in the example in the following table.

Table 1. Basic client-store operations

Item	Example values	Description
Maximum number of client nodes that back up, archive, or migrate files concurrently at any time	300	The number of client nodes that back up, archive, or migrate files every night.
Files stored during each transaction	4096	The default value of the server option TXNGROUPMAX is 4096.



Item	Example values	Description
Log space that is required for each file	3053 bytes	The value of 3053 bytes for each file in a transaction represents the log bytes that are needed when backing up files from a Windows client where the file names are 12 - 120 bytes.  This value is based on the results of tests performed under laboratory conditions. The tests consisted of backup-archive clients performing backup operations to a random-access disk (DISK) storage pool. DISK pools result in more log use than sequential-access storage pools. Consider a value larger than 3053 bytes if the data being stored has file names that are longer than 12 - 120 bytes.
Active log: Suggested size	19.5 GB <sup>1</sup>	Use the following calculation to determine the size of the active log. One GB equals 1,073,741,824 bytes.  (300 clients x 4096 files stored during each transaction x 3053 bytes for each file) ÷ 1,073,741,824 bytes = 3.5 GB  Increase that amount by the suggested starting size of 16 GB:  3.5 + 16 = 19.5 GB
Archive log: Suggested size	58.5 GB <sup>1</sup>	Because of the requirement to be able to store archive logs across three server database-backup cycles, multiply the estimate for the active log by 3 to estimate the total archive log requirement.  3.5 x 3 = 10.5 GB  Increase that amount by the suggested starting size of 48 GB:  10.5 + 48 = 58.5 GB
<p><sup>1</sup> The example values in this table are used only to illustrate how the sizes for active logs and archive logs are calculated. In a production environment that does not use deduplication, 16 GB is the suggested minimum size for an active log. The suggested minimum size for an archive log in a production environment that does not use deduplication is 48 GB. If you substitute values from your environment and the results are larger than 16 GB and 48 GB, use your results to size the active log and archive log.</p> <p>Monitor your logs and adjust their size if necessary.</p>		

## Linux: Example: Estimating active and archive log sizes for clients that use multiple sessions

If the client option RESOURCEUTILIZATION is set to a value that is greater than the default, the concurrent workload for the server increases.

To determine the sizes of the active and archive logs when clients use multiple sessions, use the following calculation:

```
number of clients x sessions for each client x files stored
during each transaction x log space needed for each file
```

This calculation is used in the example in the following table.

Table 1. Multiple client sessions

Item	Example values		Description
Maximum number of client nodes that back up, archive, or migrate files concurrently at any time	300	1000	The number of client nodes that back up, archive, or migrate files every night.

Item	Example values		Description
Possible sessions for each client	3	3	The setting of the client option RESOURCEUTILIZATION is larger than the default. Each client session runs a maximum of three sessions in parallel.
Files stored during each transaction	4096	4096	The default value of the server option TXNGROUPMAX is 4096.
Log space that is required for each file	3053	3053	The value of 3053 bytes for each file in a transaction represents the log bytes needed when backing up files from a Windows client where the file names are 12 - 120 bytes.  This value is based on the results of tests performed under laboratory conditions. Tests consisted of clients performing backup operations to a random-access disk (DISK) storage pool. DISK pools result in more log use than sequential-access storage pools. Consider a value larger than 3053 bytes if the data being stored has file names that are longer than 12 - 120 bytes.
Active log: Suggested size	26.5 GB <sup>1</sup>	51 GB <sup>1</sup>	The following calculation was used for 300 clients. One GB equals 1,073,741,824 bytes.  (300 clients x 3 sessions for each client x 4096 files stored during each transaction x 3053 bytes for each file) ÷ 1,073,741,824 = 10.5 GB  Increase that amount by the suggested starting size of 16 GB:  10.5 + 16 = 26.5 GB  The following calculation was used for 1000 clients. One GB equals 1,073,741,824 bytes.  (1000 clients x 3 sessions for each client x 4096 files store during each transaction x 3053 bytes for each file) ÷ 1,073,741,824 = 35 GB  Increase that amount by the suggested starting size of 16 GB:  35 + 16 = 51 GB
Archive log: Suggested size	79.5 GB <sup>1</sup>	153 GB <sup>1</sup>	Because of the requirement to be able to store archive logs across three server-database backup cycles, the estimate for the active log is multiplied by 3:  10.5 x 3 = 31.5 GB  35 x 3 = 105 GB  Increase those amounts by the suggested starting size of 48 GB:  31.5 + 48 = 79.5 GB  105 + 48 = 153 GB
<p><sup>1</sup> The example values in this table are used only to illustrate how the sizes for active logs and archive logs are calculated. In a production environment that does not use deduplication, 16 GB is the suggested minimum size for an active log. The suggested minimum size for an archive log in a production environment that does not use deduplication is 48 GB. If you substitute values from your environment and the results are larger than 16 GB and 48 GB, use your results to size the active log and archive log.</p> <p>Monitor your active log and adjust its size if necessary.</p>			

## Linux: Example: Estimating active and archive log sizes for simultaneous write operations

If client backup operations use storage pools that are configured for simultaneous write, the amount of log space that is required for each file increases.

The log space that is required for each file increases by about 200 bytes for each copy storage pool that is used for a simultaneous write operation. In the example in the following table, data is stored to two copy storage pools in addition to a primary storage pool. The estimated log size increases by 400 bytes for each file. If you use the suggested value of 3053 bytes of log space for each file, the total number of required bytes is 3453.

This calculation is used in the example in the following table.

Table 1. Simultaneous write operations

Item	Example values	Description
Maximum number of client nodes that back up, archive, or migrate files concurrently at any time	300	The number of client nodes that back up, archive, or migrate files every night.
Files stored during each transaction	4096	The default value of the server option TXNGROUPMAX is 4096.
Log space that is required for each file	3453 bytes	3053 bytes plus 200 bytes for each copy storage pool.  The value of 3053 bytes for each file in a transaction represents the log bytes that are needed when backing up files from a Windows client where the file names are 12 - 120 bytes.  This value is based on the results of tests performed under laboratory conditions. The tests consisted of backup-archive clients performing backup operations to a random-access disk (DISK) storage pool. DISK pools result in more log use than sequential-access storage pools. Consider a value larger than 3053 bytes if the data being stored has file names that are longer than 12 - 120 bytes.
Active log: Suggested size	20 GB <sup>1</sup>	Use the following calculation to determine the size of the active log. One GB equals 1,073,741,824 bytes.  (300 clients x 4096 files stored during each transaction x 3453 bytes for each file) ÷ 1,073,741,824 bytes = 4.0 GB  Increase that amount by the suggested starting size of 16 GB:  4 + 16 = 20 GB
Archive log: Suggested size	60 GB <sup>1</sup>	Because of the requirement to be able to store archive logs across three server database-backup cycles, multiply the estimate for the active log by 3 to estimate the archive log requirement:  4 GB x 3 = 12 GB  Increase that amount by the suggested starting size of 48 GB:  12 + 48 = 60 GB
<p><sup>1</sup> The example values in this table are used only to illustrate how the sizes for active logs and archive logs are calculated. In a production environment that does not use deduplication, 16 GB is the suggested minimum size for an active log. The suggested minimum size for an archive log in a production environment that does not use deduplication is 48 GB. If you substitute values from your environment and the results are larger than 16 GB and 48 GB, use your results to size the active log and archive log.</p> <p>Monitor your logs and adjust their size if necessary.</p>		

## Linux: Example: Estimating active and archive log sizes for basic client store operations and server operations

Migration of data in server storage, identification processes for data deduplication, reclamation, and expiration might run concurrently with client store operations. Administrative tasks such as administrative commands or SQL queries from administrative clients can also run concurrently with client store operations. Server operations and administrative tasks that run concurrently can increase the active log space that is required.

For example, migration of files from the random-access (DISK) storage pool to a sequential-access disk (FILE) storage pool uses approximately 110 bytes of log space for each file that is migrated. For example, suppose that you have 300 backup-archive clients and each one of them backs up 100,000 files every night. The files are initially stored on DISK and then migrated to a FILE storage pool. To estimate the amount of active log space that is required for the data migration, use the following calculation. The number of clients in the calculation represents the maximum number of client nodes that back up, archive, or migrate files concurrently at any time.

$$300 \text{ clients} \times 100,000 \text{ files for each client} \times 110 \text{ bytes} = 3.1 \text{ GB}$$

Add this value to the estimate for the size of the active log that calculated for basic client store operations.

## Linux: Example: Estimating active and archive log sizes under conditions of extreme variation

Problems with running out of active log space can occur if you have many transactions that complete quickly and some transactions that take much longer to complete. A typical case occurs when many workstation or file-server backup sessions are active and a few very large database server-backup sessions are active. If this situation applies to your environment, you might need to increase the size of the active log so that the work completes successfully.

## Linux: Example: Estimating archive log sizes with full database backups

The IBM Spectrum Protect™ server deletes unnecessary files from the archive log only when a full database backup occurs. Consequently, when you estimate the space that is required for the archive log, you must also consider the frequency of full database backups.

For example, if a full database backup occurs once a week, the archive log space must be able to contain the information in the archive log for a full week.

The difference in archive log size for daily and full database backups is shown in the example in the following table.

Table 1. Full database backups

Item	Example values	Description
Maximum number of client nodes that back up, archive, or migrate files concurrently at any time	300	The number of client nodes that back up, archive, or migrate files every night.
Files stored during each transaction	4096	The default value of the server option TXNGROUPMAX is 4096.
Log space that is required for each file	3453 bytes	3053 bytes for each file plus 200 bytes for each copy storage pool.  The value of 3053 bytes for each file in a transaction represents the log bytes needed when backing up files from a Windows client where the file names are 12 - 120 bytes.  This value is based on the results of tests performed under laboratory conditions. Tests consisted of clients performing backup operations to a random-access disk (DISK) storage pool. DISK pools result in more log use than sequential-access storage pools. Consider a value larger than 3053 bytes if the data being stored has file names that are longer than 12 - 120 bytes.
Active log: Suggested size	20 GB <sup>1</sup>	Use the following calculation to determine the size of the active log. One GB equals 1,073,741,824 bytes.  (300 clients x 4096 files per transaction x 3453 bytes per file) ÷ 1,073,741,824 bytes = 4.0 GB  Increase that amount by the suggested starting size of 16 GB:  4 + 16 = 20 GB

Item	Example values	Description
Archive log: Suggested size with a full database backup every day	60 GB <sup>1</sup>	Because of the requirement to be able to store archive logs across three backup cycles, multiply the estimate for the active log by 3 to estimate the total archive log requirement:  $4 \text{ GB} \times 3 = 12 \text{ GB}$  Increase that amount by the suggested starting size of 48 GB:  $12 + 48 = 60 \text{ GB}$
Archive log: Suggested size with a full database every week	132 GB <sup>1</sup>	Because of the requirement to be able to store archive logs across three server database-backup cycles, multiply the estimate for the active log by 3 to estimate the total archive log requirement. Multiply the result by the number of days between full database backups:  $(4 \text{ GB} \times 3) \times 7 = 84 \text{ GB}$  Increase that amount by the suggested starting size of 48 GB:  $84 + 48 = 132 \text{ GB}$
<p><sup>1</sup> The example values in this table are used only to illustrate how the sizes for active logs and archive logs are calculated. In a production environment that does not use deduplication, 16 GB is the suggested minimum size for an active log. The suggested starting size for an archive log in a production environment that does not use deduplication is 48 GB. If you substitute values from your environment and the results are larger than 16 GB and 48 GB, use your results to size the active log and archive log.</p> <p>Monitor your logs and adjust their size if necessary.</p>		

## Linux: Example: Estimating active and archive log sizes for data deduplication operations

If you deduplicate data, you must consider its effects on space requirements for active and archive logs.

The following factors affect requirements for active and archive log space:

The amount of deduplicated data

The effect of data deduplication on the active log and archive log space depends on the percentage of data that is eligible for deduplication. If the percentage of data that can be deduplicated is relatively high, more log space is required.

The size and number of extents

Approximately 1,500 bytes of active log space are required for each extent that is identified by a duplicate-identification process. For example, if 250,000 extents are identified by a duplicate-identification process, the estimated size of the active log is 358 MB:

$$250,000 \text{ extents identified during each process} \times 1,500 \text{ bytes for each extent} = 358 \text{ MB}$$

Consider the following scenario. Three hundred backup-archive clients back up 100,000 files each night. This activity creates a workload of 30,000,000 files. The average number of extents for each file is two. Therefore, the total number of extents is 60,000,000, and the space requirement for the archive log is 84 GB:

$$60,000,000 \text{ extents} \times 1,500 \text{ bytes for each extent} = 84 \text{ GB}$$

A duplicate-identification process operates on aggregates of files. An aggregate consists of files that are stored in a given transaction, as specified by the TXNGROUPMAX server option. Suppose that the TXNGROUPMAX server option is set to the default of 4096. If the average number of extents for each file is two, the total number of extents in each aggregate is 8192, and the space required for the active log is 12 MB:

$$8192 \text{ extents in each aggregate} \times 1500 \text{ bytes for each extent} = 12 \text{ MB}$$

The timing and number of the duplicate-identification processes

The timing and number of duplicate-identification processes also affects the size of the active log. Using the 12 MB active-log size that was calculated in the preceding example, the concurrent load on the active log is 120 MB if 10 duplicate-identification processes are running in parallel:

$$12 \text{ MB for each process} \times 10 \text{ processes} = 120 \text{ MB}$$

#### File size

Large files that are processed for duplicate identification can also affect the size of the active log. For example, suppose that a backup-archive client backs up an 80 GB, file-system image. This object can have a high number of duplicate extents if, for example, the files included in the file system image were backed up incrementally. For example, assume that a file system image has 1.2 million duplicate extents. The 1.2 million extents in this large file represent a single transaction for a duplicate-identification process. The total space in the active log that is required for this single object is 1.7 GB:

$$1,200,000 \text{ extents} \times 1,500 \text{ bytes for each extent} = 1.7 \text{ GB}$$

If other, smaller duplicate-identification processes occur at the same time as the duplicate-identification process for a single large object, the active log might not have enough space. For example, suppose that a storage pool is enabled for deduplication. The storage pool has a mixture of data, including many relatively small files that range from 10 KB to several hundred KB. The storage pool also has few large objects that have a high percentage of duplicate extents.

To take into account not only space requirements but also the timing and duration of concurrent transactions, increase the estimated size of the active log by a factor of two. For example, suppose that your calculations for space requirements are 25 GB (23.3 GB + 1.7 GB for deduplication of a large object). If deduplication processes are running concurrently, the suggested size of the active log is 50 GB. The suggested size of the archive log is 150 GB.

The examples in the following tables show calculations for active and archive logs. The example in the first table uses an average size of 700 KB for extents. The example in the second table uses an average size of 256 KB. As the examples show, the average deduplicate-extent size of 256 KB indicates a larger estimated size for the active log. To minimize or prevent operational problems for the server, use 256 KB to estimate the size of the active log in your production environment.

**Table 1. Average duplicate-extent size of 700 KB**

Item	Example values		Description
Size of largest single object to deduplicate	800 GB	4 TB	The granularity of processing for deduplication is at the file level. Therefore, the largest single file to deduplicate represents the largest transaction and a correspondingly large load on the active and archive logs.
Average size of extents	700 KB	700 KB	The deduplication algorithms use a variable block method. Not all deduplicated extents for a given file are the same size, so this calculation assumes an average size for extents.
Extents for a given file	1,198,372 bits	6,135,667 bits	Using the average extent size (700 KB), these calculations represent the total number of extents for a given object.  The following calculation was used for an 800 GB object: (800 GB ÷ 700 KB) = 1,198,372 bits  The following calculation was used for a 4 TB object: (4 TB ÷ 700 KB) = 6,135,667 bits
Active log: Suggested size that is required for the deduplication of a single large object during a single duplicate-identification process	1.7 GB	8.6 GB	The estimated active log space that are needed for this transaction.

Item	Example values		Description
Active log: Suggested total size	66 GB <sup>1</sup>	79.8 GB <sup>1</sup>	<p>After considering other aspects of the workload on the server in addition to deduplication, multiply the existing estimate by a factor of two. In these examples, the active log space required to deduplicate a single large object is considered along with previous estimates for the required active log size.</p> <p>The following calculation was used for multiple transactions and an 800 GB object:</p> $(23.3 \text{ GB} + 1.7 \text{ GB}) \times 2 = 50 \text{ GB}$ <p>Increase that amount by the suggested starting size of 16 GB:</p> $50 + 16 = 66 \text{ GB}$ <p>The following calculation was used for multiple transactions and a 4 TB object:</p> $(23.3 \text{ GB} + 8.6 \text{ GB}) \times 2 = 63.8 \text{ GB}$ <p>Increase that amount by the suggested starting size of 16 GB:</p> $63.8 + 16 = 79.8 \text{ GB}$
Archive log: Suggested size	198 GB <sup>1</sup>	239.4 GB <sup>1</sup>	<p>Multiply the estimated size of the active log by a factor of 3.</p> <p>The following calculation was used for multiple transactions and an 800 GB object:</p> $50 \text{ GB} \times 3 = 150 \text{ GB}$ <p>Increase that amount by the suggested starting size of 48 GB:</p> $150 + 48 = 198 \text{ GB}$ <p>The following calculation was used for multiple transactions and a 4 TB object:</p> $63.8 \text{ GB} \times 3 = 191.4 \text{ GB}$ <p>Increase that amount by the suggested starting size of 48 GB:</p> $191.4 + 48 = 239.4 \text{ GB}$
<p><sup>1</sup> The example values in this table are used only to illustrate how the sizes for active logs and archive logs are calculated. In a production environment that uses deduplication, 32 GB is the suggested minimum size for an active log. The suggested minimum size for an archive log in a production environment that uses deduplication is 96 GB. If you substitute values from your environment and the results are larger than 32 GB and 96 GB, use your results to size the active log and archive log.</p> <p>Monitor your logs and adjust their size if necessary.</p>			

Table 2. Average duplicate-extent size of 256 KB

Item	Example values		Description
Size of largest single object to deduplicate	800 GB	4 TB	The granularity of processing for deduplication is at the file level. Therefore, the largest single file to deduplicate represents the largest transaction and a correspondingly large load on the active and archive logs.

Item	Example values		Description
Average size of extents	256 KB	256 KB	The deduplication algorithms use a variable block method. Not all deduplicated extents for a given file are the same size, so this calculation assumes an average extent size.
Extents for a given file	3,276,800 bits	16,777,216 bits	<p>Using the average extent size, these calculations represent the total number of extents for a given object.</p> <p>The following calculation was used for multiple transactions and an 800 GB object:</p> $(800 \text{ GB} \div 256 \text{ KB}) = 3,276,800 \text{ bits}$ <p>The following calculation was used for multiple transactions and a 4 TB object:</p> $(4 \text{ TB} \div 256 \text{ KB}) = 16,777,216 \text{ bits}$
Active log: Suggested size that is required for the deduplication of a single large object during a single duplicate-identification process	4.5 GB	23.4 GB	The estimated size of the active log space that is required for this transaction.
Active log: Suggested total size	71.6 GB <sup>1</sup>	109.4 GB <sup>1</sup>	<p>After considering other aspects of the workload on the server in addition to deduplication, multiply the existing estimate by a factor of 2. In these examples, the active log space required to deduplicate a single large object is considered along with previous estimates for the required active log size.</p> <p>The following calculation was used for multiple transactions and an 800 GB object:</p> $(23.3 \text{ GB} + 4.5 \text{ GB}) \times 2 = 55.6 \text{ GB}$ <p>Increase that amount by the suggested starting size of 16 GB:</p> $55.6 + 16 = 71.6 \text{ GB}$ <p>The following calculation was used for multiple transactions and a 4 TB object:</p> $(23.3 \text{ GB} + 23.4 \text{ GB}) \times 2 = 93.4 \text{ GB}$ <p>Increase that amount by the suggested starting size of 16 GB:</p> $93.4 + 16 = 109.4 \text{ GB}$



Item	Example values		Description
Archive log: Suggested size	214.8 GB <sup>1</sup>	328.2 GB <sup>1</sup>	<p>The estimated size of the active log multiplied by a factor of 3.</p> <p>The following calculation was used for an 800 GB object:</p> $55.6 \text{ GB} \times 3 = 166.8 \text{ GB}$ <p>Increase that amount by the suggested starting size of 48 GB:</p> $166.8 + 48 = 214.8 \text{ GB}$ <p>The following calculation was used for a 4 TB object:</p> $93.4 \text{ GB} \times 3 = 280.2 \text{ GB}$ <p>Increase that amount by the suggested starting size of 48 GB:</p> $280.2 + 48 = 328.2 \text{ GB}$
<p><sup>1</sup> The example values in this table are used only to illustrate how the sizes for active logs and archive logs are calculated. In a production environment that uses deduplication, 32 GB is the suggested minimum size for an active log. The suggested minimum size for an archive log in a production environment that uses deduplication is 96 GB. If you substitute values from your environment and the results are larger than 32 GB and 96 GB, use your results to size the active log and archive log.</p> <p>Monitor your logs and adjust their size if necessary.</p>			

## Linux: Active-log mirror space

The active log can be mirrored so that the mirrored copy can be used if the active log files cannot be read. There can be only one active log mirror.

Creating a log mirror is a suggested option. If you increase the size of the active log, the log mirror size is increased automatically. Mirroring the log can affect performance because of the doubled I/O activity that is required to maintain the mirror. The additional space that the log mirror requires is another factor to consider when deciding whether to create a log mirror.

If the mirror log directory becomes full, the server issues error messages to the activity log and to the db2diag.log. Server activity continues.

## Linux: Archive-failover log space

The archive failover log is used by the server if the archive log directory runs out of space.

Specifying an archive failover log directory can prevent problems that occur if the archive log runs out of space. If both the archive log directory and the drive or file system where the archive failover log directory is located become full, the data remains in the active log directory. This condition can cause the active log to fill up, which causes the server to halt.

## Linux: Monitoring space utilization for the database and recovery logs

To determine the amount of used and available active log space, you issue the QUERY LOG command. To monitor space utilization in the database and recovery logs, you can also check the activity log for messages.

### Active log

If the amount of available active log space is too low, the following messages are displayed in the activity log:

```
ANR4531I: IC_AUTOBACKUP_LOG_USED_SINCE_LAST_BACKUP_TRIGGER
```

This message is displayed when the active log space exceeds the maximum specified size. The IBM Spectrum Protect™ server starts a full database backup.

To change the maximum log size, halt the server. Open the dsmserv.opt file, and specify a new value for the ACTIVELOGSIZE option. When you are finished, restart the server.

**ANR0297I: IC\_BACKUP\_NEEDED\_LOG\_USED\_SINCE\_LAST\_BACKUP**

This message is displayed when the active log space exceeds the maximum specified size. You must back up the database manually.

To change the maximum log size, halt the server. Open the dsmserv.opt file, and specify a new value for the ACTIVELOGSIZE option. When you are finished, restart the server.

**ANR4529I: IC\_AUTOBACKUP\_LOG\_UTILIZATION\_TRIGGER**

The ratio of used active-log space to available active-log space exceeds the log utilization threshold. If at least one full database backup has occurred, the IBM Spectrum Protect server starts an incremental database backup. Otherwise, the server starts a full database backup.

**ANR0295I: IC\_BACKUP\_NEEDED\_LOG\_UTILIZATION**

The ratio of used active-log space to available active-log space exceeds the log utilization threshold. You must back up the database manually.

## Archive log

---

If the amount of available archive log space is too low, the following message is displayed in the activity log:

**ANR0299I: IC\_BACKUP\_NEEDED\_ARCHLOG\_USED**

The ratio of used archive-log space to available archive-log space exceeds the log utilization threshold. The IBM Spectrum Protect server starts a full automatic database backup.

## Database

---

If the amount of space available for database activities is too low, the following messages are displayed in the activity log:

**ANR2992W: IC\_LOG\_FILE\_SYSTEM\_UTILIZATION\_WARNING\_2**

The used database space exceeds the threshold for database space utilization. To increase the space for the database, use the EXTEND DBSPACE command, the EXTEND DBSPACE command, or the DSMSERV FORMAT utility with the DBDIR parameter.

**ANR1546W: FILESYSTEM\_DBPATH\_LESS\_1GB**

The available space in the directory where the server database files are located is less than 1 GB.

When an IBM Spectrum Protect server is created with the DSMSERV FORMAT utility or with the configuration wizard, a server database and recovery log are also created. In addition, files are created to hold database information used by the database manager. The path specified in this message indicates the location of the database information used by the database manager. If space is unavailable in the path, the server can no longer function.

You must add space to the file system or make space available on the file system or disk.

## Linux: Deleting installation rollback files

---

You can delete certain installation files that were saved during the installation process to free space in the shared resource directory. For example, files that might have been required for a rollback operation are types of files that you can delete.

### About this task

---

To delete the files that are no longer needed, use either the installation graphical wizard or the command line in console mode.

- **Linux: Deleting installation rollback files by using a graphical wizard**  
You can delete certain installation files that were saved during installation process by using the IBM® Installation Manager user interface.
- **Linux: Deleting installation rollback files by using the command line**  
You can delete certain installation files that were saved during the installation process by using the command line.

## Linux: Deleting installation rollback files by using a graphical wizard

---

You can delete certain installation files that were saved during installation process by using the IBM® Installation Manager user interface.

## Procedure

---

1. Open IBM Installation Manager.

**Linux** In the directory where IBM Installation Manager is installed, go to the eclipse subdirectory (for example, /opt/IBM/InstallationManager/eclipse), and issue the following command to start IBM Installation Manager:

```
./IBMIM
```

2. Click File > Preferences.
3. Select Files for Rollback.
4. Click Delete Saved Files and click OK.

## Linux: Deleting installation rollback files by using the command line

---

You can delete certain installation files that were saved during the installation process by using the command line.

### Procedure

---

1. In the directory where IBM® Installation Manager is installed, go to the following subdirectory:
  - o **Linux** eclipse/tools

For example:

- o **Linux** /opt/IBM/InstallationManager/eclipse/tools
2. From the tools directory, issue the following command to start an IBM Installation Manager command line:
    - o **Linux** ./imcl -c
  3. Enter **P** to select Preferences.
  4. Enter **B** to select Files for Rollback.
  5. Enter **D** to Delete the Files for Rollback.
  6. Enter **A** to Apply Changes and Return to Preferences Menu.
  7. Enter **C** to leave the Preference Menu.
  8. Enter **X** to Exit Installation Manager.

## Linux: Server naming best practices

---

Use these descriptions as a reference when you install or upgrade an IBM Spectrum Protect™ server.

### Instance user ID

---

The instance user ID is used as the basis for other names related to the server instance. The instance user ID is also called the instance owner.

For example: tsminst1

The instance user ID is the user ID that must have ownership or read/write access authority to all directories that you create for the database and the recovery log. The standard way to run the server is under the instance user ID. That user ID must also have read/write access to the directories that are used for any FILE device classes.

**Linux**

### Home directory for the instance user ID

---

The home directory can be created when creating the instance user ID, by using the option (-m) to create a home directory if it does not exist already. Depending on local settings, the home directory might have the form: /home/instance\_user\_ID

For example: /home/tsminst1

The home directory is primarily used to contain the profile for the user ID and for security settings.

**Linux**

## Database instance name

---

The database instance name must be the same as the instance user ID under which you run the server instance.

For example: tsminst1

Linux

## Instance directory

---

The instance directory is a directory that contains files specifically for a server instance (the server options file and other server-specific files). It can have any name that you want. For easier identification, use a name that ties the directory to the instance name.

You can create the instance directory as a subdirectory of the home directory for the instance user ID. For example:  
`/home/instance_user_ID/instance_user_ID`

The following example places the instance directory in the home directory for user ID tsminst1: `/home/tsminst1/tsminst1`

You can also create the directory in another location, for example: `/tsmsserver/tsminst1`

The instance directory stores the following files for the server instance:

- The server options file, `dsmserv.opt`
- The server key database file, `cert.kdb`, and the `.arm` files (used by clients and other servers to import the Secure Sockets Layer certificates of the server)
- Device configuration file, if the `DEVCONFIG` server option does not specify a fully qualified name
- Volume history file, if the `VOLUMEHISTORY` server option does not specify a fully qualified name
- Volumes for `DEVTYPE=FILE` storage pools, if the directory for the device class is not fully specified, or not fully qualified
- User exits
- Trace output (if not fully qualified)

## Database name

---

The database name is always `TSMDB1`, for every server instance. This name cannot be changed.

## Server name

---

The server name is an internal name for IBM Spectrum Protect, and is used for operations that involve communication among multiple IBM Spectrum Protect servers. Examples include server-to-server communication and library sharing.

Linux The server name is also used when you add the server to the Operations Center so that it can be managed using that interface. Use a unique name for each server. For easy identification in the Operations Center (or from a `QUERY SERVER` command), use a name that reflects the location or purpose of the server. Do not change the name of an IBM Spectrum Protect server after it is configured as a hub or spoke server.

If you use the wizard, the default name that is suggested is the host name of the system that you are using. You can use a different name that is meaningful in your environment. If you have more than one server on the system and you use the wizard, you can use the default name for only one of the servers. You must enter a unique name for each server.

Linux For example:

- `PAYROLL`
- `SALES`

## Directories for database space and recovery log

---

The directories can be named according to local practices. For easier identification, consider using names that tie the directories to the server instance.

For example, for the archive log:

- `Linux /tsminst1_archlog`

## Linux: Installation directories

---

Installation directories for the IBM Spectrum Protect™ server include the server, DB2®, device, language, and other directories. Each one contains several additional directories.

The (/opt/tivoli/tsm/server/bin) is the default directory that contains server code and licensing.

The DB2 product that is installed as part of the installation of the IBM Spectrum Protect server has the directory structure as documented in DB2 information sources. Protect these directories and files as you do the server directories. The default directory is /opt/tivoli/tsm/db2.

You can use US English, German, French, Italian, Spanish, Brazilian Portuguese, Korean, Japanese, traditional Chinese, simplified Chinese, Chinese GBK, Chinese Big5, and Russian.

## Linux: Installing the server components

---

To install the Version 8.1.2 server components, you can use the installation wizard, the command line in console mode, or silent mode.

### About this task

---

Using the IBM Spectrum Protect™ installation software, you can install the following components:

- server  
Tip: The database (DB2®), the Global Security Kit (GSKit) and IBM® Java™ Runtime Environment (JRE) are automatically installed when you select the server component.
- server languages
- license
- devices
- IBM Spectrum Protect for SAN
- Operations Center

**Linux** Allow approximately 30 - 45 minutes to install a V8.1.2 server, using this guide.

- Linux: Obtaining the installation package  
You can obtain the IBM Spectrum Protect installation package from an IBM download site such as Passport Advantage® or IBM Fix Central.
- Linux: Installing IBM Spectrum Protect by using the installation wizard  
You can install the server by using the IBM Installation Manager graphical wizard.
- Linux: Installing IBM Spectrum Protect by using console mode  
You can install IBM Spectrum Protect by using the command line in console mode.
- Linux: Installing IBM Spectrum Protect in silent mode  
You can install or upgrade the server in silent mode. In silent mode, the installation does not send messages to a console but instead stores messages and errors in log files.
- Linux: Installing server language packages  
Translations for the server allow the server to display messages and help in languages other than US English. The translations also allow for the use of locale conventions for date, time, and number formatting.

## Linux: Obtaining the installation package

---

You can obtain the IBM Spectrum Protect™ installation package from an IBM® download site such as Passport Advantage® or IBM Fix Central.

**Linux**

### Before you begin

---

If you plan to download the files, set the system user limit for maximum file size to unlimited to ensure that the files can be downloaded correctly:

1. To query the maximum file size value, issue the following command:

```
ulimit -Hf
```

2. If the system user limit for maximum file size is not set to unlimited, change it to unlimited by following the instructions in the documentation for your operating system.

## Procedure

---

1. Download the appropriate package file from one of the following websites.
  - o Download the server package from Passport Advantage or Fix Central.
  - o For the latest information, updates, and maintenance fixes, go to the IBM Support Portal.
2. If you downloaded the package from an IBM download site, complete the following steps:

### Linux

- a. Verify that you have enough space to store the installation files when they are extracted from the product package. See the download document for the space requirements:
  - IBM Spectrum Protect technote 4042944
  - IBM Spectrum Protect Extended Edition technote 4042945
  - IBM Spectrum Protect for Data Retention technote 4042946
- b. Download the package file to the directory of your choice. The path must contain no more than 128 characters. Be sure to extract the installation files to an empty directory. Do not extract to a directory that contains previously extracted files, or any other files.
- c. Ensure that executable permission is set for the package. If necessary, change the file permissions by issuing the following command:

```
chmod a+x package_name.bin
```

- d. Extract the package by issuing the following command:

```
./package_name.bin
```

where *package\_name* is the name of the downloaded file, for example:

### Linux

```
8.1.x.000-IBM-SPSRV-Linuxx86_64.bin  
8.1.x.000-IBM-SPSRV-Linuxs390x.bin  
8.1.x.000-IBM-SPSRV-Linuxppc64le.bin
```

3. Select one of the following methods of installing IBM Spectrum Protect:
  - o Linux: Installing IBM Spectrum Protect by using the installation wizard
  - o Linux: Installing IBM Spectrum Protect by using console mode
  - o Linux: Installing IBM Spectrum Protect in silent mode
4. After you install IBM Spectrum Protect, and before you customize it for your use, go to the IBM Support Portal. Click Support and downloads and apply any applicable fixes.

## Linux: Installing IBM Spectrum Protect by using the installation wizard

---

You can install the server by using the IBM® Installation Manager graphical wizard.

### Before you begin

---

Take the following actions before you start the installation:

- Verify that the operating system is set to the language that you require. By default, the language of the operating system is the language of the installation wizard.

## Procedure

---

Install IBM Spectrum Protect™ by using this method:

Option	Description
--------	-------------

Option	Description
<b>Installing the software from a downloaded package:</b>	a. Change to the directory where you downloaded the package. b. Start the installation wizard by issuing the following command: <b>Linux</b> <pre>./install.sh</pre>

## What to do next

- If errors occur during the installation process, the errors are recorded in log files that are stored in the IBM Installation Manager logs directory.  
You can view installation log files by clicking File > View Log from the Installation Manager tool. To collect these log files, click Help > Export Data for Problem Analysis from the Installation Manager tool.
- After you install the server and components, and before you customize it for your use, go to the IBM Support Portal. Click Downloads (fixes and PTFs) and apply any applicable fixes.
- Linux** After you install a new server, review Taking the first steps after you install IBM Spectrum Protect to learn about configuring your server.

## Linux: Installing IBM Spectrum Protect by using console mode

You can install IBM Spectrum Protect™ by using the command line in console mode.

### Before you begin

Take the following actions before you start the installation:

- Verify that the operating system is set to the language that you require. By default, the language of the operating system is the language of the installation wizard.

### Procedure

Install IBM Spectrum Protect by using this method:

Option	Description
<b>Installing the software from a downloaded package:</b>	a. Change to the directory where you downloaded the package. b. Start the installation wizard in console mode by issuing the following command: <b>Linux</b> <pre>./install.sh -c</pre> Optional: Generate a response file as part of a console mode installation. Complete the console mode installation options, and in the Summary panel, specify <b>G</b> to generate the responses.

## What to do next

- If errors occur during the installation process, the errors are recorded in log files that are stored in the IBM® Installation Manager logs directory, for example:
  - Linux** /var/ibm/InstallationManager/logs
- After you install the server and components, and before you customize it for your use, go to the IBM Support Portal. Click Downloads (fixes and PTFs) and apply any applicable fixes.
- Linux** After you install a new server, review Taking the first steps after you install IBM Spectrum Protect to learn about configuring your server.

## Linux: Installing IBM Spectrum Protect in silent mode

You can install or upgrade the server in silent mode. In silent mode, the installation does not send messages to a console but instead stores messages and errors in log files.

## Before you begin

---

To provide data input when you use the silent installation method, you can use a response file. The following sample response files are provided in the input directory where the installation package is extracted:

install\_response\_sample.xml

Use this file to install the IBM Spectrum Protect™ components.

update\_response\_sample.xml

Use this file to upgrade the IBM Spectrum Protect components.

These files contain default values that can help you avoid any unnecessary warnings. To use these files, follow the instructions that are provided in the files.

If you want to customize a response file, you can modify the options that are in the file. For information about response files, see Response files.

## Procedure

---

1. Create a response file. You can modify the sample response file or create your own file.
2. If you install the server and Operations Center in silent mode, create a password for the Operations Center truststore in the response file.  
If you are using the install\_response\_sample.xml file, add the password in the following line of the file, where *mypassword* represents the password:

```
<variable name='ssl.password' value='mypassword' />
```

For more information about this password, see Installation checklist

Tip: To upgrade the Operations Center, the truststore password is not required if you are using the update\_response\_sample.xml file.

3. Start the silent installation by issuing the following command from the directory where the installation package is extracted. The value *response\_file* represents the response file path and file name:

o **Linux**

```
./install.sh -s -input response_file -acceptLicense
```

## What to do next

---

- If errors occur during the installation process, the errors are recorded in log files that are stored in the IBM® Installation Manager logs directory, for example:
  - o **Linux** /var/ibm/InstallationManager/logs
- After you install the server and components, and before you customize it for your use, go to the IBM Support Portal. Click Downloads (fixes and PTFs) and apply any applicable fixes.
- **Linux** After you install a new server, review Taking the first steps after you install IBM Spectrum Protect to learn about configuring your server.

**Linux**

## Linux: Installing server language packages

---

Translations for the server allow the server to display messages and help in languages other than US English. The translations also allow for the use of locale conventions for date, time, and number formatting.

## Before you begin

---

For instructions on installing storage agent language packages, see Language pack configuration for storage agents.

- **Linux:** Server language locales  
Use either the default language package option or select another language package to display server messages and help.
- **Linux:** Configuring a language package  
After you configure a language package, messages and help are shown on the server in languages other than US English. Installation packages are provided with IBM Spectrum Protect™.
- **Linux:** Updating a language package  
You can modify or update a language package by using the IBM® Installation Manager.



## Linux: Server language locales

---

Use either the default language package option or select another language package to display server messages and help.

**Linux** This language package is automatically installed for the following default language option for IBM Spectrum Protect™ server messages and help:

- **Linux** LANGUAGE en\_US

For languages or locales other than the default, install the language package that your installation requires.

You can use the languages that are shown:

**Linux**

Table 1. Server languages for Linux

LANGUAGE	LANGUAGE option value
Chinese, Simplified	zh_CN
	zh_CN.gb18030
	zh_CN.utf8
Chinese, Traditional	Big5 / Zh_TW
	zh_TW
	zh_TW.utf8
English, United States	en_US
	en_US.utf8
French	fr_FR
	fr_FR.utf8
German	de_DE
	de_DE.utf8
Italian	it_IT
	it_IT.utf8
Japanese	ja_JP
	ja_JP.utf8
Korean	ko_KR
	ko_KR.utf8
Portuguese, Brazilian	pt_BR
	pt_BR.utf8
Russian	ru_RU
	ru_RU.utf8
Spanish	es_ES
	es_ES.utf8

**Linux** Restriction: For Operations Center users, some characters might not be displayed properly if the web browser does not use the same language as the server. If this problem occurs, set the browser to use the same language as the server.

## Linux: Configuring a language package

---

After you configure a language package, messages and help are shown on the server in languages other than US English. Installation packages are provided with IBM Spectrum Protect™.

### About this task

---

**Linux** To set support for a certain locale, complete one of the following tasks:

- Set the LANGUAGE option in the server options file to the name of the locale that you want to use. For example:
  - **Linux** To use the `it_IT` locale, set the LANGUAGE option to `it_IT`. See [Linux: Server language locales](#).
- **Linux** If you are starting the server in the foreground, set the `LC_ALL` environment variable to match the value that is set in the server options file. For example, to set the environment variable for Italian, enter the following value:

```
export LC_ALL=it_IT
```

If the locale is successfully initialized, it formats the date, time, and number for the server. If the locale is not successfully initialized, the server uses the US English message files and the date, time, and number format.

## Linux: Updating a language package

---

You can modify or update a language package by using the IBM® Installation Manager.

### About this task

---

You can install another language package within the same IBM Spectrum Protect™ instance.

- Use the Modify function of IBM Installation Manager to install another language package.
- Use the Update function of IBM Installation Manager to update to newer versions of the language packages.

Tip: In IBM Installation Manager, the term *update* means to discover and install updates and fixes to installed software packages. In this context, *update* and *upgrade* are synonymous.

## Linux: Taking the first steps after you install IBM Spectrum Protect

---

After you install Version 8.1.2, prepare for the configuration. Using the configuration wizard is the preferred method of configuring the IBM Spectrum Protect™ instance.

### About this task

---

1. **Linux** Update the kernel parameter values.
    - **Linux** See [Linux: Tuning kernel parameters for Linux systems](#).
  2. Create the directories and user ID for the server instance. See [Linux: Creating the user ID and directories for the server instance](#).
  3. Configure a server instance. Select one of the following options:
    - Use the configuration wizard, the preferred method. See [Linux: Configuring IBM Spectrum Protect by using the configuration wizard](#).
    - Manually configure the new instance. See [Linux: Configuring the server instance manually](#). Complete the following steps during a manual configuration.
      - a. Set up your directories and create the IBM Spectrum Protect instance. See [Linux: Creating the server instance](#).
      - b. Create a new server options file by copying the sample file to set up communications between the server and clients. See **Linux** [Linux: Configuring server and client communications](#).
      - c. Issue the `DSMSERV FORMAT` command to format the database. See [Linux: Formatting the database and log](#).
      - d. Configure your system for database backup. See [Linux: Preparing the database manager for database backup](#).
  4. Configure options to control when database reorganization runs. See [Linux: Configuring server options for server database maintenance](#).
  5. Start the server instance if it is not already started.
    - **Linux** See [Linux: Starting the server instance](#).
  6. Register your license. See [Linux: Registering licenses](#).
  7. Prepare your system for database backups. See [Linux: Specifying a device class in preparation for database backups](#).
  8. Monitor the server. See [Linux: Monitoring the server](#).
- **Linux** [Linux: Tuning kernel parameters for Linux systems](#)  
For IBM Spectrum Protect and DB2 to install and operate correctly on Linux, you must update the kernel configuration parameters.

- **Linux:** Creating the user ID and directories for the server instance  
Create the user ID for the IBM Spectrum Protect server instance and create the directories that the server instance needs for database and recovery logs.
- **Linux:** Configuring the IBM Spectrum Protect server  
After you have installed the server and prepared for the configuration, configure the server instance.
- **Linux:** Configuring server options for server database maintenance  
To help avoid problems with database growth and server performance, the server automatically monitors its database tables and reorganizes them when needed. Before starting the server for production use, set server options to control when reorganization runs. If you plan to use data deduplication, ensure that the option to run index reorganization is enabled.
- **Linux:** Starting the server instance  
You can start the server by using the instance user ID, which is the preferred method, or the root user ID.
- **Linux:** Stopping the server  
You can stop the server when needed to return control to the operating system. To avoid losing administrative and client node connections, stop the server only after current sessions are completed or canceled.
- **Linux:** Registering licenses  
Immediately register any IBM Spectrum Protect licensed functions that you purchase so you do not lose any data after you start server operations, such as backing up your data.
- **Linux:** Specifying a device class in preparation for database backups  
To prepare the system for automatic and manual database backups, you must specify the device class to be used.
- **Linux:** Running multiple server instances on a single system  
You can create more than one server instance on your system. Each server instance has its own instance directory, and database and log directories.
- **Linux:** Monitoring the server  
When you start to use the server in production, monitor the space that is used by the server to ensure that the amount of space is adequate. Adjust the space if needed.

Linux

## Linux: Tuning kernel parameters for Linux systems

---

For IBM Spectrum Protect™ and DB2® to install and operate correctly on Linux, you must update the kernel configuration parameters.

### About this task

---

If you do not update these parameters, the installation of DB2 and IBM Spectrum Protect might fail. Even if installation is successful, operational problems might occur if you do not set parameter values.

- **Linux:** Updating kernel parameters on Linux  
DB2 automatically increases interprocess communication (IPC) kernel parameter values to the preferred settings.
- **Linux:** Suggested values for kernel parameters on Linux  
Ensure that the values for kernel parameters are sufficient to prevent operational problems from occurring when you run the IBM Spectrum Protect server.

Linux

## Linux: Updating kernel parameters on Linux

---

DB2® automatically increases interprocess communication (IPC) kernel parameter values to the preferred settings.

### About this task

---

To update the kernel parameters on Linux servers, complete the following steps:

### Procedure

---

1. Issue the `ipcs -l` command to list the parameter values.
2. Analyze the results to determine whether any changes are required for your system. If changes are required, you can set the parameter in the `/etc/sysctl.conf` file. The parameter value is applied when the system starts.

### What to do next

---

For Red Hat Enterprise Linux 6 (RHEL6), you must set the `kernel.shmmax` parameter in the `/etc/sysctl.conf` file before automatically starting the IBM Spectrum Protect™ server on system startup.

For details about the DB2 database for Linux, see the DB2 product information.

Linux

## Linux: Suggested values for kernel parameters on Linux

Ensure that the values for kernel parameters are sufficient to prevent operational problems from occurring when you run the IBM Spectrum Protect™ server.

### About this task

The following table contains the suggested kernel parameter settings to run both IBM Spectrum Protect and DB2®.

Parameter	Description	Preferred value
<code>kernel.randomize_va_space</code>	The <code>kernel.randomize_va_space</code> parameter configures the kernel's use of memory ASLR. When you set the value to 0, <code>kernel.randomize_va_space=0</code> , it disables ASLR. DB2 data servers rely on fixed addresses for certain shared memory objects, and the ASLR can cause errors for some activities. To learn more details about the Linux ASLR and DB2, see the technote at: <a href="http://www.ibm.com/support/docview.wss?uid=swg21365583">http://www.ibm.com/support/docview.wss?uid=swg21365583</a> .	0
<code>vm.swappiness</code>	The <code>vm.swappiness</code> parameter defines whether the kernel can swap application memory out of physical random access memory (RAM). For more information about kernel parameters, see the DB2 product information.	0
<code>vm.overcommit_memory</code>	The <code>vm.overcommit_memory</code> parameter influences how much virtual memory the kernel can permit be allocated. For more information about kernel parameters, see the DB2 product information.	0

## Linux: Creating the user ID and directories for the server instance

Create the user ID for the IBM Spectrum Protect™ server instance and create the directories that the server instance needs for database and recovery logs.

### Before you begin

Review the information about planning space for the server before you complete this task. See Linux: Worksheets for planning details for the server.

### Procedure

1. Create the user ID that will own the server instance. You use this user ID when you create the server instance in a later step.

Linux

Linux Create a user ID and group that will be the owner of the server instance.

- a. The following commands can be run from an administrative user ID that will set up the user and group. Create the user ID and group in the home directory of the user.

Restriction: In the user ID, only lowercase letters (a-z), numerals (0-9), and the underscore character ( `_` ) can be used. The user ID and group name must comply with the following rules:

- The length must be 8 characters or less.

- The user ID and group name cannot start with *ibm*, *sql*, *sys*, or a numeral.
- The user ID and group name cannot be *user*, *admin*, *guest*, *public*, *local*, or any SQL reserved word.

For example, create user ID `tminst1` in group `tmsrvrs`. The following examples show how to create this user ID and group using operating system commands.

**Linux**

```
groupadd tmsrvrs -g 1111
useradd -d /home/tminst1 -u 2222 -g 1111 -s /bin/bash tminst1
passwd tminst1
```

Restriction: DB2® does not support direct operating system user authentication through LDAP.

- Log off, then log in to your system. Change to the user account that you just created. Use an interactive login program, such as `telnet`, so that you are prompted for the password and can change it if necessary.

2. Create directories that the server requires.

**Linux**

Create empty directories for each item in the table and ensure that the directories are owned by the new user ID you just created. Mount the associated storage to each directory for the active log, archive log, and database directories.

Item	Example commands for creating the directories	Your directories
The <i>instance directory</i> for the server, which is a directory that will contain files specifically for this server instance (the server options file and other server-specific files)	<code>mkdir /tminst1</code>	
The database directories	<code>mkdir /tsmdb001</code> <code>mkdir /tsmdb002</code> <code>mkdir /tsmdb003</code> <code>mkdir /tsmdb004</code>	
Active log directory	<code>mkdir /tsmlog</code>	
Archive log directory	<code>mkdir /tsmarchlog</code>	
Optional: Directory for the log mirror for the active log	<code>mkdir /tsmlogmirror</code>	
Optional: Secondary archive log directory (failover location for archive log)	<code>mkdir /tsmarchlogfailover</code>	

When a server is initially created by using the `DSMSERV FORMAT` utility or the configuration wizard, a server database and recovery log are created. In addition, files are created to hold database information that is used by the database manager.

3. Log off the new user ID.

## Linux: Configuring the IBM Spectrum Protect server

After you have installed the server and prepared for the configuration, configure the server instance.

### About this task

Configure an IBM Spectrum Protect™ server instance by selecting one of the following options:

- **Linux: Configuring IBM Spectrum Protect by using the configuration wizard**  
The wizard offers a guided approach to configuring a server. By using the graphical user interface (GUI), you can avoid some configuration steps that are complex when done manually. Start the wizard on the system where you installed the IBM Spectrum Protect server program.
- **Linux: Configuring the server instance manually**  
After installing IBM Spectrum Protect Version 8.1.2, you can configure IBM Spectrum Protect manually instead of using the configuration wizard.

# Linux: Configuring IBM Spectrum Protect by using the configuration wizard

---

The wizard offers a guided approach to configuring a server. By using the graphical user interface (GUI), you can avoid some configuration steps that are complex when done manually. Start the wizard on the system where you installed the IBM Spectrum Protect™ server program.

## Before you begin

---

Before you begin to use the configuration wizard, you must complete all preceding steps to prepare for the configuration. These steps include installing IBM Spectrum Protect, creating the database and log directories, and creating the directories and user ID for the server instance.

## Procedure

---

1. Ensure that the following requirements are met: **Linux**
  - o The system where you installed IBM Spectrum Protect must have the X Window System client. You must also be running an X Window System server on your desktop.
  - o The system must have the Secure Shell (SSH) protocol enabled. Ensure that the port is set to the default value, 22, and that the port is not blocked by a firewall. You must enable password authentication in the `sshd_config` file in the `/etc/ssh/` directory. Also, ensure that the SSH daemon service has access rights for connecting to the system by using the `localhost` value.
  - o You must be able to log in to IBM Spectrum Protect with the user ID that you created for the server instance, by using the SSH protocol. When you use the wizard, you must provide this user ID and password to access that system.
  - o Restart the server before you proceed with the Configuration wizard.
2. Start the local version of the wizard:
  - o **Linux** Open the `dsmicfgx` program in the `/opt/tivoli/tsm/server/bin` directory. This wizard can be only run as a root user.

Follow the instructions to complete the configuration. The wizard can be stopped and restarted, but the server is not operational until the entire configuration process is complete.

## Linux: Configuring the server instance manually

---

After installing IBM Spectrum Protect™ Version 8.1.2, you can configure IBM Spectrum Protect manually instead of using the configuration wizard.

- Linux: Creating the server instance  
Create an IBM Spectrum Protect instance by issuing the `db2icrt` command.
- **Linux** Linux: Configuring server and client communications  
A default sample server options file, `dsmserv.opt.smp`, is created during IBM Spectrum Protect installation in the `/opt/tivoli/tsm/server/bin` directory. You must set up communications between the server and clients by creating a new server options file. To do so, copy the sample file to the directory for the server instance.
- Linux: Formatting the database and log  
Use the `DSMSERV FORMAT` utility to initialize a server instance. No other server activity is allowed while you initialize the database and recovery log.
- Linux: Preparing the database manager for database backup  
To back up the data in the database to IBM Spectrum Protect, you must enable the database manager and configure the IBM Spectrum Protect application programming interface (API).

## Linux: Creating the server instance

---

Create an IBM Spectrum Protect™ instance by issuing the `db2icrt` command.

### About this task

---

You can have one or more server instances on one workstation.

**Linux** Important: Before you run the `db2icrt` command, verify the following items:

- The home directory for the user (/home/tsminst1) exists. If there is no home directory, you must create it. The instance directory stores the following core files that are generated by the IBM Spectrum Protect server:
  - The server options file, dsm serv.opt
  - The server key database file, cert.kdb, and the .arm files (used by clients and other servers to import the Secure Sockets Layer certificates of the server)
  - Device configuration file, if the DEVCONFIG server option does not specify a fully qualified name
  - Volume history file, if the VOLUMEHISTORY server option does not specify a fully qualified name
  - Volumes for DEVTYPE=FILE storage pools, if the directory for the device class is not fully specified, or not fully qualified
  - User exits
  - Trace output (if not fully qualified)
- A shell configuration file (for example, .profile) exists in the home directory. The root user and instance-user ID must have write permission to this file. For more information, see the DB2® product information. Search for Linux and UNIX environment variable settings.

#### Linux

1. Log in using the root user ID and create an IBM Spectrum Protect instance. The name of the instance must be the same name as the user that owns the instance. Use the db2icrt command and enter the command on one line: **Linux**

```
/opt/tivoli/tsm/db2/instance/db2icrt -a server -u
instance_name instance_name
```

For example, if your user ID for this instance is tsminst1, use the following command to create the instance. Enter the command on one line. **Linux**

```
/opt/tivoli/tsm/db2/instance/db2icrt -a server -u
tsminst1 tsminst1
```

Remember: From this point on, use this new user ID when you configure your IBM Spectrum Protect server. Log out of the root user ID and log in under the new instance-user ID.

2. Change the default directory for the database to be the same as the instance directory for the server. If you have multiple servers, log in under the instance ID for each server. Issue this command:

```
db2 update dbm cfg using dftdbpath instance_directory
```

For example, where instance\_directory is the instance user ID:

```
db2 update dbm cfg using dftdbpath /tsminst1
```

3. Modify the library path to use the version of the IBM Global Security Kit (GSKit) that is installed with the server. In the following examples, server\_bin\_directory is a subdirectory of the server installation directory. For example, /opt/tivoli/tsm/server/bin.

- You must update the following files to set the library path when DB2 or the server are started:

Bash or Korn shell example:

```
instance_users_home_directory/sqlllib/userprofile
```

C shell example:

```
instance_users_home_directory/sqlllib/usercshrc
```

- Add the following entry to the instance\_users\_home\_directory/sqlllib/userprofile (Bash or Korn shell) file. Each entry is on one line. **Linux**

```
LD_LIBRARY_PATH=server_bin_directory/dbbkapi:
/opt/ibm/lib:/opt/ibm/lib64:/usr/lib64:$LD_LIBRARY_PATH
```

```
export LD_LIBRARY_PATH
```

Remember: The following entries must be in the library path:

- /usr/local/ibm/gsk8\_64/lib64
- /opt/ibm/lib
- /opt/ibm/lib64
- /usr/lib64

- Add the following entry to the instance\_users\_home\_directory/sqlllib/usercshrc (C shell) file, on one line: **Linux**

```
setenv LD_LIBRARY_PATH server_bin_directory/dbbkapi:  
/opt/ibm/lib:/opt/ibm/lib64:/usr/lib64:$LD_LIBRARY_PATH
```

- o Verify the library path settings and that the GSKit is version 8.0.14.43 or later. Issue the following commands:

Linux

```
echo $LD_LIBRARY_PATH  
gsk8capiCmd_64 -version  
gsk8ver_64
```

If your GSKit version is not 8.0.14.43 or later, you must reinstall the IBM Spectrum Protect server. The reinstallation ensures that the correct GSKit version is available.

4. Create a new server options file. See Linux: Configuring server and client communications.

Linux

## Linux: Configuring server and client communications

---

A default sample server options file, `dsmserv.opt.smp`, is created during IBM Spectrum Protect™ installation in the `/opt/tivoli/tsm/server/bin` directory. You must set up communications between the server and clients by creating a new server options file. To do so, copy the sample file to the directory for the server instance.

### About this task

---

Ensure that you have a server instance directory, for example `/tsminst1`, and copy the sample file to this directory. Name the new file `dsmserv.opt` and edit the options. Complete this set-up before you initialize the server database. Each sample or default entry in the sample options file is a comment, a line beginning with an asterisk (\*). Options are not case-sensitive and one or more blank spaces are allowed between keywords and values.

When editing the options file, follow these guidelines:

- Remove the asterisk at the beginning of the line to activate an option.
- Begin entering the options in any column.
- Enter only one option per line, and the option must be on only one line.
- If you make multiple entries for a keyword, the IBM Spectrum Protect server uses the last entry.

If you change the server options file, you must restart the server for the changes to take effect.

You can specify one or more of the following communication methods:

- TCP/IP Version 4 or Version 6
- Shared memory
- Secure Sockets Layer (SSL)

Tip: You can authenticate passwords with the LDAP directory server, or authenticate passwords with the IBM Spectrum Protect server. Passwords that are authenticated with the LDAP directory server can provide enhanced system security.

- **Linux** Linux: Setting TCP/IP options  
Select from a range of TCP/IP options for the IBM Spectrum Protect server or retain the default.
- **Linux** Linux: Setting shared memory options  
You can use shared memory communications between clients and servers on the same system. To use shared memory, TCP/IP Version 4 must be installed on the system.
- **Linux** Linux: Setting Secure Sockets Layer options  
You can add more protection for your data and passwords by using Secure Sockets Layer (SSL).

## Linux: Setting TCP/IP options

---

Select from a range of TCP/IP options for the IBM Spectrum Protect™ server or retain the default.

### About this task

---

The following is an example of a list of TCP/IP options that you can use to set up your system.

```
commethod      tcpip  
tcpport        1500
```



```
tcpwindow size 0
tcpno delay yes
```

Tip: You can use TCP/IP Version 4, Version 6, or both.

#### TCPSPORT

The server port address for TCP/IP and SSL communication. The default value is 1500.

#### Linux TCPWINDOWSIZE

Specifies the size of the TCP/IP buffer that is used when sending or receiving data. The window size that is used in a session is the smaller of the server and client window sizes. Larger window sizes use additional memory but can improve performance.

You can specify an integer from 0 to 2048. To use the default window size for the operating system, specify 0.

#### TCPNODELAY

Specifies whether or not the server sends small messages or lets TCP/IP buffer the messages. Sending small messages can improve throughput but increases the number of packets sent over the network. Specify YES to send small messages or NO to let TCP/IP buffer them. The default is YES.

#### TCPADMINPORT

Specifies the port number on which the server TCP/IP communication driver is to wait for TCP/IP or SSL-enabled communication requests other than client sessions. The default is the value of TCPSPORT.

#### SSLTCPSPORT

(SSL-only) Specifies the Secure Sockets Layer (SSL) port number on which the server TCP/IP communication driver waits for requests for SSL-enabled sessions for the command-line backup-archive client and the command-line administrative client.

#### SSLTCPADMINPORT

(SSL-only) Specifies the port address on which the server TCP/IP communication driver waits for requests for SSL-enabled sessions for the command-line administrative client.

## Linux: Setting shared memory options

---

You can use shared memory communications between clients and servers on the same system. To use shared memory, TCP/IP Version 4 must be installed on the system.

### About this task

---

The following example shows a shared memory setting:

```
commmethod sharedmem
shmport 1510
```

In this example, SHMPORT specifies the TCP/IP port address of a server when using shared memory. Use the SHMPORT option to specify a different TCP/IP port. The default port address is 1510.

COMMETHOD can be used multiple times in the IBM Spectrum Protect™ server options file, with a different value each time. For example, the following example is possible:

```
commmethod tcpip
commmethod sharedmem
```

Linux You might receive the following message from the server when using shared memory:

```
ANR9999D shmcomm.c(1598): ThreadId<39>
Error from msgget (2), errno = 28
```

The message means that a message queue must be created but the system limit for the maximum number of message queues (MSGMNI) would be exceeded.

Linux To find out the maximum number of message queues (MSGMNI) on your system, issue the following command:

```
cat /proc/sys/kernel/msgmni
```

To increase the MSGMNI value on your system, issue the following command:

```
sysctl -w kernel.msgmni=n
```

where **n** is the maximum number of message queues that you want the system to allow.

## Linux: Setting Secure Sockets Layer options

---

You can add more protection for your data and passwords by using Secure Sockets Layer (SSL).

### Before you begin

---

SSL is the standard technology for creating encrypted sessions between servers and clients. SSL provides a secure channel for servers and clients to communicate over open communication paths. With SSL, the identity of the server is verified through the use of digital certificates.

To ensure better system performance, use SSL only for sessions when it is needed. Consider adding additional processor resources on the IBM Spectrum Protect™ server to manage the increased requirements.

## Linux: Formatting the database and log

---

Use the DSMSEV FORMAT utility to initialize a server instance. No other server activity is allowed while you initialize the database and recovery log.

After you set up server communications, you are ready to initialize the database. Ensure that you log in by using the instance user ID. Do not place the directories on file systems that might run out of space. If certain directories (for example, the archive log) become unavailable or full, the server stops.

For optimal performance and to facilitate I/O, specify at least two equally sized containers or Logical Unit Numbers (LUNs) for the database. In addition, each active log and archive log needs its own container or LUN.

### Setting the exit list handler

---

Set the DB2NOEXITLIST registry variable to ON for each server instance. Log on to the system as the server instance owner and issue this command:

```
db2set -i server_instance_name DB2NOEXITLIST=ON
```

For example: **Linux**

```
db2set -i tsminst1 DB2NOEXITLIST=ON
```

### Initializing a server instance

---

Use the DSMSEV FORMAT utility to initialize a server instance. For example, if the server instance directory is */tsminst1*, issue the following commands: **Linux**

```
cd /tsminst1
dsmsevr format dbdir=/tsmdb001 activelogsiz=32768
activelogdirectory=/activelog archlogdirectory=/archlog
archfailoverlogdirectory=/archfaillog mirrorlogdirectory=/mirrorlog
```

Tip: If you specify multiple directories, ensure that the underlying file systems are of equal size to ensure a consistent degree of parallelism for database operations. If one or more directories for the database are smaller than the others, they reduce the potential for optimized parallel prefetching and distribution of the database.

**Linux** Tip: If DB2® does not start after you issue the DSMSEV FORMAT command, you might need to disable the file system mount option NOSUID. If this option is set on the file system that contains the DB2 instance owner directory, or on any file system that contains the DB2 database, active logs, archive logs, failover logs, or mirrored logs, the option must be disabled to start the system.

After you disable the NOSUID option, remount the file system and then start DB2 by issuing the following command:

```
db2start
```

#### Related information:

[DSMSEV FORMAT \(Format the database and log\)](#)

## Linux: Preparing the database manager for database backup

---

To back up the data in the database to IBM Spectrum Protect™, you must enable the database manager and configure the IBM Spectrum Protect application programming interface (API).

## About this task

**Linux** Starting with IBM Spectrum Protect V7.1, it is no longer necessary to set the API password during a manual configuration of the server. If you set the API password during the manual configuration process, attempts to back up the database might fail.

If you use the configuration wizard to create an IBM Spectrum Protect server instance, you do not have to complete these steps. If you are configuring an instance manually, complete the following steps before you issue either the BACKUP DB or the RESTORE DB commands.

Attention: If the database is unusable, the entire IBM Spectrum Protect server is unavailable. If a database is lost and cannot be recovered, it might be difficult or impossible to recover data that is managed by that server. Therefore, it is critically important to back up the database.

**Linux** In the following commands, replace the example values with your actual values. The examples use `tsminst1` for the server instance user ID, `/tsminst1` for the server instance directory, and `/home/tsminst1` as the server instance users home directory.

1. Set the IBM Spectrum Protect API environment-variable configuration for the database instance:

- a. Log in by using the `tsminst1` user ID.
- b. When user `tsminst1` is logged in, ensure that the DB2® environment is properly initialized. The DB2 environment is initialized by running the `/home/tsminst1/sqllib/db2profile` script, which normally runs automatically from the profile of the user ID. Ensure the `.profile` file exists in the instance users home directory, for example, `/home/tsminst1/.profile`. If `.profile` does not run the `db2profile` script, add the following lines:

```
if [ -f /home/tsminst1/sqllib/db2profile ]; then
    . /home/tsminst1/sqllib/db2profile
fi
```

- c. In the `instance_directory/sqllib/userprofile` file, add the following lines:

```
DSMI_CONFIG=server_instance_directory/tsmdbmgr.opt
DSMI_DIR=server_bin_directory/dbbkapi
DSMI_LOG=server_instance_directory
export DSMI_CONFIG DSMI_DIR DSMI_LOG
```

where:

- *instance\_directory* is the home directory of the server instance user.
- *server\_instance\_directory* is the server instance directory.
- *server\_bin\_directory* is the server bin directory. The default location is `/opt/tivoli/tsm/server/bin`.

In the `instance_directory/sqllib/usercshrc` file, add the following lines:

```
setenv DSMI_CONFIG=server_instance_directory/tsmdbmgr.opt
setenv DSMI_DIR=server_bin_directory/dbbkapi
setenv DSMI_LOG=server_instance_directory
```

2. Log off and log in again as `tsminst1`, or issue this command:

```
. ~/.profile
```

Tip: Ensure that you enter a space after the initial dot (.) character.

3. Create a file that is named `tsmdbmgr.opt` in the *server\_instance* directory, which is in the `/tsminst1` directory in this example, and add the following line:

```
SERVERNAME TSMDBMGR_TSMINST1
```

Remember: The value for `SERVERNAME` must be consistent in the `tsmdbmgr.opt` and `dsm.sys` files.

4. As root user, add the following lines to the IBM Spectrum Protect API `dsm.sys` configuration file. By default, the `dsm.sys` configuration file is in the following default location:

- o *server\_bin\_directory*/dbbkapi/dsm.sys

```
servername TSMDBMGR_TSMINST1
commethod tcpip
tcpserveraddr localhost
tcpport 1500
```

```
errorlogname /tsminst1/tsmdbmgr.log
nodename $$_TSMDBMGR_$$
```

where

- o *servername* matches the *servername* value in the *tsmdbmgr.opt* file.
- o *commethod* specifies the client API that is used to contact the server for database backup. This value can be *tcpip* or *sharedmem*. For more information about shared memory, see step 5.
- o *tcpserveraddr* specifies the server address that the client API uses to contact the server for database backup. To ensure that the database can be backed up, this value must be *localhost*.
- o *tcpport* specifies the port number that the client API uses to contact the server for database backup. Ensure that you enter the same *tcpport* value that is specified in the *dsmserve.opt* server options file.
- o *errorlogname* specifies the error log where the client API logs errors that are encountered during a database backup. This log is typically in the server instance directory. However, this log can be placed in any location where the instance user ID has write-permission.
- o *nodename* specifies the node name that the client API uses to connect to the server during a database backup. To ensure that the database can be backed up, this value must be *\$\$\_TSMDBMGR\_\$\$*.

**Linux** Attention: Do not add the `PASSWORDACCESS generate` option to the `dsm.sys` configuration file. This option can cause the database backup to fail.

5. Optional: Configure the server to back up the database by using shared memory. In this way, you might be able to reduce the processor load and improve throughput. Complete the following steps:
  - a. Review the `dsmserve.opt` file. If the following lines are not in the file, add them:

```
commethod sharedmem
shmport port_number
```

where *port\_number* specifies the port to be used for shared memory.

- b. In the `dsm.sys` configuration file, locate the following lines:

```
commethod tcpip
tcpserveraddr localhost
tcpport port_number
```

Replace the specified lines with the following lines:

```
commethod sharedmem
shmport port_number
```

where *port\_number* specifies the port to be used for shared memory.

## Linux: Configuring server options for server database maintenance

---

To help avoid problems with database growth and server performance, the server automatically monitors its database tables and reorganizes them when needed. Before starting the server for production use, set server options to control when reorganization runs. If you plan to use data deduplication, ensure that the option to run index reorganization is enabled.

### About this task

---

Table and index reorganization requires significant processor resources, active log space, and archive log space. Because database backup takes precedence over reorganization, select the time and duration for reorganization to ensure that the processes do not overlap and reorganization can complete.

**Linux** You can optimize index and table reorganization for the server database. In this way, you can help to avoid unexpected database growth and performance issues. For instructions, see technote 1683633.

If you update these server options while the server is running, you must stop and restart the server before the updated values take effect.

### Procedure

---

1. Modify the server options.

**Linux** Edit the server options file, `dsmserve.opt`, in the server instance directory. Follow these guidelines when you edit the server options file:

- o To enable an option, remove the asterisk at the beginning of the line.
- o Enter an option on any line.
- o Enter only one option per line. The entire option with its value must be on one line.

- If you have multiple entries for an option in the file, the server uses the last entry.
- To view available server options, see the sample file, `dsmserv.opt.smp`, in the `/opt/tivoli/tsm/server/bin` directory.
2. If you plan to use data deduplication, enable the `ALLOWREORGINDEX` server option. Add the following option and value to the server options file:

```
allowreorgindex yes
```

3. Set the `REORGBEGINTIME` and `REORGDURATION` server options to control when reorganization starts and how long it runs. Select a time and duration so that reorganization runs when you expect that the server is least busy. These server options control both table and index reorganization processes.
  - a. Set the time for reorganization to start by using the `REORGBEGINTIME` server option. Specify the time by using the 24-hour system. For example, to set the start time for reorganization as 8:30 p.m., specify the following option and value in the server options file:

```
reorgbegintime 20:30
```

- b. Set the interval during which the server can start reorganization. For example, to specify that the server can start reorganization for four hours after the time set by the `REORGBEGINTIME` server option, specify the following option and value in the server options file:

```
reorgduration 4
```

4. If the server was running while you updated the server options file, stop and restart the server.

#### Related information:

- [ALLOWREORGINDEX](#)
- [ALLOWREORGTABLE](#)
- [REORGBEGINTIME](#)
- [REORGDURATION](#)

Linux

## Linux: Starting the server instance

---

You can start the server by using the instance user ID, which is the preferred method, or the root user ID.

### Before you begin

---

Ensure that you set access permissions and user limits correctly.

Linux For instructions, see [Verifying access rights and user limits](#).

### About this task

---

When you start the server by using the instance user ID, you simplify the setup process and avoid potential issues. However, in some cases, it might be necessary to start the server with the root user ID. For example, you might want to use the root user ID to ensure that the server can access specific devices. You can set up the server to start automatically by using either the instance user ID or the root user ID.

Linux If you must complete maintenance or reconfiguration tasks, start the server in maintenance mode.

### Procedure

---

To start the server, take one of the following actions:

- Start the server by using the instance user ID.

Linux For instructions, see [Starting the server from the instance user ID](#).

- Start the server by using the root user ID.

For instructions about authorizing root user IDs to start the server, see [Authorizing root user IDs to start the server \(V7.1.1\)](#). For instructions about starting the server by using the root user ID, see [Starting the server from the root user ID \(V7.1.1\)](#).

- Linux Start the server automatically.

**Linux** For instructions, see Linux: Automatically starting servers on Linux systems.

- **Linux** Start the server in maintenance mode.

For instructions, see Linux: Starting the server in maintenance mode.

**Linux**

## Linux: Verifying access rights and user limits

Before you start the server, verify access rights and user limits.

### About this task

If you do not verify user limits, also known as *ulimits*, you might experience server instability or a failure of the server to respond. You must also verify the system-wide limit for the maximum number of open files. The system-wide limit must be greater than or equal to the user limit.

### Procedure

1. Verify that the server instance user ID has permissions to start the server.
2. For the server instance that you plan to start, ensure that you have authority to read and write files in the server instance directory. Verify that the `dsmserv.opt` file exists in the server instance directory, and that the file includes parameters for the server instance.
3. If the server is attached to a tape drive, medium changer, or removable media device, and you plan to start the server by using the instance user ID, grant read/write access to the instance user ID for these devices. To set permissions, take one of the following actions:

- If the system is dedicated to IBM Spectrum Protect™ and only the IBM Spectrum Protect administrator has access, make the device special file world-writable. On the operating system command line, issue the following command:

```
chmod +w /dev/rmtX
```

- If the system has multiple users, you can restrict access by making the IBM Spectrum Protect instance user ID the owner of the special device files. On the operating system command line, issue the following command:

```
chmod u+w /dev/rmtX
```

- If multiple user instances are running on the same system, change the group name, for example TAPEUSERS, and add each IBM Spectrum Protect instance user ID to that group. Then, change the ownership of the device special files to belong to the group TAPEUSERS, and make them group-writable. On the operating system command line, issue the following command:

```
chmod g+w /dev/rmtX
```

4. **Linux** If you are using the IBM Spectrum Protect device driver and the `autoconf` utility, use the `-a` option to grant read/write access to the instance user ID.
5. **Linux** To prevent server failures during interaction with DB2®, tune the kernel parameters.

**Linux** For instructions about tuning kernel parameters, see Linux: Tuning kernel parameters for Linux systems.

6. Verify the following user limits based on the guidelines in the table.

Table 1. User limit (ulimit) values

User limit type	Preferred value	Command to query value
Maximum size of core files created	Unlimited	<code>ulimit -Hc</code>
Maximum size of a data segment for a process	Unlimited	<code>ulimit -Hd</code>
Maximum file size	Unlimited	<code>ulimit -Hf</code>
Maximum number of open files	65536	<code>ulimit -Hn</code>
Maximum amount of processor time in seconds	Unlimited	<code>ulimit -Ht</code>

To modify user limits, follow the instructions in the documentation for your operating system.

Tip: If you plan to start the server automatically by using a script, you can set the user limits in the script.

7. Ensure that the user limit of maximum user processes (the `nproc` setting) is set to the minimum suggested value of 16384.
  - a. To verify the current user limit, issue the `ulimit -Hu` command by using the instance user ID. For example:

```
[user@Machine ~]$ ulimit -Hu
16384
```

- b. If the limit of maximum user processes is not set to 16384, set the value to 16384.

**Linux** Add the following line to the `/etc/security/limits.conf` file:

```
instance_user_id          -          nproc          16384
```

where `instance_user_id` specifies the server instance user ID.

**Linux** If the server is installed on the Red Hat Enterprise Linux 6 operating system, set the user limit by editing the `/etc/security/limits.d/90-nproc.conf` file in the `/etc/security/limits.d` directory. This file overrides the settings in the `/etc/security/limits.conf` file.

Tip: The default value for the user limit of maximum user processes has changed on some distributions and versions of the Linux operating system. The default value is 1024. If you do not change the value to the minimum suggested value of 16384, the server might fail or hang.

**Linux**

## Linux: Starting the server from the instance user ID

---

To start the server from the instance user ID, log in with the instance user ID and issue the appropriate command from the server instance directory.

### Before you begin

---

Ensure that access rights and user limits are set correctly. For instructions, see [Linux: Verifying access rights and user limits](#).

### Procedure

---

1. Log in to the system where IBM Spectrum Protect™ is installed by using the instance user ID for the server.
2. If you do not have a user profile that runs the `db2profile` script, issue the following command:

```
. /home/tsminst1/sqlllib/db2profile
```

Tip: For instructions about updating the user ID login script to run the `db2profile` script automatically, see the [DB2®](#) documentation.

3. Start the server by issuing the following command on one line from the server instance directory:

**Linux**

```
usr/bin/dsmserv
```

Tip: The command runs in the foreground so that you can set an administrator ID and connect to the server instance.

**Linux** For example, if the name of the server instance is `tsminst1` and the server instance directory is `/tsminst1`, you can start the instance by issuing the following commands:

```
cd /tsminst1
. ~/sqlllib/db2profile
/usr/bin/dsmserv
```

**Linux**

## Linux: Automatically starting servers on Linux systems

---

To automatically start a server on a Linux operating system, use the `dsmserv.rc` script.

### Before you begin

---

Ensure that kernel parameters are set correctly. For instructions, see [Tuning kernel parameters for Linux systems](#).

Ensure that the server instance runs under the instance owner user ID.

Ensure that access rights and user limits are set correctly. For instructions, see [Verifying access rights and user limits](#).

## About this task

---

The `dsmserv.rc` script is in the server installation directory, for example, `/opt/tivoli/tsm/server/bin`.

The `dsmserv.rc` script can be used either to start the server manually or to start the server automatically by adding entries to the `/etc/rc.d/init.d` directory. The script works with Linux utilities such as `CHKCONFIG` and `SERVICE`.

## Procedure

---

For each server instance that you want to automatically start, complete the following steps:

1. Place a copy of the `dsmserv.rc` script in the `/init.d` directory, for example, `/etc/rc.d/init.d`.

Ensure that you change only the copy of the script. Do not change the original script.

2. Rename the script copy so that it matches the name of the server instance owner, for example, `tsminst1`.

The script was created under the assumption that the server instance directory is *home\_directory/tsminst1*, for example: `/home/tsminst1/tsminst1`.

3. If the server instance directory is not *home\_directory/tsminst1*, locate the following line in the script copy:

```
instance_dir="${instance_home}/tsminst1"
```

Change the line so that it points to your server instance directory, for example:

```
instance_dir="/tsminst1"
```

4. In the script copy, locate the following line:

```
# pidfile: /var/run/dsmserv_instancename.pid
```

Change the instance name value to the name of the server instance owner. For example, if the server instance owner is `tsminst1`, update the line as shown:

```
# pidfile: /var/run/dsmserv_tsminst1.pid
```

5. Configure the run level in which the server automatically starts. By using tools such as the `CHKCONFIG` utility, specify a value that corresponds to a multiuser mode, with networking turned on. Typically, the run level to use is 3 or 5, depending on the operating system and its configuration. For more information about multiuser mode and run levels, see the documentation for your operating system.
6. To start or stop the server, issue one of the following commands:

- o To start the server:

```
service tsminst1 start
```

- o To stop the server:

```
service tsminst1 stop
```

## Example

---

This example uses the following values:

- The instance owner is `tsminst1`.
- The server instance directory is `/home/tsminst1/tsminst1`.
- The `dsmserv.rc` script copy is named `tsminst1`.
- The `CHKCONFIG` utility is used to configure the script to start at run levels 3, 4, and 5.

```
cp /opt/tivoli/tsm/server/bin/dsmserv.rc /etc/rc.d/init.d/tsminst1
sed -i 's/dsmserv_instancename.pid/dsmserv_tsminst1.pid/' /etc/rc.d/init.d/tsminst1
chkconfig --list tsminst1
service tsminst1 supports chkconfig, but is not referenced in
any runlevel (run 'chkconfig --add tsminst1')
chkconfig --add tsminst1
chkconfig --list tsminst1
tsminst1 0:off 1:off 2:off 3:off 4:off 5:off 6:off
chkconfig --level 345 tsminst1 on
```



```
chkconfig --list tsminst1
tsminst1 0:off 1:off 2:off 3:on 4:on 5:on 6:off
```

**Related reference:**

 Server startup script: dsmserv.rc

Linux

## Linux: Starting the server in maintenance mode

---

You can start the server in maintenance mode to avoid disruptions during maintenance and reconfiguration tasks.

### About this task

---

Start the server in maintenance mode by running the DSMSEV utility with the MAINTENANCE parameter.

The following operations are disabled in maintenance mode:

- Administrative command schedules
- Client schedules
- Reclamation of storage space on the server
- Inventory expiration
- Migration of storage pools

In addition, clients are prevented from starting sessions with the server.

Tips:

- You do not have to edit the server options file, dsmserv.opt, to start the server in maintenance mode.
- While the server is running in maintenance mode, you can manually start the storage-space reclamation, inventory expiration, and storage-pool migration processes.

### Procedure

---

To start the server in maintenance mode, issue the following command:

```
dsmserv maintenance
```

Tip: To view a video about starting the server in maintenance mode, see [Starting a server in maintenance mode](#).

### What to do next

---

To resume server operations in production mode, complete the following steps:

1. Shut down the server by issuing the HALT command:

```
halt
```

2. Start the server by using the method that you use in production mode.

Operations that were disabled during maintenance mode are reenabled.

## Linux: Stopping the server

---

You can stop the server when needed to return control to the operating system. To avoid losing administrative and client node connections, stop the server only after current sessions are completed or canceled.

### About this task

---

To stop the server, issue the following command from the IBM Spectrum Protect™ command line:

```
halt
```

Linux

If you cannot connect to the server with an administrative client and you want to stop the server, you must cancel the process by using the kill command with the process ID number (pid). The pid is displayed at initialization.

Important: Before you issue the kill command, ensure that you know the correct process ID for the IBM Spectrum Protect server.

The `dsmserve.v6lock` file, in the directory from which the server is running, can be used to identify the process ID of the process to kill. To display the file, enter:

```
cat /instance_dir/dsmserve.v6lock
```

**Linux** Issue the following command to stop the server:

```
kill -23 dsmserve_pid
```

where `dsmserve_pid` is the process ID number.

## Linux: Registering licenses

---

Immediately register any IBM Spectrum Protect™ licensed functions that you purchase so you do not lose any data after you start server operations, such as backing up your data.

### About this task

---

Use the REGISTER LICENSE command for this task. See REGISTER LICENSE for more details.

### Example: Register a license

---

Register the base IBM Spectrum Protect license.

```
register license file=tsmbasic.lic
```

## Linux: Specifying a device class in preparation for database backups

---

To prepare the system for automatic and manual database backups, you must specify the device class to be used.

### Before you begin

---

Ensure that you have defined a tape or file device class. For details, see DEFINE DEVCLASS, or search for defining a device class.

### About this task

---

Complete the following steps to set up your system for database backups.

### Procedure

---

1. If you did not use the configuration wizard (`dsmicfgx`) to configure the server, ensure that you have completed the steps to manually configure the system for database backups.
2. Select the device class to be used for backups of the database. Issue the following command from an IBM Spectrum Protect™ administrative command line.

```
set dbrecovery device_class_name
```

The device class that you specify is used by the database manager for database backups. If you do not specify a device class with the SET DBRECOVERY command, the backup fails.

### Example

---

For example, to specify that the DBBACK device class is to be used, issue this command:

```
set dbrecovery dbback
```

## Linux: Running multiple server instances on a single system

---

You can create more than one server instance on your system. Each server instance has its own instance directory, and database and log directories.

Multiply the memory and other system requirements for one server by the number of instances planned for the system.

**Linux** The set of files for one instance of the server is stored separately from the files used by another server instance on the same system. Use the steps in Linux: Creating the server instance for each new instance, including creation of the new instance user.

To manage the system memory that is used by each server, use the `DBMEMPERCENT` server option to limit the percentage of system memory. If all servers are equally important, use the same value for each server. If one server is a production server and other servers are test servers, set the value for the production server to a higher value than the test servers.

You can upgrade directly from either V6.3 to V7.1. See the upgrade section (Upgrading to V8.1) for more details. When you upgrade and have multiple servers on your system, you must run the installation wizard only once. The installation wizard collects the database and variables information for all of your original server instances.

If you upgrade from IBM Spectrum Protect V6.3 to V8.1.2 and have multiple servers on your system, all instances that exist in DB2® V9.7 are dropped and recreated in DB2 V11.1. The wizard issues the `db2 upgrade db dbname` command for each database. The database environment variables for each instance on your system are also reconfigured during the upgrade process.

**Related tasks:**

➤ Running multiple server instances on a single system (V7.1.1)

## Linux: Monitoring the server

---

When you start to use the server in production, monitor the space that is used by the server to ensure that the amount of space is adequate. Adjust the space if needed.

### Procedure

---

1. Monitor the active log to ensure that the size is correct for the workload that is handled by the server instance.

When the server workload reaches its typical expected level, the space that is used by the active log is 80% - 90% of the space that is available to the active log directory. At that point, you might need to increase the amount of space. Whether you must increase the space depends on the types of transactions in the server workload. Transaction characteristics affect how the active log space is used.

The following transaction characteristics can affect the space usage in the active log:

- The number and size of files in backup operations
  - Clients such as file servers that back up large numbers of small files can cause large numbers of transactions that are completed quickly. The transactions might use a large amount of space in the active log, but for a short time.
  - Clients such as a mail server or a database server that back up large amounts of data in few transactions can cause small numbers of transactions that take a long time to complete. The transactions might use a small amount of space in the active log, but for a long time.
- Network connection types
  - Backup operations that occur over fast network connections cause transactions that complete more quickly. The transactions use space in the active log for a shorter time.
  - Backup operations that occur over relatively slower connections cause transactions that take a longer time to complete. The transactions use space in the active log for a longer time.

If the server is handling transactions with a wide variety of characteristics, the space that is used for the active log might increase and decrease significantly over time. For such a server, you might need to ensure that the active log typically has a smaller percentage of its space used. The extra space allows the active log to grow for transactions that take a long time to complete.

2. Monitor the archive log to ensure that space is always available.

Remember: If the archive log becomes full, and the failover archive log becomes full, the active log can become full, and the server stops. The goal is to make enough space available to the archive log so that it never uses all its available space.

You are likely to notice the following pattern:

- a. Initially, the archive log grows rapidly as typical client-backup operations occur.
- b. Database backups occur regularly, either as scheduled or done manually.
- c. After at least two full database backups occur, log pruning occurs automatically. The space that is used by the archive log decreases when the pruning occurs.
- d. Normal client operations continue, and the archive log grows again.

- e. Database backups occur regularly, and log pruning occurs as often as full database backups occur.

With this pattern, the archive log grows initially, decreases, and then might grow again. Over time, as normal operations continue, the amount of space that is used by the archive log should reach a relatively constant level.

If the archive log continues to grow, consider taking one or both of these actions:

- o Add space to the archive log. You might need to move the archive log to a different file system.
  - o Increase the frequency of full database backups, so that log pruning occurs more frequently.
3. If you defined a directory for the failover archive log, determine whether any logs get stored in that directory during normal operations. If the failover log space is being used, consider increasing the size of the archive log. The goal is that the failover archive log is used only under unusual conditions, not in normal operation.

## Linux: Installing an IBM Spectrum Protect server fix pack

---

IBM Spectrum Protect™ maintenance updates, which are also referred to as fix packs, bring your server up to the current maintenance level.

### Before you begin

---

To install a fix pack or interim fix to the server, install the server at the level on which you want to run it. You do not have to start the server installation at the base release level. For example, if you currently have V8.1.1 installed, you can go directly to the latest fix pack for V8.1. You do not have to start with the V8.1.0 installation if a maintenance update is available.

You must have the IBM Spectrum Protect license package installed. The license package is provided with the purchase of a base release. When you download a fix pack or interim fix from Fix Central, install the server license that is available on the Passport Advantage® website. To display messages and help in a language other than US English, install the language package of your choice.

If you upgrade the server to V8.1.2 or later, and then revert the server to a level that is earlier than V8.1.2, you must restore the database to a point in time before the upgrade. During the upgrade process, complete the required steps to ensure that the database can be restored: back up the database, the volume history file, the device configuration file, and the server options file. For more information, see Linux: Reverting from Version 8.1.2 to a previous server.

If you are using the client management service, ensure that you upgrade it to the same version as the IBM Spectrum Protect server.

Ensure that you retain the installation media from the base release of the installed server. If you installed IBM Spectrum Protect from a downloaded package, ensure that the downloaded files are available. If the upgrade fails, and the server license module is uninstalled, the installation media from the server base release are required to reinstall the license.

Visit the IBM® Support Portal for the following information:

- A list of the latest maintenance and download fixes. Click **Downloads** and apply any applicable fixes.
- Details about obtaining a base license package. Search for **Downloads > Passport Advantage**.
- Supported platforms and system requirements. Search for **IBM Spectrum Protect supported operating systems**.

Ensure that you upgrade the server before you upgrade backup-archive clients. If you do not upgrade the server first, communication between the server and clients might be interrupted.

Attention: Do not alter the DB2® software that is installed with IBM Spectrum Protect installation packages and fix packs. Do not install or upgrade to a different version, release, or fix pack of DB2 software because doing so can damage the database.

### Procedure

---

To install a fix pack or interim fix, complete the following steps:

1. Back up the database. The preferred method is to use a snapshot backup. A snapshot backup is a full database backup that does not interrupt any scheduled database backups. For example, issue the following IBM Spectrum Protect administrative command:

```
backup db type=dbsnapshot devclass=tapeclass
```

2. Back up the device configuration information. Issue the following IBM Spectrum Protect administrative command:

```
backup devconfig filenames=file_name
```

where *file\_name* specifies the name of the file in which to store device configuration information.

3. Save the volume history file to another directory or rename the file. Issue the following IBM Spectrum Protect administrative command:

```
backup volhistory filenames=file_name
```

where *file\_name* specifies the name of the file in which to store the volume history information.

4. Save a copy of the server options file, typically named `dsmserv.opt`. The file is in the server instance directory.
5. Halt the server before installing a fix pack or interim fix. Use the HALT command.
6. Ensure that extra space is available in the installation directory. The installation of this fix pack might require additional temporary disk space in the installation directory of the server. The amount of additional disk space can be as much as that required for installing a new database as part of an IBM Spectrum Protect installation. The IBM Spectrum Protect installation wizard displays the amount of space that is required for installing the fix pack and the available amount. If the required amount of space is greater than the available amount, the installation stops. If the installation stops, add the required disk space to the file system and restart the installation.
7. **Linux** Log in as the root user.
8. Obtain the package file for the fix pack or interim fix that you want to install from the IBM Support Portal, Passport Advantage, or Fix Central.
9. **Linux** Change to the directory where you placed the executable file and complete the following steps.  
Tip: The files are extracted to the current directory. Ensure that the executable file is in the directory where you want the extracted files to be located.
  - a. Change file permissions by entering the following command:

```
chmod a+x 8.x.x.x-IBM-SPSRV-platform.bin
```

where *platform* denotes the architecture that IBM Spectrum Protect is to be installed on.

- b. Issue the following command to extract the installation files:

```
./8.x.x.x-IBM-SPSRV-platform.bin
```

10. Select one of the following ways of installing IBM Spectrum Protect.

Important: After a fix pack is installed, it is not necessary to go through the configuration again. You can stop after completing the installation, fix any errors, then restart your servers.

Install the IBM Spectrum Protect software by using one of the following methods:

#### Installation wizard

Follow the instructions for your operating system:

Linux: Installing IBM Spectrum Protect by using the installation wizard

Tip: After you start the wizard, in the IBM Installation Manager window, click the Update icon; do not click the Install or Modify icon.

#### Command line in console mode

Follow the instructions for your operating system:

Linux: Installing IBM Spectrum Protect by using console mode

#### Silent mode

Follow the instructions for your operating system:

Linux: Installing IBM Spectrum Protect in silent mode

Tip: If you have multiple server instances on your system, run the installation wizard only once. The installation wizard upgrades all server instances.

## Results

---

Correct any errors that are detected during the installation process.

If you installed the server by using the installation wizard, you can view installation logs by using the IBM Installation Manager tool. Click File > View Log. To collect log files, from the IBM Installation Manager tool, click Help > Export Data for Problem Analysis.

If you installed the server by using console mode or silent mode, you can view error logs in the IBM Installation Manager log directory, for example:

- **Linux** `/var/ibm/InstallationManager/logs`

# Linux: Reverting from Version 8.1.2 to a previous server

---

If you must revert to the previous version of the server after an upgrade, you must have a full database backup from your original version. You must also have the server installation media for your original version and key configuration files. Carefully follow the preparation steps before you upgrade the server. By doing so, it might be possible to revert to the previous version of the IBM Spectrum Protect™ server with minimal loss of data.

## Before you begin

---

You must have the following items from the earlier version of the server:

- Server database backup
- Volume history file
- Device configuration file
- Server options file

## About this task

---

Use the same instructions whether you are reverting within releases or to an earlier release, for example, from 8.1.2 to 8.1.1 or from 8.1.2 to 7.1.2. The older version must match the version that you used before the upgrade to V8.1.

Attention: Specify the REUSEDELAY parameter to help prevent backup-archive client data loss when you revert the server to a previous version.

## Steps for reverting to the previous server version

---

### About this task

Complete the following steps on the system that has the V8.1 server.

### Procedure

1. Halt the server to shut down all server operations by using the HALT command.
2. Remove the database from the database manager, then delete the database and recovery log directories.
  - a. Manually remove the database. One way to remove it is by issuing this command: `Linux`

```
dsmserv removedb tsmdb1
```
  - b. If you must reuse the space that is occupied by the database and recovery log directories, you can now delete these directories.
3. Use the uninstallation program to uninstall the V8.1 server. Uninstallation removes the server and the database manager, with their directories. For details, see [Linux: Uninstalling IBM Spectrum Protect](#).
4. Stop the cluster service. Reinstall the version of the server program that you were using before the upgrade to V8.1.2. This version must match the version that your server was running when you created the database backup that you restore in a later step. For example, the server was at V7.1.7 before the upgrade, and you intend to use the database backup that was in use on this server. You must install the V7.1.7 fix pack to be able to restore the database backup.
5. Configure the new server database by using the configuration wizard. To start the wizard, issue the following command: `Linux`

```
./dsmicfgx
```
6. Ensure that no servers are running in the background.
7. Restore the database to a point in time before the upgrade.
8. Copy the following files to the instance directory.
  - Device configuration file
  - Volume history file
  - The server options file (typically dsmserv.opt)
9. If you enabled data deduplication for any FILE-type storage pools that existed before the upgrade, or if you moved data that existed before the upgrade into new storage pools while using the V8.1.2 server, you must complete additional recovery steps. For more details, see [Additional recovery steps if you created new storage pools or enabled data deduplication](#).
10. If the REUSEDELAY parameter setting on storage pools is less than the age of the database that you restored, restore volumes on any sequential-access storage pools that were reclaimed after that database backup. Use the RESTORE

VOLUME command.

If you do not have a backup of a storage pool, audit the reclaimed volumes by using the AUDIT VOLUME command, with the FIX=YES parameter to resolve inconsistencies. For example:

```
audit volume volume_name fix=yes
```

11. If client backup or archive operations were completed using the V8.1 server, audit the storage pool volumes on which the data was stored.

## Additional recovery steps if you created new storage pools or enabled data deduplication

---

If you created new storage pools, turned on data deduplication for any FILE-type storage pools, or did both while your server was running as a V8.1.2 server, you must complete more steps to return to the previous server version.

### Before you begin

To complete this task, you must have a complete backup of the storage pool that was created before the upgrade to V8.1.2.

### About this task

Use this information if you did either or both of the following actions while your server was running as a V8.1.2 server:

- You enabled the data deduplication function for any storage pools that existed before the upgrade to V8.1.2 program. Data deduplication applies only to storage pools that use a FILE device type.
- You created new primary storage pools after the upgrade *and* moved data that was stored in other storage pools into the new storage pools.

Complete these steps after the server is again restored to V7.

### Procedure

- For each storage pool for which you enabled the data deduplication function, restore the entire storage pool by using the RESTORE STGPPOOL command.
- For storage pools that you created after the upgrade, determine what action to take. Data that was moved from existing V8 storage pools into the new storage pools might be lost because the new storage pools no longer exist in your restored V8 server. Possible recovery depends on the type of storage pool:
  - If data was moved from V8 DISK-type storage pools into a new storage pool, space that was occupied by the data that was moved was probably reused. Therefore, you must restore the original V8 storage pools by using the storage pool backups that were created before the upgrade to V8.1.2.

If *no* data was moved from V8 DISK-type storage pools into a new storage pool, then audit the storage pool volumes in these DISK-type storage pools.

- If data was moved from V8 sequential-access storage pools into a new storage pool, that data might still exist and be usable in storage pool volumes on the restored V8 server. The data might be usable if the REUSEDDELAY parameter for the storage pool was set to a value that prevented reclamation while the server was running as a V8.1.2 server. If any volumes were reclaimed while the server was running as a V8.1.2 server, restore those volumes from storage pool backups that were created before the upgrade to V8.1.2.

## Linux: Reference: DB2 commands for IBM Spectrum Protect server databases

---

Use this list as reference when you are directed to issue DB2® commands by IBM® support.

### Purpose

---

After using the wizards to install and configure IBM Spectrum Protect™, you seldom need to issue DB2 commands. A limited set of DB2 commands that you might use or be asked to issue are listed in Table 1. This list is supplemental material only and is not a comprehensive list. There is no implication that an IBM Spectrum Protect administrator will use it on a daily or ongoing basis. Samples of some commands are provided. Details of output are not listed.

For a full explanation of the commands described here and of their syntax, see the DB2 product information.

Table 1. DB2 commands

Command	Description	Example
db2icrt	<p>Creates DB2 instances in the home directory of the instance owner.</p> <p>Tip: The IBM Spectrum Protect configuration wizard creates the instance used by the server and database. After a server is installed and configured through the configuration wizard, the db2icrt command is generally not used.</p> <p><b>Linux</b> This utility is in the DB2DIR/instance directory, where DB2DIR represents the installation location where the current version of the DB2 database system is installed.</p>	<p>Manually create an IBM Spectrum Protect instance. Enter the command on one line:</p> <pre> /opt/tivoli /tsm/db2/in stance/ db2icrt -a server -u instance_na me instance_na me                     </pre>
db2set	Displays DB2 variables.	<p>List DB2 variables:</p> <pre> db2set                     </pre>
CATALOG DATABASE	Stores database location information in the system database directory. The database can be located either on the local workstation or on a remote database partition server. The server configuration wizard takes care of any catalog needed for using the server database. Run this command manually, after a server is configured and running, only if something in the environment changes or is damaged.	<p>Catalog the database:</p> <pre> db2 catalog database tsmdb1                     </pre>
CONNECT TO DATABASE	Connects to a specified database for command-line interface (CLI) use.	<p>Connect to the IBM Spectrum Protect database from a DB2 CLI:</p> <pre> db2 connect to tsmdb1                     </pre>
GET DATABASE CONFIGURATION	Returns the values of individual entries in a specific database configuration file. Important: This command and parameters are set and managed directly by DB2. They are listed here for informational purposes and a means to view the existing settings. Changing these settings might be advised by IBM support or through service bulletins such as APARs or Technical Guidance documents (technotes). Do not change these settings manually. Change them only at the direction of IBM and only through the use of IBM Spectrum Protect server commands or procedures.	<p>Show the configuration information for a database alias:</p> <pre> db2 get db cfg for tsmdb1                     </pre> <p>Retrieve information in order to verify settings such as database configuration, log mode, and maintenance.</p> <pre> db2 get db config for tsmdb1 show detail                     </pre>



Command	Description	Example
GET DATA BASE MAN AGE R CON FIGU RATI ON	Returns the values of individual entries in a specific database configuration file. Important: This command and parameters are set and managed directly by DB2. They are listed here for informational purposes and a means to view the existing settings. Changing these settings might be advised by IBM support or through service bulletins such as APARs or Technical Guidance documents (technotes). Do not change these settings manually. Change them only at the direction of IBM and only through the use of IBM Spectrum Protect server commands or procedures.	Retrieve configuration information for the database manager:  db2 get dbm cfg
GET HEAL TH SNA PSH OT	Retrieves the health status information for the database manager and its databases. The information returned represents a snapshot of the health state at the time the command was issued. IBM Spectrum Protect monitors the state of the database using the health snapshot and other mechanisms that are provided by DB2. There might be cases where the health snapshot or other DB2 documentation indicates that an item or database resource might be in an alert state. Such a case indicates that action must be considered to remedy the situation. IBM Spectrum Protect monitors the condition and responds appropriately. Not all declared alerts by the DB2 database are acted on.	Receive a report on DB2 health monitor indicators:  db2 get health snapshot for database on tsmdb1
GRA NT (Data base Auth oritie s)	Grants authorities that apply to the entire database rather than privileges that apply to specific objects within the database.	Grant access to the user ID itmuser:  db2 GRANT CONNECT ON DATABASE TO USER itmuser db2 GRANT CREATETAB ON DATABASE TO USER itmuser
RUN STAT S	Updates statistics about the characteristics of a table and associated indexes or statistical views. These characteristics include number of records, number of pages, and average record length.  To see a table, issue this utility after updating or reorganizing the table.  A view must be enabled for optimization before its statistics can be used to optimize a query. A view that is enabled for optimization is known as a statistical view. Use the DB2 ALTER VIEW statement to enable a view for optimization. Issue the RUNSTATS utility when changes to underlying tables substantially affect the rows returned by the view.  Tip: The server configures DB2 to run the RUNSTATS command as needed.	Update statistics on a single table.  db2 runstats on table SCHEMA_NAME .TABLE_NAME with distributio n and sampled detailed indexes all
SET SCH EMA	Changes the value of the CURRENT SCHEMA special register, in preparation for issuing SQL commands directly through the DB2 CLI. Tip: A special register is a storage area that is defined for an application process by the database manager. It is used to store information that can be referenced in SQL statements.	Set the schema for IBM Spectrum Protect:  db2 set schema tsmdb1

Command	Description	Example
START DATABASE MANAGER	Starts the current database manager instance background processes. The server starts and stops the instance and database whenever the server starts and halts.  Important: Allow the server to manage the starting and stopping of the instance and database unless otherwise directed by IBM support.	Start the database manager:  <code>db2start</code>
STOP DATABASE MANAGER	Stops the current database manager instance. Unless explicitly stopped, the database manager continues to be active. This command does not stop the database manager instance if any applications are connected to databases. If there are no database connections, but there are instance attachments, the command forces the instance attachments to stop first. Then, it stops the database manager. This command also deactivates any outstanding database activations before stopping the database manager.  This command is not valid on a client.  The server starts and stops the instance and database whenever the server starts and halts.  Important: Allow the server to manage the starting and stopping of the instance and database unless otherwise directed by IBM support.	Stop the database manager:  <code>db2 stop dbm</code>

## Linux: Uninstalling IBM Spectrum Protect

You can use the following procedures to uninstall IBM Spectrum Protect™. Before you remove IBM Spectrum Protect, ensure that you do not lose your backup and archive data.

### Before you begin

Complete the following steps before you uninstall IBM Spectrum Protect:

- Complete a full database backup.
- Save a copy of the volume history and device configuration files.
- Store the output volumes in a safe location.

### About this task

You can uninstall IBM Spectrum Protect by using any of the following methods: a graphical wizard, the command line in console mode, or silent mode.

- **Linux: Uninstalling IBM Spectrum Protect by using a graphical wizard**  
You can uninstall IBM Spectrum Protect by using the IBM® Installation Manager installation wizard.
- **Linux: Uninstalling IBM Spectrum Protect in console mode**  
To uninstall IBM Spectrum Protect by using the command line, you must run the uninstallation program of IBM Installation Manager from the command line with the parameter for console mode.
- **Linux: Uninstalling IBM Spectrum Protect in silent mode**  
To uninstall IBM Spectrum Protect in silent mode, you must run the uninstallation program of IBM Installation Manager from the command line with the parameters for silent mode.
- **Linux: Uninstalling and reinstalling IBM Spectrum Protect**  
If you plan to manually reinstall IBM Spectrum Protect instead of using the wizard, there are a number of steps to take to preserve your server instance names and database directories. During an uninstallation, any server instances previously set up are removed, but the database catalogs for those instances still exist.
- **Linux: Uninstalling IBM Installation Manager**  
You can uninstall IBM Installation Manager if you no longer have any products that were installed by IBM Installation Manager.

### What to do next

See Linux: Installing the server components for installation steps to reinstall the IBM Spectrum Protect components.

# Linux: Uninstalling IBM Spectrum Protect by using a graphical wizard

---

You can uninstall IBM Spectrum Protect™ by using the IBM® Installation Manager installation wizard.

## Procedure

---

1. Start the Installation Manager.

**Linux** In the directory where the Installation Manager is installed, go to the eclipse subdirectory (for example, /opt/IBM/InstallationManager/eclipse), and issue the following command:

```
./IBMIM
```

2. Click Uninstall.
3. Select IBM Spectrum Protect server, and click Next.
4. Click Uninstall.
5. Click Finish.

## Linux: Uninstalling IBM Spectrum Protect in console mode

---

To uninstall IBM Spectrum Protect™ by using the command line, you must run the uninstallation program of IBM® Installation Manager from the command line with the parameter for console mode.

## Procedure

---

1. In the directory where IBM Installation Manager is installed, go to the following subdirectory:
  - o **Linux** eclipse/tools

For example:

- o **Linux** /opt/IBM/InstallationManager/eclipse/tools
2. From the tools directory, issue the following command:
  - o **Linux** ./imcl -c
3. To uninstall, enter 5.
4. Choose to uninstall from the IBM Spectrum Protect package group.
5. Enter **N** for Next.
6. Choose to uninstall the IBM Spectrum Protect server package.
7. Enter **N** for Next.
8. Enter **U** for Uninstall.
9. Enter **F** for Finish.

## Linux: Uninstalling IBM Spectrum Protect in silent mode

---

To uninstall IBM Spectrum Protect™ in silent mode, you must run the uninstallation program of IBM® Installation Manager from the command line with the parameters for silent mode.

## Before you begin

---

You can use a response file to provide data input to silently uninstall the IBM Spectrum Protect server components. IBM Spectrum Protect includes a sample response file, `uninstall_response_sample.xml`, in the input directory where the installation package is extracted. This file contains default values to help you avoid any unnecessary warnings.

If you want to uninstall all IBM Spectrum Protect components, leave `modify="false"` set for each component in the response file. If you do not want to uninstall a component, set the value to `modify="true"`.

If you want to customize the response file, you can modify the options that are in the file. For information about response files, see Response files.

## Procedure

---

1. In the directory where IBM Installation Manager is installed, go to the following subdirectory:
  - o **Linux** eclipse/tools

For example:

- o `Linux` /opt/IBM/InstallationManager/eclipse/tools
2. From the tools directory, issue the following command, where *response\_file* represents the response file path, including the file name:

```
Linux  
./imcl -input response_file -silent
```

The following command is an example:

```
Linux  
./imcl -input /tmp/input/uninstall_response.xml -silent
```

## Linux: Uninstalling and reinstalling IBM Spectrum Protect

---

If you plan to manually reinstall IBM Spectrum Protect™ instead of using the wizard, there are a number of steps to take to preserve your server instance names and database directories. During an uninstallation, any server instances previously set up are removed, but the database catalogs for those instances still exist.

### About this task

---

To manually uninstall and reinstall IBM Spectrum Protect, complete the following steps:

1. `Linux` Make a list of your current server instances before proceeding to the uninstallation. Run the following command:

```
/opt/tivoli/tsm/db2/instance/db2ilist
```

2. Run the following commands for every server instance:

```
Linux  
db2 attach to instance_name  
db2 get dbm cfg show detail  
db2 detach
```

Keep a record of the database path for each instance.

3. Uninstall IBM Spectrum Protect. See Linux: Uninstalling IBM Spectrum Protect.
4. When you uninstall any supported version of IBM Spectrum Protect, including a fix pack, an instance file is created. The instance file is created to help reinstall IBM Spectrum Protect. Check this file and use the information when you are prompted for the instance credentials when reinstalling. In silent installation mode, you provide these credentials using the `INSTANCE_CRED` variable.

You can find the instance file in the following location:

- o `Linux` /etc/tivoli/tsm/instanceList.obj
5. Reinstall IBM Spectrum Protect. See Linux: Installing the server components.

If the `instanceList.obj` file does not exist, you need to recreate your server instances using the following steps:

- a. Recreate your server instances. See Linux: Creating the server instance.  
Tip: The installation wizard configures the server instances but you must verify that they exist. If they do not exist, you must manually configure them.
- b. Catalog the database. Log in to each server instance as the instance user, one at a time, and issue the following commands:

```
Linux  
db2 catalog database tsmdb1  
db2 attach to instance_name  
db2 update dbm cfg using dftdbpath instance_directory  
db2 detach
```

- c. `Linux` Verify that the server instance was created successfully. Issue this command:

```
/opt/tivoli/tsm/db2/instance/db2ilist
```

- d. Verify that IBM Spectrum Protect recognizes the server instance by listing your directories. Your home directory appears if you did not change it. Your instance directory does appear if you used the configuration wizard. Issue this command:

```
db2 list database directory
```

If you see TSMDDB1 listed, you can start the server.

## Linux: Uninstalling IBM Installation Manager

---

You can uninstall IBM® Installation Manager if you no longer have any products that were installed by IBM Installation Manager.

### Before you begin

---

Before you uninstall IBM Installation Manager, you must ensure that all packages that were installed by IBM Installation Manager are uninstalled. Close IBM Installation Manager before you start the uninstall process.

**Linux** To view installed packages, issue the following command from a command line:

```
cd /opt/IBM/InstallationManager/eclipse/tools
./imcl listInstalledPackages
```

### Procedure

---

To uninstall IBM Installation Manager, complete the following steps:

**Linux**

1. Open a command line and change directories to `/var/ibm/InstallationManager/uninstall`.
2. Issue the following command:

```
./uninstall
```

Restriction: You must be logged in to the system as the `root` user ID.

## Windows: Installing the server

---

Installation of the server includes planning, installation, and initial configuration.

- **Windows: Planning to install the server**  
Install the server software on the computer that manages storage devices and install the client software on every workstation that transfers data to IBM Spectrum Protect™ server-managed storage.
- **Windows: Installing the server components**  
To install the Version 8.1.2 server components, you can use the installation wizard, the command line in console mode, or silent mode.
- **Windows: Taking the first steps after you install IBM Spectrum Protect**  
After you install Version 8.1.2, prepare for the configuration. Using the configuration wizard is the preferred method of configuring the IBM Spectrum Protect instance.
- **Windows: Installing an IBM Spectrum Protect server fix pack**  
IBM Spectrum Protect maintenance updates, which are also referred to as fix packs, bring your server up to the current maintenance level.
- **Windows: Reverting from Version 8.1.2 to a previous server**  
If you must revert to the previous version of the server after an upgrade, you must have a full database backup from your original version. You must also have the server installation media for your original version and key configuration files. Carefully follow the preparation steps before you upgrade the server. By doing so, it might be possible to revert to the previous version of the IBM Spectrum Protect server with minimal loss of data.
- **Windows: Reference: DB2 commands for IBM Spectrum Protect server databases**  
Use this list as reference when you are directed to issue DB2® commands by IBM® support.
- **Windows: Uninstalling IBM Spectrum Protect**  
You can use the following procedures to uninstall IBM Spectrum Protect. Before you remove IBM Spectrum Protect, ensure that you do not lose your backup and archive data.

## Windows: Planning to install the server

---

Install the server software on the computer that manages storage devices and install the client software on every workstation that transfers data to IBM Spectrum Protect™ server-managed storage.

- **Windows: What you should know first**  
Before installing IBM Spectrum Protect, be familiar with your operating systems, storage devices, communication protocols, and system configurations.
- **Windows: What you should know about security before you install or upgrade the server**  
Before you install IBM Spectrum Protect V8.1.2 or later, review information about the enhanced security features and the requirements for updating your environment.
- **Windows: Planning for optimal performance**  
Before you install the IBM Spectrum Protect server, evaluate the characteristics and configuration of the system to ensure that the server is set up for optimal performance.
- **Windows** **Windows: Minimum system requirements for Windows systems**  
The server can require a large amount of memory, network bandwidth, and processor resources. In many cases, the server performs best when other applications are not installed on the same system.
- **Windows: IBM Installation Manager**  
IBM Spectrum Protect uses IBM® Installation Manager, which is an installation program that can use remote or local software repositories to install or update many IBM products.
- **Windows: Worksheets for planning details for the server**  
You can use the worksheets to help you plan the amount and location of storage needed for the IBM Spectrum Protect server. You can also use them to keep track of names and user IDs.
- **Windows: Capacity planning**  
Capacity planning for IBM Spectrum Protect includes managing resources such as the database, the recovery log and the shared resource area. To maximize resources as part of capacity planning, you must estimate space requirements for the database and the recovery log. The shared resource area must have enough space available for each installation or upgrade.
- **Windows: Server naming best practices**  
Use these descriptions as a reference when you install or upgrade an IBM Spectrum Protect server.
- **Windows: Installation directories**  
Installation directories for the IBM Spectrum Protect server include the server, DB2®, device, language, and other directories. Each one contains several additional directories.

## Windows: What you should know first

---

Before installing IBM Spectrum Protect™, be familiar with your operating systems, storage devices, communication protocols, and system configurations.

Server maintenance releases, client software, and publications are available from the IBM® Support Portal.

**Windows** **Restriction:** You cannot install and run the Version 8.1.2 server on a system that already has DB2® installed on it, whether DB2 was installed by itself or as part of some other application. The V8.1.2 server requires the installation and use of the DB2 version that is packaged with the V8.1.2 server. No other version of DB2 can exist on the system.

**Windows** You can install the IBM Spectrum Protect server on a domain controller. The server can have heavy processor usage, however, and that might affect and stall other applications.

Experienced DB2 administrators can choose to perform advanced SQL queries and use DB2 tools to monitor the database. Do not, however, use DB2 tools to change DB2 configuration settings from those that are preset by IBM Spectrum Protect, or alter the DB2 environment for IBM Spectrum Protect in other ways, such as with other products. The V8.1.2 server has been built and tested extensively using the data definition language (DDL) and database configuration that the server deploys.

**Attention:** Do not alter the DB2 software that is installed with IBM Spectrum Protect installation packages and fix packs. Do not install or upgrade to a different version, release, or fix pack of DB2 software because doing so can damage the database.

## Windows: What you should know about security before you install or upgrade the server

---

Before you install IBM Spectrum Protect™ V8.1.2 or later, review information about the enhanced security features and the requirements for updating your environment.

### About this task

---

Security enhancements that were introduced in V8.12 and later enforce stricter security settings. To ensure that communication between servers and clients is not interrupted when you install or upgrade IBM Spectrum Protect software to V8.1.2, follow the

procedure.

## Procedure

---

1. Install or upgrade the IBM Spectrum Protect servers to 8.1.2 or later.
2. Install or upgrade the backup-archive clients. For more information, see [Installing and configuring clients](#).  
For information about scheduling deployment of client updates from the server, see the following documents:
  - o For IBM Spectrum Protect 8.1.2 or later servers, see [technote 2004596](#).
  - o For IBM® Tivoli® Storage Manager V7.1 servers and IBM Spectrum Protect V8.1.0 and V8.1.1 servers, see [technote 1673299](#).
3. Configure the options for backup-archive clients. For more information, see [Upgrading the IBM Spectrum Protect Server and the IBM Spectrum Protect Client](#).

## Windows: Planning for optimal performance

---

Before you install the IBM Spectrum Protect™ server, evaluate the characteristics and configuration of the system to ensure that the server is set up for optimal performance.

### Procedure

---

1. Review [Windows: What you should know first](#).
2. Review each of the following sub-sections.
  - [Windows: Planning for the server hardware and the operating system](#)  
Use the checklist to verify that the system where the server is installed meets requirements for hardware and software configuration.
  - [Windows: Planning for the server database disks](#)  
Use the checklist to verify that the system where the server is installed meets requirements for hardware and software configuration.
  - [Windows: Planning for the server recovery log disks](#)  
Use the checklist to verify that the system where the server is installed meets requirements for hardware and software configuration.
  - [Windows: Planning for directory-container and cloud-container storage pools](#)  
Review how your directory-container and cloud-container storage pools are set up to ensure optimal performance.
  - [Windows: Planning for storage pools in DISK or FILE device classes](#)  
Use the checklist to review how your disk storage pools are set up. This checklist includes tips for storage pools that use DISK or FILE device classes.
  - [Windows: Planning for the correct type of storage technology](#)  
Storage devices have different capacity and performance characteristics. These characteristics affect which devices are better for use with IBM Spectrum Protect.
  - [Windows: Applying best practices to the server installation](#)  
Typically, hardware configuration and selection have the most significant effect on the performance of an IBM Spectrum Protect solution. Other factors that affect performance are the operating system selection and configuration, and the configuration of IBM Spectrum Protect.

## Windows: Planning for the server hardware and the operating system

---

Use the checklist to verify that the system where the server is installed meets requirements for hardware and software configuration.

Question	Tasks, characteristics, options, or settings	More information
----------	--	------------------

Question	Tasks, characteristics, options, or settings	More information
<p>Does the operating system and hardware meet or exceed requirements?</p> <ul style="list-style-type: none"> <li>• Number and speed of processors</li> <li>• System memory</li> <li>• Supported operating system level</li> </ul>	<p>If you are using the minimum required amount of memory, you can support a minimal workload.</p> <p>You can experiment by adding more system memory to determine whether the performance is improved. Then, decide whether you want to keep the system memory dedicated to the server. Test the memory variations by using the entire daily cycle of the server workload.</p> <p>If you run multiple servers on the system, add the requirements for each server to get the requirements for the system.</p>	<p>Review operating system requirements at technote 1243309.</p> <p>Additionally, review the guidance in Tuning tasks for operating systems and other applications.</p> <p>For more information about requirements when these features are in use, see the following topics:</p> <ul style="list-style-type: none"> <li>• Checklist for data deduplication</li> <li>• Checklist for node replication</li> </ul> <p>For more information about sizing requirements for the server and storage, see the IBM Spectrum Protect™ Blueprint.</p>
<p>Are disks configured for optimal performance?</p>	<p>The amount of tuning that can be done for different disk systems varies. Ensure that the appropriate queue depths and other disk system options are set.</p>	<p>For more information, see the following topics:</p> <ul style="list-style-type: none"> <li>• "Planning for server database disks"</li> <li>• "Planning for server recovery log disks"</li> <li>• "Planning for storage pools in DISK or FILE device classes"</li> </ul>



Question	Tasks, characteristics, options, or settings	More information
Does the server have enough memory?	<p>Heavier workloads and advanced features such as data deduplication and node replication require more than the minimum system memory that is specified in the system requirements document.</p> <p>For databases that are not enabled for data deduplication, use the following guidelines to specify memory requirements:</p> <ul style="list-style-type: none"> <li>• For databases less than 500 GB, you need 16 GB of memory.</li> <li>• For databases with a size of 500 GB - 1 TB, you need 24 GB of memory.</li> <li>• For databases with a size of 1 TB - 1.5 TB, you need 32 GB of memory.</li> <li>• For databases greater than 1.5 TB, you need 40 GB of memory.</li> </ul> <p>Ensure that you allocate extra space for the active log and the archive log for replication processing.</p>	<p>For more information about requirements when these features are in use, see the following topics:</p> <ul style="list-style-type: none"> <li>• Checklist for data deduplication</li> <li>• Checklist for node replication</li> <li>• Memory requirements</li> </ul>
Does the system have enough host bus adapters (HBAs) to handle the data operations that the IBM Spectrum Protect server must run simultaneously?	<p>Understand what operations require use of HBAs at the same time.</p> <p>For example, a server must store 1 GB/sec of backup data while also doing storage pool migration that requires 0.5 GB/sec capacity to complete. The HBAs must be able to handle all of the data at the speed required.</p>	See Tuning HBA capacity.

Question	Tasks, characteristics, options, or settings	More information
Is network bandwidth greater than the planned maximum throughput for backups?	<p>Network bandwidth must allow the system to complete operations such as backups in the time that is allowed or that meets service level commitments.</p> <p>For node replication, network bandwidth must be greater than the planned maximum throughput.</p>	<p>For more information, see the following topics:</p> <ul style="list-style-type: none"> <li>• Tuning network performance</li> <li>• Checklist for node replication</li> </ul>
Are you using a preferred file system for IBM Spectrum Protect server files?	<p>Use a file system that ensures optimal performance and data availability. The server uses direct I/O with file systems that support the feature. Using direct I/O can improve throughput and reduce processor use. The following list identifies the preferred file system:</p> <ul style="list-style-type: none"> <li>• <b>Windows</b> Use New Technology File System (NTFS) without compression.</li> </ul>	<p>For more information, see Configuring the operating system for disk performance.</p>
Are you planning to configure enough paging space?	<p>Paging space, or swap space, extends the memory that is available for processing. When the amount of free RAM in the system is low, programs or data that is not in use are moved from memory to paging space. This action releases memory for other activities, such as database operations.</p> <p><b>Windows</b> Paging space is automatically configured.</p>	

## Windows: Planning for the server database disks

Use the checklist to verify that the system where the server is installed meets requirements for hardware and software configuration.

Question	Tasks, characteristics, options, or settings	More information
----------	--	------------------

Question	Tasks, characteristics, options, or settings	More information
Is the database on fast, low-latency disks?	<p>Do not use the following drives for the IBM Spectrum Protect™ database:</p> <ul style="list-style-type: none"> <li>• Nearline SAS (NL-SAS)</li> <li>• Serial Advanced Technology Attachment (SATA)</li> <li>• Parallel Advanced Technology Attachment (PATA)</li> </ul> <p>Do not use internal disks that are included by default in most server hardware.</p> <p>Enterprise-grade solid-state disks (SSD), with Fibre Channel or SAS interface, offer the best performance.</p> <p>If you plan to use the data deduplication functions of IBM Spectrum Protect, focus on disk performance in terms of I/O operations per second (IOPS).</p>	For more information, see Checklist for data deduplication.
Is the database stored on disks or LUNs that are separate from disks or LUNs that are used for the active log, archive log, and storage pool volumes?	<p>Separation of the server database from other server components helps reduce contention for the same resources by different operations that must run at the same time.</p> <p>Tip: The database and the archive log can share an array when you use solid-state drive (SSD) technology.</p>	
If you are using RAID, do you know how to select the optimal RAID level for your system? Are you defining all LUNs with the same size and type of RAID?	<p>When a system must do large numbers of writes, RAID 10 outperforms RAID 5. However, RAID 10 requires more disks than RAID 5 for the same amount of usable storage.</p> <p>If your disk system is RAID, define all your LUNs with the same size and type of RAID. For example, do not mix 4+1 RAID 5 with 4+2 RAID 6.</p>	
If an option to set the strip size or segment size is available, are you planning to optimize the size when you configure the disk system?	If you can set the strip size or segment size, use 64 KB or 128 KB sizes on disk systems for the database.	The block size that is used for the database varies depending on the table space. Most table spaces use 8 KB blocks, but some use 32 KB blocks.

Question	Tasks, characteristics, options, or settings	More information
<p>Are you planning to create at least four directories, also called storage paths, on four separate LUNs for the database?</p> <p>Create one directory per distinct array on the subsystem. If you have fewer than three arrays, create a separate LUN volume within the array.</p>	<p>Heavier workloads and use of some features require more database storage paths than the minimum requirements.</p> <p>Server operations such as data deduplication drive a high number of input/output operations per second (IOPS) for the database. Such operations perform better when the database has more directories.</p> <p>For server databases that are larger than 2 TB or are expected to grow to that size, use eight directories.</p> <p>Consider planned growth of the system when you determine how many storage paths to create. The server uses the higher number of storage paths more effectively if the storage paths are present when the server is first created.</p> <p>Use the <i>DB2_PARALLEL_IO</i> variable to force parallel I/O to occur on table spaces that have one container, or on table spaces that have containers on more than one physical disk. If you do not set the <i>DB2_PARALLEL_IO</i> variable, I/O parallelism is equal to the number of containers that are used by the table space. For example, if a table space spans four containers, the level of I/O parallelism that is used is 4.</p>	<p>For more information, see the following topics:</p> <ul style="list-style-type: none"> <li>• Checklist for data deduplication</li> <li>• Checklist for node replication</li> </ul> <p>For help with forecasting growth when the server deduplicates data, see technote 1596944.</p> <p>For the most recent information about database size, database reorganization, and performance considerations for IBM Spectrum Protect servers, see technote 1683633.</p> <p>For information about setting the <i>DB2_PARALLEL_IO</i> variable, see Recommended settings for IBM DB2 registry variables.</p>
<p>Are all directories for the database the same size?</p>	<p>Directories that are all the same size ensure a consistent degree of parallelism for database operations. If one or more directories for the database are smaller than the others, they reduce the potential for optimized parallel prefetching.</p> <p>This guideline also applies if you must add storage paths after the initial configuration of the server.</p>	
<p>Are you planning to raise the queue depth of the database LUNs on AIX® systems?</p>	<p>The default queue depth is often too low.</p>	<p>See Configuring AIX systems for disk performance.</p>

## Windows: Planning for the server recovery log disks

Use the checklist to verify that the system where the server is installed meets requirements for hardware and software configuration.

Question	Tasks, characteristics, options, or settings	More information
<p>Are the active log and archive log stored on disks or LUNs that are separate from what is used for the database and storage pool volumes?</p>	<p>Ensure that the disks where you place the active log are not used for other server or system purposes. Do not place the active log on disks that contain the server database, the archive log, or system files such as page or swap space.</p>	<p>Separation of the server database, active log, and archive log helps to reduce contention for the same resources by different operations that must run at the same time.</p>

Question	Tasks, characteristics, options, or settings	More information
Are the logs on disks that have nonvolatile write cache?	Nonvolatile write cache allows data to be written to the logs as fast as possible. Faster write operations for the logs can improve performance for server operations.	
Are you setting the logs to a size that adequately supports the workload?	<p>If you are not sure about the workload, use the largest size that you can.</p> <p><b>Active log</b> The maximum size is 512 GB, set with the ACTIVELOGSIZE server option.</p> <p>Ensure that there is at least 8 GB of free space on the active log file system after the fixed size active logs are created.</p> <p><b>Archive log</b> The size of the archive log is limited by the size of the file system on which it is located, and not by a server option. Make the archive log at least as large as the active log.</p>	<ul style="list-style-type: none"> <li>For log sizing details, see the recovery log information in technote 1421060.</li> <li>For information about sizing when you use data deduplication, see Checklist for data deduplication.</li> </ul>
Are you defining an archive failover log? Are you placing this log on a disk that is separate from the archive log?	The archive failover log is for emergency use by the server when the archive log becomes full. Slower disks can be used for the archive failover log.	<p>Use the ARCHFAILOVERLOGDIRECTORY server option to specify the location of the archive failover log.</p> <p>Monitor the usage of the directory for the archive failover log. If the archive failover log must be used by the server, the space for the archive log might not be large enough.</p>
If you are mirroring the active log, are you using only one type of mirroring?	<p>You can mirror the log by using one of the following methods. Use only one type of mirroring for the log.</p> <ul style="list-style-type: none"> <li>Use the MIRRORLOGDIRECTORY option that is available for the IBM Spectrum Protect™ server to specify a mirror location.</li> <li>Use software mirroring, such as Logical Volume Manager (LVM) on AIX®.</li> <li>Use mirroring in the disk system hardware.</li> </ul>	<p>If you mirror the active log, ensure that the disks for both the active log and the mirror copy have equal speed and reliability.</p> <p>For more information, see Configuring and tuning the recovery log.</p>

## Windows: Planning for directory-container and cloud-container storage pools

Review how your directory-container and cloud-container storage pools are set up to ensure optimal performance.

Question	Tasks, characteristics, options, or settings	More information
----------	--	------------------

Question	Tasks, characteristics, options, or settings	More information
<p>Measured in terms of input/output operations per second (IOPS), are you using fast disk storage for the IBM Spectrum Protect™ database?</p>	<p>Use a high-performance disk for the database. Use solid-state drive technology for data deduplication processing.</p> <p>Ensure that the database has a minimum capability of 3000 IOPS. For each TB of data that is backed up daily (before data deduplication), add 1000 IOPS to this minimum.</p> <p>For example, an IBM Spectrum Protect server that is ingesting 3 TB of data per day would need 6000 IOPS for the database disks:</p> $3000 \text{ IOPS minimum} + 3000 (3 \text{ TB} \times 1000 \text{ IOPS}) = 6000 \text{ IOPS}$	<p>For recommendations about disk selection, see "Planning for server database disks".</p> <p>For more information about IOPS, see the IBM Spectrum Protect Blueprints.</p>
<p>Do you have enough memory for the size of your database?</p>	<p>Use a minimum of 40 GB of system memory for IBM Spectrum Protect servers, with a database size of 100 GB, that are deduplicating data. If the retained capacity of backup data grows, the memory requirement might need to be higher.</p> <p>Monitor memory usage regularly to determine whether more memory is required.</p> <p>Use more system memory to improve caching of database pages. The following memory size guidelines are based on the daily amount of new data that you back up:</p> <ul style="list-style-type: none"> <li>• 128 GB of system memory for daily backups of data, where the database size is 1 - 2 TB</li> <li>• 192 GB of system memory for daily backups of data, where the database size is 2 - 4 TB</li> </ul>	<p>Memory requirements</p>

Question	Tasks, characteristics, options, or settings	More information
<p>Have you properly sized the storage capacity for the database active log and archive log?</p>	<p>Configure the server to have a minimum active log size of 128 GB by setting the ACTIVELOGSIZE server option to a value of 131072.</p> <p>The suggested starting size for the archive log is 1 TB. The size of the archive log is limited by the size of the file system on which it is located, and not by a server option. Ensure that there is at least 10% extra disk space for the file system than the size of the archive log.</p> <p>Use a directory for the database archive logs with an initial free capacity of at least 1 TB. Specify the directory by using the ARCHLOGDIRECTORY server option.</p> <p>Define space for the archive failover log by using the ARCHFAILOVERLOGDIRECTORY server option.</p>	<p>For more information about sizing for your system, see the IBM Spectrum Protect Blueprints.</p>
<p>Is compression enabled for the archive log and database backups?</p>	<p>Enable the ARCHLOGCOMPRESS server option to save storage space.</p> <p>This compression option is different from inline compression. Inline compression is enabled by default with IBM Spectrum Protect V7.1.5 and later.</p> <p>Restriction: Do not use this option if the amount of backed up data exceeds 6 TB per day.</p>	<p>For more information about compression for your system, see the IBM Spectrum Protect Blueprints.</p>
<p>Are the IBM Spectrum Protect database and logs on separate disk volumes (LUNs)?</p> <p>Is the disk that is used for the database configured according to best practices for a transactional database?</p>	<p>The database must not share disk volumes with IBM Spectrum Protect database logs or storage pools, or with any other application or file system.</p>	<p>For more information about server database and recovery log configuration, see Server database and recovery log configuration and tuning.</p>
<p>Are you using a minimum of eight (2.2 GHz or equivalent) processor cores for each IBM Spectrum Protect server that you plan to use with data deduplication?</p>	<p>If you are planning to use client-side data deduplication, verify that client systems have adequate resources available during a backup operation to complete data deduplication processing. Use a processor that is at least the minimum equivalent of one 2.2 GHz processor core per backup process with client-side data deduplication.</p>	<ul style="list-style-type: none"> <li>• Effective planning and use of deduplication</li> <li>• IBM Spectrum Protect Blueprints</li> </ul>

Question	Tasks, characteristics, options, or settings	More information
Did you allocate enough storage space for the database?	<p>For a rough estimate, plan for 100 GB of database storage for every 50 TB of data that is to be protected in deduplicated storage pools. <i>Protected data</i> is the amount of data before data deduplication, including all versions of objects stored.</p> <p>As a best practice, define a new container storage pool exclusively for data deduplication. Data deduplication occurs at the storage-pool level, and all data within a storage pool, except encrypted data, is deduplicated.</p>	
Have you estimated storage pool capacity to configure enough space for the size of your environment?	<p>You can estimate capacity requirements for a deduplicated storage pool by using the following technique:</p> <ol style="list-style-type: none"> <li>1. Estimate the base size of the source data.</li> <li>2. Estimate the daily backup size by using an estimated change and growth rate.</li> <li>3. Determine retention requirements.</li> <li>4. Estimate the total amount of source data by factoring in the base size, daily backup size, and retention requirements.</li> <li>5. Apply the deduplication ratio factor.</li> <li>6. Apply the compression ratio factor.</li> <li>7. Round up the estimate to consider transient storage pool usage.</li> </ol>	For an example of using this technique, see Effective planning and use of deduplication.
Have you distributed disk I/O over many disk devices and controllers?	<p>Use arrays that consist of as many disks as possible, which is sometimes referred to as wide striping. Ensure that you use one database directory per distinct array on the subsystem.</p> <p>Set the <i>DB2_PARALLEL_IO</i> registry variable to enable parallel I/O for each table space used if the containers in the table space span multiple physical disks.</p> <p>When I/O bandwidth is available and the files are large, for example 1 MB, the process of finding duplicates can occupy the resources of an entire processor. When files are smaller, other bottlenecks can occur.</p> <p>Specify eight or more file systems for the deduplicated storage pool device class so that I/O is distributed across as many LUNs and physical devices as possible.</p>	<p>For guidelines about setting up storage pools, see "Planning for storage pools in DISK or FILE device classes".</p> <p>For information about setting the <i>DB2_PARALLEL_IO</i> variable, see Recommended settings for IBM DB2 registry variables.</p>



Question	Tasks, characteristics, options, or settings	More information
Have you scheduled daily operations based on your backup strategy?	<p>The best practice sequence of operations is in the following order:</p> <ol style="list-style-type: none"> <li>1. Client backup</li> <li>2. Storage pool protection</li> <li>3. Node replication</li> <li>4. Database backup</li> <li>5. Expire inventory</li> </ol>	<ul style="list-style-type: none"> <li>• Scheduling data deduplication and node replication processes</li> <li>• Daily operations for directory-container storage pools</li> </ul>
Do you have enough storage to manage the DB2® lock list?	<p>If you deduplicate data that includes large files or large numbers of files concurrently, the process can result in insufficient storage space. When the lock list storage is insufficient, backup failures, data management process failures, or server outages can occur.</p> <p>File sizes greater than 500 GB that are processed by data deduplication are most likely to deplete storage space. However, if many backup operations use client-side data deduplication, this problem can also occur with smaller-sized files.</p>	For information about tuning the DB2 LOCKLIST parameter, see Tuning server-side data deduplication.
Is sufficient bandwidth available to transfer data to an IBM Spectrum Protect server?	<p>To transfer data to an IBM Spectrum Protect server, use client-side or server-side data deduplication and compression to reduce the bandwidth that is required.</p> <p>Use a V7.1.5 server or higher to use inline compression and use a V7.1.6 or later client to enable enhanced compression processing.</p>	For more information, see the enablededup client option.
Have you determined how many storage pool directories to assign to each storage pool?	<p>Assign directories to a storage pool by using the DEFINE STGPOOLDIRECTORY command.</p> <p>Create multiple storage pool directories and ensure that each directory is backed up to a separate disk volume (LUN).</p>	

Question	Tasks, characteristics, options, or settings	More information
<p>Did you allocate enough disk space in the cloud-container storage pool?</p>	<p>To prevent backup failures, ensure that the local directory has enough space. Use the following list as a guide for optimal disk space:</p> <ul style="list-style-type: none"> <li>• For serial-attached SCSI (SAS) and spinning disk, calculate the amount of new data that is expected after daily data reduction (compression and data deduplication). Allocate up to 100 percent of that amount, in terabytes, for disk space.</li> <li>• Provide 3 TB for flash-based storage systems with fast network connections to on-premises, high-performance cloud systems.</li> <li>• Provide 5 TB for solid-state drive (SSD) systems with fast network connections to high-performance cloud systems.</li> </ul>	
<p>Did you select the appropriate type of local storage?</p>	<p>Ensure that data transfers from local storage to cloud finish before the next backup cycle starts.  Tip: Data is removed from local storage soon after it moves to the cloud.  Use the following guidelines:</p> <ul style="list-style-type: none"> <li>• Use flash or SSD for large systems that have high-performing cloud systems. Ensure that you have a dedicated 10 GB wide area network (WAN) link with a high-speed connection to the object storage. For example, use flash or SSD if you have a dedicated 10 GB WAN link plus a high-speed connection to either an IBM® Cloud Object Storage location or to an Amazon Simple Storage Service (Amazon S3) data center.</li> <li>• Use larger capacity 15000 rpm SAS disks for these scenarios: <ul style="list-style-type: none"> <li>◦ Medium-sized systems</li> <li>◦ Slower cloud connections, for example, 1 GB</li> <li>◦ When you use IBM Cloud Object Storage as your service provider across several regions</li> </ul> </li> <li>• For SAS or spinning disk, calculate the amount of new data that is expected after daily data reduction (compression and data deduplication). Allocate up to 100 percent of that amount for disk space, in terabytes.</li> </ul>	

## Windows: Planning for storage pools in DISK or FILE device classes

Use the checklist to review how your disk storage pools are set up. This checklist includes tips for storage pools that use DISK or FILE device classes.

Question	Tasks, characteristics, options, or settings	More information
Can the storage pool LUNs sustain throughput rates for 256 KB sequential reads and writes to adequately handle the workload within the time constraints?	<p>When you are planning for peak loads, consider all the data that you want the server to read or write to the disk storage pools simultaneously. For example, consider the peak flow of data from client backup operations and server data-movement operations such as migration that run at the same time.</p> <p>The IBM Spectrum Protect™ server reads and writes to storage pools predominantly in 256 KB blocks.</p> <p>If the disk system includes the capability, configure the disk system for optimal performance with sequential read/write operations rather than random read/write operations.</p>	For more information, see Analyzing the basic performance of disk systems.
Is the disk configured to use read and write cache?	Use more cache for better performance.	
For storage pools that use FILE device classes, have you determined a good size to use for the storage pool volumes?	Review the information in Optimal number and size of volumes for storage pools that use disk. If you do not have the information to estimate a size for FILE device class volumes, start with volumes that are 50 GB.	Typically, problems arise more frequently when the volumes are too small. Few problems are reported when volumes are larger than needed. When you determine the volume size to use, as a precaution choose a size that might be larger than necessary.
For storage pools that use FILE device classes, are you using preallocated volumes?	<p>Scratch volumes can cause file fragmentation.</p> <p>To ensure that a storage pool does not run out of volumes, set the MAXSCRATCH parameter to a value greater than zero.</p>	<p>Use the DEFINE VOLUME server command to preallocate volumes in the storage pool.</p> <p>Use the DEFINE STGPOOL or UPDATE STGPOOL server command to set the MAXSCRATCH parameter.</p>
For storage pools that use FILE device classes, have you compared the maximum number of client sessions to the number of volumes that are defined?	Always maintain enough usable volumes in the storage pools to allow for the expected peak number of client sessions that run at one time. The volumes might be scratch volumes, empty volumes, or partly filled volumes.	For storage pools that use FILE device classes, only one session or process can write to a volume at the same time.

Question	Tasks, characteristics, options, or settings	More information
<p>For storage pools that use FILE device classes, have you set the MOUNTLIMIT parameter of the device class to a value that is high enough to account for the number of volumes that might be mounted in parallel?</p>	<p>For storage pools that use data deduplication, the MOUNTLIMIT parameter is typically in the range of 500 - 1000.</p> <p>Set the value for MOUNTLIMIT to the maximum number of mount points that are needed for all active sessions. Consider parameters that affect the maximum number of mount points that are needed:</p> <ul style="list-style-type: none"> <li>• The MAXSESSIONS server option, which is the maximum number of IBM Spectrum Protect sessions that can run concurrently.</li> <li>• The MAXNUMMP parameter, which sets the maximum number of mount points that each client node can use.</li> </ul> <p>For example, if the maximum number of client node backup sessions is typically 100 and each of the nodes has MAXNUMMP=2, multiply 100 nodes by the 2 mount points for each node to get the value of 200 for the MOUNTLIMIT parameter.</p>	<p>Use the REGISTER NODE or UPDATE NODE server command to set the MAXNUMMP parameter for client nodes.</p>
<p>For storage pools that use DISK device classes, have you determined how many storage pool volumes to put on each file system?</p>	<p>How you configure the storage for a storage pool that uses a DISK device class depends on whether you are using RAID for the disk system.</p> <p>If you are not using RAID, then configure one file system per physical disk, and define one storage pool volume for each file system.</p> <p>If you are using RAID 5 with <math>n + 1</math> volumes, configure the storage in one of the following ways:</p> <ul style="list-style-type: none"> <li>• Configure <math>n</math> file systems on the LUN and define one storage pool volume per file system.</li> <li>• Configure one file system and <math>n</math> storage pool volumes for the LUN.</li> </ul>	<p>For an example layout that follows this guideline, see Sample layout of server storage pools.</p>
<p>Did you create your storage pools to distribute I/O across multiple file systems?</p>	<p>Ensure that each file system is on a different LUN on the disk system.</p> <p>Typically, having 10 - 30 file systems is a good goal, but ensure that the file systems are no smaller than approximately 250 GB.</p>	<p>For details, see the following topics:</p> <ul style="list-style-type: none"> <li>• Tuning disk storage for the server</li> <li>• Tuning and configuring storage pools and volumes</li> </ul>

## Windows: Planning for the correct type of storage technology

Storage devices have different capacity and performance characteristics. These characteristics affect which devices are better for use with IBM Spectrum Protect™.

### Procedure

Review the following table to help you to choose the correct type of storage technology for the storage resources that the server requires.

Table 1. Storage technology types for IBM Spectrum Protect storage requirements

<b>Storage technology type</b>	<b>Database</b>	<b>Active log</b>	<b>Archive log and archive failover log</b>	<b>Storage pools</b>
<b>Solid-state disk (SSD)</b>	Place the database on SSD in the following circumstances: <ul style="list-style-type: none"> <li>You are using IBM Spectrum Protect data deduplication.</li> <li>You are backing up more than 8 TB of new data daily.</li> </ul>	If you place the IBM Spectrum Protect database on an SSD, as a best practice, place the active log on an SSD. If space is not available, use high-performance disk instead.	Save SSDs for use with the database and active log. The archive log and archive failover logs can be placed on slower storage technology types.	Save SSDs for use with the database and active log. Storage pools can be placed on slower storage technology types.
<b>High-performance disk with the following characteristic s:</b> <ul style="list-style-type: none"> <li><b>15k rpm disk</b></li> <li><b>Fibre Channel or serial-attached SCSI (SAS) interface</b></li> </ul>	Use high-performance disks in the following circumstances: <ul style="list-style-type: none"> <li>The server does not do data deduplication.</li> <li>The server does not do node replication.</li> </ul> Isolate the server database from its logs and storage pools, and from data for other applications.	Use high-performance disks in the following circumstances: <ul style="list-style-type: none"> <li>The server does not do data deduplication.</li> <li>The server does not do node replication.</li> </ul> For performance and availability, isolate the active log from the server database, archive logs, and storage pools.	You can use high-performance disks for the archive log and archive failover logs. For availability, isolate these logs from the database and active log.	Use high-performance disks for storage pools in the following circumstances: <ul style="list-style-type: none"> <li>Data is frequently read.</li> <li>Data is frequently written.</li> </ul> For performance and availability, isolate storage pool data from the server database and logs, and from data for other applications.
<b>Medium-performance or high-performance disk with the following characteristic s:</b> <ul style="list-style-type: none"> <li><b>10k rpm disk</b></li> <li><b>Fibre Channel or SAS interface</b></li> </ul>	If the disk system has a mix of disk technologies, use the faster disks for the database and active log. Isolate the server database from its logs and storage pools, and from data for other applications.	If the disk system has a mix of disk technologies, use the faster disks for the database and active log. For performance and availability, isolate the active log from the server database, archive logs, and storage pools.	You can use medium-performance or high-performance disk for the archive log and archive failover logs. For availability, isolate these logs from the database and active log.	Use medium-performance or high-performance disk for storage pools in the following circumstances: <ul style="list-style-type: none"> <li>Data is frequently read.</li> <li>Data is frequently written.</li> </ul> For performance and availability, isolate storage pool data from the server database and logs, and from data for other applications.

Storage technology type	Database	Active log	Archive log and archive failover log	Storage pools
<b>SATA, network-attached storage</b>	Do not use this storage for the database. Do not place the database on XIV storage systems.	Do not use this storage for the active log.	Use of this slower storage technology is acceptable because these logs are written once and infrequently read.	Use this slower storage technology in the following circumstances: <ul style="list-style-type: none"> <li>• Data is infrequently written, for example written once.</li> <li>• Data is infrequently read.</li> </ul>
<b>Tape and virtual tape</b>				Use for long-term retention or if data is infrequently used.

## Windows: Applying best practices to the server installation

Typically, hardware configuration and selection have the most significant effect on the performance of an IBM Spectrum Protect™ solution. Other factors that affect performance are the operating system selection and configuration, and the configuration of IBM Spectrum Protect.

### Procedure

- The following best practices are the most important for optimal performance and problem prevention.
- Review the table to determine the best practices that apply to your environment.

Best practice	More information
Use fast disks for the server database. Enterprise-grade solid-state disks (SSD), with Fibre Channel or SAS interface, offer the best performance.	Use fast, low-latency disks for the database. Using SSD is essential if you are using data deduplication and node replication. Avoid Serial Advanced Technology Attachment (SATA) and Parallel Advanced Technology Attachment (PATA) disks. For details and more tips, see the following topics: <ul style="list-style-type: none"> <li>◦ "Planning for server database disks"</li> <li>◦ "Planning for the correct type of storage technology"</li> </ul>
Ensure that the server system has enough memory.	Review operating system requirements in technote 1243309. Heavier workloads require more than the minimum requirements. Advanced features such as data deduplication and node replication can require more than the minimum memory that is specified in the system requirements document. <p>If you plan to run multiple instances, each instance requires the memory that is listed for one server. Multiply the memory for one server by the number of instances that are planned for the system.</p>

Best practice	More information
Separate the server database, the active log, the archive log, and disk storage pools from each other.	<p>Keep all IBM Spectrum Protect storage resources on separate disks. Keep storage pool disks separate from the disks for the server database and logs. Storage pool operations can interfere with database operations when both are on the same disks. Ideally, the server database and logs are also separated from each other. For details and more tips, see the following topics:</p> <ul style="list-style-type: none"> <li>○ "Planning for server database disks"</li> <li>○ "Planning for server recovery log disks"</li> <li>○ "Planning for storage pools in DISK or FILE device classes"</li> </ul>
Use at least four directories for the server database. For larger servers or servers that use advanced features, use eight directories.	<p>Place each directory on a LUN that is isolated from other LUNs and from other applications.</p> <p>A server is considered to be large if its database is larger than 2 TB or is expected to grow to that size. Use eight directories for such servers.</p> <p>See "Planning for server database disks".</p>
If you are using data deduplication, node replication, or both, follow the guidelines for database configuration and other items.	<p>Configure the server database according to the guidelines, because the database is extremely important to how well the server runs when these features are being used. For details and more tips, see the following topics:</p> <ul style="list-style-type: none"> <li>○ Checklist for data deduplication</li> <li>○ Checklist for node replication</li> </ul>
For storage pools that use FILE type device classes, follow the guidelines for the size of storage pool volumes. Typically, 50 GB volumes are best.	<p>Review the information in Optimal number and size of volumes for storage pools that use disk to help you to determine volume size.</p> <p>Configure storage pool devices and file systems based on throughput requirements, not only on capacity requirements.</p> <p>Isolate the storage devices that are used by IBM Spectrum Protect from other applications that have high I/O, and ensure that there is enough throughput to that storage.</p> <p>For more details, see Checklist for storage pools on DISK or FILE.</p>
Schedule IBM Spectrum Protect client operations and server maintenance activities to avoid or minimize overlap of operations.	<p>For more details, see the following topics:</p> <ul style="list-style-type: none"> <li>○ Tuning the schedule for daily operations</li> <li>○ Checklist for server configuration</li> </ul>
Monitor operations constantly.	<p>By monitoring, you can find problems early and more easily identify causes. Keep records of monitoring reports for up to a year to help you identify trends and plan for growth. See Monitoring and maintaining the environment for performance.</p>

## Windows: Minimum system requirements for Windows systems

The server can require a large amount of memory, network bandwidth, and processor resources. In many cases, the server performs best when other applications are not installed on the same system.

### Hardware and software requirements for the IBM Spectrum Protect server installation

These tables list the minimum hardware and software requirements for the installation of an IBM Spectrum Protect™ server. Use these requirements as a starting point for systems without data deduplication. The optimal IBM Spectrum Protect environment is set up with data deduplication by using the IBM Spectrum Protect Blueprints. For the most current information about system requirements, see technote 1243309.

## Hardware requirements

Table 1 describes the minimum hardware requirements for the server. If the server does not meet the minimum requirements, the installation fails. For more details about planning disk space, see Windows: Capacity planning.

Table 1. Hardware requirements

Type of hardware	Hardware requirements
Hardware	An AMD64 or Intel EMT-64 processor
Disk Space	<p>The following minimum values for disk space:</p> <ul style="list-style-type: none"><li>• At least 7.5 GB of free disk storage for a typical installation</li><li>• 60 MB in the temporary directory space</li><li>• 2 GB partition size in the C:\ drive</li><li>• 300 MB in the instance directory</li><li>• 2 GB for the shared resources area</li></ul> <p>In case a problem arises and any diagnosis is needed, it is optimal to have temporary or other space available on the system for a first failure data capture (FFDC) log or for other temporary uses such as for collecting trace logs.</p> <p>Significant additional disk space is required for database and log files. The size of the database depends on the number of client files to be stored and the method by which the server manages them. The default active log space is 16 GB, the minimum that is needed for most workloads and configurations. When you create the active log, you need at least 64 GB to run replication. If replication and data deduplication are both being used, create an active log of 128 GB. Allocate at least three times the default active log space for the archive log (48 GB). Ensure that you have sufficient resources if you are using data deduplication or expect a heavy client workload.</p> <p>For optimal performance and to facilitate I/O, specify at least two equally sized containers or Logical Unit Numbers (LUNs) for the database. In addition, each active log and archive log needs its own container or LUN.</p> <p>Ensure that you see Windows: Capacity planning for more details about disk space.</p>
Memory	<p>The following minimum values for memory:</p> <ul style="list-style-type: none"><li>• 16 GB for standard server operations without data deduplication and node replication</li><li>• 24 GB for data deduplication or node replication</li><li>• 32 GB for node replication with data deduplication</li></ul> <p>For more specific memory requirements for larger databases and higher ingestion capability, see the IBM Spectrum Protect server memory tuning table.</p> <p>For more specific memory requirements when you are using data deduplication, see the IBM Spectrum Protect Blueprint for your operating system.</p>

## Software requirements

Table 2 describes the minimum software requirements that are needed for a server on a Windows system.

Table 2. Software requirements

Type of software	Minimum software requirements
Operating system	<p>One of the following operating systems:</p> <ul style="list-style-type: none"><li>• Microsoft Windows Server 2012: Standard, Enterprise, or Datacenter Edition (64-bit)</li><li>• Microsoft Windows Server 2012 R2 (64-bit)</li><li>• Microsoft Windows Server 2016</li></ul>



Type of software	Minimum software requirements
Communication protocol	At least one of the following communication protocols (installed by default with the current Windows operating systems): <ul style="list-style-type: none"> <li>• Named Pipes</li> <li>• TCP/IP Version 4 or Version 6</li> </ul>
Device drivers	The IBM Spectrum Protect passthru device driver that is required for non-IBM® drives and tape libraries. The Windows native device driver is recommended for tape drives and tape libraries. Otherwise, the IBM Spectrum Protect kernel device driver can be used.  For the IBM 3590, 3592, or the Ultrium tape library or drives, the IBM device drivers are required. Install the most current device drivers. You can locate IBM driver packages at Fix Central.  Configure the device drivers before you use the server with tape devices.
Other software	Windows 2012, Windows 2012 R2, and Windows 2016 require that .NET Framework 3.5 is installed and enabled.  The following User Account Control policies must be disabled: <ul style="list-style-type: none"> <li>• User Account Control: Admin Approval Mode for the Built-in Administrator account</li> <li>• User Account Control: Run all administrators in Admin Approval Mode</li> </ul> To authenticate IBM Spectrum Protect users with a Lightweight Directory Access Protocol (LDAP) server, you must use one of the following directory servers: <ul style="list-style-type: none"> <li>• Microsoft Active Directory (Windows Server 2012, Windows Server 2012 R2)</li> <li>• IBM Security Directory Server V6.3</li> <li>• IBM Security Directory Server V6.4</li> </ul>

## Windows: IBM Installation Manager

IBM Spectrum Protect™ uses IBM® Installation Manager, which is an installation program that can use remote or local software repositories to install or update many IBM products.

If the required version of IBM Installation Manager is not already installed, it is automatically installed or upgraded when you install IBM Spectrum Protect. It must remain installed on the system so that IBM Spectrum Protect can be updated or uninstalled later as needed.

The following list contains explanations of some terms that are used in IBM Installation Manager:

### Offering

An installable unit of a software product.

The IBM Spectrum Protect offering contains all of the media that IBM Installation Manager requires to install IBM Spectrum Protect.

### Package

The group of software components that are required to install an offering.

The IBM Spectrum Protect package contains the following components:

- IBM Installation Manager installation program
- IBM Spectrum Protect offering

### Package group

A set of packages that share a common parent directory.

The default package group for the IBM Spectrum Protect package is `IBM Installation Manager`.

### Repository

A remote or local storage area for data and other application resources.

The IBM Spectrum Protect package is stored in a repository on IBM Fix Central.

Shared resources directory

A directory that contains software files or plug-ins that are shared by packages.

IBM Installation Manager stores installation-related files in the shared resources directory, including files that are used for rolling back to a previous version of IBM Spectrum Protect.

## Windows: Worksheets for planning details for the server

You can use the worksheets to help you plan the amount and location of storage needed for the IBM Spectrum Protect™ server. You can also use them to keep track of names and user IDs.

**Windows** Restriction: If you are using a File Allocation Table (FAT or FAT32) or a New Technology File System (NTFS) format, you cannot specify the root directory of that system as the location of a database directory or log directory. Instead, you must create one or more subdirectories within the root directory. Then, create the database directories and log directories within the subdirectories.

Item	Space required	Number of directories	Location of directories
The database			
Active log			
Archive log			
Optional: Log mirror for the active log			
Optional: Secondary archive log (failover location for archive log)			

Item	Names and user IDs	Location
The <i>instance user ID</i> for the server, which is the ID you use to start and run the IBM Spectrum Protect server		
The <i>home directory</i> for the server, which is the directory that contains the instance user ID		
The database instance name		
The <i>instance directory</i> for the server, which is a directory that contains files specifically for this server instance (the server options file and other server-specific files)		
The server name, use a unique name for each server		

## Windows: Capacity planning

Capacity planning for IBM Spectrum Protect™ includes managing resources such as the database, the recovery log and the shared resource area. To maximize resources as part of capacity planning, you must estimate space requirements for the database and the recovery log. The shared resource area must have enough space available for each installation or upgrade.

- Windows: Estimating space requirements for the database  
To estimate space requirements for the database, you can use the maximum number of files that can be in server storage at one time or you can use storage pool capacity.
- Windows: Recovery log space requirements  
In IBM Spectrum Protect, the term *recovery log* comprises the active log, the archive log, the active log mirror, and the archive failover log. The amount of space that you require for the recovery log depends on various factors, including, for example, the amount of client activity with the server.

- **Windows: Monitoring space utilization for the database and recovery logs**  
To determine the amount of used and available active log space, you issue the QUERY LOG command. To monitor space utilization in the database and recovery logs, you can also check the activity log for messages.
- **Windows: Deleting installation rollback files**  
You can delete certain installation files that were saved during the installation process to free space in the shared resource directory. For example, files that might have been required for a rollback operation are types of files that you can delete.

## Windows: Estimating space requirements for the database

---

To estimate space requirements for the database, you can use the maximum number of files that can be in server storage at one time or you can use storage pool capacity.

### About this task

---

Consider using at least 25 GB for the initial database space. Provision file system space appropriately. A database size of 25 GB is adequate for a test environment or a library-manager-only environment. For a production server supporting client workloads, the database size is expected to be larger. If you use random-access disk (DISK) storage pools, more database and log storage space is needed than for sequential-access storage pools.

The maximum size of the IBM Spectrum Protect™ database is 6 TB.

For information about sizing the database in a production environment that is based on the number of files and on storage pool size, see the following topics.

- **Windows: Estimating database space requirements based on the number of files**  
If you can estimate the maximum number of files that might be in server storage at a time, you can use that number to estimate space requirements for the database.
- **Windows: Estimating database space requirements based on storage pool capacity**  
To estimate database space requirements based on storage pool capacity, use a ratio of 1 - 5%. For example, if you require 200 TB of storage pool capacity, the size of your database is expected to be 2 - 10 TB. As a general rule, make your database as large as possible to prevent running out of space. If you run out of database space, server operations and client-store operations can fail.
- **Windows: The database manager and temporary space**  
The IBM Spectrum Protect server database manager manages and allocates system memory and disk space for the database. The amount of database space you require depends on the amount of system memory available and the server workload.

## Windows: Estimating database space requirements based on the number of files

---

If you can estimate the maximum number of files that might be in server storage at a time, you can use that number to estimate space requirements for the database.

### About this task

---

To estimate space requirements that is based on the maximum number of files in server storage, use the following guidelines:

- 600 - 1000 bytes for each stored version of a file, including image backups.  
Restriction: The guideline does not include space that is used during data deduplication.
- 100 - 200 bytes for each cached file, copy storage pool file, active-data pool file, and deduplicated file.
- Additional space is required for database optimization to support varying data-access patterns and to support server back-end processing of the data. The amount of extra space is equal to 50% of the estimate for the total number of bytes for file objects.

In the following example for a single client, the calculations are based on the maximum values in the preceding guidelines. The examples do not take into account that you might use file aggregation. In general, when you aggregate small files, it reduces the amount of required database space. File aggregation does not affect space-managed files.

### Procedure

---

1. Calculate the number of file versions. Add each of the following values to obtain the number of file versions:
  - a. Calculate the number of backed-up files. For example, as many as 500,000 client files might be backed up at a time. In this example, storage policies are set to keep up to three copies of backed up files:

$$500,000 \text{ files} * 3 \text{ copies} = 1,500,000 \text{ files}$$

- b. Calculate the number of archive files. For example, as many as 100,000 client files might be archived copies.
- c. Calculate the number of space-managed files. For example, as many as 200,000 client files might be migrated from client workstations.

Using 1000 bytes per file, the total amount of database space that is required for the files that belong to the client is 1.8 GB:

$$(1,500,000 + 100,000 + 200,000) * 1000 = 1.8 \text{ GB}$$

2. Calculate the number of cached files, copy storage-pool files, active-data pool files, and deduplicated files:
  - a. Calculate the number of cached copies. For example, caching is enabled in a 5 GB disk storage pool. The high migration threshold of the pool is 90% and the low migration threshold of the pool is 70%. Thus, 20% of the disk pool, or 1 GB, is occupied by cached files.

If the average file size is about 10 KB, approximately 100,000 files are in cache at any one time:

$$100,000 \text{ files} * 200 \text{ bytes} = 19 \text{ MB}$$

- b. Calculate the number of copy storage-pool files. All primary storage pools are backed up to the copy storage pool:

$$(1,500,000 + 100,000 + 200,000) * 200 \text{ bytes} = 343 \text{ MB}$$

- c. Calculate the number of active storage-pool files. All the active client-backup data in primary storage pools is copied to the active-data storage pool. Assume that 500,000 versions of the 1,500,000 backup files in the primary storage pool are active:

$$500,000 * 200 \text{ bytes} = 95 \text{ MB}$$

- d. Calculate the number of deduplicated files. Assume that a deduplicated storage pool contains 50,000 files:

$$50,000 * 200 \text{ bytes} = 10 \text{ MB}$$

Based on the preceding calculations, about 0.5 GB of extra database space is required for the client's cached files, copy storage-pool files, active-data pool files, and deduplicated files.

3. Calculate the amount of extra space that is required for database optimization. To provide optimal data access and management by the server, extra database space is required. The amount of extra database space is equal to 50% of the total space requirements for file objects.

$$(1.8 + 0.5) * 50\% = 1.2 \text{ GB}$$

4. Calculate the total amount of database space that is required for the client. The total is approximately 3.5 GB:

$$1.8 + 0.5 + 1.2 = 3.5 \text{ GB}$$

5. Calculate the total amount of database space that is required for all clients. If the client that was used in the preceding calculations is typical and you have 500 clients, for example, you can use the following calculation to estimate the total amount of database space that is required for all clients:

$$500 * 3.5 = 1.7 \text{ TB}$$

## Results

---

Tip: In the preceding examples, the results are estimates. The actual size of the database might differ from the estimate because of factors such as the number of directories and the length of the path and file names. Periodically monitor your database and adjust its size as necessary.

## What to do next

---

During normal operations, the IBM Spectrum Protect™ server might require temporary database space. This space is needed for the following reasons:

- To hold the results of sorting or ordering that are not already being kept and optimized in the database directly. The results are temporarily held in the database for processing.
- To give administrative access to the database through one of the following methods:

- A DB2® open database connectivity (ODBC) client
- An Oracle Java™ database connectivity (JDBC) client
- Structured Query Language (SQL) to the server from an administrative-client command line

Consider using an extra 50 GB of temporary space for every 500 GB of space for file objects and optimization. See the guidelines in the following table. In the example that is used in the preceding step, a total of 1.7 TB of database space is required for file objects and optimization for 500 clients. Based on that calculation, 200 GB is required for temporary space. The total amount of required database space is 1.9 TB.

Database size	Minimum temporary-space requirement
< 500 GB	50 GB
≥ 500 GB and < 1 TB	100 GB
≥ 1 TB and < 1.5 TB	150 GB
≥ 1.5 and < 2 TB	200 GB
≥ 2 and < 3 TB	250 - 300 GB
≥ 3 and < 4 TB	350 - 400 GB

## Windows: Estimating database space requirements based on storage pool capacity

To estimate database space requirements based on storage pool capacity, use a ratio of 1 - 5%. For example, if you require 200 TB of storage pool capacity, the size of your database is expected to be 2 - 10 TB. As a general rule, make your database as large as possible to prevent running out of space. If you run out of database space, server operations and client-store operations can fail.

## Windows: The database manager and temporary space

The IBM Spectrum Protect™ server database manager manages and allocates system memory and disk space for the database. The amount of database space you require depends on the amount of system memory available and the server workload.

The database manager sorts data in a specific sequence, according to the SQL statement that you issue to request the data. Depending on the workload on the server, and if there is more data than the database manager can manage, the data (that is ordered in sequence) is allocated to temporary disk space. Data is allocated to temporary disk space when there is a large result set. The database manager dynamically manages the memory that is used when data is allocated to temporary disk space.

For example, expiration processing can produce a large result set. If there is not enough system memory on the database to store the result set, some of the data is allocated to temporary disk space. During expiration processing, if a node or file space are selected that are too large to process, the database manager cannot sort the data in memory. The database manager must use temporary space to sort data.

To run database operations, consider adding more database space for the following scenarios:

- The database has a small amount of space and the server operation that requires temporary space uses the remaining free space.
- The file spaces are large, or the file spaces have an assigned policy that creates many file versions.
- The IBM Spectrum Protect server must run with limited memory. The database uses the IBM Spectrum Protect server main memory to run database operations. However, if there is insufficient memory available, the IBM Spectrum Protect server allocates temporary space on disk to the database. For example, if 10G of memory is available and database operations require 12G of memory, the database uses temporary space.
- An `out of database space` error is displayed when you deploy an IBM Spectrum Protect server. Monitor the server activity log for messages that are related to database space.

Important: Do not change the DB2 software that is installed with the IBM Spectrum Protect installation packages and fix packs. Do not install or upgrade to a different version, release, or fix pack, of DB2 software to avoid damage to the database.

## Windows: Recovery log space requirements

In IBM Spectrum Protect™, the term *recovery log* comprises the active log, the archive log, the active log mirror, and the archive failover log. The amount of space that you require for the recovery log depends on various factors, including, for example, the amount of client activity with the server.

- **Windows: Active and archive log space**  
When you estimate space requirements for active and archive logs, include some extra space for contingencies such as occasional heavy workloads and failovers.
- **Windows: Active-log mirror space**  
The active log can be mirrored so that the mirrored copy can be used if the active log files cannot be read. There can be only one active log mirror.
- **Windows: Archive-failover log space**  
The archive failover log is used by the server if the archive log directory runs out of space.

## Windows: Active and archive log space

---

When you estimate space requirements for active and archive logs, include some extra space for contingencies such as occasional heavy workloads and failovers.

In IBM Spectrum Protect™ servers V7.1 and later, the active log can be a maximum size of 512 GB. The archive log size is limited to the size of the file system that it is installed on.

Use the following general guidelines when you estimate the size of the active log:

- The suggested starting size for the active log is 16 GB.
- Ensure that the active log is at least large enough for the amount of concurrent activity that the server typically handles. As a precaution, try to anticipate the largest amount of work that the server manages at one time. Provision the active log with extra space that can be used if needed. Consider using 20% of extra space.
- Monitor used and available active log space. Adjust the size of the active log as needed, depending upon factors such as client activity and the level of server operations.
- Ensure that the directory that holds the active log is as large as, or larger than, the size of the active log. A directory that is larger than the active log can accommodate failovers, if they occur.
- Ensure that the file system that contains the active log directory has at least 8 GB of free space for temporary log movement requirements.

The suggested starting size for the archive log is 48 GB.

The archive log directory must be large enough to contain the log files that are generated since the previous full backup. For example, if you perform a full backup of the database every day, the archive log directory must be large enough to hold the log files for all the client activity that occurs during 24 hours. To recover space, the server deletes obsolete archive log files after a full backup of the database. If the archive log directory becomes full and a directory for archive failover logs does not exist, log files remain in the active log directory. This condition can cause the active log directory to fill up and stop the server. When the server restarts, some of the existing active-log space is released.

After the server is installed, you can monitor archive log utilization and the space in the archive log directory. If the space in the archive log directory fills up, it can cause the following problems:

- The server is unable to perform full database backups. Investigate and resolve this problem.
- Other applications write to the archive log directory, exhausting the space that is required by the archive log. Do not share archive log space with other applications including other IBM Spectrum Protect servers. Ensure that each server has a separate storage location that is owned and managed by that specific server.
- **Windows: Example: Estimating active and archive log sizes for basic client-store operations**  
Basic client-store operations include backup, archive, and space management. Log space must be sufficient to handle all store transactions that are in progress at one time.
- **Windows: Example: Estimating active and archive log sizes for clients that use multiple sessions**  
If the client option `RESOURCEUTILIZATION` is set to a value that is greater than the default, the concurrent workload for the server increases.
- **Windows: Example: Estimating active and archive log sizes for simultaneous write operations**  
If client backup operations use storage pools that are configured for simultaneous write, the amount of log space that is required for each file increases.
- **Windows: Example: Estimating active and archive log sizes for basic client store operations and server operations**  
Migration of data in server storage, identification processes for data deduplication, reclamation, and expiration might run concurrently with client store operations. Administrative tasks such as administrative commands or SQL queries from

administrative clients can also run concurrently with client store operations. Server operations and administrative tasks that run concurrently can increase the active log space that is required.

- Windows: Example: Estimating active and archive log sizes under conditions of extreme variation  
Problems with running out of active log space can occur if you have many transactions that complete quickly and some transactions that take much longer to complete. A typical case occurs when many workstation or file-server backup sessions are active and a few very large database server-backup sessions are active. If this situation applies to your environment, you might need to increase the size of the active log so that the work completes successfully.
- Windows: Example: Estimating archive log sizes with full database backups  
The IBM Spectrum Protect server deletes unnecessary files from the archive log only when a full database backup occurs. Consequently, when you estimate the space that is required for the archive log, you must also consider the frequency of full database backups.
- Windows: Example: Estimating active and archive log sizes for data deduplication operations  
If you deduplicate data, you must consider its effects on space requirements for active and archive logs.

## Windows: Example: Estimating active and archive log sizes for basic client-store operations

Basic client-store operations include backup, archive, and space management. Log space must be sufficient to handle all store transactions that are in progress at one time.

To determine the sizes of the active and archive logs for basic client-store operations, use the following calculation:

```
number of clients x files stored during each transaction
x log space needed for each file
```

This calculation is used in the example in the following table.

Table 1. Basic client-store operations

Item	Example values	Description
Maximum number of client nodes that back up, archive, or migrate files concurrently at any time	300	The number of client nodes that back up, archive, or migrate files every night.
Files stored during each transaction	4096	The default value of the server option TXNGROUPMAX is 4096.
Log space that is required for each file	3053 bytes	The value of 3053 bytes for each file in a transaction represents the log bytes that are needed when backing up files from a Windows client where the file names are 12 - 120 bytes.  This value is based on the results of tests performed under laboratory conditions. The tests consisted of backup-archive clients performing backup operations to a random-access disk (DISK) storage pool. DISK pools result in more log use than sequential-access storage pools. Consider a value larger than 3053 bytes if the data being stored has file names that are longer than 12 - 120 bytes.
Active log: Suggested size	19.5 GB <sup>1</sup>	Use the following calculation to determine the size of the active log. One GB equals 1,073,741,824 bytes.  (300 clients x 4096 files stored during each transaction x 3053 bytes for each file) ÷ 1,073,741,824 bytes = 3.5 GB  Increase that amount by the suggested starting size of 16 GB:  3.5 + 16 = 19.5 GB

Item	Example values	Description
Archive log: Suggested size	58.5 GB <sup>1</sup>	<p>Because of the requirement to be able to store archive logs across three server database-backup cycles, multiply the estimate for the active log by 3 to estimate the total archive log requirement.</p> $3.5 \times 3 = 10.5 \text{ GB}$ <p>Increase that amount by the suggested starting size of 48 GB:</p> $10.5 + 48 = 58.5 \text{ GB}$
<p><sup>1</sup> The example values in this table are used only to illustrate how the sizes for active logs and archive logs are calculated. In a production environment that does not use deduplication, 16 GB is the suggested minimum size for an active log. The suggested minimum size for an archive log in a production environment that does not use deduplication is 48 GB. If you substitute values from your environment and the results are larger than 16 GB and 48 GB, use your results to size the active log and archive log.</p> <p>Monitor your logs and adjust their size if necessary.</p>		

## Windows: Example: Estimating active and archive log sizes for clients that use multiple sessions

If the client option RESOURCEUTILIZATION is set to a value that is greater than the default, the concurrent workload for the server increases.

To determine the sizes of the active and archive logs when clients use multiple sessions, use the following calculation:

$$\text{number of clients} \times \text{sessions for each client} \times \text{files stored during each transaction} \times \text{log space needed for each file}$$

This calculation is used in the example in the following table.

Table 1. Multiple client sessions

Item	Example values		Description
Maximum number of client nodes that back up, archive, or migrate files concurrently at any time	300	1000	The number of client nodes that back up, archive, or migrate files every night.
Possible sessions for each client	3	3	The setting of the client option RESOURCEUTILIZATION is larger than the default. Each client session runs a maximum of three sessions in parallel.
Files stored during each transaction	4096	4096	The default value of the server option TXNGROUPMAX is 4096.
Log space that is required for each file	3053	3053	<p>The value of 3053 bytes for each file in a transaction represents the log bytes needed when backing up files from a Windows client where the file names are 12 - 120 bytes.</p> <p>This value is based on the results of tests performed under laboratory conditions. Tests consisted of clients performing backup operations to a random-access disk (DISK) storage pool. DISK pools result in more log use than sequential-access storage pools. Consider a value larger than 3053 bytes if the data being stored has file names that are longer than 12 - 120 bytes.</p>



Item	Example values		Description
Active log: Suggested size	26.5 GB <sup>1</sup>	51 GB <sup>1</sup>	<p>The following calculation was used for 300 clients. One GB equals 1,073,741,824 bytes.</p> <p>(300 clients x 3 sessions for each client x 4096 files stored during each transaction x 3053 bytes for each file) ÷ 1,073,741,824 = 10.5 GB</p> <p>Increase that amount by the suggested starting size of 16 GB:</p> <p>10.5 + 16 = 26.5 GB</p> <p>The following calculation was used for 1000 clients. One GB equals 1,073,741,824 bytes.</p> <p>(1000 clients x 3 sessions for each client x 4096 files store during each transaction x 3053 bytes for each file) ÷ 1,073,741,824 = 35 GB</p> <p>Increase that amount by the suggested starting size of 16 GB:</p> <p>35 + 16 = 51 GB</p>
Archive log: Suggested size	79.5 GB <sup>1</sup>	153 GB <sup>1</sup>	<p>Because of the requirement to be able to store archive logs across three server-database backup cycles, the estimate for the active log is multiplied by 3:</p> <p>10.5 x 3 = 31.5 GB</p> <p>35 x 3 = 105 GB</p> <p>Increase those amounts by the suggested starting size of 48 GB:</p> <p>31.5 + 48 = 79.5 GB</p> <p>105 + 48 = 153 GB</p>
<p><sup>1</sup> The example values in this table are used only to illustrate how the sizes for active logs and archive logs are calculated. In a production environment that does not use deduplication, 16 GB is the suggested minimum size for an active log. The suggested minimum size for an archive log in a production environment that does not use deduplication is 48 GB. If you substitute values from your environment and the results are larger than 16 GB and 48 GB, use your results to size the active log and archive log.</p> <p>Monitor your active log and adjust its size if necessary.</p>			

## Windows: Example: Estimating active and archive log sizes for simultaneous write operations

If client backup operations use storage pools that are configured for simultaneous write, the amount of log space that is required for each file increases.

The log space that is required for each file increases by about 200 bytes for each copy storage pool that is used for a simultaneous write operation. In the example in the following table, data is stored to two copy storage pools in addition to a primary storage pool. The estimated log size increases by 400 bytes for each file. If you use the suggested value of 3053 bytes of log space for each file, the total number of required bytes is 3453.

This calculation is used in the example in the following table.

Table 1. Simultaneous write operations

Item	Example values	Description
Maximum number of client nodes that back up, archive, or migrate files concurrently at any time	300	The number of client nodes that back up, archive, or migrate files every night.

Item	Example values	Description
Files stored during each transaction	4096	The default value of the server option TXNGROUPMAX is 4096.
Log space that is required for each file	3453 bytes	3053 bytes plus 200 bytes for each copy storage pool.  The value of 3053 bytes for each file in a transaction represents the log bytes that are needed when backing up files from a Windows client where the file names are 12 - 120 bytes.  This value is based on the results of tests performed under laboratory conditions. The tests consisted of backup-archive clients performing backup operations to a random-access disk (DISK) storage pool. DISK pools result in more log use than sequential-access storage pools. Consider a value larger than 3053 bytes if the data being stored has file names that are longer than 12 - 120 bytes.
Active log: Suggested size	20 GB <sup>1</sup>	Use the following calculation to determine the size of the active log. One GB equals 1,073,741,824 bytes.  (300 clients x 4096 files stored during each transaction x 3453 bytes for each file) ÷ 1,073,741,824 bytes = 4.0 GB  Increase that amount by the suggested starting size of 16 GB:  4 + 16 = 20 GB
Archive log: Suggested size	60 GB <sup>1</sup>	Because of the requirement to be able to store archive logs across three server database-backup cycles, multiply the estimate for the active log by 3 to estimate the archive log requirement:  4 GB x 3 = 12 GB  Increase that amount by the suggested starting size of 48 GB:  12 + 48 = 60 GB
<p><sup>1</sup> The example values in this table are used only to illustrate how the sizes for active logs and archive logs are calculated. In a production environment that does not use deduplication, 16 GB is the suggested minimum size for an active log. The suggested minimum size for an archive log in a production environment that does not use deduplication is 48 GB. If you substitute values from your environment and the results are larger than 16 GB and 48 GB, use your results to size the active log and archive log.</p> <p>Monitor your logs and adjust their size if necessary.</p>		

## Windows: Example: Estimating active and archive log sizes for basic client store operations and server operations

Migration of data in server storage, identification processes for data deduplication, reclamation, and expiration might run concurrently with client store operations. Administrative tasks such as administrative commands or SQL queries from administrative clients can also run concurrently with client store operations. Server operations and administrative tasks that run concurrently can increase the active log space that is required.

For example, migration of files from the random-access (DISK) storage pool to a sequential-access disk (FILE) storage pool uses approximately 110 bytes of log space for each file that is migrated. For example, suppose that you have 300 backup-archive clients and each one of them backs up 100,000 files every night. The files are initially stored on DISK and then migrated to a FILE storage pool. To estimate the amount of active log space that is required for the data migration, use the following calculation. The number of clients in the calculation represents the maximum number of client nodes that back up, archive, or migrate files concurrently at any time.

300 clients x 100,000 files for each client x 110 bytes = 3.1 GB

Add this value to the estimate for the size of the active log that calculated for basic client store operations.

## Windows: Example: Estimating active and archive log sizes under conditions of extreme variation

Problems with running out of active log space can occur if you have many transactions that complete quickly and some transactions that take much longer to complete. A typical case occurs when many workstation or file-server backup sessions are active and a few very large database server-backup sessions are active. If this situation applies to your environment, you might need to increase the size of the active log so that the work completes successfully.

## Windows: Example: Estimating archive log sizes with full database backups

The IBM Spectrum Protect™ server deletes unnecessary files from the archive log only when a full database backup occurs. Consequently, when you estimate the space that is required for the archive log, you must also consider the frequency of full database backups.

For example, if a full database backup occurs once a week, the archive log space must be able to contain the information in the archive log for a full week.

The difference in archive log size for daily and full database backups is shown in the example in the following table.

Table 1. Full database backups

Item	Example values	Description
Maximum number of client nodes that back up, archive, or migrate files concurrently at any time	300	The number of client nodes that back up, archive, or migrate files every night.
Files stored during each transaction	4096	The default value of the server option TXNGROUPMAX is 4096.
Log space that is required for each file	3453 bytes	3053 bytes for each file plus 200 bytes for each copy storage pool.  The value of 3053 bytes for each file in a transaction represents the log bytes needed when backing up files from a Windows client where the file names are 12 - 120 bytes.  This value is based on the results of tests performed under laboratory conditions. Tests consisted of clients performing backup operations to a random-access disk (DISK) storage pool. DISK pools result in more log use than sequential-access storage pools. Consider a value larger than 3053 bytes if the data being stored has file names that are longer than 12 - 120 bytes.
Active log: Suggested size	20 GB <sup>1</sup>	Use the following calculation to determine the size of the active log. One GB equals 1,073,741,824 bytes.  (300 clients x 4096 files per transaction x 3453 bytes per file) ÷ 1,073,741,824 bytes = 4.0 GB  Increase that amount by the suggested starting size of 16 GB:  4 + 16 = 20 GB
Archive log: Suggested size with a full database backup every day	60 GB <sup>1</sup>	Because of the requirement to be able to store archive logs across three backup cycles, multiply the estimate for the active log by 3 to estimate the total archive log requirement:  4 GB x 3 = 12 GB  Increase that amount by the suggested starting size of 48 GB:  12 + 48 = 60 GB

Item	Example values	Description
Archive log: Suggested size with a full database every week	132 GB <sup>1</sup>	<p>Because of the requirement to be able to store archive logs across three server database-backup cycles, multiply the estimate for the active log by 3 to estimate the total archive log requirement. Multiply the result by the number of days between full database backups:</p> $(4 \text{ GB} \times 3) \times 7 = 84 \text{ GB}$ <p>Increase that amount by the suggested starting size of 48 GB:</p> $84 + 48 = 132 \text{ GB}$
<p><sup>1</sup> The example values in this table are used only to illustrate how the sizes for active logs and archive logs are calculated. In a production environment that does not use deduplication, 16 GB is the suggested minimum size for an active log. The suggested starting size for an archive log in a production environment that does not use deduplication is 48 GB. If you substitute values from your environment and the results are larger than 16 GB and 48 GB, use your results to size the active log and archive log.</p> <p>Monitor your logs and adjust their size if necessary.</p>		

## Windows: Example: Estimating active and archive log sizes for data deduplication operations

If you deduplicate data, you must consider its effects on space requirements for active and archive logs.

The following factors affect requirements for active and archive log space:

The amount of deduplicated data

The effect of data deduplication on the active log and archive log space depends on the percentage of data that is eligible for deduplication. If the percentage of data that can be deduplicated is relatively high, more log space is required.

The size and number of extents

Approximately 1,500 bytes of active log space are required for each extent that is identified by a duplicate-identification process. For example, if 250,000 extents are identified by a duplicate-identification process, the estimated size of the active log is 358 MB:

$$250,000 \text{ extents identified during each process} \times 1,500 \text{ bytes for each extent} = 358 \text{ MB}$$

Consider the following scenario. Three hundred backup-archive clients back up 100,000 files each night. This activity creates a workload of 30,000,000 files. The average number of extents for each file is two. Therefore, the total number of extents is 60,000,000, and the space requirement for the archive log is 84 GB:

$$60,000,000 \text{ extents} \times 1,500 \text{ bytes for each extent} = 84 \text{ GB}$$

A duplicate-identification process operates on aggregates of files. An aggregate consists of files that are stored in a given transaction, as specified by the TXNGROUPMAX server option. Suppose that the TXNGROUPMAX server option is set to the default of 4096. If the average number of extents for each file is two, the total number of extents in each aggregate is 8192, and the space required for the active log is 12 MB:

$$8192 \text{ extents in each aggregate} \times 1500 \text{ bytes for each extent} = 12 \text{ MB}$$

The timing and number of the duplicate-identification processes

The timing and number of duplicate-identification processes also affects the size of the active log. Using the 12 MB active-log size that was calculated in the preceding example, the concurrent load on the active log is 120 MB if 10 duplicate-identification processes are running in parallel:

$$12 \text{ MB for each process} \times 10 \text{ processes} = 120 \text{ MB}$$

File size

Large files that are processed for duplicate identification can also affect the size of the active log. For example, suppose that a backup-archive client backs up an 80 GB, file-system image. This object can have a high number of duplicate extents if, for example, the files included in the file system image were backed up incrementally. For example, assume that a file

system image has 1.2 million duplicate extents. The 1.2 million extents in this large file represent a single transaction for a duplicate-identification process. The total space in the active log that is required for this single object is 1.7 GB:

$$1,200,000 \text{ extents} \times 1,500 \text{ bytes for each extent} = 1.7 \text{ GB}$$

If other, smaller duplicate-identification processes occur at the same time as the duplicate-identification process for a single large object, the active log might not have enough space. For example, suppose that a storage pool is enabled for deduplication. The storage pool has a mixture of data, including many relatively small files that range from 10 KB to several hundred KB. The storage pool also has few large objects that have a high percentage of duplicate extents.

To take into account not only space requirements but also the timing and duration of concurrent transactions, increase the estimated size of the active log by a factor of two. For example, suppose that your calculations for space requirements are 25 GB (23.3 GB + 1.7 GB for deduplication of a large object). If deduplication processes are running concurrently, the suggested size of the active log is 50 GB. The suggested size of the archive log is 150 GB.

The examples in the following tables show calculations for active and archive logs. The example in the first table uses an average size of 700 KB for extents. The example in the second table uses an average size of 256 KB. As the examples show, the average deduplicate-extent size of 256 KB indicates a larger estimated size for the active log. To minimize or prevent operational problems for the server, use 256 KB to estimate the size of the active log in your production environment.

Table 1. Average duplicate-extent size of 700 KB

Item	Example values		Description
Size of largest single object to deduplicate	800 GB	4 TB	The granularity of processing for deduplication is at the file level. Therefore, the largest single file to deduplicate represents the largest transaction and a correspondingly large load on the active and archive logs.
Average size of extents	700 KB	700 KB	The deduplication algorithms use a variable block method. Not all deduplicated extents for a given file are the same size, so this calculation assumes an average size for extents.
Extents for a given file	1,198,372 bits	6,135,667 bits	Using the average extent size (700 KB), these calculations represent the total number of extents for a given object.  The following calculation was used for an 800 GB object: $(800 \text{ GB} \div 700 \text{ KB}) = 1,198,372 \text{ bits}$  The following calculation was used for a 4 TB object: $(4 \text{ TB} \div 700 \text{ KB}) = 6,135,667 \text{ bits}$
Active log: Suggested size that is required for the deduplication of a single large object during a single duplicate-identification process	1.7 GB	8.6 GB	The estimated active log space that are needed for this transaction.

Item	Example values		Description
Active log: Suggested total size	66 GB <sup>1</sup>	79.8 GB <sup>1</sup>	<p>After considering other aspects of the workload on the server in addition to deduplication, multiply the existing estimate by a factor of two. In these examples, the active log space required to deduplicate a single large object is considered along with previous estimates for the required active log size.</p> <p>The following calculation was used for multiple transactions and an 800 GB object:</p> $(23.3 \text{ GB} + 1.7 \text{ GB}) \times 2 = 50 \text{ GB}$ <p>Increase that amount by the suggested starting size of 16 GB:</p> $50 + 16 = 66 \text{ GB}$ <p>The following calculation was used for multiple transactions and a 4 TB object:</p> $(23.3 \text{ GB} + 8.6 \text{ GB}) \times 2 = 63.8 \text{ GB}$ <p>Increase that amount by the suggested starting size of 16 GB:</p> $63.8 + 16 = 79.8 \text{ GB}$
Archive log: Suggested size	198 GB <sup>1</sup>	239.4 GB <sup>1</sup>	<p>Multiply the estimated size of the active log by a factor of 3.</p> <p>The following calculation was used for multiple transactions and an 800 GB object:</p> $50 \text{ GB} \times 3 = 150 \text{ GB}$ <p>Increase that amount by the suggested starting size of 48 GB:</p> $150 + 48 = 198 \text{ GB}$ <p>The following calculation was used for multiple transactions and a 4 TB object:</p> $63.8 \text{ GB} \times 3 = 191.4 \text{ GB}$ <p>Increase that amount by the suggested starting size of 48 GB:</p> $191.4 + 48 = 239.4 \text{ GB}$
<p><sup>1</sup> The example values in this table are used only to illustrate how the sizes for active logs and archive logs are calculated. In a production environment that uses deduplication, 32 GB is the suggested minimum size for an active log. The suggested minimum size for an archive log in a production environment that uses deduplication is 96 GB. If you substitute values from your environment and the results are larger than 32 GB and 96 GB, use your results to size the active log and archive log.</p> <p>Monitor your logs and adjust their size if necessary.</p>			

Table 2. Average duplicate-extent size of 256 KB

Item	Example values		Description
Size of largest single object to deduplicate	800 GB	4 TB	The granularity of processing for deduplication is at the file level. Therefore, the largest single file to deduplicate represents the largest transaction and a correspondingly large load on the active and archive logs.

Item	Example values		Description
Average size of extents	256 KB	256 KB	The deduplication algorithms use a variable block method. Not all deduplicated extents for a given file are the same size, so this calculation assumes an average extent size.
Extents for a given file	3,276,800 bits	16,777,216 bits	<p>Using the average extent size, these calculations represent the total number of extents for a given object.</p> <p>The following calculation was used for multiple transactions and an 800 GB object:</p> $(800 \text{ GB} \div 256 \text{ KB}) = 3,276,800 \text{ bits}$ <p>The following calculation was used for multiple transactions and a 4 TB object:</p> $(4 \text{ TB} \div 256 \text{ KB}) = 16,777,216 \text{ bits}$
Active log: Suggested size that is required for the deduplication of a single large object during a single duplicate-identification process	4.5 GB	23.4 GB	The estimated size of the active log space that is required for this transaction.
Active log: Suggested total size	71.6 GB <sup>1</sup>	109.4 GB <sup>1</sup>	<p>After considering other aspects of the workload on the server in addition to deduplication, multiply the existing estimate by a factor of 2. In these examples, the active log space required to deduplicate a single large object is considered along with previous estimates for the required active log size.</p> <p>The following calculation was used for multiple transactions and an 800 GB object:</p> $(23.3 \text{ GB} + 4.5 \text{ GB}) \times 2 = 55.6 \text{ GB}$ <p>Increase that amount by the suggested starting size of 16 GB:</p> $55.6 + 16 = 71.6 \text{ GB}$ <p>The following calculation was used for multiple transactions and a 4 TB object:</p> $(23.3 \text{ GB} + 23.4 \text{ GB}) \times 2 = 93.4 \text{ GB}$ <p>Increase that amount by the suggested starting size of 16 GB:</p> $93.4 + 16 = 109.4 \text{ GB}$

Item	Example values		Description
Archive log: Suggested size	214.8 GB <sup>1</sup>	328.2 GB <sup>1</sup>	<p>The estimated size of the active log multiplied by a factor of 3.</p> <p>The following calculation was used for an 800 GB object:</p> $55.6 \text{ GB} \times 3 = 166.8 \text{ GB}$ <p>Increase that amount by the suggested starting size of 48 GB:</p> $166.8 + 48 = 214.8 \text{ GB}$ <p>The following calculation was used for a 4 TB object:</p> $93.4 \text{ GB} \times 3 = 280.2 \text{ GB}$ <p>Increase that amount by the suggested starting size of 48 GB:</p> $280.2 + 48 = 328.2 \text{ GB}$
<p><sup>1</sup> The example values in this table are used only to illustrate how the sizes for active logs and archive logs are calculated. In a production environment that uses deduplication, 32 GB is the suggested minimum size for an active log. The suggested minimum size for an archive log in a production environment that uses deduplication is 96 GB. If you substitute values from your environment and the results are larger than 32 GB and 96 GB, use your results to size the active log and archive log.</p> <p>Monitor your logs and adjust their size if necessary.</p>			

## Windows: Active-log mirror space

The active log can be mirrored so that the mirrored copy can be used if the active log files cannot be read. There can be only one active log mirror.

Creating a log mirror is a suggested option. If you increase the size of the active log, the log mirror size is increased automatically. Mirroring the log can affect performance because of the doubled I/O activity that is required to maintain the mirror. The additional space that the log mirror requires is another factor to consider when deciding whether to create a log mirror.

If the mirror log directory becomes full, the server issues error messages to the activity log and to the db2diag.log. Server activity continues.

## Windows: Archive-failover log space

The archive failover log is used by the server if the archive log directory runs out of space.

Specifying an archive failover log directory can prevent problems that occur if the archive log runs out of space. If both the archive log directory and the drive or file system where the archive failover log directory is located become full, the data remains in the active log directory. This condition can cause the active log to fill up, which causes the server to halt.

## Windows: Monitoring space utilization for the database and recovery logs

To determine the amount of used and available active log space, you issue the QUERY LOG command. To monitor space utilization in the database and recovery logs, you can also check the activity log for messages.

### Active log

If the amount of available active log space is too low, the following messages are displayed in the activity log:

```
ANR4531I: IC_AUTOBACKUP_LOG_USED_SINCE_LAST_BACKUP_TRIGGER
```



This message is displayed when the active log space exceeds the maximum specified size. The IBM Spectrum Protect™ server starts a full database backup.

To change the maximum log size, halt the server. Open the dmserv.opt file, and specify a new value for the ACTIVELOGSIZE option. When you are finished, restart the server.

**ANR0297I: IC\_BACKUP\_NEEDED\_LOG\_USED\_SINCE\_LAST\_BACKUP**

This message is displayed when the active log space exceeds the maximum specified size. You must back up the database manually.

To change the maximum log size, halt the server. Open the dmserv.opt file, and specify a new value for the ACTIVELOGSIZE option. When you are finished, restart the server.

**ANR4529I: IC\_AUTOBACKUP\_LOG\_UTILIZATION\_TRIGGER**

The ratio of used active-log space to available active-log space exceeds the log utilization threshold. If at least one full database backup has occurred, the IBM Spectrum Protect server starts an incremental database backup. Otherwise, the server starts a full database backup.

**ANR0295I: IC\_BACKUP\_NEEDED\_LOG\_UTILIZATION**

The ratio of used active-log space to available active-log space exceeds the log utilization threshold. You must back up the database manually.

## Archive log

---

If the amount of available archive log space is too low, the following message is displayed in the activity log:

**ANR0299I: IC\_BACKUP\_NEEDED\_ARCHLOG\_USED**

The ratio of used archive-log space to available archive-log space exceeds the log utilization threshold. The IBM Spectrum Protect server starts a full automatic database backup.

## Database

---

If the amount of space available for database activities is too low, the following messages are displayed in the activity log:

**ANR2992W: IC\_LOG\_FILE\_SYSTEM\_UTILIZATION\_WARNING\_2**

The used database space exceeds the threshold for database space utilization. To increase the space for the database, use the EXTEND DBSPACE command, the EXTEND DBSPACE command, or the DSMSEV FORMAT utility with the DBDIR parameter.

**ANR1546W: FILESYSTEM\_DBPATH\_LESS\_1GB**

The available space in the directory where the server database files are located is less than 1 GB.

When an IBM Spectrum Protect server is created with the DSMSEV FORMAT utility or with the configuration wizard, a server database and recovery log are also created. In addition, files are created to hold database information used by the database manager. The path specified in this message indicates the location of the database information used by the database manager. If space is unavailable in the path, the server can no longer function.

You must add space to the file system or make space available on the file system or disk.

## Windows: Deleting installation rollback files

---

You can delete certain installation files that were saved during the installation process to free space in the shared resource directory. For example, files that might have been required for a rollback operation are types of files that you can delete.

### About this task

---

To delete the files that are no longer needed, use either the installation graphical wizard or the command line in console mode.

- **Windows: Deleting installation rollback files by using a graphical wizard**  
You can delete certain installation files that were saved during installation process by using the IBM® Installation Manager user interface.
- **Windows: Deleting installation rollback files by using the command line**  
You can delete certain installation files that were saved during the installation process by using the command line.

## Windows: Deleting installation rollback files by using a graphical wizard

---

You can delete certain installation files that were saved during installation process by using the IBM® Installation Manager user interface.

### Procedure

---

1. Open IBM Installation Manager.
2. Click File > Preferences.
3. Select Files for Rollback.
4. Click Delete Saved Files and click OK.

## Windows: Deleting installation rollback files by using the command line

---

You can delete certain installation files that were saved during the installation process by using the command line.

### Procedure

---

1. In the directory where IBM® Installation Manager is installed, go to the following subdirectory:
  - o **Windows** eclipse\tools

For example:

- o **Windows** C:\Program Files\IBM\Installation Manager\eclipse\tools
2. From the tools directory, issue the following command to start an IBM Installation Manager command line:
    - o **Windows** imcl.exe -c
  3. Enter **P** to select Preferences.
  4. Enter **3** to select Files for Rollback.
  5. Enter **D** to Delete the Files for Rollback.
  6. Enter **A** to Apply Changes and Return to Preferences Menu.
  7. Enter **C** to leave the Preference Menu.
  8. Enter **X** to Exit Installation Manager.

## Windows: Server naming best practices

---

Use these descriptions as a reference when you install or upgrade an IBM Spectrum Protect™ server.

### Instance user ID

---

The instance user ID is used as the basis for other names related to the server instance. The instance user ID is also called the instance owner.

For example: tsminst1

The instance user ID is the user ID that must have ownership or read/write access authority to all directories that you create for the database and the recovery log. The standard way to run the server is under the instance user ID. That user ID must also have read/write access to the directories that are used for any FILE device classes.

**Windows**

### Database instance name

---

The database instance name is the name of the server instance as it appears in the registry.

For example: Server1

**Windows**

### Instance directory

---

The instance directory is a directory that contains files specifically for a server instance (the server options file and other server-specific files). It can have any name that you want. For easier identification, use a name that ties the directory to the instance name.

You can use a name that includes the name of the server instance as it appears (or will appear) in the registry. Default server instance names have the form `Serverx`.

For example: `C:\tsm\server1`

The instance directory stores the following files for the server instance:

- The server options file, `dsmserv.opt`
- The server key database file, `cert.kdb`, and the `.arm` files (used by clients and other servers to import the Secure Sockets Layer certificates of the server)
- Device configuration file, if the `DEVCONFIG` server option does not specify a fully qualified name
- Volume history file, if the `VOLUMEHISTORY` server option does not specify a fully qualified name
- Volumes for `DEVTYPE=FILE` storage pools, if the directory for the device class is not fully specified, or not fully qualified
- User exits
- Trace output (if not fully qualified)

## Database name

---

The database name is always `TSMDB1`, for every server instance. This name cannot be changed.

## Server name

---

The server name is an internal name for IBM Spectrum Protect, and is used for operations that involve communication among multiple IBM Spectrum Protect servers. Examples include server-to-server communication and library sharing.

**Windows** The server name is also used when you add the server to the Operations Center so that it can be managed using that interface. Use a unique name for each server. For easy identification in the Operations Center (or from a `QUERY SERVER` command), use a name that reflects the location or purpose of the server. Do not change the name of an IBM Spectrum Protect server after it is configured as a hub or spoke server.

If you use the wizard, the default name that is suggested is the host name of the system that you are using. You can use a different name that is meaningful in your environment. If you have more than one server on the system and you use the wizard, you can use the default name for only one of the servers. You must enter a unique name for each server.

**Windows** For example,

- `TUCSON_SERVER1`
- `TUCSON_SERVER2`

## Directories for database space and recovery log

---

The directories can be named according to local practices. For easier identification, consider using names that tie the directories to the server instance.

For example, for the archive log:

- **Windows** `f:\server1\archlog`

## Windows: Installation directories

---

Installation directories for the IBM Spectrum Protect™ server include the server, DB2®, device, language, and other directories. Each one contains several additional directories.

The `(/opt/tivoli/tsm/server/bin)` is the default directory that contains server code and licensing.

The DB2 product that is installed as part of the installation of the IBM Spectrum Protect server has the directory structure as documented in DB2 information sources. Protect these directories and files as you do the server directories. The default directory is `/opt/tivoli/tsm/db2`.

You can use US English, German, French, Italian, Spanish, Brazilian Portuguese, Korean, Japanese, traditional Chinese, simplified Chinese, Chinese GBK, Chinese Big5, and Russian.

## Windows: Installing the server components

---

To install the Version 8.1.2 server components, you can use the installation wizard, the command line in console mode, or silent mode.

### About this task

---

Using the IBM Spectrum Protect™ installation software, you can install the following components:

- server  
Tip: The database (DB2®), the Global Security Kit (GSKit) and IBM® Java™ Runtime Environment (JRE) are automatically installed when you select the server component.
- server languages
- license
- devices
- IBM Spectrum Protect for SAN
- Operations Center

**Windows** Allow approximately 15 - 30 minutes to install a V8.1.2 server, using this guide.

- Windows: Obtaining the installation package  
You can obtain the IBM Spectrum Protect installation package from an IBM download site such as Passport Advantage® or IBM Fix Central.
- Windows: Installing IBM Spectrum Protect by using the installation wizard  
You can install the server by using the IBM Installation Manager graphical wizard.
- Windows: Installing IBM Spectrum Protect by using console mode  
You can install IBM Spectrum Protect by using the command line in console mode.
- Windows: Installing IBM Spectrum Protect in silent mode  
You can install or upgrade the server in silent mode. In silent mode, the installation does not send messages to a console but instead stores messages and errors in log files.
- Windows: Installing server language packages  
Translations for the server allow the server to display messages and help in languages other than US English. The translations also allow for the use of locale conventions for date, time, and number formatting.

## Windows: Obtaining the installation package

---

You can obtain the IBM Spectrum Protect™ installation package from an IBM® download site such as Passport Advantage® or IBM Fix Central.

### Procedure

---

1. Download the appropriate package file from one of the following websites.
  - Download the server package from Passport Advantage or Fix Central.
  - For the latest information, updates, and maintenance fixes, go to the IBM Support Portal.
2. If you downloaded the package from an IBM download site, complete the following steps:

**Windows**

- a. Verify that you have enough space to store the installation files when they are extracted from the product package.  
See the download document for the space requirements:
  - IBM Spectrum Protect technote 4042944
  - IBM Spectrum Protect Extended Edition technote 4042945
  - IBM Spectrum Protect for Data Retention technote 4042946
- b. Change to the directory where you placed the executable file.  
Important: In the next step, the files are extracted to the current directory. The path must contain no more than 128 characters. Be sure to extract the installation files to an empty directory. Do not extract to a directory that contains previously extracted files, or any other files.
- c. Either double-click the executable file, or enter the following command on the command line to extract the installation files. The files are extracted to the current directory.

*package\_name.exe*

where *package\_name* is like this example: 8.1.x.000-IBM-SPSRV-WindowsX64.exe

3. Select one of the following methods of installing IBM Spectrum Protect:
  - o Windows: Installing IBM Spectrum Protect by using the installation wizard
  - o Windows: Installing IBM Spectrum Protect by using console mode
  - o Windows: Installing IBM Spectrum Protect in silent mode
4. After you install IBM Spectrum Protect, and before you customize it for your use, go to the IBM Support Portal. Click Support and downloads and apply any applicable fixes.

## Windows: Installing IBM Spectrum Protect by using the installation wizard

You can install the server by using the IBM® Installation Manager graphical wizard.

### Before you begin

Take the following actions before you start the installation:

- Verify that the operating system is set to the language that you require. By default, the language of the operating system is the language of the installation wizard.
- **Windows** Ensure that the user ID that you plan to use during the installation is a user with local Administrator authority.

### Procedure

Install IBM Spectrum Protect™ by using this method:

Option	Description
<b>Installing the software from a downloaded package:</b>	<ol style="list-style-type: none"><li>a. Change to the directory where you downloaded the package.</li><li>b. Start the installation wizard by issuing the following command: <b>Windows</b> <pre>install.bat</pre><b>Windows</b> Or, in the directory where the installation files were extracted, double-click the install.bat file.</li></ol>

### What to do next

- If errors occur during the installation process, the errors are recorded in log files that are stored in the IBM Installation Manager logs directory.

You can view installation log files by clicking File > View Log from the Installation Manager tool. To collect these log files, click Help > Export Data for Problem Analysis from the Installation Manager tool.
- After you install the server and components, and before you customize it for your use, go to the IBM Support Portal. Click Downloads (fixes and PTFs) and apply any applicable fixes.
- **Windows** After you install a new server, review Taking the first steps after you install IBM Spectrum Protect to learn about configuring your server.
- **Windows** If a native device driver is available on Windows for the tape drives or medium changers that you plan to use, use the native device driver. If a native device driver is not available on Windows for the tape drives or medium changers that you plan to use, install the IBM Spectrum Protect device driver by issuing the `dpinst.exe /a` command. The `dpinst.exe` file is in the device driver directory. The default directory is `C:\Program Files\Tivoli\TSM\device\drivers`.

## Windows: Installing IBM Spectrum Protect by using console mode

You can install IBM Spectrum Protect™ by using the command line in console mode.

### Before you begin

Take the following actions before you start the installation:

- Verify that the operating system is set to the language that you require. By default, the language of the operating system is the language of the installation wizard.
- **Windows** Ensure that the user ID that you plan to use during the installation is a user with local Administrator authority.

## Procedure

Install IBM Spectrum Protect by using this method:

Option	Description
<b>Installing the software from a downloaded package:</b>	<p>a. Change to the directory where you downloaded the package.</p> <p>b. Start the installation wizard in console mode by issuing the following command: <b>Windows</b></p> <pre>install.bat -c</pre> <p>Optional: Generate a response file as part of a console mode installation. Complete the console mode installation options, and in the Summary panel, specify <b>G</b> to generate the responses.</p>

## What to do next

- If errors occur during the installation process, the errors are recorded in log files that are stored in the IBM® Installation Manager logs directory, for example:
  - **Windows** C:\ProgramData\IBM\Installation Manager\logs
- After you install the server and components, and before you customize it for your use, go to the IBM Support Portal. Click Downloads (fixes and PTFs) and apply any applicable fixes.
- **Windows** After you install a new server, review Taking the first steps after you install IBM Spectrum Protect to learn about configuring your server.
- **Windows** If a native device driver is available on Windows for the tape drives or medium changers that you plan to use, use the native device driver. If a native device driver is not available on Windows for the tape drives or medium changers that you plan to use, install the IBM Spectrum Protect device driver by issuing the `dpinst.exe /a` command. The `dpinst.exe` file is in the device driver directory. The default directory is C:\Program Files\Tivoli\TSM\device\drivers.

## Windows: Installing IBM Spectrum Protect in silent mode

You can install or upgrade the server in silent mode. In silent mode, the installation does not send messages to a console but instead stores messages and errors in log files.

## Before you begin

To provide data input when you use the silent installation method, you can use a response file. The following sample response files are provided in the input directory where the installation package is extracted:

install\_response\_sample.xml

Use this file to install the IBM Spectrum Protect™ components.

update\_response\_sample.xml

Use this file to upgrade the IBM Spectrum Protect components.

These files contain default values that can help you avoid any unnecessary warnings. To use these files, follow the instructions that are provided in the files.

If you want to customize a response file, you can modify the options that are in the file. For information about response files, see Response files.

## Procedure

1. Create a response file. You can modify the sample response file or create your own file.
2. If you install the server and Operations Center in silent mode, create a password for the Operations Center truststore in the response file.

If you are using the `install_response_sample.xml` file, add the password in the following line of the file, where `mypassword` represents the password:

```
<variable name='ssl.password' value='mypassword' />
```

For more information about this password, see Installation checklist

Tip: To upgrade the Operations Center, the truststore password is not required if you are using the `update_response_sample.xml` file.

3. Start the silent installation by issuing the following command from the directory where the installation package is extracted. The value `response_file` represents the response file path and file name:

o **Windows**

```
install.bat -s -input response_file -acceptLicense
```

## What to do next

- If errors occur during the installation process, the errors are recorded in log files that are stored in the IBM® Installation Manager logs directory, for example:
  - o **Windows** `C:\ProgramData\IBM\Installation Manager\logs`
- After you install the server and components, and before you customize it for your use, go to the IBM Support Portal. Click Downloads (fixes and PTFs) and apply any applicable fixes.
- **Windows** After you install a new server, review Taking the first steps after you install IBM Spectrum Protect to learn about configuring your server.
- **Windows** If a native device driver is available on Windows for the tape drives or medium changers that you plan to use, use the native device driver. If a native device driver is not available on Windows for the tape drives or medium changers that you plan to use, install the IBM Spectrum Protect device driver by issuing the `dpinst.exe /a` command. The `dpinst.exe` file is in the device driver directory. The default directory is `C:\Program Files\Tivoli\TSM\device\drivers`.

**Windows**

## Windows: Installing server language packages

Translations for the server allow the server to display messages and help in languages other than US English. The translations also allow for the use of locale conventions for date, time, and number formatting.

### Before you begin

For instructions on installing storage agent language packages, see Language pack configuration for storage agents.

- **Windows: Server language locales**  
Use either the default language package option or select another language package to display server messages and help.
- **Windows: Configuring a language package**  
After you configure a language package, messages and help are shown on the server in languages other than US English. Installation packages are provided with IBM Spectrum Protect™.
- **Windows: Updating a language package**  
You can modify or update a language package by using the IBM® Installation Manager.

## Windows: Server language locales

Use either the default language package option or select another language package to display server messages and help.

**Windows** This language package is automatically installed for the following default language option for server messages and help: LANGUAGE AMENG.

For languages or locales other than the default, install the language package that your installation requires.

You can use the languages that are shown:

**Windows**

Table 1. Server languages for Windows

Language	LANGUAGE option value
Chinese, Simplified	chs
Chinese, Traditional	cht
English	ameng
French	fra
German	deu

Language	LANGUAGE option value
Italian	ita
Japanese (Shift-JIS)	jpn
Korean	kor
Portuguese, Brazilian	ptb
Russian	rus
Spanish	esp

**Windows** Restriction: For Operations Center users, some characters might not be displayed properly if the web browser does not use the same language as the server. If this problem occurs, set the browser to use the same language as the server.

## Windows: Configuring a language package

After you configure a language package, messages and help are shown on the server in languages other than US English. Installation packages are provided with IBM Spectrum Protect™.

### About this task

**Windows** Set the LANGUAGE option in the server options file to the name of the locale that you want to use. For example: to use the `ita` locale, set the LANGUAGE option to `ita`. See Windows: Server language locales.

If the locale is successfully initialized, it formats the date, time, and number for the server. If the locale is not successfully initialized, the server uses the US English message files and the date, time, and number format.

## Windows: Updating a language package

You can modify or update a language package by using the IBM® Installation Manager.

### About this task

You can install another language package within the same IBM Spectrum Protect™ instance.

- Use the Modify function of IBM Installation Manager to install another language package.
- Use the Update function of IBM Installation Manager to update to newer versions of the language packages.

Tip: In IBM Installation Manager, the term *update* means to discover and install updates and fixes to installed software packages. In this context, *update* and *upgrade* are synonymous.

## Windows: Taking the first steps after you install IBM Spectrum Protect

After you install Version 8.1.2, prepare for the configuration. Using the configuration wizard is the preferred method of configuring the IBM Spectrum Protect™ instance.

### About this task

1. Create the directories and user ID for the server instance. See Windows: Creating the user ID and directories for the server instance.
2. Configure a server instance. Select one of the following options:
  - Use the configuration wizard, the preferred method. See Windows: Configuring IBM Spectrum Protect by using the configuration wizard.
  - Manually configure the new instance. See Windows: Configuring the server instance manually. Complete the following steps during a manual configuration.
    - a. Set up your directories and create the IBM Spectrum Protect instance. See Windows: Creating the server instance.
    - b. Create a new server options file by copying the sample file to set up communications between the server and clients. See **Windows** Windows: Configuring server and client communications.



- c. Issue the DSMSEV FORMAT command to format the database. See Windows: Formatting the database and log.
  - d. Configure your system for database backup. See Windows: Preparing the database manager for database backup.
3. Configure options to control when database reorganization runs. See Windows: Configuring server options for server database maintenance.
  4. Start the server instance if it is not already started.
    - o **Windows** See Windows: Starting the server instance on Windows systems.
  5. Register your license. See Windows: Registering licenses.
  6. Prepare your system for database backups. See Windows: Specifying a device class in preparation for database backups.
  7. Monitor the server. See Windows: Monitoring the server.

- Windows: Creating the user ID and directories for the server instance  
Create the user ID for the IBM Spectrum Protect server instance and create the directories that the server instance needs for database and recovery logs.
- Windows: Configuring the IBM Spectrum Protect server  
After you have installed the server and prepared for the configuration, configure the server instance.
- Windows: Configuring server options for server database maintenance  
To help avoid problems with database growth and server performance, the server automatically monitors its database tables and reorganizes them when needed. Before starting the server for production use, set server options to control when reorganization runs. If you plan to use data deduplication, ensure that the option to run index reorganization is enabled.
- **Windows** Windows: Starting the server instance on Windows systems  
In a production environment, the preferred method for starting the server is as a Windows service. In an environment where you are reconfiguring, testing, or completing maintenance tasks, start the server in the foreground or use maintenance mode.
- Windows: Stopping the server  
You can stop the server when needed to return control to the operating system. To avoid losing administrative and client node connections, stop the server only after current sessions are completed or canceled.
- Windows: Registering licenses  
Immediately register any IBM Spectrum Protect licensed functions that you purchase so you do not lose any data after you start server operations, such as backing up your data.
- Windows: Specifying a device class in preparation for database backups  
To prepare the system for automatic and manual database backups, you must specify the device class to be used.
- Windows: Running multiple server instances on a single system  
You can create more than one server instance on your system. Each server instance has its own instance directory, and database and log directories.
- Windows: Monitoring the server  
When you start to use the server in production, monitor the space that is used by the server to ensure that the amount of space is adequate. Adjust the space if needed.

## Windows: Creating the user ID and directories for the server instance

---

Create the user ID for the IBM Spectrum Protect™ server instance and create the directories that the server instance needs for database and recovery logs.

### Before you begin

---

Review the information about planning space for the server before you complete this task. See Windows: Worksheets for planning details for the server.

### Procedure

---

1. Create the user ID that will own the server instance. You use this user ID when you create the server instance in a later step.

#### **Windows**

**Windows** Create a user ID that will be the owner of the IBM Spectrum Protect server instance. A user ID can own more than one IBM Spectrum Protect server instance. Identify the user account that will own the server instance.

When the server is started as a Windows service, this account is the one that the service will log on to. The user account must have administrative authority on the system. One user account can own more than one server instance.

If you have multiple servers on one system and want to run each server with a different user account, create a new user account in this step.

Create the user ID.

Restriction: The user ID must comply with the following rule:

In the user ID, only lowercase letters (a-z), numerals (0-9), and the underscore character ( \_ ) can be used. The user ID must be 30 characters or less, and cannot start with *ibm*, *sql*, *sys*, or a numeral. The user ID and group name cannot be *user*, *admin*, *guest*, *public*, *local*, or any SQL reserved word.

- a. Use the following operating system command to create the user ID:

```
net user user_ID * /add
```

You are prompted to create and verify a password for the new user ID.

- b. Issue the following operating system commands to add the new user ID to the Administrators groups:

```
net localgroup Administrators user_ID /add
net localgroup DB2ADMNS user_ID /add
```

2. Create directories that the server requires.

**Windows** Create empty directories for each item in the table and ensure that the new user ID you just created has read/write permission to the directories. The database, archive log, and active log must reside on different physical volumes.

Item	Example commands for creating the directories	Your directories
The <i>instance directory</i> for the server, which is a directory that will contain files specifically for this server instance (the server options file and other server-specific files)	<code>mkdir d:\tsm\server1</code>	
The database directories	<code>mkdir d:\tsm\db001</code> <code>mkdir e:\tsm\db002</code> <code>mkdir f:\tsm\db003</code> <code>mkdir g:\tsm\db004</code>	
Active log directory	<code>mkdir h:\tsm\log</code>	
Archive log directory	<code>mkdir i:\tsm\archlog</code>	
Optional: Directory for the log mirror for the active log	<code>mkdir j:\tsm\logmirror</code>	
Optional: Secondary archive log directory (failover location for archive log)	<code>mkdir k:\tsm\archlogfailover</code>	

When a server is initially created by using the DSMSEV FORMAT utility or the configuration wizard, a server database and recovery log are created. In addition, files are created to hold database information that is used by the database manager.

3. Log off the new user ID.

## Windows: Configuring the IBM Spectrum Protect server

After you have installed the server and prepared for the configuration, configure the server instance.

### About this task

**Windows** Tip: The IBM Spectrum Protect™ Management Console, which is a Microsoft Management Console (MMC) snap-in, is no longer delivered with IBM Spectrum Protect. The preferred method for configuring the server is to use the configuration wizard. You can use the wizard to complete several server configuration tasks. However, you cannot use the wizard to extend the Active Directory schema so that clients can automatically discover servers.

Configure an IBM Spectrum Protect server instance by selecting one of the following options:

- **Windows: Configuring IBM Spectrum Protect by using the configuration wizard**  
The wizard offers a guided approach to configuring a server. By using the graphical user interface (GUI), you can avoid some configuration steps that are complex when done manually. Start the wizard on the system where you installed the IBM Spectrum Protect server program.
- **Windows: Configuring the server instance manually**  
After installing IBM Spectrum Protect Version 8.1.2, you can configure IBM Spectrum Protect manually instead of using the configuration wizard.

## Windows: Configuring IBM Spectrum Protect by using the configuration wizard

---

The wizard offers a guided approach to configuring a server. By using the graphical user interface (GUI), you can avoid some configuration steps that are complex when done manually. Start the wizard on the system where you installed the IBM Spectrum Protect™ server program.

### Before you begin

---

Before you begin to use the configuration wizard, you must complete all preceding steps to prepare for the configuration. These steps include installing IBM Spectrum Protect, creating the database and log directories, and creating the directories and user ID for the server instance.

**Windows**

### About this task

---

**Windows** **Tip:** The IBM Spectrum Protect Console, which is an MMC snap-in, is no longer delivered with IBM Spectrum Protect. The preferred method for configuring the server instance is to use the configuration wizard. You can use the wizard to complete several configuration tasks.

### Procedure

---

1. Ensure that the following requirements are met: **Windows**
  - Ensure that the following requirements are met:
    - a. Click Start > Administrative Tools > Services.
    - b. In the Services window, select the Remote Registry service if it is not started, and click Start.
  - Ensure ports 137, 139 and 445 are not blocked by a firewall:
    - a. Click Start > Control Panel > Windows Firewall.
    - b. Select Advanced Settings.
    - c. Select Inbound Rules in the left pane.
    - d. Select New Rule in the right pane.
    - e. Create a port rule for TCP ports 137, 139 and 445 to allow connections for domain and private networks.
  - Configure User Account Control:
 

Access all three of the user account control configuration settings by first accessing Local Security Policy Security options, by using the following steps:

    - a. Enable the built-in Administrator account:
      - Select the Accounts: Administrator account status.
      - Select Enable and click OK.
    - b. Disable User Account Control for all Windows administrators:
      - Select the User Account Control: Run all administrators in Admin Approval Mode.
      - Select Disable and click OK.
    - c. Disable User Account Control for the built-in Administrator account:
      - Select the User Account Control: Admin Approval Mode for the Built-in Administrator Account.
      - Select Disable and click OK.
  - Restart the server before you proceed with the Configuration wizard.
2. Start the local version of the wizard:
  - **Windows** Either click Start > All Programs > IBM Spectrum Protect > Configuration Wizard. Or, double-click the `dsmicfgx.exe` program in `installation_directory\server`. The default directory is `C:\Program Files\Tivoli\TSM`.

Follow the instructions to complete the configuration. The wizard can be stopped and restarted, but the server is not operational until the entire configuration process is complete.

- **Windows** Windows: Configuring Remote Execution Protocol on Windows  
Configure remote access settings by using these procedures.

## Windows: Configuring the server instance manually

---

After installing IBM Spectrum Protect™ Version 8.1.2, you can configure IBM Spectrum Protect manually instead of using the configuration wizard.

- Windows: Creating the server instance  
Create an IBM Spectrum Protect instance by issuing the `db2icrt` command.
- **Windows** Windows: Configuring server and client communications  
After installing the server, you can set up client and server communications by specifying options in the server and client options files.
- Windows: Formatting the database and log  
Use the `DSMSERV FORMAT` utility to initialize a server instance. No other server activity is allowed while you initialize the database and recovery log.
- Windows: Preparing the database manager for database backup  
To back up the data in the database to IBM Spectrum Protect, you must enable the database manager and configure the IBM Spectrum Protect application programming interface (API).

## Windows: Creating the server instance

---

Create an IBM Spectrum Protect™ instance by issuing the `db2icrt` command.

### About this task

---

You can have one or more server instances on one workstation.

**Windows** Important: Before you run the `db2icrt` command, ensure that the user and the instance directory of the user exists. If there is no instance directory, you must create it.

The instance directory stores the following files for the server instance:

- The server options file, `dsmserv.opt`
- The server key database file, `cert.kdb`, and the `.arm` files (used by clients and other servers to import the Secure Sockets Layer certificates of the server)
- Device configuration file, if the `DEVCONFIG` server option does not specify a fully qualified name
- Volume history file, if the `VOLUMEHISTORY` server option does not specify a fully qualified name
- Volumes for `DEVTYPE=FILE` storage pools, if the directory for the device class is not fully specified, or not fully qualified
- User exits
- Trace output (if not fully qualified)

#### Windows

1. Log in as an administrator and create an IBM Spectrum Protect instance, by using the `db2icrt` command. Enter the following command on one line. The user account that you specify becomes the user ID that owns the Version 8.1.2 server (the instance user ID).

```
db2icrt -u user_account instance_name
```

For example, if the user account is `tminst1` and the server instance is `Server1`, enter the following command:

```
db2icrt -u tminst1 server1
```

You are prompted for the password for user ID `tminst1`. Later, when you create and format the database, you use the instance name that you specified with this command, with the `-k` option.

2. Change the default path for the database to be the drive where the instance directory for the server is located. Complete the following steps:
  - a. Click Start > Programs > IBM DB2 > DB2TSM1 > Command Line Tools > Command Line Processor.
  - b. Enter `quit` to exit the command line processor.

A window with a command prompt should now be open, with the environment properly set up to successfully issue the commands in the next steps.

- c. From the command prompt in that window, issue the following command to set the environment variable for the server instance that you are working with:

```
set db2instance=instance_name
```

The *instance\_name* is the same as the instance name that you specified when you issued the db2icrt command. For example, to set the environment variable for the *Server1* server instance, issue the following command:

```
set db2instance=server1
```

- d. Issue the command to set the default drive:

```
db2 update dbm cfg using dftdbpath instance_location
```

For example, the instance directory is d:\tsm\server1 and the instance location is drive d:. Enter the command:

```
db2 update dbm cfg using dftdbpath d:
```

3. Create a new server options file. See Windows: Configuring server and client communications.

Windows

## Windows: Configuring server and client communications

---

After installing the server, you can set up client and server communications by specifying options in the server and client options files.

### About this task

---

Set these server options before you start the server. When you start the server, the new options go into effect. If you modify any server options after starting the server, you must stop and restart the server to activate the updated options.

Review the server options file (*dsmserv.opt.smp*) that is located in the server instance directory to view and specify server communications options. By default, the server uses the TCP/IP and Named Pipes communication methods.

Tip: If you start the server console and see warning messages that a protocol could not be used by the server, either the protocol is not installed or the settings do not match the Windows protocol settings.

For a client to use a protocol that is enabled on the server, the client options file must contain corresponding values for communication options. In the server options file, you can view the values for each protocol.

You can specify one or more of the following communication methods:

- TCP/IP Version 4 or Version 6
- Named Pipes
- Shared memory
- Secure Sockets Layer (SSL)  
Tip: You can authenticate passwords with the LDAP directory server, or authenticate passwords with the server. Passwords that are authenticated with the LDAP directory server can provide enhanced system security.
- **Windows** Windows: Setting TCP/IP options  
Select from a range of TCP/IP options for the IBM Spectrum Protect server or retain the default.
- **Windows** Windows: Setting Named Pipes options  
The Named Pipes communication method is ideal when running the server and client on the same Windows machine. Named Pipes require no special configuration.
- **Windows** Windows: Setting Secure Sockets Layer options  
You can add more protection for your data and passwords by using Secure Sockets Layer (SSL).

## Windows: Setting TCP/IP options

---

Select from a range of TCP/IP options for the IBM Spectrum Protect™ server or retain the default.

### About this task

---

The following is an example of a list of TCP/IP options that you can use to set up your system.

```
commmethod      tcpip
tcpport         1500
tcpwindowsize   0
tcpnodelay      yes
```

Tip: You can use TCP/IP Version 4, Version 6, or both.

#### TCPPOINT

The server port address for TCP/IP and SSL communication. The default value is 1500.

#### **Windows** TCPWINDOWSIZE

**Windows** Specifies the size of the TCP/IP buffer that is used when sending or receiving data. The window size that is used in a session is the smaller of the server and client window sizes. Larger window sizes use additional memory but can improve performance.

To use the default window size for the operating system, specify 0.

#### TCPNODELAY

Specifies whether or not the server sends small messages or lets TCP/IP buffer the messages. Sending small messages can improve throughput but increases the number of packets sent over the network. Specify YES to send small messages or NO to let TCP/IP buffer them. The default is YES.

#### TCPADMINPORT

Specifies the port number on which the server TCP/IP communication driver is to wait for TCP/IP or SSL-enabled communication requests other than client sessions. The default is the value of TCPPOINT.

#### SSLTCPPOINT

(SSL-only) Specifies the Secure Sockets Layer (SSL) port number on which the server TCP/IP communication driver waits for requests for SSL-enabled sessions for the command-line backup-archive client and the command-line administrative client.

#### SSLTCPADMINPORT

(SSL-only) Specifies the port address on which the server TCP/IP communication driver waits for requests for SSL-enabled sessions for the command-line administrative client.

## Windows: Setting Named Pipes options

---

The Named Pipes communication method is ideal when running the server and client on the same Windows machine. Named Pipes require no special configuration.

### About this task

---

Here is an example of a Named Pipes setting:

```
commmethod      namedpipe
namedpipename   \\.\pipe\adsmpipe
```

COMMETHOD can be used multiple times in the IBM Spectrum Protect™ server options file, with a different value each time. For example, the following example is possible:

```
commmethod tcpip
commmethod namedpipe
```

## Windows: Setting Secure Sockets Layer options

---

You can add more protection for your data and passwords by using Secure Sockets Layer (SSL).

### Before you begin

---

SSL is the standard technology for creating encrypted sessions between servers and clients. SSL provides a secure channel for servers and clients to communicate over open communication paths. With SSL, the identity of the server is verified through the use of digital certificates.

To ensure better system performance, use SSL only for sessions when it is needed. Consider adding additional processor resources on the IBM Spectrum Protect™ server to manage the increased requirements.

## Windows: Formatting the database and log

---

Use the DSMSEV FORMAT utility to initialize a server instance. No other server activity is allowed while you initialize the database and recovery log.

After you set up server communications, you are ready to initialize the database. Ensure that you log in by using the instance user ID. Do not place the directories on file systems that might run out of space. If certain directories (for example, the archive log) become unavailable or full, the server stops.

For optimal performance and to facilitate I/O, specify at least two equally sized containers or Logical Unit Numbers (LUNs) for the database. In addition, each active log and archive log needs its own container or LUN.

**Windows** Important: The installation program creates a set of registry keys. One of these keys points to the directory where a default server, named SERVER1, is created. To install an additional server, create a directory and use the DSMSEV FORMAT utility, with the -k parameter, from that directory. That directory becomes the location of the server. The registry tracks the installed servers.

## Setting the exit list handler

---

Set the DB2NOEXITLIST registry variable to ON for each server instance. Log on to the system as the server instance owner and issue this command:

```
db2set -i server_instance_name DB2NOEXITLIST=ON
```

For example: **Windows**

```
db2set -i server1 DB2NOEXITLIST=ON
```

## Initializing a server instance

---

Use the DSMSEV FORMAT utility to initialize a server instance. For example, if the server instance directory is */tsminst1*, issue the following commands: **Windows**

```
cd /tsminst1
dsmsevr -k server2 format dbdir=d:\tsm\db001 activelogsiz=32768
activelogdirectory=e:\tsm\activelog archlogdirectory=f:\tsm\archlog
archfailoverlogdirectory=g:\tsm\archfaillog mirrorlogdirectory=h:\tsm\mirrorlog
```

Tip: If you specify multiple directories, ensure that the underlying file systems are of equal size to ensure a consistent degree of parallelism for database operations. If one or more directories for the database are smaller than the others, they reduce the potential for optimized parallel prefetching and distribution of the database.

### Related information:

[DSMSEV FORMAT \(Format the database and log\)](#)

## Windows: Preparing the database manager for database backup

---

To back up the data in the database to IBM Spectrum Protect™, you must enable the database manager and configure the IBM Spectrum Protect application programming interface (API).

### About this task

---

If you use the configuration wizard to create an IBM Spectrum Protect server instance, you do not have to complete these steps. If you are configuring an instance manually, complete the following steps before you issue either the BACKUP DB or the RESTORE DB commands.

Attention: If the database is unusable, the entire IBM Spectrum Protect server is unavailable. If a database is lost and cannot be recovered, it might be difficult or impossible to recover data that is managed by that server. Therefore, it is critically important to back up the database.

**Windows** Restriction: Database backup and restore over shared memory are not available on Windows systems.

**Windows** In the following commands, the examples use *server1* for the database instance and *d:\tmsserver1* for the IBM Spectrum Protect server directory. Replace these values with your actual values in the commands.

1. Create a file that is called *tmsdbmgr.env* in the *d:\tmsserver1* directory with the following contents:

```
DSMI_CONFIG=server_instance_directory\tmsdbmgr.opt
DSMI_LOG=server_instance_directory
```

2. Set the DSMI\_ api environment-variable configuration for the database instance:

- a. Open a DB2® command window. One method is to go to the C:\Program Files\Tivoli\TSM\db2\bin directory, or if you installed IBM Spectrum Protect in a different location, go to the db2\bin subdirectory in your main installation directory. Then, issue this command:

```
db2cmd
```

- b. Issue this command:

```
db2set -i server1 DB2_VENDOR_INI=d:\tmsserver1\tsmdbmgr.env
```

3. Create a file that is called `tsmdbmgr.opt` in the `d:\tmsserver1` directory with the following contents:

```
*****
nodename $$_TSMDBMGR_$$
commethod tcpip
tcpserveraddr localhost
tcpport 1500
passwordaccess generate
errorlogname d:\tmsserver1\tsmdbmgr.log
```

where

- o *nodename* specifies the node name the client API uses to connect to the server during a database backup. This value must be `$_TSMDBMGR_$$` for database backup to work.
- o *commethod* specifies the client API used to contact the server for database backup.
- o *tcpserveraddr* specifies the server address that the client API uses to contact the server for database backup. To ensure that the database can be backed up, this value must be `localhost`.
- o *tcpport* specifies the port number that the client API uses to contact the server for database backup. Ensure that you enter the same `tcpport` value that is specified in the `dsmserv.opt` server options file.
- o *passwordaccess* is required for the backup node to connect to the server on windows systems.
- o *errorlogname* specifies the error log where the client API logs errors that are encountered during a database backup. This log is typically in the server instance directory. However, this log can be placed in any location where the instance user ID has write-permission.

## Windows: Configuring server options for server database maintenance

---

To help avoid problems with database growth and server performance, the server automatically monitors its database tables and reorganizes them when needed. Before starting the server for production use, set server options to control when reorganization runs. If you plan to use data deduplication, ensure that the option to run index reorganization is enabled.

### About this task

---

Table and index reorganization requires significant processor resources, active log space, and archive log space. Because database backup takes precedence over reorganization, select the time and duration for reorganization to ensure that the processes do not overlap and reorganization can complete.

**Windows** You can optimize index and table reorganization for the server database. In this way, you can help to avoid unexpected database growth and performance issues. For instructions, see technote 1683633.

If you update these server options while the server is running, you must stop and restart the server before the updated values take effect.

### Procedure

---

1. Modify the server options.

**Windows** Edit the server options file, `dsmserv.opt`, in the server instance directory by using a text editor. Follow these guidelines when you edit the server options file:

- o To enable an option, remove the asterisk at the beginning of the line.
- o Enter an option on any line.
- o Enter only one option per line. The entire option with its value must be on one line.
- o If you have multiple entries for an option in the file, the server uses the last entry.

To view available server options, see the sample file, `dsmserv.opt.smp`, in the `c:\Program Files\Tivoli\TSM` directory.

2. If you plan to use data deduplication, enable the `ALLOWREORGINDEX` server option. Add the following option and value to the server options file:



```
allowreorgindex yes
```

3. Set the REORGBEGINTIME and REORGDURATION server options to control when reorganization starts and how long it runs. Select a time and duration so that reorganization runs when you expect that the server is least busy. These server options control both table and index reorganization processes.
  - a. Set the time for reorganization to start by using the REORGBEGINTIME server option. Specify the time by using the 24-hour system. For example, to set the start time for reorganization as 8:30 p.m., specify the following option and value in the server options file:

```
reorgbegintime 20:30
```

- b. Set the interval during which the server can start reorganization. For example, to specify that the server can start reorganization for four hours after the time set by the REORGBEGINTIME server option, specify the following option and value in the server options file:

```
reorgduration 4
```

4. If the server was running while you updated the server options file, stop and restart the server.

**Related information:**

[ALLOWREORGINDEX](#)

[ALLOWREORGTABLE](#)

[REORGBEGINTIME](#)

[REORGDURATION](#)

[Windows](#)

## Windows: Starting the server instance on Windows systems

In a production environment, the preferred method for starting the server is as a Windows service. In an environment where you are reconfiguring, testing, or completing maintenance tasks, start the server in the foreground or use maintenance mode.

### Before you begin

Select one of the following methods for starting the server:

**As a Windows service**

This method is useful in a production environment. When you configure the server to run as a service, you can specify that the server starts automatically whenever the system is started.

**In the foreground**

This method is useful when you are configuring or testing the server. When you start the server in the foreground, IBM Spectrum Protect™ provides a special administrator user ID that is named SERVER\_CONSOLE. All server messages are displayed in the foreground. The messages can be useful if you must debug startup problems.

**In maintenance mode**

This method is useful when you are completing maintenance or reconfiguration tasks. When you start the server in maintenance mode, you disable operations that might disrupt your maintenance or reconfiguration tasks.

### Procedure

Follow the instructions for your selected option:

Option	Description
<b>Starting the server as a Windows service</b>	To start the server as a Windows service, take one of the following actions: <ul style="list-style-type: none"><li>• If you configured the server by using the configuration wizard, complete the following steps:<ol style="list-style-type: none"><li>a. Configure the server to start as a Windows service by following the instructions in Windows: Configuring the server to start as a Windows service.</li><li>b. Start the server by following the instructions in Windows: Starting the server as a Windows service.</li></ol></li><li>• If you did not use the configuration wizard, create and configure the Windows service by following the instructions in Windows: Manually creating and configuring a Windows service.</li></ul>
<b>Starting the server in the foreground</b>	To start the server in the foreground, follow the instructions in Windows: Starting the server in the foreground.

Option	Description
<b>Starting the server in maintenance mode</b>	To start the server in maintenance mode, follow the instructions in Windows: Starting the server in maintenance mode.

Windows

## Windows: Configuring the server to start as a Windows service

Before you can start the server as a Windows service, you must ensure that options and access rights are set correctly.

### Before you begin

A Windows service must be created. If you configured the server by using the configuration wizard, a Windows service was created automatically. In that case, use this procedure to configure the server to start as a Windows service.

If you did not use a wizard, you must create and configure the Windows service manually by following the steps in Windows: Manually creating and configuring a Windows service.

### Procedure

1. From the Windows Start menu, click Run, type `services.msc`, and click OK.
2. In the Services window, select the server instance that you want to start as a service, and click Properties. For example, select TSM INST1, and click Properties.
3. To ensure that the server service starts automatically, click the General tab. From the Startup type list, select Automatic.
4. To set the user for starting the server service, click the Log On tab, and take one of the following actions:
  - o If you plan to run the server service under the Local System account, select Local System account and click OK.
  - o If you plan to run the server service under the instance user ID, take the following actions:
    - a. Select This account, and browse for the user ID that owns the server DB2® instance and has permissions for starting the server.
    - b. In the Select User window, in the Enter the object name to select field, enter the user ID.
    - c. Click Check Names.
    - d. Click OK twice.
5. If you configured the server service to run under the Local System account, grant database access to the Local System account:
  - a. Log on with the user ID that was used to create the server database. This user ID is the user ID that was used to run the DSMSEV FORMAT utility to initialize the server database. Alternatively, if you configured the server with the `dsmicfgx` configuration wizard, this user ID is the user ID that was used to create the instance.
  - b. Open a DB2 command window. If the server is installed on Windows Server 2012, open the Start window, and click DB2 Command Window - Administrator.
  - c. In the DB2 command window, enter the following commands:

```
set DB2INSTANCE=server1
db2 connect to TSMDB1
db2 grant dbadm with dataaccess with accessctrl on database to user system
db2 grant secadm on database to user system
```

Tip: When the server service is configured to run under the Local System account, the database can be accessed by any administrator on the system. In addition, any administrator who can log on to the system can run the server.

### What to do next

To start the service, follow the instructions in Windows: Starting the server as a Windows service.

Windows

## Windows: Starting the server as a Windows service

If you are running IBM Spectrum Protect™ on a Windows operating system, you can start the server as a service.

### Before you begin

A Windows service must be created. The service was created automatically if you configured the server by using the configuration wizard. If the service was created automatically, you must configure the server to start as a service by following the steps in

Windows: Configuring the server to start as a Windows service. Then, use this procedure to start the server as a service.

If you did not use the configuration wizard to create the service, you must create and configure the service manually. Follow the steps in Windows: Manually creating and configuring a Windows service.

## Procedure

---

To start the server as a Windows service, complete the following steps:

1. Log on to the server with a user ID that is in the Administrators group.
2. From the Windows Start menu, click Run, type `services.msc`, and click OK.
3. In the Services window, select the server instance that you want to start, and click Start.

## What to do next

---

Because the server service can issue requests that require action, it is important to monitor server activity with the Operations Center or the administrative client.

To view start and stop completion messages that are logged in the Windows application log, use the Event Viewer tool in the Administrative Tools folder.

Windows

## Windows: Manually creating and configuring a Windows service

---

If you configured the server by using the configuration wizard, a Windows service was created automatically. If a service was not created automatically, you must create it.

## Before you begin

---

To complete this procedure, you must log on with a user ID that is in the Administrators group.

## Procedure

---

To create a Windows service and configure the startup options for the service, complete the following step:

Open a command window and enter the `sc.exe create` command:

```
sc.exe create server_name binPath= "path_to_server -k instance_name"  
start= start_type obj= account_name password= password
```

where:

*server\_name*

Specifies the name of the server service.

*path\_to\_server*

Specifies the path to the `dsmsvc.exe` executable file, including the file name. This path is the default path:

```
C:\Program Files\Tivoli\TSM\server
```

*instance\_name*

Specifies the name of the DB2® instance, which is also the name of the server instance, for example, `Server1`.

*start\_type*

Specifies the method for starting the service. To automatically start the service, enter `auto`. If you specify the `auto` option, the service starts automatically at system startup and restarts automatically whenever the system is restarted. To manually start the service, enter `demand`.

*account\_name*

Specifies the user ID for the account under which the service runs. For example, the account name might be `Administrator`. This parameter is optional. If it is not specified, the Local System account is used.

*password*

Specifies the password for the *account\_name* user account.

Tip: When you enter the command, ensure that you enter a space after each equal sign (=).

## Results

The server starts as a Windows service.

Windows

## Windows: Starting the server in the foreground

To directly interact with an IBM Spectrum Protect™ server, start the server in the foreground. For example, if you want to enter commands, start the server in the foreground.

### Procedure

1. Change to the directory where the server is installed. For example, change to the c:\program files\tivoli\tsm\server directory.
2. Enter the following command:

```
dsmserv -k instance_name
```

where *instance\_name* specifies the server instance.

Windows

## Windows: Services associated with the server on Windows systems

When you start the IBM Spectrum Protect™ server as a service, other services start automatically. These services are associated with the database manager, DB2®.

The following services are associated with the server.

Service name	Purpose	Comments
TSM <i>Server_instance</i>	The service for the server instance that is named <i>Server_instance</i> .  For example: TSM Server1	Set the start and stop options for this service to start and stop the server instance automatically.  Each server instance runs as a separate service.
DB2 - DB2TSM1 - <i>SERVER_INSTANCE</i>	The DB2 service for the server instance that is named <i>Server_instance</i> .  For example: DB2 - DB2TSM1 - SERVER1	This service is automatically started when the service for the server instance is started. The DB2 service is not stopped automatically when you stop the service for the server.  The system has one of these services for each server-instance service that is started on the system.
DB2 Governor (DB2TSM1)	A DB2 service that is created at installation time, and is required for all server instances.	Do not change the options for this service.
DB2 License Server (DB2TSM1)	A DB2 service that is created at installation time, and is required for all server instances.	Do not change the options for this service.
DB2 Management Server (DB2TSM1)	A DB2 service that is created at installation time, and is required for all server instances.	Do not change the options for this service.
DB2 Remote Command Server (DB2TSM1)	A DB2 service that is created at installation time, and is required for all server instances.	Do not change the options for this service.

Windows

## Windows: Starting the server in maintenance mode

You can start the server in maintenance mode to avoid disruptions during maintenance and reconfiguration tasks.

## About this task

---

Start the server in maintenance mode by running the DSMSErv utility with the MAINTENANCE parameter.

The following operations are disabled in maintenance mode:

- Administrative command schedules
- Client schedules
- Reclamation of storage space on the server
- Inventory expiration
- Migration of storage pools

In addition, clients are prevented from starting sessions with the server.

Tips:

- You do not have to edit the server options file, dsmserv.opt, to start the server in maintenance mode.
- While the server is running in maintenance mode, you can manually start the storage-space reclamation, inventory expiration, and storage-pool migration processes.

## Procedure

---

To start the server in maintenance mode, issue the following command:

```
dsmserv maintenance
```

Tip: To view a video about starting the server in maintenance mode, see [Starting a server in maintenance mode](#).

## What to do next

---

To resume server operations in production mode, complete the following steps:

1. Shut down the server by issuing the HALT command:

```
halt
```

2. Start the server by using the method that you use in production mode.

Operations that were disabled during maintenance mode are reenabled.

## Windows: Stopping the server

---

You can stop the server when needed to return control to the operating system. To avoid losing administrative and client node connections, stop the server only after current sessions are completed or canceled.

## About this task

---

To stop the server, issue the following command from the IBM Spectrum Protect™ command line:

```
halt
```

## Windows: Registering licenses

---

Immediately register any IBM Spectrum Protect™ licensed functions that you purchase so you do not lose any data after you start server operations, such as backing up your data.

## About this task

---

Use the REGISTER LICENSE command for this task. See REGISTER LICENSE for more details.

## Example: Register a license

---

Register the base IBM Spectrum Protect license.

```
register license file=tsmbasic.lic
```

## Windows: Specifying a device class in preparation for database backups

---

To prepare the system for automatic and manual database backups, you must specify the device class to be used.

### Before you begin

---

Ensure that you have defined a tape or file device class. For details, see DEFINE DEVCLASS, or search for defining a device class.

### About this task

---

Complete the following steps to set up your system for database backups.

### Procedure

---

1. If you did not use the configuration wizard (dsmicfgx) to configure the server, ensure that you have completed the steps to manually configure the system for database backups.
2. Select the device class to be used for backups of the database. Issue the following command from an IBM Spectrum Protect™ administrative command line.

```
set dbrecovery device_class_name
```

The device class that you specify is used by the database manager for database backups. If you do not specify a device class with the SET DBRECOVERY command, the backup fails.

### Example

---

For example, to specify that the DBBACK device class is to be used, issue this command:

```
set dbrecovery ddback
```

## Windows: Running multiple server instances on a single system

---

You can create more than one server instance on your system. Each server instance has its own instance directory, and database and log directories.

Multiply the memory and other system requirements for one server by the number of instances planned for the system.

**Windows** The set of files for one instance of the server is stored separately from the files used by another server instance on the same system. Use the steps in Windows: Creating the server instance for each new instance, optionally creating the new instance user.

To manage the system memory that is used by each server, use the DBMEMPERCENT server option to limit the percentage of system memory. If all servers are equally important, use the same value for each server. If one server is a production server and other servers are test servers, set the value for the production server to a higher value than the test servers.

You can upgrade directly from either V6.3 to V7.1. See the upgrade section (Upgrading to V8.1) for more details. When you upgrade and have multiple servers on your system, you must run the installation wizard only once. The installation wizard collects the database and variables information for all of your original server instances.

If you upgrade from IBM Spectrum Protect V6.3 to V8.1.2 and have multiple servers on your system, all instances that exist in DB2® V9.7 are dropped and recreated in DB2 V11.1. The wizard issues the `db2 upgrade db dbname` command for each database. The database environment variables for each instance on your system are also reconfigured during the upgrade process.

**Windows** A typical IBM Spectrum Protect installation involves one server instance on the IBM Spectrum Protect server computer. You might want to install a second instance if you are configuring in a clustered environment. You might also want to run more than one server on a large computer if you have multiple tape libraries or a disk-only configuration. After you install and configure the first IBM Spectrum Protect server, use the Server Initialization wizard to create additional IBM Spectrum Protect server instances on the same computer.

**Windows** By using the Server Initialization wizard, you can install up to four IBM Spectrum Protect server instances on a single system or cluster.

**Related tasks:**

[Running multiple server instances on a single system \(V7.1.1\)](#)

## Windows: Monitoring the server

---

When you start to use the server in production, monitor the space that is used by the server to ensure that the amount of space is adequate. Adjust the space if needed.

### Procedure

---

1. Monitor the active log to ensure that the size is correct for the workload that is handled by the server instance.

When the server workload reaches its typical expected level, the space that is used by the active log is 80% - 90% of the space that is available to the active log directory. At that point, you might need to increase the amount of space. Whether you must increase the space depends on the types of transactions in the server workload. Transaction characteristics affect how the active log space is used.

The following transaction characteristics can affect the space usage in the active log:

- o The number and size of files in backup operations
  - Clients such as file servers that back up large numbers of small files can cause large numbers of transactions that are completed quickly. The transactions might use a large amount of space in the active log, but for a short time.
  - Clients such as a mail server or a database server that back up large amounts of data in few transactions can cause small numbers of transactions that take a long time to complete. The transactions might use a small amount of space in the active log, but for a long time.
- o Network connection types
  - Backup operations that occur over fast network connections cause transactions that complete more quickly. The transactions use space in the active log for a shorter time.
  - Backup operations that occur over relatively slower connections cause transactions that take a longer time to complete. The transactions use space in the active log for a longer time.

If the server is handling transactions with a wide variety of characteristics, the space that is used for the active log might increase and decrease significantly over time. For such a server, you might need to ensure that the active log typically has a smaller percentage of its space used. The extra space allows the active log to grow for transactions that take a long time to complete.

2. Monitor the archive log to ensure that space is always available.

Remember: If the archive log becomes full, and the failover archive log becomes full, the active log can become full, and the server stops. The goal is to make enough space available to the archive log so that it never uses all its available space.

You are likely to notice the following pattern:

- a. Initially, the archive log grows rapidly as typical client-backup operations occur.
- b. Database backups occur regularly, either as scheduled or done manually.
- c. After at least two full database backups occur, log pruning occurs automatically. The space that is used by the archive log decreases when the pruning occurs.
- d. Normal client operations continue, and the archive log grows again.
- e. Database backups occur regularly, and log pruning occurs as often as full database backups occur.

With this pattern, the archive log grows initially, decreases, and then might grow again. Over time, as normal operations continue, the amount of space that is used by the archive log should reach a relatively constant level.

If the archive log continues to grow, consider taking one or both of these actions:

- o Add space to the archive log. You might need to move the archive log to a different file system.
- o Increase the frequency of full database backups, so that log pruning occurs more frequently.

3. If you defined a directory for the failover archive log, determine whether any logs get stored in that directory during normal operations. If the failover log space is being used, consider increasing the size of the archive log. The goal is that the failover archive log is used only under unusual conditions, not in normal operation.

## Windows: Installing an IBM Spectrum Protect server fix pack

---

IBM Spectrum Protect™ maintenance updates, which are also referred to as fix packs, bring your server up to the current maintenance level.

## Before you begin

---

To install a fix pack or interim fix to the server, install the server at the level on which you want to run it. You do not have to start the server installation at the base release level. For example, if you currently have V8.1.1 installed, you can go directly to the latest fix pack for V8.1. You do not have to start with the V8.1.0 installation if a maintenance update is available.

You must have the IBM Spectrum Protect license package installed. The license package is provided with the purchase of a base release. When you download a fix pack or interim fix from Fix Central, install the server license that is available on the Passport Advantage® website. To display messages and help in a language other than US English, install the language package of your choice.

If you upgrade the server to V8.1.2 or later, and then revert the server to a level that is earlier than V8.1.2, you must restore the database to a point in time before the upgrade. During the upgrade process, complete the required steps to ensure that the database can be restored: back up the database, the volume history file, the device configuration file, and the server options file. For more information, see *Windows: Reverting from Version 8.1.2 to a previous server*.

If you are using the client management service, ensure that you upgrade it to the same version as the IBM Spectrum Protect server.

Ensure that you retain the installation media from the base release of the installed server. If you installed IBM Spectrum Protect from a downloaded package, ensure that the downloaded files are available. If the upgrade fails, and the server license module is uninstalled, the installation media from the server base release are required to reinstall the license.

Visit the IBM® Support Portal for the following information:

- A list of the latest maintenance and download fixes. Click **Downloads** and apply any applicable fixes.
- Details about obtaining a base license package. Search for **Downloads > Passport Advantage**.
- Supported platforms and system requirements. Search for **IBM Spectrum Protect supported operating systems**.

Ensure that you upgrade the server before you upgrade backup-archive clients. If you do not upgrade the server first, communication between the server and clients might be interrupted.

Attention: Do not alter the DB2® software that is installed with IBM Spectrum Protect installation packages and fix packs. Do not install or upgrade to a different version, release, or fix pack of DB2 software because doing so can damage the database.

## Procedure

---

To install a fix pack or interim fix, complete the following steps:

1. Back up the database. The preferred method is to use a snapshot backup. A snapshot backup is a full database backup that does not interrupt any scheduled database backups. For example, issue the following IBM Spectrum Protect administrative command:

```
backup db type=dbsnapshot devclass=tapeclass
```

2. Back up the device configuration information. Issue the following IBM Spectrum Protect administrative command:

```
backup devconfig filenames=file_name
```

where *file\_name* specifies the name of the file in which to store device configuration information.

3. Save the volume history file to another directory or rename the file. Issue the following IBM Spectrum Protect administrative command:

```
backup volhistory filenames=file_name
```

where *file\_name* specifies the name of the file in which to store the volume history information.

4. Save a copy of the server options file, typically named `dsmserv.opt`. The file is in the server instance directory.
5. Halt the server before installing a fix pack or interim fix. Use the HALT command.
6. Ensure that extra space is available in the installation directory. The installation of this fix pack might require additional temporary disk space in the installation directory of the server. The amount of additional disk space can be as much as that required for installing a new database as part of an IBM Spectrum Protect installation. The IBM Spectrum Protect installation wizard displays the amount of space that is required for installing the fix pack and the available amount. If the



required amount of space is greater than the available amount, the installation stops. If the installation stops, add the required disk space to the file system and restart the installation.

7. Obtain the package file for the fix pack or interim fix that you want to install from the IBM Support Portal, Passport Advantage, or Fix Central.
8. **Windows** Change to the directory where you placed the executable file. Then, either double-click the following executable file or enter the following command on the command line to extract the installation files.  
Tip: The files are extracted to the current directory. Ensure that the executable file is in the directory where you want the extracted files to be located.

```
8.x.x.x-IBM-SPSRV-platform.exe
```

where: *platform* denotes the operating system that IBM Spectrum Protect is to be installed on.

9. Select one of the following ways of installing IBM Spectrum Protect.  
Important: After a fix pack is installed, it is not necessary to go through the configuration again. You can stop after completing the installation, fix any errors, then restart your servers.  
Install the IBM Spectrum Protect software by using one of the following methods:

#### Installation wizard

Follow the instructions for your operating system:

Windows: Installing IBM Spectrum Protect by using the installation wizard

Tip: After you start the wizard, in the IBM Installation Manager window, click the Update icon; do not click the Install or Modify icon.

#### Command line in console mode

Follow the instructions for your operating system:

Windows: Installing IBM Spectrum Protect by using console mode

#### Silent mode

Follow the instructions for your operating system:

Windows: Installing IBM Spectrum Protect in silent mode

Tip: If you have multiple server instances on your system, run the installation wizard only once. The installation wizard upgrades all server instances.

## Results

---

Correct any errors that are detected during the installation process.

If you installed the server by using the installation wizard, you can view installation logs by using the IBM Installation Manager tool. Click File > View Log. To collect log files, from the IBM Installation Manager tool, click Help > Export Data for Problem Analysis.

If you installed the server by using console mode or silent mode, you can view error logs in the IBM Installation Manager log directory, for example:

- **Windows** C:\ProgramData\IBM\Installation Manager\logs
- **Windows** Windows: Applying a fix pack to IBM Spectrum Protect 8.1.2 in a clustered environment for Windows  
To take advantage of new product features, you can upgrade a server that is installed on a Windows operating system in a clustered environment from V6.3 or V7.1 to IBM Spectrum Protect V8.1.2.

## Windows: Reverting from Version 8.1.2 to a previous server

---

If you must revert to the previous version of the server after an upgrade, you must have a full database backup from your original version. You must also have the server installation media for your original version and key configuration files. Carefully follow the preparation steps before you upgrade the server. By doing so, it might be possible to revert to the previous version of the IBM Spectrum Protect™ server with minimal loss of data.

## Before you begin

---

You must have the following items from the earlier version of the server:

- Server database backup

- Volume history file
- Device configuration file
- Server options file

## About this task

---

Use the same instructions whether you are reverting within releases or to an earlier release, for example, from 8.1.2 to 8.1.1 or from 8.1.2 to 7.1.2. The older version must match the version that you used before the upgrade to V8.1.

Attention: Specify the REUSEDelay parameter to help prevent backup-archive client data loss when you revert the server to a previous version.

- **Windows** Windows: Reverting to the previous server version in a cluster configuration  
If you must revert to the previous version of the server after an upgrade, you must have a full database backup from your original version. You must also have the server installation media for your original version and key configuration files. Carefully follow the preparation steps before you upgrade the server. By doing so, it might be possible to revert to the previous version of the IBM Spectrum Protect server with minimal loss of data.

## Steps for reverting to the previous server version

---

### About this task

Complete the following steps on the system that has the V8.1 server.

### Procedure

1. Halt the server to shut down all server operations by using the HALT command.
2. Remove the database from the database manager, then delete the database and recovery log directories.
  - a. Manually remove the database. One way to remove it is by issuing this command: **Windows**

```
dsmserv -k instance_name removedb tsmdb1
```

- b. If you must reuse the space that is occupied by the database and recovery log directories, you can now delete these directories.
3. Use the uninstallation program to uninstall the V8.1 server. Uninstallation removes the server and the database manager, with their directories. For details, see Windows: Uninstalling IBM Spectrum Protect.
  4. Stop the cluster service. Reinstall the version of the server program that you were using before the upgrade to V8.1.2. This version must match the version that your server was running when you created the database backup that you restore in a later step. For example, the server was at V7.1.7 before the upgrade, and you intend to use the database backup that was in use on this server. You must install the V7.1.7 fix pack to be able to restore the database backup.
  5. Configure the new server database by using the configuration wizard. To start the wizard, issue the following command:

**Windows**

```
/dsmicfgx
```

6. Ensure that no servers are running in the background.
7. Restore the database to a point in time before the upgrade.
8. Copy the following files to the instance directory.
  - Device configuration file
  - Volume history file
  - The server options file (typically dsmserv.opt)
9. If you enabled data deduplication for any FILE-type storage pools that existed before the upgrade, or if you moved data that existed before the upgrade into new storage pools while using the V8.1.2 server, you must complete additional recovery steps. For more details, see Additional recovery steps if you created new storage pools or enabled data deduplication.
10. If the REUSEDelay parameter setting on storage pools is less than the age of the database that you restored, restore volumes on any sequential-access storage pools that were reclaimed after that database backup. Use the RESTORE VOLUME command.  
If you do not have a backup of a storage pool, audit the reclaimed volumes by using the AUDIT VOLUME command, with the FIX=YES parameter to resolve inconsistencies. For example:

```
audit volume volume_name fix=yes
```

11. If client backup or archive operations were completed using the V8.1 server, audit the storage pool volumes on which the data was stored.

## Additional recovery steps if you created new storage pools or enabled data deduplication

If you created new storage pools, turned on data deduplication for any FILE-type storage pools, or did both while your server was running as a V8.1.2 server, you must complete more steps to return to the previous server version.

### Before you begin

To complete this task, you must have a complete backup of the storage pool that was created before the upgrade to V8.1.2.

### About this task

Use this information if you did either or both of the following actions while your server was running as a V8.1.2 server:

- You enabled the data deduplication function for any storage pools that existed before the upgrade to V8.1.2 program. Data deduplication applies only to storage pools that use a FILE device type.
- You created new primary storage pools after the upgrade *and* moved data that was stored in other storage pools into the new storage pools.

Complete these steps after the server is again restored to V7.

### Procedure

- For each storage pool for which you enabled the data deduplication function, restore the entire storage pool by using the RESTORE STGPPOOL command.
- For storage pools that you created after the upgrade, determine what action to take. Data that was moved from existing V8 storage pools into the new storage pools might be lost because the new storage pools no longer exist in your restored V8 server. Possible recovery depends on the type of storage pool:
  - If data was moved from V8 DISK-type storage pools into a new storage pool, space that was occupied by the data that was moved was probably reused. Therefore, you must restore the original V8 storage pools by using the storage pool backups that were created before the upgrade to V8.1.2.
  - If *no* data was moved from V8 DISK-type storage pools into a new storage pool, then audit the storage pool volumes in these DISK-type storage pools.
  - If data was moved from V8 sequential-access storage pools into a new storage pool, that data might still exist and be usable in storage pool volumes on the restored V8 server. The data might be usable if the REUSEDELAY parameter for the storage pool was set to a value that prevented reclamation while the server was running as a V8.1.2 server. If any volumes were reclaimed while the server was running as a V8.1.2 server, restore those volumes from storage pool backups that were created before the upgrade to V8.1.2.

## Windows: Reference: DB2 commands for IBM Spectrum Protect server databases

Use this list as reference when you are directed to issue DB2® commands by IBM® support.

### Purpose

After using the wizards to install and configure IBM Spectrum Protect™, you seldom need to issue DB2 commands. A limited set of DB2 commands that you might use or be asked to issue are listed in Table 1. This list is supplemental material only and is not a comprehensive list. There is no implication that an IBM Spectrum Protect administrator will use it on a daily or ongoing basis. Samples of some commands are provided. Details of output are not listed.

For a full explanation of the commands described here and of their syntax, see the DB2 product information.

Table 1. DB2 commands

Com man d	Description	Example

Command	Description	Example
<small>Windows</small> db2cmd	<small>Windows</small> Opens the command line processor DB2 window, and initializes the DB2 command-line environment.	<small>Windows</small> Open the DB2 command window:  db2cmd
db2icrt	Creates DB2 instances in the home directory of the instance owner. Tip: The IBM Spectrum Protect configuration wizard creates the instance used by the server and database. After a server is installed and configured through the configuration wizard, the db2icrt command is generally not used.  <small>Windows</small> This utility is located in the DB2PATH\bin directory where DB2PATH is the location where the DB2 copy is installed.	Manually create an IBM Spectrum Protect instance. Enter the command on one line:  <pre> /opt/tivoli /tsm/db2/in stance/ db2icrt -a server -u instance_na me instance_na me </pre>
db2set	Displays DB2 variables.	List DB2 variables:  db2set
CATALOG DATA BASE	Stores database location information in the system database directory. The database can be located either on the local workstation or on a remote database partition server. The server configuration wizard takes care of any catalog needed for using the server database. Run this command manually, after a server is configured and running, only if something in the environment changes or is damaged.	Catalog the database:  db2 catalog database tsmdb1
CONNECT TO DATA BASE	Connects to a specified database for command-line interface (CLI) use.	Connect to the IBM Spectrum Protect database from a DB2 CLI:  db2 connect to tsmdb1

Command	Description	Example
GET DATA BASE CON FIGU RATI ON	Returns the values of individual entries in a specific database configuration file. Important: This command and parameters are set and managed directly by DB2. They are listed here for informational purposes and a means to view the existing settings. Changing these settings might be advised by IBM support or through service bulletins such as APARs or Technical Guidance documents (technotes). Do not change these settings manually. Change them only at the direction of IBM and only through the use of IBM Spectrum Protect server commands or procedures.	Show the configuration information for a database alias:  db2 get db cfg for tsmdb1  Retrieve information in order to verify settings such as database configuration, log mode, and maintenance.  db2 get db config for tsmdb1 show detail
GET DATA BASE MAN AGE R CON FIGU RATI ON	Returns the values of individual entries in a specific database configuration file. Important: This command and parameters are set and managed directly by DB2. They are listed here for informational purposes and a means to view the existing settings. Changing these settings might be advised by IBM support or through service bulletins such as APARs or Technical Guidance documents (technotes). Do not change these settings manually. Change them only at the direction of IBM and only through the use of IBM Spectrum Protect server commands or procedures.	Retrieve configuration information for the database manager:  db2 get dbm cfg
GET HEAL TH SNA PSH OT	Retrieves the health status information for the database manager and its databases. The information returned represents a snapshot of the health state at the time the command was issued. IBM Spectrum Protect monitors the state of the database using the health snapshot and other mechanisms that are provided by DB2. There might be cases where the health snapshot or other DB2 documentation indicates that an item or database resource might be in an alert state. Such a case indicates that action must be considered to remedy the situation. IBM Spectrum Protect monitors the condition and responds appropriately. Not all declared alerts by the DB2 database are acted on.	Receive a report on DB2 health monitor indicators:  db2 get health snapshot for database on tsmdb1
GRA NT (Data base Auth oritie s)	Grants authorities that apply to the entire database rather than privileges that apply to specific objects within the database.	Grant access to the user ID itmuser:  db2 GRANT CONNECT ON DATABASE TO USER itmuser db2 GRANT CREATETAB ON DATABASE TO USER itmuser

Command	Description	Example
RUNSTATS	<p>Updates statistics about the characteristics of a table and associated indexes or statistical views. These characteristics include number of records, number of pages, and average record length.</p> <p>To see a table, issue this utility after updating or reorganizing the table.</p> <p>A view must be enabled for optimization before its statistics can be used to optimize a query. A view that is enabled for optimization is known as a statistical view. Use the DB2 ALTER VIEW statement to enable a view for optimization. Issue the RUNSTATS utility when changes to underlying tables substantially affect the rows returned by the view.</p> <p>Tip: The server configures DB2 to run the RUNSTATS command as needed.</p>	<p>Update statistics on a single table.</p> <pre>db2 runstats on table SCHEMA_NAME .TABLE_NAME with distributio n and sampled detailed indexes all</pre>
<small>Windows</small> set db2instance	<p><small>Windows</small> Determines which instance applies to the current session.</p>	<p><small>Windows</small> Determine which instance is applicable:</p> <pre>set db2instance =tsminst1</pre>
SET SCHEMA	<p>Changes the value of the CURRENT SCHEMA special register, in preparation for issuing SQL commands directly through the DB2 CLI.</p> <p>Tip: A special register is a storage area that is defined for an application process by the database manager. It is used to store information that can be referenced in SQL statements.</p>	<p>Set the schema for IBM Spectrum Protect:</p> <pre>db2 set schema tsmdb1</pre>
START DATABASE MANAGER	<p>Starts the current database manager instance background processes. The server starts and stops the instance and database whenever the server starts and halts.</p> <p>Important: Allow the server to manage the starting and stopping of the instance and database unless otherwise directed by IBM support.</p>	<p>Start the database manager:</p> <pre>db2start</pre>
STOP DATABASE MANAGER	<p>Stops the current database manager instance. Unless explicitly stopped, the database manager continues to be active. This command does not stop the database manager instance if any applications are connected to databases. If there are no database connections, but there are instance attachments, the command forces the instance attachments to stop first. Then, it stops the database manager. This command also deactivates any outstanding database activations before stopping the database manager.</p> <p>This command is not valid on a client.</p> <p>The server starts and stops the instance and database whenever the server starts and halts.</p> <p>Important: Allow the server to manage the starting and stopping of the instance and database unless otherwise directed by IBM support.</p>	<p>Stop the database manager:</p> <pre>db2 stop dbm</pre>

## Windows: Uninstalling IBM Spectrum Protect

You can use the following procedures to uninstall IBM Spectrum Protect™. Before you remove IBM Spectrum Protect, ensure that you do not lose your backup and archive data.

## Before you begin

---

Complete the following steps before you uninstall IBM Spectrum Protect:

- Complete a full database backup.
- Save a copy of the volume history and device configuration files.
- Store the output volumes in a safe location.

**Windows** Attention: Do not use the Add/Remove Programs tool in the Windows Control Panel to uninstall IBM Spectrum Protect. Use only the uninstallation procedure that is described in this section.

## About this task

---

You can uninstall IBM Spectrum Protect by using any of the following methods: a graphical wizard, the command line in console mode, or silent mode.

- **Windows: Uninstalling IBM Spectrum Protect by using a graphical wizard**  
You can uninstall IBM Spectrum Protect by using the IBM® Installation Manager installation wizard.
- **Windows: Uninstalling IBM Spectrum Protect in console mode**  
To uninstall IBM Spectrum Protect by using the command line, you must run the uninstallation program of IBM Installation Manager from the command line with the parameter for console mode.
- **Windows: Uninstalling IBM Spectrum Protect in silent mode**  
To uninstall IBM Spectrum Protect in silent mode, you must run the uninstallation program of IBM Installation Manager from the command line with the parameters for silent mode.
- **Windows: Uninstalling and reinstalling IBM Spectrum Protect**  
If you plan to manually reinstall IBM Spectrum Protect instead of using the wizard, there are a number of steps to take to preserve your server instance names and database directories. During an uninstallation, any server instances previously set up are removed, but the database catalogs for those instances still exist.
- **Windows: Uninstalling IBM Installation Manager**  
You can uninstall IBM Installation Manager if you no longer have any products that were installed by IBM Installation Manager.

## What to do next

---

See Windows: Installing the server components for installation steps to reinstall the IBM Spectrum Protect components.

## Windows: Uninstalling IBM Spectrum Protect by using a graphical wizard

---

You can uninstall IBM Spectrum Protect™ by using the IBM® Installation Manager installation wizard.

### Procedure

---

1. Start the Installation Manager.

**Windows** Open the Installation Manager from the Start menu.

2. Click Uninstall.
3. Select IBM Spectrum Protect server, and click Next.
4. Click Uninstall.
5. Click Finish.

## Windows: Uninstalling IBM Spectrum Protect in console mode

---

To uninstall IBM Spectrum Protect™ by using the command line, you must run the uninstallation program of IBM® Installation Manager from the command line with the parameter for console mode.

### Procedure

---

1. In the directory where IBM Installation Manager is installed, go to the following subdirectory:
  - o **Windows** eclipse\tools

For example:

- o **Windows** C:\Program Files\IBM\Installation Manager\eclipse\tools
2. From the tools directory, issue the following command:
  - o **Windows** `imcl.exe -c`
3. To uninstall, enter 5.
4. Choose to uninstall from the IBM Spectrum Protect package group.
5. Enter N for Next.
6. Choose to uninstall the IBM Spectrum Protect server package.
7. Enter N for Next.
8. Enter U for Uninstall.
9. Enter F for Finish.

## Windows: Uninstalling IBM Spectrum Protect in silent mode

---

To uninstall IBM Spectrum Protect™ in silent mode, you must run the uninstallation program of IBM® Installation Manager from the command line with the parameters for silent mode.

### Before you begin

---

You can use a response file to provide data input to silently uninstall the IBM Spectrum Protect server components. IBM Spectrum Protect includes a sample response file, `uninstall_response_sample.xml`, in the input directory where the installation package is extracted. This file contains default values to help you avoid any unnecessary warnings.

If you want to uninstall all IBM Spectrum Protect components, leave `modify="false"` set for each component in the response file. If you do not want to uninstall a component, set the value to `modify="true"`.

If you want to customize the response file, you can modify the options that are in the file. For information about response files, see Response files.

### Procedure

---

1. In the directory where IBM Installation Manager is installed, go to the following subdirectory:
  - o **Windows** `eclipse\tools`

For example:

- o **Windows** C:\Program Files\IBM\Installation Manager\eclipse\tools
2. From the tools directory, issue the following command, where *response\_file* represents the response file path, including the file name:

```
Windows  
imcl.exe -input response_file -silent
```

The following command is an example:

```
Windows  
imcl.exe -input C:\tmp\input\uninstall_response.xml -silent
```

## Windows: Uninstalling and reinstalling IBM Spectrum Protect

---

If you plan to manually reinstall IBM Spectrum Protect™ instead of using the wizard, there are a number of steps to take to preserve your server instance names and database directories. During an uninstallation, any server instances previously set up are removed, but the database catalogs for those instances still exist.

### About this task

---

To manually uninstall and reinstall IBM Spectrum Protect, complete the following steps:

1. **Windows** Make a list of your current server instances before proceeding to the uninstallation. Run the following command:  
`db2ilist`



2. Run the following commands for every server instance:

**Windows**

```
db2 attach to server1
db2 get dbm cfg show detail
db2 detach
```

Keep a record of the database path for each instance.

3. Uninstall IBM Spectrum Protect. See Windows: Uninstalling IBM Spectrum Protect.

**Windows**

After uninstalling IBM Spectrum Protect, check the Control Panel > Add or Remove Programs to verify that IBM Spectrum Protect DB2® is uninstalled.

4. When you uninstall any supported version of IBM Spectrum Protect, including a fix pack, an instance file is created. The instance file is created to help reinstall IBM Spectrum Protect. Check this file and use the information when you are prompted for the instance credentials when reinstalling. In silent installation mode, you provide these credentials using the `INSTANCE_CRED` variable.

You can find the instance file in the following location:

- o **Windows** `C:\ProgramData\IBM\Tivoli\TSM\instanceList.obj` in the IBM Spectrum Protect server installation directory

5. Reinstall IBM Spectrum Protect. See Windows: Installing the server components.

If the `instanceList.obj` file does not exist, you need to recreate your server instances using the following steps:

- a. Recreate your server instances. See Windows: Creating the server instance.

Tip: The installation wizard configures the server instances but you must verify that they exist. If they do not exist, you must manually configure them.

- b. Catalog the database. Log in to each server instance as the instance user, one at a time, and issue the following commands:

**Windows**

```
set db2instance=server1
db2 catalog database tsmdb1
db2 attach to server1
db2 update dbm cfg using dftdbpath instance_drive
db2 detach
```

- c. Verify that IBM Spectrum Protect recognizes the server instance by listing your directories. Your home directory appears if you did not change it. Your instance directory does appear if you used the configuration wizard. Issue this command:

```
db2 list database directory
```

If you see TSMDB1 listed, you can start the server.

## Windows: Uninstalling IBM Installation Manager

---

You can uninstall IBM® Installation Manager if you no longer have any products that were installed by IBM Installation Manager.

### Before you begin

---

Before you uninstall IBM Installation Manager, you must ensure that all packages that were installed by IBM Installation Manager are uninstalled. Close IBM Installation Manager before you start the uninstall process.

**Windows** To view installed packages, click Start > All Programs > IBM Installation Manager > View Installed Packages.

### Procedure

---

To uninstall IBM Installation Manager, complete the following steps:

**Windows**

1. From the Start menu, click Control Panel > Programs and Features.
2. Select IBM Installation Manager and click Uninstall.

## Upgrading to V8.1

---

To take advantage of new product features and updates, upgrade the IBM Spectrum Protect™ server to Version 8.1.2.

## Before you begin

Upgrade the IBM Spectrum Protect server before you update clients. For more information, see:

**AIX** What you should know about security before you install or upgrade the server

**Linux** What you should know about security before you install or upgrade the server

**Windows** What you should know about security before you install or upgrade the server

## About this task

To upgrade the server on the same operating system, see the upgrade instructions. For instructions about migrating the server to a different operating system, see IBM Spectrum Protect Upgrade and Migration Process - Frequently Asked Questions.

Table 1. Upgrade instructions

To upgrade from this version	To this version	See this information
V8.1	V8.1 fix pack or interim fix	<b>AIX</b> Installing an IBM Spectrum Protect server fix pack <b>Linux</b> Installing an IBM Spectrum Protect server fix pack <b>Windows</b> Installing an IBM Spectrum Protect server fix pack
V7.1	V8.1	Installing the server and verifying the upgrade
V7.1	V8.1 fix pack or interim fix	<b>AIX</b> Installing an IBM Spectrum Protect server fix pack <b>Linux</b> Installing an IBM Spectrum Protect server fix pack <b>Windows</b> Installing an IBM Spectrum Protect server fix pack
V5.5, V6.2, or V6.3	V8.1	IBM Spectrum Protect Upgrade and Migration Process - Frequently Asked Questions

An upgrade from V7 to V8.1 takes approximately 20 - 50 minutes. Your environment might produce different results from the results that were obtained in the labs.

For information about upgrades in a clustered environment, see [Upgrading the server in a clustered environment](#).

To revert to an earlier version of the server after an upgrade or migration, you must have a full database backup and the installation software for the original server. You must also have the following key configuration files:

- Volume history file
- Device configuration file
- Server options file
- Upgrading to V8.1  
You can upgrade the server directly from V7.1 to V8.1. You do not have to uninstall V7.1.
- Upgrading the server in a clustered environment  
To upgrade a server to V8.1.2 in a clustered environment, you must complete preparation and installation tasks. The procedures vary, depending on the operating system and release.
- **Windows** Removing GSKit Version 7 after upgrading to IBM Spectrum Protect Version 8.1.2  
The IBM Spectrum Protect installation wizard upgrades GSKit Version 8 and later. GSKit Version 7 is not removed or upgraded when you upgrade to IBM Spectrum Protect Version 8.1.2, even if GSKit was installed with an earlier version of IBM Spectrum Protect.

### Related information:

[IBM Spectrum Protect Upgrade and Migration Process - Frequently Asked Questions](#)

## Upgrading to V8.1

You can upgrade the server directly from V7.1 to V8.1. You do not have to uninstall V7.1.

## Before you begin

---

Ensure that you retain the installation media from the server base release that you are upgrading. If you installed the server components from a DVD, ensure that the DVD is available. If you installed the server components from a downloaded package, ensure that the downloaded files are available. If the upgrade fails, and the server license module is uninstalled, the installation media from the server base release are required to reinstall the license.

Tip: DVDs are no longer available with V8.1 and later.

## Procedure

---

To upgrade the server to V8.1, complete the following tasks:

- **Planning the upgrade**  
Before you upgrade the server from V7.1 to V8.1, you must review the relevant planning information, such as system requirements and release notes. Then, select an appropriate day and time to upgrade the system so that you can minimize the impact on production operations.
- **Preparing the system**  
To prepare the system for the upgrade from V7.1 to V8.1, you must gather information about each DB2® instance. Then, back up the server database, save key configuration files, cancel sessions, and stop the server.
- **Installing the server and verifying the upgrade**  
To complete the process of upgrading the server to V8.1, you must install the V8.1 server. Then, verify that the upgrade was successful by starting the server instance.

## Planning the upgrade

---

Before you upgrade the server from V7.1 to V8.1, you must review the relevant planning information, such as system requirements and release notes. Then, select an appropriate day and time to upgrade the system so that you can minimize the impact on production operations.

## About this task

---

In lab tests, the process of upgrading the server from V7.1 to V8.1 took 14 - 45 minutes. The results that you achieve might differ, depending on your hardware and software environment, and the size of the server database.

## Procedure

---

1. Review the hardware and software requirements:

**AIX** System requirements for AIX® systems

**Linux** System requirements for Linux systems

**Windows** System requirements for Windows systems

For the latest updates related to system requirements, see the IBM Spectrum Protect™ support website at technote 1243309.

2. For special instructions or specific information for your operating system, review the Release notes for Version 8.1 server components and IBM Spectrum Protect server Version 8.1 fix pack readme files.
3. Select an appropriate day and time to upgrade your system to minimize the impact on production operations. The amount of time that is required to update the system depends on the database size and many other factors. When you start the upgrade process, clients cannot connect to the server until the new software is installed and any required licenses are registered again.
4. If you are upgrading the server from V6 or V7 to V8.1, verify that you have the system ID and password for the DB2 instance of the IBM Spectrum Protect server. These credentials are required to upgrade the system.

## Preparing the system

---

To prepare the system for the upgrade from V7.1 to V8.1, you must gather information about each DB2® instance. Then, back up the server database, save key configuration files, cancel sessions, and stop the server.

## Procedure

1. Log on to the computer where the server is installed.

**AIX Linux** Ensure that you are logged on with the instance user ID.

**Windows** Ensure that you are logged on with the administrative user ID that was used to install the V7.1 server.

2. Obtain a list of DB2 instances. Issue the following system command:

**AIX Linux**

```
/opt/tivoli/tsm/db2/instance/db2ilist
```

**Windows**

```
db2ilist
```

The output might be similar to the following example:

**AIX Linux**

```
tsminst1
```

**Windows**

```
SERVER1
```

Ensure that each instance corresponds to a server that is running on the system.

3. **AIX Linux** For each DB2 instance, note the default database path, actual database path, database name, database alias, and any DB2 variables that are configured for the instance. Keep the record for future reference. This information is required to restore the V7.1 database.
4. **Windows** Gather information about each DB2 instance. Note the default database path, actual database path, database name, database alias, and any DB2 variables that are configured for the instance. Keep the record for future reference. This information is required to restore the V7.1 database.

- a. Open the DB2 command window by issuing the following system command:

```
db2cmd
```

- b. To change the instance, issue the following system command:

```
set DB2INSTANCE=instance
```

where *instance* specifies the DB2 instance.

- c. Obtain the default database path for the DB2 instance by issuing the following system command:

```
db2 get dbm cfg | findstr DFTDBPATH
```

The output might be similar to the following example:

```
Default database path (DFTDBPATH) = D:
```

- d. Obtain information about the DB2 instance databases by issuing the following system command:

```
db2 list database directory
```

The output might be similar to the following example:

```
System Database Directory
```

```
Number of entries in the directory = 2
```

```
Database 1 entry:
```

```
Database alias           = TSMAL001
Database name           = TSMDB1
Node name               = TSMNODE1
Database release level  = d.00
Comment                 = TSM SERVER DATABASE VIA TCPIP
Directory entry type    = Remote
Catalog database partition number = -1
Alternate server hostname =
Alternate server port number =
```

Database 2 entry:

```
Database alias           = TSMDB1
Database name           = TSMDB1
Local database directory = D:
Database release level  = d.00
Comment                 =
Directory entry type    = Indirect
Catalog database partition number = 0
Alternate server hostname =
Alternate server port number =
```

- e. Obtain the DB2 instance variables by issuing the following system command:

```
db2set -all
```

The output might be similar to the following example:

```
[e] DB2CODEPAGE=1208
[e] DB2PATH=D:\TSM\db2
[i] DB2_PMODEL_SETTINGS=MAX_BACKGROUND_SYSAPPS:500
[i] DB2_SKIPINSERTED=ON
[i] DB2_KEEPTABLELOCK=OFF
[i] DB2_EVALUNCOMMITTED=ON
[i] DB2_VENDOR_INI=D:\Server1\tsmdbmgr.env
[i] DB2_SKIPDELETED=ON
[i] DB2INSTPROF=C:\ProgramData\IBM\DB2\DB2TSM1
[i] DB2COMM=TCPIP
[i] DB2CODEPAGE=819
[i] DB2_PARALLEL_IO=*
[g] DB2_EXTSECURITY=YES
[g] DB2_COMMON_APP_DATA_PATH=C:\ProgramData

[g] DB2PATH=D:\TSM\db2
[g] DB2INSTDEF=SERVER1
```

5. Connect to the server by using an administrative user ID.
6. Back up the database by using the BACKUP DB command. The preferred method is to create a snapshot backup, which is a full database backup that does not interrupt scheduled database backups. For example, you can create a snapshot backup by issuing the following command:

```
backup db type=dbsnapshot devclass=tapeclass
```

7. Back up the device configuration information to another directory by issuing the following administrative command:

```
backup devconfig filenames=file_name
```

where *file\_name* specifies the name of the file in which to store device configuration information.

Tip: If you decide to restore the V7.1 database, this file is required.

8. Back up the volume history file to another directory. Issue the following administrative command:

```
backup volhistory filenames=file_name
```

where *file\_name* specifies the name of the file in which to store the volume history information.

Tip: If you decide to restore the V7.1 database, this file is required.

9. Save a copy of the server options file, which is typically named dsmserv.opt. The file is in the server instance directory.
10. Prevent activity on the server by disabling new sessions. Issue the following administrative commands:

```
disable sessions client
disable sessions server
```

11. Verify whether any sessions exist, and notify the users that the server will be stopped. To check for existing sessions, issue the following administrative command:

```
query session
```

12. Cancel sessions by issuing the following administrative command:

```
cancel session all
```

This command cancels all sessions except for your current session.

13. Stop the server by issuing the following administrative command:

```
halt
```

14. Verify that the server is shut down and no processes are running.

**AIX** | **Linux** Issue the following command:

```
ps -ef | grep dsmserv
```

**Windows** Open the Windows Task Manager application and review the list of active processes.

15. In the server instance directory of your installation, locate the NODELOCK file and move it to another directory, where you are saving configuration files. The NODELOCK file contains the previous licensing information for your installation. This licensing information is replaced when the upgrade is complete.

**Related reference:**

BACKUP DB (Back up the database)

BACKUP DEVCONFIG (Create backup copies of device configuration information)

BACKUP VOLHISTORY (Save sequential volume history information)

DISABLE SESSIONS (Prevent new sessions from accessing Tivoli Storage Manager)

QUERY SESSION (Query client sessions)

CANCEL SESSION (Cancel one or more client sessions)

HALT (Shut down the server)

## Installing the server and verifying the upgrade

---

To complete the process of upgrading the server to V8.1, you must install the V8.1 server. Then, verify that the upgrade was successful by starting the server instance.

### Before you begin

---

**AIX** | **Linux** You must be logged on to the system by using the root user ID.

**Windows** You must be logged on to the system with the administrative user ID that was used to install the previous server.

You can obtain the installation package from an IBM® download site.

**AIX** | **Linux** Set the system user limit for maximum file size to unlimited to ensure that the files can be downloaded correctly.

1. To query the maximum file size value, run the following command:

```
ulimit -Hf
```

2. If the system user limit for maximum file size is not set to unlimited, change the setting to unlimited by completing the instructions in the documentation for your operating system.

### About this task

---

By using the IBM Spectrum Protect™ installation software, you can install the following components:

- Server  
Tip: The database (DB2®), the Global Security Kit (GSKit), and IBM Java™ Runtime Environment (JRE) are automatically installed when you select the server component.
- Server languages
- License
- Devices
- IBM Spectrum Protect for SAN
- Operations Center

### Procedure

---

1. Download the appropriate package file from one of the following websites:
  - Download the server package from Passport Advantage® or Fix Central.
  - For the most recent information, updates, and maintenance fixes, go to the IBM Support Portal.

## 2. Complete the following steps:

**AIX** | **Linux**  
**AIX** | **Linux**

- a. Verify that you have enough space to store the installation files when they are extracted from the product package. For space requirements, see the download document for your product.
  - IBM Spectrum Protect technote 4042944
  - IBM Spectrum Protect Extended Edition technote 4042945
  - IBM Spectrum Protect for Data Retention technote 4042946
- b. Download the package file to the directory of your choice. The path must contain no more than 128 characters. Be sure to extract the installation files to an empty directory. Do not extract to a directory that contains previously extracted files, or any other files.

Also, ensure that you have executable permission for the package file.

- c. If necessary, run the following command to change the file permissions:

```
chmod a+x package_name.bin
```

where *package\_name* is like the following example:

**AIX**

```
8.1.x.000-IBM-SPSRV-AIX.bin
```

**Linux**

```
8.1.x.000-IBM-SPSRV-Linuxs390x.bin  
8.1.x.000-IBM-SPSRV-Linuxx86_64.bin  
8.1.x.000-IBM-SPSRV-Linuxppc64le.bin
```

In the examples, *8.1.x.000* represents the product release level.

- d. Extract the installation files by running the following command:

```
./package_name.bin
```

The package is large. Therefore, the extraction takes some time.

**Windows**

**Windows**

- a. Verify that you have enough space to store the installation files when they are extracted from the product package. For space requirements, see the download document for your product.
  - IBM Spectrum Protect technote 4042944
  - IBM Spectrum Protect Extended Edition technote 4042945
  - IBM Spectrum Protect for Data Retention technote 4042946
- b. Change to the directory where you placed the executable file.

Tip: In the next step, the files are extracted to the current directory. The path must contain no more than 128 characters. Be sure to extract the installation files to an empty directory. Do not extract to a directory that contains previously extracted files, or any other files.
- c. To extract the installation files, double-click the executable file:

```
package_name.exe
```

Where *package\_name* is similar to the following example:

```
8.1.x.000-SPSRV-WindowsX64.exe
```

The package is large. Therefore, the extraction takes some time.

3. **AIX** To ensure that the IBM Spectrum Protect wizards work correctly, verify that the following command is enabled:
  - o **AIX** `lsuser`

By default, the command is enabled.

4. Install the IBM Spectrum Protect software by using one of the following methods. Install the IBM Spectrum Protect license during the installation process.

Tip: If you have multiple server instances on your system, install the IBM Spectrum Protect software only one time to upgrade all server instances.

Installation wizard

**AIX** To install the server by using the graphical wizard of IBM Installation Manager, follow the instructions in Installing IBM Spectrum Protect by using the installation wizard.

**Linux** To install the server by using the graphical wizard of IBM Installation Manager, follow the instructions in Installing IBM Spectrum Protect by using the installation wizard.

**Windows** To install the server by using the graphical wizard of IBM Installation Manager, follow the instructions in Installing IBM Spectrum Protect by using the installation wizard.

Ensure that your system meets the prerequisites for using the installation wizard. Then, complete the installation procedure. In the IBM Installation Manager window, click the Update or Modify icon.

#### Installing the server by using the console mode

**AIX** To install the server by using the console mode, follow the instructions in Installing Tivoli® Storage Manager by using console mode.

**Linux** To install the server by using the console mode, follow the instructions in Installing Tivoli Storage Manager by using console mode.

**Windows** To install the server by using the console mode, follow the instructions in Installing Tivoli Storage Manager by using console mode.

Review the information about installing the server in console mode and then complete the installation procedure.

#### Silent mode

**AIX** To install the server by using silent mode, follow the instructions in Installing Tivoli Storage Manager in silent mode.

**Linux** To install the server by using silent mode, follow the instructions in Installing Tivoli Storage Manager in silent mode.

**Windows** To install the server by using silent mode, follow the instructions in Installing Tivoli Storage Manager in silent mode.

Review the information about installing the server in silent mode and then complete the installation procedure.

After you install the software, you do not have to reconfigure the system.

#### 5. Correct any errors that are detected during the installation process.

If you installed the server by using the installation wizard, you can view installation logs by using the IBM Installation Manager tool. Click File > View Log. To collect log files, from the IBM Installation Manager tool, click Help > Export Data for Problem Analysis.

If you installed the server by using console mode or silent mode, you can view error logs in the IBM Installation Manager log directory, for example:

- o **AIX** | **Linux** /var/ibm/InstallationManager/logs
- o **Windows** C:\ProgramData\IBM\Installation Manager\logs

#### 6. Go to the IBM Support Portal to obtain fixes. Click Fixes, updates, and drivers and apply any applicable fixes.

#### 7. **AIX** | **Linux** Verify that the upgrade was successful:

- a. Start the server instance.

**AIX** For instructions, see Starting the server instance.

**Linux** For instructions, see Starting the server instance.

- b. Monitor the messages that the server issues as it starts. Watch for error and warning messages, and resolve any issues.
- c. Verify that you can connect to the server by using the administrative client. To start an administrative client session, run the following IBM Spectrum Protect administrative command:

```
dsmadm
```

- d. To obtain information about the upgraded system, run QUERY commands. For example, to obtain consolidated information about the system, run the following IBM Spectrum Protect administrative command:

```
query system
```

To obtain information about the database, run the following IBM Spectrum Protect administrative command:



```
query db format=detailed
```

8. **Windows** Verify that the upgrade was successful:

- a. Start the server instance. To start the server from the default directory, C:\Program Files\Tivoli\TSM, run the following IBM Spectrum Protect administrative command:

```
dsmserve -k server_instance
```

*server\_instance* is the name of your server instance. Server1 is the default name for the first instance of the IBM Spectrum Protect server.

If you plan to run the server as a service under the Local System account, the Local System account must be explicitly granted access to the server database. For instructions, see Starting the server by using Windows services.

- b. Monitor the messages that the server issues as it starts. Watch for error and warning messages, and resolve any issues.
- c. Verify that you can connect to the server by using the administrative client. To start an administrative client session, run the following IBM Spectrum Protect administrative command:

```
dsmadm
```

- d. To obtain information about the upgraded system, run QUERY commands. For example, to obtain consolidated information about the system, run the following IBM Spectrum Protect administrative command:

```
query system
```

To obtain information about the database, run the following IBM Spectrum Protect administrative command:

```
query db format=detailed
```

9. **AIX Linux** Register the licenses for the IBM Spectrum Protect server components that are installed on your system by running the REGISTER LICENSE command:

```
register license file=installation_directory/server/bin/component_name.lic
```

where *installation\_directory* specifies the directory in which you installed the component, and *component\_name* specifies the abbreviation for the component.

For example, if you installed the server in the default directory, /opt/tivoli/tsm, run the following command to register the license:

```
register license file=/opt/tivoli/tsm/server/bin/tsmbasic.lic
```

For example, if you installed IBM Spectrum Protect Extended Edition in the /opt/tivoli/tsm directory, run the following command:

```
register license file=/opt/tivoli/tsm/server/bin/tsmee.lic
```

For example, if you installed IBM Spectrum Protect for Data Retention in the /opt/tivoli/tsm directory, run the following command:

```
register license file=/opt/tivoli/tsm/server/bin/dataret.lic
```

**Restriction:**

You cannot use the IBM Spectrum Protect server to register licenses for the following products:

- o IBM Spectrum Protect for Mail
- o IBM Spectrum Protect for Databases
- o IBM Spectrum Protect for ERP
- o IBM Spectrum Protect for Space Management

The REGISTER LICENSE command does not apply to these licenses. The licensing for these products is done by IBM Spectrum Protect clients.

10. **Windows** Register the licenses for the server components that are installed on your system by running the REGISTER LICENSE command:

```
register license file=installation_directory\server\component_name.lic
```

Where *installation\_directory* specifies the directory in which you installed the component, and *component\_name* specifies the abbreviation for the component.

For example, if you installed the server in the default directory, c:\Program Files\Tivoli\TSM, run the following command to register the license:

```
register license file=c:\Program Files\Tivoli\TSM\server\tsmbasic.lic
```

For example, if you installed IBM Spectrum Protect Extended Edition in the c:\Program Files\Tivoli\TSM directory, run the following command:

```
register license file=c:\Program Files\Tivoli\TSM\server\tsmee.lic
```

For example, if you installed IBM Spectrum Protect for Data Retention in the c:\Program Files\Tivoli\TSM directory, run the following command:

```
register license file=c:\Program Files\Tivoli\TSM\server\dataret.lic
```

**Restriction:**

You cannot use the IBM Spectrum Protect server to register licenses for the following products:

- o IBM Spectrum Protect for Mail
- o IBM Spectrum Protect for Databases
- o IBM Spectrum Protect for ERP
- o IBM Spectrum Protect for Space Management

The REGISTER LICENSE command does not apply to these licenses. The licensing for these products is done by IBM Spectrum Protect clients.

11. Optional: To install an extra language package, use the modify function of the IBM Installation Manager.
12. Optional: To upgrade to a newer version of a language package, use the update function of the IBM Installation Manager.

## What to do next

You can authenticate passwords with the LDAP directory server, or authenticate passwords with the IBM Spectrum Protect server. Passwords that are authenticated with the LDAP directory server can provide enhanced system security.

**Windows** If a device driver is available on Windows for the tape drives or medium changers that you plan to use, use the device driver. If a device driver is not available on Windows for the tape drives or medium changers that you plan to use, install the IBM Spectrum Protect device driver by running the `dpinst.exe /a` command. The `dpinst.exe` file is in the device driver directory. The default directory is C:\Program Files\Tivoli\TSM\device\drivers.

**Related reference:**

- QUERY SYSTEM (Query the system configuration and capacity)
- QUERY DB (Display database information)
- REGISTER LICENSE (Register a new license)

**AIX** | **Linux** | **Windows**

## Upgrading the server in a clustered environment

To upgrade a server to V8.1.2 in a clustered environment, you must complete preparation and installation tasks. The procedures vary, depending on the operating system and release.

### Procedure

Follow the procedure for your operating system, source release, and target release:

**AIX**

Table 1. Procedures for upgrading the server in a clustered environment on an AIX operating system

Source release	Target release	Procedure
V8.1.2	V8.1.2 fix pack	Applying a fix pack to V8 in a clustered environment for AIX
V6.3 or V7.1	V8.1.2	Upgrading IBM Spectrum Protect from V6.3 or V7.1 to V8.1.2 in a clustered environment for AIX with a shared database instance Upgrading from V6.3 to V8.1.2 in a clustered environment for AIX with separate database instances
V6.1	V8.1.2	Upgrading IBM Spectrum Protect from V6.1 to V8.1.2 in a clustered environment for AIX

Source release	Target release	Procedure
V5	V7.1.1 or later	Upgrading the server to V7.1.1 in an AIX clustered environment

Linux

Table 2. Procedures for upgrading the server in a clustered environment on a Linux operating system

Source release	Target release	Procedure
V6 or V7	V8.1.2	Upgrading a server that is configured with Tivoli System Automation

Windows

Table 3. Procedures for upgrading the server in a clustered environment on a Windows operating system

Source release	Target release	Procedure
V8.1.2	V8.1.2 fix pack	Applying a fix pack to V8 in a clustered environment for Windows
V6.3 or V7.1	V8.1.2	Upgrading V6.3 or V7.1 to V8.1 in a clustered environment on Windows
V6.1	V8.1.2	Upgrading V6.1 to V8.1 in a clustered environment on Windows
V5	V7.1 or later	Upgrading the server to V7.1 or later in a Windows clustered environment

- Upgrading IBM Spectrum Protect from V6.3 or V7.1 to V8.1.2 in a clustered environment for AIX with a shared database instance  
You can upgrade an IBM Spectrum Protect server from or V6.3 or V7.1 to V8.1.2 in a clustered environment on AIX with a shared database instance. In this way, you can take advantage of the new features in IBM Spectrum Protect V8.1.2.
- Upgrading from V6.3 to V8.1.2 in a clustered environment for AIX with separate database instances  
You can upgrade a server from V6.3 to V8.1.2 in a clustered environment on AIX with separate database instances. In this way, you can take advantage of the new features in V8.1.2.
- Upgrading IBM Spectrum Protect from V6.1 to V8.1.2 in a clustered environment for AIX  
You can upgrade an IBM Spectrum Protect server on AIX from V6.1 to V8.1.2 in a clustered environment. Complete the upgrade to take advantage of the new features in V8.1.2.
- Upgrading IBM Spectrum Protect to V8.1.2 in a clustered environment for Linux  
To take advantage of new features in IBM Spectrum Protect, you can upgrade the IBM Spectrum Protect server that is installed on a Linux operating system in a clustered environment.
- Upgrading a V6.3 or V7.1 server to V8.1.2 in a clustered environment for Windows  
To take advantage of new product features, you can upgrade a server that is installed on a Windows operating system in a clustered environment from V6.3 or V7.1 to IBM Spectrum Protect V8.1.2.
- Upgrading IBM Tivoli Storage Manager V6.1 to IBM Spectrum Protect V8.1.2 in a clustered environment for Windows  
To take advantage of new features, you can upgrade a server that is installed on a Windows operating system in a clustered environment from V6.1 to V8.1.2.

AIX

## Upgrading IBM Spectrum Protect from V6.3 or V7.1 to V8.1.2 in a clustered environment for AIX with a shared database instance

You can upgrade an IBM Spectrum Protect™ server from or V6.3 or V7.1 to V8.1.2 in a clustered environment on AIX® with a shared database instance. In this way, you can take advantage of the new features in IBM Spectrum Protect V8.1.2.

### Before you begin

Ensure that you retain the installation media from the V6.3 or V7.1 server base release that you are upgrading. If you installed IBM Spectrum Protect from a DVD, ensure that the DVD is available. If you installed IBM Spectrum Protect from a downloaded package, ensure that the downloaded files are available. If the upgrade fails, and the server license module is uninstalled, you must reinstall the license from the installation media of the server base release.

### About this task

Use the following procedure when the DB2® instance directory is shared between the nodes in the cluster. The DB2 instance directory is in the following location:

```
/home/tsminst1/sqllib
```

If the DB2 instance directory is not shared between nodes, follow the instructions in Upgrading from V6.3 to V8.1.2 in a clustered environment for AIX with separate database instances.

## Procedure

---

1. Back up the database by using the BACKUP DB command. The preferred method is to use a snapshot backup, which creates a full database backup without interrupting any scheduled backups. For example, you can create a snapshot backup by running the following command:

```
backup db type=dbsnapshot devclass=tapeclass
```

2. Back up the device configuration information to another directory, by running the following command:

```
backup devconfig filenames=file_name
```

Where *file\_name* specifies the name of the file in which to store device configuration information.

3. Back up the volume history file to another directory, by running the following command:

```
backup volhistory filenames=file_name
```

Where *file\_name* specifies the name of the file in which to store the volume history information.

4. Save a copy of the server options file, typically named dsmserv.opt, which is in the server instance directory.
5. Stop all instances of the server. Verify that no server processes are running. If you are using application-level monitoring of the IBM Spectrum Protect server, use your clustering tool to suspend monitoring of the dsmserv application resource.
6. Verify that the database manager is not running for any instance. Determine whether any db2sysc processes are running. The owner of running processes indicates which instances are active. For each server instance owner, run the following command to stop DB2:

```
db2stop
```

7. On the primary node, install the IBM Spectrum Protect V8.1.2 server by running the `./install.sh` command. For instructions, see Installing the server components. After you start the wizard, in the IBM Installation Manager window, click the Install icon; do not click the Update or Modify icon.
8. Start each V8.1.2 server in the foreground:
  - a. Verify that you are logged in with the instance owner ID.
  - b. Navigate to the instance directory and run the following command:

```
/opt/tivoli/tsm/server/bin/dsmserv
```

Wait until you see the server prompt, which indicates that the server is started.

9. Stop the server for each IBM Spectrum Protect instance that is being upgraded. Issue the following command:

```
halt
```

Tip: Because the DB2 instance directory is shared between the nodes in the cluster, you do not have to move the shared resources to the secondary node in the cluster.

10. On each secondary node in the cluster, complete the following steps:
  - a. Install the IBM Spectrum Protect V8.1.2 server by running the `./install.sh` command. For instructions, see Installing the server components.
    - i. If you are running the installation wizard, in the IBM Installation Manager window, click the Install icon; do not click the Update or Modify icon.
    - ii. If you are running the installation wizard, in the Instance Credentials panel, clear the Update this instance check box for each instance.
    - iii. If you are installing the server in console mode, at the prompt `Do you want update this instance?`, enter `NO` for each instance.
    - iv. If you are installing the server in silent mode, specify `FALSE` for the value of the `user.instance_name_update` variable for each instance.
  - b. Ensure that each IBM Spectrum Protect V8.1.2 server starts. If you are using application-level monitoring, use the clustering tool to start the server.

For instructions about starting the server, see Starting the server instance.

11. Register the licenses for the server components that are installed on your system by running the REGISTER LICENSE command:

```
register license file=installation_directory/server/bin/component_name.lic
```

Where *installation\_directory* specifies the directory in which you installed the component and *component\_name* specifies the abbreviation for the component.

For example, if you installed the server in the default directory, /opt/tivoli/tsm, run the following command to register the license:

```
register license file=/opt/tivoli/tsm/server/bin/tsmbasic.lic
```

For example, if you installed IBM Spectrum Protect Extended Edition in the /opt/tivoli/tsm directory, run the following command:

```
register license file=/opt/tivoli/tsm/server/bin/tsmee.lic
```

For example, if you installed IBM Spectrum Protect for Data Retention in the /opt/tivoli/tsm directory, run the following command:

```
register license file=/opt/tivoli/tsm/server/bin/dataret.lic
```

**Restriction:**

You cannot use the IBM Spectrum Protect server to register licenses for the following products:

- o IBM Spectrum Protect for Mail
- o IBM Spectrum Protect for Databases
- o IBM Spectrum Protect for ERP
- o IBM Spectrum Protect for Space Management

The REGISTER LICENSE command does not apply to these licenses. The licensing for these products is done by IBM Spectrum Protect clients.

**Related reference:**

BACKUP DB (Back up the database)

BACKUP DEVCONFIG (Create backup copies of device configuration information)

BACKUP VOLHISTORY (Save sequential volume history information)

HALT (Shut down the server)

REGISTER LICENSE (Register a new license)

AIX

## Upgrading from V6.3 to V8.1.2 in a clustered environment for AIX with separate database instances

---

You can upgrade a server from V6.3 to V8.1.2 in a clustered environment on AIX® with separate database instances. In this way, you can take advantage of the new features in V8.1.2.

### Before you begin

---

Ensure that you retain the installation media from the V6.3 or V7.1 server base release that you are upgrading. If you installed IBM Spectrum Protect™ from a DVD, ensure that the DVD is available. If you installed IBM Spectrum Protect from a downloaded package, ensure that the downloaded files are available. If the upgrade fails, and the server license module is uninstalled, you must reinstall the license from the installation media of the server base release.

### About this task

---

Use the following procedure when the DB2® instance directory is not shared between the nodes in the cluster. The DB2 instance directory is at the following location:

```
/home/tsminst1/sqllib
```

If the DB2 instance directory is shared between the nodes in the cluster, follow the instructions in Upgrading IBM Spectrum Protect from V6.3 or V7.1 to V8.1.2 in a clustered environment for AIX with a shared database instance.

### Procedure

---

1. Back up the database by using the BACKUP DB command. The preferred method is to use a snapshot backup, which creates a full database backup without interrupting any scheduled backups. For example, you can create a snapshot backup by running the following command:

```
backup db type=dbsnapshot devclass=tapeclass
```

2. Back up the device configuration information to another directory, by running the following command:

```
backup devconfig filenames=file_name
```

Where *file\_name* specifies the name of the file in which to store device configuration information.

3. Back up the volume history file to another directory, by running the following command:

```
backup volhistory filenames=file_name
```

Where *file\_name* specifies the name of the file in which to store the volume history information.

4. Save a copy of the server options file, typically named dmserv.opt, which is in the server instance directory.
5. Stop all instances of the server. Verify that no server processes are running. If you are using application-level monitoring of the IBM Spectrum Protect server, use your clustering tool to suspend monitoring of the dmserv application resource.
6. Verify that the database manager is not running for any instance. Determine whether any db2sysc processes are running. The owner of running processes indicates which instances are active. For each server instance owner, run the following command to stop DB2:

```
db2stop
```

7. Ensure that the shared resources for all IBM Spectrum Protect instances are on the primary node. Verify that no other nodes have write access to these resources during the upgrade. If the environment includes multiple instances of the server, shared resources for all instances must be accessible to the primary node.
8. On the primary node, install the V8.1.2 server by running the `./install.sh` command. For instructions, see Installing the server components. After you start the wizard, in the IBM Installation Manager window, click the Install icon; do not click the Update or Modify icon. To complete the upgrade from V6.3 to V8.1.2, you must install the V8.1.2 server.
9. Start each V8.1.2 server in the foreground:
  - a. Verify that you are logged in with the instance owner ID.
  - b. Navigate to the instance directory and run the following command:

```
/opt/tivoli/tsm/server/bin/dmserv
```

Wait until you see the server prompt, which indicates that the server is started.

10. Stop the server for each IBM Spectrum Protect instance that is being upgraded. Run the following command:

```
halt
```

11. On each secondary node in the cluster, complete the following steps:
  - a. Move all shared resources to the secondary node. If the environment includes multiple instances of the server, shared resources for all instances must be accessible to the secondary nodes during the upgrade.
  - b. Stop all instances of the server. Verify that no server processes are running.
  - c. Verify that the database manager is not running for any instance. Determine whether any db2sysc processes are running. The owner of running processes indicates which instances are active. For each server instance owner, run the following command to stop DB2:

```
db2stop
```

- d. Install the V8.1.2 server by running the `./install.sh` command. For instructions, see Installing the server components.
  - i. If you are using the installation wizard, in the IBM Installation Manager window, click the Install icon; do not click the Update or Modify icon.
  - ii. If you are using the installation wizard, on the Instance Credentials page, select the Configure this instance on a secondary node of the cluster check box for each instance that you are configuring.
  - iii. If you are installing the server in console mode, at the prompt `Configure this instance on a secondary node of the cluster?`, enter `YES` for each instance.
  - iv. If you are installing the server in silent mode, specify `TRUE` for the value of the `user.instance_name_secondaryNode` variable for each instance.
- e. Ensure that each V8.1.2 server starts. If you are using application-level monitoring, use the clustering tool to start the server.

For instructions about starting the server, see Starting the server instance.

12. Register the licenses for the server components that are installed on your system by running the REGISTER LICENSE command:

```
register license file=installation_directory/server/bin/component_name.lic
```

Where *installation\_directory* specifies the directory in which you installed the component and *component\_name* specifies the abbreviation for the component.

For example, if you installed the server in the default directory, /opt/tivoli/tsm, run the following command to register the license:

```
register license file=/opt/tivoli/tsm/server/bin/tsmbasic.lic
```

For example, if you installed IBM Spectrum Protect Extended Edition in the /opt/tivoli/tsm directory, run the following command:

```
register license file=/opt/tivoli/tsm/server/bin/tsmee.lic
```

For example, if you installed IBM Spectrum Protect for Data Retention in the /opt/tivoli/tsm directory, run the following command:

```
register license file=/opt/tivoli/tsm/server/bin/dataret.lic
```

**Restriction:**

You cannot use the IBM Spectrum Protect server to register licenses for the following products:

- o IBM Spectrum Protect for Mail
- o IBM Spectrum Protect for Databases
- o IBM Spectrum Protect for ERP
- o IBM Spectrum Protect for Space Management

The REGISTER LICENSE command does not apply to these licenses. The licensing for these products is done by IBM Spectrum Protect clients.

**Related reference:**

BACKUP DB (Back up the database)

BACKUP DEVCONFIG (Create backup copies of device configuration information)

BACKUP VOLHISTORY (Save sequential volume history information)

HALT (Shut down the server)

REGISTER LICENSE (Register a new license)

AIX

## Upgrading IBM Spectrum Protect from V6.1 to V8.1.2 in a clustered environment for AIX

---

You can upgrade an IBM Spectrum Protect™ server on AIX® from V6.1 to V8.1.2 in a clustered environment. Complete the upgrade to take advantage of the new features in V8.1.2.

### Before you begin

---

Ensure that you retain the installation media from the base release of the V6.1 and V6.3 servers. If you obtained the server software from a DVD, ensure that the DVD is available. If you obtained the server software from a downloaded package, ensure that the downloaded files are available. If the upgrade fails, and the server license module is uninstalled, the installation media from the server base release are required to reinstall the license.

### About this task

---

If the clustered environment contains multiple server instances, move all resources that are required for the instances onto a single cluster node, which is the primary node, during the upgrade process.

### Procedure

---

1. Back up the database by using the BACKUP DB command. The preferred method is to use a snapshot backup, which creates a full database backup without interrupting any scheduled backups. For example, you can create a snapshot backup by running the following command:

```
backup db type=dbsnapshot devclass=tapeclass
```

2. Back up the device configuration information to another directory, by running the following command:

```
backup devconfig filenames=file_name
```

Where *file\_name* specifies the name of the file in which to store device configuration information.

3. Back up the volume history file to another directory, by running the following command:

```
backup volhistory filenames=file_name
```

Where *file\_name* specifies the name of the file in which to store the volume history information.

4. Save a copy of the server options file, which is typically named dsmserv.opt. The file is in the server instance directory.
5. Stop all instances of the IBM Spectrum Protect server. Verify that no IBM Spectrum Protect server processes are running. If you are using application-level monitoring of the IBM Spectrum Protect server, use your clustering tool to suspend monitoring of the dsmserv application resource.
6. Verify that the database manager is not running for any instance. Determine whether any db2sysc processes are running. The owner of running processes indicates which instances are active. For each server instance owner, run the following command to stop DB2®:

```
db2stop
```

7. Ensure that the shared resources for all IBM Spectrum Protect instances are on the primary node. Verify that no other nodes have write access to these resources during the upgrade.
8. On the primary node, install the V6.3 server by using the ./install.bin command. For detailed instructions about installing the V6.3 server, see *Installing the server components*.
9. On the primary node, install the IBM Spectrum Protect V8.1.2 server by running the ./install.sh command. For instructions, see *Installing the server components*. After you start the wizard, in the IBM Installation Manager window, click the Install icon; do not click the Update or Modify icon.
10. Start each IBM Spectrum Protect V8.1.2 server in the foreground. Using the instance owner ID, navigate to the instance directory and issue the following command:

```
/opt/tivoli/tsm/server/bin/dsmserv
```

Wait until you see the server prompt, which indicates that the server is started.

11. Stop the server for each IBM Spectrum Protect instance that is being upgraded.
12. On each secondary node in the cluster, complete the following steps:
  - a. Move all shared resources to the secondary node. If your environment includes multiple instances of IBM Spectrum Protect, shared resources for all instances must be accessible to the secondary nodes during the upgrade.
  - b. Stop all instances of the IBM Spectrum Protect server. Verify that no IBM Spectrum Protect server processes are running.
  - c. Verify that the database manager is not running for any instance. Determine whether any db2sysc processes are running. The owner of running processes indicates which instances are active. For each server instance owner, run the following command to stop DB2:

```
db2stop
```

- d. Uninstall the V6.1 server:

- i. In the /opt/tivoli/tsm/\_uninst directory, issue the following command:

```
cd _uninst
```

- ii. Issue the following command:

```
./Uninstall_Tivoli_Storage_Manager
```

For detailed instructions about uninstalling the server, see the *Tivoli Storage Manager V6.1 documentation*.

- e. Install the IBM Spectrum Protect V8.1.2 server by running the ./install.sh command. In the IBM Installation Manager window, click the Install icon; do not click the Update or Modify icon. For instructions about installing the server, see *Installing the server components*.
  - f. Ensure that each IBM Spectrum Protect V8.1.2 server starts.
13. Register the licenses for the server components that are installed on your system by running the REGISTER LICENSE command:

```
register license file=installation_directory/server/bin/component_name.lic
```



Where *installation\_directory* specifies the directory in which you installed the component and *component\_name* specifies the abbreviation for the component.

For example, if you installed the server in the default directory, `/opt/tivoli/tsm`, run the following command to register the license:

```
register license file=/opt/tivoli/tsm/server/bin/tsmbasic.lic
```

For example, if you installed IBM Spectrum Protect Extended Edition in the `/opt/tivoli/tsm` directory, run the following command:

```
register license file=/opt/tivoli/tsm/server/bin/tsmee.lic
```

For example, if you installed IBM Spectrum Protect for Data Retention in the `/opt/tivoli/tsm` directory, run the following command:

```
register license file=/opt/tivoli/tsm/server/bin/dataret.lic
```

**Restriction:**

You cannot use the IBM Spectrum Protect server to register licenses for the following products:

- o IBM Spectrum Protect for Mail
- o IBM Spectrum Protect for Databases
- o IBM Spectrum Protect for ERP
- o IBM Spectrum Protect for Space Management

The REGISTER LICENSE command does not apply to these licenses. The licensing for these products is done by IBM Spectrum Protect clients.

**Related reference:**

BACKUP DB (Back up the database)

BACKUP DEVCONFIG (Create backup copies of device configuration information)

BACKUP VOLHISTORY (Save sequential volume history information)

HALT (Shut down the server)

REGISTER LICENSE (Register a new license)

Linux

## Upgrading IBM Spectrum Protect to V8.1.2 in a clustered environment for Linux

---

To take advantage of new features in IBM Spectrum Protect™, you can upgrade the IBM Spectrum Protect server that is installed on a Linux operating system in a clustered environment.

### Procedure

---

Follow the instructions in [Configuring a Linux environment for clustering](#).

Windows

## Upgrading a V6.3 or V7.1 server to V8.1.2 in a clustered environment for Windows

---

To take advantage of new product features, you can upgrade a server that is installed on a Windows operating system in a clustered environment from V6.3 or V7.1 to IBM Spectrum Protect™ V8.1.2.

### Before you begin

---

Ensure that you retain the installation media from the V6.3 or V7.1 server base release that you are upgrading. If you installed the server from a downloaded package, ensure that the downloaded files are available. If the upgrade fails, and the server license module is uninstalled, you must reinstall the license from the installation media of the server base release.

### Procedure

---

1. If you plan to install the IBM Spectrum Protect V8.1.2 server on the Windows Server 2012 operating system, install the failover cluster automation server and the failover cluster command interface first. To install these components, issue the

following commands from Windows 2.0 PowerShell:

```
Install-WindowsFeature -Name RSAT-Clustering-AutomationServer  
Install-WindowsFeature -Name RSAT-Clustering-CmdInterface
```

2. Back up the database by using the BACKUP DB command. The preferred method is to use a snapshot backup, which provides a full database backup without interrupting scheduled backups. For example, you can run the following command to create a snapshot backup:

```
backup db type=dbsnapshot devclass=tapeclass
```

3. Back up the device configuration information to another directory. Run the following command:

```
backup devconfig filenames=file_name
```

Where *file\_name* specifies the name of the file in which to store device configuration information.

4. Back up the volume history file to another directory. Run the following command:

```
backup volhistory filenames=file_name
```

Where *file\_name* specifies the name of the file in which to store the volume history information.

5. Save a copy of the server options file, typically named dmserv.opt, which is in the server instance directory.
6. Ensure that the resource group is on the primary node, and that all nodes in the cluster are running. Take the following actions on the primary node:
  - a. In the Failover Cluster Manager window, take the server resource offline and delete it:
    - i. Select Services and applications, and then select the cluster group. The server resource is displayed in the Other Resources section.
    - ii. Select the server resource, and click Take this resource offline.
    - iii. To delete the server resource, select it, and click Delete.
  - b. In the Failover Cluster Manager window, delete the network name and IP address:
    - i. In the Server name section, expand the network name to view the IP address. Note the network name and IP address.
    - ii. Select the network name and the IP address, and click Remove.
  - c. In the Failover Cluster Manager window, take the DB2® server resource offline:
    - i. Select Services and applications, and then select the cluster group. The IBM Spectrum Protect server resource is displayed in the Other Resources section.
    - ii. Select a DB2 server resource, for example, SERVER1, and click Take this resource offline.
7. On the primary node, run the following command to remove DB2 clustering from each IBM Spectrum Protect instance in the cluster:

```
db2mcs -u:instancename
```

For example, run the following command to remove DB2 clustering from the SERVER1 instance:

```
db2mcs -u:server1
```

Tip: You might see an error message about a missing cluster resource. Ignore this message.

8. On the primary node, in the Failover Cluster Manager window, review the resource group Summary section. Verify that only the shared disks and any tape resources remain in the resource group.
9. Stop the cluster service on each node in the cluster and delete the server cluster DLL files. Then, restart the cluster service.
10. Install the IBM Spectrum Protect V8.1.2 server on each node in the cluster. For instructions, see Installing the IBM Spectrum Protect server components. If you use the installation wizard to install the server, in the IBM Installation Manager window, click the Update icon. Do not click the Install or Modify icon.
11. On the primary node, start the server in the foreground to allow the database schema reconciliation and configuration to be completed. When the server starts, halt it by running the HALT command. If your environment has multiple server instances, complete this step for each instance.
12. On the primary node, start the configuration wizard by clicking Start > All Programs > IBM Spectrum Protect server > Configuration Wizard. Complete the following steps in the configuration wizard:
  - a. When you are prompted to enter the user ID, enter the name of the domain account that is associated with the cluster.
  - b. When you are prompted to enter the instance name, enter the name of the instance that you are recluster.
  - c. Click Yes when you are prompted to indicate whether you want to recluster.
  - d. Continue stepping through the wizard until you see a message that the configuration was successful.
13. Register the licenses for the IBM Spectrum Protect server components that are installed on your system by running the REGISTER LICENSE command:

```
register license file=installation_directory\server\component_name.lic
```

Where *installation\_directory* specifies the directory in which you installed the component and *component\_name* specifies the abbreviation for the component.

For example, if you installed the server in the default directory, c:\Program Files\Tivoli\TSM, run the following command to register the license:

```
register license file=c:\Program Files\Tivoli\TSM\server\tsmbasic.lic
```

For example, if you installed IBM Spectrum Protect Extended Edition in the c:\Program Files\Tivoli\TSM directory, run the following command:

```
register license file=c:\Program Files\Tivoli\TSM\server\tsmee.lic
```

For example, if you installed IBM Spectrum Protect for Data Retention in the c:\Program Files\Tivoli\TSM directory, run the following command:

```
register license file=c:\Program Files\Tivoli\TSM\server\dataaret.lic
```

#### Restriction:

You cannot use the IBM Spectrum Protect server to register licenses for the following products:

- o IBM Spectrum Protect for Mail
- o IBM Spectrum Protect for Databases
- o IBM Spectrum Protect for ERP
- o IBM Spectrum Protect for Space Management

The REGISTER LICENSE command does not apply to these licenses. The licensing for these products is done by IBM Spectrum Protect clients.

## What to do next

---

If a device driver is available on Windows for the tape drives or medium changers that you plan to use, use the device driver. If a device driver is not available, install the IBM Spectrum Protect device driver by running the dpinst.exe /a command. The dpinst.exe file is in the device driver directory, and the default location is C:\Program Files\Tivoli\TSM\device\drivers.

#### Related reference:

BACKUP DB (Back up the database)

BACKUP DEVCONFIG (Create backup copies of device configuration information)

BACKUP VOLHISTORY (Save sequential volume history information)

REGISTER LICENSE (Register a new license)

Windows

## Upgrading IBM® Tivoli® Storage Manager V6.1 to IBM Spectrum Protect V8.1.2 in a clustered environment for Windows

---

To take advantage of new features, you can upgrade a server that is installed on a Windows operating system in a clustered environment from V6.1 to V8.1.2.

### Before you begin

---

Ensure that you retain the installation media from the V6.1 and V6.3 server base releases. If you obtained the server software from a downloaded package, ensure that the downloaded files are available. If the upgrade fails, and the server license module is uninstalled, the installation media from the server base release are required to reinstall the license.

### Procedure

---

1. If you plan to install the IBM Spectrum Protect™ V8.1.2 server on the Windows Server 2012 operating system, install the failover cluster automation server and the failover cluster command interface first. To install these components, issue the following commands from Windows 2.0 PowerShell:

```
Install-WindowsFeature -Name RSAT-Clustering-AutomationServer  
Install-WindowsFeature -Name RSAT-Clustering-CmdInterface
```

2. Back up the database by using the BACKUP DB command. The preferred method is to use a snapshot backup, which provides a full database backup without interrupting scheduled backups. For example, you can run the following command

to create a snapshot backup:

```
backup db type=dbsnapshot devclass=tapeclass
```

3. Back up the device configuration information to another directory. Run the following command:

```
backup devconfig filenames=file_name
```

Where *file\_name* specifies the name of the file in which to store device configuration information.

4. Back up the volume history file to another directory. Run the following command:

```
backup volhistory filenames=file_name
```

Where *file\_name* specifies the name of the file in which to store the volume history information.

5. Save a copy of the server options file, typically named `dsmserv.opt`, which is in the server instance directory.
6. Ensure that the resource group is on the primary node, and that all nodes in the cluster are running. Take the following actions on the primary node:
  - a. In the Failover Cluster Manager window, take the server resource offline and delete it:
    - i. Select Services and applications, and then select the cluster group. The server resource is displayed in the Other Resources section.
    - ii. Select the server resource, and click Take this resource offline.
    - iii. To delete the server resource, select it, and click Delete.
  - b. In the Failover Cluster Manager window, delete the network name and IP address:
    - i. In the Server name section, expand the network name to view the IP address. Note the network name and IP address.
    - ii. Select the network name and the IP address, and click Remove.
  - c. In the Failover Cluster Manager window, take the DB2® server resource offline:
    - i. Select Services and applications, and then select the cluster group. The IBM Spectrum Protect server resource is displayed in the Other Resources section.
    - ii. Select a DB2 server resource, for example, `SERVER1`, and click Take this resource offline.
7. On the primary node, to remove DB2 clustering from the instance, for each IBM Spectrum Protect instance in the cluster, issue the following command:

```
db2mcs -u:instancename
```

For example:

```
db2mcs -u:server1
```

Tip: You might see an error message about a missing cluster resource. Ignore this message.

8. On the primary node, in the Failover Cluster Manager window, in the resource group Summary section, verify that only the shared disks and any tape resources remain in the resource group.
9. On the primary node, install the V6.3 server by using the `install.exe` command. For detailed instructions about installing the V6.3 server, see *Installing the server components*.
10. On the primary node, install the IBM Spectrum Protect V8.1.2 server. For instructions, see *Installing the server components*. If you use the installation wizard to install the server, in the IBM Installation Manager window, click the Install icon. Do not click the Update or Modify icon.
11. On each secondary node, uninstall V6.1:
  - a. Change to the following directory:

```
C:\Program Files\Tivoli\TSM\_uninst
```

- b. Issue the following command:

```
Uninstall Tivoli Storage Manager.exe
```

12. On the primary node, start the configuration wizard by clicking Start > All Programs > IBM Spectrum Protect server > Configuration Wizard. Step through the configuration wizard:
  - a. When you are prompted to enter the instance name, enter the name of the instance that you are reclustered.
  - b. When you are prompted to enter the user ID, enter the name of the domain account that is associated with the cluster.
  - c. When you are prompted to indicate whether you want to recluster, click Yes.
  - d. Continue stepping through the wizard until you see a message that the configuration was successful.
13. Register the licenses for the IBM Spectrum Protect server components that are installed on your system by running the REGISTER LICENSE command:

```
register license file=installation_directory\server\component_name.lic
```

Where *installation\_directory* specifies the directory in which you installed the component and *component\_name* specifies the abbreviation for the component.

For example, if you installed the server in the default directory, c:\Program Files\Tivoli\TSM, run the following command to register the license:

```
register license file=c:\Program Files\Tivoli\TSM\server\tsmbasic.lic
```

For example, if you installed IBM Spectrum Protect Extended Edition in the c:\Program Files\Tivoli\TSM directory, run the following command:

```
register license file=c:\Program Files\Tivoli\TSM\server\tsmee.lic
```

For example, if you installed IBM Spectrum Protect for Data Retention in the c:\Program Files\Tivoli\TSM directory, run the following command:

```
register license file=c:\Program Files\Tivoli\TSM\server\dataaret.lic
```

#### Restriction:

You cannot use the IBM Spectrum Protect server to register licenses for the following products:

- o IBM Spectrum Protect for Mail
- o IBM Spectrum Protect for Databases
- o IBM Spectrum Protect for ERP
- o IBM Spectrum Protect for Space Management

The REGISTER LICENSE command does not apply to these licenses. The licensing for these products is done by IBM Spectrum Protect clients.

## What to do next

---

If a device driver is available on Windows for the tape drives or medium changers that you plan to use, use the device driver. If a device driver is not available, install the IBM Spectrum Protect device driver by running the dpinst.exe /a command. The dpinst.exe file is in the device driver directory, and the default location is C:\Program Files\Tivoli\TSM\device\drivers.

#### Related reference:

BACKUP DB (Back up the database)

BACKUP DEVCONFIG (Create backup copies of device configuration information)

BACKUP VOLHISTORY (Save sequential volume history information)

REGISTER LICENSE (Register a new license)

Windows

## Removing GSKit Version 7 after upgrading to IBM Spectrum Protect Version 8.1.2

---

The IBM Spectrum Protect™ installation wizard upgrades GSKit Version 8 and later. GSKit Version 7 is not removed or upgraded when you upgrade to IBM Spectrum Protect Version 8.1.2, even if GSKit was installed with an earlier version of IBM Spectrum Protect.

### About this task

---

If you no longer need GSKit V7 and want to free up space on your system, you can remove it after the upgrade to IBM Spectrum Protect V8.1.2.

Important: Removing GSKit V7 might affect other programs on your system that rely on it.

### Procedure

---

To remove GSKit V7, complete the following steps:

1. Back up your registry.
  - a. Click Start, and then click Run.
  - b. Type `Regedit`. Click OK.
  - c. To save a copy of your registry, select File > Export.
  - d. If you must later restore the registry, select File > Import.

For more information, see the Windows documentation.

2. Locate the directory where the GSKit is installed. The default directory is C:\Program Files\IBM\gsk7\.

3. Remove the GSKit installation directory, gsk7, and all subfiles and directories. Right-click the folder and click Delete.
4. Remove the GSKit 7 registry key and all subkeys and values.

Important: Removing the wrong key can cause system problems such as not being able to restart the workstation.

- a. Click Start, and then click Run.
- b. Type `Regedit`. Click OK.
- c. The GSKit registry key is in this directory: `HKEY_LOCAL_MACHINE\SOFTWARE\IBM`. Right-click the registry key, `HKEY_LOCAL_MACHINE\SOFTWARE\IBM\GSK7`, and click Delete.

AIX

Linux

Windows

## Installing and upgrading the Operations Center

The IBM Spectrum Protect™ Operations Center is the web-based interface for managing your storage environment.

### Before you begin

Before you install and configure the Operations Center, review the following information:

- System requirements for the Operations Center
  - Operations Center computer requirements
  - Hub and spoke server requirements
  - Operating system requirements
  - Web browser requirements
  - Language requirements
  - Requirements and limitations for IBM Spectrum Protect client management services
- Administrator IDs that the Operations Center requires
- IBM Installation Manager
- Installation checklist
- Obtaining the Operations Center installation package

### About this task

Table 1 lists the methods for installing or uninstalling the Operations Center and indicates where to find the associated instructions.

For information about upgrading the Operations Center, see [Upgrading the Operations Center](#).

Table 1. Methods for installing or uninstalling the Operations Center

Method	Instructions
Graphical wizard	<ul style="list-style-type: none"> <li>• Installing the Operations Center by using a graphical wizard</li> <li>• Uninstalling the Operations Center by using a graphical wizard</li> </ul>
Console mode	<ul style="list-style-type: none"> <li>• Installing the Operations Center in console mode</li> <li>• Uninstalling the Operations Center in console mode</li> </ul>
Silent mode	<ul style="list-style-type: none"> <li>• Installing the Operations Center in silent mode</li> <li>• Uninstalling the Operations Center in silent mode</li> </ul>

- Planning to install the Operations Center
 

Before you install the Operations Center, you must understand the system requirements, the administrator IDs that the Operations Center requires, and the information that you must provide to the installation program.
- Installing the Operations Center
 

You can install the Operations Center by using any of the following methods: a graphical wizard, the command line in console mode, or silent mode.
- Upgrading the Operations Center
 

You can upgrade the Operations Center by using any of the following methods: a graphical wizard, the command line in console mode, or silent mode.
- Getting started with the Operations Center
 

Before you can use the Operations Center to manage your storage environment, you must configure it.

- **AIX | Linux** Troubleshooting the Operations Center installation  
If a problem occurs with the Operations Center installation and you cannot solve it, you can consult the descriptions of known problems for a possible solution.
- Uninstalling the Operations Center  
You can uninstall the Operations Center by using any of the following methods: a graphical wizard, the command line in console mode, or silent mode.
- Rolling back to a previous version of the Operations Center  
By default, IBM Installation Manager saves earlier versions of a package to roll back to if you experience a problem with later versions of updates, fixes, or packages.

**AIX | Linux | Windows**

## Planning to install the Operations Center

---

Before you install the Operations Center, you must understand the system requirements, the administrator IDs that the Operations Center requires, and the information that you must provide to the installation program.

### About this task

---

From the Operations Center, you can manage the following primary aspects of the storage environment:

- IBM Spectrum Protect™ servers and clients
- Services such as backup and restore, archive and retrieve, and migrate and recall
- Storage pools and storage devices

The Operations Center includes the following features:

#### User interface for multiple servers

You can use the Operations Center to manage one or more IBM Spectrum Protect servers.

In an environment with multiple servers, you can designate one server as a *hub server* and the others as *spoke servers*. The hub server can receive alerts and status information from the spoke servers and present the information in a consolidated view in the Operations Center.

#### Alert monitoring

An *alert* is a notification of a relevant problem on the server and is triggered by a server message. You can define which server messages trigger alerts, and only those messages are reported as alerts in the Operations Center or in an email.

This alert monitoring can help you identify and track relevant problems on the server.

#### Convenient command-line interface

The Operations Center includes a command-line interface for advanced features and configuration.

- System requirements for the Operations Center  
Before you install the Operations Center, ensure that your system meets the minimum requirements.
- Administrator IDs that the Operations Center requires  
An administrator must have a valid ID and password on the hub server to log in to the Operations Center. An administrator ID is also assigned to the Operations Center so that the Operations Center can monitor servers.
- IBM Installation Manager  
The Operations Center uses IBM® Installation Manager, which is an installation program that can use remote or local software repositories to install or update many IBM products.
- Installation checklist  
Before you install the Operations Center, you must verify certain information, such as the installation credentials, and you must determine the input to provide to IBM Installation Manager for the installation.

**AIX | Linux | Windows**

## System requirements for the Operations Center

---

Before you install the Operations Center, ensure that your system meets the minimum requirements.

Use the Operations Center System Requirements Calculator to estimate the system requirements for running the Operations Center and the hub and spoke servers that are monitored by the Operations Center.

## Requirements that are verified during the installation

Table 1 lists the prerequisite requirements that are verified during the installation and indicates where to find more information about these requirements.

Table 1. Requirements that are verified during the installation

Requirement	Details
Minimum memory requirement	Operations Center computer requirements
Operating system requirement	Operating system requirements
Host name for the computer where the Operations Center will be installed	Installation checklist
Requirements for the Operations Center installation directory	Installation checklist

- Operations Center computer requirements  
You can install the Operations Center on a computer that is also running IBM Spectrum Protect server or on a different computer. If you install the Operations Center on the same computer as a server, that computer must meet the system requirements for both the Operations Center and the server.
- Hub and spoke server requirements  
When you open the Operations Center for the first time, you must associate the Operations Center with one IBM Spectrum Protect server that is designated as the *hub server*. In a multiple-server environment, you can connect the other servers, called *spoke servers*, to the hub server.
- Operating system requirements  
The Operations Center is available for AIX, Linux, and Windows systems.
- Web browser requirements  
The Operations Center can run in Apple, Google, Microsoft, and Mozilla web browsers.
- Language requirements  
By default, the Operations Center uses the language that the web browser uses. However, the installation process uses the language that the operating system uses. Verify that the web browser and the operating system are set to the language that you require.
- Requirements and limitations for IBM Spectrum Protect client management services  
IBM Spectrum Protect client management services is a component that you install on backup-archive clients to collect diagnostic information such as client log files. Before you install the client management service on your system, you must understand the requirements and limitations.

AIX | Linux | Windows

## Operations Center computer requirements

You can install the Operations Center on a computer that is also running IBM Spectrum Protect™ server or on a different computer. If you install the Operations Center on the same computer as a server, that computer must meet the system requirements for both the Operations Center and the server.

### Resource requirements

The following resources are required to run the Operations Center:

- One processor core
- 4 GB of memory
- 1 GB of disk space

The hub and spoke servers that are monitored by the Operations Center require additional resources, as described in Hub and spoke server requirements.

AIX | Linux | Windows

## Hub and spoke server requirements

When you open the Operations Center for the first time, you must associate the Operations Center with one IBM Spectrum Protect™ server that is designated as the *hub server*. In a multiple-server environment, you can connect the other servers, called *spoke servers*, to the hub server.



The spoke servers send alerts and status information to the hub server. The Operations Center shows you a consolidated view of alerts and status information for the hub server and any spoke servers.

If only one server is monitored by the Operations Center, that server is still called a hub server, even though no spoke servers are connected to it.

Table 1 indicates the version of IBM Spectrum Protect server that must be installed on the hub server and on each spoke server that is managed by the Operations Center.

Table 1. IBM Spectrum Protect server version requirements for hub and spoke servers

Operations Center	Version on the hub server	Version on each spoke server
V8.1.2	V8.1.2	V6.3.4 or later Restriction: Some Operations Center functions are not available for servers that use a version earlier than V8.1.2.

## Number of spoke servers that a hub server can support

The number of spoke servers that a hub server can support depends on the configuration and on the version of IBM Spectrum Protect on each spoke server. However, a general guideline is that a hub server can support 10 - 20 V6.3.4 spoke servers but can support more V7.1 or later spoke servers.

- Tips for designing the hub and spoke server configuration  
In designing the hub and spoke configuration, especially consider the resource requirements for status monitoring. Also, consider how you want to group hub and spoke servers and whether you want to use multiple hub servers.
- Tips for choosing a hub server  
For the hub server, you must choose a server that has adequate resources and is located for minimal roundtrip network latency.

AIX

Linux

Windows

## Tips for designing the hub and spoke server configuration

In designing the hub and spoke configuration, especially consider the resource requirements for status monitoring. Also, consider how you want to group hub and spoke servers and whether you want to use multiple hub servers.

Use the Operations Center System Requirements Calculator to estimate the system requirements for running the Operations Center and the hub and spoke servers that are monitored by the Operations Center.

## Primary factors that affect performance

The following factors have the most significant impact on the performance of the Operations Center:

- The processor and memory on the computer where the Operations Center is installed
- The system resources of the hub and spoke servers, including the disk system that is in use for the hub server database
- The number of client nodes and virtual machine file spaces that are managed by the hub and spoke servers
- The frequency at which data is refreshed in the Operations Center

## How to group hub and spoke servers

Consider grouping hub and spoke servers by geographic location. For example, managing the servers within the same data center can help prevent issues that are caused by firewalls or by inadequate network bandwidth between different locations. If necessary, you can further divide servers according to one or more of the following characteristics:

- The administrator who manages the servers
- The organizational entity that funds the servers
- Server operating system
- The language in which the servers run  
Tip: If the hub and spoke servers are not running in the same language, you might see corrupted text in the Operations Center.

## How to group hub and spoke servers in an enterprise configuration

In an enterprise configuration, a network of IBM Spectrum Protect™ servers are managed as a group. Changes that are made on the *configuration manager* can be distributed automatically to one or more *managed servers* in the network.

The Operations Center normally registers and maintains a dedicated administrator ID on the hub and spoke servers. This *monitoring administrator* must always have the same password on all the servers.

If you use an enterprise configuration, you can improve the process by which the administrator credentials are synchronized on spoke servers. To improve the performance and efficiency of maintaining the monitoring administrator ID, complete the following steps:

1. Designate the configuration manager server as the Operations Center hub server. During the hub server configuration, a monitoring administrator ID named `IBM-OC-hub_server_name` is registered.
2. On the hub server, add the monitoring administrator ID to a new or existing enterprise configuration profile. Issue the `NOTIFY SUBSCRIBERS` command to distribute the profile to the managed servers.
3. Add one or more of the managed servers as Operations Center spoke servers.

The Operations Center detects this configuration and allows the configuration manager to distribute and update the monitoring administrator ID on the spoke servers.

## When to use multiple hub servers

---

If you have more than 10 - 20 V6.3.4 spoke servers, or if resource limitations require the environment to be partitioned, you can configure multiple hub servers, and connect a subset of the spoke servers to each hub server.

Restrictions:

- A single server cannot be both a hub server and a spoke server.
- Each spoke server can be assigned to only one hub server.
- Each hub server requires a separate instance of the Operations Center, each of which has a separate web address.

AIX

Linux

Windows

## Tips for choosing a hub server

---

For the hub server, you must choose a server that has adequate resources and is located for minimal roundtrip network latency.

Attention: Do not use the same server as the hub server for multiple Operations Centers.

Use the following guidelines in deciding which server to designate as the hub server:

Choose a lightly loaded server

Consider a server that has a light load for operations such as client backup and archive. A lightly loaded server is also a good choice as the host system for the Operations Center.

Ensure that the server has the resources to handle both its typical server workload and the estimated workload for acting as the hub server.

Locate the server for minimal roundtrip network latency

Locate the hub server so that the network connection between the hub server and the spoke servers has a roundtrip latency that is no greater than 5 ms. This latency can typically be achieved when the servers are on the same local area network (LAN).

Networks that are poorly tuned, are heavily used by other applications, or have roundtrip latency much higher than 5 ms can degrade communications between the hub and spoke servers. For example, roundtrip latencies of 50 ms or higher can result in communication timeouts that cause spoke servers to disconnect or reconnect to the Operations Center. Such high latencies might be experienced in long-distance, wide area network (WAN) communications.

If spoke servers are a long distance from the hub server and experience frequent disconnects in the Operations Center, you can increase the value of the `ADMINCOMMTIMEOUT` option on each server to reduce the problem.

Verify that the hub server meets the resource requirements for status monitoring

Status monitoring requires extra resources on each server on which it is enabled. The resources that are required depend primarily on the number of clients that are managed by the hub and spoke servers. Fewer resources are used on a hub server with a V7.1 or later spoke server than on a hub server with a V6.3.4 spoke server.

Verify that the hub server meets the resource requirements for processor usage, database space, archive log space, and I/O operations per second (IOPS) capacity.

A hub server with high IOPS capacity can handle a larger amount of incoming status data from spoke servers. Use of the following storage devices for the hub server database can help meet this capacity:

- An enterprise-level solid-state drive (SSD)
- An external SAN disk storage device with multiple volumes or multiple spindles under each volume

In an environment with fewer than 1000 clients, consider establishing a baseline capacity of 1000 IOPS for the hub server database if the hub server manages any spoke servers.

Determine whether your environment requires multiple hub servers

If more than 10,000 - 20,000 client nodes and virtual machine file spaces are managed by one set of hub and spoke servers, the resource requirements might exceed what the hub server has available, especially if the spoke servers are V6.3.4 servers. Consider designating a second server as a hub server and moving spoke servers to the new hub server to balance the load.

AIX | Linux | Windows

## Operating system requirements

---

The Operations Center is available for AIX®, Linux, and Windows systems.

You can run the Operations Center on the following systems:

- **AIX** AIX systems:
  - IBM® AIX V7.1 (64 bit) TL 4 and SP 2
  - IBM AIX V7.2 (64 bit) TL 0 and SP 2
- **Linux** Linux on x86\_64 systems:
  - Red Hat Enterprise Linux 6.7
  - Red Hat Enterprise Linux 7.1
  - SUSE Linux Enterprise Server 11, Service Pack 4 or later
  - SUSE Linux Enterprise Server 12
- **Linux** Linux on System z (s390x 64-bit architecture) systems:
  - Red Hat Enterprise Linux 7.1
  - SUSE Linux Enterprise Server 12
- **Linux** Linux on Power Systems (little endian) systems:
  - Red Hat Enterprise Linux 7 with the PPC64LE architecture
- **Windows** Windows systems:
  - Microsoft Windows Server 2012: Standard, Enterprise, or Datacenter Edition (64-bit)
  - Microsoft Windows Server 2012 R2 (64-bit)
  - Microsoft Windows Server 2016

For the most up-to-date requirements information, see Software and Hardware Requirements.

AIX | Linux | Windows

## Web browser requirements

---

The Operations Center can run in Apple, Google, Microsoft, and Mozilla web browsers.

For optimal viewing of the Operations Center in the web browser, ensure that the screen resolution for the system is set to a minimum of 1024 X 768 pixels.

For optimal performance, use a web browser that has good JavaScript performance, and enable browser caching.

The Operations Center can run in the following web browsers:

- Apple Safari on the iPad  
Restriction: If Apple Safari is running on iOS 8.x or iOS 9.x, you cannot use a self-signed certificate for secure communication with the Operations Center without extra configuration of the certificate. Use a certificate authority (CA) certificate, or configure the self-signed certificate as needed. For instructions, see Technote <http://www.ibm.com/support/docview.wss?uid=swg21963153>.
- Google Chrome 40 or later
- Microsoft Internet Explorer 11 or later
- Mozilla Firefox ESR 31 or later

To run the Operations Center in compliance with the National Institute of Standards and Technology (NIST) Special Publications (SP) 800-131A recommendation, communication between the Operations Center and the web browser must be secured by using the Transport Layer Security (TLS) 1.2 protocol. During installation, you specify whether SP 800-131A compliance is required and the level of compliance. If strict SP 800-131A compliance is specified during installation, the web browser must support TLS 1.2, and TLS 1.2 must be enabled.

The web browser displays an SSL error if strict SP 800-131A compliance is specified during installation, and the web browser does not meet the preceding requirements.

AIX Linux Windows

## Language requirements

By default, the Operations Center uses the language that the web browser uses. However, the installation process uses the language that the operating system uses. Verify that the web browser and the operating system are set to the language that you require.

AIX

Table 1. Operations Center language values that you can use on AIX® systems

Language	Language option value
Chinese, Simplified	zh_CN
Chinese, Simplified (UTF-8)	ZH_CN
Chinese, Traditional (Big5)	Zh_TW
Chinese, Traditional (UTF-8)	ZH_TW
Chinese, Traditional (euc_tw)	zh_TW
English	en_US
English (UTF-8)	EN_US
French	fr_FR
French (UTF-8)	FR_FR
German	de_DE
German (UTF-8)	DE_DE
Italian	it_IT
Italian (UTF-8)	IT_IT
Japanese (EUC)	ja_JP
Japanese (PC)	Ja_JP
Japanese (UTF-8)	JA_JP
Korean	ko_KR
Korean (UTF-8)	KO_KR
Portuguese, Brazilian	pt_BR
Portuguese, Brazilian (UTF-8)	PT_BR
Russian	ru_RU
Russian (UTF-8)	RU_RU
Spanish	es_ES
Spanish (UTF-8)	ES_ES

Linux

Table 2. Operations Center language values that you can use on Linux systems

Language	Language option value
----------	-----------------------

Language	Language option value
Chinese, Simplified	zh_CN
Chinese, Simplified (GBK)	zh_CN.gb18030
Chinese, Simplified (UTF-8)	zh_CN.utf8
Chinese, Traditional (Big5)	Zh_TW
Chinese, Traditional (euc_tw)	zh_TW
Chinese, Traditional (UTF-8)	zh_TW.utf8
English, United States	en_US
English (UTF-8)	en_US.utf8
French	fr_FR
French (UTF-8)	fr_FR.utf8
German	de_DE
German (UTF-8)	de_DE.utf8
Italian	it_IT
Italian (UTF-8)	it_IT.utf8
Japanese (EUC)	ja_JP
Japanese (UTF-8)	ja_JP.utf8
Korean	ko_KR
Korean (UTF-8)	ko_KR.utf8
Portuguese, Brazilian	pt_BR
Portuguese, Brazilian (UTF-8)	pt_BR.utf8
Russian	ru_RU
Russian (UTF-8)	ru_RU.utf8
Spanish	es_ES
Spanish (UTF-8)	es_ES.utf8

Windows

Table 3. Operations Center language values that you can use on Windows systems

Language	Language option value
Chinese, Simplified	chs
Chinese, Traditional	cht
English	ameng
French	fra
German	deu
Italian	ita
Japanese (Shift-JIS)	jpn
Korean	kor
Portuguese, Brazilian	ptb
Russian	rus
Spanish	esp

AIX

Linux

Windows

# Requirements and limitations for IBM Spectrum Protect client management services

---

IBM Spectrum Protect™ client management services is a component that you install on backup-archive clients to collect diagnostic information such as client log files. Before you install the client management service on your system, you must understand the requirements and limitations.

In the documentation for the client management service, *client system* is the system where the backup-archive client is installed.

Diagnostic information can be collected only from Linux and Windows clients, but administrators can view the diagnostic information in the Operations Center on AIX®, Linux, or Windows operating systems.

## Requirements for the client management service

---

Verify the following requirements before you install the client management service:

- To remotely access the client, the Operations Center administrator must have system authority or one of the following client authority levels:
  - Policy authority
  - Client owner authority
  - Client node access authority
- Ensure that the client system meets the following requirements:
  - The client management service can be installed only on client systems that run on Linux or Windows operating systems:
    - Linux x86 64-bit operating systems that are supported for the backup-archive client.
    - Windows 32-bit and 64-bit operating systems that are supported for the backup-archive client.
  - Transport Layer Security (TLS) 1.2 must be installed for transmission of data between the client management service and Operations Center. Basic authentication is provided and data and authentication information are encrypted through the SSL channel. TLS 1.2 is automatically installed along with the necessary SSL certificates when you install the client management service.
- On Linux client systems, you must have root user authority to install the client management service.
- For client systems that can have multiple client nodes, such as Linux client systems, ensure that each node name is unique on the client system.

Tip: After you install the client management service, you do not have to install it again because the service can discover multiple client options files.

## Limitations of the client management service

---

The client management service provides basic services for collecting diagnostic information from backup-archive clients. The following limitations exist for the client management service:

- You can install the client management service only on systems with backup-archive clients, including backup-archive clients that are installed on data mover nodes for IBM Spectrum Protect for Virtual Environments: Data Protection for VMware.
- You cannot install the client management service on other IBM Spectrum Protect client components or products that do not have backup-archive clients.
- If the backup-archive clients are protected by a firewall, ensure that the Operations Center can connect to the backup-archive clients through the firewall by using the configured port for the client management service. The default port is 9028, but it can be changed.
- The client management service scans all client log files to locate entries for the previous 72-hour period.
- The Diagnosis page in the Operations Center provides basic troubleshooting information for backup-archive clients. However, for some backup issues, you might have to access the client system and obtain further diagnostic information.
- If the combined size of the client error log files and schedule log files on a client system is more than 500 MB, delays can occur in sending log records to the Operations Center. You can control the size of the log files by enabling log file pruning or wrapping by specifying the `errorlogretention` or `errorlogmax` client option.
- If you use the same client node name to connect to multiple IBM Spectrum Protect servers that are installed on the same server, you can view log files for only one of the client nodes.

For updates about the client management service, including requirements, limitations, and documentation updates, see technote 1963610.

**Related tasks:**

Collecting diagnostic information with IBM Spectrum Protect client management services

[AIX](#)[Linux](#)[Windows](#)

## Administrator IDs that the Operations Center requires

---

An administrator must have a valid ID and password on the hub server to log in to the Operations Center. An administrator ID is also assigned to the Operations Center so that the Operations Center can monitor servers.

The Operations Center requires the following IBM Spectrum Protect™ administrator IDs:

Administrator IDs that are registered on the hub server

Any administrator ID that is registered on the hub server can be used to log in to the Operations Center. The authority level of the ID determines which tasks can be completed. You can create new administrator IDs by using the REGISTER ADMIN command.

Restriction: To use an administrator ID in a multiple-server configuration, the ID must be registered on the hub and spoke servers with the same password and authority level.

To manage authentication for these servers, consider using one of the following methods:

- A Lightweight Directory Access Protocol (LDAP) server
- The enterprise configuration functions to automatically distribute changes to the administrator definitions.

Monitoring administrator ID

When you initially configure the hub server, an administrator ID named IBM-OC-*server\_name* is registered with system authority on the hub server and is associated with the initial password that you specify. This ID, which is sometimes called the *monitoring administrator*, is intended for use only by the Operations Center.

Do not delete, lock, or modify this ID. The same administrator ID with the same password is registered on the spoke servers that you add. The password is automatically changed on the hub and spoke servers every 90 days. You do not need to use or manage this password.

Restriction: The Operations Center maintains the monitoring administrator ID and password on spoke servers unless you use an enterprise configuration to manage these credentials. For more information about using an enterprise configuration to manage the credentials, see Tips for designing the hub and spoke server configuration.

**Related reference:**

REGISTER ADMIN (Register an administrator ID)

[AIX](#)[Linux](#)[Windows](#)

## IBM Installation Manager

---

The Operations Center uses IBM® Installation Manager, which is an installation program that can use remote or local software repositories to install or update many IBM products.

If the required version of IBM Installation Manager is not already installed, it is automatically installed or upgraded when you install the Operations Center. It must remain installed on the system so that the Operations Center can be updated or uninstalled later as needed.

The following list contains explanations of some terms that are used in IBM Installation Manager:

Offering

An installable unit of a software product.

The Operations Center offering contains all of the media that IBM Installation Manager requires to install the Operations Center.

Package

The group of software components that are required to install an offering.

The Operations Center package contains the following components:

- IBM Installation Manager installation program
- Operations Center offering

Package group

A set of packages that share a common parent directory.

Repository

A remote or local storage area for data and other application resources.

The Operations Center package is stored in a repository on IBM Fix Central.

Shared resources directory

A directory that contains software files or plug-ins that are shared by packages.

IBM Installation Manager stores installation-related files in the shared resources directory, including files that are used for rolling back to a previous version of the Operations Center.

AIX | Linux | Windows

## Installation checklist

Before you install the Operations Center, you must verify certain information, such as the installation credentials, and you must determine the input to provide to IBM® Installation Manager for the installation.

The following checklist highlights the information that you must verify or determine before you install the Operations Center, and Table 1 describes the details of this information:

- Verify the host name for the computer where the Operations Center is to be installed.
- Verify the installation credentials.
- Determine the Operations Center installation directory, if you do not want to accept the default path.
- Determine the IBM Installation Manager installation directory, if you do not want to accept the default path.
- Determine the port number to be used by the Operations Center web server, if you do not want to accept the default port number.
- Determine the password for secure communications.
- Determine whether secure communications must comply with the National Institute of Standards and Technology (NIST) Special Publications (SP) 800-131A recommendation.

Table 1. Information to verify or determine before you install the Operations Center

Information	Details
Host name for the computer where the Operations Center is to be installed.	The host name must meet the following criteria: <ul style="list-style-type: none"><li>• It must not contain double-byte character set (DBCS) characters or the underscore character (_).</li><li>• Although the host name can contain the hyphen character (-), it cannot have a hyphen as the last character in the name.</li></ul>
Installation credentials	To install the Operations Center, you must use the following user account: <ul style="list-style-type: none"><li>• <b>AIX</b>   <b>Linux</b> The root user</li><li>• <b>Windows</b> Administrator</li></ul>



Information	Details
<p>Operations Center installation directory</p>	<p>The Operations Center is installed in the ui subdirectory of the installation directory.</p> <p>The following path is the default path for the Operations Center installation directory:</p> <ul style="list-style-type: none"> <li> <span style="background-color: #e91e63; color: white; padding: 2px;">AIX</span>   <span style="background-color: #e91e63; color: white; padding: 2px;">Linux</span> /opt/tivoli/tsm            For example, if you use this default path, the Operations Center is installed in the following directory:  <pre> /opt/tivoli/tsm/ui </pre> </li> <li> <span style="background-color: #e91e63; color: white; padding: 2px;">Windows</span> c:\Program Files\Tivoli\TSM            For example, if you use this default path, the Operations Center is installed in the following directory:  <pre> c:\Program Files\Tivoli\TSM\ui </pre> </li> </ul> <p>The installation directory path must meet the following criteria:</p> <ul style="list-style-type: none"> <li>The path must contain no more than 128 characters.</li> <li>The path must include only ASCII characters.</li> <li>The path cannot include non-displayable control characters.</li> <li>The path cannot include any of the following characters:  <pre> %   &lt; &gt; ' " \$ &amp; ; * </pre> </li> </ul>
<p>IBM Installation Manager installation directory</p>	<p>The following path is the default path for the IBM Installation Manager installation directory:</p> <ul style="list-style-type: none"> <li> <span style="background-color: #e91e63; color: white; padding: 2px;">AIX</span>   <span style="background-color: #e91e63; color: white; padding: 2px;">Linux</span> /opt/IBM/InstallationManager </li> <li> <span style="background-color: #e91e63; color: white; padding: 2px;">Windows</span> C:\Program Files\IBM\Installation Manager </li> </ul>
<p>Port number that is used by the Operations Center web server.</p>	<p>The value for the secure (https) port number must meet the following criteria:</p> <ul style="list-style-type: none"> <li>The number must be an integer in the range 1024 - 65535.</li> <li>The number cannot be in use or allocated to other programs.</li> </ul> <p>If you do not specify a port number, the default value is 11090.</p> <p>Tip: If you later do not remember the port number that you specified, refer to the following file, where <i>installation_dir</i> represents the directory where the Operations Center is installed:</p> <ul style="list-style-type: none"> <li> <span style="background-color: #e91e63; color: white; padding: 2px;">AIX</span>   <span style="background-color: #e91e63; color: white; padding: 2px;">Linux</span>  <i>installation_dir</i>/ui/Liberty/usr/servers/guiServer/bootstrap.properties </li> <li> <span style="background-color: #e91e63; color: white; padding: 2px;">Windows</span> <i>installation_dir</i>\ui\Liberty\usr\servers\guiServer\bootstrap.properties </li> </ul> <p>The bootstrap.properties file contains the IBM Spectrum Protect™ server connection information.</p>

Information	Details
Password for secure communications	<p>The Operations Center uses Hypertext Transfer Protocol Secure (HTTPS) to communicate with web browsers.</p> <p>The Operations Center requires secure communication between the server and the Operations Center. To secure communication, you must add the Transport Layer Security (TLS) certificate of the hub server to the truststore file of the Operations Center.</p> <p>The truststore file of the Operations Center contains the certificate that the Operations Center uses for HTTPS communication with web browsers. During installation of the Operations Center, you create a password for the truststore file. When you set up secure communication between the Operations Center and the hub server, you must use the same password to add the certificate of the hub server to the truststore file.</p> <p>The password for the truststore file must meet the following criteria:</p> <ul style="list-style-type: none"> <li>• The password must contain a minimum of 6 characters and a maximum of 64 characters.</li> <li>• The password must contain at least the following characters: <ul style="list-style-type: none"> <li>◦ One uppercase letter (A – Z)</li> <li>◦ One lowercase letter (a – z)</li> <li>◦ One digit (0 – 9)</li> <li>◦ Two of the non-alphanumeric characters that are listed in the following series: <pre> ~ ! @ # \$ % ^ &amp; * _ - + = `   ( ) { } [ ] : ; &lt; &gt; , . ? / </pre> </li> </ul> </li> </ul>

**Related tasks:**

Configuring for secure communication

Resetting the password for the Operations Center truststore file

AIX Linux Windows

## Installing the Operations Center

You can install the Operations Center by using any of the following methods: a graphical wizard, the command line in console mode, or silent mode.

### Before you begin

You cannot configure the Operations Center until you install, configure, and start the IBM Spectrum Protect™ server. Therefore, before you install the Operations Center, install the appropriate server package, according to the server version requirements in Hub and spoke server requirements.

You can install the Operations Center on a computer with the IBM Spectrum Protect server or on a separate computer.

- Obtaining the Operations Center installation package  
You can obtain the installation package from an IBM® download site such as IBM Passport Advantage® or IBM Fix Central.
- Installing the Operations Center by using a graphical wizard  
You can install or update the Operations Center by using the graphical wizard of IBM Installation Manager.
- Installing the Operations Center in console mode  
You can install or update the Operations Center by using the command line in console mode.
- Installing the Operations Center in silent mode  
You can install or upgrade the Operations Center in silent mode. In silent mode, the installation does not send messages to a console but instead stores messages and errors in log files.

AIX Linux Windows

## Obtaining the Operations Center installation package

You can obtain the installation package from an IBM® download site such as IBM Passport Advantage® or IBM Fix Central.

## About this task

---

After you obtain the package from an IBM download site, you must extract the installation files.

## Procedure

---

Complete the following steps to extract the Operations Center installation files. In the following steps, replace *version\_number* with the version of Operations Center that you are installing.

**AIX** On AIX® systems:

- a. Download the following package file to the directory of your choice:

```
version_number.000  
-IBM-SPOC-AIX.bin
```

- b. Ensure that you have executable permission for the package file.  
If necessary, change the file permissions by issuing the following command:

```
chmod a+x version_number.000-IBM-SPOC-AIX.bin
```

- c. Issue the following command to extract the installation files:

```
./version_number.000-IBM-SPOC-AIX.bin
```

The self-extracting package file is extracted to the directory.

**Linux** On Linux systems:

- a. Download one of the following package files to the directory of your choice:

- o *version\_number.000-IBM-SPOC-LinuxS390.bin*
- o *version\_number.000-IBM-SPOC-Linuxx86\_64.bin*

- b. Ensure that you have executable permission for the package file.  
If necessary, change the file permissions by issuing the following command:

```
chmod a+x package_name.bin
```

- c. Issue the following command to extract the installation files:

```
./package_name.bin
```

The self-extracting package file is extracted to the directory.

**Windows** On Windows systems:

- a. Download the following package file to the directory of your choice:

```
version_number.000-IBM-SPOC-WindowsX64.exe
```

- b. In Windows Explorer, double-click the file name to extract the installation files.

The self-extracting package file is extracted to the directory.

**AIX** | **Linux** | **Windows**

## Installing the Operations Center by using a graphical wizard

---

You can install or update the Operations Center by using the graphical wizard of IBM® Installation Manager.

**AIX**

### Before you begin

---

If the following RPM files are not installed on the computer, install them. For instructions, see Installing RPM files for the graphical wizard.

- atk-1.12.3-2.aix5.2.ppc.rpm
- cairo-1.8.8-1.aix5.2.ppc.rpm
- expat-2.0.1-1.aix5.2.ppc.rpm

- fontconfig-2.4.2-1.aix5.2.ppc.rpm
- freetype2-2.3.9-1.aix5.2.ppc.rpm
- gettext-0.10.40-6.aix5.1.ppc.rpm
- glib2-2.12.4-2.aix5.2.ppc.rpm
- gtk2-2.10.6-4.aix5.2.ppc.rpm
- libjpeg-6b-6.aix5.1.ppc.rpm
- libpng-1.2.32-2.aix5.2.ppc.rpm
- libtiff-3.8.2-1.aix5.2.ppc.rpm
- pango-1.14.5-4.aix5.2.ppc.rpm
- pixman-0.12.0-3.aix5.2.ppc.rpm
- xcursor-1.1.7-3.aix5.2.ppc.rpm
- xft-2.1.6-5.aix5.1.ppc.rpm
- xrender-0.9.1-3.aix5.2.ppc.rpm
- zlib-1.2.3-3.aix5.1.ppc.rpm

## Procedure

---

1. From the directory where the Operations Center installation package file is extracted, issue the following command:
  - **AIX** | **Linux** `./install.sh`
  - **Windows** `install.bat`
2. Follow the wizard instructions to install the IBM Installation Manager and Operations Center packages.
 

**AIX** The following message might be displayed, and the installation wizard might be slow, if your locale uses UTF-8 encoding:

```
Cannot create font set
```

If the message is displayed, take one of the following actions:

- Change to a locale that does not use UTF-8 encoding. For language-option values that do not use UTF-8 encoding, see Language requirements.
- Install the Operations Center by using the command line in console mode.
- Install the Operations Center in silent mode.

## What to do next

---

See Configuring the Operations Center.

- **AIX** Installing RPM files for the graphical wizard  
Before you can use the graphical wizard of IBM Installation Manager to install the Operations Center, certain RPM files must be installed.

**AIX** | **Linux** | **Windows**

## Installing the Operations Center in console mode

---

You can install or update the Operations Center by using the command line in console mode.

## Procedure

---

1. From the directory where the installation package file is extracted, run the following program:
 

**AIX** | **Linux**

```
./install.sh -c
```

**Windows**

```
install.bat -c
```
2. Follow the console instructions to install the Installation Manager and Operations Center packages.

## What to do next

---

See Configuring the Operations Center.

**AIX** | **Linux** | **Windows**

# Installing the Operations Center in silent mode

---

You can install or upgrade the Operations Center in silent mode. In silent mode, the installation does not send messages to a console but instead stores messages and errors in log files.

## Before you begin

---

To provide data input when you use the silent installation method, you can use a response file. The following sample response files are provided in the input directory where the installation package is extracted:

install\_response\_sample.xml

Use this file to install the Operations Center.

update\_response\_sample.xml

Use this file to upgrade the Operations Center.

These files contain default values that can help you avoid any unnecessary warnings. To use these files, follow the instructions that are provided in the files.

If you want to customize a response file, you can modify the options that are in the file. For information about response files, see [Response files](#).

## Procedure

---

1. Create a response file. You can modify the sample response file or create your own file.

Tip: To generate a response file as part of a console-mode installation, complete the selection of the console-mode installation options. Then, in the Summary panel, enter **G** to generate the response file according to the previously selected options.

2. Create a password for the Operations Center truststore in the response file.

If you are using the `install_response_sample.xml` file, add the password in the following line of the file, where *mypassword* represents the password:

```
<variable name='ssl.password' value='mypassword' />
```

For more information about this password, see [Installation checklist](#).

Tip: To upgrade the Operations Center, the truststore password is not required if you are using the `update_response_sample.xml` file.

3. Start the silent installation by issuing the following command from the directory where the installation package is extracted. The value *response\_file* represents the response file path and file name:

- o **AIX** | **Linux**  

```
./install.sh -s -input response_file -acceptLicense
```
- o **Windows**  

```
install.bat -s -input response_file -acceptLicense
```

## What to do next

---

See [Configuring the Operations Center](#).

**AIX** | **Linux** | **Windows**

# Upgrading the Operations Center

---

You can upgrade the Operations Center by using any of the following methods: a graphical wizard, the command line in console mode, or silent mode.

## Before you begin

---

Before you upgrade the Operations Center, review the system requirements and the installation checklist. The new version of the Operations Center might have more or different requirements and considerations than the version you are currently using.

## About this task

---

The instructions for upgrading the Operations Center are the same as the instructions for installing the Operations Center, with the following exceptions:

- You use the Update function of IBM® Installation Manager rather than the Install function.  
Tip: In IBM Installation Manager, the term *update* means to discover and install updates and fixes to installed software packages. In this context, *update* and *upgrade* are synonymous.
- If you are upgrading the Operations Center in silent mode, you can skip the step of creating a password for the truststore file.

AIX

Linux

Windows

## Getting started with the Operations Center

Before you can use the Operations Center to manage your storage environment, you must configure it.

### About this task

After you install the Operations Center, complete the following basic configuration steps:

1. Designate the hub server.
2. Add any spoke servers.
3. Optionally, configure email alerts on the hub and spoke servers.

Figure 1 illustrates an Operations Center configuration.

Figure 1. Example of an Operations Center configuration with the hub and spoke servers

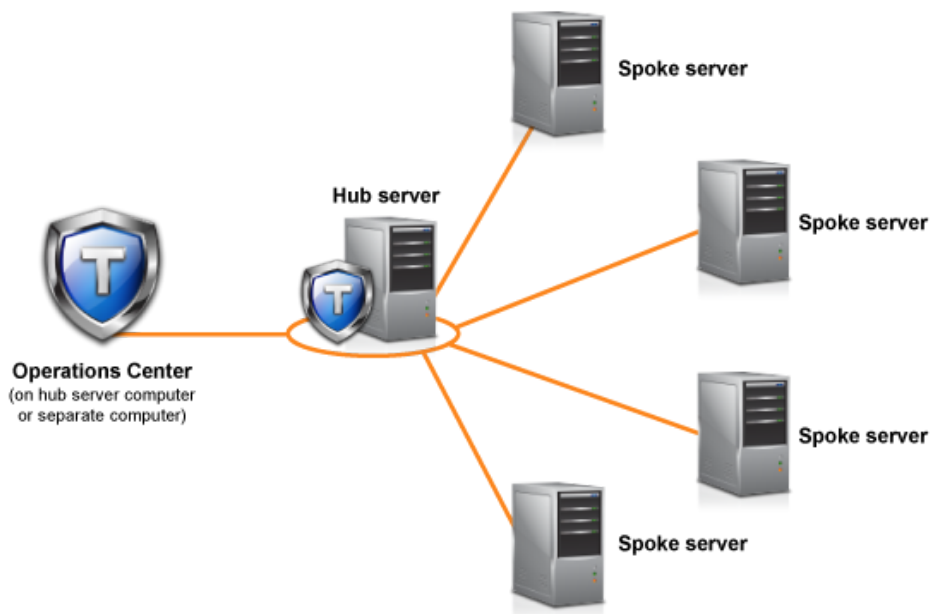

- **Configuring the Operations Center**  
When you open the Operations Center for the first time, you must configure it to manage your storage environment. You must associate the Operations Center with the IBM Spectrum Protect server that is designated as the hub server. You can then connect additional IBM Spectrum Protect servers as spoke servers.
- **Configuring for secure communication**  
The Operations Center uses Hypertext Transfer Protocol Secure (HTTPS) to communicate with web browsers. The Transport Layer Security (TLS) protocol secures communications between the Operations Center and the hub server, and between the hub server and associated spoke servers.
- **Starting and stopping the web server**  
The web server of the Operations Center runs as a service and starts automatically. You might need to stop and start the web server, for example, to make configuration changes.
- **Opening the Operations Center**  
The Overview page is the default initial view in the Operations Center. However, in your web browser, you can bookmark the page that you want to open when you log in to the Operations Center.
- **Collecting diagnostic information with IBM Spectrum Protect client management services**  
The client management service collects diagnostic information about backup-archive clients and makes the information

available to the Operations Center for basic monitoring capability.

AIX Linux Windows

## Configuring the Operations Center

---

When you open the Operations Center for the first time, you must configure it to manage your storage environment. You must associate the Operations Center with the IBM Spectrum Protect™ server that is designated as the hub server. You can then connect additional IBM Spectrum Protect servers as spoke servers.

- Designating the hub server  
When you connect to the Operations Center for the first time, you must designate which IBM Spectrum Protect server is the hub server.
- Adding a spoke server  
After you configure the hub server for the Operations Center, you can add one or more spoke servers to the hub server.
- Sending email alerts to administrators  
An alert is a notification of a relevant problem on the IBM Spectrum Protect server and is triggered by a server message. Alerts can be shown in the Operations Center and can be sent from the server to administrators by email.
- Adding customized text to the login screen  
You can add customized text, such as your organization's Terms of Use of the software, to the login screen of the Operations Center so that users of the Operations Center see the text before they enter their user name and password.
- Enabling REST services  
Applications that use Representational State Transfer (REST) services can query and manage the storage environment by connecting to the Operations Center.

AIX Linux Windows

## Designating the hub server

---

When you connect to the Operations Center for the first time, you must designate which IBM Spectrum Protect™ server is the hub server.

### Before you begin

---

The Operations Center requires secure communication between the hub server and the Operations Center. To secure communication, you must add the Transport Layer Security (TLS) certificate of the hub server to the truststore file of the Operations Center. For more information, see [Securing communication between the Operations Center and the hub server](#).

### Procedure

---

In a web browser, enter the following address, where *hostname* represents the name of the computer where the Operations Center is installed, and *secure\_port* represents the port number that the Operations Center uses for HTTPS communication on that computer:

```
https://hostname:secure_port/oc
```

Tips:

- The URL is case-sensitive. For example, ensure that you type "oc" in lowercase as indicated.
- For more information about the port number, see the Installation checklist.
- If you are connecting to the Operations Center for the first time, you must provide the following information:
  - Connection information for the server that you want to designate as a hub server
  - Login credentials for an administrator ID that is defined for that server
- If the event-record retention period of the server is less than 14 days, the period is automatically reset to 14 days if you configure the server as a hub server.

### What to do next

---

If you have multiple IBM Spectrum Protect servers in your environment, add the other servers as spoke servers to the hub server.

Attention: Do not change the name of a server after it is configured as a hub or spoke server.

**Related concepts:**

## Adding a spoke server

---

After you configure the hub server for the Operations Center, you can add one or more spoke servers to the hub server.

### Before you begin

---

Communication between the spoke server and the hub server must be secured by using the Transport Layer Security (TLS) protocol. To secure communication, add the certificate of the spoke server to the truststore file of the hub server.

### Procedure

---

1. In the Operations Center menu bar, click Servers. The Servers page opens.

In the table on the Servers page, a server might have a status of "Unmonitored." This status means that although an administrator defined this server to the hub server by using the DEFINE SERVER command, the server is not yet configured as a spoke server.

2. Complete one of the following steps:
  - o Click the server to highlight it, and in the table menu bar, click Monitor Spoke.
  - o If the server that you want to add is not shown in the table, and secure SSL/TLS communication is not required, click + Spoke in the table menu bar.
3. Provide the necessary information, and complete the steps in the spoke configuration wizard.  
Tip: If the event-record retention period of the server is less than 14 days, the period is automatically reset to 14 days if you configure the server as a spoke server.

#### Related reference:

DEFINE SERVER (Define a server for server-to-server communications)

AIX Linux Windows

## Sending email alerts to administrators

---

An alert is a notification of a relevant problem on the IBM Spectrum Protect™ server and is triggered by a server message. Alerts can be shown in the Operations Center and can be sent from the server to administrators by email.

### Before you begin

---

Before you configure email notification for administrators about alerts, ensure that the following requirements are met:

- An SMTP server is required to send and receive alerts by email, and the server that sends the alerts by email must have access to the SMTP server.  
Tip: If the Operations Center is installed on a separate computer, that computer does not need access to the SMTP server.
- An administrator must have system privilege to configure email notification.

### About this task

---

An email notification is sent only for the first occurrence of an alert. Also, if an alert is generated before you configure email notification, no email notification is sent for that alert.

You can configure email notification in the following ways:

- Send notification for individual alerts
- Send alert summaries

An alert summary contains information about current alerts. The summary includes the total number of alerts, the total number of active and inactive alerts, the oldest alert, the newest alert, and the most frequently occurring alert.

You can specify a maximum of three administrators to receive alert summaries by email. Alert summaries are sent approximately every hour.



## Procedure

---

To configure email notification for administrators about alerts, complete the following steps on each hub and spoke server from which you want to receive email alerts:

1. To verify that alert monitoring is turned on, issue the following command:

```
QUERY MONITORSETTINGS
```

2. If the command output indicates that alert monitoring is turned off, issue the following command. Otherwise, proceed to the next step.

```
SET ALERTMONITOR ON
```

3. To enable the sending of email notification, issue the following command:

```
SET ALERTEMAIL ON
```

4. To define the SMTP server that is used to send email notification, issue the following command:

```
SET ALERTEMAILSMTPHOST host_name
```

5. To specify the port number for the SMTP server, issue the following command:

```
SET ALERTEMAILSMTPPORT port_number
```

The default port number is 25.

6. To specify the email address of the sender of the alerts, issue the following command:

```
SET ALERTEMAILFROMADDR email_address
```

7. For each administrator ID that must receive email notification, issue one of the following commands to activate email notification and to specify the email address:

```
REGISTER ADMIN admin_name ALERT=YES EMAILADDRESS=email_address
```

```
UPDATE ADMIN admin_name ALERT=YES EMAILADDRESS=email_address
```

8. Choose either, or both, of the following options, and specify the administrator IDs to receive email notification:

- o Send notification for individual alerts

To specify or update the administrator IDs to receive email notification for an individual alert, issue one of the following commands:

```
DEFINE ALERTTRIGGER message_number Admin=admin_name1,admin_name2
```

```
UPDATE ALERTTRIGGER message_number ADDadmin=admin_name3 DELadmin=admin_name1
```

Tip: From the Configure Alerts page of the Operations Center, you can select the administrators who will receive email notification.

- o Send alert summaries

To specify or update the administrator IDs to receive alert summaries by email, issue the following command:

```
SET ALERTSUMMARYTOADMINS admin_name1,admin_name2,admin_name3
```

If you want to receive alert summaries but do not want to receive notification about individual alerts, complete the following steps:

- a. Suspend notification about individual alerts, as described in Suspending email alerts temporarily.
- b. Ensure that the respective administrator ID is listed in the following command:

```
SET ALERTSUMMARYTOADMINS admin_name1,admin_name2,admin_name3
```

## Sending email alerts to multiple administrators

---

The following example illustrates the commands that cause any alerts for message ANR1075E to be sent in an email to the administrators myadmin, djadmin, and csadmin:

```
SET ALERTMONITOR ON
SET ALERTEMAIL ON
SET ALERTEMAILSMTPHOST mymailserver.domain.com
```

```

SET ALERTEMAILSMTPPORT 450
SET ALERTEMAILFROMADDR srvadmin@mydomain.com
UPDATE ADMIN myadmin ALERT=YES EMAILADDRESS=myaddr@anycompany.com
UPDATE ADMIN djadmin ALERT=YES EMAILADDRESS=djaddr@anycompany.com
UPDATE ADMIN csadmin ALERT=YES EMAILADDRESS=csaddr@anycompany.com
DEFINE ALERTTRIGGER anr0175e ADMIN=myadmin,djadmin,csadmin

```

- Suspending email alerts temporarily

In certain situations, you might want to suspend email alerts temporarily. For example, you might want to receive alert summaries but suspend notification about individual alerts, or you might want to suspend email alerts when an administrator is on vacation.

#### Related reference:

```

DEFINE ALERTTRIGGER (Define an alert trigger)
QUERY MONITORSETTINGS (Query the configuration settings for monitoring alerts and server status)
REGISTER ADMIN (Register an administrator ID)
SET ALERTEMAIL (Set the alert monitor to email alerts to administrators)
SET ALERTEMAILFROMADDR (Set the email address of the sender)
SET ALERTEMAILSMTPHOST (Set the SMTP mail server host name)
SET ALERTEMAILSMTPPORT (Set the SMTP mail server host port)
SET ALERTMONITOR (Set the alert monitor to on or off)
SET ALERTSUMMARYTOADMINS (Set the list of administrators to receive alert summaries by email)
UPDATE ADMIN (Update an administrator)
UPDATE ALERTTRIGGER (Update a defined alert trigger)

```

AIX Linux Windows

## Adding customized text to the login screen

You can add customized text, such as your organization's Terms of Use of the software, to the login screen of the Operations Center so that users of the Operations Center see the text before they enter their user name and password.

### Procedure

To add customized text to the login screen, complete the following steps:

1. On the computer where the Operations Center is installed, go to the following directory, where *installation\_dir* represents the directory in which the Operations Center is installed:

AIX Linux *installation\_dir*/ui/Liberty/usr/servers/guiServer

Windows *installation\_dir*\ui\Liberty\usr\servers\guiServer

2. In the directory, create a file that is named loginText.html that contains the text that you want to add to the login screen. Any special, non-ASCII text must be UTF-8 encoded.  
Tip: You can format the text by adding HTML tags.
3. Review the added text on the login screen of the Operations Center.  
To open the Operations Center, enter the following address in a web browser, where *hostname* represents the name of the computer where the Operations Center is installed, and *secure\_port* represents the port number that the Operations Center uses for HTTPS communication on that computer:

`https://hostname:secure_port/oc`

## Enabling REST services

Applications that use Representational State Transfer (REST) services can query and manage the storage environment by connecting to the Operations Center.

### About this task

Enable this feature to allow REST services to interact with hub and spoke servers by sending calls to the following address:

`https://oc_host_name:port/oc/api`

where *oc\_host\_name* is the network name or IP address of the Operations Center host system and *port* is the Operations Center port number. The default port number is 11090.

For information about the REST services that are available for the Operations Center, see Technote <http://www.ibm.com/support/docview.wss?uid=swg21973011>, or issue the following REST call:

```
https://oc_host_name:port/oc/api/help
```

## Procedure

---

1. On the Operations Center menu bar, hover over the settings icon  and click Settings.
2. On the General page, select the Enable administrative REST API check box.
3. Click Save.

AIX

Linux

Windows

## Configuring for secure communication

---

The Operations Center uses Hypertext Transfer Protocol Secure (HTTPS) to communicate with web browsers. The Transport Layer Security (TLS) protocol secures communications between the Operations Center and the hub server, and between the hub server and associated spoke servers.

### About this task

---

TLS 1.2 is required for secure communication between the IBM Spectrum Protect™ server and the Operations Center, and between the hub server and spoke servers.

- Securing communication between the Operations Center and the hub server  
To secure communications between the Operations Center and the hub server, you must add the Transport Layer Security (TLS) certificate of the hub server to the truststore file of the Operations Center.
- Securing communication between the hub server and a spoke server  
To secure communications between the hub server and a spoke server by using the Transport Layer Security (TLS) protocol, you must define the certificate of the spoke server to the hub server. You must also configure the Operations Center to monitor the spoke server.
- Resetting the password for the Operations Center truststore file  
To set up secure communication between the Operations Center and the hub server, you must know the password for the truststore file of the Operations Center. You create this password during the installation of the Operations Center. If you do not know the password, you can reset it.

AIX

Linux

Windows

## Securing communication between the Operations Center and the hub server

---

To secure communications between the Operations Center and the hub server, you must add the Transport Layer Security (TLS) certificate of the hub server to the truststore file of the Operations Center.

### Before you begin

---

The truststore file of the Operations Center is a container for certificates that the Operations Center can access. The truststore file contains the certificate that the Operations Center uses for HTTPS communication with web browsers.

During the installation of the Operations Center, you create a password for the truststore file. To secure communication between the Operations Center and the hub server, you must use the same password to add the certificate of the hub server to the truststore file. If you do not remember this password, you can reset it. See [Resetting the password for the Operations Center truststore file](#).

## Procedure

---

1. Specify the cert256.arm certificate as the default certificate in the key database file of the hub server.

To specify cert256.arm as the default certificate, complete the following steps:

a. Issue the following command from the hub server instance directory:

```
gsk8capicmd_64 -cert -setdefault -db cert.kdb -stashed  
-label "TSM Server SelfSigned SHA Key"
```

b. Restart the hub server so that it can receive the changes to the key database file.

2. To verify that the cert256.arm certificate is set as the default certificate in the key database file of the hub server, issue the following command:

```
gsk8capicmd_64 -cert -list -db cert.kdb -stashed
```

3. Stop the Operations Center web server.

4. Go to the command line of the operating system on which the Operations Center is installed.

5. Add the certificate to the truststore file of the Operations Center by using the iKeycmd command or the iKeyman command. The iKeyman command opens the IBM® Key Management graphical user interface, and iKeycmd is a command line interface.

To add the SSL certificate by using the command line interface, issue the iKeycmd command to add the cert256.arm certificate as the default certificate in the key database file of the hub server:

```
ikeycmd -cert -add  
-db /installation_dir/Liberty/usr/servers/guiServer/gui-truststore.jks  
-file /fvt/comfrey/srv/cert256.arm  
-label 'label description'  
-pw 'password' -type jks -format ascii -trust enable
```

where:

installation\_dir

The directory in which the Operations Center is installed.

label description

The description that you assign to the label.

password

The password that you created when you installed the Operations Center. To reset the password, uninstall the Operations Center, delete the .jks file, and reinstall the Operations Center.

To add the certificate by using the IBM Key Management window, complete the following steps:

a. Go to the following directory, where *installation\_dir* represents the directory in which the Operations Center is installed:

- |     |       |
|-----|-------|
| AIX | Linux |
|-----|-------|

*installation\_dir*/ui/jre/bin
- |         |
|---------|
| Windows |
|---------|

*installation\_dir*\ui\jre\bin

b. Open the IBM Key Management window by issuing the following command:

```
ikeyman
```

c. Click Key Database File > Open.

d. In the Open window, click Browse, and go to the following directory, where *installation\_dir* represents the directory in which the Operations Center is installed:

- |     |       |
|-----|-------|
| AIX | Linux |
|-----|-------|

*installation\_dir*/ui/Liberty/usr/servers/guiServer
- |         |
|---------|
| Windows |
|---------|

*installation\_dir*\ui\Liberty\usr\servers\guiServer

e. In the guiServer directory, select the gui-truststore.jks file.

f. Click Open, and click OK.

g. Enter the password for the truststore file, and click OK.

h. In the Key database content area of the IBM Key Management window, click the arrow, and select Signer Certificates from the list.

i. Click Add.

j. In the Open window, click Browse, and go to the hub server instance directory, as shown in the following example:

- |     |       |
|-----|-------|
| AIX | Linux |
|-----|-------|

 /opt/tivoli/tsm/server/bin
- |         |
|---------|
| Windows |
|---------|

 c:\Program Files\Tivoli\TSM\server1

The directory contains the cert256.arm certificate.

If you cannot access the hub server instance directory from the Open window, complete the following steps:

i. Use FTP or another file-transfer method to copy the cert256.arm files from the hub server to the following directory on the computer where the Operations Center is installed:

- |     |       |
|-----|-------|
| AIX | Linux |
|-----|-------|

*installation\_dir*/ui/Liberty/usr/servers/guiServer
- |         |
|---------|
| Windows |
|---------|

*installation\_dir*\ui\Liberty\usr\servers\guiServer

- ii. In the Open window, go to the guiServer directory.
  - k. Select the cert256.arm certificate as the certificate.
    - Tip: The certificate that you choose must be set as the default certificate in the key database file of the hub server. For more information, see step 1 and 2.
  - l. Click Open, and click OK.
  - m. Enter a label for the certificate. For example, enter the name of the hub server.
  - n. Click OK. The SSL certificate of the hub server is added to the truststore file, and the label is displayed in the Key database content area of the IBM Key Management window.
  - o. Close the IBM Key Management window.
6. Start the Operations Center web server.
7. When you connect to the Operations Center for the first time, you are prompted to identify the IP address or network name of the hub server, and the port number for communicating with the hub server. If the ADMINONCLIENTPORT server option is enabled for the IBM Spectrum Protect™ server, enter the port number that is specified by the TCPADMINPORT server option. If the ADMINONCLIENTPORT server option is not enabled, enter the port number that is specified by the TCPPORT server option.
- If the Operations Center was previously configured, you can review the contents of the serverConnection.properties file to verify the connection information. The serverConnection.properties file is in the following directory on the computer where the Operations Center is installed:
- o 

AIX	Linux
-----	-------

`installation_dir/ui/Liberty/usr/servers/guiServer`
  - o 

Windows
---------

`installation_dir\ui\Liberty\usr\servers\guiServer`

## What to do next

To set up SSL communication between the hub server and a spoke server, see [Securing communication between the hub server and a spoke server](#).

### Related reference:

[QUERY OPTION \(Query server options\)](#)

AIX	Linux	Windows
-----	-------	---------

## Securing communication between the hub server and a spoke server

To secure communications between the hub server and a spoke server by using the Transport Layer Security (TLS) protocol, you must define the certificate of the spoke server to the hub server. You must also configure the Operations Center to monitor the spoke server.

### Procedure

1. On the spoke server, change to the directory of the spoke server instance.
2. Specify the required cert256.arm certificate as the default certificate in the key database file of the spoke server. Issue the following command:

```
gsk8capicmd_64 -cert -setdefault -db cert.kdb -stashed
-label "TSM Server SelfSigned SHA Key"
```

3. Verify the certificates in the key database file of the spoke server. Issue the following command:

```
gsk8capicmd_64 -cert -list -db cert.kdb -stashed
```

4. Securely transfer the cert256.arm file of the spoke server to the hub server.
5. On the hub server, change to the directory of the hub server instance.
6. Define the spoke server certificate to the hub server. Issue the following command from the hub server instance directory, where *spoke\_servername* is the name of the spoke server, and *spoke\_cert256.arm* is the file name of the spoke server certificate:

```
gsk8capicmd_64 -cert -add -db cert.kdb -stashed -format ascii
-label spoke_servername -file spoke_cert256.arm
```

The spoke server does not require the hub server certificate for hub-to-spoke communication. However, other server configurations that require cross-defined servers do require the spoke server to have the hub server certificate.

7. Restart the hub server and the spoke server.
8. For the hub server, issue the DEFINE SERVER command, according to the following example:

```
DEFINE SERVER spoke_servername HLA=spoke_address
LLA=spoke_SSLTCPADMINPort SERVERPA=spoke_serverpassword
```

Tip: By default, server communication is encrypted except when the server is sending or receiving object data. Object data is sent and received by using TCP/IP. By choosing not to encrypt the object data, server performance is similar to communication over a TCP/IP session and the session is secure. To encrypt all communication with the specified server, even when the server is sending and receiving object data, specify the SSL=YES parameter on the DEFINE SERVER command.

9. On the Operations Center menu bar, click Servers.

In the table on the Servers page, the spoke server that you defined in step 8 typically has a status of "Unmonitored." Depending on the setting for the status refresh interval, you might not see the spoke server immediately.

10. Click the spoke server to highlight the item, and in the table menu bar, click Monitor Spoke.

**Related reference:**

DEFINE SERVER (Define a server for server-to-server communications)

QUERY OPTION (Query server options)

AIX | Linux | Windows

## Resetting the password for the Operations Center truststore file

To set up secure communication between the Operations Center and the hub server, you must know the password for the truststore file of the Operations Center. You create this password during the installation of the Operations Center. If you do not know the password, you can reset it.

### About this task

To reset the password, you must create a new password, delete the truststore file of the Operations Center, and restart the Operations Center web server.

### Procedure

1. Stop the Operations Center web server.
2. Go to the following directory, where *installation\_dir* represents the directory in which the Operations Center is installed:
  - o AIX | Linux `installation_dir/ui/Liberty/usr/servers/guiServer`
  - o Windows `installation_dir\ui\Liberty\usr\servers\guiServer`
3. Open the bootstrap.properties file, which contains the password for the truststore file. If the password is unencrypted, you can use it to open the truststore file without having to reset it.

The following examples indicate the difference between an encrypted and an unencrypted password:

#### Encrypted password example

Encrypted passwords begin with the text string {xor}.

The following example shows the encrypted password as the value of the tsm.truststore.pswd parameter:

```
tsm.truststore.pswd={xor}MiYPPiwsKDatOw==
```

#### Unencrypted password example

The following example shows the unencrypted password as the value of the tsm.truststore.pswd parameter:

```
tsm.truststore.pswd=J8b%^B
```

4. Reset the password by replacing the password in the bootstrap.properties file with a new password. You can replace the password with an encrypted or unencrypted password. Remember the unencrypted password for future use. To create an encrypted password, complete the following steps:
  - a. Create an unencrypted password.

The password for the truststore file must meet the following criteria:

    - The password must contain a minimum of 6 characters and a maximum of 64 characters.
    - The password must contain at least the following characters:
      - One uppercase letter (A – Z)
      - One lowercase letter (a – z)
      - One digit (0 – 9)
      - Two of the non-alphanumeric characters that are listed in the following series:

```
~ ! @ # $ % ^ & * _ - + = ` |
( ) { } [ ] : ; < > , . ? /
```

b. From the command line of the operating system, go to the following directory:

- **AIX** | **Linux** `installation_dir/ui/Liberty/bin`
- **Windows** `installation_dir\ui\Liberty\bin`

c. To encrypt the password, issue the following command, where *myPassword* represents the unencrypted password:

- **AIX** | **Linux** `securityUtility encode myPassword`
- **Windows** `securityUtility.bat encode myPassword`

**Windows** The following message might be shown:

```
! "java" is not recognized as an internal or external command,
operable program or batch file.
```

If this message is shown, complete the following steps:

i. Issue the following command, where *installation\_dir* represents the directory where the Operations Center is installed:

```
set JAVA_HOME="installation_dir\ui\jre"
```

ii. Reissue the following command to encrypt the password:

```
securityUtility.bat encode myPassword
```

5. Close the bootstrap.properties file.

6. Go to the following directory:

- **AIX** | **Linux** `installation_dir/ui/Liberty/usr/servers/guiServer`
- **Windows** `installation_dir\ui\Liberty\usr\servers\guiServer`

7. Delete the gui-truststore.jks file, which is the truststore file of the Operations Center.

8. Start the Operations Center web server.

## Results

---

A new truststore file is automatically created for the Operations Center, and the TLS certificate of the Operations Center is automatically included in the truststore file.

**AIX** | **Linux** | **Windows**

## Starting and stopping the web server

---

The web server of the Operations Center runs as a service and starts automatically. You might need to stop and start the web server, for example, to make configuration changes.

## Procedure

---

Stop and start the web server.

- **AIX** From the `/installation_dir/ui/utls` directory, where *installation\_dir* represents the directory where the Operations Center is installed, issue the following commands:

- To stop the server:

```
./stopserver.sh
```

- To start the server:

```
./startserver.sh
```

- **Linux** Issue the following commands:

- To stop the server:

```
service opscenter.rc stop
```

- To start the server:

```
service opscenter.rc start
```

- To restart the server:

```
service opscenter.rc restart
```

To determine whether the server is running, issue the following command:

```
service opscenter.rc status
```

- **Windows** From the Services window, stop or start the Operations Center service.

## Opening the Operations Center

---

The Overview page is the default initial view in the Operations Center. However, in your web browser, you can bookmark the page that you want to open when you log in to the Operations Center.

### Procedure

---

1. In a web browser, enter the following address, where *hostname* represents the name of the computer where the Operations Center is installed, and *secure\_port* represents the port number that the Operations Center uses for HTTPS communication on that computer:

```
https://hostname:secure_port/oc
```

Tips:

- The URL is case-sensitive. For example, ensure that you type "oc" in lowercase as indicated.
  - The default port number for HTTPS communication is 11090, but a different port number can be specified during Operations Center installation.
2. Log in, using an administrator ID that is registered on the hub server.

In the Overview page, you can view summary information for clients, services, servers, storage pools, and storage devices. You can view more details by clicking items or by using the Operations Center menu bar.

Monitoring from a mobile device: To remotely monitor the storage environment, you can view the Overview page of the Operations Center in the web browser of a mobile device. The Operations Center supports the Apple Safari web browser on the iPad. Other mobile devices can also be used.

**AIX** | **Linux** | **Windows**

## Collecting diagnostic information with IBM Spectrum Protect client management services

---

The client management service collects diagnostic information about backup-archive clients and makes the information available to the Operations Center for basic monitoring capability.

### About this task

---

After you install the client management service, you can view the Diagnosis page in the Operations Center to obtain troubleshooting information for backup-archive clients.

Diagnostic information can be collected only from Linux and Windows clients, but administrators can view the diagnostic information in the Operations Center on AIX®, Linux, or Windows operating systems.

You can also install the client management service on data mover nodes for IBM Spectrum Protect™ for Virtual Environments: Data Protection for VMware to collect diagnostic information about the data movers.

Tip: In the documentation for the client management service, *client system* is the system where the backup-archive client is installed.

- Installing the client management service by using a graphical wizard  
To collect diagnostic information about backup-archive clients such as client log files, you must install the client management service on the client systems that you manage.
- Installing the client management service in silent mode  
You can install the client management service in silent mode. When you use silent mode, you provide the installation values in a response file and then run an installation command.



- Verifying that the client management service is installed correctly  
Before you use the client management service to collect diagnostic information about a backup-archive client, you can verify that the client management service is correctly installed and configured.
- Configuring the Operations Center to use the client management service  
If you did not use the default configuration for the client management service, you must configure the Operations Center to access the client management service.
- Starting and stopping the client management service  
The client management service is automatically started after it is installed on the client system. You might need to stop and start the service in certain situations.
- Uninstalling the client management service  
If you no longer have to collect client diagnostic information, you can uninstall the client management service from the client system.
- Configuring the client management service for custom client installations  
The client management service uses information in the client configuration file (client-configuration.xml) to discover diagnostic information. If the client management service is unable to discover the location of log files, you must run the CmsConfig utility to add the location of the log files to the client-configuration.xml file.

AIX | Linux | Windows

## Installing the client management service by using a graphical wizard

To collect diagnostic information about backup-archive clients such as client log files, you must install the client management service on the client systems that you manage.

### Before you begin

Review Requirements and limitations for IBM Spectrum Protect client management services.

### About this task

You must install the client management service on the same computer as the backup-archive client.

### Procedure

1. Download the installation package for the client management service from an IBM® download site such as IBM Passport Advantage® or IBM Fix Central. Look for a file name that is similar to `<version>-IBM-SPCMS-<operating system>.bin`.

The following table shows the names of the installation packages.

Client operating system	Installation package name
Linux x86 64-bit	8.1.x.000-IBM-SPCMS-Linuxx64.bin
Windows 32-bit	8.1.x.000-IBM-SPCMS-Windows32.exe
Windows 64-bit	8.1.x.000-IBM-SPCMS-Windows64.exe

2. Create a directory on the client system that you want to manage, and copy the installation package there.
3. Extract the contents of the installation package file.

- On Linux client systems, complete the following steps:
  - a. Change the file to an executable file by issuing the following command:

```
chmod +x 8.1.x.000-IBM-SPCMS-Linuxx64.bin
```

- b. Issue the following command:

```
./8.1.x.000-IBM-SPCMS-Linuxx64.bin
```

- On Windows client systems, double-click the installation package name in Windows Explorer.

Tip: If you previously installed and uninstalled the package, select All when prompted to replace the existing installation files.

4. Run the installation batch file from the directory where you extracted the installation files and associated files. This is the directory that you created in step 2.
  - On Linux client systems, issue the following command:

```
./install.sh
```

- o On Windows client systems, double-click install.bat.
5. To install the client management service, follow the instructions in the IBM Installation Manager wizard.

If IBM Installation Manager is not already installed on the client system, you must select both IBM Installation Manager and IBM Spectrum Protect Client Management Services.

Tip: You can accept the default locations for the shared resources directory and the installation directory for IBM Installation Manager.

## What to do next

---

Follow the instructions in Verifying that the client management service is installed correctly.

AIX | Linux | Windows

## Installing the client management service in silent mode

---

You can install the client management service in silent mode. When you use silent mode, you provide the installation values in a response file and then run an installation command.

### Before you begin

---

Review Requirements and limitations for IBM Spectrum Protect client management services.

Extract the installation package by following the instructions in Installing the client management service by using a graphical wizard.

### About this task

---

You must install the client management service on the same computer as the backup-archive client.

The input directory, which is in the directory where the installation package is extracted, contains the following sample response file:

```
install_response_sample.xml
```

You can use the sample file with the default values, or you can customize it.

Tip: If you want to customize the sample file, create a copy of the sample file, rename it, and edit the copy.

### Procedure

---

1. Create a response file based on the sample file, or use the sample file, `install_response_sample.xml`. In either case, ensure that the response file specifies the port number for the client management service. The default port is 9028. For example:

```
<variable name='port' value='9028' />
```

2. Run the command to install the client management service and accept the license. From the directory where the installation package file is extracted, issue the following command, where *response\_file* represents the response file path, including the file name:

On a Linux client system:

```
./install.sh -s -input response_file -acceptLicense
```

For example:

```
./install.sh -s -input /cms_install/input/install_response.xml -acceptLicense
```

On a Windows client system:

```
install.bat -s -input response_file -acceptLicense
```

For example:

```
install.bat -s -input c:\cms_install\input\install_response.xml -acceptLicense
```

## What to do next

---

Follow the instructions in Verifying that the client management service is installed correctly.

AIX | Linux | Windows

## Verifying that the client management service is installed correctly

---

Before you use the client management service to collect diagnostic information about a backup-archive client, you can verify that the client management service is correctly installed and configured.

### Procedure

---

On the client system, at the command line, run the following commands to view the configuration of the client management service:

- On Linux client systems, issue the following command:

```
client_install_dir/cms/bin/CmsConfig.sh list
```

where *client\_install\_dir* is the directory where the backup-archive client is installed. For example, with the default client installation, issue the following command:

```
/opt/tivoli/tsm/cms/bin/CmsConfig.sh list
```

The output is similar to the following text:

Listing CMS configuration

```
server1.example.com:1500 NO_SSL HOSTNAME
Capabilities: [LOG_QUERY]
  Opt Path: /opt/tivoli/tsm/client/ba/bin/dsm.sys

  Log File: /opt/tivoli/tsm/client/ba/bin/dsmerror.log
            en_US MM/dd/yyyy HH:mm:ss Windows-1252

  Log File: /opt/tivoli/tsm/client/ba/bin/dsmsched.log
            en_US MM/dd/yyyy HH:mm:ss Windows-1252
```

- On Windows client systems, issue the following command:

```
client_install_dir\cms\bin\CmsConfig.bat list
```

where *client\_install\_dir* is the directory where the backup-archive client is installed. For example, with the default client installation, issue the following command:

```
C:"Program Files"\Tivoli\TSM\cms\bin\CmsConfig.bat list
```

The output is similar to the following text:

Listing CMS configuration

```
server1.example.com:1500 NO_SSL HOSTNAME
Capabilities: [LOG_QUERY]
  Opt Path: C:\Program Files\Tivoli\TSM\baclient\dsm.opt

  Log File: C:\Program Files\Tivoli\TSM\baclient\dsmerror.log
            en_US MM/dd/yyyy HH:mm:ss Windows-1252

  Log File: C:\Program Files\Tivoli\TSM\baclient\dsmsched.log
            en_US MM/dd/yyyy HH:mm:ss Windows-1252
```

If the client management service is correctly installed and configured, the output displays the location of the error log file. The output text is extracted from the following configuration file:

- On Linux client systems:

```
client_install_dir/cms/Liberty/usr/servers/cmsServer/client-configuration.xml
```

- On Windows client systems:

```
client_install_dir\cms\Liberty\usr\servers\cmsServer\client-configuration.xml
```

If the output does not contain any entries, you must configure the client-configuration.xml file. For instructions about how to configure this file, see [Configuring the client management service for custom client installations](#). You can use the CmsConfig verify command to verify that a node definition is correctly created in the client-configuration.xml file.

AIX

Linux

Windows

## Configuring the Operations Center to use the client management service

If you did not use the default configuration for the client management service, you must configure the Operations Center to access the client management service.

### Before you begin

Ensure that the client management service is installed and started on the client system.

Verify whether the default configuration is used. The default configuration is not used if either of the following conditions is met:

- The client management service does not use the default port number, 9028.
- The backup-archive client is not accessed by the same IP address as the client system where the backup-archive client is installed. For example, a different IP address might be used in the following situations:
  - The computer system has two network cards. The backup-archive client is configured to communicate on one network, while the client management service communicates on the other network.
  - The client system is configured with the Dynamic Host Configuration Protocol (DHCP). As a result, the client system is dynamically assigned an IP address, which is saved on the IBM Spectrum Protect™ server during the previous backup-archive client operation. When the client system is restarted, the client system might be assigned a different IP address. To ensure that the Operations Center can always find the client system, you specify a fully qualified domain name.

### Procedure

To configure the Operations Center to use the client management service, complete the following steps:

1. On the Clients page of the Operations Center, select the client.
2. Click Details.
3. Click the Properties tab.
4. In the Remote diagnostics URL field in the General section, specify the URL for the client management service on the client system.

The address must start with `https`. The following table shows examples of the remote diagnostics URL.

Type of URL	Example
With DNS host name and default port, 9028	<code>https://server.example.com</code>
With DNS host name and non-default port	<code>https://server.example.com:1599</code>
With IP address and non-default port	<code>https://192.0.2.0:1599</code>

5. Click Save.

### What to do next

You can access client diagnostic information such as client log files from the Diagnosis tab in the Operations Center.

AIX

Linux

Windows

## Starting and stopping the client management service

The client management service is automatically started after it is installed on the client system. You might need to stop and start the service in certain situations.

## Procedure

---

- To stop, start, or restart the client management service on Linux client systems, issue the following commands:
  - To stop the service:

```
service cms.rc stop
```
  - To start the service:

```
service cms.rc start
```
  - To restart the service:

```
service cms.rc restart
```
- On Windows client systems, open the Services window, and stop, start, or restart the IBM Spectrum Protect™ Client Management Services service.

AIX

Linux

Windows

## Uninstalling the client management service

---

If you no longer have to collect client diagnostic information, you can uninstall the client management service from the client system.

### About this task

---

You must use IBM® Installation Manager to uninstall the client management service. If you no longer plan to use IBM Installation Manager, you can also uninstall it.

## Procedure

---

1. Uninstall the client management service from the client system:
  - a. Open IBM Installation Manager:
    - On the Linux client system, in the directory where IBM Installation Manager is installed, go to the eclipse subdirectory (for example, /opt/IBM/InstallationManager/eclipse), and issue the following command:

```
./IBMIM
```
    - On the Windows client system, open IBM Installation Manager from the Start menu.
  - b. Click Uninstall.
  - c. Select IBM Spectrum Protect Client Management Services, and click Next.
  - d. Click Uninstall, and then click Finish.
  - e. Close the IBM Installation Manager window.
2. If you no longer require IBM Installation Manager, uninstall it from the client system:
  - a. Open the IBM Installation Manager uninstall wizard:
    - On the Linux client system, change to the IBM Installation Manager uninstall directory (for example, /var/ibm/InstallationManager/uninstall), and issue the following command:

```
./uninstall
```
    - On the Windows client system, click Start > Control Panel. Then, click Uninstall a program > IBM Installation Manager > Uninstall.
  - b. In the IBM Installation Manager window, select IBM Installation Manager if it is not already selected, and click Next.
  - c. Click Uninstall, and click Finish.

AIX

Linux

Windows

## Configuring the client management service for custom client installations

---

The client management service uses information in the client configuration file (client-configuration.xml) to discover diagnostic information. If the client management service is unable to discover the location of log files, you must run the CmsConfig utility to add the location of the log files to the client-configuration.xml file.

- CmsConfig utility

If you are not using the default client configuration, you can run the CmsConfig utility on the client system to discover and add the location of the client log files to the client-configuration.xml file. After you complete the configuration, the client management service can access the client log files and make them available for basic diagnostic functions in the Operations Center.

AIX | Linux

## Troubleshooting the Operations Center installation

---

If a problem occurs with the Operations Center installation and you cannot solve it, you can consult the descriptions of known problems for a possible solution.

- **AIX** Graphical installation wizard cannot be started on an AIX system  
You are installing the Operations Center on an AIX® system by using the graphical wizard, and the installation program does not start.
- **Linux** Chinese, Japanese, or Korean fonts are displayed incorrectly  
Chinese, Japanese, or Korean fonts are displayed incorrectly in the Operations Center on Red Hat Enterprise Linux 5.

AIX

## Graphical installation wizard cannot be started on an AIX system

---

You are installing the Operations Center on an AIX® system by using the graphical wizard, and the installation program does not start.

### Solution

---

The RPM files that are listed in Installing the Operations Center by using a graphical wizard must be installed on the computer. Verify that the RPM files are installed.

Linux

## Chinese, Japanese, or Korean fonts are displayed incorrectly

---

Chinese, Japanese, or Korean fonts are displayed incorrectly in the Operations Center on Red Hat Enterprise Linux 5.

### Solution

---

Install the following font packages, which are available from Red Hat:

- fonts-chinese
- fonts-japanese
- fonts-korean

AIX | Linux | Windows

## Uninstalling the Operations Center

---

You can uninstall the Operations Center by using any of the following methods: a graphical wizard, the command line in console mode, or silent mode.

- Uninstalling the Operations Center by using a graphical wizard  
You can uninstall the Operations Center by using the graphical wizard of IBM® Installation Manager.
- Uninstalling the Operations Center in console mode  
To uninstall the Operations Center by using the command line, you must run the uninstallation program of IBM Installation Manager from the command line with the parameter for console mode.
- Uninstalling the Operations Center in silent mode  
To uninstall the Operations Center in silent mode, you must run the uninstallation program of IBM Installation Manager from the command line with the parameters for silent mode.

AIX | Linux | Windows

# Uninstalling the Operations Center by using a graphical wizard

---

You can uninstall the Operations Center by using the graphical wizard of IBM® Installation Manager.

## Procedure

---

1. Open IBM Installation Manager.

**AIX** | **Linux** In the directory where IBM Installation Manager is installed, go to the eclipse subdirectory (for example, /opt/IBM/InstallationManager/eclipse), and issue the following command:

```
./IBMIM
```

**Windows** You can open IBM Installation Manager from the Start menu.

2. Click Uninstall.
3. Select the option for the Operations Center, and click Next.
4. Click Uninstall.
5. Click Finish.

**AIX** | **Linux** | **Windows**

## Uninstalling the Operations Center in console mode

---

To uninstall the Operations Center by using the command line, you must run the uninstallation program of IBM® Installation Manager from the command line with the parameter for console mode.

## Procedure

---

1. In the directory where IBM Installation Manager is installed, go to the following subdirectory:

- o **AIX** | **Linux** eclipse/tools
- o **Windows** eclipse\tools

For example:

- o **AIX** | **Linux** /opt/IBM/InstallationManager/eclipse/tools
- o **Windows** C:\Program Files\IBM\Installation Manager\eclipse\tools

2. From the tools directory, issue the following command:

- o **AIX** | **Linux** ./imcl -c
- o **Windows** imcl.exe -c

3. To uninstall, enter 5.
4. Choose to uninstall from the IBM Spectrum Protect™ package group.
5. Enter N for Next.
6. Choose to uninstall the Operations Center package.
7. Enter N for Next.
8. Enter U for Uninstall.
9. Enter F for Finish.

**AIX** | **Linux** | **Windows**

## Uninstalling the Operations Center in silent mode

---

To uninstall the Operations Center in silent mode, you must run the uninstallation program of IBM® Installation Manager from the command line with the parameters for silent mode.

## Before you begin

---

You can use a response file to provide data input to silently uninstall the Operations Center server. IBM Spectrum Protect™ includes a sample response file, uninstall\_response\_sample.xml, in the input directory where the installation package is extracted. This file contains default values to help you avoid any unnecessary warnings.

To uninstall the Operations Center, leave `modify="false"` set for the Operations Center entry in the response file.

If you want to customize the response file, you can modify the options that are in the file. For information about response files, see Response files.

## Procedure

---

1. In the directory where IBM Installation Manager is installed, go to the following subdirectory:

- o **AIX** | **Linux** eclipse/tools
- o **Windows** eclipse\tools

For example:

- o **AIX** | **Linux** /opt/IBM/InstallationManager/eclipse/tools
- o **Windows** C:\Program Files\IBM\Installation Manager\eclipse\tools

2. From the tools directory, issue the following command, where *response\_file* represents the response file path, including the file name:

- o **AIX** | **Linux** ./imcl -input *response\_file* -silent
- o **Windows** imcl.exe -input *response\_file* -silent

The following command is an example:

- o **AIX** | **Linux** ./imcl -input /tmp/input/uninstall\_response.xml -silent
- o **Windows** imcl.exe -input C:\tmp\input\uninstall\_response.xml -silent

**AIX** | **Linux** | **Windows**

## Rolling back to a previous version of the Operations Center

---

By default, IBM® Installation Manager saves earlier versions of a package to roll back to if you experience a problem with later versions of updates, fixes, or packages.

### Before you begin

---

The rollback function is available only after the Operations Center is updated.

### About this task

---

When IBM Installation Manager rolls back a package to a previous version, the current version of the package files is uninstalled, and an earlier version is reinstalled.

To roll back to a previous version, IBM Installation Manager must access files for that version. By default, these files are saved during each successive installation. Because the number of saved files increases with each installed version, you might want to delete these files from your system on a regular schedule. However, if you delete the files, you cannot roll back to a previous version.

To delete saved files or to update your preference for saving these files in future installations, complete the following steps:

1. In IBM Installation Manager, click File > Preferences.
2. On the Preferences page, click Files for Rollback, and specify your preference.

## Procedure

---

To roll back to a previous version of the Operations Center, use the Roll Back function of IBM Installation Manager.

## Configuring servers

---

To complete configuration tasks for the IBM Spectrum Protect™ server, review available documentation.

### About this task

---

For an existing solution, review the following actions.

To plan, implement, monitor, and operate a new solution, follow the instructions in IBM Spectrum Protect data protection solutions.



Tip: Beginning with IBM Spectrum Protect V7.1.3, the *Administrator's Guide* is obsoleted.

Action	Details	Documentation
Monitor a storage solution	Monitor the storage solution to identify existing and potential issues. In this way, you can troubleshoot problems and optimize system performance.	Monitoring storage solutions
Select and configure storage	Select storage based on your business needs and then complete the tasks for configuration.	Configuring storage
Eliminate duplicate data	<p>Use data deduplication to eliminate redundant data in storage pools. Data deduplication reduces the storage that is required to retain the data. Only one instance of the data is retained in a deduplicated storage pool.</p> <p>With IBM Spectrum Protect V7.1.3 and later, you can use inline data deduplication.</p>	To learn more about the differences between inline and post-process data deduplication and to configure the best practice solution for data deduplication, see <a href="#">Data deduplication options</a> .
Replicate data	You can replicate client node data from a source replication server to a target replication server. If a disaster occurs and the source server is temporarily unavailable, client nodes can recover their data from the target replication server.	<p>To implement a best practice solution that uses IBM Spectrum Protect replication and automatic failover, see <a href="#">Multisite disk solution</a>.</p> <p>For general information about replication, including configuration steps, see <a href="#">Replicating client data to another server</a>.</p>
Manage the database and recovery log	The database and recovery log, or server inventory, store information about client data and are critical to the operation of the server.	<ul style="list-style-type: none"> <li>• For general information about the database and recovery log, see: <a href="#">Managing the database and recovery log (V7.1.1)</a>.</li> <li>• To optimize index and table reorganization for the server database, and prevent and resolve issues that are related to database growth and performance issues, see <a href="#">technote 1683633</a>.</li> </ul>
Secure the server	Secure the IBM Spectrum Protect server and data by controlling access to servers and client nodes, encrypting data, and maintaining secure access levels and passwords.	Securing the IBM Spectrum Protect server
Configure SSL for Lightweight Directory Access Protocol (LDAP)	You can configure SSL for LDAP directory servers and manage passwords and logon procedures.	<p>For information about LDAP, see:</p> <ul style="list-style-type: none"> <li>• <a href="#">Authenticating users by using an LDAP server</a></li> <li>• <a href="#">Configuring SSL or TLS for LDAP directory servers (V7.1.1)</a></li> </ul>

Action	Details	Documentation
Learn about and configure policies for data retention	IBM Spectrum Protect policies define the rules for managing your data.	To update policies, use the Operations Center.  To learn more about policies and create policies, see Customizing policies.
Protect the server and recover in a disaster	Protect your system infrastructure and data so that you can recover from a disaster. Use the tools and procedures that IBM Spectrum Protect provides to help you create a disaster plan.	For information about protecting and recovering the server, see: <ul style="list-style-type: none"> <li>Protecting the database and infrastructure setup files (V7.1.1)</li> <li>Using disaster recovery manager for tape environments (V7.1.1)</li> </ul>
Protect NAS file servers	You can plan, configure, and manage a backup environment that protects your network-attached storage (NAS) file server.	Protecting NAS file servers
Configure a clustered environment	Configure a clustered environment on AIX®, Linux, or Windows to ensure higher server availability and minimized downtime.	Configuring clustered environments
Verify license compliance	Verify that your IBM Spectrum Protect solution complies with the provisions of your licensing agreement. By verifying compliance regularly, you can track trends in data growth or processor value unit (PVU) usage.	Verifying license compliance

- Securing the IBM Spectrum Protect server  
Secure the IBM Spectrum Protect server and data by controlling access to servers and client nodes, encrypting data, and maintaining secure access levels and passwords.
- Replicating client data to another server  
Replicating client data from a source server to another server helps to ensure that backed-up client data is available for recovery if the source server is damaged. Replication incrementally copies data from the source server to the target server to provide failover and failback capability.
- Configuring clustered environments  
You can configure the IBM Spectrum Protect server for clustering on AIX, Linux, or Windows systems.

## Securing the IBM Spectrum Protect server

Secure the IBM Spectrum Protect™ server and data by controlling access to servers and client nodes, encrypting data, and maintaining secure access levels and passwords.

- Security concepts  
You can protect IBM Spectrum Protect from security risks by using communication protocols, securing passwords, and providing different access levels for administrators.
- Managing administrators  
An administrator who has system authority can complete any task with the IBM Spectrum Protect server, including assigning authority levels to other administrators. To complete some tasks, you must be granted authority by being assigned one or more authority levels.
- Changing password requirements  
You can change the minimum password limit, password length, password expiration, and enable or disable authentication for IBM Spectrum Protect.
- Securing IBM Spectrum Protect on the system  
Protect the system where the IBM Spectrum Protect server runs to prevent unauthorized access.

- Securing communications  
Your data and passwords are more secure when you protect them by using Secure Sockets Layer (SSL) or Transport Layer Security (TLS), a form of SSL.
- Authenticating IBM Spectrum Protect users by using an LDAP server  
Within an IBM Spectrum Protect system, users must authenticate to the server by providing a user ID and password. If your organization uses a Lightweight Directory Access Protocol (LDAP) server to manage user IDs, you can use the LDAP server to authenticate IBM Spectrum Protect user IDs.

## Security concepts

---

You can protect IBM Spectrum Protect™ from security risks by using communication protocols, securing passwords, and providing different access levels for administrators.

### Transport Layer Security

---

You can use the Secure Sockets Layer (SSL) or the Transport Layer Security (TLS) protocol to provide transport layer security for a secure connection between servers, clients, and storage agents. If you send data between the server, client, and storage agent, use SSL or TLS to encrypt the data.

Tip: Any IBM Spectrum Protect documentation that indicates "SSL" or to "select SSL" applies to TLS.

SSL is provided by the Global Security Kit (GSKit) that is installed with the IBM Spectrum Protect server that the server, client, and storage agent use.

Restriction: Do not use the SSL or TLS protocols for communications with a DB2® database instance that is used by any IBM Spectrum Protect servers.

Each server, client, or storage agent that enables SSL must use a trusted self-signed certificate or obtain a unique certificate that is signed by a certificate authority (CA). You can use your own certificates or purchase certificates from a CA. Either certificate must be installed and added to the key database on the IBM Spectrum Protect server, client, or storage agent. The certificate is verified by the SSL client or server that requests or initiates the SSL communication. Some CA certificates are preinstalled in the key databases, by default.

SSL is set up independently on the IBM Spectrum Protect server, client, and storage agent.

### Authority levels

---

With each IBM Spectrum Protect server, different administrative authority levels are available that determine the tasks that an administrator can complete.

After registration, an administrator must be granted authority by being assigned one or more administrative authority levels. An administrator with system authority can complete any task with the server and assign authority levels to other administrators by using the GRANT AUTHORITY command. Administrators with policy, storage, or operator authority can complete subsets of tasks.

An administrator can register other administrator IDs, grant levels of authority to them, rename IDs, remove IDs, and lock and unlock them from the server.

An administrator can control access to specific client nodes for root user IDs and non-root user IDs. By default, a non-root user ID cannot back up data on the node. Use the UPDATE NODE command to change the node settings to enable backup.

### Passwords

---

By default, the server automatically uses password authentication. With password authentication, all users must enter a password when they access the server.

Use Lightweight Directory Access Protocol (LDAP) to apply stricter requirements for passwords. For more information, see Authenticating users by using an LDAP server.

Table 1. Password authentication characteristics

Characteristic	More information
Case-sensitivity	Not case-sensitive.

Characteristic	More information
Default password expiration	90 days.  The expiration period begins when an administrator ID or client node is first registered to the server. If the password is not changed within this period, the password must be changed the next time that the user accesses the server.
Invalid password attempts	You can set a limit on consecutive invalid password attempts for all client nodes. When the limit is exceeded, the server locks the node.
Password length	The administrator can specify a minimum length.

## Session security

Session security is the level of security that is used for communication among IBM Spectrum Protect client nodes, administrative clients, and servers and is set by using the SESSIONSECURITY parameter.

The SESSIONSECURITY parameter can be set to one of the following values:

- The STRICT value enforces the highest level of security for communication between IBM Spectrum Protect servers, nodes, and administrators.
- The TRANSITIONAL value specifies that the existing communication protocol is used while you update your IBM Spectrum Protect software to V8.1.2 or later. This is the default. When SESSIONSECURITY=TRANSITIONAL, stricter security settings are automatically enforced as higher versions of the TLS protocol are used and as the software is updated to V8.1.2 or later. After a node, administrator, or server meets the requirements for the STRICT value, session security is automatically updated to the STRICT value, and the entity can no longer authenticate by using a previous version of the client or earlier TLS protocols.

For more information about the SESSIONSECURITY parameter values, see the following commands.

Table 2. Commands used to set the SESSIONSECURITY parameter

Entity	Command
Client nodes	<ul style="list-style-type: none"> <li>• REGISTER NODE</li> <li>• UPDATE NODE</li> </ul>
Administrators	<ul style="list-style-type: none"> <li>• REGISTER ADMIN</li> <li>• UPDATE ADMIN</li> </ul>
Servers	<ul style="list-style-type: none"> <li>• DEFINE SERVER</li> <li>• UPDATE SERVER</li> </ul>

Administrators that authenticate by using the DSMADMC command, DSMC command, or dsm program cannot authenticate by using an earlier version after authenticating by using V8.1.2 or later. To resolve authentication issues for administrators, see the following tips:

Tips:

- Ensure that all IBM Spectrum Protect software that the administrator account uses to log on is upgraded to V8.1.2 or later. If an administrator account logs on from multiple systems, ensure that the server's certificate is installed on each system.
- After an administrator authenticates to a V8.1.2 or later server by using a V8.1.2 or later client, the administrator can authenticate only on clients or servers that are using V8.1.2 or later. An administrator command can be issued from any system.
- If necessary, create a separate administrator account to use only with clients and servers that are using V8.1.1 or earlier software.

Enforce the highest level of security for communication with the IBM Spectrum Protect server by ensuring that all nodes, administrators, and servers use STRICT session security. You can use the SELECT command to determine which servers, nodes, and administrators are using TRANSITIONAL session security and should be updated to use STRICT session security.

**Related reference:**

Securing communications  
 SELECT (Perform an SQL query of the database)

## Managing administrators

---

An administrator who has system authority can complete any task with the IBM Spectrum Protect™ server, including assigning authority levels to other administrators. To complete some tasks, you must be granted authority by being assigned one or more authority levels.

### Procedure

---

Complete the following tasks to modify administrator settings.

Task	Procedure
Add an administrator.	<p>To add an administrator, ADMIN1, with system authority and specify a password, complete the following steps:</p> <ol style="list-style-type: none"> <li>Register the administrator and specify Pa\$#\$twO as the password by issuing the following command:           <pre>register admin admin1 Pa\$#\$twO</pre> </li> <li>Grant system authority to the administrator by issuing the following command:           <pre>grant authority admin1 classes=system</pre> </li> </ol>
Change administrative authority.	<p>Change the authority level for an administrator, ADMIN1.</p> <ul style="list-style-type: none"> <li>Grant system authority to the administrator by issuing the following command:           <pre>grant authority admin1 classes=system</pre> </li> <li>Revoke system authority for the administrator by issuing the following command:           <pre>revoke authority admin1 classes=system</pre> </li> </ul>
Remove administrators.	<p>Remove an administrator, ADMIN1, from accessing the IBM Spectrum Protect server by issuing the following command:</p> <pre>remove admin admin1</pre>
Temporarily prevent access to the server.	<p>Lock or unlock an administrator by using the LOCK ADMIN or UNLOCK ADMIN command.</p>

## Changing password requirements

---

You can change the minimum password limit, password length, password expiration, and enable or disable authentication for IBM Spectrum Protect™.

### About this task

---

By enforcing password authentication and managing password restrictions, you protect your data and your servers from potential security risks.

### Procedure

---

Complete the following tasks to change password requirements for IBM Spectrum Protect servers.

Table 1. Authentication tasks for IBM Spectrum Protect servers

Task	Procedure
Set a limit for invalid password attempts.	<ol style="list-style-type: none"> <li>On the Servers page in the Operations Center, select the server.</li> <li>Click Details, and then click the Properties tab.</li> <li>Set the number of invalid attempts in the Invalid sign-on attempt limit field.</li> </ol> <p>The default value at installation is 0.</p>
Set a minimum length for passwords.	<ol style="list-style-type: none"> <li>On the Servers page in the Operations Center, select the server.</li> <li>Click Details and then click the Properties tab.</li> <li>Set the number of characters in the Minimum password length field.</li> </ol>
Set the expiration period for passwords.	<ol style="list-style-type: none"> <li>On the Servers page in the Operations Center, select the server.</li> <li>Click Details and then click the Properties tab.</li> <li>Set the number of days in the Password common expiration field.</li> </ol>
Disable password authentication.	<p>By default, the server automatically uses password authentication. With password authentication, all users must enter a password to access the server.</p> <p>You can disable password authentication only for passwords that authenticate with the server (LOCAL). By disabling password authentication, you increase the security risk for the server.</p>
Set a default authentication method.	<p>Issue the SET DEFAULTAUTHENTICATION command. For example, to use the server as the default authentication method, issue the following command:</p> <pre>set defaultauthentication local</pre> <p>To update one client node to authenticate with the server, include AUTHENTICATION=LOCAL in the UPDATE NODE command:</p> <pre>update node authentication=local</pre>

## Securing IBM Spectrum Protect on the system

Protect the system where the IBM Spectrum Protect™ server runs to prevent unauthorized access.

### Procedure

Ensure that unauthorized users cannot access the directories for the server database and the server instance. Keep the access settings for these directories that you configured during implementation.

- Restricting user access to the server  
Authority levels determine what an administrator can do with the IBM Spectrum Protect server. An administrator with system authority can complete any task with the server. Administrators with policy, storage, or operator authority can complete subsets of tasks.
- Limiting access through port restrictions  
Limit access to the server by applying port restrictions.

### Restricting user access to the server

Authority levels determine what an administrator can do with the IBM Spectrum Protect™ server. An administrator with system authority can complete any task with the server. Administrators with policy, storage, or operator authority can complete subsets of tasks.

## Procedure

1. After you register an administrator by using the REGISTER ADMIN command, use the GRANT AUTHORITY command to set the administrator's authority level. For details about setting and changing authority, see Managing administrators.
2. To control the authority of an administrator to complete some tasks, use the following two server options:
  - a. You can select the authority level that an administrator must have to issue QUERY and SELECT commands with the QUERYAUTH server option. By default, no authority level is required. You can change the requirement to one of the authority levels, including system.
  - b. You can specify that system authority is required for commands that cause the server to write to an external file with the REQSYSAUTHOUTFILE server option. By default, system authority is required for such commands.
3. You can restrict data backup on a client node to only root user IDs or authorized users. For example, to limit backups to the root user ID, issue the REGISTER NODE or UPDATE NODE command and specify the BACKUPINITIATION=root parameter:

```
update node backupinitiation=root
```

## Limiting access through port restrictions

Limit access to the server by applying port restrictions.

### About this task

You might have to restrict access to specific servers, based on your security requirements. The IBM Spectrum Protect™ server can be configured to listen on four TCP/IP ports: two that can be used for either regular TCP/IP protocols or Secure Sockets Layer (SSL)/Transport Layer Security (TLS) protocols and two that can be used only for the SSL/TLS protocol.

## Procedure

You can set the server options to specify the port that you require, as listed in Table 1.

Table 1. Server options and port access

Server option	Port access
TCPPORT	Specifies the port number on which the server TCP/IP communication driver is to wait for requests for client sessions. This port listens for both TCP/IP and SSL-enabled sessions. The default value is 1500.
TCPADMINPORT	Specifies the port number on which the server TCP/IP communication driver is to wait for requests for sessions other than client sessions. This port listens for both TCP/IP and SSL-enabled sessions. The default is the value of TCPPORT.  Use this option to separate administrative client traffic from regular client traffic that uses the TCPPORT and SSLTCPSPORT options.
SSLTCPSPORT	Specifies the SSL TCP/IP port address for a server. This port listens for SSL-enabled sessions only. A default port value is not available.
SSLTCPADMINPORT	Specifies the port address on which the server TCP/IP communication driver waits for requests for SSL-enabled sessions. A default port value is not available.  Use this option to separate administrative client traffic from regular client traffic that uses the TCPSPORT and SSLTCPSPORT options.

## Securing communications

Your data and passwords are more secure when you protect them by using Secure Sockets Layer (SSL) or Transport Layer Security (TLS), a form of SSL.

SSL and TLS are the standard technology for creating encrypted sessions between servers and clients. SSL and TLS provide a secure channel for servers and clients to communicate over open communication paths. With SSL and TLS, the identity of the

server is verified by using digital certificates. Clients, servers, and storage agents that are using IBM Spectrum Protect™ V8.1.2 or later software to communicate are automatically configured to use TLS 1.2.

To improve system performance, use TLS for authentication without encrypting object data. To specify whether the server uses TLS 1.2 for the entire session or only for authentication, see the SSL client option for client-to-server communication, and the SSL parameter in the UPDATE SERVER command for server-to-server communication. If you choose to use TLS to encrypt object data, consider adding more processor resources on the IBM Spectrum Protect server to manage the increased network traffic.

If you authenticate passwords with an LDAP directory server, TLS protects passwords between the IBM Spectrum Protect server and the LDAP server. TLS is required for all LDAP password communications.

- Secure Sockets Layer and Transport Layer Security communication  
The Secure Sockets Layer (SSL) or the Transport Layer Security (TLS) protocol is used to provide transport layer security for a secure connection between IBM Spectrum Protect servers, clients, storage agents, and the Operations Center. If you send data between the server, client, and storage agent, SSL or TLS is used to encrypt the data.
- Configuring storage agents, servers, clients, and the Operations Center to connect to the server by using SSL  
Configure Secure Sockets Layer (SSL) on the IBM Spectrum Protect server, backup-archive client, storage agent, and the Operations Center to ensure that data is encrypted during communication.

## Secure Sockets Layer and Transport Layer Security communication

The Secure Sockets Layer (SSL) or the Transport Layer Security (TLS) protocol is used to provide transport layer security for a secure connection between IBM Spectrum Protect™ servers, clients, storage agents, and the Operations Center. If you send data between the server, client, and storage agent, SSL or TLS is used to encrypt the data.

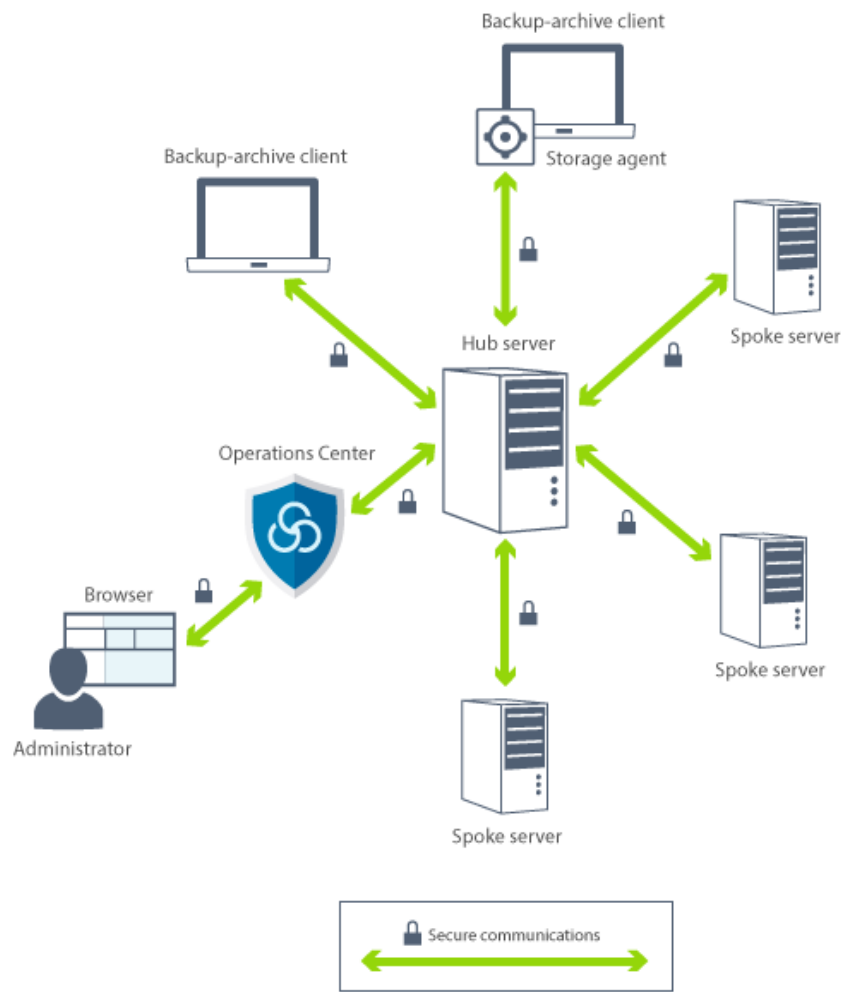

Restriction: Do not use the SSL or TLS protocols for communications with an IBM DB2 database instance that is used by the IBM Spectrum Protect server.



Each server or storage agent has a unique private key and a unique signed certificate that is used to allow SSL connections. If you use self-signed certificates, you must distribute the self-signed certificate for each server or storage agent to all the clients, storage agents, and servers that use TLS to communicate with it. If you use certificates that are signed by a certificate authority (CA), you must distribute only the CA certificates to all the clients, storage agents, and servers that use TLS to communicate.

If you use a root certificate from a CA, you must install it on each key database for the client, server, and storage agent that initiates SSL communication. A *root certificate* is a certificate that identifies the Root Certificate Authority. The certificate is verified by the SSL client or server that requests or initiates the SSL communication.

Beginning with IBM Spectrum Protect Version 8.1.2, SSL is enabled by default for communications among V8.1.2 servers, clients, and storage agents.

The IBM Spectrum Protect server, client, or storage agent can serve as SSL clients during communication. An SSL client is the component that initiates communication and verifies the certificate for an SSL server. For example, if the IBM Spectrum Protect client initiates the SSL communication with the IBM Spectrum Protect server, the IBM Spectrum Protect client is the SSL client and the server is the SSL server.

Table 1 lists the components that can be an SSL client or SSL server.

Table 1. SSL clients and servers in the IBM Spectrum Protect environment

SSL client	SSL server	Scenario
Client	Server	The IBM Spectrum Protect client initiates a communication request with the IBM Spectrum Protect server. The client verifies the certificate. The server provides the certificate.
Server (such as a source server)	Server (such as a target server)	The IBM Spectrum Protect source server initiates a communication request with the IBM Spectrum Protect target server. The source server acts as an SSL client and verifies the certificate that the target server provides.  This type of communication is common during replication processing.
Client through a storage agent	Server	The client verifies each certificate when it initiates SSL communication separately with the IBM Spectrum Protect server and the storage agent.  When the storage agent communicates with the server by using the SSL communication protocol, the storage agent acts as an SSL client and verifies the certificate that the server provides.  The storage agent can be the SSL client and the SSL provider at the same time.
Server	LDAP server	The IBM Spectrum Protect server initiates a communication request with the LDAP server. The IBM Spectrum Protect server acts as the SSL client and verifies the certificate that the LDAP server provides.
Operations Center	Server	The Operations Center initiates a communication request with the IBM Spectrum Protect server. The Operations Center acts as the SSL client and verifies the certificate that the IBM Spectrum Protect server provides.
Reporting	Server	The reporting agent initiates a communication request with the IBM Spectrum Protect server. The Reporting feature acts as the SSL client and verifies the certificate that the IBM Spectrum Protect server provides.

## Configuring storage agents, servers, clients, and the Operations Center to connect to the server by using SSL

Configure Secure Sockets Layer (SSL) on the IBM Spectrum Protect™ server, backup-archive client, storage agent, and the Operations Center to ensure that data is encrypted during communication.

You can use a self-signed SSL certificate or a signed certificate from a third-party certificate authority (CA) to verify an SSL communication request between the server, client, and storage agent. Each IBM Spectrum Protect server, client, or storage agent that enables SSL must use a trusted self-signed certificate or obtain a unique certificate that is signed by a CA.

The benefit of CA-signed certificates is that a single CA-signed certificate can be used for all servers, which allows you to distribute a single certificate to clients. If you use a self-signed certificate, the certificate is automatically created for each server and storage agent. If you use a root certificate from a CA, it must be installed on each key database for the client, server, and

storage agent that initiates SSL communication. The certificate is verified by the SSL client or server that requests or initiates the SSL communication.

Restriction: Some CAs use certificates in a format that is not recognized by IBM Spectrum Protect. You might have to contact your CA to convert the certificate to a format that you can use with IBM Spectrum Protect.

- Configuring the server to accept SSL connections  
Configure the server to accept SSL connections before you enable SSL communication from the server to a client, a storage agent, or another server.
- Configuring a storage agent to use SSL  
To ensure that data is encrypted for communication between the storage agent and the server and the storage agent and the client, configure the storage agents to communicate by using the SSL protocol.
- Configuring the client to connect to a storage agent by using SSL  
To protect the data that is transmitted between a client and storage agent, configure the client to connect to the storage agent by using the SSL protocol.

## Configuring the server to accept SSL connections

---

Configure the server to accept SSL connections before you enable SSL communication from the server to a client, a storage agent, or another server.

### Procedure

---

1. Specify the port on which the server waits for client communications that are enabled for SSL or accept the default port number. Optionally, update the dsmserv.opt file in the server instance directory by specifying the TCPSPORT or TCPADMINPORT options, or both. The SSLTCPSPORT and SSLTCPADMINPORT options can be used for SSL-only connections.
2. Create the server key database by starting the server. The server key database file, cert.kdb, is stored in the server instance directory, and the default certificate label is automatically set as "TSM Server SelfSigned SHA Key". The certificate is exported to the cert256.arm file.
3. If you are using the default self-signed certificate, the default self-signed certificate (cert256.arm) file is needed when you connect to the server by using TLS.
4. If you are importing a CA signed certificate, complete the following steps:
  - a. Import a unique certificate that is signed by a CA on each server that enables SSL. You can import both a root and intermediate CA signed certificate. The same CA-signed certificate is used for each server. Log on to the IBM Spectrum Protect™ server system with the instance user ID and issue the following example command from the instance directory:

```
gsk8capicmd_64 -cert -add -db cert.kdb -stashed -label "CA cert" -file ca.crt
```

- b. To import an intermediate CA signed certificate, issue the following example command:

```
gsk8capicmd_64 -cert -add -db cert.kdb -stashed  
-label "Intermediate CA cert" -file intca.crt
```

- c. The root and intermediate certificates (ca.crt and intca.crt) are needed when you connect the server by using TLS.
- d. On the server, create a certificate request for the CA to sign by issuing a command that is similar to the following example:

```
gsk8capicmd_64 -certreq -create -db cert.kdb -stashed -label "CA cert"  
-sigalg sha256 -size 2048 -ku "digitalSignature,keyEncipherment,keyAgreement"  
-eku "clientAuth,serverAuth" -dn "CN=tucson.example.com,OU=Spectrum Protect,O=IBM"  
-san_dnsname tucson.example.com -san_ipaddr 9.11.0.0 -file cert_request.csr
```

- e. To receive the signed certificate and make it the default for communicating with clients, issue the following example command:

```
gsk8capicmd_64 -cert -receive -db cert.kdb -stashed -file cert_signed.crt  
-default_cert yes
```

5. If you made any changes, restart the server.

### What to do next

---

Enable SSL communication from a client, a storage agent, or another server to this server. To complete the following tasks, you must have the server's certificate and the port number that is defined for the server.

1. To enable SSL communication from a client to this server, see [Configuring IBM Spectrum Protect client/server communication with Secure Sockets Layer](#).
  2. To enable SSL communication from another server to this server, see [Configuring the server to connect to another server by using SSL](#).
  3. To enable SSL communication from a storage agent to this server, see [Configuring a storage agent to use SSL](#).
  4. To enable SSL communication from the Operations Center to this server, see [Configuring the Operations Center to connect to the hub server by using SSL](#).
- **Configuring clients to communicate with the server by using SSL**  
To ensure that data is encrypted during client/server communication, configure clients to communicate with the server by using the SSL protocol.
  - **Configuring the server to connect to another server by using SSL**  
To ensure that data is encrypted for server-to-server communication, configure servers to communicate with servers by using the SSL protocol.
  - **Configuring the Operations Center to connect to the hub server by using SSL**  
To ensure that data is encrypted for communication between the Operations Center and the hub server, configure the Operations Center to communicate with the hub server by using the SSL protocol.

**Related reference:**

TCPPORT

TCPADMINPORT

QUERY SESSION (Query client sessions)

## Configuring clients to communicate with the server by using SSL

---

To ensure that data is encrypted during client/server communication, configure clients to communicate with the server by using the SSL protocol.

### Before you begin

---

You must have the server's certificate and the port number that the server is using. For more information, see [Configuring the server to accept SSL connections](#).

### Procedure

---

To enable SSL communication between the server and clients, see [Configuring IBM Spectrum Protect client/server communication with Secure Sockets Layer](#).

## Configuring the server to connect to another server by using SSL

---

To ensure that data is encrypted for server-to-server communication, configure servers to communicate with servers by using the SSL protocol.

### Before you begin

---

You must have the certificate and the port number for the server that you are connecting to. For more information, see [Configuring the server to accept SSL connections](#).

### About this task

---

**Tip:** If both servers are using IBM Spectrum Protect™ V8.1.2 or later software, SSL is automatically configured. Manual configuration is recommended but not required. If either the server or the storage agent is using IBM Spectrum Protect software earlier than V8.1.2, you must manually configure SSL.

In the procedure, the following server addresses are used as examples:

- ServerA (the server you are connecting to) is at `bfa.tucson.example.com`
- ServerB is at `bf.b.tucson.example.com`

### Procedure

---

1. Create the server key database by starting the server. The server key database file, cert.kdb, is stored in the server instance directory.

2. For each server, import the other server's cert256.arm or CA-certificate files:

```
gsk8capicmd_64 -cert -add -label server_ip_address -db cert.kdb -stashed  
-file cert256.arm
```

Tip: Use the IP address of the server as the label name.

3. From each server, you can view the certificates in the key database by issuing the following command:

```
gsk8capicmd_64 -cert -list -db cert.kdb -stashed
```

4. Restart the servers.

5. Issue the DEFINE SERVER command.

a. For ServerA, issue the following command:

```
DEFINE SERVER BFB hla=bfh.tucson.example.com lla=1542  
serverpa=passwordforbfb SSL=YES
```

b. For ServerB, issue the following command:

```
DEFINE SERVER BFA hla=bfa.tucson.example.com lla=1542  
serverpa=passwordforbfa SSL=YES
```

**Related reference:**

QUERY SESSION (Query client sessions)

TCPPORT

TCPADMINPORT

DEFINE SERVER (Define a server for server-to-server communications)

## Configuring the Operations Center to connect to the hub server by using SSL

---

To ensure that data is encrypted for communication between the Operations Center and the hub server, configure the Operations Center to communicate with the hub server by using the SSL protocol.

### Before you begin

---

You must have the hub server's certificate and the port number that the server is using. For more information, see [Configuring the server to accept SSL connections](#).

### Procedure

---

To configure SSL communications with the Operations Center, see [Securing communications between the Operations Center and the hub server](#).

## Configuring a storage agent to use SSL

---

To ensure that data is encrypted for communication between the storage agent and the server and the storage agent and the client, configure the storage agents to communicate by using the SSL protocol.

### Before you begin

---

You must have the server's certificate and the port number that the server is using. For more information, see [Configuring the server to accept SSL connections](#).

### Procedure

---

1. Initialize the storage agent and add communication information to the device configuration file and the storage agent options file dsmsta.opt by issuing the DSMSTA SETSTORAGESERVER command. You must specify the SSL=YES and STAKEYDBPW=password parameters to create the key database file in dsmsta.opt. All passwords are encrypted in dsmsta.opt.

```
dsmsta setstorageserver myname=storage_agent_name mypa=sta_password  
myhla=ip_address servername=server_name serverpa=server_password hla=ip_address lla=ssl_port  
STAKEYDBPW=password ssl=yes
```

2. Create the key database certificate and default certificates by starting the storage agent.
3. For the storage agent and the server, import the other's cert256.arm or CA-certificate files:

```
gsk8capicmd_64 -cert -add -label ip_address -db cert.kdb -stashed  
-file cert256.arm
```

Tip: Use the IP address as the label name.

4. You can view the certificates in the key database by issuing the following command:

```
gsk8capicmd_64 -cert -list -db cert.kdb -stashed
```

5. Restart the storage agent and the server.
6. Establish communication between the server and the storage agent by issuing the following command:

```
define server sta hla=ip_address lla=port serverpa=password ssl=yes
```

**Related reference:**

QUERY SESSION (Query client sessions)

TCPPORT

TCPADMINPORT

DEFINE SERVER (Define a server for server-to-server communications)

## Configuring the client to connect to a storage agent by using SSL

---

To protect the data that is transmitted between a client and storage agent, configure the client to connect to the storage agent by using the SSL protocol.

### Before you begin

---

You must have the certificate and the port number for the storage agent.

### About this task

---

After you configure a storage agent to accept SSL connections, configure clients to connect to the storage agent by using SSL.

### Procedure

---

To enable SSL communication between the clients and the storage agent, see [Configuring IBM Spectrum Protect client/server communication with Secure Sockets Layer](#).

**Related reference:**

TCPPORT

TCPADMINPORT

## Authenticating IBM Spectrum Protect users by using an LDAP server

---

Within an IBM Spectrum Protect™ system, users must authenticate to the server by providing a user ID and password. If your organization uses a Lightweight Directory Access Protocol (LDAP) server to manage user IDs, you can use the LDAP server to authenticate IBM Spectrum Protect user IDs.

You can use one of the following methods to authenticate users with an LDAP server:

Method that is preferred for IBM Spectrum Protect V7.1.7 and later servers

To use this method, sometimes known as *integrated mode*, user IDs must be registered in an Active Directory database on an LDAP server. Then, you register the same users with the IBM Spectrum Protect server. When a registered user ID accesses the IBM Spectrum Protect server, the credentials are authenticated against the Active Directory database.

To use this method, follow the instructions in [Authenticating users by using an Active Directory database](#).

Method that is used for servers earlier than V7.1.7, and by IBM® Security Directory Server users

To use this method, user IDs must be registered in an Active Directory database on an LDAP server. Alternatively, user IDs can be registered in an IBM Security Directory Server (formerly IBM Tivoli® Directory Server) database on an LDAP server.

With this method, you cannot use the standard user accounts that are registered with the LDAP server. You must create separate user accounts that are associated with a specific organizational unit. To use this method, follow the instructions in *Managing passwords and logon procedures (V7.1.1)*.

- Authenticating users by using an Active Directory database  
You can authenticate IBM Spectrum Protect users by using an Active Directory database on a Lightweight Directory Access Protocol (LDAP) server. With this method, you use the standard user accounts that are registered with the LDAP server. The same user ID can be used to authenticate to the IBM Spectrum Protect server and to the LDAP server.

## Replicating client data to another server

---

Replicating client data from a source server to another server helps to ensure that backed-up client data is available for recovery if the source server is damaged. Replication incrementally copies data from the source server to the target server to provide failover and failback capability.

### About this task

---

If a disaster occurs and the source server is temporarily unavailable, client nodes can recover their data from the target server. If the source server cannot be recovered, you can change client node configurations to store data on the target server. When an outage occurs, the source server can automatically fail over to a target server for data recovery.

Restriction: A server can replicate data to only one target server.

You can replicate data that is stored in any type of storage pool. The storage pool type can be different at the source replication server and the target replication server. You can control replication by type of client node data:

- Active and inactive backup data together, or only active backup data
- Archive data
- Data that was migrated to a source server by IBM Spectrum Protect™ for Space Management clients

When you replicate data in directory-container storage pools, use storage pool protection to improve the efficiency of the replication process, and to enable repair of data. When you use the Operations Center to set up your storage pools, schedules for protection are automatically defined to coordinate with the replication schedule.

### Procedure

---

1. Verify that servers are compatible and have the system resources for successful use of replication.

Increased amounts of memory and processor cores are required. The database and its logs must be sized to ensure that transactions can complete. A dedicated network, with enough bandwidth to handle the amount of data you intend to replicate, is required.

- a. Verify that the source and target servers are compatible for replication. See *Replication compatibility*.
- b. Verify that the server has appropriate resources for good performance. For details, see *Checklist for node replication*.

2. Enable replication. See *Enabling node replication*.
3. Schedule replication for the source server. For information about how to integrate this schedule in regular server maintenance schedules, see *Defining schedules for server maintenance activities*.
4. Schedule storage pool protection for all directory-container storage pools on the source server. See *Protecting data in directory-container storage pools*.
5. Monitor replication by using the Operations Center. For more information, see *Daily monitoring checklist*.

- Replication compatibility  
Before you set up replication operations with IBM Spectrum Protect, you must ensure that the source and target replication servers are compatible for replication.
- Enabling node replication  
You can enable node replication to protect your data.
- Protecting data in directory-container storage pools  
Protect data in directory-container storage pools to reduce node replication time and to enable repair of data in directory-container storage pools.
- Modifying replication settings  
Modify replication settings in the Operations Center. Change settings such as the number of replication sessions, replication rules, the data that you want to replicate, the replication schedule, and the replication workload.
- Setting different retention policies for the source server and target server  
You can set policies on the target replication server that manage the replicated client-node data differently than on the

source server. For example, you can maintain a different number of versions of files on the source and the target servers.

## Replication compatibility

---

Before you set up replication operations with IBM Spectrum Protect™, you must ensure that the source and target replication servers are compatible for replication.

Table 1. Replication compatibility of server versions

Source replication server version	Compatible versions for the target replication server
V6.3.0 - V6.3.2	V6.3.0 - V6.3.2
V6.3.3	V6.3.3 or later V6.3 levels
V6.3.4 or later V6.3 levels	V6.3.4 or later
V7.1	V7.1 or later
V7.1.1	V7.1 or later
V7.1.3	V7.1.3 or later
V7.1.4	V7.1.3 or later
V7.1.5	V7.1.3 or later
V7.1.6	V7.1.3 or later
V7.1.7	V7.1.3 or later
V8.1	V7.1.3 or later
V8.1.1	V7.1.3 or later
V8.1.2	V7.1.3 or later

## Enabling node replication

---

You can enable node replication to protect your data.

### Before you begin

---

Ensure that the source and target servers are compatible for replication.

### About this task

---

Replicate the client node to replicate all client data, including metadata. By default, node replication is disabled when you start the server for the first time.

Tips:

- To reduce replication processing time, protect the storage pool before you replicate client nodes. When node replication is started, the data extents that are already replicated through storage pool protection are skipped.
- Replication requires increased amounts of memory and sufficient bandwidth to complete processing. Size the database and its logs to ensure that transactions can complete.

### Procedure

---

To enable node replication, complete the following steps in the Operations Center:

- a. On the Servers page, click Details.
- b. On the Details page, click Properties.
- c. In the Replication section, select Enabled in the Outbound replication field.
- d. Click Save.

### What to do next

---

Complete the following actions:

1. To verify that replication was successful, review the Daily monitoring checklist.
2. **Linux** If the IBM Spectrum Protect™ server replicates nodes to a remote server, determine whether Aspera® Fast Adaptive Secure Protocol (FASP®) technology can improve data throughput to the remote server. Follow the instructions in Determining whether Aspera FASP technology can optimize data transfer in your system environment.

## Protecting data in directory-container storage pools

---

Protect data in directory-container storage pools to reduce node replication time and to enable repair of data in directory-container storage pools.

### Before you begin

---

Ensure that at least one directory-container storage pool exists on the target replication server. When you enable replication in the Operations Center, you can schedule storage pool protection. To configure replication and enable storage pool protection, complete the following steps:

1. On the Operations Center menu bar, hover over Storage and click Replication.
2. On the Replication page, click Server Pair.
3. Complete the steps in the Add Server Pair wizard.

### About this task

---

Protecting a directory-container storage pool backs up data extents to another storage pool, and can improve performance for node replication. When node replication is started, the data extents that are already backed up through storage pool protection are skipped, which reduces the replication processing time. You can schedule the protection of storage pools several times a day to keep up with changes to data.

By protecting a storage pool, you do not use resources that replicate existing data and metadata, which improves server performance. You must use directory-container storage pools if you want to protect and back up the storage pool only.

Alternative protection strategy: As an alternative to using replication, you can protect data in directory-container storage pools by copying the data to container-copy storage pools. Data in container-copy storage pools is stored on tape volumes. Tape copies that are stored offsite provide additional disaster recovery protection in a replicated environment.

### Procedure

---

1. Alternatively, to enable storage pool protection, you can use the PROTECT STGPOOL command from the source server to back up data extents in a directory-container storage pool. For example, to protect a directory-container storage pool that is named POOL1 issue the following command:

```
protect stgpool pool1
```

As part of the operation of the PROTECT STGPOOL command, damaged extents in the target storage pool are repaired. To be repaired, extents must already be marked as damaged on the target server. For example, an AUDIT CONTAINER command might identify damage in the target storage pool before the PROTECT STGPOOL command is issued.

2. Optional: If damaged extents were repaired in the target storage pool and you protect multiple source storage pools in one target storage pool, complete the following steps to ensure a complete repair:
  - a. Issue the PROTECT STGPOOL command for all source storage pools to repair as much of the damage as possible.
  - b. Issue the PROTECT STGPOOL command again for all source storage pools. For this second operation, use the FORCERECONCILE=YES parameter. This step ensures that any repairs from other source pools are properly recognized for all source storage pools.

### Results

---

If a directory-container storage pool is protected, you can repair the storage pool if damage occurs, by using the REPAIR STGPOOL command.

Restriction: If you replicate client nodes but do not protect the directory-container storage pool, you cannot repair the storage pool.

### What to do next

---



Complete the following actions:

1. To view replication workload status, follow the instructions in the Daily monitoring checklist.
2. **Linux** If the IBM Spectrum Protect™ server replicates nodes to a remote server, determine whether Aspera® Fast Adaptive Secure Protocol (FASP®) technology can improve data throughput to the remote server. Follow the instructions in Determining whether Aspera FASP technology can optimize data transfer in your system environment.

**Related tasks:**

🔗 Copying directory-container storage pools to tape

**Related reference:**

🔗 AUDIT CONTAINER (Verify the consistency of database information for a directory-container storage pool)

🔗 PROTECT STGPOOL (Protect storage pool data)

## Modifying replication settings

Modify replication settings in the Operations Center. Change settings such as the number of replication sessions, replication rules, the data that you want to replicate, the replication schedule, and the replication workload.

### About this task

You might need to customize your replication settings in the following scenarios:

- Changes to data priorities
- Changes to replication rules
- Requirement for a different server to be the target server
- Scheduled processes that negatively affect server performance

### Procedure

Use the Operations Center to modify replication settings.

Task	Procedure
Change a replication rule.	<ol style="list-style-type: none"><li>a. On the Servers page, click Details.</li><li>b. On the Details page, click Properties.</li><li>c. In the Replication section, choose the replication rule that you want to apply: Default archive rule, Default backup rule, or Default space-management rule.</li><li>d. Click Save.</li></ol>
Specify the duration that replication records are retained.	<ol style="list-style-type: none"><li>a. On the Servers page, click Details.</li><li>b. On the Details page, click Properties.</li><li>c. In the Replication section, enter the number of days that replication records must be retained in the Retain replication history field. Alternatively, select the Do not retain check box if you do not require replication records.</li><li>d. Click Save.</li></ol>
Specify a target replication server.	<ol style="list-style-type: none"><li>a. On the Servers page, click Details.</li><li>b. On the Details page, click Properties.</li><li>c. In the Replication section, specify the target server.</li><li>d. Click Save.</li></ol>
Cancel a replication process.	<ol style="list-style-type: none"><li>a. On the Servers page, click Active tasks.</li><li>b. Select the process or session that you want to cancel.</li><li>c. Click Cancel.</li></ol>

## Setting different retention policies for the source server and target server

You can set policies on the target replication server that manage the replicated client-node data differently than on the source server. For example, you can maintain a different number of versions of files on the source and the target servers.

## Procedure

---

1. From the source replication server, validate the replication configuration and verify that the source replication server can communicate with the target replication server by issuing the `VALIDATE REPLICATION` command. For example, validate the configuration by using the name of one client node that is being replicated:

```
validate replication node1 verifyconnection=yes
```

2. From the source replication server, issue the `VALIDATE REPLPOLICY` command to review the differences between the policies on the source and target replication servers. For example, to display the differences between the policies on the source server and the target server, `CVT_SRV2`, issue the following command from the source server:

```
validate replpolicy cvt_srv2
```

3. Update the policies on the target server if necessary.

Tip: You can use the Operations Center to modify the policies on the target server. Follow the instructions in [Editing policies](#).

For example, to maintain inactive versions of files for a shorter time on the target server than on the source server, reduce the Backups setting in the management classes that apply to replicated client data.

4. Enable the target replication server to use its policies to manage the replicated client-node data by issuing the `SET DISSIMILARPOLICIES` command on the source server. For example, to enable the policies on the target replication server, `CVT_SRV2`, issue the following command on the source server:

```
set dissimilarpolicies cvt_srv2 on
```

The next time that the replication process runs, the policies on the target replication server are used to manage the replicated client-node data.

Tip: If you configure replication by using the Operations Center and the policies on the source and target replication servers do not match, the policy that is specified for the source replication server is used. If you enabled the policies on the target replication server by using the `SET DISSIMILARPOLICIES` command, the policy that is specified for the target replication server is used. If the target replication server does not have the policy that is used by the node on the source replication server, the `STANDARD` policy is used.

### Related reference:

[EXPORT POLICY](#) (Export policy information)

[SET DISSIMILARPOLICIES](#) (Enable the policies on the target replication server to manage replicated data)

[VALIDATE REPLICATION](#) (Validate replication for a client node)

[VALIDATE REPLPOLICY](#) (Verify the policies on the target replication server)

AIX

Linux

Windows

## Configuring clustered environments

---

You can configure the IBM Spectrum Protect™ server for clustering on AIX®, Linux, or Windows systems.

You can use a clustered environment for the following operating systems:

- IBM® PowerHA® SystemMirror for AIX
- IBM Tivoli® System Automation for Multiplatforms for AIX and Linux
- Microsoft Failover Cluster for Windows

You can use other cluster products with IBM Spectrum Protect, however, documentation is not available and support is limited. For the latest information about support for clustered environments, see <http://www.ibm.com/support/docview.wss?uid=swg21609772>.

Before you use another cluster product, verify that DB2® supports the required file systems. For more information about the level of DB2 that you are using, see the DB2 product information, and search for recommended file systems.

- [Clustered environment overview](#)  
*Clusters* consist of many components such as IBM Spectrum Protect servers, hardware, and software. You can use clustering to join two or more servers or nodes by using a shared disk system.

- **AIX** Configuring an AIX environment for clustering  
You can configure the IBM Spectrum Protect server for AIX clustered environments by using IBM PowerHA SystemMirror for AIX or IBM Tivoli System Automation for Multiplatforms.
- **Linux** Configuring a Linux environment for clustering  
You can configure the IBM Spectrum Protect Linux server in a clustered environment by using IBM Tivoli System Automation for Multiplatforms Version 3.2.2.
- **Windows** Configuring a Windows clustered environment  
You can configure an IBM Spectrum Protect server for Windows in a Microsoft failover cluster environment. Windows cluster environments consist of components such as IBM Spectrum Protect servers, hardware, and software. When these components are connected to the same disk system, downtime is minimized.

**Related information:**

Upgrading the server in a clustered environment

**AIX** | **Linux** | **Windows**

## Clustered environment overview

---

*Clusters* consist of many components such as IBM Spectrum Protect™ servers, hardware, and software. You can use clustering to join two or more servers or nodes by using a shared disk system.

This configuration provides the nodes with the ability to share data, which allows higher server availability and minimized downtime. For example:

- You can configure, monitor, and control applications and hardware components that are deployed on a cluster.
- You can use an administrative cluster interface and IBM Spectrum Protect to designate cluster arrangements and define a failover pattern. The server is part of the cluster that provides an extra level of security by ensuring that no transactions are missed because a server failed. The failover pattern that you establish prevents future failures.
- You can apply clustering to the node replication process. In this way, server availability is higher than it would be if node replication is used as a process on its own. Server availability is higher because a client is less likely to fail over to another server in a clustered environment. If you replicate data from several source replication servers to one target replication server, there is a high dependency on the target replication server. A clustered environment eases the dependency on the target replication server.

Components in a server cluster are known as *cluster objects*. Cluster objects are associated with a set of properties that have data values that describe the identity and behavior of an object in the cluster. Cluster objects can include the following components:

- Nodes
- Storage
- Services and applications
- Networks

You manage cluster objects by manipulating their properties, typically through a cluster management application.

- Cluster nodes  
Nodes in a cluster all have similar characteristics, which allows them to work together.

**AIX**

## Configuring an AIX environment for clustering

---

You can configure the IBM Spectrum Protect™ server for AIX® clustered environments by using IBM® PowerHA® SystemMirror for AIX or IBM Tivoli® System Automation for Multiplatforms.

PowerHA SystemMirror for AIX and Tivoli System Automation detect system failures and manage failover to a recovery processor with a minimal loss of user time. You can set up the IBM Spectrum Protect server on a system in a PowerHA or a Tivoli System Automation cluster. Then, if the system fails, the IBM Spectrum Protect server can be started on another system in the cluster.

In both failover and failback, it seems that the IBM Spectrum Protect server halted and is then restarted. Any transactions that were in progress at the time of the failover or failback are rolled back, and all completed transactions are still complete. IBM Spectrum Protect clients see failover or failback as a communications failure and try to reestablish their connections.

See the following information for details about these clustering options.

- Configure IBM Spectrum Protect for AIX to use IBM PowerHA SystemMirror for AIX in a clustered environment by reviewing the following topics.
- Configure IBM Spectrum Protect for AIX to use Tivoli System Automation in a clustered environment by reviewing the information in <http://www.ibm.com/support/docview.wss?uid=swg27039780>.
- Learn more about PowerHA SystemMirror® product information.
- **AIX** Requirements for a PowerHA cluster  
IBM PowerHA SystemMirror for AIX detects system failures and manages failover to a recovery processor with a minimal loss of user time.
- **AIX** PowerHA failover and fallback  
If a node fails, the server cluster transfers the groups that were being hosted by the node to other nodes in the cluster. This transfer process is called *failover*. The reverse process, *fallback*, occurs when the failed node becomes active again and the groups that were failed over to the other nodes are transferred back to the original node.
- **AIX** Installing and configuring PowerHA SystemMirror for AIX  
You can configure the IBM Spectrum Protect server for AIX clustered environments by using IBM PowerHA SystemMirror for AIX.
- **AIX** Installing the IBM Spectrum Protect server on a production node for PowerHA  
Install the IBM Spectrum Protect server on a production node for PowerHA to be able to configure the server for clustering.
- **AIX** Installing the IBM Spectrum Protect client on a production node for PowerHA  
You need to install only the backup-archive client file set, which contains the backup-archive client files and the administrative command-line client.
- **AIX** Verifying the configuration of the IBM Spectrum Protect server for PowerHA  
When you configure the IBM Spectrum Protect server to use PowerHA, you must verify the configuration.
- **AIX** Setting up the standby node for PowerHA  
For PowerHA, ensure that the IBM Spectrum Protect server is not running on the production node before you set up the standby node.
- **AIX** Defining the removable media storage devices to AIX for PowerHA  
For an AIX operating system, you must define the removable-media storage devices that are used by IBM Spectrum Protect on the production and standby nodes. The library manager validates that the cartridge that contains the removable-media storage device is in the correct drive.
- **AIX** Completing the cluster manager and IBM Spectrum Protect configurations  
Update the cluster manager configuration to define the IBM Spectrum Protect server as an application and a failover resource of the standby node. This application is owned by the production node.
- **AIX** Troubleshooting the PowerHA clustered environment  
Review the following list for information about troubleshooting common problems. The information that is provided for IBM PowerHA SystemMirror for AIX does not represent all possible scenarios.

**AIX**

## Requirements for a PowerHA cluster

---

IBM PowerHA® SystemMirror for AIX® detects system failures and manages failover to a recovery processor with a minimal loss of user time.

The following hardware requirements are for configuring the IBM Spectrum Protect™ server:

- A hardware configuration that is suitable for PowerHA. The removable media storage devices for the IBM Spectrum Protect server must be physically connected to at least two nodes of the PowerHA cluster on a shared bus (including a SAN).
- Sufficient shared disk space to hold the IBM Spectrum Protect database, recovery logs, instance directory, and disk storage pools to be used. See [Managing inventory capacity](#) to determine how much space is required for the database and recovery log and to ensure the availability of the database and recovery log.
- A TCP/IP network.

Tip: If an IBM Spectrum Protect server manages removable media storage devices, you can configure two IBM Spectrum Protect servers to run on different systems in an PowerHA cluster. Either system can run both servers if the other system fails. To configure two IBM Spectrum Protect servers to run on different systems in an PowerHA cluster, use another file system that is accessible to both servers.

**AIX**

## PowerHA failover and fallback

---

If a node fails, the server cluster transfers the groups that were being hosted by the node to other nodes in the cluster. This transfer process is called *failover*. The reverse process, *failback*, occurs when the failed node becomes active again and the groups that were failed over to the other nodes are transferred back to the original node.

The terms *production node* and *standby node* refer to the two PowerHA® nodes on which the IBM Spectrum Protect™ server runs.

PowerHA manages taking over the TCP/IP address and mounting the shared file system on the standby node or production node, as appropriate.

When a *failover* or *failback* occurs, any transactions that were being processed at the time are rolled back. To IBM Spectrum Protect clients, *failover* or *failback* represents a communications failure. Therefore, you must reestablish a connection that is based on their COMMRESTARTDURATION and COMMRESTARTINTERVAL option settings.

Typically, you can restart the backup-archive client from the last committed transaction. If a client schedule is running when a *failover* occurs, the client operation is likely to fail. If you can restart client operations, then you must restart them from the beginning of the processing. The clients and agent operations complete as they normally do if the server was halted and restarted while they were connected. The only difference is that the server is physically restarted on different hardware.

If you do not want automatic *failback* to occur, you can configure the resource as a cascading resource group without *failback*.

#### Related information:

[PowerHA SystemMirror product information](#)

## Installing and configuring PowerHA SystemMirror for AIX

You can configure the IBM Spectrum Protect™ server for AIX® clustered environments by using IBM® PowerHA® SystemMirror® for AIX.

- **AIX** Installing and configuring the PowerHA cluster  
You might experience processing errors if your IBM PowerHA SystemMirror for AIX installation and configuration are not done correctly.
- **AIX** Configuring IBM Spectrum Protect server on the primary node for PowerHA  
You can configure an IBM Spectrum Protect server instance on the primary node.
- **AIX** Configuring IBM Spectrum Protect server on a secondary node for PowerHA with a shared DB2 instance  
If the DB2® instance directory is shared between the nodes in the PowerHA cluster, you do not need to create a DB2 instance on the secondary node. You do not run the dsmdir wizard.
- **AIX** Configuring IBM Spectrum Protect server on a secondary node for PowerHA with a separate DB2 instance  
You must create a DB2 instance on each secondary node if the DB2 instance directory, /home/tsminst1/sqllib, is not shared between the nodes in the PowerHA cluster.

**AIX**

## Installing and configuring the PowerHA cluster

You might experience processing errors if your IBM PowerHA® SystemMirror for AIX® installation and configuration are not done correctly.

### Procedure

Complete the following steps to install and configure the PowerHA cluster:

1. Define the shared file systems and logical volumes when they are needed. You might want to put files in separate file systems or on separate physical disks for integrity or performance reasons. Do not put the home directory of the user instance on a shared disk. Mirror the logical volumes to provide maximum availability (including the underlying file systems). The file systems that must be defined include the IBM Spectrum Protect™ server instance directory, the database and log directories, all disk storage pool directories, and FILE device type storage pool directories.
2. Configure PowerHA so that the production node owns the shared volume groups and the standby node takes over the shared volume groups if the production node fails.
3. Configure PowerHA so that the file systems also fail over.
4. Set up a Service IP address for the IBM Spectrum Protect server. The Service IP address must be different from each host IP address. The Service IP is moved from host to host, not the actual host IP address.
5. Failover the shared database and the log and instance directories to the standby node of the PowerHA cluster.

## Results

You must configure the removable media storage devices for failover and define the IBM Spectrum Protect server as an application to PowerHA.

AIX

## Configuring IBM Spectrum Protect server on the primary node for PowerHA

You can configure an IBM Spectrum Protect™ server instance on the primary node.

### Procedure

1. Review the topics in the configuring the IBM Spectrum Protect server information.
2. After you configure the IBM Spectrum Protect server instance on the primary node, you can configure the IBM Spectrum Protect server on a secondary node.

#### Related tasks:

Configuring the IBM Spectrum Protect server instance

AIX

## Configuring IBM Spectrum Protect server on a secondary node for PowerHA with a shared DB2 instance

If the DB2® instance directory is shared between the nodes in the PowerHA® cluster, you do not need to create a DB2 instance on the secondary node. You do not run the dsmsicfx wizard.

### Procedure

To configure a server instance on the secondary node with a shared DB2 instance, complete the following steps:

1. On each node in the cluster, add the following text to the `/opt/tivoli/tsm/server/bin/rc.dsmserv` script:

```
DB2NODES_TEMP='/tmp/db2nodes.tmp'
DB2NODES=${homeDir}/sqllib/db2nodes.cfg
# Current hostname
HOSTNAME=$(/bin/hostname)
# hostname saved in db2nodes.cfg
DB2_HOST=$(cat $DB2NODES | cut -d ' ' -f 2)
# if they are different update the file
if [[ "$HOSTNAME" != "$DB2_HOST" ]]
then
  echo "Updating hostname in db2nodes.cfg"
  sed -e s_${DB2_HOST}_${HOSTNAME}_g $DB2NODES > $DB2NODES_TEMP
  cp $DB2NODES_TEMP $DB2NODES
fi
```

Tip: If the text is not included in the script, you can include it before you issue `/opt/tivoli/tsm/server/bin/rc.dsmserv` script.

2. Move all the shared resources to the secondary node.
3. Update the following variables in the `/opt/tivoli/tsm/server/bin/startserver` script, by using the following values:

Table 1. Variables in the `/opt/tivoli/tsm/server/bin/startserver` script

Description	Variable	Example
Set the INST_USER to the instance user ID.	INST_USER	INST_USER='tsmuser1'
Set the INST_DIR to the location of the IBM Spectrum Protect™ instance directory. This directory contains dsmserv.dbid and dsmserv.opt.	INST_DIR	INST_DIR='/home/tsmuser1/tsminst1'

Description	Variable	Example
<p>Select one of the following startup options:</p> <p>Option 1 - use instance:</p> <p>\$INST_USER but run the server as root (-U)</p> <p>Option 2 - use instance:</p> <p>\$INST_USER and run the server as \$INST_USER (-u)</p>	INST_OPTION	<p>Option 1:</p> <p>INST_OPTION='-U \$INST_USER'</p> <p>Option 2:</p> <p>INST_OPTION='-u \$INST_USER'</p>

4. Start the server by issuing the following script:

```
/opt/tivoli/tsm/server/bin/startserver
```

5. When the server is started, issue the BACKUP DB command to verify that the data is successfully backed up.

AIX

## Configuring IBM Spectrum Protect server on a secondary node for PowerHA with a separate DB2 instance

You must create a DB2® instance on each secondary node if the DB2 instance directory, /home/tsminst1/sqllib, is not shared between the nodes in the PowerHA® cluster.

### About this task

You can configure the IBM Spectrum Protect™ server on a secondary node by using the dsomicfgx wizard or manually.

### Procedure

- To create a DB2 instance on a secondary node by using the dsomicfgx wizard, complete the following steps:
  - Run the dsomicfgx wizard.
  - From the Instance Directory panel, select the Check this if you are configuring the server instance on a secondary node of a high availability cluster check box.
- To create a DB2 instance on a secondary node manually, complete the following steps:
  - Move all the shared resources to the secondary node.
  - Create a DB2 instance by issuing the following db2icrt command:

```
/opt/tivoli/tsm/db2/instance/db2icrt -s ese -u instance_user instance_user
```

where *instance\_user* is the same user that owns the DB2 instance on the primary node.

3. When the DB2 instance is created, log in as the instance user or by issuing the su command:

```
su - <instance_user>
```

4. As the instance user, issue the following commands:

```
db2start
db2 update dbm cfg using DFTDBPATH shared_db_path
db2 catalog db TSMDB1
db2stop
```

where *shared\_db\_path* is the shared database directory. The shared database directory is typically the server instance directory.

Tip: To determine the *shared\_db\_path* value, issue the following command on the primary node:

```
db2 get dbm cfg | grep DFTDBPATH
```

5. Update the following variables in the /opt/tivoli/tsm/server/bin/startserver script, by using the following values:

Table 1. Variables in the /opt/tivoli/tsm/server/bin/startserver script

Description	Variable	Example
Set the INST_USER to the instance user ID.	INST_USER	INST_USER='tsmuser1'
Set the INST_DIR to the location of the IBM Spectrum Protect instance directory. This directory contains dsmserv.dbid and dsmserv.opt.	INST_DIR	INST_DIR='/home/tsmuser1/tsminst1'
Select one of the following startup options:  Option 1 - use instance:  \$INST_USER but run the server as root (-U)  Option 2 - use instance:  \$INST_USER and run the server as \$INST_USER (-u)	INST_OPTION	Option 1:  INST_OPTION='-U \$INST_USER'  Option 2:  INST_OPTION='-u \$INST_USER'

6. Start the server by issuing the following script:

```
/opt/tivoli/tsm/server/bin/startserver
```

7. When the server is started, issue the BACKUP DB command to verify that the data is successfully backed up.

AIX

## Installing the IBM Spectrum Protect server on a production node for PowerHA

Install the IBM Spectrum Protect™ server on a production node for PowerHA® to be able to configure the server for clustering.

### Procedure

Complete the following steps to install the IBM Spectrum Protect server on the production node:

1. Install IBM Spectrum Protect. Select one of the following components:
  - o The IBM Spectrum Protect server
  - o The IBM Spectrum Protect device driver, if needed
  - o The IBM Spectrum Protect license

The executable files are typically installed on the internal disks of the production node, not on the shared IBM Spectrum Protect disk space. IBM Spectrum Protect server executable files are installed in the /opt/tivoli/tsm/server/bin directory.

2. Configure IBM Spectrum Protect to use the TCP/IP communication method. For instructions, see the information about configuring a server instance in AIX: Taking the first steps after you install IBM Spectrum Protect.
3. Define a new user ID that owns the IBM Spectrum Protect server instance or use an existing user ID that does not already own an IBM Spectrum Protect instance. While logged in to the instance user ID, complete the following steps:
  - a. Create an instance directory by using the mkdir command on a shared file system that can fail over to the standby system. This disk must be defined to PowerHA.
  - b. Create the database and log directories by using the mkdir command on shared file systems that can fail over to the standby system. These disks must also be defined to PowerHA to fail over.
  - c. Complete the configuration by using the dsomicfgx wizard.

#### Related tasks:

AIX: Installing the server

Upgrading the server

AIX

## Installing the IBM Spectrum Protect client on a production node for PowerHA

You need to install only the backup-archive client file set, which contains the backup-archive client files and the administrative command-line client.



## Procedure

---

For detailed instructions on installing the IBM Spectrum Protect™ client, see Installing the IBM Spectrum Protect backup-archive clients.

Complete the following steps to install the IBM Spectrum Protect client on the production node.

1. Install the IBM Spectrum Protect client executable files in the `/usr/tivoli/tsm/client/ba/bin` directory. These files are typically installed on the internal disks of the production node.
2. For the client to find the server, ensure that the client options file, `dsm.sys`, points to the IBM Spectrum Protect server. The server name in `dsm.sys` is used only on the `-servername` parameter of the `dsmadm` command to specify the server to be contacted.

AIX

## Verifying the configuration of the IBM Spectrum Protect server for PowerHA

---

When you configure the IBM Spectrum Protect™ server to use PowerHA®, you must verify the configuration.

### About this task

---

When you use PowerHA, all database, log, storage, and instance directories must be on shared disks that are configured to fail over by PowerHA.

## Procedure

---

To identify the directories that are on shared disk, complete the following steps:

1. Log on as the instance user.
2. Run the `/opt/tivoli/tsm/server/bin/dsmclustfs` script.
3. Examine the file systems that are reported by the script and verify that they are on shared disks. The following example script shows the type of information that you must review:

```
> su - tsminst1
$ /opt/tivoli/tsm/server/bin/dsmclustfs
SQL1026N The database manager is already active.
```

The following database connection information is displayed when the IBM Spectrum Protect server connects to the DB2® database:

```
DB20000I The START DATABASE MANAGER command completed successfully.
```

```
Database Connection Information
```

```
Database server          = DB2/AIX64 11.1.0
SQL authorization ID     = TSMINST1
Local database alias     = TSMDB1
```

```
File systems for the DB2 database: /TSMdbspace2 /TSMdbspace1
File system for Active Log: /TSMalog
File system for Archive Log: /TSMarchlog
Active log mirror not defined for this database
```

The following mandatory DB2 file systems are in the script:

```
/TSMdb-1 /TSMalog-1 /TSMarchlog-1
```

```
Checking existing TSM disk-based volumes...
TSM Data is stored in the following file systems: /TSMdisk-1 /TSMfile-1
```

AIX

## Setting up the standby node for PowerHA

---

For PowerHA®, ensure that the IBM Spectrum Protect™ server is not running on the production node before you set up the standby node.

## Procedure

---

Complete the following steps to set up the standby node:

1. On the standby node, open the shared volume group and any IBM Spectrum Protect file systems.
2. On the standby node, install the IBM Spectrum Protect product code. For more information, see [Installing the IBM Spectrum Protect server on a production node for PowerHA](#). If the executable files are installed on shared disk space, you might need to install them on the standby node. IBM Spectrum Protect device drivers, SMIT panels, and other files must be installed in AIX® system directories.
3. Open the `dsmicfgx` wizard. Follow the instructions to complete the configuration. Select the check box to indicate that this item is a secondary node in the cluster.
4. Start the server on the standby node. Query the database, recovery log, and storage pool volumes to verify that they are the same as when the server was started on the production node.
5. Install the client on the standby node. If the executable files are installed on shared disk space, you might need to install them on the standby node. IBM Spectrum Protect SMIT panels and other files must be installed in AIX system directories. Use the AIX RCP command with the `-p` option to copy the `dsm.sys` file from the production node to the standby node. If the `dsm.sys` file is changed on one node, it must be copied to the other node.

## Results

---

Tip: If the `dsm.sys` file is changed on one node, you must copy it to the other node.

AIX

## Defining the removable media storage devices to AIX for PowerHA

---

For an AIX® operating system, you must define the removable-media storage devices that are used by IBM Spectrum Protect™ on the production and standby nodes. The library manager validates that the cartridge that contains the removable-media storage device is in the correct drive.

## About this task

---

Prerequisite:

- If you define a library manager server that is not shared with the IBM Spectrum Protect server, ensure that the `RESETDRIVES` parameter for the `DEFINE LIBRARY` command or the `UPDATE LIBRARY` command is specified as `YES`. If you define a library manager server that is shared with the IBM Spectrum Protect server, the `SANDISCOVERY` option must be set to `ON` in the IBM Spectrum Protect server option file `dsm serv.opt`. By default, this option is set to `OFF`.
- You can issue the `PERFORM LIBACTION` command from SCSI and VTL library types. Use this command to define the drives and paths for a library in one step.

If your SAN device mapping is accurate, continue to the [Completing the cluster manager and IBM Spectrum Protect configurations](#) section. If the device names on the primary and secondary systems are not the same, you must use SAN discovery so that the IBM Spectrum Protect server can access the devices.

### Related tasks:

[Configuring library sharing \(V7.1.1\)](#)

### Related reference:

`DEFINE LIBRARY` (Define a library)

`UPDATE LIBRARY` (Update a library)

`PERFORM LIBACTION` (Define or delete all drives and paths for a library)

`SANDISCOVERY`

### Related information:

[IBM Spectrum Protect Supported Devices](#)

AIX

## Completing the cluster manager and IBM Spectrum Protect configurations

---

Update the cluster manager configuration to define the IBM Spectrum Protect™ server as an application and a failover resource of the standby node. This application is owned by the production node.

## About this task

---

You can issue IBM® PowerHA® SystemMirror for AIX® or Tivoli® System Automation commands to set up the cluster. Continue with configuring the IBM Spectrum Protect server.

### Related information:

[PowerHA SystemMirror product information](#)

[IBM Tivoli System Automation for Multiplatforms Version 3.2.2 product information](#)

AIX

## Troubleshooting the PowerHA clustered environment

---

Review the following list for information about troubleshooting common problems. The information that is provided for IBM® PowerHA® SystemMirror for AIX® does not represent all possible scenarios.

Warning messages that are issued after you run the `clverify` utility

You can run the PowerHA cluster verification utility, `clverify`, on one node to verify the cluster configuration and the assignment on the PowerHA resources. If you run the `clverify` utility after you define the IBM Spectrum Protect™ server as a PowerHA application, warning messages are issued.

Warning messages display because the shell scripts that start and stop the IBM Spectrum Protect servers are in a shared file system. The shell scripts can be run only on one node at a time. Therefore, the shell scripts can be available on only one node at a time. You can ignore the `clverify` utility warning messages. If a shared file system cannot be mounted, the IBM Spectrum Protect server cannot be started.

IBM Spectrum Protect server fails to start after you issue the `startserver` script

If you use the `startserver` shell script and PowerHA fails to start the IBM Spectrum Protect server, start it manually on a terminal without the quiet option. If you want to run the server with the quiet option, issue the `dsmserv -q` command.

Messages that are associated with the `tctl` command

If you issue the `tctl -f/dev/rmt2` rewind command, the following message might be displayed:

```
/dev/rmt2: A device is already mounted or cannot be unmounted
```

This message means that the I/O device is locked with a SCSI RESERVE by a system other than the one on which the `tctl` command was run. If you are using persistent reservation, the IBM Spectrum Protect server preempts a drive reservation by default. If the device driver does not use persistent reservation, the server completes a target reset.

ANS4329S Server out of data storage space message

If the ANS4329S Server out of data storage space message is displayed on an IBM Spectrum Protect client, the license for the IBM Spectrum Protect server might be non-compliant. Issue the `QUERY LICENSE` command to display the compliance information for the license. If the compliance state is valid, use the `QUERY ACTLOG` command on the server and review the messages that are displayed to identify the problem.

Linux

## Configuring a Linux environment for clustering

---

You can configure the IBM Spectrum Protect™ Linux server in a clustered environment by using IBM® Tivoli® System Automation for Multiplatforms Version 3.2.2.

- **Linux** Overview of a two-node IBM Spectrum Protect cluster using Tivoli System Automation  
Use the Tivoli System Automation cluster for higher server and database availability during a failure. By using the Tivoli System Automation failover function, server components such as the database can automatically recover from a failure.
- **Linux** Setting up an IBM Spectrum Protect cluster with Tivoli System Automation  
You must set up the IBM Spectrum Protect cluster to use Tivoli System Automation.
- **Linux** Prerequisites to configuring a Linux clustered environment with Tivoli System Automation  
Before you install and configure IBM Spectrum Protect in a clustered environment with Tivoli System Automation, you must check the prerequisites.
- **Linux** Installing and configuring IBM Spectrum Protect components on the primary and secondary nodes  
You must install the IBM Spectrum Protect server and database components on the primary and secondary nodes in the cluster. Then, configure the primary node first followed by the secondary node.

- **Linux** Installing Tivoli System Automation on the primary and secondary nodes  
After you install and configure IBM Spectrum Protect on the primary and secondary nodes in the cluster, you must install and configure Tivoli System Automation on these nodes. Then, you must activate these nodes for the domain, configure the resources, and activate the base policy. Finally, you must add the mount points to the IBM Spectrum Protect directories.
- **Linux** Configuring storage resources  
Use the Tivoli System Automation user interface or command line to add or delete storage resources and to delete mount points that are no longer required. If you add a storage pool to the cluster, you must add it to the resource group. If you remove a storage pool from the cluster, you must also delete it from the resource group.
- **Linux** Upgrading a server that is configured with Tivoli System Automation  
You can upgrade a server that is configured with Tivoli System Automation from Version 6.3 or Version 7.1.

**Linux**

## Overview of a two-node IBM Spectrum Protect cluster using Tivoli System Automation

---

Use the Tivoli® System Automation cluster for higher server and database availability during a failure. By using the Tivoli System Automation failover function, server components such as the database can automatically recover from a failure.

The IBM Spectrum Protect™ server and the DB2® database are the underlying server components for this two-node cluster. The server is the core component. It is responsible for client and server activity. The DB2 database is an internal component, which is installed as part of the server. The server controls all database activity such as startup and shutdown. When the server detects a server or database component failure, it tries to restart the database. If the restart fails, the server and database are automatically shut down on the primary node and Tivoli System Automation automatically starts these components on the secondary node. Because the IBM Spectrum Protect functions are restored immediately, server and database availability is higher.

Figure 1. The failover function. The server and database components fail on the primary node. Tivoli System Automation starts these components on the secondary node.

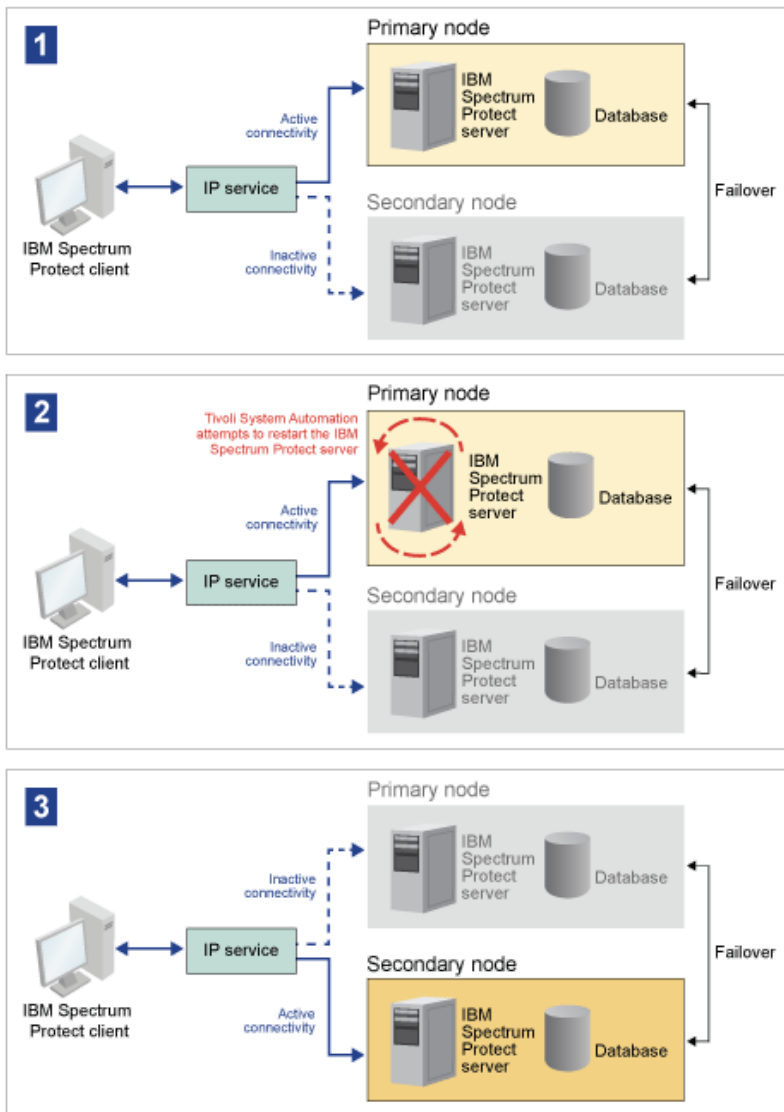

The server and the database include the following log directories, which are used for storage:

- IBM Spectrum Protect instance directory
- Active log directory
- Archive log directory
- Database directory

The two nodes in this Tivoli System Automation cluster are configured to access highly available shared storage that protects the data. For example, a two-node topology includes a primary node and a secondary node. These nodes are on separate physical systems but they can access the same data by using the shared storage array.

Figure 2. Multiple IBM Spectrum Protect server instances on separate nodes. These server instances are on separate physical systems. These instances can access the highly available shared storage.

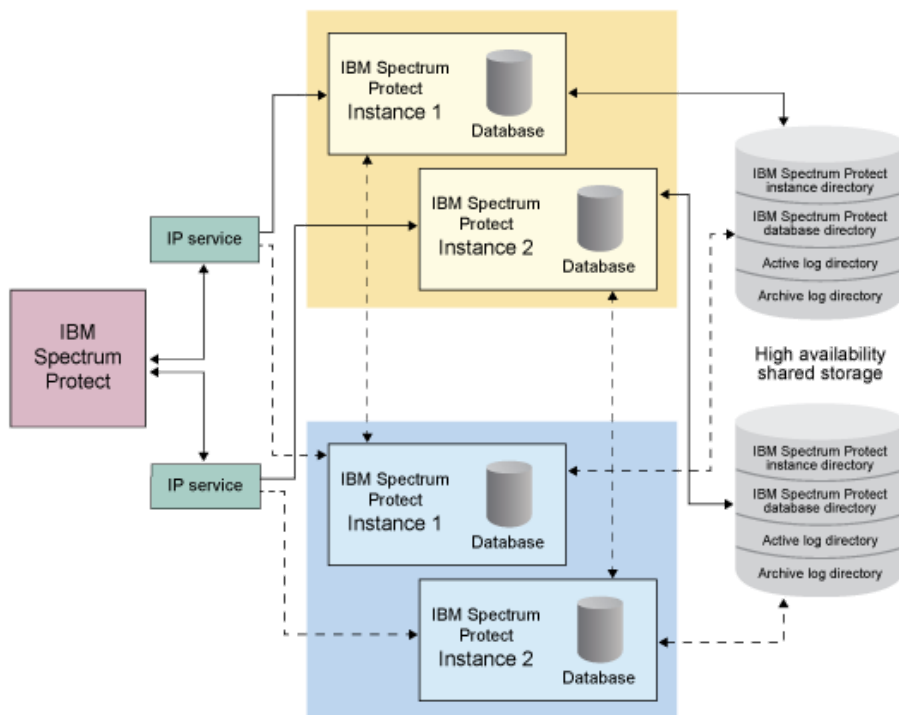

- Linux Two-node shared disk topology  
 This cluster uses a two-node shared disk topology. It includes a primary and secondary node. The primary node hosts the IBM Spectrum Protect server, database, IBM Spectrum Protect instance, and the data. The secondary node is where the IBM Spectrum Protect resources are moved to if a failure occurs.
- Linux Tivoli System Automation resource groups  
 Use Tivoli System Automation resources groups with defined automation policies to manage the IBM Spectrum Protect components for this cluster. The only exception is the database server instance resource that is managed by the IBM Spectrum Protect server.

Linux

## Two-node shared disk topology

This cluster uses a two-node shared disk topology. It includes a primary and secondary node. The primary node hosts the IBM Spectrum Protect™ server, database, IBM Spectrum Protect instance, and the data. The secondary node is where the IBM Spectrum Protect resources are moved to if a failure occurs.

The two nodes in this cluster are connected to each other over a single public network and wired to a *shared disk storage* system, which is always available. *Shared disk storage* is where one or more disks are available to both the primary and secondary nodes. These disks are only mounted to one node, the primary node, at any one time. One node can input and output data to the shared storage disks. The following illustration shows a two-node shared topology where automatic failover to the secondary node occurs in the instance of a failure.

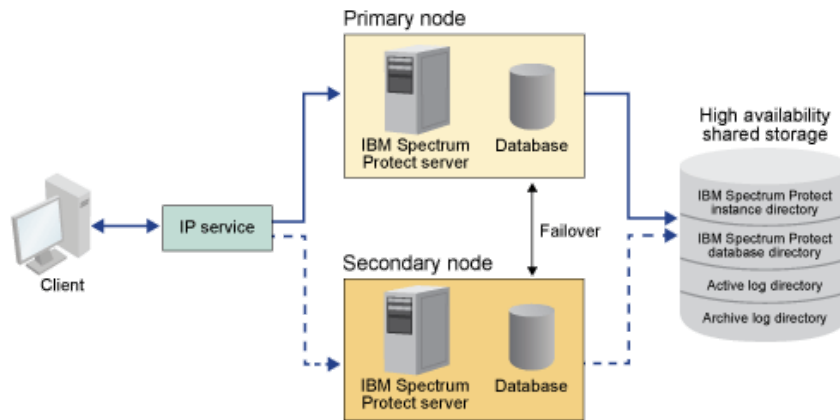

Linux

## Tivoli System Automation resource groups

Use Tivoli® System Automation resources groups with defined automation policies to manage the IBM Spectrum Protect™ components for this cluster. The only exception is the database server instance resource that is managed by the IBM Spectrum Protect server.

The shared file systems and IBM Spectrum Protect components are defined as resources. Multiple resources make up a resource group. Each resource in a resource group has a resource type. Each IBM Spectrum Protect instance in a cluster includes one resource group. During planned outages, resource groups can be manually moved from the primary node to the secondary node.

The IBM Spectrum Protect resource group includes the following resources. The name of the IBM Spectrum Protect resource group is SA-tsm-inst1-rg, where inst1 is the instance name. The following resources are used for different but mandatory functions in this cluster.

### Service IP

The Service IP resource is used for communication. It is called tsm-inst1-ip-rs, where inst1 is the instance name. Service IP is managed by Tivoli System Automation. This IP is available on the node where the IBM Spectrum Protect server is running. You must create the Service IP logical interface on the same physical interface as the public network interface.

### Shared disk storage resource

A *shared disk storage* resource is a physical storage device on the IBM Spectrum Protect server where IBM Spectrum Protect and DB2® application data is stored. You must create the following disk storage resources:

- Instance directory - tsm-inst1-instdir-ag
- DB2 directory - tsm-inst1-db2dir-ag
- Active log directory - tsm-inst1-actlog-ag
- Archive log directory - tsm-inst1-archlog-ag

### Shared disk storage for storage pools

The storage pool resource includes physical storage devices on the IBM Spectrum Protect server where client data is stored.

### Volume group resources

If you decide to configure your storage by using volume groups, a volume group resource is available for the preceding *shared disk storage* resources. Volume group resources are automatically created by Tivoli System Automation.

### Application resources for the IBM Spectrum Protect server instance

The IBM Spectrum Protect server instance resource is the server resource that manages the IBM Spectrum Protect application. This resource is managed by Tivoli System Automation control scripts.

Table 1. Tasks that are completed by the Tivoli System Automation control scripts

Tasks	Description	Sample commands
Start	Starts the IBM Spectrum Protect server instance.	The <code>/opt/tivoli/tsm/server/bin/rc.dsmserv -u db2inst1 -i /tsminst1</code> command starts the server instance with the db2inst1 user in the /tsminst1 directory.
Stop	Stops the IBM Spectrum Protect server instance.	<code>kill -s SIGURG 345</code> where 345 is the <i>PID</i> . The <i>PID</i> can be found in the /tsminst1/dsmserv.v6lock file.
Monitor	Checks whether the /tsminst1/dsmserv.v6lock file exists. It uses the <i>PID</i> to check whether the process is running.	<code>ps -ef   grep 345</code> where 345 is the <i>PID</i> .

- Linux Resource group dependencies  
 Resource group dependencies are automatically created to control the order in which resources are started. These dependencies also control which resources must be restarted or shut down when the specific resource that these resources depend on fails.

Linux

## Setting up an IBM Spectrum Protect cluster with Tivoli System Automation

You must set up the IBM Spectrum Protect™ cluster to use Tivoli® System Automation.

### Procedure

1. Install and configure the IBM Spectrum Protect components on the primary and secondary nodes.
2. Install Tivoli System Automation on the primary and secondary nodes.
3. Configure the storage resources.
4. Depending on the IBM Spectrum Protect version that is installed on the server, you might have to upgrade the IBM Spectrum Protect server for the Tivoli System Automation cluster.
5. Optional: You can set the `FILE_EXIT` variable in the `tsmservctrl` cluster script to route the Tivoli System Automation event data to the IBM Spectrum Protect server FILEEXIT file.  
 For example, edit the `tsmservctrl` cluster script in the `<server_install_directory>/tsam/controls` directory and add the following line:

```
FILE_EXIT="fileexittmp"
```

Linux

## Prerequisites to configuring a Linux clustered environment with Tivoli System Automation

Before you install and configure IBM Spectrum Protect™ in a clustered environment with Tivoli® System Automation, you must check the prerequisites.

Check that the following prerequisites are met.

- Plan the installation of the IBM Spectrum Protect server.
- After you install IBM Spectrum Protect, verify the following items:
  - Ensure that the DB2® database is installed on the same node as the server.
  - Check that the server can control database recovery.
  - Verify that shared storage devices are available. IBM Spectrum Protect requires highly available shared storage devices to protect data integrity.
  - Verify that each node in the cluster can contain multiple instances of the server.



- Prepare for the Tivoli System Automation installation. For instructions, go to the Tivoli System Automation product documentation. In the *Installation and Configuration Guide*, search for *Preparing for installation*.
- After you install Tivoli System Automation, check that Tivoli System Automation can process failover such as IP failover and data failover for the database, instance data, active and archive logs, and storage pools.

**Related tasks:**

Planning to install the IBM Spectrum Protect server

Linux

## Installing and configuring IBM Spectrum Protect components on the primary and secondary nodes

---

You must install the IBM Spectrum Protect™ server and database components on the primary and secondary nodes in the cluster. Then, configure the primary node first followed by the secondary node.

- **Linux** Installing IBM Spectrum Protect server components  
After you check and verify the prerequisites, you must install the required components on the primary and secondary nodes on the system.
- **Linux** Configuring the primary node  
To set up the two-node topology, configure the IBM Spectrum Protect components on both nodes. First, you must configure the IBM Spectrum Protect instance on the primary node.
- **Linux** Configuring the secondary node  
After you configure the primary node, you must configure the secondary node so that Tivoli System Automation can move the IBM Spectrum Protect server components to the secondary node if the server fails on the primary node.

Linux

## Installing IBM Spectrum Protect server components

---

After you check and verify the prerequisites, you must install the required components on the primary and secondary nodes on the system.

### Procedure

---

Review the topics in the installing the IBM Spectrum Protect™ server components information.

**Related tasks:**

Installing the IBM Spectrum Protect server components

Linux

## Configuring the primary node

---

To set up the two-node topology, configure the IBM Spectrum Protect™ components on both nodes. First, you must configure the IBM Spectrum Protect instance on the primary node.

### Before you begin

---

- Install the IBM Spectrum Protect server components.
- Verify that the IBM Spectrum Protect instance owner has the same user and group ID for all of the nodes in the cluster domain.
- Verify that the IBM Spectrum Protect instance owner has the same password for all of the cluster nodes.

### Procedure

---

1. For detailed instructions about creating the directories and the user ID for the server instance, see Linux: Creating the user ID and directories for the server instance.
2. Verify that the IBM Spectrum Protect server, DB2® instance, and the active and archive log directories are shared.
3. Define the mount points by adding entries to the `/etc/fstab` file.

When you add mount points on the cluster nodes, use the `noauto` option to prevent the mount points from being automatically mounted on more than one node in the cluster.

4. Set the following permissions on each of the mount points:

- 755. For example, the following command sets the 755 permission on the `/tsminst1` mount point.

```
chmod -R 755 /tsminst1
```

- IBM Spectrum Protect server instance owner. For example, the following command sets the permissions for the instance owner.

```
chown -R tsminst1 /tsminst1
```

- IBM Spectrum Protect server group that the instance owner belongs to. For example, the following command sets the permissions for the instance owner's group.

```
chgrp tsmsrv_1_group /tsminst1
```

5. For detailed instructions on configuring the IBM Spectrum Protect server by using the configuration wizard, see [Linux: Configuring IBM Spectrum Protect by using the configuration wizard](#). Check that all of the shared directories are mounted on the primary node.

6. Start the IBM Spectrum Protect server instance on the primary node by using the DSMSEV utility. For example, the following command starts the server for normal operation.

```
/opt/tivoli/tsm/server/bin/dsmsevr
```

7. Verify that the IBM Spectrum Protect components are started without any errors.

8. Shut down the IBM Spectrum Protect server.

9. As root user, unmount the shared drives.

Linux

## Configuring the secondary node

---

After you configure the primary node, you must configure the secondary node so that Tivoli® System Automation can move the IBM Spectrum Protect™ server components to the secondary node if the server fails on the primary node.

### Procedure

---

1. To create the directories and the user ID for the server instance manually, follow the instructions in [Creating the user ID and directories for the server instance](#).
2. Verify that the IBM Spectrum Protect server, DB2® instance, and the active and archive log directories are shared.
3. Define the mount points by adding entries in the `/etc/fstab` file.

When you add mount points on the cluster nodes, use the `noauto` option. This option prevents the mount points from being automatically mounted on more than one node in the cluster.

Check that all of the shared directories are mounted on the secondary node.

4. Set the following permissions on each of the mount points:

- 755. For example, the following command sets the 755 permission on the `/tsminst1` mount point.

```
chmod -R 755 /tsminst1
```

- IBM Spectrum Protect server instance owner. For example, the following command sets the permissions for the instance owner.

```
chown -R tsminst1 /tsminst1
```

- IBM Spectrum Protect server group that the instance owner belongs to. For example, the following command sets the permissions for the instance owner's group.

```
chgrp tsmsrv_1_group /tsminst1
```

5. Create the IBM Spectrum Protect server instance by issuing the `db2icrt` command. For instructions, see [Creating the server instance](#).

Remember: You do not need to create a new server options file because the secondary node uses the `dsmsevr.opt` file from the primary node.

Check that all of the shared directories are mounted on the secondary node.

6. Catalog the database by issuing the `catalog db` command. For example, the following command catalogs the `tsmdb1` database.

```
db2 catalog db tsmdb1
```

7. Prepare the database for backup. For instructions, see Preparing the database manager for database backup.
8. Start the IBM Spectrum Protect server by using the DSMSEPV utility. For example, the following command starts the server for normal operation.

```
/opt/tivoli/tsm/server/bin/dsmserve
```

9. Verify that the IBM Spectrum Protect components are starting without any errors.
10. On the secondary nodes, shut down the IBM Spectrum Protect server and unmount the shared directories.

Linux

## Installing Tivoli System Automation on the primary and secondary nodes

After you install and configure IBM Spectrum Protect™ on the primary and secondary nodes in the cluster, you must install and configure Tivoli® System Automation on these nodes. Then, you must activate these nodes for the domain, configure the resources, and activate the base policy. Finally, you must add the mount points to the IBM Spectrum Protect directories.

- **Linux** Creating the label for the mount points  
Create a label for each mount point on the primary and secondary nodes in the cluster.
- **Linux** Installing and configuring Tivoli System Automation  
You must install IBM Tivoli System Automation for Multiplatforms on the primary and secondary nodes in the system.
- **Linux** Preparing to activate the cluster nodes for the domain  
After you install Tivoli System Automation on the primary and secondary nodes in the cluster, you must prepare these nodes so that you can activate the cluster and start the cluster domain.
- **Linux** Configuring volume group resources  
If you created volume groups for your cluster, you must configure these resources. Tivoli System Automation automatically finds and defines the shared disk volume resources.
- **Linux** Configuring resources that are not in a volume group  
If you created your *shared disk storage* resources by using ext2, ext3, or reiserfs resource types in one of the nodes in the cluster, then you must configure these resources.
- **Linux** Activating the base policy  
After you configure the resources, you must activate the policy on the primary and secondary nodes to create any remaining resources and the resource group.
- **Linux** Adding mount points to the IBM Spectrum Protect directories  
Before you can start the cluster, you must add the mount points that you created for the IBM Spectrum Protect components.

Linux

## Creating the label for the mount points

Create a label for each mount point on the primary and secondary nodes in the cluster.

### Procedure

1. Create a label for each of the volumes that you created previously for the shared directory mount points by issuing the `e2label` command. For example, the following command creates the `/tsminst1` label that has a `/dev/tsmvg1/tsminst1LV` partition.

```
e2label /dev/tsmvg1/tsminst1LV /tsminst1
```

2. For each node in the cluster, replace the entries for the mount points that you created previously in the `/etc/fstab` file. For example, for the previous sample label, issue the following command:

```
LABEL=/tsminst1 /tsminst1 ext3 defaults 0 0
```

Linux

## Installing and configuring Tivoli System Automation

You must install IBM® Tivoli® System Automation for Multiplatforms on the primary and secondary nodes in the system.

## Procedure

---

1. To install and configure Tivoli System Automation, detailed information is available in the Tivoli System Automation Installation and Configuration Guide.
2. Download the TSM-25072011-1015.zip file from the Integrated Service Management Library. Extract the compressed file on each cluster node.
3. After you extract the compressed file, verify that the new Tivoli System Automation directory that was created during the installation includes the /TSM/HA directory and subdirectories.

### Related information:

[IBM Tivoli System Automation for Multiplatforms Version 3.2.2 product information](#)

Linux

## Preparing to activate the cluster nodes for the domain

---

After you install Tivoli® System Automation on the primary and secondary nodes in the cluster, you must prepare these nodes so that you can activate the cluster and start the cluster domain.

### Procedure

---

1. Prepare each node for the domain by issuing the `preprnode` command. Issue this command for all the cluster nodes in the domain. For example, the following command prepares the `HOST1.ibm.com` and `HOST2.ibm.com` nodes.

```
preprnode HOST1.ibm.com HOST2.ibm.com
```

2. Create a domain for each node by issuing the `mkrpdomain` command. For example, the following command creates the `tsm_domain` for the `HOST1.ibm.com` and `HOST2.ibm.com` nodes.

```
mkrpdomain tsm_domain HOST1.ibm.com HOST2.ibm.com
```

3. Start the domain for each node by issuing `startdomain` command. For example, the following command starts the `tsm_domain`.

```
startdomain tsm_domain
```

Linux

## Configuring volume group resources

---

If you created volume groups for your cluster, you must configure these resources. Tivoli® System Automation automatically finds and defines the shared disk volume resources.

### Procedure

---

To configure the volume group resources for the shared IBM Spectrum Protect™ directories and mount points that you created previously, complete the following steps on the primary node.

1. Import the volume groups. For example, use the `vgimport X` command to import the `X` volume groups.
2. Activate the volume groups. For example, use the `vgchange -ay X` command to activate the `X` volume groups.
3. Mount the file system by issuing the `mount` command. The following example mounts the `X` file system.

```
mount X
```

4. Restart the domain by issuing the `stopdomain` and `startdomain` commands. For example, the following commands restart the `tsm_domain`.

```
stopdomain tsm_domain  
startdomain tsm_domain
```

5. Unmount the file system by issuing the `umount` command. For example, use the `umount X` command to unmount the `X` file system.
6. Deactivate the volume groups. For example, use the `vgchange -an X` command to deactivate the `X` volume groups.
7. Verify that all of the IBM®.AgfileSystem storage resources are harvested by Tivoli System Automation by issuing the following command:

```
lsrsrc -s "Name=='Resource_Name' && ResourceType=1" IBM.AgFileSystem
```

Linux

## Configuring resources that are not in a volume group

If you created your *shared disk storage* resources by using ext2, ext3, or reiserfs resource types in one of the nodes in the cluster, then you must configure these resources.

### Procedure

Complete the following steps on the primary node.

1. Mount the file system by issuing the mount command. For example, the following command mounts the *x* file system.

```
mount X
```

2. Restart the domain by issuing the stoprpdomain and startprdomain commands. For example, the following command restarts the *tsm\_domain*.

```
stoprpdomain tsm_domain  
startprdomain tsm_domain
```

3. Unmount the file system by issuing the umount command. For example, the following command unmounts the *x* file system.

```
umount X
```

4. Verify that all of the IBM®.AgfileSystem storage resources are harvested by Tivoli® System Automation by issuing the following command:

```
lsrsrc -s "Name=='Resource_Name' && ResourceType=1" IBM.AgFileSystem
```

For example, to verify the *tsmalog* resource, issue the following command:

```
lsrsrc -s "Name=='tsmalog' && ResourceType=1" IBM.AgFileSystem  
Resource Persistent Attributes for IBM.AgFileSystem resource 1:  
ResourceHandle= "0x2038 0xffff 0x6ad47197 0x256fc23d 0x9338a9950x263fa510"  
Name = "tsmalog"  
ResourceType = 1 <-----  
MountPoint = ""  
DeviceName = ""  
Vfs = "ext3"  
AggregateResource = "0x3fff 0xffff 0x00000000 0x00000000 0x00000000 0x00000000"  
ContainerResource = "0x2036 0xffff 0x6ad47197 0x256fc23d 0x9338a995 0x25ffaa28"  
GhostDevice = 0  
ResourceId = "360050768019c021d30000000000005da"  
ProtectionMode = 1  
UserControl = 0  
SysMountPoint = "/tsmalog"  
Label = "/tsmalog"  
FSID = "5792f887-8547-4c33-a519-9d0c50ab6882"  
PreOnlineMethod = 0  
ContainerResourceId = "360050768019c021d30000000000005da"  
AutoMonitor = 1  
Options = "defaults,noauto"  
PreOfflineMethod = 0  
ActivePeerDomain = "TSM_Domain"  
NodeNameList =  
{ "tsmlnode01.storage.tucson.ibm.com", "tsmlnode02.storage.tucson.ibm.com" }
```

Linux

## Activating the base policy

After you configure the resources, you must activate the policy on the primary and secondary nodes to create any remaining resources and the resource group.

### About this task

To activate the base policy, you must create the Service IP resource and IBM Spectrum Protect™ application resources for the IBM Spectrum Protect server instance. Then, you must create the resource group and the policies to manage the cluster.

## Procedure

---

Complete the following steps first on the primary node and then on the secondary node.

1. Go to the directory where you extracted the contents of the TSM-25072011-1015.zip file.
2. Set the file permissions on the scripts in the bin directory by issuing the `chmod` command. For example, the following command sets the file permissions for all of the scripts in the bin directory. XXX is the name of the extracted folder.

```
chmod 755 /XXX/TSM/HA/bin/*
```

3. Go to the bin directory by issuing the `cd` command.
4. Update the following variables in the `base_cluster_variables.sh` script:
  - o `NODE1` specifies the host name for node 1 (primary node) in the cluster.
  - o `NODE2` specifies the host name for node 2 (secondary node) in the cluster.
  - o `IP_GATEWAY` specifies the gateway of the Service IP.
  - o `SUBNET_MASK` specifies the subnet mask of the Service IP.
  - o `NET_INT` specifies the network interface name of a specific node in the cluster. This name must be the same for all the nodes in the cluster.
5. Run the `configureHA.sh` configuration script by issuing the `./configureHA.sh` command on all of the nodes in the cluster. If the `configureHA.sh` script fails with the `-bash: ./configureHA.sh: /bin/bash^M: bad interpreter: No such file or directory` error, issue the `dos2unix` command on all of the scripts in the bin directory. For example, for each script run the following command:

```
dos2unix -o <filename>
```

6. Verify that the configuration is a success by verifying that the configuration script runs successfully.
7. Attention: Complete this step on the primary node only.  
Run the setup script by issuing the `./setup.sh` command. For example, the following command runs the setup script on the `inst1` IBM Spectrum Protect server instance for the `dbinst1` instance user in the `/tsminst1` IBM Spectrum Protect server instance directory with `9.11.142.129` as the service IP.

```
./setup.sh inst1 dbinst1 /tsminst1 9.11.142.129
```

8. Verify that you are using the correct IP by running the following command:

```
lssam -V
```

9. Repeat step 5 for all of the IBM Spectrum Protect instances that you have in your IBM Spectrum Protect server environment.
10. Complete all of the previous steps on the secondary node.

Linux

## Adding mount points to the IBM Spectrum Protect directories

---

Before you can start the cluster, you must add the mount points that you created for the IBM Spectrum Protect™ components.

## Procedure

---

To add the shared disk mount points to the cluster resource group and bring the cluster online, complete the following steps:

1. Identify mount points for the following directories:
  - o Instance
  - o Database
  - o Active log
  - o Archive log
  - o Storage pool
2. Add resources to each mount point:
  - a. Check whether the `tsm-$INST_NAME-rg` resource group is online by issuing the `lssam` command.
  - b. If the `tsm-$INST_NAME-rg` resource group is online, take it offline by issuing the following command:

```
chrg -o offline tsm-$INST_NAME-rg
```

- c. Go to the directory where you extracted the contents of the TSM-25072011-1015.zip file.
- d. Move to the bin directory by issuing the `cd` command.
- e. To add shared disk resources to each mount point, run the `./update_setup.sh` script. For example, the following command adds the `/tsminst1` mount point to the `inst1` IBM Spectrum Protect server instance.

```
./update_setup.sh inst1 /tsminst1
```

3. Bring the `tsm-$INST_NAME-rg` resource group online by issuing the following command:

```
chrg -o online tsm-$INST_NAME-rg
```

4. Connect to the server using the service gateway IP to verify that the configuration is correct.

Linux

## Configuring storage resources

---

Use the Tivoli® System Automation user interface or command line to add or delete storage resources and to delete mount points that are no longer required. If you add a storage pool to the cluster, you must add it to the resource group. If you remove a storage pool from the cluster, you must also delete it from the resource group.

- **Linux** Adding a storage pool to a resource group  
If your IBM Spectrum Protect configuration stores data on disks, then you must add the shared disk mount point for the storage pool to the resource group.
- **Linux** Deleting a storage pool from a resource group  
You can delete a storage pool that is no longer required. If a storage pool is removed from the IBM Spectrum Protect server instance, it must be deleted from the resource group.
- **Linux** Deleting a mount point from a resource group  
You might want to delete a mount point that is no longer required.

Linux

## Adding a storage pool to a resource group

---

If your IBM Spectrum Protect™ configuration stores data on disks, then you must add the shared disk mount point for the storage pool to the resource group.

### Procedure

---

To add the shared disk mount point for the storage pool to the resource group, complete the following steps:

1. Lock the resource group by issuing the `rgreq -o lock` command. For example, the following command locks the `Sample_Resourcegroup_X` resource group.

```
rgreq -o lock Sample_Resourcegroup_X
```

2. Move to the bin directory by issuing the `cd` command:
3. To add a storage pool resource to a resource group, run the `update_setup.sh` script by issuing the `./update_setup.sh` command. For example, the following command adds the `/inst1stg1` storage pool mount point to the `inst1` IBM Spectrum Protect server instance.

```
./update_setup.sh inst1 /inst1stg1
```

4. Unlock the resource group by issuing the `rgreq -o unlock` command. For example, the following command unlocks the `Sample_Resourcegroup_X` resource group.

```
rgreq -o unlock Sample_Resourcegroup_X
```

Linux

## Deleting a storage pool from a resource group

---

You can delete a storage pool that is no longer required. If a storage pool is removed from the IBM Spectrum Protect™ server instance, it must be deleted from the resource group.

## Procedure

---

To delete a storage pool, complete the following steps:

1. Lock the resource group by issuing the `rgreq -o lock` command. For example, the following command locks the `Sample_Resourcegroup_X` resource group.

```
rgreq -o lock Sample_Resourcegroup_X
```

2. Move to the bin directory by issuing the `cd` command.
3. To delete a storage pool resource from a resource group, run the `delete_mount.sh` script by issuing the `./delete_mount.sh` command. For example, the following command deletes the `/inst1stg1` mount point from the `inst1` IBM Spectrum Protect server instance.

```
./delete_mount.sh /inst1stg1 inst1
```

4. Unlock the resource group by issuing the `rgreq -o unlock` command. For example, the following command unlocks the `Sample_Resourcegroup_X` resource group.

```
rgreq -o unlock Sample_Resourcegroup_X
```

Linux

## Deleting a mount point from a resource group

---

You might want to delete a mount point that is no longer required.

### Procedure

---

To delete a mount point, complete the following steps:

1. Check whether the `tsm- $\$INST\_NAME$ -rg` resource group is online by issuing the `lssam` command.
2. If the `tsm- $\$INST\_NAME$ -rg` resource group is online, take it offline by issuing the following command:

```
chrg -o offline tsm- $\$INST\_NAME$ -rg
```

3. Move to the bin directory by issuing the `cd` command.
4. To delete a mount point, run the `delete_mount.sh` script. For example, the following command deletes the `/tsminst1` mount point from the `inst1` IBM Spectrum Protect™ server instance resource group.

```
./delete_mount.sh /tsminst1 inst1
```

5. Bring the `tsm- $\$INST\_NAME$ -rg` resource group online by issuing the following command:

```
chrg -o online tsm- $\$INST\_NAME$ -rg
```

Linux

## Upgrading a server that is configured with Tivoli System Automation

---

You can upgrade a server that is configured with Tivoli® System Automation from Version 6.3 or Version 7.1.

### Procedure

---

To upgrade the server on each node in the cluster, log in to the server and complete the following steps. These steps start the upgrade on the primary node and then the latter part of this procedure upgrades the secondary node.

1. Stop the server resources by issuing the `chrg -o Offline` command. For example, the following command stops the resources in the `tsm-tsminst1-rg` resource group:

```
chrg -o Offline tsm-tsminst1-rg
```

2. Stop the Tivoli System Automation domain by issuing the `stoprpdomain` command. For example, the following command stops the `tsm_domain`:

```
stoprpdomain tsm_domain
```



3. Mount the server mount points on the primary node.
4. To upgrade the server on the primary node, see [Upgrading IBM Spectrum Protect™](#).
5. After the upgrade is finished, complete the post upgrade steps to verify that the upgrade is successful on the primary node.
6. Stop the server and unmount the server mount points on the primary node.
7. Mount the server mount points on the secondary node.
8. If you are upgrading a server from V6 to V7, complete the following steps:
  - a. Uninstall the server.

For instructions, see [Uninstalling the V6.3 server](#).

- b. Install the server on the secondary node. Follow the instructions in [Linux: Installing the server components](#).
9. To upgrade the server on the secondary node, see [Upgrading the server](#).
10. After the upgrade is complete, complete the post upgrade steps to verify that the upgrade is successful on the secondary node.
11. Unmount the server mount points on the secondary node.
12. Start the Tivoli System Automation domain by issuing the `starttrpdomain` command. For example, the following command starts the `tsa_domain`:

```
starttrpdomain tsa_domain
```

13. Start the server resources by issuing the `chrg -o Online` command. For example, the following command starts the resources in the `tsm-tsminst1-rg` resource group:

```
chrg -o Online tsm-tsminst1-rg
```

Windows

## Configuring a Windows clustered environment

---

You can configure an IBM Spectrum Protect™ server for Windows in a Microsoft failover cluster environment. Windows cluster environments consist of components such as IBM Spectrum Protect servers, hardware, and software. When these components are connected to the same disk system, downtime is minimized.

Microsoft software helps configure, monitor, and control applications and hardware components that are deployed on a Windows cluster. The administrator uses the Microsoft Cluster Administrator interface and IBM Spectrum Protect to designate cluster arrangements and define the failover pattern.

IBM Spectrum Protect supports tape failover for a cluster environment by using a Fibre or SCSI connection. Although Microsoft failover clusters do not support the failover of tape devices, the failover configuration can be monitored through the Microsoft Cluster Administrator interface after it is set up through IBM Spectrum Protect.

- Windows [Microsoft Failover Cluster environment overview](#)  
 With a Microsoft Failover Cluster Manager, you can place IBM Spectrum Protect server cluster resources into a cluster group. The IBM Spectrum Protect cluster group has a network name, an IP address, one or more physical disks, a Tivoli® server, and an IBM Spectrum Protect server service.
- Windows [Tape failover for nodes in a cluster](#)  
 Groups in a cluster can be transferred to other nodes when the node that is hosting the groups fails.
- Windows [Planning for a clustered environment](#)  
 Configuration in a clustered environment takes planning to ensure the optimal performance of your system. Whether you configure your system to include clusters depends on your business needs.
- Windows [Setting up IBM Spectrum Protect in a Microsoft Failover Cluster](#)  
 You must ensure that your cluster is properly installed and configured before you install IBM Spectrum Protect.
- Windows [Maintaining the clustered environment](#)  
 After you set up your initial cluster or clusters, maintenance needs are minimal.

Windows

## Microsoft Failover Cluster environment overview

---

With a Microsoft Failover Cluster Manager, you can place IBM Spectrum Protect™ server cluster resources into a cluster group. The IBM Spectrum Protect cluster group has a network name, an IP address, one or more physical disks, a Tivoli® server, and an IBM Spectrum Protect server service.

The IBM Spectrum Protect instance network name is independent of the name of the physical node on which the IBM Spectrum Protect cluster group runs. Clients connect to an IBM Spectrum Protect server by using the instance network name, rather than the Windows node name. The instance network name maps to a primary or backup node. The mapping depends on which node owns the cluster group. Any client that uses Windows Internet Name Service (WINS) or directory services to locate servers can automatically track the IBM Spectrum Protect clustered server as it moves between nodes. You can automatically track the clustered server without modifying or reconfiguring the client.

Each IBM Spectrum Protect cluster group has its own disk as part of a cluster resource group. IBM Spectrum Protect cluster groups cannot share data between the cluster groups. Each IBM Spectrum Protect server that is configured in a cluster group has its database, active logs, recovery logs, and set of storage pool volumes on a separate disk. This disk is owned by the cluster group where the server is configured.

Remember: Microsoft Failover Cluster Manager supports an IP address only as a resource. Hence, any IBM Spectrum Protect server that runs on a cluster must limit its supported communication method to just TCP/IP. Any client that does not use TCP/IP as a communication method is not able to reach the IBM Spectrum Protect cluster group if it fails over to the other cluster node.

The following example demonstrates the way that a Microsoft Failover Cluster Manager for an IBM Spectrum Protect cluster server works.

Assume that a clustered IBM Spectrum Protect server that is named JUPITER is running on Node Z and a clustered IBM Spectrum Protect server that is named SATURN is running on Node X. Clients connect to the IBM Spectrum Protect server JUPITER and the IBM Spectrum Protect server SATURN without knowing which node hosts their server.

Figure 1. Clustering with JUPITER as Node Z and SATURN as Node X

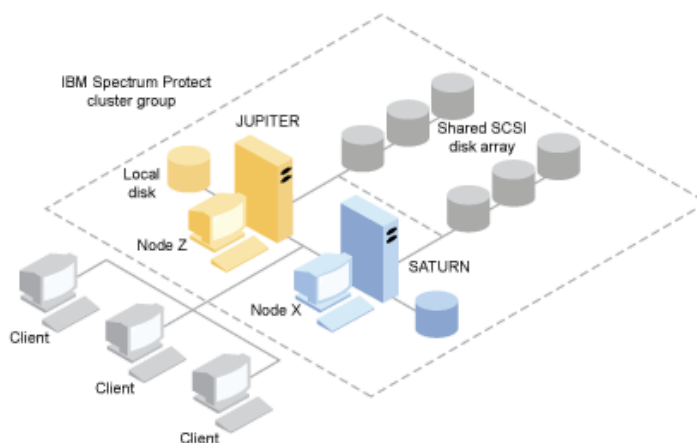

When one of the software or hardware resources fails, failover occurs. Resources such as applications, disks, and an IP address move from the failed node to the remaining node. The remaining node:

- Takes over the IBM Spectrum Protect cluster group
- Brings the disk resources, the network resources, and the DB2 resource online
- Restarts the IBM Spectrum Protect service
- Provides access to administrators and clients

If Node X fails, Node Z assumes the role of running SATURN. To a client, it is exactly as if Node X were turned off and immediately turned back on again. Clients experience the loss of all connections to SATURN and all active transactions are rolled back to the client. Clients must reconnect to SATURN after the connection is lost. The location of SATURN is not apparent to the client.

Windows

## Tape failover for nodes in a cluster

Groups in a cluster can be transferred to other nodes when the node that is hosting the groups fails.

A node can host physical or logical units, referred to as resources. Administrators organize these cluster resources into functional units that are called groups and assign these groups to individual nodes. If a node fails, the server cluster transfers the groups that were being hosted by the node to other nodes in the cluster. This transfer process is called *failover*. The reverse process,

*failback*, occurs when the failed node becomes active again and the groups that were failed over to the other nodes are transferred back to the original node.

- **Windows** Fiber tape failover  
IBM Spectrum Protect can manage the failover of Fibre Channel direct-attached tape and library devices on a Microsoft Windows system in a clustered environment without extra hardware.

**Windows**

## Planning for a clustered environment

---

Configuration in a clustered environment takes planning to ensure the optimal performance of your system. Whether you configure your system to include clusters depends on your business needs.

Plan for a cluster configuration that accommodates your environment. In addition to assuring the correct type of hardware and the applicable software, you must set up a failover pattern.

When a node fails or needs to be taken offline, which node or nodes in the cluster picks up the transaction processing? In a two-node cluster, there is little planning necessary. In a more complex arrangement, you want to consider how your transaction processing is best handled. A form of load balancing among your nodes needs to be accounted for so that you maintain peak performance. Another consideration is to ensure that your customers do not see any lag and little drop in productivity.

Microsoft Cluster Servers and Microsoft Failover Clusters require each IBM Spectrum Protect™ server instance to have a private set of disk resources. Although nodes can share disk resources, only one node can actively control a disk at a time.

Attention: Ensure that the same level of Windows (Windows 2012, Windows 2012 R2, and Windows 2016) is installed on all computers in the cluster.

Is one configuration better than the other? To determine your best installation, you need to look at the differences in performance and cost. Assume that you have an IBM Spectrum Protect server-dedicated cluster whose nodes have comparable power. During failover, the performance of a configuration might degrade because one node must manage both IBM Spectrum Protect cluster instances. If each node handles 100 clients in a normal operation, one node must handle 200 clients during a failure.

- **Windows** Cluster configuration worksheet  
Record your answers to the following planning questions before you set up the cluster configuration.
- **Windows** Planning for cluster hardware and software configuration  
Cluster hardware and software configuration is determined during the planning stage and before the actual installation.
- **Windows** Configuring IBM Spectrum Protect in Microsoft Failover Cluster  
The IBM Spectrum Protect cluster configuration procedure must be completed on the set of nodes that hosts an IBM Spectrum Protect cluster group.

### Related information:

[IBM Spectrum Protect Supported Operating Systems](#)

**Windows**

## Cluster configuration worksheet

---

Record your answers to the following planning questions before you set up the cluster configuration.

1. What type of cluster solution best fits your business needs?
2. What type of failover pattern do you need?

The use of tape failover support also affects the pattern.

3. Is tape failover support be needed?

Consider how tape devices are used by the IBM Spectrum Protect™ cluster instances. The way that tape devices are used by cluster instances can limit the number of nodes in the failover pattern to two.

4. What are the resources to be dedicated to IBM Spectrum Protect?

Resource type	Resource name
Cluster Resource Group	

Resource type	Resource name
Physical Disk Resources	
IP address	
Subnet Mask	
Network	
Network Name (server name)	
Nodes	
Tape Failover (optional): device name - both nodes	

Windows

## Planning for cluster hardware and software configuration

Cluster hardware and software configuration is determined during the planning stage and before the actual installation.

### Procedure

The following guidelines help determine what resources are needed for a successful IBM Spectrum Protect™ cluster:

1. Decide which cluster configuration you must use with servers that use disk devices. Each IBM Spectrum Protect cluster instance needs a separate set of disk resources on the shared disk subsystem. You might have problems if you configure the I/O subsystem as one large array. For example, when you configure a two server cluster and later decide to expand to a four server cluster.
2. Identify the disk resources to be dedicated to IBM Spectrum Protect. Do not divide a shared disk into multiple partitions with each partition assigned to a different application and thus a different cluster group.

For example, Application A, a stable application, might be forced to fail over because of a software problem with Application B. This failover might occur if both applications use partitions that are part of the same physical disk. This problem causes the Cluster Services to fail over Application B and its corequisite disk resource. Because the partitions exist on the same physical drive, Application A is also forced to fail over. Therefore, when you install and configure an IBM Spectrum Protect application, dedicate a shared disk as a resource that can fail if necessary.

3. Ensure that you have an IP address and network name for each IBM Spectrum Protect server instance that you configure. For a cluster that involves two IBM Spectrum Protect cluster instances, you must have two network names.
4. Create a cluster resource group and move disk resources to it. Each IBM Spectrum Protect server instance requires a cluster resource group. Initially, the group must contain only disk resources. You might choose just to rename an existing resource group that contains only disk resources.
5. IBM Spectrum Protect is installed to a local disk on each node in the cluster. Determine the disk to be used on each node. Use the same drive letter on each system. When IBM Spectrum Protect server is installed in a cluster environment, the SANDISCOVERY option must be set to ON. By default, this option is set to OFF.
6. If you choose not to use IBM Spectrum Protect tape failover support, you can attach tape devices in either of the following configurations:

Configuration	Advantages and disadvantages	The required disk space	How to enable migration	What to do when a failover occurs
Attach to the node on which the IBM Spectrum Protect server instance is active.	This configuration allows high-performance backup and restore operations. However, it is not entirely automated because operator intervention is required to service a failover when repair delays occur.	Define enough volume space for which data is disk-based to keep more than two days worth of average data.	Set up a storage pool hierarchy so that data is moved efficiently to the tape device.	Manually disconnect the tape device and reattach it to the node on which the server was activated.

Configuration	Advantages and disadvantages	The required disk space	How to enable migration	What to do when a failover occurs
Attach to a third, non-clustered system on which an extra instance of the IBM Spectrum Protect server is active.	This configuration might not be feasible in installations with low-bandwidth communications between the servers in the cluster and the tape-device controller server.	Define enough volume space for which data is disk-based to keep more than two days worth of average data.	Use the virtual volumes to move the data from the local disk volumes to the tape device.	No action is needed; the activated server continues to use the virtual volumes.

Windows

## Configuring IBM Spectrum Protect in Microsoft Failover Cluster

The IBM Spectrum Protect™ cluster configuration procedure must be completed on the set of nodes that hosts an IBM Spectrum Protect cluster group.

Steps for the procedure vary depending upon which node you are currently configuring. When you configure the primary node in the set, the IBM Spectrum Protect server instance is created and configured. When you configure the remaining nodes in the set, each node is updated by using a specific method. The way the node is updated allows it to host the IBM Spectrum Protect server instance that is created on the primary node. An IBM Spectrum Protect server must be installed and configured on the first node in the set before you configure the remaining nodes in the set. Violating this requirement causes the configuration to fail.

Ensure that you completely configure one IBM Spectrum Protect cluster group before you move on to the next when you are configuring multiple IBM Spectrum Protect cluster groups. Because you are dealing with separate IP addresses and network names for each IBM Spectrum Protect cluster group, you lessen the possibility of mistakes by configuring each cluster group separately.

Windows

## Setting up IBM Spectrum Protect in a Microsoft Failover Cluster

You must ensure that your cluster is properly installed and configured before you install IBM Spectrum Protect™.

### Procedure

To configure IBM Spectrum Protect in a Microsoft Failover Cluster, complete the following steps:

1. Ensure that the Windows operating system is installed on all computers that are part of the cluster. For the most current information about supported Windows operating systems, see technote 1243309.
2. Log on with the domain user ID. The domain user must be in the same domain as the IBM Spectrum Protect server.
3. Ensure that the failover cluster is installed and configured for all the computers in the cluster.

If you plan to install the IBM Spectrum Protect server on the Windows Server 2012 operating system, install the failover cluster automation server and the failover cluster command interface first. To install these components, issue the following commands from Windows 2.0 PowerShell:

```
Install-WindowsFeature -Name RSAT-Clustering-AutomationServer
Install-WindowsFeature -Name RSAT-Clustering-CmdInterface
```

4. Verify that each node and shared disk in the cluster is operational.
5. Ensure that the shared tape devices are operational if IBM Spectrum Protect tape failover support is being used.

- **Windows** Preparing a Microsoft Failover Cluster group for a basic virtual server  
Each IBM Spectrum Protect server instance requires a cluster resource group.
- **Windows** Installing IBM Spectrum Protect in a Microsoft Failover Cluster  
Install the IBM Spectrum Protect server on every node in the cluster that hosts an IBM Spectrum Protect clustered server.
- **Windows** Initializing the IBM Spectrum Protect server for a Microsoft Failover Cluster on the primary node  
After you install IBM Spectrum Protect on the nodes in the cluster, you must initialize the server on the primary node.
- **Windows** Verifying the configuration of IBM Spectrum Protect in a Microsoft Failover Cluster  
When you finish configuring IBM Spectrum Protect in a Microsoft Failover Cluster, you can review the Failover Cluster Manager summary window. Verify that clustering is completed successfully and the IBM Spectrum Protect server is started.

- **Windows** Completing a failover test for your cluster

After you complete the cluster configuration, run a failover test to ensure that the nodes are working properly.

**Windows**

## Preparing a Microsoft Failover Cluster group for a basic virtual server

---

Each IBM Spectrum Protect™ server instance requires a cluster resource group.

### Before you begin

---

Use the Failover Cluster Manager program on the computer that owns the shared disk or tape resource to prepare your resource group. Initially, the group must contain only disk resources. You can create a group and move disk resources to it. You can also choose to rename an existing resource group that contains only disk resources.

As you construct your resource groups, consider the following items:

- Ensure that each resource group has a distinctive name. Do not change the names after the group is created because it can cause a corrupted configuration.
- Ensure that all nodes in the cluster are online.
- Ensure that the group is online and owned by the node where the initial server instance is installed.

### Procedure

---

To prepare a resource group for cluster configuration, complete the following steps:

1. Open the Failover Cluster Manager program. Right-click Services and Applications and then choose More Actions > Create Empty Service or Application.
2. Right-click New Service or Application, select Change the name and choose a new name for the resource group such as TSMGROUP.
3. Right-click the resource group TSMGROUP and select Add storage.
4. On the Add storage area panel, select the shared volume or volumes for IBM Spectrum Protect and click OK. The resource group TSMGROUP, which contains the disk volumes you just added, is displayed.

**Windows**

## Installing IBM Spectrum Protect in a Microsoft Failover Cluster

---

Install the IBM Spectrum Protect™ server on every node in the cluster that hosts an IBM Spectrum Protect clustered server.

### Procedure

---

Complete the following steps for each node in your cluster to install the IBM Spectrum Protect server:

1. Log in with an administrator or domain user ID. The domain user must be a member of the Domain Administrators group.
2. Install the IBM Spectrum Protect server to a local disk on each node. Use the same local disk drive letter for each node.
3. Restart the system after the server installation completes.

**Windows**

## Initializing the IBM Spectrum Protect server for a Microsoft Failover Cluster on the primary node

---

After you install IBM Spectrum Protect™ on the nodes in the cluster, you must initialize the server on the primary node.

### Procedure

---

1. Ensure that all systems are restarted after the installation. Verify that all systems are running correctly.
2. Log in with an administrator or domain user ID. The domain user must be in the same domain as the IBM Spectrum Protect server.
3. Open the Failover Cluster Manager program and verify that the resources are online and available to the primary node.

4. Begin the initialization procedure on the primary node in your cluster. In the Failover Cluster Manager program, verify that the owner of the resource group is the primary node in your cluster.
5. From the Start menu, click All programs > IBM Spectrum Protect server > Configuration wizard.
6. Follow the wizard directions, clicking Next to step through the wizard. When you are prompted to enter the user ID, enter the name of the domain account to associate with the cluster.
7. If the initialization completed, click Done.

Windows

## Verifying the configuration of IBM Spectrum Protect in a Microsoft Failover Cluster

---

When you finish configuring IBM Spectrum Protect™ in a Microsoft Failover Cluster, you can review the Failover Cluster Manager summary window. Verify that clustering is completed successfully and the IBM Spectrum Protect server is started.

### Procedure

---

To verify that the IBM Spectrum Protect server instance in a Microsoft Failover Cluster is created and configured correctly, complete the following steps:

1. From the Failover Cluster Manager, select the server instance. The network name that you configured is displayed in the Server Name pane.
2. In the Other Resources pane, confirm that the server instance and the IBM® DB2® server resource are displayed.
3. Right-click the IBM Spectrum Protect server instance and select Bring this resource online.

Windows

## Completing a failover test for your cluster

---

After you complete the cluster configuration, run a failover test to ensure that the nodes are working properly.

### Procedure

---

1. Open Failover Cluster Manager. Under Other Resources, right-click the IBM Spectrum Protect™ Instance(x) resource. Select Bring this resource online.
2. To test the failover, right-click the IBM Spectrum Protect cluster resource group and select Move this service or application to another node.
3. Verify that the failover from the second node to the first node completes successfully.

Windows

## Maintaining the clustered environment

---

After you set up your initial cluster or clusters, maintenance needs are minimal.

Check your Windows Event log on a regular, if not daily, basis to monitor the activity of the nodes in the cluster. Use the log to check whether a node fails and needs maintenance.

The following list of topics describes situations that might affect the configuration or format of your cluster after it is operational.

- **Windows** Migrating an existing IBM Spectrum Protect server into a cluster  
The reason for moving client data into a cluster is similar to the reason for adding a server to a cluster. You want to increase the availability and reliability of data to all your users. By having the server as part of the cluster, you provide an extra level of security by ensuring that no transactions are missed due to a failed server. The failover pattern that you establish prevents future failures.
- **Windows** Adding an IBM Spectrum Protect server with backup and restore  
If your hardware resources are limited, you can add an existing IBM Spectrum Protect server to a cluster by using a backup and restore procedure.
- **Windows** Managing a virtual IBM Spectrum Protect server on a cluster  
For most tasks, you can administer a virtual IBM Spectrum Protect server as you would a non-clustered server. To complete

tasks such as starting and stopping the server or moving a resource group to another node to complete system maintenance, you must use the Microsoft Cluster Administrator interface.

- **Windows** Managing tape failover in a cluster

As part of your regular routine, check the event log to ensure that the configuration is operating properly. If a server fails, the error is logged. The log provides you with information to understand why the failure took place.

- **Windows** Troubleshooting with IBM Spectrum Protect cluster log

The IBM Spectrum Protect Cluster Resource DLL reports events and errors to the cluster log. The cluster log is a useful troubleshooting tool. When this log is enabled, it records the actions of each component of the Cluster service as the result of each action.

**Windows**

## Migrating an existing IBM Spectrum Protect server into a cluster

---

The reason for moving client data into a cluster is similar to the reason for adding a server to a cluster. You want to increase the availability and reliability of data to all your users. By having the server as part of the cluster, you provide an extra level of security by ensuring that no transactions are missed due to a failed server. The failover pattern that you establish prevents future failures.

### About this task

---

To migrate an existing IBM Spectrum Protect™ server into a cluster, you can either move the clients or complete a backup and restore procedure. The choice depends primarily on the availability and capacity of other IBM Spectrum Protect server computers in your site and your familiarity with the backup and restore procedure.

- **Windows** Moving the clients

If you move clients from a non-clustered IBM Spectrum Protect server computer to a clustered one, you can slowly move your users to the new system and not interrupt services. However, you must have the correct hardware to run two IBM Spectrum Protect servers simultaneously.

#### Related tasks:

Installing and upgrading the server

**Windows**

## Adding an IBM Spectrum Protect server with backup and restore

---

If your hardware resources are limited, you can add an existing IBM Spectrum Protect™ server to a cluster by using a backup and restore procedure.

### About this task

---

For example, suppose that you have no hardware other than the two server systems to be clustered. You plan to use the computer that is running the IBM Spectrum Protect server as a node. Complete this procedure to remove IBM Spectrum Protect from the computer and reinstall it in the cluster:

### Procedure

---

1. Back up all disk storage pools to a copy storage pool.
2. Back up the database of the existing IBM Spectrum Protect server.
3. Perform the installation and configuration of the cluster.
4. Restore the database to the clustered IBM Spectrum Protect server.
5. Restore the disk storage pool volumes from the copy storage pool.
6. After you verify that all of your data is on the clustered server, delete the old server.

**Windows**

## Managing a virtual IBM Spectrum Protect server on a cluster

---

For most tasks, you can administer a virtual IBM Spectrum Protect™ server as you would a non-clustered server. To complete tasks such as starting and stopping the server or moving a resource group to another node to complete system maintenance, you must use the Microsoft Cluster Administrator interface.



## About this task

---

The Microsoft Cluster Administrator interface is available through the Administrative Tools program group. The interface is a detailed view of a virtual server configuration. The virtual server configuration includes details such as the physical Windows servers that are part of the cluster and their resources, network connections, and status. View the components of a virtual server configuration and start, stop, or fail back a virtual server by using this interface. Manage a virtual IBM Spectrum Protect server by using the Microsoft Cluster Administrator interface to avoid server failures and error messages. For example, if you use the Windows Service Control Manager to shut down the server, you might receive messages that the server failed.

You might want to move a virtual IBM Spectrum Protect server when the Windows server acts as the primary node and this server requires hardware or system maintenance. Use the Microsoft Cluster Administrator interface to move the management of the virtual IBM Spectrum Protect server to the secondary node until the maintenance is completed.

Windows

## Managing tape failover in a cluster

---

As part of your regular routine, check the event log to ensure that the configuration is operating properly. If a server fails, the error is logged. The log provides you with information to understand why the failure took place.

## About this task

---

Sometimes a node must rejoin the cluster, for example:

- When a node failed
- When a new Host Bus Adapter fiber card is added (equipment changes)

## Procedure

---

Complete the following tasks in any order to ensure that a node can successfully join the cluster:

- Update, if necessary, the drive and library that use the IBM Spectrum Protect™ cluster tool.
- Take the IBM Spectrum Protect server offline until the failed node rejoins the cluster. This action helps ensure that the IBM Spectrum Protect server that is running on the other node is not affected.

Windows

## Troubleshooting with IBM Spectrum Protect cluster log

---

The IBM Spectrum Protect™ Cluster Resource DLL reports events and errors to the cluster log. The cluster log is a useful troubleshooting tool. When this log is enabled, it records the actions of each component of the Cluster service as the result of each action.

In comparison with the Microsoft Windows Event Log, the cluster log is a complete record of cluster activity. The cluster log records the cluster service activity that is recorded in the event log. Although the event log can point you to a problem, the cluster log helps you resolve the problem.

The cluster log is enabled by default in Windows. Its output is printed as a log file in %SystemRoot%\Cluster. For more information, see the Windows online help documentation.

## Configuring clients for applications, virtual machines, and systems

---

The server protects data for clients, which can include applications, virtual machines, and systems. To start protecting client data, register the client node with the server and select a backup schedule to protect the client data.

- Adding clients  
After you implement a data protection solution with IBM Spectrum Protect™, you can expand the solution by adding clients.
- Customizing policies  
An organization's goals for how data is protected and retained are typically defined by corporate executives, legal advisors, or other people in lead roles. *Policies* are the means to align the operation of IBM Spectrum Protect with the data protection and retention goals of your organization.

## Adding clients

---

After you implement a data protection solution with IBM Spectrum Protect™, you can expand the solution by adding clients.

### About this task

---

The procedure describes basic steps for adding a client. For more specific instructions about configuring clients, see the documentation for the product that you install on the client node. You can have the following types of client nodes:

#### Application client nodes

Application client nodes include email servers, databases, and other applications. For example, any of the following applications can be an application client node:

- IBM Spectrum Protect Snapshot
- IBM Spectrum Protect for Databases
- IBM Spectrum Protect for Enterprise Resource Planning
- IBM Spectrum Protect for Mail
- IBM Spectrum Protect for Virtual Environments

#### System client nodes

System client nodes include workstations, network-attached storage (NAS) file servers, and API clients.

#### Virtual machine client nodes

Virtual machine client nodes consist of an individual guest host within a hypervisor. Each virtual machine is represented as a file space.

### Procedure

---

To add a client, complete the following steps:

1. Select the software to install on the client node and plan the installation. Follow the instructions in [Selecting the client software and planning the installation](#).
2. Specify how to back up and archive client data. Follow the instructions in [Specifying rules for backing up and archiving client data](#).
3. Specify when to back up and archive client data. Follow the instructions in [Scheduling backup and archive operations](#).
4. To allow the client to connect to the server, register the client. Follow the instructions in [Registering clients](#).
5. To start protecting a client node, install and configure the selected software on the client node. Follow the instructions in [Installing and configuring clients](#).

## Selecting the client software and planning the installation

---

Different types of data require different types of protection. Identify the type of data that you must protect and select the appropriate software.

### About this task

---

The preferred practice is to install the backup-archive client on all client nodes so that you can configure and start the client acceptor on the client node. The client acceptor is designed to efficiently run scheduled operations.

The client acceptor runs schedules for the following products: the backup-archive client, IBM Spectrum Protect™ for Databases, IBM Spectrum Protect for Enterprise Resource Planning, IBM Spectrum Protect for Mail, and IBM Spectrum Protect for Virtual Environments. If you install a product for which the client acceptor does not run schedules, you must follow the configuration instructions in the product documentation to ensure that scheduled operations can occur.

### Procedure

---

Based on your goal, select the products to install and review the installation instructions.

Tip: If you install the client software now, you must also complete the client configuration tasks that are described in [Installing and configuring clients](#) before you can use the client.

Goal	Product and description	Installation instructions
------	-------------------------	---------------------------

Goal	Product and description	Installation instructions
Protect a file server or workstation	The backup-archive client backs up and archives files and directories from file servers and workstations to storage. You can also restore and retrieve backup versions and archived copies of files.	<ul style="list-style-type: none"> <li>• Backup-archive client requirements</li> <li>• Installing the UNIX and Linux backup-archive clients</li> <li>• Installing the Windows backup-archive client</li> </ul>
Protect applications with snapshot backup and restore capabilities	IBM Spectrum Protect Snapshot protects data with integrated, application-aware snapshot backup and restore capabilities. You can protect data that is stored by IBM DB2® database software and SAP, Oracle, Microsoft Exchange, and Microsoft SQL Server applications.	<ul style="list-style-type: none"> <li>• Installing and upgrading IBM Spectrum Protect Snapshot for UNIX and Linux</li> <li>• Installing and upgrading IBM Spectrum Protect Snapshot for VMware</li> <li>• Installing and upgrading IBM Spectrum Protect Snapshot for Windows</li> </ul>
Protect an email application on an IBM Domino® server	IBM Spectrum Protect for Mail: Data Protection for IBM® Domino automates data protection so that backups are completed without shutting down IBM Domino servers.	<ul style="list-style-type: none"> <li>• Installation of Data Protection for IBM Domino on a UNIX, AIX, or Linux system (V7.1.0)</li> <li>• Installation of Data Protection for IBM Domino on a Windows system (V7.1.0)</li> </ul>
Protect an email application on a Microsoft Exchange server	IBM Spectrum Protect for Mail: Data Protection for Microsoft Exchange Server automates data protection so that backups are completed without shutting down Microsoft Exchange servers.	Installing, upgrading, and migrating IBM Spectrum Protect for Mail: Data Protection for Microsoft Exchange Server
Protect an IBM DB2 database	The application programming interface (API) of the backup-archive client can be used to back up DB2 data to the IBM Spectrum Protect server.	Installing the IBM Spectrum Protect backup-archive clients (UNIX, Linux, and Windows)
Protect an IBM Informix® database	The API of the backup-archive client can be used to back up Informix data to the IBM Spectrum Protect server.	Installing the IBM Spectrum Protect backup-archive clients (UNIX, Linux, and Windows)
Protect a Microsoft SQL database	IBM Spectrum Protect for Databases: Data Protection for Microsoft SQL Server protects Microsoft SQL data.	Installing Data Protection for SQL Server on Windows Server Core
Protect an Oracle database	IBM Spectrum Protect for Databases: Data Protection for Oracle protects Oracle data.	Data Protection for Oracle installation
Protect an SAP environment	IBM Spectrum Protect for Enterprise Resource Planning: Data Protection for SAP provides protection that is customized for SAP environments. The product is designed to improve the availability of SAP database servers and reduce administration workload.	<ul style="list-style-type: none"> <li>• Installing IBM Spectrum Protect for Enterprise Resource Planning: Data Protection for SAP for DB2</li> <li>• Installing IBM Spectrum Protect for Enterprise Resource Planning: Data Protection for SAP for Oracle</li> </ul>

Goal	Product and description	Installation instructions
Protect a virtual machine	<p>IBM Spectrum Protect for Virtual Environments provides protection that is tailored for Microsoft Hyper-V and VMware virtual environments. You can use IBM Spectrum Protect for Virtual Environments to create incremental forever backups that are stored on a centralized server, create backup policies, and restore virtual machines or individual files.</p> <p>Alternatively, use the backup-archive client to back up and restore a full VMware or Microsoft Hyper-V virtual machine. You can also back up and restore files or directories from a VMware virtual machine.</p>	<ul style="list-style-type: none"> <li>• Installing Data Protection for Microsoft Hyper-V</li> <li>• Installing and upgrading Data Protection for VMware</li> <li>• Installing the IBM Spectrum Protect backup-archive clients (UNIX, Linux, and Windows)</li> </ul>

Tip: To use the client for space management, you can install IBM Spectrum Protect for Space Management or IBM Spectrum Protect HSM for Windows.

## Specifying rules for backing up and archiving client data

Before you add a client, ensure that appropriate rules are specified for backing up and archiving the client data. During the client registration process, you assign the client node to a policy domain, which has the rules that control how and when client data is stored.

### Before you begin

Determine how to proceed:

- If you are familiar with the policies that are configured for your solution and you know that they do not require changes, continue with Scheduling backup and archive operations.
- If you are not familiar with the policies, follow the steps in this procedure.

### About this task

Policies affect how much data is stored over time, and how long data is retained and available for clients to restore. To meet objectives for data protection, you can update the default policy and create your own policies. A policy includes the following rules:

- How and when files are backed up and archived to server storage
- The number of copies of a file and the length of time copies are kept in server storage

During the client registration process, you assign a client to a *policy domain*. The policy for a specific client is determined by the rules in the policy domain to which the client is assigned. In the policy domain, the rules that are in effect are in the active *policy set*.

When a client backs up or archives a file, the file is bound to a management class in the active policy set of the policy domain. A *management class* is the key set of rules for managing client data. The backup and archive operations on the client use the settings in the default management class of the policy domain unless you further customize policy. A policy can be customized by defining more management classes and assigning their use through client options.

Client options can be specified in a local, editable file on the client system and in a client option set on the server. The options in the client option set on the server can override or add to the options in the local client option file.

### Procedure

1. Review the policies that are configured for your solution by following the instructions in Viewing policies.
2. If you need to make minor changes to meet data retention requirements, follow the instructions in Editing policies.
3. Optional: If you need to create policy domains or make extensive changes to policies to meet data retention requirements, see Customizing policies.

## Viewing policies

---

View policies to determine whether they must be edited to meet your requirements.

### Procedure

---

1. To view the active policy set for a policy domain, complete the following steps:
  - a. On the Services page of the Operations Center, select a policy domain and click Details.
  - b. On the Summary page for the policy domain, click the Policy Sets tab.
2. To view inactive policy sets for a policy domain, complete the following steps:
  - a. On the Policy Sets page, click the Configure toggle. You can now view and edit the policy sets that are inactive.
  - b. Scroll through the inactive policy sets by using the forward and back arrows. When you view an inactive policy set, the settings that differentiate the inactive policy set from the active policy set are highlighted.
  - c. Click the Configure toggle. The policy sets are no longer editable.

## Editing policies

---

To change the rules that apply to a policy domain, edit the active policy set for the policy domain. You can also activate a different policy set for a domain.

### Before you begin

---

Changes to policy can affect data retention. Ensure that you continue to back up data that is essential to your organization so that you can restore that data if a disaster occurs. Also, ensure that your system has sufficient storage space for planned backup operations.

### About this task

---

You edit a policy set by changing one or more management classes within the policy set. If you edit the active policy set, the changes are not available to clients unless you reactivate the policy set. To make the edited policy set available to clients, activate the policy set.

Although you can define multiple policy sets for a policy domain, only one policy set can be active. When you activate a different policy set, it replaces the currently active policy set.

To learn about preferred practices for defining policies, see Customizing policies.

### Procedure

---

1. On the Services page of the Operations Center, select a policy domain and click Details.
2. On the Summary page for the policy domain, click the Policy Sets tab.

The Policy Sets page indicates the name of the active policy set and lists all of the management classes for that policy set.

3. Click the Configure toggle. The policy set is editable.
4. Optional: To edit a policy set that is not active, click the forward and back arrows to locate the policy set.
5. Edit the policy set by completing any of the following actions:

Option	Description
<b>Add a management class</b>	<ol style="list-style-type: none"><li>a. In the Policy Sets table, click +Management Class.</li><li>b. To specify the rules for backing up and archiving data, complete the fields in the Add Management Class window.</li><li>c. To make the management class the default management class, select the Make default check box.</li><li>d. Click Add.</li></ol>
<b>Delete a management class</b>	In the Management Class column, click -. Tip: To delete the default management class, you must first assign a different management class as the default.

Option	Description
<b>Make a management class the default management class</b>	In the Default column for the management class, click the radio button. Tip: The default management class manages client files when another management class is not assigned to, or appropriate for managing, a file. To ensure that clients can always back up and archive files, choose a default management class that contains rules for both backing up and archiving files.
<b>Modify a management class</b>	To change the properties of a management class, update the fields in the table.

6. Click Save.

Attention: When you activate a new policy set, data might be lost. Data that is protected under one policy set might not be protected under another policy set. Therefore, before you activate a policy set, ensure that the differences between the previous policy set and the new policy set do not cause data to be lost.

7. Click Activate. A summary of the differences between the active policy set and the new policy set is displayed. Ensure that the changes in the new policy set are consistent with your data retention requirements by completing the following steps:
- Review the differences between corresponding management classes in the two policy sets, and consider the consequences for client files. Client files that are bound to management classes in the active policy set will be bound to the management classes with the same names in the new policy set.
  - Identify management classes in the active policy set that do not have counterparts in the new policy set, and consider the consequences for client files. Client files that are bound to these management classes will be managed by the default management class in the new policy set.
  - If the changes to be implemented by the policy set are acceptable, select the I understand that these updates can cause data loss check box and click Activate.

## Scheduling backup and archive operations

Before you register a new client with the server, ensure that a schedule is available to specify when backup and archive operations take place. During the registration process, you assign a schedule to the client.

### Before you begin

Determine how to proceed:

- If you are familiar with the schedules that are configured for the solution and you know that they do not require modification, continue with Registering clients.
- If you are not familiar with the schedules or the schedules require modification, follow the steps in this procedure.

### About this task

Typically, backup operations for all clients must be completed daily. Carefully schedule client and server workloads to achieve the best performance for your storage environment. To avoid the overlap of client and server operations, consider scheduling client backup and archive operations so that they run at night. If client and server operations overlap or are not given enough time and resources to be processed, you might experience decreased system performance, failed operations, and other issues.

### Procedure

- Review available schedules by hovering over Clients on the Operations Center menu bar. Click Schedules.
- Optional: Modify or create a schedule by completing the following steps:

Option	Description
<b>Modify a schedule</b>	<ol style="list-style-type: none"> <li>In the Schedules view, select the schedule and click Details.</li> <li>On the Schedule Details page, view details by clicking the blue arrows at the beginning of the rows.</li> <li>Modify the settings in the schedule, and click Save.</li> </ol>
<b>Create a schedule</b>	In the Schedules view, click +Schedule and complete the steps to create a schedule.

- Optional: To configure schedule settings that are not visible in the Operations Center, use a server command. For example, you might want to schedule a client operation that backs up a specific directory and assigns it to a management class other than the default.

a. On the Overview page of the Operations Center, hover over the settings icon  and click Command Builder.

- b. Issue the DEFINE SCHEDULE command to create a schedule or the UPDATE SCHEDULE command to modify a schedule. For details about the commands, see DEFINE SCHEDULE (Define a schedule for an administrative command) or UPDATE SCHEDULE (Update a client schedule).

**Related tasks:**

[🔗 Tuning the schedule for daily operations](#)

## Registering clients

---

Register a client to ensure that the client can connect to the server, and the server can protect client data.

### Before you begin

---

Determine whether the client requires an administrative user ID with client owner authority over the client node. To determine which clients require an administrative user ID, see technote 7048963.

Restriction: For some types of clients, the client node name and the administrative user ID must match. You cannot authenticate those clients by using the Lightweight Directory Access Protocol authentication method that was introduced in V7.1.7. For details about this authentication method, sometimes referred to as integrated mode, see Authenticating users by using an Active Directory database.

### Procedure

---

To register a client, complete one of the following actions.

- If the client requires an administrative user ID, register the client by using the REGISTER NODE command and specify the USERID parameter:

```
register node node_name password userid=node_name
```

where *node\_name* specifies the node name and *password* specifies the node password. For details, see Register a node.

- If the client does not require an administrative user ID, register the client by using the Operations Center Add Client wizard. Complete the following steps:
  - a. On the Operations Center menu bar, click Clients.
  - b. In the Clients table, click +Client.
  - c. Complete the steps in the Add Client wizard:
    - i. Specify that redundant data can be eliminated on both the client and server. In the Client-side data deduplication area, select the Enable check box.
    - ii. In the Configuration window, copy the TCPSERVERADDRESS, TCPPORT, NODENAME, and DEDUPLICATION option values.

Tip: Record the option values and keep them in a safe place. After you complete the client registration and install the software on the client node, use the values to configure the client.
    - iii. Follow the instructions in the wizard to specify the policy domain, schedule, and option set.
    - iv. Set how risks are displayed for the client by specifying the at-risk setting.
    - v. Click Add Client.

**Related reference:**

- [🔗 DECOMMISSION NODE \(Decommission a client node\)](#)
- [🔗 DECOMMISSION VM \(Decommission a virtual machine\)](#)
- [🔗 QUERY NODE \(Query nodes\)](#)
- [🔗 REMOVE REPLNODE \(Remove a client node from replication\)](#)

## Installing and configuring clients

---

To start protecting a client node, you must install and configure the selected software.

### Procedure

---

If you already installed the software, start at step 2.

1. Take one of the following actions:
  - To install software on an application or client node, follow the instructions.

Software	Link to instructions
IBM Spectrum Protect™ backup-archive client	<ul style="list-style-type: none"> <li>▪ Installing the UNIX and Linux backup-archive clients</li> <li>▪ Installing the Windows backup-archive client</li> </ul> <p>For information about manual deployment of client updates from the server, see the following documents:</p> <ul style="list-style-type: none"> <li>▪ For IBM Spectrum Protect 8.1.2 or later servers, see technote 2004596.</li> <li>▪ For IBM® Tivoli® Storage Manager V7.1 servers and IBM Spectrum Protect V8.1.0 and V8.1.1 servers, see technote 1673299.</li> </ul>
IBM Spectrum Protect for Databases	<ul style="list-style-type: none"> <li>▪ Data Protection for Oracle installation</li> <li>▪ Installing Data Protection for SQL Server on Windows Server Core</li> </ul>
IBM Spectrum Protect for Mail	<ul style="list-style-type: none"> <li>▪ Installation of Data Protection for IBM Domino on a UNIX, AIX, or Linux system (V7.1.0)</li> <li>▪ Installation of Data Protection for IBM Domino on a Windows system (V7.1.0)</li> <li>▪ Installing, upgrading, and migrating IBM Spectrum Protect for Mail: Data Protection for Microsoft Exchange Server</li> </ul>
IBM Spectrum Protect Snapshot	<ul style="list-style-type: none"> <li>▪ Installing and upgrading IBM Spectrum Protect Snapshot for UNIX and Linux</li> <li>▪ Installing and upgrading IBM Spectrum Protect Snapshot for VMware</li> <li>▪ Installing and upgrading IBM Spectrum Protect Snapshot for Windows</li> </ul>
IBM Spectrum Protect for Enterprise Resource Planning	<ul style="list-style-type: none"> <li>▪ Installing IBM Spectrum Protect for Enterprise Resource Planning: Data Protection for SAP for DB2®</li> <li>▪ Installing IBM Spectrum Protect for Enterprise Resource Planning: Data Protection for SAP for Oracle</li> </ul>

- o To install software on a virtual machine client node, follow the instructions for the selected backup type.

Backup type	Link to instructions
If you plan to create full VMware backups of virtual machines, install and configure the IBM Spectrum Protect backup-archive client.	<ul style="list-style-type: none"> <li>▪ Installing the UNIX and Linux backup-archive clients</li> <li>▪ Installing the Windows backup-archive client</li> </ul>
If you plan to create incremental forever full backups of virtual machines, install and configure IBM Spectrum Protect for Virtual Environments and the backup-archive client on the same client node or on different client nodes.	<ul style="list-style-type: none"> <li>▪ IBM Spectrum Protect for Virtual Environments online product documentation</li> </ul> <p>Tip: You can obtain the software for IBM Spectrum Protect for Virtual Environments and the backup-archive client in the IBM Spectrum Protect for Virtual Environments installation package.</p>

2. To allow the client to connect to the server, add or update the values for the TCPSERVERADDRESS, TCPPORT, and NODENAME options in the client options file. Use the values that you recorded when you registered the client (Registering clients).
  - o For clients that are installed on an AIX®, Linux, Mac OS X, or Oracle Solaris operating system, add the values to the client system-options file, dsm.sys.
  - o For clients that are installed on a Windows operating system, add the values to the dsm.opt file.

By default, the options files are in the installation directory.
3. If you installed a backup-archive client on a Linux or Windows operating system, install the client management service on the client. Follow the instructions in Collecting diagnostic information with client management services.
4. Configure the client to run scheduled operations. Follow the instructions in Configuring the client to run scheduled operations.
5. Optional: Configure communications through a firewall. Follow the instructions in Configuring client/server communications through a firewall.
6. Run a test backup to verify that data is protected as you planned. For example, for a backup-archive client, complete the following steps:
  - a. On the Clients page of the Operations Center, select the client that you want to back up, and click Back Up.
  - b. Verify that the backup completes successfully and that there are no warning or error messages.
7. Monitor the results of the scheduled operations for the client in the Operations Center.



## What to do next

---

If you need to change what is getting backed up from the client, follow the instructions in [Modifying the scope of a client backup](#).

## Configuring the client to run scheduled operations

---

You must configure and start a client scheduler on the client node. The client scheduler enables communication between the client and server so that scheduled operations can occur. For example, scheduled operations typically include backing up files from a client.

### About this task

---

The preferred method is to install the backup-archive client on all client nodes so that you can configure and start the client acceptor on the client node. The client acceptor is designed to efficiently run scheduled operations. The client acceptor manages the client scheduler so that the scheduler runs only when required:

- When it is time to query the server about the next scheduled operation
- When it is time to start the next scheduled operation

By using the client acceptor, you can reduce the number of background processes on the client and help to avoid memory retention problems.

The client acceptor runs schedules for the following products: the backup-archive client, IBM Spectrum Protect™ for Databases, IBM Spectrum Protect for Enterprise Resource Planning, IBM Spectrum Protect for Mail, and IBM Spectrum Protect for Virtual Environments. If you installed a product for which the client acceptor does not run schedules, follow the configuration instructions in the product documentation to ensure that scheduled operations can occur.

If your business uses a third-party scheduling tool as standard practice, you can use that scheduling tool as an alternative to the client acceptor. Typically, third-party scheduling tools start client programs directly by using operating system commands. To configure a third-party scheduling tool, see the product documentation.

### Procedure

---

To configure and start the client scheduler by using the client acceptor, follow the instructions for the operating system that is installed on the client node:

AIX® and Oracle Solaris

- a. From the backup-archive client GUI, click Edit > Client Preferences.
- b. Click the Web Client tab.
- c. In the Managed Services Options field, click Schedule. If you also want the client acceptor to manage the web client, click the Both option.
- d. To ensure that the scheduler can start unattended, in the `dsm.sys` file, set the `passwordaccess` option to `generate`.
- e. To store the client node password, issue the following command and enter the client node password when prompted:

```
dsmc query sess
```

- f. Start the client acceptor by issuing the following command on the command line:

```
/usr/bin/dsmcad
```

- g. To enable the client acceptor to start automatically after a system restart, add the following entry to the system startup file (typically, `/etc/inittab`):

```
tsm::once:/usr/bin/dsmcad > /dev/null 2>&1 # Client Acceptor Daemon
```

Linux

- a. From the backup-archive client GUI, click Edit > Client Preferences.
- b. Click the Web Client tab.
- c. In the Managed Services Options field, click Schedule. If you also want the client acceptor to manage the web client, click the Both option.
- d. To ensure that the scheduler can start unattended, in the `dsm.sys` file, set the `passwordaccess` option to `generate`.

- e. To store the client node password, issue the following command and enter the client node password when prompted:

```
dsmc query sess
```

- f. Start the client acceptor by logging in with the root user ID and issuing the following command:

```
service dsmcad start
```

- g. To enable the client acceptor to start automatically after a system restart, add the service by issuing the following command at a shell prompt:

```
# chkconfig --add dsmcad
```

## MAC OS X

- a. In the backup-archive client GUI, click Edit > Client Preferences.
- b. To ensure that the scheduler can start unattended, click Authorization, select Password Generate, and click Apply.
- c. To specify how services are managed, click Web Client, select Schedule, click Apply, and click OK.
- d. To ensure that the generated password is saved, restart the backup-archive client.
- e. Use the IBM Spectrum Protect Tools for Administrators application to start the client acceptor.

## Windows

- a. In the backup-archive client GUI, click Utilities > Setup Wizard > Help me configure the Client Scheduler. Click Next.
- b. Read the information on the Scheduler Wizard page and click Next.
- c. On the Scheduler Task page, select Install a new or additional scheduler and click Next.
- d. On the Scheduler Name and Location page, specify a name for the client scheduler that you are adding. Then, select Use the Client Acceptor daemon (CAD) to manage the scheduler and click Next.
- e. Enter the name that you want to assign to this client acceptor. The default name is Client Acceptor. Click Next.
- f. Complete the configuration by stepping through the wizard.
- g. Update the client options file, dsm.opt, and set the passwordaccess option to generate.
- h. To store the client node password, issue the following command at the command prompt:

```
dsmc query sess
```

Enter the client node password when prompted.

- i. Start the client acceptor service from the Services Control page. For example, if you used the default name, start the Client Acceptor service. Do not start the scheduler service that you specified on the Scheduler Name and Location page. The scheduler service is started and stopped automatically by the client acceptor service as needed.

## Configuring client/server communications through a firewall

---

If a client must communicate with a server through a firewall, you must enable client/server communications through the firewall.

### Before you begin

---

If you used the Add Client wizard to register a client, find the option values in the client options file that you obtained during that process. You can use the values to specify ports.

### About this task

---

**Attention:** Do not configure a firewall in a way that might cause termination of sessions that are in use by a server or storage agent. Termination of a valid session can cause unpredictable results. Processes and sessions might appear to stop due to input/output errors. To help exclude sessions from timeout restrictions, configure known ports for IBM Spectrum Protect™ components. Ensure that the KEEPALIVE server option remains set to the default value of YES. In this way, you can help to ensure that client/server communication is uninterrupted. For instructions about setting the KEEPALIVE server option, see KEEPALIVE.

### Procedure

---

Open the following ports to allow access through the firewall:

TCP/IP port for the backup-archive client, command-line administrative client, and the client scheduler

Specify the port by using the `tcpport` option in the client options file. The `tcpport` option in the client options file must match the `TCPPORT` option in the server options file. The default value is 1500. If you decide to use a value other than the default, specify a number in the range 1024 - 32767.

HTTP port to enable communication between the web client and remote workstations

Specify the port for the remote workstation by setting the `httpport` option in the client options file of the remote workstation. The default value is 1581.

TCP/IP ports for the remote workstation

The default value of 0 (zero) causes two free port numbers to be randomly assigned to the remote workstation. If you do not want the port numbers to be randomly assigned, specify values by setting the `webports` option in the client options file of the remote workstation.

TCP/IP port for administrative sessions

Specify the port on which the server waits for requests for administrative client sessions. The value of the client `tcpadminport` option must match the value of the `TCPADMINPORT` server option. In this way, you can secure administrative sessions within a private network.

## Customizing policies

---

An organization's goals for how data is protected and retained are typically defined by corporate executives, legal advisors, or other people in lead roles. *Policies* are the means to align the operation of IBM Spectrum Protect™ with the data protection and retention goals of your organization.

### About this task

---

To automatically manage data protection and retention, you define policies, which are rules that you set on the server. Policies affect how much data is stored over time, and how long data is retained and available for clients to restore. Customize policies to meet the data protection goals for your organization.

You choose the policy that manages a client's data by assigning the client to a policy domain. Clients of different types have different retention requirements, and customizing and creating policies is typically necessary.

When a server is installed, by default it has one policy, in one policy domain. You can customize that policy and create your own policy.

- **Policy concepts**  
The policy for a specific client is determined by the settings in the policy domain to which a client is added.
- **Customizing a policy**  
You can customize existing policies to meet new or revised data retention requirements for your organization. Modifying a policy domain or copying an existing policy domain is a typical way to start customizing policy.
- **Creating a policy by copying an existing policy**  
You can create new policies by copying an existing policy and then updating the parts that you want to change.
- **Creating a policy domain**  
You might want to create a new policy domain for each type of client that is protected by the server. You might also want to divide responsibilities for clients among several administrators by giving them authority for specific policy domains.
- **Controlling client operations through client option sets**  
You can use client option sets to centrally control the processing options that clients use for operations such as backup. Client option sets can help ensure that data is consistently protected according to your requirements. A client option set can override options in a local client options file, and can add options that might not be in a local client options file.

## Policy concepts

---

The policy for a specific client is determined by the settings in the policy domain to which a client is added.

During the client registration process, you assign a client to a *policy domain*. The policy for each client is determined by the rules in the policy domain to which the client is assigned. In the policy domain, the rules that are in effect are in the active *policy set*.

When a client backs up or archives a file, the file is bound to a management class in the active policy set of the policy domain. A *management class* is the key set of rules for managing client data. The backup and archive operations on the client use the settings in the default management class of the policy domain unless you customize policy.

A policy can be customized by defining more management classes in the policy set, activating the policy set, and assigning the use of the new management classes through client options.

Client options can be specified in a local, editable file on the client system and in a client option set on the server. The options in the client option set on the server can override or add to the options in the local client option file.

The server uses the policy in management classes to manage files based on whether file versions are active or inactive. The most recent backup or archived copy of a file is the *active version*. Active versions are never deleted from server storage.

Backup versions other than the most recent version are called *inactive versions*. An active version of a file becomes inactive when one of the following events occur:

- The file is backed up again, creating a more recent version of the file in server storage.
- The file is deleted from storage on the client node and then an incremental backup operation runs. An *incremental backup*, the typical backup operation for a client, backs up only those files that changed since the last backup.

The settings in the management class that is bound to a file determine how long and how many inactive versions of the file are retained.

*Expiration processing* uses policies to determine when inactive versions are no longer needed, that is, when the versions are expired. The process of expiration on the server enforces policies that you define for data retention, and you must ensure that you schedule expiration to run regularly. For example, if you have a policy that requires only four versions of a file be kept, the fifth and oldest version is expired. During expiration processing, the server removes entries for expired versions from the database, which in effect deletes the versions from server storage.

- Retention and expiration of backup versions  
Multiple versions of file backups are important because users can continually update files and might need to restore a file from different points in time. Policy settings control the backup versions that the server retains in server storage, and affects what users can restore.
- Policy activation after updates  
When you make updates to policy, the updates do not go into effect until you activate the policy set that you updated.

**Related concepts:**

[Full incremental backup and partial incremental backup](#)

## Retention and expiration of backup versions

---

Multiple versions of file backups are important because users can continually update files and might need to restore a file from different points in time. Policy settings control the backup versions that the server retains in server storage, and affects what users can restore.

You can specify the versions that the server retains in server storage with settings in the management class:

- Specify the number of days to keep backup versions.  
You specify the number of days to keep backup versions with settings in the Operations Center:
  - Keep Extra Backups, which is how many days to keep inactive backup versions. The days are counted from the day that the version becomes inactive.  
  
If you use commands, use the DEFINE COPYGROUP command with the RETEXTRA parameter.
  - Keep Deleted Backups, which is how many days to keep the last backup version of a file that is deleted from the client file system.  
  
If you use commands, use the DEFINE COPYGROUP command with the RETONLY parameter.
- Specify the number of versions to keep.  
You specify the number of backup versions to keep with settings in the Operations Center:
  - Backups, which is the number of versions to keep of a file that still exists on the client file system.  
  
If you use commands, use the DEFINE COPYGROUP command with the VEREXISTS parameter.
  - Deleted Backups, which is the number of versions to keep of a file that is deleted from the client file system.  
  
If you use commands, use the DEFINE COPYGROUP command with the VERDELETED parameter.
- Specify a combination of the number of versions and the days to keep them.

The settings interact to determine the backup versions that the server retains. Ensure that you understand which settings take precedence and what interactions can occur:

- When the number of inactive backup versions exceeds the number in the Backups and Deleted Backups settings, the oldest version expires and the server deletes the version from the database the next time expiration processing runs.
  - The number of inactive versions that the server keeps is also affected by the Keep Extra Backups setting. Inactive versions expire when the number of days that they are inactive exceeds the value that is specified for retaining extra versions, even when the number of versions is not exceeded.
- File expiration and expiration processing  
Files expire as they exceed the retention criteria that is specified in the policy. Expiration processing on the server removes expired files from the server database and the files are deleted from server storage.
  - Example: Retention when a policy uses only time controls  
The simplest way to manage data retention is to use only time-based policy controls. With only time-based controls in the policy, the file versions are retained based on the days since the versions become inactive.
  - Example: Retention when a policy uses both version and time controls  
Using both the version and the time controls in a policy gives you flexibility in managing data retention but also causes complexity. To understand the interactions among the controls, review example policies and their effects on the retention of one file's backup versions during one month.
  - Interactions among policy settings  
Time-based and version-based policy settings interact when used together in a management class for a policy. The frequency of client backups also affects the backup versions that are stored for a client.

## File expiration and expiration processing

---

Files expire as they exceed the retention criteria that is specified in the policy. Expiration processing on the server removes expired files from the server database and the files are deleted from server storage.

Files expire under the following conditions:

- Users delete file spaces from client nodes
- Users expire files by using the EXPIRE command on the client
- A backup version of a file exceeds the criteria for backup retention (how long a file is kept and how many inactive versions of a file are kept)
- An archived file exceeds the time criteria for retention of archived files (how long archived copies are kept)
- A backup set exceeds the retention time that is specified for the backup set

The server deletes expired files from the server database only during expiration processing. After expired files are deleted from the database, the server can reuse the space in the storage pools that was occupied by expired files. Ensure that expiration processing runs periodically to allow the server to reuse space.

## Restrictions on expiration processing

---

The use of some functions affects expiration processing.

### Replication

If you are using dissimilar policies on the source and target servers, files that are marked for immediate expiration on the source replication server are not deleted until they are replicated to the target replication server. If you are not using dissimilar policies, files that are marked for immediate expiration on the source replication server are deleted immediately.

For the target replication server, if files are marked as expired, they are deleted when the target replication server runs expiration processing.

### Event-based retention for archive data

An archive file is not eligible for expiration if there is a deletion hold on it. If a file is not held, it is handled according to existing expiration processing.

### Related tasks:

[Expiration/deletion hold and release](#)

## Example: Retention when a policy uses only time controls

---

The simplest way to manage data retention is to use only time-based policy controls. With only time-based controls in the policy, the file versions are retained based on the days since the versions become inactive.

For a policy that is based only on time, you use the Keep Extra Backups and Keep Deleted Backups controls. This type of policy does not limit the number of versions of files. If clients back up frequently, ensure that server storage can handle the potential number of file versions.

The following figure shows how files from a client are handled by the server over time as the client runs a daily incremental backup operation.

In this example, the policy has the following characteristics:

- The latest version of a file is always retained, as long as the file still exists on the client system. The latest version is the active version. This characteristic is part of every policy on the server.
- Keep Extra Backups is set to 30 days. After a more recent backup is made, a file version becomes inactive and is kept in server storage for 30 days.
- Keep Deleted Backups is set to 60 days. When a file is deleted from the client system, all versions of the file in server storage become inactive. These inactive versions are kept for 60 days after the file versions become inactive.

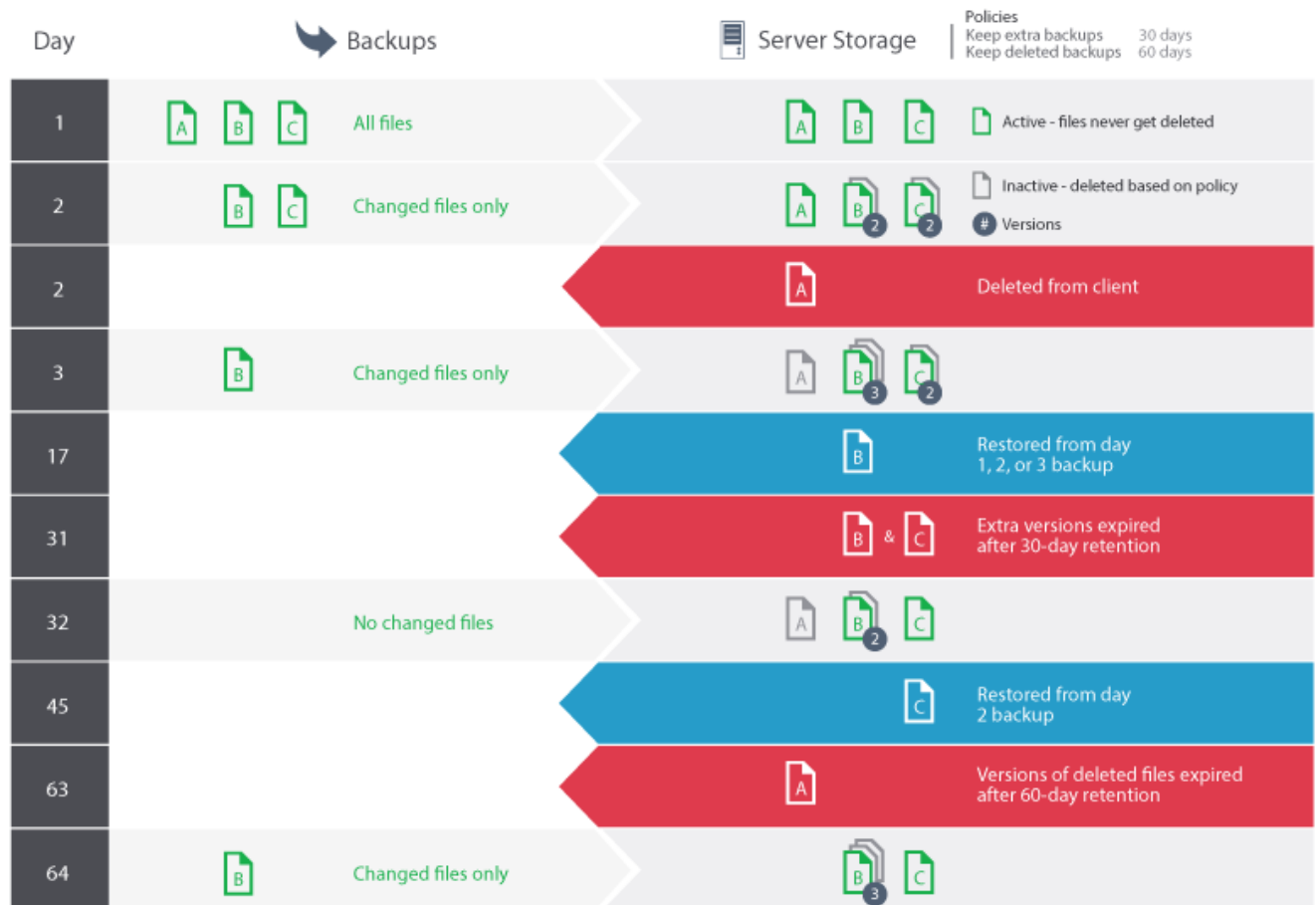

## Example: Retention when a policy uses both version and time controls

Using both the version and the time controls in a policy gives you flexibility in managing data retention but also causes complexity. To understand the interactions among the controls, review example policies and their effects on the retention of one file's backup versions during one month.

See Table 1 and Figure 1. A client backs up the file REPORT.TXT four times in one month, from 23 March to 23 April. The settings in the backup copy group of the management class to which REPORT.TXT is bound determine how the server treats these backup versions. Table 2 shows how different copy group settings can affect the versions, as of 24 April (one day after the file was last backed up).

Table 1. Status of REPORT.TXT backup versions as of 24 April

Version	Date created	Days since the version became inactive
Active	23 April	(not applicable)
Inactive 1	13 April	1 (since 23 April)
Inactive 2	31 March	11 (since 13 April)
Inactive 3	23 March	24 (since 31 March)

Figure 1. Active and inactive versions of REPORT.TXT

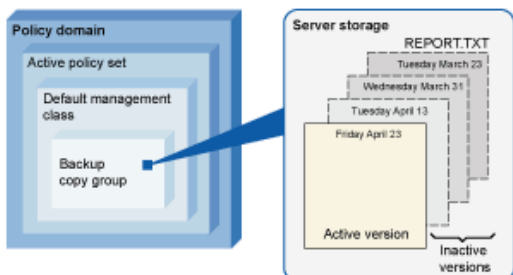

Table 2. Effects of the policy on retention of backup versions for REPORT.TXT as of 24 April

Backups	Deleted Backups	Keep Extra Backups	Keep Deleted Backups	Results
4 versions	2 versions	60 days	180 days	<p>Backups and Keep Extra Backups settings control the expiration of the versions. The version that is created on 23 March is retained until the file is backed up again (creating a fourth inactive version), or until that version is inactive for 60 days.</p> <p>If the user deletes the REPORT.TXT file from the client file system, the server notes the deletion at the next full incremental backup operation by the client. From that point, the Deleted Backups and Keep Deleted Backups settings also affect the retention. All versions are now inactive.</p> <p>Two of the four versions expire immediately (the 23 March and 31 March versions expire). The 13 April version expires when it is inactive for 60 days (on 23 June). The server keeps the last remaining inactive version, the 23 April version, for 180 days after it becomes inactive.</p>
No limit	2 versions	60 days	180 days	<p>Keep Extra Backups setting controls expiration of the versions. The inactive versions (other than the last remaining version) are expired when they are inactive for 60 days.</p> <p>If the user deletes the REPORT.TXT file from the client node, the server notes the deletion at the next full incremental backup operation by the client. From that point, the Deleted Backups and Keep Deleted Backups settings also affect the retention. All versions are now inactive.</p> <p>Two of the four versions expire immediately (the 23 March and 31 March versions expire) because only two versions are allowed. The 13 April version expires when it is inactive for 60 days (on 22 June). The server keeps the last remaining inactive version, the 23 April version, for 180 days after it becomes inactive.</p>

Backups	Deleted Backups	Keep Extra Backups	Keep Deleted Backups	Results
No limit	No limit	60 days	180 days	<p>Keep Extra Backups setting controls expiration of the versions. The server does not expire inactive versions based on the maximum number of backup copies. The inactive versions (other than the last remaining version) are expired when they are inactive for 60 days.</p> <p>If the user deletes the REPORT.TXT file from the client node, the server notes the deletion at the next full incremental backup operation by the client node. From that point, the Keep Deleted Backups setting also affects the retention. All versions are now inactive.</p> <p>Three of the four versions expire after each of them is inactive for 60 days. The server keeps the last remaining inactive version, the 23 April version, for 180 days after it becomes inactive.</p>
4 versions	2 versions	No limit	No limit	<p>Backups setting controls the expiration of the versions until a user deletes the file from the client node. The server does not expire inactive versions based on age.</p> <p>If the user deletes the REPORT.TXT file from the client node, the server notes the deletion at the next full incremental backup operation by the client node. From that point, the Deleted Backups setting controls expiration. All versions are now inactive.</p> <p>Two of the four versions expire immediately (the 23 March and 31 March versions expire) because only two versions are allowed. The server keeps the two remaining inactive versions indefinitely.</p>

**Related concepts:**

➔ Full incremental backup and partial incremental backup

## Interactions among policy settings

Time-based and version-based policy settings interact when used together in a management class for a policy. The frequency of client backups also affects the backup versions that are stored for a client.

For a client system that must back up twice a day, consider the effects of the following policy choices on a file that changes frequently:

- You set Keep Extra Backups to 30 days. You set Backups to No limit so that the policy does not limit the number of versions. After 30 days, the server might have 60 backup versions of the file, if the file changes between each of the two daily backup operations. The client can choose to restore any of the 60 versions from the past 30 days.
- You set Keep Extra Backups to No limit, and set Backups to 30 versions. If the file changes between each of the two daily backup operations, the server has 30 backup versions after 15 days. After 30 days, the server still has only 30 backup versions because of the limit on the number of versions. If the file continues to change between each of the two daily backup operations, the backup versions might be from as few as the last 15 days. The client can choose to restore one of the 30 versions, which might be no older than 15 days.

The examples show that if backup versions must be available for a specific number of days, the simplest way to implement that requirement is to use a time-based policy. Set Keep Extra Backups to the specific number of days and set Backups to No limit.

The effect of the No limit value in the policy settings varies according to what other policy controls are set:

### Keep Extra Backups

If you specify No limit, inactive backup versions are deleted based on the Backups or Deleted Backups settings.

To enable client nodes to restore files to a specific point in time, set the Backups or Deleted Backups to No limit. Set Keep Extra Backups to the number of days that you expect clients might need versions of files available for possible point-in-time restoration. For example, to enable clients to restore files from a point in time 60 days in the past, set Keep Extra Backups to 60.



## Keep Deleted Backups

If you specify No limit, the last version is retained forever unless a user or an administrator deletes the file from server storage.

## Backups

Setting the value to No limit can require increased storage, but that value might be necessary to specify for some situations. For example, to enable client nodes to restore files to a specific point in time, set the value for Backups to No limit. By not setting a limit on versions, you ensure that the server retains versions according to the Keep Extra Backups setting.

## Deleted Backups

Setting the value to No limit can require increased storage, but that value might be necessary to specify for some situations. For example, set the value for Deleted Backups to No limit to enable clients to restore files to a specific point in time. By not setting a limit on versions, you ensure that the server retains versions according to the Keep Extra Backups setting.

## Cross-reference for Operations Center fields and server command parameters

The following table shows the Operations Center fields with the equivalent parameter to use with the `DEFINE COPYGROUP TYPE=BACKUP` command.

Field name in Operations Center views	Parameter to use with the <code>DEFINE COPYGROUP TYPE=BACKUP</code> command
Keep Extra Backups	RETEXTRA
Keep Deleted Backups	REONLY
Backups	VEREXISTS
Deleted Backups	VERDELETED

## Policy activation after updates

When you make updates to policy, the updates do not go into effect until you activate the policy set that you updated.

Policy set activation puts into effect updates that you made. For example, the following types of updates go into effect after you activate the policy set:

- You define a new policy domain with a policy set and one or more management classes
- You add a management class to a policy set
- You change the backup retention settings in an existing management class

## Policy set validation before activation

In the Operations Center, validation is not a separate step. If you are using commands, validation is an optional command that gives you an opportunity to preview the effect of activating a changed policy set. When you validate a policy set, the server reports on conditions that might cause problems if the policy set is activated.

Validation fails if the policy set does not contain a default management class. Validation results in warning messages if any of the conditions that are shown in Table 1 exist.

Table 1. Conditions that cause warnings during policy set validation

Condition	Reason for warning
The storage destinations that are specified for backup, archive, or migration operations are not defined storage pools.	A storage pool must exist before you can specify it as a destination.
A storage destination that is specified for backup, archive, or migration operations is a copy storage pool or an active-data pool.	The storage destination must be a primary storage pool.
The default management class does not contain backup or archive settings.	When the default management class does not contain backup or archive settings, any files that are bound to the default management class are not backed up or archived.

Condition	Reason for warning
The current active policy set names a management class that is not defined in the policy set that is being validated.	<p>When you back up files that were bound to a management class that no longer exists in the active policy set, backup versions are rebound to the default management class.</p> <p>When the management class to which an archive copy is bound no longer exists and the default management class does not contain archive settings, the server uses the archive retention grace period to manage the retention of the archive copy.</p> <p>The archive retention grace period is set for a policy domain, and that setting is used only when no other policy setting is available to manage an archive copy.</p>
The current active policy set contains backup settings that are not defined in the policy set that is being validated.	<p>When a client backs up a file and the management class to which the file is bound no longer has backup settings, backup versions are managed by the default management class.</p> <p>If the default management class does not contain any backup settings, the server uses the backup retention grace period to manage file versions. However, the file is not backed up in the next backup operation.</p> <p>The backup retention grace period is set for a policy domain, and that setting is used only when no other policy setting is available to manage a backup version.</p>
A management class specifies that a backup version must exist before a file can be migrated from a client node, but the management class does not contain backup settings.	This warning applies only if you are using the IBM Spectrum Protect™ for Space Management product. The conflicts within the management class can cause problems for IBM Spectrum Protect for Space Management clients.

## Policy set activation

When you activate a policy set, the server validates the contents of the policy set and copies the policy set to be the active policy set. To later change the contents of the active policy set, you must create or change another policy set and then activate that policy set.

Some updates to a policy have an immediate effect when it is activated, but some other updates do not:

- Updates to Keep Extra Backups and Keep Deleted Backups settings are immediately applied to data already in server storage, and to future backups.  
If you use commands, these settings are the RETEXTRA and RETONLY parameters for the DEFINE COPYGROUP or UPDATE COPYGROUP commands.
- Updates to Backups and Deleted Backups settings do not take effect for client data until the clients complete the next backup operation.  
If you use commands, these settings are the VEREXISTS and VERDELETED parameters for the DEFINE COPYGROUP or UPDATE COPYGROUP commands.

## Restrictions for servers that use the feature for data retention protection

If the feature for data retention protection is active, more rules apply when you validate and activate a policy set. The feature for data retention protection is activated by using the SET ARCHIVERETENTIONPROTECTION command on a server that does not yet have any client data.

If data retention protection is active for a server, more rules must be satisfied before the policy is activated:

- If a management class exists in the active policy set, a management class with the same name must exist in the policy set that is being activated.
- All management classes in the policy set that is being activated must contain archive retention settings.
- If the active policy set includes archive retention settings in a management class, the policy set that is being activated must have archive retention values at least as large as the corresponding values in the active policy set.

If the server is a managed server in an enterprise configuration, the server might receive policy updates from the server that is the configuration manager. Policy updates that are received by the managed server from the configuration manager must also satisfy the preceding rules.

**Related concepts:**

[Enterprise configuration \(V7.1.1\)](#)

**Related reference:**

SET ARCHIVERETENTIONPROTECTION (Activate data retention protection)

## Customizing a policy

---

You can customize existing policies to meet new or revised data retention requirements for your organization. Modifying a policy domain or copying an existing policy domain is a typical way to start customizing policy.

### About this task

---

The key policy settings are in management classes. In the management classes, you can control both the number of backup versions and the number of days that backup versions are kept in server storage. When you use both types of controls, the policy is more complex. By controlling only the number of days that backup versions are kept, you can more simply define how long backed-up data is kept.

Ensure that the default management class in a policy domain has appropriate settings for data retention for most or all of the clients that are assigned to the domain. The retention settings in the default management class are applied to data when client operations do not specify a management class.

You can work on updates to a policy and save the changes until a later time. When you are satisfied that the draft changes are ready, you can activate the updated policy set to put the changes into effect.

### Procedure

---

1. On the Overview page of the Operations Center, click the Services menu.
2. Select the policy domain and click Details. Click Policy Sets.
3. Click the Configure toggle so that you can update the settings.
4. Customize the settings in the management class.
  - a. Make selections for backup services. For example, update the following items so that inactive backup versions for the clients are retained for 30 days:
    - Backups: No limit
    - Keep Extra Backups: 30 days
    - Deleted Backups: 1
    - Keep Deleted Backups: No limit
  - b. Optional: Make selections for archive services. For example, change the Keep Archives setting to 1 year.
  - c. Click Save.
5. Optional: Click +Management Class to add a management class.
  - a. Make selections for the basic settings, and click Add.
  - b. Customize more settings in the new management class. For backup services, make selections in the following columns: Backup Destination, Backups, Keep Extra Backups, Deleted Backups, and Keep Deleted Backups. For archive services, make selections in the Archive Destination and Keep Archives columns.
  - c. Click Save.
6. In the Default column, ensure that an appropriate management class is selected as the default. The retention settings in the default management class are applied when client operations do not specify a management class. A management class can be specified when a client operation is run. A management class can also be specified in a client option file that is on the client system, or in a client option set that is defined on the server.
7. Activate the policy set by clicking Activate.
8. Assign client nodes to the new policy domain by either updating existing client nodes or registering new nodes.
  - o To add new clients to the policy domain, click +Client.
  - o To move an existing client to the policy domain, select the client, click Details, and then click the Properties tab. Select the new policy domain and click Save.

Data retention for the client that you assign to the policy domain is now controlled by that policy.

Requirement: If a client is running when you assign it to a new domain, you must stop and restart the client for the change to take effect.

**Related tasks:**

## Creating a policy by copying an existing policy

---

You can create new policies by copying an existing policy and then updating the parts that you want to change.

### Procedure

---

You can create a policy by copying a policy domain, updating the management classes, and then assigning clients to the new domain.

1. On the Overview page of the Operations Center, hover over the settings icon  and click Command Builder.
2. Copy a policy domain by using the COPY DOMAIN command. For example, copy the default policy domain, STANDARD, to a new policy domain, NEWDOMAIN:

```
copy domain standard newdomain
```

This operation copies the policy domain and all associated policy sets and management classes. In this example, the operation copies the following items into the NEWDOMAIN policy domain:

- o A policy set, named STANDARD.
  - o The management class that is named STANDARD, which is in the STANDARD policy set.
  - o The copy groups that the STANDARD management class contains:
    - The backup copy group, named STANDARD
    - The archive copy group, named STANDARD
3. On the Overview page of the Operations Center, click the Services menu.
  4. Select the new policy domain and click Details. Click Policy Sets.
  5. Click the Configure toggle so that you can update the settings.
  6. Customize the settings in the management classes.
    - a. Make selections for backup services. For example, update the following items so that inactive backup versions for the clients are retained for 30 days:
      - Backups: No limit
      - Keep Extra Backups: 30 days
      - Deleted Backups: 1
      - Keep Deleted Backups: No limit
    - b. Optional: Make selections for archive services. For example, change the Keep Archives setting to 1 year.
    - c. Click Save.
  7. Optional: Make other updates and additions, such as adding a management class.
    - a. Click +Management Class to add a management class. Make selections for the basic settings, and click Add.
    - b. Customize more settings in the new management class. For backup services, make selections in the following columns: Backup Destination, Backups, Keep Extra Backups, Deleted Backups, and Keep Deleted Backups. For archive services, make selections in the Archive Destination and Keep Archives columns.
    - c. Click Save.
  8. Select the default management class that clients use, which is indicated in the Default column. Click Save. The retention settings in the default management class are applied when client operations do not specify a management class. A management class can be specified when a client operation is run. A management class can also be specified in a client option file that is on the client system, or in a client option set that is defined on the server.
  9. Activate the policy set by clicking Activate.
  10. Assign client nodes to the new policy domain by either updating existing client nodes or registering new nodes.
    - o To add new clients to the policy domain, click +Client.
    - o To move an existing client to the policy domain, select the client, click Details, and then click the Properties tab. Select the new policy domain and click Save.
- Data retention for the client that you assign to the policy domain is now controlled by that policy. For example, if you implemented the example in step 6, inactive backup versions for the clients are retained for 30 days by default.
- Requirement: If a client is running when you assign it to a new domain, you must stop and restart the client for the change to take effect.

#### Related tasks:

Controlling client operations through client option sets

---

## Creating a policy domain

You might want to create a new policy domain for each type of client that is protected by the server. You might also want to divide responsibilities for clients among several administrators by giving them authority for specific policy domains.

## About this task

---

Creating a new policy domain can be useful in the following circumstances:

- Applications, systems, or virtual machines require different data-retention settings. You can create a policy domain for each type of client, with a default policy that is appropriate for that type.
- Administrators are responsible for different groups of clients. For each administrator, you can create a policy domain to which you assign the clients to be managed by that administrator.

## Procedure

---

The following steps summarize how to create a policy domain.

1. On the Overview page of the Operations Center, hover over the settings icon  and click Command Builder.
2. Define a policy domain by using the DEFINE DOMAIN command.
3. Define a policy set for the domain by using the DEFINE POLICYSET command.
4. On the Overview page of the Operations Center, click the Services menu.
5. Select the policy domain and click Details. Click Policy Sets.
6. Click the Configure toggle so that you can update the settings.
7. Click +Management Class to add a management class. Make selections for the basic settings, and click Add.
8. Optional: Customize more settings in the new management class:
  - a. For backup services, make selections in the following columns: Backup Destination, Backups, Keep Extra Backups, Deleted Backups, and Keep Deleted Backups.
  - b. For archive services, make selections in the Archive Destination and Keep Archives columns.
  - c. Click Save.
9. Optional: Click +Management Class to add more management classes.
10. In the Default column, ensure that a default management class is selected.
11. Activate the policy set by clicking Activate.
12. Assign clients to the new policy domain. From the Operations Center menu bar, click Clients.
  - o To add new clients to the policy domain, click +Client.
  - o To move an existing client to the policy domain, select the client, click Details, and then click the Properties tab. Select the new policy domain and click Save.

### Related reference:

DEFINE DOMAIN (Define a new policy domain)

DEFINE POLICYSET (Define a policy set)

## Controlling client operations through client option sets

---

You can use client option sets to centrally control the processing options that clients use for operations such as backup. Client option sets can help ensure that data is consistently protected according to your requirements. A client option set can override options in a local client options file, and can add options that might not be in a local client options file.

## About this task

---

By creating and assigning client option sets, you reduce the need to update local client option files and reduce work for you or your users.

For example, you can define a client option set to specify an include-exclude list that determines what is backed up, what is excluded from backup, and what management classes are used to manage data retention. Other client options that might be useful to centrally control in a client option set are the compression and deduplication options.

You can create client option sets for clients that have similar requirements, such as clients on the same operating system, clients that use the same software, or clients that one department uses. For example, you might create client option sets for Windows workstations, or for the payroll department. After you create the client option set, you assign the client option set to all clients of the same type.

Not all client options can be specified in a client option set on the server. To learn about the client options that you can centrally control in a client option set, see Client options that can be set by the server.

## Procedure

---

1. Define a client option set by using the DEFINE CLOPTSET command. For example, to define a client option set named PAYROLLBACKUP, issue the following command:

```
define cloptset payrollbackup description='Backup options for the payroll department'
```

2. Add client options to the client option set by using the DEFINE CLIENTOPT command. For example, you want to add include and exclude options to the client option set named PAYROLLBACKUP to accomplish the following goals:
  - o Exclude temporary Internet directory files from backup operations
  - o Include for backup all files in the C:\Data directory and its subdirectories, and assign the files to the PAYCLASS management class for data retention

Issue the following commands:

```
define clientopt payrollbackup inclexcl "exclude.dir '*:\...\Temporary Internet Files'"  
define clientopt payrollbackup inclexcl "include C:\Data\...\* payclass"
```

3. To assign a client option set to a client, complete the following steps:
  - a. On the Overview page of the Operations Center, click Clients.
  - b. Select a client and click Details.
  - c. Click Properties.
  - d. In the General area, select an option set and click Save.

### Related reference:

DEFINE CLOPTSET (Define a client option set name)

DEFINE CLIENTOPT (Define an option to an option set)

[Compression client option](#)

[Deduplication client option](#)

## Configuring storage

---

Depending on the storage functionality that you require, choose the correct type of storage media. Optimize and control your storage pools for different types of data.

- Storage pool types  
To help you determine which storage pool type best meets your storage requirements, you should evaluate the characteristics of each storage pool type.
- Data deduplication options  
Use inline data deduplication to deduplicate data and write the data to a container storage pool at the same time. Use postprocess data deduplication to eliminate duplicate data from sequential access (FILE) storage pools.
- Configuring storage devices  
Configure storage devices by attaching devices, configuring device drivers, and creating the objects that represent the devices to the server.
- Configuring a directory-container storage pool for data storage  
You can configure directory-container storage pools to use inline data deduplication to store deduplicated data.
- Configuring a cloud-container storage pool for data storage  
You can store deduplicated data and non-deduplicated data in a cloud-container storage pool and restore the data as required. You can configure cloud-container storage pools to use one of the following service providers and protocols: Amazon Web Services (AWS) with Simple Storage Service (S3), IBM® Cloud Object Storage with Swift or S3 (and IBM SoftLayer), Microsoft Azure, and OpenStack with Swift using Keystone Version 1 or Version 2. Cloud-container storage pools are not supported on Linux on System z®.
- Optimizing performance for cloud object storage  
You can configure IBM Spectrum Protect™ to temporarily store data in one or more local storage pool directories during data ingestion. The data is then moved from local storage to the cloud. In this way, you can improve data backup and archive performance.
- Managing space in container storage pools  
After you configure IBM Spectrum Protect and add storage, manage your data and storage pool space effectively to ensure that it operates correctly. Use container storage pools to maximize your storage space and server performance.
- Auditing a storage pool container  
Audit a storage pool container to check for inconsistencies between database information and a container in a storage pool.
- Storage system requirements and reducing the risk of data corruption  
You can use many types of storage for the IBM Spectrum Protect server. If you use block disk storage, solid-state drives (SSD), or network-attached file systems for server storage, ensure that the storage meets requirements.

## Storage pool types

To help you determine which storage pool type best meets your storage requirements, you should evaluate the characteristics of each storage pool type.

Use the following table to evaluate each type of storage pool.

Storage pool type	Description	Uses
Directory-container storage pool	A primary storage pool that a server uses to store data. Data that is stored in directory-container storage pools uses both inline data deduplication and client-side data deduplication.	Use when you want to deduplicate data inline. By using directory-container storage pools, you remove the need for volume reclamation, which improves server performance and reduces the cost of storage hardware.  You cannot use this type of storage pool for storage pool backup, migration, reclamation, import or export operations.
Cloud-container storage pool	A primary storage pool that a server uses to store data. Use cloud-container storage pools to store data to an object-store based cloud storage provider. Data that is stored in cloud-container storage pools uses both inline data deduplication and client-side data deduplication.	By storing data in cloud-container storage pools, you can exploit the cost per unit advantages that clouds offer along with the scaling capabilities that cloud storage provides.  You cannot use this type of storage pool for storage pool backup, migration, reclamation, encryption, import or export operations.
Random-access storage pool	A set of volumes that the server uses to store backup versions of files, files that are archive copies, and files that are migrated from client nodes. Files are stored on DISK devices.	Use this type of storage pool to keep a copy of your data on DISK devices. You can migrate data in or out of this storage pools.
Sequential-access storage pool	A set of volumes that the server uses to store backup versions of files, files that are archive copies, and files that are migrated from client nodes. Files are stored on tape or FILE devices. Data that is stored in sequential-access storage pools uses both postprocess and client-side data deduplication.	Use this type of storage pool to keep a copy of your data on TAPE devices. You can migrate data into this type of storage pool.
Copy storage pool	A named set of volumes that contain copies of files that reside in primary storage pools. Copy storage pools are used only to back up the data that is stored in primary storage pools. A copy storage pool cannot be a destination for a backup copy group, an archive copy group, or a management class (for space-managed files).	Use copy storage pools to have a copy of active and inactive data that you can restore to a primary storage pool after a disaster or outage.  You cannot use inline data deduplication, compression, replication, or data deduplication with this type of storage pool.

Storage pool type	Description	Uses
Container-copy storage pool	A set of tape volumes that contain a copy of deduplicated extents that reside in a directory-container storage pool. Container-copy storage pools are used only to protect the data that is stored in directory-container storage pools. Container-copy storage pools are used to repair damage in a directory-container storage pool or to restore a directory-container storage pool if a disaster occurs. Container-copy storage pools are stored on sequential media.	Use container-copy storage pools to store copies of directory-container storage pools onsite or offsite. Damaged data in directory-container storage pools can be repaired by using the deduplicated extents in a container-copy storage pool.
Active-data storage pool	A named set of storage pool volumes that contain only active versions of client backup data.	Use active-data storage pools to restore active only data to primary storage pools after a disaster or outage. By restoring active only data you can restore client data quicker and you use less bandwidth.  You cannot use inline data deduplication, compression, replication, or data deduplication with this type of storage pool.

Use the following table to compare storage pool capabilities and choose the storage pool that most suits your business needs based on your storage requirements.

User goal	Directory-container storage pool	Cloud-container storage pool	Random-access storage pool	Sequential-access storage pool	Copy storage pool	Container-copy storage pool	Active-data storage pool
Protect storage pool data through node replication.	✔		✔	✔	✔		✔
Reduce storage needs by using inline compression.	✔	✔					
Reduce storage needs by using inline data deduplication.	✔	✔					
Reduce storage needs by using client-side data deduplication.	✔	✔		✔			
Reduce storage needs by using postprocess data deduplication.				✔			



User goal	Directory-container storage pool	Cloud-container storage pool	Random-access storage pool	Sequential-access storage pool	Copy storage pool	Container-copy storage pool	Active-data storage pool
Protect storage pool data through storage pool protection.	✓					✓	
Back up storage pool data by using copy storage pools on disk or tape.			✓	✓			
Store data in a cloud.		✓					

## Data deduplication options

Use inline data deduplication to deduplicate data and write the data to a container storage pool at the same time. Use postprocess data deduplication to eliminate duplicate data from sequential access (FILE) storage pools.

You must use directory-container storage pools or cloud-container storage pools for inline data deduplication. By using directory-container or cloud-container storage pools, you reduce the need for offline reorganization, which improves server performance and reduces the cost of storage hardware. You do not use device classes or volumes with these types of storage pool.

By using postprocess data deduplication, the server identifies the data first and then removes the duplicate data to the storage pool. Only one instance of the data is retained on storage media. Other instances of the same data are replaced with a pointer to the retained instance. When you remove the duplicate data, you can reclaim space in the storage pool.

For more information about postprocess data deduplication, see [Deduplicating data \(V7.1.1\)](#).

In client-side data deduplication, only compressed, deduplicated data is sent to the server. Processing is distributed between the server and the client during a backup process.

Use the following table to compare data deduplication options.

Type of data deduplication	Advantages	Disadvantages
Post-process Restriction: You can use postprocess data deduplication only with sequential access (FILE) storage pools.	<ul style="list-style-type: none"> <li>After data deduplication, you can reclaim the storage pool.</li> </ul>	<ul style="list-style-type: none"> <li>Longer processing times because the data must be identified first before the duplicate data is removed from the storage pool.</li> </ul>
Inline Restriction: You can use inline data deduplication only with directory-container and cloud-container storage pools.	<ul style="list-style-type: none"> <li>Deduplicates data as the data is written to a container storage pool.</li> <li>Reduces the need for offline reorganization which improves server performance.</li> <li>Reduced cost of storage hardware.</li> </ul>	<ul style="list-style-type: none"> <li>Higher processor usage by the server.</li> </ul>
Client-side	<ul style="list-style-type: none"> <li>Processing is distributed between the server and the client during a backup process.</li> </ul>	<ul style="list-style-type: none"> <li>Higher processor usage by the client.</li> <li>Longer elapsed time for client operations such as backup.</li> <li>Only compressed, deduplicated data is sent to the server.</li> </ul>

### Related tasks:

[Configuring data deduplication \(multisite disk solution\)](#)

## Configuring storage devices

---

Configure storage devices by attaching devices, configuring device drivers, and creating the objects that represent the devices to the server.

### About this task

---

If you are not using the single-site disk or multisite disk solution, configure and manage storage devices by following the instructions in the V7.1.1 documentation:

- **AIX** | **Linux** Configuring and managing storage devices
- **Windows** Configuring and managing storage devices

## Configuring a directory-container storage pool for data storage

---

You can configure directory-container storage pools to use inline data deduplication to store deduplicated data.

### Procedure

---

To store data in a directory-container storage pool, complete the following steps:

1. Create a directory-container storage pool by completing the following steps:
  - a. On the Operations Center menu bar, click Storage > Storage Pools.
  - b. On the Storage Pools page, click + Storage Pool.
  - c. Complete the steps in the Add Storage Pool wizard. Select Directory for the type of container-based storage.
2. After the wizard creates the storage pool, update your management classes and policy sets to use the new pool. To update a management class to use the new pool, complete the following steps:
  - a. On the Operations Center menu bar, click Services.
  - b. On the Policies page, select a policy domain and click Details.
  - c. On the Details page, click the Policy Sets tab.
  - d. Click the Configure toggle. The policy sets are editable.
  - e. Optional: To edit a policy set that is not active, click the forward and back arrows to locate the policy set.
  - f. Update one or more management classes to use the new pool by editing the Backup Destination field of the table.
  - g. Click Save.
3. Activate the changed policy set by completing the following steps:
  - a. Click Activate. Because changing the active policy set might result in data loss, a summary of the differences between the active policy set and the new policy set is displayed.
  - b. Look at the differences between corresponding management classes in the two policy sets, and consider the consequences on client files. Client files that are bound to management classes in the currently active policy set are, after activation, bound to the management classes with the same names in the new policy set.
  - c. Identify management classes in the currently active policy set that do not have counterparts in the new policy set, and consider the consequences on client files. Client files that are bound to these management classes are, after activation, managed by the default management class in the new policy set.
  - d. If the changes implemented by the policy set are acceptable, select the I understand that these updates can cause data loss check box and click Activate.
4. Click the Configure toggle. The policy sets are no longer editable.

### What to do next

---

To protect a directory-container storage pool, issue the PROTECT STGPOOL command. For instructions, see PROTECT STGPOOL (Protect data that belongs to a storage pool) and Copying directory-container storage pools to tape.

**Linux** If you are protecting a directory-container storage pool by copying the data to a remote server, and you experience network issues, see Determining whether Aspera FASP technology can optimize data transfer in your system environment.

- Copying directory-container storage pools to tape  
You can protect data in a directory-container storage pool by copying the data to container-copy storage pools, which are represented by tape volumes. The tape copy is used to repair damage to a directory-container storage pool.

- Rotating tape volumes offsite when DRM is not configured  
If your storage solution includes container-copy storage pools that are represented by tape volumes, but you did not configure the disaster recovery manager (DRM) function, you can follow a manual procedure to rotate the tape volumes offsite. By maintaining copies of data in offsite tape volumes, you can restore the data if a disaster occurs onsite.
- Changing the volume reclamation threshold for container-copy storage pools  
By default, tape volume reclamation is enabled for container-copy storage pools. To ensure that tape volumes are used efficiently, you can change the threshold for volume reclamation.
- Reclaiming tape volumes in container-copy storage pools  
You can reclaim tape volumes in container-copy storage pools without running a protection operation when you don't have time to allow both protection and reclamation operations.
- Determining whether to use container-copy storage pools for disaster protection  
Determine whether container-copy storage pools meet your requirements for disaster protection.

## Copying directory-container storage pools to tape

---

You can protect data in a directory-container storage pool by copying the data to container-copy storage pools, which are represented by tape volumes. The tape copy is used to repair damage to a directory-container storage pool.

### Before you begin

---

Define at least one tape library to the server by using the DEFINE LIBRARY command. Provision enough tape drives and scratch volumes to meet your storage requirements. For more information about managing backup media and configuring disaster recovery manager (DRM), see Disaster recovery manager (V7.1.1).

### About this task

---

To copy the data in directory-container storage pools to tape, the Operations Center creates a schedule to run the PROTECT STGPOOL command. When the protection schedule runs, one tape copy is created. At least one volume must be available when the protection schedule runs. Otherwise, the operation fails.

You can create up to two tape copies, but you must use the command-line interface to create a second container-copy storage pool. One tape copy can be taken to an offsite disaster recovery location. The other copy can be kept onsite to expedite recovery from less-critical failures.

Restrictions:

- Virtual tape libraries are not supported, regardless of which library type is defined. Only physical tape is supported.
- Container-copy storage pools can be used to repair minor to moderate storage pool damage, which includes damaged containers or directories. Container-copy storage pools can also be used for disaster protection, but you must ensure that recovery times meet your requirements. For more information, see Determining whether to use container-copy storage pools for disaster protection.
- You cannot use replication to target a container-copy storage pool.  
Tip: You can create a tape copy of the directory-container storage pool data at a disaster recovery site by using this procedure to create a container-copy storage pool on the target replication server. Then, schedule the PROTECT STGPOOL and REPLICATE NODE commands to run on the source replication server to protect your data to the target replication server.
- You cannot use the following procedure if the directory-container storage pool already has an associated container-copy storage pool. To create a second container-copy storage pool, follow the instructions in step 5.

If you created a container-copy storage pool as part of the Add Storage Pool wizard, you do not have to use this procedure. When you completed the wizard, the Operations Center configured the container-copy storage pool and a protection schedule.

### Procedure

---

To configure storage pool protection to tape for an existing directory-container storage pool, complete the following steps:

1. On the Operations Center menu bar, click Storage > Storage Pools.
2. On the Storage Pools page, select the directory-container storage pool that you want to protect to tape.
3. Click More > Add Container-Copy Pool.
4. Follow the instructions in the Add Container-Copy Pool window to schedule protection to tape.
5. After you complete the previous steps, you can add a second container-copy storage pool by using the command-line interface. Optionally, complete the following steps to add a container-copy storage pool:

- a. Create a container-copy storage pool by issuing the DEFINE STGPOOL command.
- b. Assign the container-copy storage pool to the directory-container storage pool by issuing the UPDATE STGPOOL command for the directory-container pool.

## Results

---

After you complete the configuration, data in the directory-container storage pool is copied to a container-copy storage pool based on the defined protection schedule.

## What to do next

---

1. If you created a tape copy to store offsite, enable the offsite container-copy storage pool for DRM operations by issuing the SET DRMCOPYCONTAINERSTGPOOL command. Ensure that the tape volumes are added to your offsite tape rotation schedules. If DRM is not configured, you must do so or use the alternative method to rotate tapes offsite. For instructions about the alternative method, see Rotating tape volumes offsite when DRM is not configured. To verify that offsite container-copy storage pools are enabled for DRM, use the QUERY DRMSTATUS command.

For instructions about configuring DRM, see Disaster recovery manager (V7.1.1).

2. Confirm that the reclamation threshold for your container-copy storage pool meets your requirements.

By default, tape volume reclamation is enabled for new container-copy storage pools that are created by using the Operations Center. Volume reclamation occurs when the reclamation threshold for the container-copy storage pool is less than 100%. However, tape volumes are not a candidate for reclamation until they are 75% full. Be careful when you use reclamation with container-copy storage pools that have offsite volumes. When an offsite volume becomes eligible for reclamation, in effect the server moves the extents on the volume back to the onsite location. If a disaster occurs onsite, the server can obtain extents from the offsite volume if the restored database refers to extents on the offsite volume. To prevent volumes from being rewritten immediately after all extents are deleted, use the REUSEDELAY parameter to specify a value that is greater than 0. The Operations Center sets the reclamation threshold at 60% for onsite container-copy storage pools.

For instructions about changing the reclamation threshold, see Changing the volume reclamation threshold for container-copy storage pools.

3. Protect the metadata for your container-copy storage pool.

When the protection schedule runs, data extents in the container-copy storage pools are copied to tape volumes without the associated metadata. This metadata is required to restore the tape copies. To protect the metadata, you must separately back up the server database along with its volume history, server options, and device configuration files. If you use reclamation with container-copy storage pools that have offsite tape volumes, ensure that the following requirements are met to provide disaster recovery protection:

- o Database backup operations run after storage pool protection schedules and DRM move schedules finish.
- o All database backup volumes and DRM volumes are taken offsite together.

For instructions about backing up the server database and related files, see Defining schedules for server maintenance activities.

4. Optionally, change the protection schedule for a directory-container storage pool that has one or more associated container-copy storage pools by using the UPDATE SCHEDULE command. The schedule that is created by the Operations Center is named CONTAINER\_COPY.

### Related concepts:

Data storage in container-copy storage pools

### Related tasks:

Determining whether to use container-copy storage pools for disaster protection

### Related reference:

DEFINE LIBRARY (Define a library)

PROTECT STGPOOL (Protect data that belongs to a storage pool)

UPDATE SCHEDULE (Update an administrative schedule)

QUERY DRMSTATUS (Query disaster recovery manager system parameters)

## Rotating tape volumes offsite when DRM is not configured

---

If your storage solution includes container-copy storage pools that are represented by tape volumes, but you did not configure the disaster recovery manager (DRM) function, you can follow a manual procedure to rotate the tape volumes offsite. By maintaining copies of data in offsite tape volumes, you can restore the data if a disaster occurs onsite.

## Procedure

---

1. Check out the storage volume that must be rotated offsite by using the CHECKOUT LIBVOLUME command.
2. Update the volume to indicate that it is moved offsite by using the UPDATE VOLUME command and specifying ACCESS=UNAVAILABLE. Optionally, indicate the offsite location by using the LOCATION parameter. For example, specify LOCATION=SITE1.
3. Reclaim space by taking one of the following actions:
  - o To reclaim space without protecting the storage pool, run the PROTECT STGPOOL command and specify TYPE=LOCAL and RECLAIM=ONLY.
  - o To reclaim space while protecting the storage pool, run the PROTECT STGPOOL command without specifying RECLAIM=ONLY.
4. Monitor the volume by using the QUERY VOLUME command. If the volume is shown to be unavailable and empty, return the volume onsite and check it into the library by using the CHECKIN LIBVOLUME command.
5. Update the volume by using the UPDATE VOLUME command and specifying ACCESS=READWRITE.

### Related reference:

CHECKOUT LIBVOLUME (Check a storage volume out of a library)

PROTECT STGPOOL (Protect data that belongs to a storage pool)

UPDATE VOLUME (Change a storage pool volume)

## Changing the volume reclamation threshold for container-copy storage pools

---

By default, tape volume reclamation is enabled for container-copy storage pools. To ensure that tape volumes are used efficiently, you can change the threshold for volume reclamation.

## Procedure

---

1. On the Operations Center Overview page, click Storage > Storage Pools.
2. Select the storage pool and click Details, and then Properties.
3. In the Reclamation section, set the reclamation percentage and click Save.
  - Tip: Alternatively, change the reclamation threshold by issuing the UPDATE STGPOOL command and specifying the RECLAIM parameter. For details about the RECLAIM parameter, see the commands for defining and updating container-copy storage pools.
  - Restriction: You cannot use the RECLAIM STGPOOL command to reclaim volumes in container-copy storage pools. For details about reclaiming volumes in container-copy storage pools, see the RECLAIM parameter in the PROTECT STGPOOL command.

## Reclaiming tape volumes in container-copy storage pools

---

You can reclaim tape volumes in container-copy storage pools without running a protection operation when you don't have time to allow both protection and reclamation operations.

## About this task

---

When you issue the PROTECT STGPOOL command and the target storage pool is a container-copy storage pool, both protection and reclamation operations run by default. The preferred practice is to allow both protection and reclamation operations to run. However, to save time, you can run only the storage pool protection operation or only reclamation, or you can limit the number of tape volumes that are reclaimed. Use this procedure only when you have to reclaim tape volumes quickly or when you have to reclaim a limited number of tape volumes.

## Procedure

---

To reclaim tape volumes without running a storage pool protection operation, complete the following steps:

1. Optional: To maximize the amount of space that is reclaimed, start the inventory expiration process by issuing the EXPIRE INVENTORY command.
2. Determine whether you want reclamation to run to completion or limit the number of tape volumes that are reclaimed.
3. To run reclamation to completion, issue the PROTECT STGPOOL command and specify the TYPE=LOCAL and RECLAIM=ONLY parameters. For example, to reclaim space in a local container-copy storage pool that is defined as the target protection pool for SPOOL1, issue the following command:

```
protect stgpool spool1 type=local reclaim=only
```

4. To reclaim a limited number of tape volumes, complete the following steps:
  - a. Set a reclamation limit for the container-copy storage pool by issuing the UPDATE STGPOOL command and specifying the RECLAIMLIMIT parameter. This parameter limits the number of volumes in the container-copy storage pool that are reclaimed.
  - b. Issue the PROTECT STGPOOL command and specify the TYPE=LOCAL parameter along with either the RECLAIM=YESLIMITED or RECLAIM=ONLYLIMITED parameter.

Tip: When you specify RECLAIM=YESLIMITED, both reclamation and storage pool protection operations run when the PROTECT STGPOOL command is issued. When you specify RECLAIM=ONLYLIMITED, reclamation is the only operation that runs. When you specify either of these values, reclamation runs only until it reaches the reclamation limit that is defined for the container-copy storage pool. The reclamation limit is defined with the RECLAIMLIMIT parameter on the DEFINE STGPOOL or UPDATE STGPOOL command.

For example, to reclaim a limit of five tape volumes in a container-copy storage pool that is named CCPOOL1 without running a protection operation on the source directory-container storage pool that is named SPOOL1, issue the following commands:

```
update stgpool ccpool1 reclaimlimit=5
protect stgpool spool1 type=local reclaim=onlylimited
```

For example, to protect a storage pool that is named SPOOL1 and to reclaim a maximum of 10 tape volumes in the associated container-copy storage pool, issue the following commands:

```
update stgpool spool1 reclaimlimit=10
protect stgpool spool1 type=local reclaim=yeslimited
```

## Results

---

Reclamation processing for the container-copy storage pool is completed. The storage pool protection operation did not run, so data in the directory-container storage pool that was updated since the last protection operation is not protected.

## What to do next

---

1. Protect the data in the directory-container storage pool to the container-copy storage pool by issuing the PROTECT STGPOOL command and specifying the TYPE=LOCAL parameter. The protection process runs with the default RECLAIM=YES parameter. The protection operation takes less time because reclamation already ran. For example, to protect the data in a directory-container storage pool that is named SPOOL1, issue the following command:

```
protect stgpool spool1 type=local
```

Alternatively, protect the data in a directory-container storage pool that is named SPOOL1 without running reclamation by issuing the following command:

```
protect stgpool spool1 type=local reclaim=no
```

2. Back up the server database and run scheduled maintenance operations. For instructions, see Defining schedules for server maintenance activities.

### Related reference:

PROTECT STGPOOL (Protect data that belongs to a storage pool)

DEFINE STGPOOL (Define a container-copy storage pool)

UPDATE STGPOOL (Define a container-copy storage pool)

EXPIRE INVENTORY (Manually start inventory expiration processing)

## Determining whether to use container-copy storage pools for disaster protection

---

Determine whether container-copy storage pools meet your requirements for disaster protection.

## About this task

You can create an offsite copy of your container-copy storage pool for disaster recovery protection or to satisfy regulatory and business requirements for offsite tape copies. Before you decide to use offsite tape copies for disaster protection, carefully consider whether the solution meets your recovery time objective.

Using container-copy storage pools for disaster recovery is suitable when the amount of data in your environment is equal to or less than the following values:

- 200 TB of total managed data
- 50 TB of back-end data
- 37 TB of front-end data

### Total managed data

All data that is stored in the directory-container storage pool on the server. This includes active and inactive versions of the data. The number of versions is determined by retention policies.

### Back-end data

All data that is stored in the container-copy storage pool.

### Front-end data

The current active data that is stored in the container-copy storage pool. This is the active data that is used to restore data on client nodes. In a disaster, all or part of the front-end data is required to reestablish production. Front-end data is a percentage of total managed data and is less than or equal to the total managed data, depending on the policy settings in use.

To recover from a disaster within 48 hours, the system environment at the recovery site must meet the minimum hardware requirements for the actions in the following table.

Action	Time required	Minimum requirements
Configure a new IBM Spectrum Protect™ server at a disaster recovery site. To configure the new server, you must complete the following steps: <ol style="list-style-type: none"> <li>1. Provision disks for the server.</li> <li>2. Restore the server from backup.</li> <li>3. Start the server.</li> <li>4. Update the storage and device configurations.</li> </ol>	Time to restore the server: 6 hours	Use a solid-state drive (SSD) for the server database, with the following requirements: <ul style="list-style-type: none"> <li>• A minimum of 100 MB per second average combined read/write throughput</li> <li>• A minimum of 12,862 average input/output operations per second (IOPS)</li> </ul>
Audit the directory-container storage pool and repair the data from tape. Tip: If the system meets the minimum hardware requirements, you can repair up to 50 TB of back-end data within 48 hours.	Time to audit the storage pool: 2 hours  Time to repair the storage pool by using a tape copy: 28 hours  Note: The time estimate applies if you have a maximum of 200 TB of total managed data in the storage pool.	Use Nearline SAS (NL-SAS) drives, as in a medium blueprint server configuration, with a minimum of 700 MB per second write performance to storage pool disk.  Use new generation tape technology such as LTO-7 or better, with a minimum of six drives to allow concurrent read operations from tape volumes.
Restore data on client nodes. Tip: If the system meets the minimum hardware requirements, you can restore up to 37 TB of front-end data within 48 hours.	Time for client restore operations: 12 hours	Use NL-SAS drives, as in a medium blueprint server configuration, with a minimum of 10 restore sessions achieving 3102 GB per hour.

## Procedure

1. Estimate the disaster recovery time for your environment by using the following table. Determine whether the recovery time meets your requirements.

Table 1. Recovery time estimate for differing amounts of total managed data

Recovery time objective	Total managed data (TB)	Number of hours to repair a directory-container storage pool (First Byte Restored)	Hours until client nodes are restored (Disaster Recovery complete)
Up to 1 day	25	10	12
	50	13	16
	75	17	22
Up to 2 days	100	20	26
	200	34	46
Up to 4 days	300	48	66
	400	62	86
More than 4 days	500	76	106

Notes:

- o Achievable rates are highly dependent on the workload and the configured environment.
  - o The front-end data percentage is relative to the total managed data. Increasing the amount of front-end data increases the total recovery time. Decreasing the amount of front-end data decreases the total recovery time.
2. Estimate the recovery time for your environment by using the following formulas:
- o Estimate the value **Hours until directory-container storage pool is repaired (First Byte Restored)**:

Time to Client First Byte Restore =  
6 hours + 14 hours for every 100 TB of Total Managed Data

- o Estimate the value **Hours until client nodes are restored (Disaster Recovery complete)**:

Time to Client Restore Complete =  
Time to Client First Byte Restore + ((Total Managed Data \* Front-End Data) / Restore Rate)

**Restore Rate:** The rate at which clients can restore data from the server back to their local computer or storage device.

3. Complete test procedures for disaster recovery to ensure that container-copy storage pools can be used to restore your environment in a time frame that meets your requirements.

**Related reference:**

Repairing storage pools after a disaster

## Configuring a cloud-container storage pool for data storage

You can store deduplicated data and non-deduplicated data in a cloud-container storage pool and restore the data as required. You can configure cloud-container storage pools to use one of the following service providers and protocols: Amazon Web Services (AWS) with Simple Storage Service (S3), IBM® Cloud Object Storage with Swift or S3 (and IBM SoftLayer®), Microsoft Azure, and OpenStack with Swift using Keystone Version 1 or Version 2. Cloud-container storage pools are not supported on Linux on System z®.

### Before you begin

Complete the following steps:

1. Obtain the configuration information for your cloud service provider:
  - o Amazon with S3 (off-premises)
  - o Microsoft Azure
  - o IBM Cloud Object Storage with S3 (off-premises, with IBM SoftLayer®)
  - o IBM Cloud Object Storage with Swift (off-premises, with IBM SoftLayer)
  - o IBM Cloud Object Storage with S3 (on-premises)
  - o OpenStack with Swift (on-premises or off-premises)
2. Specify a device class to use for database backup operations. When you use encryption for cloud-container storage pools, the server master encryption key is used to protect the cloud encryption key in a database backup.
  - a. On the Operations Center menu bar, select Servers.



- b. Select a server row and click Back Up.
  - c. Select a device class to use for database backup operations and click Back Up.
- Tip: Alternatively, use the SET DBRECOVERY command to specify a device class for the database backup.

## Procedure

---

To store data in a cloud-container storage pool, complete the following steps:

1. Create a cloud-container storage pool. You must provide configuration information that identifies the cloud service.
  - a. On the Operations Center menu bar, click Storage > Storage Pools.
  - b. On the Storage Pools page, click + Storage Pool.
  - c. Complete the steps in the Add Storage Pool wizard. Select On-premises cloud or Off-premises cloud for the type of container-based storage.
2. Update your management classes and policy sets to use the new storage pool. To update a management class to use the new storage pool, complete the following steps:
  - a. On the Operations Center menu bar, click Services.
  - b. On the Policies page, select a policy domain and click Details.
  - c. On the Details page, click the Policy Sets tab.
  - d. Click the Configure toggle. The policy sets are editable.
  - e. Optional: To edit a policy set that is not active, click the forward and back arrows to locate the policy set.
  - f. Update one or more management classes to use the new storage pool by editing the Backup Destination field of the table.
  - g. Click Save.
3. Activate the changed policy set by completing the following steps:
  - a. Click Activate. Because changing the active policy set might result in data loss, a summary of the differences between the active policy set and the new policy set is displayed.
  - b. Look at the differences between corresponding management classes in the two policy sets, and consider the consequences on client files. Client files that are bound to management classes in the currently active policy set are, after activation, bound to the management classes with the same names in the new policy set.
  - c. Identify management classes in the currently active policy set that do not have counterparts in the new policy set, and consider the consequences on client files. Client files that are bound to these management classes are, after activation, managed by the default management class in the new policy set.
  - d. If the changes implemented by the policy set are acceptable, select the I understand that these updates can cause data loss check box and click Activate.
4. Click the Configure toggle. The policy sets are no longer editable.
5. To take advantage of local storage, create a storage pool directory for this storage pool using the DEFINE STGPOOLDIRECTORY command. For more information, see Optimizing performance for cloud object storage.

### Related tasks:

Preparing to configure cloud-container storage pools for AWS with S3 (off premises)  
Preparing to configure cloud-container storage pools for IBM Cloud Object Storage with S3 (on premises)  
Preparing to configure cloud-container storage pools for IBM Cloud Object Storage with S3 (off premises)  
Preparing to configure cloud-container storage pools for IBM Cloud Object Storage with Swift (off premises)  
Preparing to configure cloud-container storage pools for OpenStack with Swift  
Encrypting data for cloud-container storage pools  
Optimizing performance for cloud object storage

### Related reference:

SET DBRECOVERY (Set the device class for automatic backups)

## Preparing to configure cloud-container storage pools for AWS with S3 (off premises)

---

Before you configure cloud-container storage pools to use Amazon Web Services (AWS) off premises with the Simple Storage Service (S3) protocol, you must obtain information from Amazon that is required for the configuration process.

### About this task

---

AWS account credentials are different from Amazon account credentials. Use the credentials for your AWS account when you configure storage pools in the Operations Center or with the DEFINE STGPOOL command.

AWS uses *buckets* to store data. AWS buckets are used in the same manner as containers in a cloud-container storage pool. IBM Spectrum Protect™ automatically creates a bucket in Amazon for an instance of IBM Spectrum Protect, and that bucket is shared by all pools for that instance.

Restriction: Edit an AWS bucket only with IBM Spectrum Protect, and do not change the data in the bucket or edit the configuration settings for the bucket.

## Procedure

---

1. Sign up for an AWS account by going to the Amazon S3 page and clicking Create an AWS Account.
2. Obtain your AWS credentials:
  - a. Go to the Amazon S3 page and click Sign In to the Console.
  - b. Select your name and select Security Credentials.
  - c. Go to the Access Keys section to locate the Access Key ID and the Secret Access Key fields. Record the values so that you can use them when you configure storage pools.
3. If you plan to configure storage pools by using the Add Storage Pool wizard in the Operations Center, use the following values for the parameters:
  - o Cloud type: `Amazon - S3 API`
  - o Access key ID: `access_key_id`
  - o Secret access key: `secret_access_key`
  - o Region: Select the region endpoint that best fits your location, based on the AWS Regions and Endpoints page. If you select `Other`, specify a region endpoint URL in the URL field, and include the protocol, usually `https://`. Typically, you can use the region that is closest to your physical location for the Region parameter. Because an Amazon bucket exists in only one region, you can specify only one endpoint URL for a region. If you require a GovCloud region, specify a URL from the AWS GovCloud (US) Endpoints page.

Warning: Be sure to use only the AWS endpoint URL for the Region value, such as `https://s3-us-west-1.amazonaws.com`. Do not use the static website hosting URL for this value.
  - o Bucket name: Use the default bucket name generated by the server, or specify a new bucket name.
4. To define the cloud-container storage pool, issue the DEFINE STGPOOL command with the following values:
  - o CLOUDTYPE: `S3`
  - o IDENTITY: `access_key_id`
  - o PASSWORD: `secret_access_key`
  - o CLOUDURL: Specify the region endpoint URL that best fits your location, based on the AWS Regions and Endpoints page.

Typically, you can use the region that is closest to your physical location for the CLOUDURL parameter. If you require a GovCloud region, specify a URL from the AWS GovCloud (US) Endpoints page.

Warning: Be sure to use only the AWS endpoint URL for the CLOUDURL value, such as `https://s3-us-west-1.amazonaws.com`. Do not use the static website hosting URL for this value.

## What to do next

---

Configure cloud-container storage pools for AWS by following the instructions in Configuring a cloud-container storage pool for data storage.

## Configuring an Amazon S3 compatible device as a cloud-container storage pool

---

You can configure a storage device that is compatible with the Amazon Simple Storage Service (S3) protocol so that the device can be used as an IBM Spectrum Protect™ cloud-container storage pool.

## About this task

---

Amazon S3 uses *buckets* to store data. You must create a bucket on the S3 compatible storage device for use by an IBM Spectrum Protect server. After you create the bucket, use the credentials from the account on your Amazon S3 compatible cloud object storage device when you configure storage pools with the DEFINE STGPOOL command.

Restriction: Do not change the data in the bucket or edit the configuration settings for the bucket.

## Procedure

---

1. Create a bucket on the cloud object storage device. Follow the instructions in the device documentation.
2. Create a user account on the cloud object storage device. The account is used by IBM Spectrum Protect to access the device by using the access key ID and secret access key. Ensure that the account has permissions to store data in and delete data from the bucket that you created in Step 1. Record the access key ID and the secret access key values so that you can use them when you configure storage pools.
3. Identify the URL value that will be used by IBM Spectrum Protect to access the cloud object storage device. For instructions, see the documentation for your cloud object storage device.
4. To define the cloud-container storage pool, issue the DEFINE STGPOOL command with the following values:

- o CLOUDTYPE: S3
- o IDENTITY: *access\_key\_id*
- o PASSWORD: *secret\_access\_key*
- o CLOUDURL: `http://cloud_object_storage_endpoint_IP_address` or `https://cloud_object_storage_endpoint_IP_address`. If you use more than one endpoint, list the endpoint IP addresses separated by a vertical bar (|), with no spaces, as shown in the following example:

```
CLOUDURL=endpoint_URL1|endpoint_URL2|endpoint_URL3
```

- o BUCKETNAME: *name\_of\_bucket\_on\_device*

To optimize performance, use multiple endpoints or a load balancer.

## What to do next

---

Configure cloud-container storage pools in a similar way as you would configure a cloud-container storage pool for IBM Cloud Object Storage by following the instructions in [Configuring a cloud-container storage pool for data storage](#).

## Preparing to configure cloud-container storage pools for Microsoft Azure (off premises)

---

Before you configure cloud-container storage pools to use the Microsoft Azure cloud computing system, you must obtain information for the configuration process from Microsoft.

### About this task

---

IBM Spectrum Protect™ supports the following Azure storage tiers:

- *Hot storage tier* for data that is accessed frequently
- *Cool storage tier* for data that is accessed less frequently

You can use a cool storage tier for cost-effective, long-term storage. However, it is more costly to restore data from a cool storage tier than from a hot storage tier.

## Procedure

---

1. Sign up for a Microsoft Azure account by going to the Azure portal and creating an account.
2. Create a storage account. Typically, select the location that is nearest to your IBM Spectrum Protect server for the storage account location.
3. Obtain your Azure credentials:
  - a. Go to the Azure portal and click Storage accounts.
  - b. Open the new storage account, go to the container section of the Blob Service pane, and record the blob service endpoint value so that you can use it when you configure storage pools. The blob service endpoint looks like these examples: `https://name.blob.core.windows.net` and `http://name.blob.core.windows.net`.
  - c. Create a shared access signature (SAS) token by opening the Shared access signature tab and completing the fields. Ensure that the Allowed services section includes Blob and that the Allowed resource types section includes Container and Object. Ensure that the SAS token has read, write, delete, list, add, and create permissions. Click Generate SAS.
  - d. Record the SAS token value so that you can use it when you configure storage pools. IBM Spectrum Protect does not monitor the SAS token expiration date, so ensure that you select a date that best suits your needs. If the token expires, the IBM Spectrum Protect server loses access to the storage account until you provide a new SAS token. Tip: If you would like to less frequently update the SAS token, set an expiration date that is several years away. Also, ensure that you verify the start date and time fields.

4. If you plan to configure storage pools by using the Add Storage Pool wizard in the Operations Center, use the following values for the parameters:
  - o Cloud type: *Azure*
  - o SAS token: *SAS\_token\_value*. Look for a string that is similar to this example:
 

```
?sv=2016-05-31&ss=b&srt=sco&sp=rwdlac&se=2017-04-05T18:26:12Z&st=2017-04-05T10:26:12Z&spr=https&sig=XUangS%2FcXXXXXXXXXXXXXXXXXXXXXXXXXXXXXXXXXELsuWp106Cmq7o%3D
```
  - o Blob service endpoint: Specify the blob service endpoint from your Azure storage account, for example, `https://name.blob.core.windows.net` or `http://name.blob.core.windows.net`.
5. If you plan to configure storage pools by using the DEFINE STGPOOL command, use the following values for the command parameters:
  - o CLOUDTYPE: *Azure*
  - o PASSWORD: *SAS\_token\_value*. Look for a string that is similar to this example:
 

```
?sv=2016-05-31&ss=b&srt=sco&sp=rwdlac&se=2017-04-05T18:26:12Z&st=2017-04-05T10:26:12Z&spr=https&sig=XUangS%2FcXXXXXXXXXXXXXXXXXXXXXXXXXXXXXXXXXELsuWp106Cmq7o%3D
```
  - o CLOUDURL: Specify the blob service endpoint from your Azure storage account, for example, `https://name.blob.core.windows.net` or `http://name.blob.core.windows.net`.

## What to do next

---

Configure cloud-container storage pools for Azure by following the instructions in [Configuring a cloud-container storage pool for data storage](#).

## Preparing to configure cloud-container storage pools for IBM Cloud Object Storage with Swift (off premises)

---

Before you configure cloud-container storage pools to use IBM® Cloud Object Storage and IBM SoftLayer® off premises using Swift, you must obtain configuration information from the [SoftLayer Object Storage page](#).

### About this task

---

Use the credentials from your IBM SoftLayer account when you configure the storage pools in the Operations Center or with the DEFINE STGPOOL command.

### Procedure

---

1. Create a SoftLayer account by following the instructions in the [SoftLayer documentation](#).
2. Obtain your SoftLayer credentials:
  - a. Go to the [SoftLayer Object Storage page](#) and log in with your account credentials.
  - b. Select the account and cluster that you want to configure.
  - c. In the Account section, click [View Credentials](#)
  - d. In the Account Credentials section, locate the Public Authentication Endpoint, Username, and API Key fields. Record the values in those fields so that you can use them when you configure storage pools.
3. If you plan to configure storage pools by using the Add Storage Pool wizard in the Operations Center, use the following values for the parameters:
  - o Cloud type: *IBM Cloud Object Storage - Swift API (SoftLayer)*
  - o User name: *username*
  - o Password: *API\_key*
  - o URL: *public\_authentication\_endpoint*
4. If you plan to configure storage pools by using the DEFINE STGPOOL command, use the following values for the command parameters:
  - o CLOUDTYPE: *SOFTLAYER*
  - o IDENTITY: *username*
  - o PASSWORD: *API\_key*
  - o CLOUDURL: *public\_authentication\_endpoint*

## What to do next

---

Configure cloud-container storage pools for IBM SoftLayer by following the instructions in [Configuring a cloud-container storage pool for data storage](#).

## Preparing to configure cloud-container storage pools for IBM Cloud Object Storage with S3 (off premises)

---

You can set up cloud storage pools to use IBM® Cloud Object Storage off premises with the Simple Storage Service (S3) protocol.

### About this task

---

The off premises implementation of IBM Cloud Object Storage is managed through SoftLayer® or IBM Bluemix. In this setup, only the owner of the SoftLayer or Bluemix account can create buckets and administrators.

Use the credentials from your IBM SoftLayer or IBM Bluemix account when you configure the storage pools in the Operations Center or with the DEFINE STGPOOL command. For more information, see the [SoftLayer Object Storage page](#). To use this configuration, select Cloud Object Storage - S3 API from the [SoftLayer Order Object Storage page](#).

### Procedure

---

1. Log into the SoftLayer Customer Portal.
2. Click the Storage menu and select Object Storage.
3. From the Object Storage page, select an S3 account.
4. From the Cloud Object Storage page, click Manage Buckets and then click the + symbol to create the bucket you want to use with the new cloud-container storage pool.
5. Click Show Credentials to create administrator credentials for your new bucket.
6. Click Add Credential.
7. Locate the Access Key ID, the Secret Access Key, and the Public Authentication Endpoint. Record the values in those fields so that you can use them when you configure storage pools. If you are inside the SoftLayer network, you can use a private authentication endpoint.
8. To configure storage pools by using the Add Storage Pool wizard in the Operations Center, select Off-premises cloud. Use the following values for the parameters:
  - o Cloud type: IBM Cloud Object Storage - S3 API (SoftLayer)
  - o Access key ID: *access\_key\_ID*
  - o Secret access key: *secret\_access\_key*
  - o Bucket name: *bucket\_name* (from step 4)
  - o URL: *us-geo\_authentication\_endpoint*  
Note: Only one cloud provider endpoint is needed with this configuration. If all of your servers are inside the SoftLayer network, you can use a private authentication endpoint.
9. If you configure storage pools by using the DEFINE STGPOOL command, use the following values for the command parameters:
  - o CLOUDTYPE: S3
  - o IDENTITY: *access\_key\_ID*
  - o BUCKETNAME: *bucket\_name* (from step 4)
  - o PASSWORD: *secret\_access\_key*
  - o CLOUDURL: *us-geo\_authentication\_endpoint*  
Note: Only one cloud provider endpoint is needed with this configuration. If all of your servers are inside the SoftLayer network, you can use a private authentication endpoint.

### What to do next

---

Configure cloud-container storage pools for IBM SoftLayer Cloud Object Storage by following the instructions in [Configuring a cloud-container storage pool for data storage](#).

## Preparing to configure cloud-container storage pools for IBM Cloud Object Storage with S3 (on premises)

---

Before you configure cloud-container storage pools to use IBM® Cloud Object Storage on premises with S3, you must set up an IBM Cloud Object Storage vault template and an IBM Cloud Object Storage user account, and then obtain configuration information.

## About this task

---

IBM Cloud Object Storage vaults are used in the same manner as containers in a cloud-container storage pool. Set up a vault template to quickly create vaults with your preferred settings.

After you create a vault template, use the credentials from your IBM Cloud Object Storage user account to configure the storage pools in the Operations Center or with the DEFINE STGPOOL command. IBM Spectrum Protect™ uses the Simple Storage Service (S3) protocol to communicate with IBM Cloud Object Storage.

Tip: You can skip the first four steps in the procedure if you want to configure a vault that already exists by using the BUCKETNAME parameter in the DEFINE STGPOOL or UPDATE STGPOOL commands.

## Procedure

---

1. Create a vault template:
  - a. Log in to IBM Cloud Object Storage and click the Configure tab.
  - b. In the dsNet navigation pane, expand Storage Pools.
  - c. Select the IBM Cloud Object Storage storage pool where you want to create the vault template, and click the Storage Pool link in the General section.
  - d. In the Vault Templates section, click Create Vault Template.
  - e. Select the settings for the default vault template. You might be able to optimize performance by not selecting the Enable SecureSlice Technology or the Name Index Enabled options, and selecting the Recovery Listing Enabled option.
  - f. In the Deployment section, select the access pool or pools that you want to use for the template and click Save.
2. Set the vault template as the default for your IBM Cloud Object Storage dsNet:
  - a. Click the Configure tab.
  - b. In the Default Vault Template Configuration section, click Configure.
  - c. Select a vault template to use as the default, and click Update to set that template as the default.
3. If this is your first time configuring a vault template, enable the vault provisioning role so you can create new vaults:
  - a. Click the Administration tab.
  - b. In the Provisioning API Configuration section, click Configure.
  - c. Select Create Only or Create and Delete to let users create new vaults using the Provisioning API.
  - d. Click Update to save the settings.
4. Use an IBM Cloud Object Storage account with administration authority to create a user account on the IBM Cloud Object Storage instance in your environment. Ensure that the new user account has the Vault Provisioner role.
5. Click the Security tab and select the new user account.
6. Generate an access key for the new user:
  - a. In the Access Key Authentication section, click Change Keys.
  - b. On the Edit Access Keys page, click Generate New Access Key.
  - c. Click Back.
7. In the Access Key Authentication section, locate the Access Key ID and Secret Access Key values. Record the values so that you can use them when you configure storage pools.
8. Locate the URL value:
  - a. Click the Configure tab.
  - b. In the dsNet navigation pane, expand the Devices and Accesser sections.
  - c. Select the IBM Cloud Object Storage accesser. Verify that the accesser belongs to an access pool to which the default vault template is deployed.
  - d. In the Device Configuration section for the accesser, record the IP Address value so that you can use it when you configure storage pools. Use `http://` before the IP address value to prevent certificate security errors.
9. If you configure storage pools by using the Add Storage Pool wizard in the Operations Center, use the following values for the parameters:
  - o Cloud type: IBM Cloud Object Storage - S3 API
  - o Access key ID: `access_key_ID`
  - o Secret access key: `secret_access_key`
  - o Bucket name: Use the default bucket name generated by the server, or specify a new bucket name.
  - o URL: `http://Cloud_Object_Store_accesser_IP_address`  
Important: If you use more than one accesser, type an accesser IP address and then press Enter to add additional IP addresses. Use multiple accessers or a load balancer for optimal performance.
10. If you configure storage pools by using the DEFINE STGPOOL command, use the following values for the command parameters:
  - o CLOUDTYPE: S3
  - o IDENTITY: `access_key_ID`

- o PASSWORD: *secret\_access\_key*
- o CLOUDURL: `http://Cloud_Object_Store_accesser_IP_address`  
Important: If you use more than one accesser, list the accesser IP addresses separated by a vertical bar (|), with no spaces, such as `CLOUDURL=<accesser_URL1>|<accesser_URL2>|<accesser_URL3>`. Use multiple accessers or a load balancer for optimal performance.

---

## What to do next

Configure cloud-container storage pools for IBM Cloud Object Storage by following the instructions in [Configuring a cloud-container storage pool for data storage](#).

---

## Preparing to configure cloud-container storage pools for OpenStack with Swift

Before you configure cloud-container storage pools to use OpenStack on premises or off premises with Swift, you must obtain configuration information from the OpenStack Swift computer.

---

### About this task

Use the credentials from your OpenStack Swift account when you configure the storage pools by using the Operations Center or the DEFINE STGPOOL command.

---

### Procedure

1. Create an OpenStack Swift account by following the instructions in the OpenStack Swift documentation.
2. Obtain your OpenStack Swift credentials:
  - a. On the OpenStack Swift computer, type the following command:

```
swift auth -v
```
  - b. In the output, locate the `OS_AUTH_URL`, the `OS_TENANT_NAME`, the `OS_USERNAME`, and the `OS_PASSWORD` values. Record the values so that you can use them when you configure storage pools.
3. If you plan to configure storage pools by using the Add Storage Pool wizard in the Operations Center, use the following values for the parameters:
  - o Cloud type: `OpenStack Swift`
  - o User name: `OS_TENANT_NAME:OS_USERNAME`
  - o Password: `OS_PASSWORD`
  - o URL: `OS_AUTH_URL`
4. If you plan to configure storage pools by using the DEFINE STGPOOL command, use the following values for the command parameters:
  - o CLOUDTYPE: `SWIFT` or `V1SWIFT`
  - o IDENTITY: `OS_TENANT_NAME:OS_USERNAME`
  - o PASSWORD: `OS_PASSWORD`
  - o CLOUDURL: `OS_AUTH_URL`
5. If you plan to use a specific tenant or user name, record the values in the following format: `TENANT_NAME:USERNAME`.
6. To prevent data loss, configure OpenStack Swift to create replicas of the data that is written to its object storage. For more information, see the OpenStack Swift documentation.

---

## What to do next

Configure cloud-container storage pools for OpenStack Swift by following the instructions in [Configuring a cloud-container storage pool for data storage](#).

---

## Encrypting data for cloud-container storage pools

Data that is stored in off-premises cloud-container pools is encrypted by default. You can optionally encrypt data in on-premises cloud-container storage pools.

---

### About this task



For information about encrypting cloud-container storage pool data and for performance considerations related to the encryption of data, see technote 1963635.

## Optimizing performance for cloud object storage

---

You can configure IBM Spectrum Protect™ to temporarily store data in one or more local storage pool directories during data ingestion. The data is then moved from local storage to the cloud. In this way, you can improve data backup and archive performance.

### Before you begin

---

To optimize backup and archive performance, ensure that IBM Spectrum Protect Version 8.1 is installed.

### About this task

---

After you define a storage pool directory, the IBM Spectrum Protect server uses that directory as a temporary landing spot for the data that you are transferring to cloud object storage. The server uses an automated background process to transfer data from local storage in the directory to cloud object storage. You do not need to take any additional steps to start or manage this transfer process. After the server successfully moves the data from local storage to cloud object storage, the server deletes the data from the directory and releases space for more incoming data.

If storage pool directories contain no more free space, backup operations stop prematurely. To avoid this situation, you can allocate more storage pool directories. You can also wait for the data to be automatically removed from the local directories after the data moves to the cloud. The required number of storage pool directories you need to define depends on your disk configuration on the server. When the initial backups occur, the server spreads the data across all the directories you defined.

The amount of space you need for local storage is based on the amount of data you expect to back up each day after data deduplication and compression. If you have a stable network connection to the cloud object storage, the required amount of space is similar to the amount that is required for a daily backup.

For additional planning information, see the topic for your operating system:

- AIX®: Planning for directory-container and cloud-container storage pools
- Linux: Planning for directory-container and cloud-container storage pools
- Windows: Planning for directory-container and cloud-container storage pools

### Procedure

---

1. Create a cloud-container storage pool by using the Add Storage Pool wizard in the Operations Center. Alternatively, create the pool by using the DEFINE STGPOOL command.
2. Define one or more storage pool directories by using the DEFINE STGPOOLDIRECTORY command. Ensure that each storage pool directory has its own file system. On Linux systems, use xfs or ext4 as the file system instead of ext3 because deleting large files takes more time with ext3. Ensure that the new storage pool directories do not share the root file system, nor should they share the same file systems that are used by other IBM Spectrum Protect resources, such as the database or the logs.

#### Related reference:

DEFINE STGPOOLDIRECTORY (Define a storage pool directory)

AIX

Linux

Windows

## Managing space in container storage pools

---

After you configure IBM Spectrum Protect™ and add storage, manage your data and storage pool space effectively to ensure that it operates correctly. Use container storage pools to maximize your storage space and server performance.

### About this task

---

Container storage pools are primary storage pools that you use for inline data deduplication, inline compression, and cloud storage.

Restriction: You cannot use any of the following functions with container storage pools:

- Migration



- Reclamation
- Aggregation
- Collocation
- Export
- Import
- Simultaneous-write
- Storage pool backup
- Virtual volumes

## Procedure

1. Create a directory-container storage pool by completing the following steps:
  - a. Open the Operations Center.
  - b. On the Operations Center menu bar, click Storage > Storage Pools.
  - c. Click +Storage Pool.
  - d. Complete the steps in the Add Storage Pool wizard:
    - To use inline data deduplication, select a Directory storage pool under Container-based storage.
    - When you configure directories for the directory-container storage pool, specify the directory paths that you created for storage during system setup.
  - e. After you configure the new directory-container storage pool, click Close & View Policies to update a management class and start using the storage pool.
2. For optimal performance of container storage pools, complete the following tasks:

Task	Procedure	More information
Protect the storage pool	<p>When you create a directory-container storage pool in the Operations Center, you can configure storage pool protection in the schedule that you assign to the storage pool.</p> <p>Alternatively, use the PROTECT STGPOOL command from the source server to back up data extents in a directory-container storage pool.</p> <p>By protecting a storage pool, you do not use resources that replicate existing data and metadata, which improves server performance.</p>	<ul style="list-style-type: none"> <li>○ Protecting data in directory-container storage pools</li> <li>○ PROTECT STGPOOL (Protect data that belongs to a storage pool)</li> </ul>
Repair a storage pool	<p>When a storage pool is protected, you can use the REPAIR STGPOOL command to repair damaged data extents. Use the REPAIR STGPOOL command to repair a directory-container storage pool.</p> <p>Restriction: If you replicate client nodes but do not protect the directory-container storage pool, you cannot repair the storage pool.</p>	<ul style="list-style-type: none"> <li>○ Repairing storage pools</li> <li>○ REPAIR STGPOOL (Repair a directory-container storage pool)</li> </ul>
Delete containers	<p>Containers are deleted in the inventory as file data is removed or expired.</p> <p>Use the DEFINE STGPOOL command and specify the REUSEDDELAY parameter to control the duration that deduplicated extents are associated with a directory-container storage pool after they are no longer referenced.</p> <p>If a container is damaged, use the AUDIT CONTAINER command to recover or remove data.</p>	<ul style="list-style-type: none"> <li>○ DEFINE STGPOOL (Define a directory-container storage pool)</li> <li>○ AUDIT CONTAINER (Verify the consistency of database information for a directory-container)</li> </ul>

Convert a primary storage pool that uses a FILE device class, a tape device class, or a virtual tape library (VTL)	You can convert an existing storage pool to a directory-container storage pool by completing the steps in <a href="#">Converting a primary storage pool to a container storage pool</a> . Restriction: You cannot convert the following types of storage pool: <ul style="list-style-type: none"> <li>○ Primary storage pools that use random-access device classes (DISK)</li> <li>○ Copy storage pools</li> <li>○ Active-data storage pools</li> </ul>	<ul style="list-style-type: none"> <li>○ CONVERT STGPOOL (Convert a storage pool to a container storage pool)</li> </ul>
Monitor container storage pool occupancy	Monitor the storage solution to identify existing and potential issues. For more information, see <a href="#">Monitoring storage solutions</a> .	

- **Converting a primary storage pool to a container storage pool**  
Convert a primary storage pool that uses a FILE device class, a tape device class, or a virtual tape library (VTL) to a container storage pool. Data that is stored in a container storage pool can use both inline data deduplication and inline compression.
- **Cleaning up data in a source storage pool**  
To convert a storage pool to a directory-container storage pool, you might have to clean up damaged data or files that are in the source storage pool.

AIX | Linux | Windows

## Converting a primary storage pool to a container storage pool

Convert a primary storage pool that uses a FILE device class, a tape device class, or a virtual tape library (VTL) to a container storage pool. Data that is stored in a container storage pool can use both inline data deduplication and inline compression.

### Before you begin

To ensure that volumes in a source storage pool and associated copy storage pools are not reused during a conversion process, specify a value for the REUSEDELAY parameter on the UPDATE STGPOOL command. Specify a value for the REUSEDELAY parameter that is greater than the conversion duration. You might have to delay reuse of volumes for the following reasons:

- You inadvertently delete the data during storage pool conversion.
- You need source storage pool functionality that is not available in container storage pools.

**Tip:** When you specify the REUSEDELAY parameter and a conversion operation is in progress, some storage space is unavailable in the source storage pool until the value of the parameter expires.

Create a container storage pool where data will be moved by completing the following steps:

1. On the Storage Pools page of the Operations Center, click + Storage Pool.
2. Complete the steps in the Add Storage Pool wizard. Select the type of container-based storage that you require.

### About this task

By converting a storage pool to a container storage pool, you remove the need for volume reclamation. The omission of volume reclamation operations can help to improve server performance and reduce the amount of required storage hardware.

As files are converted, any copies that are stored in copy pools or active-data pools are deleted.

Restrictions:

- If the source pool is specified as a backup, archive, or migration destination in an active policy set that has pending changes, you must activate those changes before you can convert the pool.
- To ensure that the destination specifies a storage pool that is not converted or undergoing conversion, you must update all policies that reference the source storage pool.
- If the source storage pool is specified as a next storage pool, you must update the NEXTSTGPOOL parameter on the UPDATE STGPOOL command to specify a random-access or sequential-access storage pool that is not being converted.

- The following data types are not eligible for conversion: table of contents (TOC) backups, virtual volumes, and Network Data Management Protocol (NDMP) data. Before you start the conversion process, manually delete these data types from the storage pool, move the data types to a different primary storage pool, or allow the data types to expire based on policy settings.
- When you convert a storage pool with a FILE device class to a directory-container pool, the target storage pool should be approximately 30% larger than the source storage pool. Additional space is not typically required when you convert other storage pool types.

For more information about best practices for storage pool conversion, see [Best practices for IBM Spectrum Protect storage pool conversion](#).

- If the source storage pool is used to store TOC backups, ensure that another primary storage pool is available to store new TOC backups. Existing TOC backups are not moved during conversion.

The TOC pool must use a NATIVE or NONBLOCK data format and a device class other than Centera. To avoid mount delays, use a DISK or FILE device class.

## Procedure

---

1. On the Storage Pools page of the Operations Center, select a storage pool that uses a FILE device class, a tape device class, or VTL.
2. Click More > Convert and complete the steps in the Convert Storage Pool wizard.  
Tip: Schedule conversion for at least 2 hours for a storage pool that uses a FILE device class and at least 4 hours for VTL.

## What to do next

---

When the conversion process is complete, the source storage pool might contain damaged data or data that is incompatible with container storage pools. Clean up the source storage pool by completing the steps in [Cleaning up objects after storage pool conversion](#).

### Related tasks:

Restoring the database

AIX

Linux

Windows

## Cleaning up data in a source storage pool

---

To convert a storage pool to a directory-container storage pool, you might have to clean up damaged data or files that are in the source storage pool.

## Procedure

---

Use the following options to recover or repair damaged data:

- Recover an undamaged version of the data from a copy or active-data storage pool by issuing the RESTORE STGPOOL command.
- Recover an undamaged version of the data from a target replication server by issuing the REPLICATE NODE command and specifying the RECOVERDAMAGED=YES parameter.
- Remove data that cannot be repaired after storage pool conversion by issuing the REMOVE DAMAGED command. The REMOVE DAMAGED command might not remove volumes that are marked as destroyed on the source storage pool. To remove these volumes, complete the following steps:
  - a. Issue the DELETE VOLUME command and specify the DISCARDDATA=YES parameter.
  - b. Issue the CONVERT STGPOOL command to convert the storage pool again.
  - c. If damaged data is identified during storage pool conversion, reissue the REMOVE DAMAGED command.
- Complete the analysis tasks that are described in [technote 1666371](#).

## What to do next

---

After you have recovered or repaired the damaged data, retry conversion by issuing the CONVERT STGPOOL command.

To view information about damaged files that remain in the source storage pool, issue the QUERY CLEANUP command.

Tip: If a Cleanup status is shown for a storage pool that contains no data, you can delete the storage pool by using the DELETE STGPOOL command.

**Related reference:**

DELETE VOLUME (Delete a storage pool volume)  
QUERY CLEANUP (Query the cleanup that is required in a source storage pool)  
REMOVE DAMAGED (Remove damaged data from a source storage pool)  
REPLICATE NODE (Replicate data in file spaces that belong to a client node)  
RESTORE STGPOOL (Restore storage pool data from a copy pool or an active-data pool)

## Auditing a storage pool container

---

Audit a storage pool container to check for inconsistencies between database information and a container in a storage pool.

### About this task

---

You audit a storage pool container in the following situations:

- When you issue the QUERY DAMAGED command and a problem is detected
- When the server displays messages about damaged data extents
- Your hardware reports an issue and error messages that are associated with the storage pool container are displayed

### Procedure

---

1. To audit a storage pool container, issue the AUDIT CONTAINER command. For example, issue the following command to audit a container, 000000000000076c.dcf:

```
audit container c:\tsm-storage\07\000000000000076c.dcf
```

2. Review the output from the ANR4891I message for information about any damaged data extents.

### What to do next

---

If you detect problems with the storage pool container, you can restore data based on your configuration. You can repair the contents in the storage pool by using the REPAIR STGPOOL command.

Restriction: You can repair the contents of the storage pool only if you protected the storage pool by using the PROTECT STGPOOL command.

**Related reference:**

- [AUDIT CONTAINER](#) (Verify the consistency of database information for a directory-container storage pool)
- [QUERY DAMAGED](#) (Query damaged data in a directory-container or cloud-container storage pool)

## Storage system requirements and reducing the risk of data corruption

---

You can use many types of storage for the IBM Spectrum Protect™ server. If you use block disk storage, solid-state drives (SSD), or network-attached file systems for server storage, ensure that the storage meets requirements.

The following requirements apply to storage for the server database, active log, and archive log; for storage pools that use DISK or FILE device classes; and for directory-container storage pools.

Storage can be connected to the server system by any method that is valid for the operating system. For example, the storage can be attached directly, or by using Fibre Channel or iSCSI technology.

Because of the many storage systems that can meet the requirements for server storage, a list of such devices is not available. Contact the vendor if you have questions about whether a system meets IBM Spectrum Protect requirements.

For details about file system requirements, see technote 1902417. For details about network file system (NFS) requirements, see technote 1470193.

Storage and file systems must report write and commit results synchronously and accurately to the IBM Spectrum Protect server. Unreported or asynchronously reported write errors that result in data not being permanently committed to the storage system can cause data corruption. Data corruption can cause operational failures, including failure to start the server, and data recovery is typically required.

You can reduce the risk of data corruption with the following tips:

Write cache

Disk systems use write cache to improve system performance. To reduce the risk of data corruption, the storage system must reliably commit the data in the write cache to permanent storage.

The write cache typically has a battery to prevent loss of data from the cache during short power outages. For critical systems, consider backup power sources to protect the cache from extended power outages.

#### Direct I/O

Direct I/O meets the server's need for synchronous and accurate reporting on data write and commit operations.

Attention: Do not disable direct I/O in situations where the method of write caching has a potential to cause data loss.

Disabling direct I/O can greatly increase the potential for data loss because more data is cached by the file system, in addition to the disk system.

#### Storage replication

Environments that replicate IBM Spectrum Protect storage must use features such as maintenance of write order between the source (local server) and the target (remote server). The database, active log, archive logs, and storage pools must be part of a consistency group. A consistency group maintains relationships among volumes to preserve write order so that they can be recovered. Any I/O to the members of the target consistency group must be written in the same order as the source and maintain the same volatility characteristics.

To maintain synchronization between IBM Spectrum Protect servers at local and remote sites, do not start a server at the remote site except in a failover situation. Monitor for synchronization of data at the local and remote locations. If synchronization is lost, you must restore the server at the remote location by using IBM Spectrum Protect restore commands for the database and storage pools.

## Tips on storage configuration

---

For tips on storage configuration to optimize system performance, see the following topics from the V7.1.1 product documentation. The information in the checklists can be applied to later releases.

- Checklist for server database disks
- Checklist for server recovery log disks
- Checklist for storage pools that use DISK or FILE device classes

## Monitoring storage solutions

---

After you implement an IBM Spectrum Protect™ solution, monitor the solution to ensure that it operates correctly. By monitoring the solution on a daily and periodic basis, you can identify existing and potential issues. The information that you gather can be used to troubleshoot problems and optimize system performance.

### About this task

---

The preferred way to monitor a solution is by using the Operations Center, which provides overall and detailed system status in a graphical user interface. In addition, you can configure the Operations Center to generate email reports that summarize system status.

### Procedure

---

1. Complete daily monitoring tasks. For instructions, see Daily monitoring checklist.
2. Complete periodic monitoring tasks. For instructions, see Periodic monitoring checklist.
3. To verify that your system complies with licensing requirements, follow the instructions in Verifying license compliance.
4. Optional: Set up email reports of system status. For instructions, see Tracking system status by using email reports
5. Optional: In some cases, you might want to use advanced monitoring tools to complete specific monitoring or troubleshooting tasks. To select and configure advanced monitoring tools, see Selecting, configuring, and using monitoring tools.

### What to do next

---

To help you diagnose issues with backup-archive clients, install IBM Spectrum Protect client management services on backup-archive client systems that support it. When the client management service is installed on a system, in the Operations Center you can click Diagnose to get help with diagnosing issues with the backup-archive client. To install the client management service, follow the instructions in Collecting diagnostic information with IBM Spectrum Protect client management services.

#### Related concepts:

- 📄 Performance
- Related tasks:**
- 📄 Troubleshooting

## Daily monitoring checklist

Review the checklist to ensure that you complete important daily monitoring tasks.

Complete the daily monitoring tasks from the Operations Center Overview page. You can access the Overview page by opening the Operations Center and clicking Overviews.

The following figure shows the location for completing each task.









Tip: To run administrative commands for advanced monitoring tasks, use the Operations Center command builder. The command builder provides a type-ahead function to guide you as you enter commands. To open the command builder, go to the Operations Center Overview page. On the menu bar, hover over the settings icon  and click Command Builder.

The following table lists the daily monitoring tasks and provides instructions for completing each task.





Table 1. Daily monitoring tasks

Task	Basic procedures	Advanced procedures and troubleshooting information
<p><b>1</b> Determine whether clients are at risk of being unprotected due to failed or missed backup operations.</p>	<p>To verify whether clients are at risk, in the Clients area, look for an At risk notification. To view details, click the Clients area.</p> <p>If you installed the client management service on a backup-archive client, you can view and analyze the client error and schedule logs by completing the following steps:</p> <ol style="list-style-type: none"> <li>1. In the Clients table, select the client and click Details.</li> <li>2. To diagnose an issue, click Diagnosis.</li> </ol>	<p>For clients that do not have the client management service installed, access the client system to review the client error logs.</p>

Task	Basic procedures	Advanced procedures and troubleshooting information
<p><b>2</b> Determine whether client-related or server-related errors require attention.</p>	<p>To determine the severity of any reported alerts, in the Alerts area, hover over the columns.</p>	<p>To view additional information about alerts, complete the following steps:</p> <ol style="list-style-type: none"> <li>1. Click the Alerts area.</li> <li>2. In the Alerts table, select an alert.</li> <li>3. In the Activity Log pane, review the messages. The pane displays related messages that were issued before and after the selected alert occurred.</li> </ol>
<p><b>3</b> Determine whether servers that are managed by the Operations Center are available to provide data protection services to clients.</p>	<ol style="list-style-type: none"> <li>1. To verify whether servers are at risk, in the Servers area, look for an Unavailable notification.</li> <li>2. To view additional information, click the Servers area.</li> <li>3. Select a server in the Servers table and click Details.</li> </ol>	<p>Tip: If you detect an issue that is related to server properties, update the server properties:</p> <ol style="list-style-type: none"> <li>1. In the Servers table, select a server and click Details.</li> <li>2. To update server properties, click Properties.</li> </ol>
<p><b>4</b> Determine whether sufficient space is available for the server inventory, which consists of the server database, active log, and archive log.</p>	<ol style="list-style-type: none"> <li>1. Click the Servers area.</li> <li>2. In the Status column of the table, view the status of the server and resolve any issues: <ul style="list-style-type: none"> <li>o Normal  Sufficient space is available for the server database, active log, and archive log.</li> <li>o Critical  Insufficient space is available for the server database, active log, or archive log. You must add space immediately, or the data protection services that are provided by the server will be interrupted.</li> <li>o Warning  The server database, active log, or archive log is running out of space. If this condition persists, you must add space.</li> <li>o Unavailable  Status cannot be obtained. Ensure that the server is running, and that there are no network issues. This status is also shown if the monitoring administrator ID is locked or otherwise unavailable on the server. This ID is named IBM-OC-hub_server_name.</li> <li>o Unmonitored  Unmonitored servers are defined to the hub server, but are not configured for management by the Operations Center. To configure an unmonitored server, select the server, and click Monitor Spoke.</li> </ul> </li> </ol>	<p>You can also look for related alerts on the Alerts page. For additional instructions about troubleshooting, see Resolving server problems.</p>

Task	Basic procedures	Advanced procedures and troubleshooting information
<p><b>5</b> Verify server database backup operations.</p>	<p>To determine when a server was most recently backed up, complete the following steps:</p> <ol style="list-style-type: none"> <li>1. Click the Servers area.</li> <li>2. In the Servers table, review the Last Database Backup column.</li> </ol>	<p>To obtain more detailed information about backup operations, complete the following steps:</p> <ol style="list-style-type: none"> <li>1. In the Servers table, select a row and click Details.</li> <li>2. In the DB Backup area, hover over the check marks to review information about backup operations.</li> </ol> <p>If a database was not backed up recently (for example, in the last 24 hours), you can start a backup operation:</p> <ol style="list-style-type: none"> <li>1. On the Operations Center Overview page, click the Servers area.</li> <li>2. In the table, select a server and click Back Up.</li> </ol> <p>To determine whether the server database is configured for automatic backup operations, complete the following steps:</p> <ol style="list-style-type: none"> <li>1. On the menu bar, hover over the settings icon  and click Command Builder.</li> <li>2. Issue the QUERY DB command: <pre>query db f=d</pre> </li> <li>3. In the output, review the Full Device Class Name field. If a device class is specified, the server is configured for automatic database backups.</li> </ol>
<p><b>6</b> Monitor other server maintenance tasks. Server maintenance tasks can include running administrative command schedules, maintenance scripts, and related commands.</p>	<p>To search for information about processes that failed because of server issues, complete the following steps:</p> <ol style="list-style-type: none"> <li>1. Click Servers &gt; Maintenance.</li> <li>2. To obtain the two-week history of a process, view the History column.</li> <li>3. To obtain more information about a scheduled process, hover over the check box that is associated with the process.</li> </ol>	<p>For more information about monitoring processes and resolving issues, see the Operations Center online help.</p>
<p><b>7</b> Verify that the amount of data that was recently sent to and from servers is within the expected range.</p>	<ul style="list-style-type: none"> <li>• To obtain an overview of activity in the last 24 hours, view the Activity area.</li> <li>• To compare activity in the last 24 hours with activity in the previous 24 hours, review the figures in the Current and Previous areas.</li> </ul>	<ul style="list-style-type: none"> <li>• If more data was sent to the server than you expected, determine which clients are backing up more data and investigate the cause. It is possible that client-side data deduplication is not working correctly.</li> <li>• If less data was sent to the server than you expected, investigate whether client backup operations are proceeding on schedule.</li> </ul>



Task	Basic procedures	Advanced procedures and troubleshooting information
<p>8 Verify that storage pools are available to back up client data.</p>	<ol style="list-style-type: none"> <li>1. If problems are indicated in the Storage &amp; Data Availability area, click Pools to view the details: <ul style="list-style-type: none"> <li>o If the Critical  status is displayed, insufficient space is available in the storage pool, or its access status is unavailable.</li> <li>o If the Warning  status is displayed, the storage pool is running out of space, or its access status is read-only.</li> </ul> </li> <li>2. To view the used, free, and total space for your selected storage pool, hover over the entries in the Capacity Used column.</li> </ol>	<p>To view the storage-pool capacity that was used over the past two weeks, select a row in the Storage Pools table and click Details.</p>
<p>9 Verify that storage devices are available for backup operations.</p>	<p>In the Storage &amp; Data Availability area, in the Volumes section, under the capacity bars, review the status that is reported next to Devices. If a Critical  or Warning  status is displayed for any device, investigate the issue. To view details, click Devices.</p>	<p>Disk devices might have a critical or warning status for the following reasons:</p> <ul style="list-style-type: none"> <li>• For DISK device classes, volumes might be offline or have a read-only access status. The Disk Storage column of the Disk Devices table shows the state of volumes.</li> <li>• For FILE device classes that are not shared, directories might be offline. Also, insufficient free space might be available for allocating scratch volumes. The Disk Storage column of the Disk Devices table shows the state of directories.</li> <li>• For FILE device classes that are shared, drives might be unavailable. A drive is unavailable if it is offline, if it stopped responding to the server, or if its path is offline. Other columns of the Disk Devices table show the state of the drives and paths.</li> </ul> <p>Tape devices might have a warning or critical status if drives are unavailable. A drive is unavailable if it is offline, if it stopped responding to the server, or if its path is offline. A tape device might also have a critical status if the library is offline. Other columns of the Tape Devices table show the state of the library robotics, drives, and paths.</p> <p>For tape backup operations, verify that sufficient scratch tapes are available. If you are not certain whether the number of available scratch tapes is sufficient, open the details notebook to view tape usage and an estimate of scratch tape availability. To open the details notebook, select a library in the table and click Details.</p>

Task	Basic procedures	Advanced procedures and troubleshooting information
<p><b>10</b> Monitor node replication processes.</p>	<ol style="list-style-type: none"> <li>1. To obtain the overall status of node replication processes, view the Replication area on the Operations Center Overview page.</li> <li>2. To view information about each replicated server pair, click the Replication area.</li> <li>3. To view the amount of data that was replicated over the last two weeks and the speed of replication, select a server pair and click Details.</li> <li>4. To view replication information for a client, on the Operations Center Overview page, click Clients. View the information in the Replication Workload column.</li> </ol>	<p>For advanced monitoring, view information about running and ended node replication processes by using commands:</p> <ol style="list-style-type: none"> <li>1. On the Operations Center Overview page, hover over the settings icon  and click Command Builder.</li> <li>2. Issue the QUERY REPLICATION command. For instructions, see QUERY REPLICATION (Query node replication processes). If the replication operation was completed successfully, the <code>Total Files To Replicate</code> value matches the <code>Total Files Replicated</code> value.</li> </ol> <p>To display messages that are related to a node replication process on a source or target replication server, complete the following steps:</p> <ol style="list-style-type: none"> <li>1. On the Operations Center Overview page, click Servers.</li> <li>2. Select the source or target replication server and click Details: <ul style="list-style-type: none"> <li>o To view active tasks, click Active Tasks, select the task, and verify that the Running status is displayed. For details, view the related activity logs.</li> <li>o To view completed tasks, click Completed Tasks, select the task, and ensure that the Completed status is displayed. For details, view the related activity logs.</li> </ul> </li> </ol>

## Periodic monitoring checklist

To help ensure operations run correctly, complete the tasks in the periodic monitoring checklist. Schedule periodic tasks frequently enough so that you can detect potential issues before they become problematic.



Tip: To run administrative commands for advanced monitoring tasks, use the Operations Center command builder. The command builder provides a type-ahead function to guide you as you enter commands. To open the command builder, go to the Operations Center Overview page. On the menu bar, hover over the settings icon  and click Command Builder.

Table 1. Periodic monitoring tasks

Task	Basic procedures	Advanced procedures and troubleshooting
------	------------------	---

Task	Basic procedures	Advanced procedures and troubleshooting
<p>Monitor system performance.</p>	<p>Determine the length of time that is required for client backup operations:</p> <ol style="list-style-type: none"> <li>1. On the Operations Center Overview page, click Clients. Find the server that is associated with the client.</li> <li>2. Click Servers. Select the server and click Details.</li> <li>3. To view the duration of completed tasks in the last 24 hours, click Completed Tasks.</li> <li>4. To view the duration of tasks that were completed more than 24 hours ago, use the QUERY ACTLOG command. Follow the instructions in QUERY ACTLOG (Query the activity log).</li> <li>5. If the duration of client backup operations is increasing and the reasons are not clear, investigate the cause.</li> </ol> <p>If you installed the client management service on a backup-archive client, you can diagnose performance issues for the backup-archive client by completing the following steps:</p> <ol style="list-style-type: none"> <li>1. On the Operations Center Overview page, click Clients.</li> <li>2. Select a backup-archive client and click Details.</li> <li>3. To retrieve client logs, click Diagnosis.</li> </ol>	<p>For instructions about reducing the time that it takes for the client to back up data to the server, see Resolving common client performance problems.</p> <p>Look for performance bottlenecks. For instructions, see Identifying performance bottlenecks.</p> <p>For information about identifying and resolving other performance issues, see Performance.</p>
<p>Determine the disk savings that are provided by data deduplication.</p>	<ol style="list-style-type: none"> <li>1. On the Operations Center Overview page, click Pools.</li> <li>2. Select a pool and click Quick Look.</li> <li>3. In the Data Deduplication area, view the Space saved row.</li> </ol>	<p>For advanced monitoring, to obtain detailed statistics about the data-deduplication process for a specific directory-container storage pool or cloud-container storage pool, complete the following steps:</p> <ol style="list-style-type: none"> <li>1. On the Operations Center Overview page, hover over the settings icon  and click Command Builder.</li> <li>2. Obtain a statistical report by issuing the GENERATE DEDUPSTATS command. Follow the instructions in GENERATE DEDUPSTATS (Generate data deduplication statistics for a directory-container storage pool).</li> <li>3. View the statistical report by issuing the QUERY DEDUPSTATS command. Follow the instructions in QUERY DEDUPSTATS (Query data deduplication statistics).</li> </ol>

Task	Basic procedures	Advanced procedures and troubleshooting
<p>Verify that current backup files for device configuration and volume history information are saved.</p>	<p>Access your storage locations to ensure that the files are available. The preferred method is to save the backup files to two locations.</p> <p>To locate the volume history and device configuration files, complete the following steps:</p> <ol style="list-style-type: none"> <li>1. On the Operations Center Overview page, hover over the settings icon  and click Command Builder.</li> <li>2. To locate the volume history and device configuration files, issue the following commands: <ul style="list-style-type: none"> <li><code>query option volhistory</code></li> <li><code>query option devconfig</code></li> </ul> </li> <li>3. In the output, review the Option Setting column to find the file locations.</li> </ol> <p>If a disaster occurs, both the volume history file and the device configuration file are required to restore the server database.</p>	

Task	Basic procedures	Advanced procedures and troubleshooting
<p>Determine whether sufficient space is available for the instance directory file system.</p>	<p>Verify that at least 20% of free space is available in the instance directory file system. Take the action that is appropriate for your operating system:</p> <ul style="list-style-type: none"> <li>• <b>AIX</b> To view available space in the file system, on the operating system command line, issue the following command:  <code>df -g instance_directory</code>  where <i>instance_directory</i> specifies the instance directory.</li> <li>• <b>Linux</b> To view available space in the file system, on the operating system command line, issue the following command:  <code>df -h instance_directory</code>  where <i>instance_directory</i> specifies the instance directory.</li> <li>• <b>Windows</b> In the Windows Explorer program, right-click the file system and click Properties. View the capacity information.</li> </ul> <p>The preferred location of the instance directory depends on the operating system where the server is installed:</p> <ul style="list-style-type: none"> <li>• <b>AIX</b>   <b>Linux</b> <code>/home/tsminst1/tsminst1</code></li> <li>• <b>Windows</b> <code>C:\tsminst1</code></li> </ul> <p>Tip: If you completed a planning worksheet, the location of the instance directory is recorded in the worksheet.</p>	
<p>Identify unexpected client activity.</p>	<p>To monitor client activity to determine whether data volumes exceed expected amounts, complete the following steps:</p> <ol style="list-style-type: none"> <li>1. On the Operations Center Overview page, click the Clients area.</li> <li>2. To view activity over the past two weeks, double-click any client.</li> <li>3. To view the number of bytes sent to the client, click the Properties tab.</li> <li>4. In the Last Session area, view the Sent to client row.</li> </ol>	<p>When you double-click a client in the Clients table, the Activity over 2 Weeks area displays the amount of data that the client sent to the server each day.</p>

Task	Basic procedures	Advanced procedures and troubleshooting
<p>Monitor storage pool growth over time.</p>	<ol style="list-style-type: none"> <li>1. On the Operations Center Overview page, click the Pools area.</li> <li>2. To view the capacity that was used over the last two weeks, select a pool and click Details.</li> </ol>	<p>Tips:</p> <ul style="list-style-type: none"> <li>• To specify the time period that must elapse before all deduplicated extents are removed from a directory-container storage pool or cloud-container storage pool after they are no longer referenced by the inventory, complete the following steps: <ol style="list-style-type: none"> <li>1. On the Storage Pools page of the Operations Center, select the storage pool.</li> <li>2. Click Details &gt; Properties.</li> <li>3. Specify the duration in the <code>Delay period for container reuse</code> field.</li> </ol> </li> <li>• To determine data deduplication performance for directory-container and cloud-container storage pools, use the <code>GENERATE DEDUPSTATS</code> command.</li> <li>• To view data deduplication statistics for a storage pool, complete the following steps: <ol style="list-style-type: none"> <li>1. On the Storage Pools page of the Operations Center, select the storage pool.</li> <li>2. Click Details &gt; Properties.</li> </ol> </li> </ul> <p>Alternatively, use the <code>QUERY EXTENTUPDATES</code> command to display information about updates to data extents in directory-container or cloud-container storage pools. The command output can help you determine which data extents are no longer referenced and which ones are eligible to be deleted from the system. In the output, monitor the number of data extents that are eligible to be deleted from the system. This metric has a direct correlation to the amount of free space that will be available within the container storage pool.</p> <ul style="list-style-type: none"> <li>• To display the amount of physical space that is occupied by a file space after the removal of the data deduplication savings, use the <code>select * from occupancy</code> command. The command output includes the <code>LOGICAL_MB</code> value. <code>LOGICAL_MB</code> is the amount of space that is used by the file space.</li> </ul>
<p>Evaluate the timing of client schedules. Ensure that the start and end times of client schedules meet your business needs.</p>	<p>On the Operations Center Overview page, click Clients &gt; Schedules.</p> <p>In the Schedules table, the Start column displays the configured start time for the scheduled operation. To see when the most recent operation was started, hover over the clock icon.</p>	<p>Tip: You can receive a warning message if a client operation runs longer than expected. Complete the following steps:</p> <ol style="list-style-type: none"> <li>1. On the Operations Center Overview page, hover over Clients and click Schedules.</li> <li>2. Select a schedule and click Details.</li> <li>3. View the details of a schedule by clicking the blue arrow next to the row.</li> <li>4. In the Run time alert field, specify the time when a warning message will be issued if the scheduled operation is not completed.</li> <li>5. Click Save.</li> </ol>

Task	Basic procedures	Advanced procedures and troubleshooting
Evaluate the timing of maintenance tasks. Ensure that the start and end times of maintenance tasks meet your business needs.	<p>On the Operations Center Overview page, click Servers &gt; Maintenance.</p> <p>In the Maintenance table, review the information in the Last Run Time column. To see when the last maintenance task was started, hover over the clock icon.</p>	<p>Tip: If a maintenance task is running too long, change the start time or the maximum run time. Complete the following steps:</p> <ol style="list-style-type: none"> <li>1. On the Operations Center Overview page, hover over the settings icon  and click Command Builder.</li> <li>2. To change the start time or maximum run time for a task, issue the UPDATE SCHEDULE command. For instructions, see UPDATE SCHEDULE (Update a client schedule).</li> </ol>

**Related reference:**

QUERY ACTLOG (Query the activity log)

[↗](#) UPDATE STGPOOL (Update a storage pool)

[↗](#) QUERY EXTENTUPDATES (Query updated data extents)

## Verifying license compliance

Verify that your IBM Spectrum Protect™ solution complies with the provisions of your licensing agreement. By verifying compliance regularly, you can track trends in data growth or processor value unit (PVU) usage. Use this information to plan for future license purchasing.

### About this task

The method that you use to verify that your solution complies with license terms varies depending on the provisions of your IBM Spectrum Protect licensing agreement.

#### Front-end capacity licensing

The front-end model determines license requirements based on the amount of primary data that is reported as being backed up by clients. Clients include applications, virtual machines, and systems.

#### Back-end capacity licensing

The back-end model determines license requirements based on the terabytes of data that are stored in primary storage pools and repositories.

Tips:

- To ensure the accuracy of front-end and back-end capacity estimates, install the most recent version of the client software on each client node.
- The front-end and back-end capacity information in the Operations Center is for planning and estimation purposes.

#### PVU licensing

The PVU model is based on the use of PVUs by server devices.

Important: The PVU calculations that are provided by IBM Spectrum Protect are considered estimates and are not legally binding. The PVU licensing information that is reported by IBM Spectrum Protect is not considered an acceptable substitute for the IBM® License Metric Tool.



For the most recent information about licensing models, see the information about product details and licenses at the IBM Spectrum Protect product family website. If you have questions or concerns about licensing requirements, contact your IBM Spectrum Protect software provider.

## Procedure

To monitor license compliance, complete the steps that correspond to the provisions of your licensing agreement.

Tip: The Operations Center provides an email report that summarizes front-end and back-end capacity usage. Reports can be sent automatically to one or more recipients regularly. To configure and manage email reports, click Reports on the Operations Center menu bar.

Option	Description

Option	Description
<b>Front-end model</b>	<p>a. On the Operations Center menu bar, hover over the settings icon  and click Licensing.</p> <p>The front-end capacity estimate is displayed on the Front-end Usage page.</p> <p>b. If a value is displayed in the Not Reporting column, click the number to identify clients that did not report capacity usage.</p> <p>c. To estimate capacity for clients that did not report capacity usage, go to the following FTP site, which provides measuring tools and instructions:</p> <p><code>ftp://public.dhe.ibm.com/storage/tivoli-storage-management/front_end_capacity_measurement_tools</code></p> <p>To measure front-end capacity by script, complete the instructions in the most recently available licensing guide.</p> <p>d. Add the Operations Center estimate and any estimates that you obtained by using a script.</p> <p>e. Verify that the estimated capacity complies with your licensing agreement.</p>
<b>Back-end model</b>	<p>Restriction: If the source and target replication servers do not use the same policy settings, you cannot use the Operations Center to monitor back-end capacity usage for replicated clients. For information about how to estimate capacity usage for these clients, see technote 1656476.</p> <p>a. On the Operations Center menu bar, hover over the settings icon  and click Licensing.</p> <p>b. Click the Back-end tab.</p> <p>c. Verify that the estimated amount of data complies with your licensing agreement.</p>
<b>PVU model</b>	<p>For information about how to assess compliance with PVU licensing terms, see <a href="#">Assessing compliance with the PVU licensing model</a>.</p>

- Assessing compliance with the PVU licensing model
  - If you purchased IBM Spectrum Protect under the processor value unit (PVU) licensing model, ensure that your solution complies with the license terms. Review the PVU estimates periodically to plan for future license purchasing. For example, if PVU estimates increase or you plan to install more servers, you might have to purchase more licenses.

## Tracking system status by using email reports

Set up the Operations Center to generate email reports that summarize system status. You can configure a mail server connection, change report settings, and optionally create custom SQL reports.

### Before you begin

Before you set up email reports, ensure that the following requirements are met:

- A Simple Mail Transfer Protocol (SMTP) host server is available to send and receive reports by email. The SMTP server must be configured as an open mail relay. You must also ensure that the IBM Spectrum Protect™ server that sends email messages has access to the SMTP server. If the Operations Center is installed on a separate computer, that computer does not require access to the SMTP server.
- To set up email reports, you must have system privilege for the server.
- To specify the recipients, you can enter one or more email addresses or administrator IDs. If you plan to enter an administrator ID, the ID must be registered on the hub server and must have an email address associated with it. To specify an email address for an administrator, use the EMAILADDRESS parameter of the UPDATE ADMIN command.

### About this task

You can configure the Operations Center to send a general operations report, a license compliance report, and one or more custom reports, which use SQL SELECT statements to query managed servers.

### Procedure

To set up and manage email reports, complete the following steps:



1. On the Operations Center menu bar, click Reports.
  2. If an email server connection is not yet configured, click Configure Mail Server and complete the fields. After you configure the mail server, the general operations report and license compliance report are enabled.
  3. To change report settings, select a report, click Details, and update the form.
  4. Optional: To add a custom SQL report, click + Report, and complete the fields.
- Tip: To immediately run and send a report, select the report and click Send.

## Results

Enabled reports are sent according to the specified settings.

**Related reference:**

[UPDATE ADMIN \(Update an administrator\)](#)

**Related information:**

[Custom Report Examples](#)

## Selecting, configuring, and using monitoring tools

Use the Operations Center to obtain an overview of system status and to drill down to more detailed information. In some cases, you might want to use advanced tools to collect specific monitoring information.

## Procedure

Select and configure the monitoring tools that are appropriate for your solution.

Table 1. Monitoring tools

Tool type	Use cases	Links to more information
Operations Center	<ul style="list-style-type: none"> <li>• Use the graphical user interface to review system status and diagnose issues.</li> <li>• Set up the Operations Center to send daily email summary reports.</li> <li>• Optional: Customize the alerts that are displayed in the Operations Center and set up email notifications about the alerts.</li> <li>• Optional: Monitor the storage environment remotely by viewing the Overview page in the web browser of a mobile device. For example, you can use the Apple Safari web browser on an Apple iPad device. Other mobile devices can also be used.</li> </ul> <p>Tip: If you install IBM Spectrum Protect™ client management services on a backup-archive client, you can use the Operations Center to obtain troubleshooting information for the backup-archive client. The client management service can be installed only on Linux or Windows operating systems.</p>	

Tool type	Use cases	Links to more information
IBM Spectrum Protect administrative commands	<p>Review detailed information. Use the method that is appropriate for your solution:</p> <ul style="list-style-type: none"> <li>To display messages that were generated by the server and client, use the QUERY ACTLOG command. Tip: You can run administrative commands from the Operations Center command builder.</li> <li>To monitor activities such as server migration and client logons, use the administrative client in console mode. Run the <code>dsmadm -consolemode</code> command.</li> </ul>	<ul style="list-style-type: none"> <li>Administrative commands</li> <li>QUERY ACTLOG (Query the activity log)</li> <li>Monitoring server activities from the administrative client</li> <li>Administrative client options</li> </ul>
Event logging	Log server messages and most client messages as events to one or more repositories called receivers.	<p><b>AIX</b>   <b>Linux</b>   <b>Windows</b> For instructions about using event logging to monitor a solution, see <a href="#">Logging IBM Spectrum Protect events to receivers (V7.1.1)</a>.</p> <p><b>Linux</b> For instructions about logging events to a Linux system log, see <a href="#">Logging events to the Linux system log (V7.1.4)</a>.</p>
SQL queries	<p>Create and format customized queries of the server database. For example, you can query the SQL activity summary table to view statistics about client operations and server processes. To display all information in the summary table, issue the following command from the administrative client:</p> <pre>select * from summary</pre>	Using SELECT commands (V7.1.1)
Operating system tools	Monitor and test system performance.	
Device-monitoring tools	Monitor devices for availability, capacity, and performance. For example, use IBM Spectrum Control™ or tools that are included in device hardware packages.	<p>To monitor overall device status by using IBM Spectrum Control, follow the instructions in <a href="#">Monitoring the status and condition of resources</a>.</p> <p>To monitor performance by using IBM Spectrum Control, follow the instructions in <a href="#">Monitoring the performance of resources</a>.</p>
IBM® Tivoli® Monitoring for Tivoli Storage Manager	<p>Monitor IBM Spectrum Protect servers and produce historical reports about server and client activities. Tip: The Operations Center is the preferred tool for monitoring. However, Tivoli Monitoring for Tivoli Storage Manager is useful for generating historical reports that are based on IBM Cognos® Business Intelligence technology.</p>	Tivoli Monitoring for Tivoli Storage Manager

## Managing operations

---

By effectively managing server and client operations, you can optimize the performance of your storage environment. To get started, monitor the environment by using the Operations Center. Then, take action to prevent potential issues and improve performance.

### About this task

---

- **Managing server operations**  
You can start and stop the server, manage inventory capacity, and manage memory and processor usage. You can also optimize data transfer between servers, upgrade the server, and tune scheduled activities.
- **Managing client operations**  
You can evaluate and resolve errors that are related to a backup-archive client by using the Operations Center, which provides suggestions for resolving errors. For errors on other types of clients, you must examine the error logs on the client and review the product documentation.
- **Managing the Operations Center**  
The Operations Center provides web and mobile access to status information about the IBM Spectrum Protect™ environment. You can use the Operations Center to monitor multiple servers and to complete some administrative tasks. The Operations Center also provides web access to the IBM Spectrum Protect command line.

## Managing server operations

---

You can start and stop the server, manage inventory capacity, and manage memory and processor usage. You can also optimize data transfer between servers, upgrade the server, and tune scheduled activities.

- **Stopping and starting the server**  
Before you complete maintenance or reconfiguration tasks, stop the server. Then, start the server in maintenance mode. When you are finished with the maintenance or reconfiguration tasks, restart the server in production mode.
- **Managing inventory capacity**  
Manage the capacity of the database, active log, and archive logs to ensure that the inventory is sized for the tasks, based on the status of the logs.
- **Managing memory and processor usage**  
Ensure that you manage memory requirements and processor usage to ensure that the server can complete data processes such as backup and data deduplication. Consider the impact on performance when you complete certain processes.
- **Determining whether Aspera FASP technology can optimize data transfer in your system environment**  
If your IBM Spectrum Protect™ server replicates nodes or protects storage pools to a remote server, determine whether Aspera® Fast Adaptive Secure Protocol (FASP®) technology can improve data throughput to the remote server. Before you enable Aspera FASP technology, you must obtain the appropriate licenses. Both evaluation and full licenses are available.
- **Planning to upgrade the server**  
When a fix pack or interim fix becomes available, you can upgrade the IBM Spectrum Protect server to take advantage of product improvements. Servers and clients can be upgraded at different times. Ensure that you complete the planning steps before you upgrade the server.
- **Tuning scheduled activities**  
Schedule maintenance tasks daily to ensure that your solution operates correctly. By tuning your solution, you maximize server resources and effectively use different functions available within your solution.

## Stopping and starting the server

---

Before you complete maintenance or reconfiguration tasks, stop the server. Then, start the server in maintenance mode. When you are finished with the maintenance or reconfiguration tasks, restart the server in production mode.

### Before you begin

---

You must have system or operator privilege to stop and start the IBM Spectrum Protect™ server.

- **Stopping the server**  
Before you stop the server, prepare the system by ensuring that all database backup operations are completed, and all other processes and sessions are ended. In this way, you can safely shut down the server and ensure that data is protected.
- **Starting the server for maintenance or reconfiguration tasks**  
Before you begin server maintenance or reconfiguration tasks, start the server in maintenance mode. When you start the

server in maintenance mode, you disable operations that might disrupt your maintenance or reconfiguration tasks.

## Stopping the server

---

Before you stop the server, prepare the system by ensuring that all database backup operations are completed, and all other processes and sessions are ended. In this way, you can safely shut down the server and ensure that data is protected.

### About this task

---

When you issue the HALT command to stop the server, the following actions occur:

- All processes and client node sessions are canceled.
- All current transactions are stopped. (The transactions will be rolled back when the server is restarted.)

### Procedure

---

To prepare the system and stop the server, complete the following steps:

1. Prevent new client node sessions from starting by issuing the DISABLE SESSIONS command:

```
disable sessions all
```

2. Determine whether any client node sessions or processes are in progress by completing the following steps:
  - a. On the Overview page of the Operations Center, view the Activity area for the total numbers of processes and sessions that are currently active. If numbers differ significantly from the usual numbers that are displayed during your daily storage-management routine, view other status indicators in the Operations Center to check whether there is a problem.
  - b. View the graph in the Activity area to compare the amount of network traffic over the following periods:
    - The current period, that is, the most recent 24-hour period
    - The previous period, that is, the 24 hours before the current periodIf the graph for the previous period represents the expected amount of traffic, significant differences on the graph for the current period might indicate a problem.
  - c. On the Servers page, select a server for which you want to view processes and sessions, and click Details. If the server is not registered as a hub or spoke server in the Operations Center, obtain information about processes by using administrative commands. Issue the QUERY PROCESS command to query processes and obtain information about sessions by issuing the QUERY SESSION command.
3. Wait until the client node sessions are completed or cancel them. To cancel processes and sessions, complete the following steps:
  - o On the Servers page, select a server for which you want to view processes and sessions, and click Details.
  - o Click the Active Tasks tab, and select one or more processes, sessions, or a combination of both that you want to cancel.
  - o Click Cancel.
  - o If the server is not registered as a hub or spoke server in the Operations Center, cancel sessions by using administrative commands. Issue the CANCEL SESSION command to cancel a session and cancel processes by using the CANCEL PROCESS command.

Tip: If the process that you want to cancel is waiting for a tape volume to be mounted, the mount request is canceled. For example, if you issue an EXPORT, IMPORT, or MOVE DATA command, the command might initiate a process that requires a tape volume to be mounted. However, if a tape volume is being mounted by an automated library, the cancel operation might not take effect until the mount process is complete. Depending on your system environment, this could take several minutes.
4. Stop the server by issuing the HALT command:

```
halt
```

## Starting the server for maintenance or reconfiguration tasks

---

Before you begin server maintenance or reconfiguration tasks, start the server in maintenance mode. When you start the server in maintenance mode, you disable operations that might disrupt your maintenance or reconfiguration tasks.

### About this task

---

Start the server in maintenance mode by running the DSMSEV utility with the MAINTENANCE parameter.

The following operations are disabled in maintenance mode:

- Administrative command schedules
- Client schedules
- Reclamation of storage space on the server
- Inventory expiration
- Migration of storage pools

In addition, clients are prevented from starting sessions with the server.

Tips:

- You do not have to edit the server options file, `dmserv.opt`, to start the server in maintenance mode.
- While the server is running in maintenance mode, you can manually start the storage-space reclamation, inventory expiration, and storage-pool migration processes.

## Procedure

---

To start the server in maintenance mode, issue the following command:

```
dmserv maintenance
```

Tip: To view a video about starting the server in maintenance mode, see [Starting a server in maintenance mode](#).

## What to do next

---

To resume server operations in production mode, complete the following steps:

1. Shut down the server by issuing the HALT command:

```
halt
```

2. Start the server by using the method that you use in production mode. Follow the instructions for your operating system:
  - o **AIX** Starting the server instance
  - o **Linux** Starting the server instance
  - o **Windows** Starting the server instance

Operations that were disabled during maintenance mode are reenabled.

## Managing inventory capacity

---

Manage the capacity of the database, active log, and archive logs to ensure that the inventory is sized for the tasks, based on the status of the logs.

### Before you begin

---

The active and archive logs have the following characteristics:

- The active log can be a maximum size of 512 GB. For more information about sizing the active log for your system, see [Planning the storage arrays](#).
- The archive log size is limited to the size of the file system that it is installed on. The archive log size is not maintained at a predefined size like the active log. Archive log files are automatically deleted after they are no longer needed.

As a best practice, you can optionally create an archive failover log to store archive log files when the archive log directory is full.

Check the Operations Center to determine the component of the inventory that is full. Ensure that you stop the server before you increase the size of one of the inventory components.

## Procedure

---

- To increase the size of the database, complete the following steps:
  - o Create one or more directories for the database on separate drives or file systems.
  - o Issue the `EXTEND DBSPACE` command to add the directory or directories to the database. The directories must be accessible to the instance user ID of the database manager. By default, data is redistributed across all database directories and space is reclaimed.

Tips:

- The time that is needed to complete redistribution of data and reclaiming of space is variable, depending on the size of your database. Make sure that you plan adequately.
    - Ensure that the directories that you specify are the same size as existing directories to ensure a consistent degree of parallelism for database operations. If one or more directories for the database are smaller than the others, they reduce the potential for optimized parallel prefetching and distribution of the database.
  - Halt and restart the server to fully use the new directories.
  - Reorganize the database if necessary. Index and table reorganization for the server database can help to avoid unexpected database growth and performance issues. For more information about reorganizing the database, see technote 1683633.
- To decrease the size of the database for V7.1 servers and later, issue the following DB2® commands from the server instance directory:  
 Restriction: The commands can increase I/O activity, and might affect server performance. To minimize performance problems, wait until one command is completed before you issue the next command. The DB2 commands can be issued when the server is running.

```
db2 connect to tsmdb1
db2 set schema tsmdb1
db2 ALTER TABLESPACE USERSPACE1 REDUCE MAX
db2 ALTER TABLESPACE IDXSPACE1 REDUCE MAX
db2 ALTER TABLESPACE LARGEIDXSPACE1 REDUCE MAX
db2 ALTER TABLESPACE LARGESPACE1 REDUCE MAX
db2 ALTER TABLESPACE REPLTBLSPACE1 REDUCE MAX
db2 ALTER TABLESPACE REPLIDXSPACE1 REDUCE MAX
db2 ALTER TABLESPACE ARCHOBJDATASPACE REDUCE MAX
db2 ALTER TABLESPACE ARCHOBJIDXSPACE REDUCE MAX
db2 ALTER TABLESPACE BACKOBJDATASPACE REDUCE MAX
db2 ALTER TABLESPACE BACKOBJIDXSPACE REDUCE MAX
db2 ALTER TABLESPACE BFABFDATASPACE REDUCE MAX
db2 ALTER TABLESPACE BFABFIDXSPACE REDUCE MAX
db2 ALTER TABLESPACE BFBFEXTDATASPACE REDUCE MAX
db2 ALTER TABLESPACE BFBFEXTIDXSPACE REDUCE MAX
db2 ALTER TABLESPACE DEDUPTBLSPACE1 REDUCE MAX
db2 ALTER TABLESPACE DEDUPIIDXSPACE1 REDUCE MAX
db2 ALTER TABLESPACE DEDUPTBLSPACE2 REDUCE MAX
db2 ALTER TABLESPACE DEDUPIIDXSPACE2 REDUCE MAX
db2 ALTER TABLESPACE DEDUPTBLSPACE3 REDUCE MAX
db2 ALTER TABLESPACE DEDUPIIDXSPACE3 REDUCE MAX
db2 ALTER TABLESPACE DEDUPTBLSPACE4 REDUCE MAX
db2 ALTER TABLESPACE DEDUPIIDXSPACE4 REDUCE MAX
db2 ALTER TABLESPACE DEDUPTBLSPACE5 REDUCE MAX
db2 ALTER TABLESPACE DEDUPIIDXSPACE5 REDUCE MAX
```

- To increase or decrease the size of the active log, complete the following steps:
  1. Ensure that the location for the active log has enough space for the increased log size. If a log mirror exists, its location must also have enough space for the increased log size.
  2. Halt the server.
  3. In the dsmserv.opt file, update the ACTIVELOGSIZE option to the new size of the active log, in megabytes. The size of an active log file is based on the value of the ACTIVELOGSIZE option. Guidelines for space requirements are in the following table:

Table 1. How to estimate volume and file space requirements

ACTIVELOGSize option value	Reserve this much free space in the active log directory, in addition to the ACTIVELOGSize space
16 GB - 128 GB	5120 MB
129 GB - 256 GB	10240 MB
257 GB - 512 GB	20480 MB

To change the active log to its maximum size of 512 GB, enter the following server option:

```
activelogsiz 524288
```

4. If you plan to use a new active log directory, update the directory name that is specified in the ACTIVELOGDIRECTORY server option. The new directory must be empty and must be accessible to the user ID of the database manager.
5. Restart the server.

- Compress the archive logs to reduce the amount of space that is required for storage. Enable dynamic compression of the archive log by issuing the following command:

```
setopt archlogcompress yes
```

Restriction: Use caution when you enable the ARCHLOGCOMPRESS server option on systems with sustained high volume usage and heavy workloads. Enabling this option in this system environment can cause delays in archiving log files from the active log file system to the archive log file system. This delay can cause the active log file system to run out of space. Be sure to monitor the available space in the active log file system after archive log compression is enabled. If the active log directory file system usage nears out of space conditions, the ARCHLOGCOMPRESS server option must be disabled. You can use the SETOPT command to disable archive log compression immediately without halting the server.

**Related reference:**

- 🔗 [ACTIVELOGSIZE server option](#)
- 🔗 [EXTEND DBSPACE \(Increase space for the database\)](#)
- 🔗 [SETOPT \(Set a server option for dynamic update\)](#)

## Managing memory and processor usage

---

Ensure that you manage memory requirements and processor usage to ensure that the server can complete data processes such as backup and data deduplication. Consider the impact on performance when you complete certain processes.

### Before you begin

---

- Ensure that your configuration uses the required hardware and software. For more information, see IBM Spectrum Protect™ Supported Operating Systems.
- For more information about managing resources such as the database and recovery log, see Planning the storage arrays.
- Add more system memory to determine whether there is a performance improvement. Monitor memory usage regularly to determine whether more memory is required.

### Procedure

---

1. Release memory from the file system cache where possible.
2. To manage the system memory that is used by each server on a system, use the DBMEMPERCENT server option. Limit the percentage of system memory that can be used by the database manager of each server. If all servers are equally important, use the same value for each server. If one server is a production server and other servers are test servers, set the value for the production server to a higher value than the test servers.
3. Set the user data limit and private memory for the database to ensure that private memory is not exhausted. Exhausting private memory can result in errors, less than optimal performance, and instability.

Linux

## Determining whether Aspera FASP technology can optimize data transfer in your system environment

---

If your IBM Spectrum Protect™ server replicates nodes or protects storage pools to a remote server, determine whether Aspera® Fast Adaptive Secure Protocol (FASP®) technology can improve data throughput to the remote server. Before you enable Aspera FASP technology, you must obtain the appropriate licenses. Both evaluation and full licenses are available.

### Before you begin

---

Aspera FASP technology is used to transfer data extents from a container storage pool to a remote server. When Aspera FASP technology is enabled, the data extents are always encrypted during transfer regardless of whether the Secure Sockets Layer (SSL) protocol is enabled. However, if you want to secure the network connection, enable SSL. For information about SSL and how to enable it, see Secure Sockets Layer and Transport Layer Security communication.

### About this task

---

Restrictions:

- Use Aspera FASP technology when your wide area network (WAN) shows signs of high packet loss, data transfer delays that are caused by network impairment, or both. If WAN performance meets your business needs, do not enable Aspera FASP technology.
- To enable Aspera FASP technology for node replication operations, the data must be stored in a directory-container storage pool.

## Procedure

---

1. Determine whether Aspera FASP technology is appropriate for your system environment. If either of the following conditions occurs, enable Aspera FASP technology:
  - Average delays for data-transfer operations exceed 50 milliseconds.
  - Packet loss is greater than 0.01%.

Network characteristics can vary widely. You might be able to improve network throughput by enabling Aspera FASP technology even if the data-transfer delay is less than 50 milliseconds and the packet loss is less than 0.01%.

2. Obtain and install the appropriate licenses. Take one of the following actions:

### Obtain and install evaluation licenses

To obtain and install evaluation licenses, which expire in 30 days, complete the following steps:

- a. Request the licenses by sending an email to [alliances@asperasoft.com](mailto:alliances@asperasoft.com):
  - Include your company name, address, phone number, and the email address of the primary contact at your company.
  - State that you require a 30-day evaluation license.
  - Indicate the number of licenses that you require.

One license is required for each server that is used for data transfer with Aspera FASP technology. For example, if you are replicating a node from a source server to a target server, you require two licenses.

If the license request is approved, the primary contact can expect to receive an email within 24 hours. The email will have license file attachments that are named according to the following convention:

```
xxxxx-ConnectSrv-unlim.eval.aspera-license
```

where xxxxx is a unique number.

- b. Copy one of the license files to the server bin directory of the source server. Select either license file. By default, the directory is in the following location:

```
/opt/tivoli/tsm/server/bin
```

- c. Copy the remaining license file to the bin directory of the target server.
- d. On the source and target servers, set the permission level of each license file to 755. For example, if you are using the default installation directory and the unique license number is 47474, issue the following command on one line:

```
chmod 755 /opt/tivoli/tsm/server/bin/  
47474-ConnectSrv-unlim.eval.aspera-license
```

### Obtain and install full licenses

To obtain and install full, unlimited licenses, which do not expire, complete the following steps:

- a. Purchase the IBM Spectrum Protect High Speed Data Transfer product. The product identification number is 5725-Z10. You can obtain the product from Passport Advantage®.

One instance of IBM Spectrum Protect High Speed Data Transfer is required for each server that is used to transfer data with Aspera FASP technology. For example, if you are replicating a node from a source server to a target server, you require two instances of IBM Spectrum Protect High Speed Data Transfer.

- b. Install IBM Spectrum Protect High Speed Data Transfer on each server by using the installation wizard.

**Restriction:** If the required licenses are missing or expired, operations to replicate nodes and protect storage pools by using Aspera FASP technology fail.

3. Optional: Validate the Aspera FASP configuration by issuing the `VALIDATE ASPERA` command. You can use the `VALIDATE ASPERA` command to verify that your system environment is correctly configured for Aspera FASP and to verify that valid



licenses are installed. In addition, you can use the command to compare the speed of network throughput with Aspera FASP and TCP/IP technology.

## What to do next

---

To enable Aspera FASP technology, follow the steps in [Optimizing data transfer by enabling Aspera FASP technology](#).

- [Optimizing data transfer by enabling Aspera FASP technology](#)  
If you use a remote server for storage pool protection or node replication and you experience network issues, you might want to optimize data transfer by using Aspera Fast Adaptive Secure Protocol (FASP) technology.

## Planning to upgrade the server

---

When a fix pack or interim fix becomes available, you can upgrade the IBM Spectrum Protect™ server to take advantage of product improvements. Servers and clients can be upgraded at different times. Ensure that you complete the planning steps before you upgrade the server.

## About this task

---

Follow these guidelines:

- The preferred method is to upgrade the server by using the installation wizard. After you start the wizard, in the IBM Installation Manager window, click the Update icon; do not click the Install or Modify icon.
- If upgrades are available for both the server component and the Operations Center component, select the check boxes to upgrade both components.

## Procedure

---

1. Review the list of fix packs and interim fixes. See [technote 1239415](#).
2. Review product improvements, which are described in readme files.  
Tip: When you obtain the installation package file from the IBM Spectrum Protect support site, you can also access the readme file.
3. Ensure that the version that you upgrade your server to is compatible with other components, such as storage agents and library clients. See [technote 1302789](#).
4. If your solution includes servers or clients at a level that is earlier than V7.1, review the guidelines to ensure that client backup and archive operations are not disrupted. See [technote 1053218](#).
5. Review the upgrade instructions. Ensure that you back up the server database, the device configuration information, and the volume history file.

## What to do next

---

To install a fix pack or interim fix, follow the instructions for your operating system:

- [AIX](#) Installing an IBM Spectrum Protect server fix pack
- [Linux](#) Installing an IBM Spectrum Protect server fix pack
- [Windows](#) Installing an IBM Spectrum Protect server fix pack

## Tuning scheduled activities

---

Schedule maintenance tasks daily to ensure that your solution operates correctly. By tuning your solution, you maximize server resources and effectively use different functions available within your solution.

## Procedure

---

1. Monitor system performance regularly to ensure that client backup and server maintenance tasks are completing successfully. Follow the instructions in [Monitoring storage solutions](#).
2. Optional: If the monitoring information shows that the server workload increased, review the planning information. Review whether the capacity of the system is adequate in the following cases:
  - The number of clients increases
  - The amount of data that is being backed up increases

- The amount of time that is available for backups changes
- 3. Determine whether your solution is performing at the level you expect. Review the client schedules to check whether tasks are completing within the scheduled time frame:
  - a. On the Clients page of the Operations Center, select the client.
  - b. Click Details.
  - c. From the client Summary page, review the Backed up and Replicated activity to identify any risks.
 Adjust the time and frequency of client backup operations, if necessary.
- 4. Schedule enough time for the following maintenance tasks to complete successfully within a 24-hour period:
  - a. Protect storage pools.
  - b. Replicate node data.
  - c. Back up the database.
  - d. Run expiration processing to remove client backups and archive file copies from server storage.

Tip: Schedule maintenance tasks to start at an appropriate time and in the correct sequence. For example, schedule replication tasks after client backups complete successfully.

- Moving clients from one server to another  
To avoid running out of space on a server or to resolve workload issues, you might have to move client nodes from one server to another.

**Related concepts:**

[Performance](#)

**Related tasks:**

[Deduplicating data \(V7.1.1\)](#)

## Managing client operations

---

You can evaluate and resolve errors that are related to a backup-archive client by using the Operations Center, which provides suggestions for resolving errors. For errors on other types of clients, you must examine the error logs on the client and review the product documentation.

### About this task

---

In some cases, you can resolve client errors by stopping and starting the client acceptor. If client nodes or administrator IDs are locked, you can resolve the issue by unlocking the client node or administrator ID, and then resetting the password.

For detailed instructions about identifying and resolving client errors, see [Resolving client problems](#).

- **Modifying the scope of a client backup**  
When you set up client backup operations, the preferred practice is to exclude objects that you do not require. For example, you typically want to exclude temporary files from a backup operation.
- **Evaluating errors in client error logs**  
You can resolve client errors by obtaining suggestions from the Operations Center or by reviewing error logs on the client.
- **Stopping and restarting the client acceptor**  
If you change the configuration of your solution, you must restart the client acceptor on all client nodes where a backup-archive client is installed.
- **Resetting passwords**  
If a password for a client node or an administrator ID is lost or forgotten, you can reset the password. Multiple attempts to access the system with an incorrect password can cause a client node or administrator ID to be locked. You can take steps to resolve the issue.
- **Decommissioning a client node**  
If a client node is no longer required, you can start a process to remove it from the production environment. For example, if a workstation was backing up data to the IBM Spectrum Protect™ server, but the workstation is no longer used, you can decommission the workstation.
- **Deactivating data to free storage space**  
In some cases, you can deactivate data that is stored on the IBM Spectrum Protect server. When you run the deactivation process, any backup data that was stored before the specified date and time is deactivated and will be deleted as it expires. In this way, you can free space on the server.
- **Managing client upgrades**  
When a fix pack or interim fix becomes available for a client, you can upgrade the client to take advantage of product improvements. Servers and clients can be upgraded at different times and can be at different levels with some restrictions.

## Modifying the scope of a client backup

---

When you set up client backup operations, the preferred practice is to exclude objects that you do not require. For example, you typically want to exclude temporary files from a backup operation.

### About this task

---

When you exclude unnecessary objects from backup operations, you get better control of the amount of storage space that is required for backup operations, and the cost of storage. Depending on your licensing package, you also might be able to limit licensing costs.

### Procedure

---

How you modify the scope of backup operations depends on the product that is installed on the client node:

- For a backup-archive client, you can create an include-exclude list to include or exclude a file, groups of files, or directories from backup operations. To create an include-exclude list, follow the instructions in [Creating an include-exclude list](#).

To ensure consistent use of an include-exclude list for all clients of one type, you can create a client option set on the server that contains the required options. Then, you assign the client option set to each of the clients of the same type. For details, see [Controlling client operations through client option sets](#).

- For a backup-archive client, you can specify the objects to include in an incremental backup operation by using the domain option. Follow the instructions in [Domain client option](#).
- For other products, to define which objects are included in and excluded from backup operations, follow the instructions in the product documentation.

## Evaluating errors in client error logs

---

You can resolve client errors by obtaining suggestions from the Operations Center or by reviewing error logs on the client.

### Before you begin

---

To resolve errors in a backup-archive client on a Linux or Windows operating system, ensure that the client management service is installed and started. For installation instructions, see [Collecting diagnostic information with client management services](#).

### Procedure

---

To diagnose and resolve client errors, take one of the following actions:

- If the client management service is installed on the client node, complete the following steps:
  1. On the Operations Center Overview page, click Clients and select the client.
  2. Click Details.
  3. On the client Summary page, click the Diagnosis tab.
  4. Review the retrieved log messages.

Tips:

- To show or hide the Client Logs pane, double-click the Client Logs bar.
- To resize the Client Logs pane, click and drag the Client Logs bar.

If suggestions are displayed on the Diagnosis page, select a suggestion. In the Client Logs pane, client log messages to which the suggestion relates are highlighted.

5. Use the suggestions to resolve the problems that are indicated by the error messages.

Tip: Suggestions are provided for only a subset of client messages.
- If the client management service is not installed on the client node, review the error logs for the installed client.

## Stopping and restarting the client acceptor

---

If you change the configuration of your solution, you must restart the client acceptor on all client nodes where a backup-archive client is installed.

## About this task

---

In some cases, you can resolve client scheduling problems by stopping and restarting the client acceptor. The client acceptor must be running to ensure that scheduled operations can occur on the client. For example, if you change the IP address or domain name of the server, you must restart the client acceptor.

## Procedure

---

Follow the instructions for the operating system that is installed on the client node:

### AIX and Oracle Solaris

- To stop the client acceptor, complete the following steps:
  - a. Determine the process ID for the client acceptor by issuing the following command on the command line:

```
ps -ef | grep dsmcad
```

Review the output. In the following sample output, 6764 is the process ID for the client acceptor:

```
root 6764 1 0 16:26:35 ? 0:00 /usr/bin/dsmcad
```

- b. Issue the following command on the command line:

```
kill -9 PID
```

where *PID* specifies the process ID for the client acceptor.

- To start the client acceptor, issue the following command on the command line:

```
/usr/bin/dsmcad
```

### Linux

- To stop the client acceptor (and not restart it), issue the following command:

```
# service dsmcad stop
```

- To stop and restart the client acceptor, issue the following command:

```
# service dsmcad restart
```

### MAC OS X

Click Applications > Utilities > Terminal.

- To stop the client acceptor, issue the following command:

```
/bin/launchctl unload -w com.ibm.tivoli.dsmcad
```

- To start the client acceptor, issue the following command:

```
/bin/launchctl load -w com.ibm.tivoli.dsmcad
```

### Windows

- To stop the client acceptor service, complete the following steps:
  - a. Click Start > Administrative Tools > Services.
  - b. Double-click the client acceptor service.
  - c. Click Stop and OK.
- To restart the client acceptor service, complete the following steps:
  - a. Click Start > Administrative Tools > Services.
  - b. Double-click the client acceptor service.
  - c. Click Start and OK.

#### Related reference:

[Resolving client scheduling problems](#)

---

## Resetting passwords

If a password for a client node or an administrator ID is lost or forgotten, you can reset the password. Multiple attempts to access the system with an incorrect password can cause a client node or administrator ID to be locked. You can take steps to resolve the issue.

## Procedure

---

To resolve password issues, take one of the following actions:

- If a backup-archive client is installed on a client node, and the password is lost or forgotten, complete the following steps:
  1. Generate a new password by issuing the UPDATE NODE command:

```
update node node_name new_password forcepwreset=yes
```

where *node\_name* specifies the client node and *new\_password* specifies the password that you assign.

2. Inform the client node owner about the changed password. When the owner of the client node logs in with the specified password, a new password is generated automatically. That password is unknown to users to enhance security.

Tip: The password is generated automatically if you previously set the passwordaccess option to `generate` in the client options file.

- If an administrator is locked out because of password issues, complete the following steps:
  1. To provide the administrator with access to the server, issue the UNLOCK ADMIN command. For instructions, see UNLOCK ADMIN (Unlock an administrator).
  2. Set a new password by using the UPDATE ADMIN command:

```
update admin admin_name new_password forcepwreset=yes
```

where *admin\_name* specifies the name of the administrator and *new\_password* specifies the password that you assign.

- If a client node is locked, complete the following steps:
  1. Determine why the client node is locked and whether it must be unlocked. For example, if the client node is decommissioned, the client node is being removed from the production environment. You cannot reverse the decommission operation, and the client node remains locked. A client node also might be locked if the client data is the subject of a legal investigation.
  2. If you must unlock a client node, use the UNLOCK NODE command. For instructions, see UNLOCK NODE (Unlock a client node).
  3. Generate a new password by issuing the UPDATE NODE command:

```
update node node_name new_password forcepwreset=yes
```

where *node\_name* specifies the name of the node and *new\_password* specifies the password that you assign.

4. Inform the client node owner about the changed password. When the owner of the client node logs in with the specified password, a new password is generated automatically. That password is unknown to users to enhance security.

Tip: The password is generated automatically if you previously set the passwordaccess option to `generate` in the client options file.

## Decommissioning a client node

---

If a client node is no longer required, you can start a process to remove it from the production environment. For example, if a workstation was backing up data to the IBM Spectrum Protect™ server, but the workstation is no longer used, you can decommission the workstation.

### About this task

---

When you start the decommission process, the server locks the client node to prevent it from accessing the server. Files that belong to the client node are gradually deleted, and then the client node is deleted. You can decommission the following types of client nodes:

#### Application client nodes

Application client nodes include email servers, databases, and other applications. For example, any of the following applications can be an application client node:

- IBM Spectrum Protect Snapshot
- IBM Spectrum Protect for Databases

- IBM Spectrum Protect for Enterprise Resource Planning
- IBM Spectrum Protect for Mail
- IBM Spectrum Protect for Virtual Environments

#### System client nodes

System client nodes include workstations, network-attached storage (NAS) file servers, and API clients.

#### Virtual machine client nodes

Virtual machine client nodes consist of an individual guest host within a hypervisor. Each virtual machine is represented as a file space.

The simplest method for decommissioning a client node is to use the Operations Center. The decommission process runs in the background. If the client is configured to replicate client data, the Operations Center automatically removes the client from replication on the source and target replication servers before it decommissions the client.

Tip: Alternatively, you can decommission a client node by issuing the `DECOMMISSION NODE` or `DECOMMISSION VM` command. You might want to use this method in the following cases:

- To schedule the decommission process for the future or to run a series of commands by using a script, specify the decommission process to run in the background.
- To monitor the decommission process for debugging purposes, specify the decommission process to run in the foreground. If you run the process in the foreground, you must wait for the process to be completed before you continue with other tasks.

## Procedure

---

Take one of the following actions:

- To decommission a client in the background by using the Operations Center, complete the following steps:
  1. On the Operations Center Overview page, click Clients and select the client.
  2. Click More > Decommission.
- To decommission a client node by using an administrative command, complete the following steps:
  1. Determine whether the client node is configured for node replication by issuing the `QUERY NODE` command. For example, if the client node is named AUSTIN, run the following command:

```
query node austin format=detailed
```

Review the Replication State output field.

2. If the client node is configured for replication, remove the client node from replication by issuing the `REMOVE REPLNODE` command. For example, if the client node is named AUSTIN, issue the following command:

```
remove replnode austin
```

3. Take one of the following actions:

- To decommission an application or system client node in the background, issue the `DECOMMISSION NODE` command. For example, if the client node is named AUSTIN, issue the following command:

```
decommission node austin
```

- To decommission an application or system client node in the foreground, issue the `DECOMMISSION NODE` command and specify the `wait=yes` parameter. For example, if the client node is named AUSTIN, issue the following command:

```
decommission node austin wait=yes
```

- To decommission a virtual machine in the background, issue the `DECOMMISSION VM` command. For example, if the virtual machine is named AUSTIN, the file space is 7, and the file space name is specified by the file space ID, issue the following command:

```
decommission vm austin 7 nametype=fsid
```

If the virtual machine name includes one or more spaces, enclose the name in double quotation marks. For example:

```
decommission vm "austin 2" 7 nametype=fsid
```

- To decommission a virtual machine in the foreground, issue the `DECOMMISSION VM` command and specify the `wait=yes` parameter. For example, issue the following command:

```
decommission vm austin 7 nametype=fsid wait=yes
```

If the virtual machine name includes one or more spaces, enclose the name in double quotation marks. For example:

```
decommission vm "austin 2" 7 nametype=fsid wait=yes
```

## What to do next

---

Watch for error messages, which might be displayed in the user interface or in the command output, immediately after you run the process.

You can verify that the client node is decommissioned:

1. On the Operations Center Overview page, click Clients.
2. In the Clients table, in the At risk column, review the state:
  - o A DECOMMISSIONED state specifies that the node is decommissioned.
  - o A null value specifies that the node is not decommissioned.
  - o A PENDING state specifies that the node is being decommissioned, or the decommission process failed.

Tip: If you want to determine the status of a pending decommission process, issue the following command:

```
query process
```

3. Review the command output:
  - o If status is provided for the decommission process, the process is in progress. For example:

```
query process
```

Process Number	Process Description	Process Status
3	DECOMMISSION NODE	Number of backup objects deactivated for node NODE1: 8 objects deactivated.

- o If no status is provided for the decommission process, and you did not receive an error message, the process is incomplete. A process can be incomplete if files that are associated with the node are not yet deactivated. After the files are deactivated, run the decommission process again.
- o If no status is provided for the decommission process, and you receive an error message, the process failed. Run the decommission process again.

### Related reference:

- [DECOMMISSION NODE \(Decommission a client node\)](#)
- [DECOMMISSION VM \(Decommission a virtual machine\)](#)
- [QUERY NODE \(Query nodes\)](#)
- [REMOVE REPLNODE \(Remove a client node from replication\)](#)

## Deactivating data to free storage space

---

In some cases, you can deactivate data that is stored on the IBM Spectrum Protect™ server. When you run the deactivation process, any backup data that was stored before the specified date and time is deactivated and will be deleted as it expires. In this way, you can free space on the server.

### About this task

---

Some application clients always save data to the server as active backup data. Because active backup data is not managed by inventory expiration policies, the data is not deleted automatically, and uses server storage space indefinitely. To free the storage space that is used by obsolete data, you can deactivate the data.

When you run the deactivation process, all active backup data that was stored before the specified date becomes inactive. The data is deleted as it expires and cannot be restored. The deactivation feature applies only to application clients that protect Oracle databases.

### Procedure

---

1. From the Operations Center Overview page, click Clients.
2. In the Clients table, select one or more clients and click More > Clean Up.  
Command-line method: Deactivate data by using the DEACTIVATE DATA command.

**Related reference:**

[DEACTIVATE DATA \(Deactivate data for a client node\)](#)

## Managing client upgrades

When a fix pack or interim fix becomes available for a client, you can upgrade the client to take advantage of product improvements. Servers and clients can be upgraded at different times and can be at different levels with some restrictions.

### Before you begin

1. Review the client/server compatibility requirements in technote 1053218. If your solution includes servers or clients at a level that is earlier than V7.1, review the guidelines to ensure that client backup and archive operations are not disrupted.
2. Verify system requirements for the client in IBM Spectrum Protect™ Supported Operating Systems.
3. If the solution includes storage agents or library clients, review the information about storage-agent and library-client compatibility with servers that are configured as library managers. See technote 1302789.

If you plan to upgrade a library manager and a library client, you must upgrade the library manager first.

### Procedure

To upgrade the software, complete the instructions that are listed in the following table.

Software	Link to instructions
IBM Spectrum Protect backup-archive client	<ul style="list-style-type: none"> <li>• Upgrading the backup-archive client</li> </ul>
IBM Spectrum Protect Snapshot	<ul style="list-style-type: none"> <li>• Installing and upgrading IBM Spectrum Protect Snapshot for UNIX and Linux</li> <li>• Installing and upgrading IBM Spectrum Protect Snapshot for VMware</li> <li>• Installing and upgrading IBM Spectrum Protect Snapshot for Windows</li> </ul>
IBM Spectrum Protect for Databases	<ul style="list-style-type: none"> <li>• Upgrading Data Protection for SQL Server</li> <li>• Data Protection for Oracle installation</li> <li>• Installing, upgrading, and migrating IBM Spectrum Protect for Mail: Data Protection for Microsoft Exchange Server</li> </ul>
IBM Spectrum Protect for Enterprise Resource Planning	<ul style="list-style-type: none"> <li>• Upgrading IBM Spectrum Protect for Enterprise Resource Planning: Data Protection for SAP for DB2®</li> <li>• Upgrading IBM Spectrum Protect for Enterprise Resource Planning: Data Protection for SAP for Oracle</li> </ul>
IBM Spectrum Protect for Mail	<ul style="list-style-type: none"> <li>• Installation of Data Protection for IBM Domino on a UNIX, AIX, or Linux system (V7.1.0)</li> <li>• Installation of Data Protection for IBM Domino on a Windows system (V7.1.0)</li> <li>• Installing, upgrading, and migrating IBM Spectrum Protect for Mail: Data Protection for Microsoft Exchange Server</li> </ul>
IBM Spectrum Protect for Virtual Environments	<ul style="list-style-type: none"> <li>• Installing and upgrading Data Protection for VMware</li> <li>• Installing Data Protection for Microsoft Hyper-V</li> </ul>

## Managing the Operations Center

The Operations Center provides web and mobile access to status information about the IBM Spectrum Protect™ environment. You can use the Operations Center to monitor multiple servers and to complete some administrative tasks. The Operations Center also



provides web access to the IBM Spectrum Protect command line.

- Adding and removing spoke servers  
In a multiple-server environment, you can connect the other servers, called *spoke servers*, to the hub server.
- Starting and stopping the web server  
The web server of the Operations Center runs as a service and starts automatically. You might have to stop and start the web server, for example, to make configuration changes.
- Restarting the initial configuration wizard  
You might need to restart the initial configuration wizard of the Operations Center, for example, to make configuration changes.
- Changing the hub server  
You can use the Operations Center to remove the hub server of IBM Spectrum Protect, and configure another hub server.
- Restoring the configuration to the preconfiguration state  
If certain problems occur, you might want to restore the Operations Center configuration to the preconfigured state where the IBM Spectrum Protect servers are not defined as hub or spoke servers.

## Adding and removing spoke servers

---

In a multiple-server environment, you can connect the other servers, called *spoke servers*, to the hub server.

### About this task

---

The spoke servers send alerts and status information to the hub server. The Operations Center shows you a consolidated view of alerts and status information for the hub server and any spoke servers.

- Adding a spoke server  
After you configure the hub server for the Operations Center, you can add one or more spoke servers to the hub server.
- Removing a spoke server  
You can remove a spoke server from the Operations Center.

## Adding a spoke server

---

After you configure the hub server for the Operations Center, you can add one or more spoke servers to the hub server.

### Before you begin

---

Communication between the spoke server and the hub server must be secured by using the Transport Layer Security (TLS) protocol. To secure communication, add the certificate of the spoke server to the truststore file of the hub server.

### Procedure

---

1. In the Operations Center menu bar, click Servers. The Servers page opens.

In the table on the Servers page, a server might have a status of "Unmonitored." This status means that although an administrator defined this server to the hub server by using the DEFINE SERVER command, the server is not yet configured as a spoke server.

2. Complete one of the following steps:
  - Click the server to highlight it, and in the table menu bar, click Monitor Spoke.
  - If the server that you want to add is not shown in the table, and secure SSL/TLS communication is not required, click + Spoke in the table menu bar.
3. Provide the necessary information, and complete the steps in the spoke configuration wizard.  
Tip: If the event-record retention period of the server is less than 14 days, the period is automatically reset to 14 days if you configure the server as a spoke server.

## Removing a spoke server

---

You can remove a spoke server from the Operations Center.

### About this task

---

You might need to remove a spoke server in the following situations, for example:

- You want to move the spoke server from one hub server to another hub server.
- You want to decommission the spoke server.

## Procedure

---

To remove the spoke server from the group of servers that are managed by the hub server, complete the following steps:

1. From the IBM Spectrum Protect™ command line, issue the following command on the hub server:

```
QUERY MONITORSETTINGS
```

2. From the output of the command, copy the name that is in the Monitored Group field.
3. Issue the following command on the hub server, where *group\_name* represents the name of the monitored group, and *member\_name* represents the name of the spoke server:

```
DELETE GRPMEMBER group_name member_name
```

4. Optional: If you want to move the spoke server from one hub server to another hub server, do **not** complete this step. Otherwise, you can disable alerting and monitoring on the spoke server by issuing the following commands on the spoke server:

```
SET STATUSMONITOR OFF  
SET ALERTMONITOR OFF
```

5. Optional: If the spoke server definition is used for other purposes, such as enterprise configuration, command routing, storing virtual volumes, or library management, do **not** complete this step. Otherwise, you can delete the spoke server definition on the hub server by issuing the following command on the hub server:

```
DELETE SERVER spoke_server_name
```

## Starting and stopping the web server

---

The web server of the Operations Center runs as a service and starts automatically. You might have to stop and start the web server, for example, to make configuration changes.

## Procedure

---

1. Stop the web server.

- o **AIX** From the */installation\_dir/ui/utls* directory, where *installation\_dir* represents the directory where the Operations Center is installed, issue the following command:

```
./stopserver.sh
```

- o **Linux** Issue the following command:

```
service opscenter.rc stop
```

- o **Windows** From the Services window, stop the IBM Spectrum Protect™ Operations Center service.

2. Start the web server.

- o **AIX** From the */installation\_dir/ui/utls* directory, where *installation\_dir* represents the directory where the Operations Center is installed, issue the following command:

```
./startserver.sh
```

- o **Linux** Issue the following commands:

Start the server:

```
service opscenter.rc start
```

Restart the server:

```
service opscenter.rc restart
```

Determine whether the server is running:

```
service opscenter.rc status
```

- o **Windows** From the Services window, start the IBM Spectrum Protect Operations Center service.

## Restarting the initial configuration wizard

---

You might need to restart the initial configuration wizard of the Operations Center, for example, to make configuration changes.

### Before you begin

---

To change the following settings, use the Settings page in the Operations Center rather than restarting the initial configuration wizard:

- The frequency at which status data is refreshed
- The duration that alerts remain active, inactive, or closed
- The conditions that indicate that clients are at risk

The Operations Center help includes more information about how to change these settings.

### About this task

---

To restart the initial configuration wizard, you must delete a properties file that includes information about the hub server connection. However, any alerting, monitoring, at-risk, or multiserver settings that were configured for the hub server are not deleted. These settings are used as the default settings in the configuration wizard when the wizard restarts.

### Procedure

---

1. Stop the Operations Center web server.
  2. On the computer where the Operations Center is installed, go to the following directory, where *installation\_dir* represents the directory in which the Operations Center is installed:
    - o **AIX** | **Linux** *installation\_dir*/ui/Liberty/usr/servers/guiServer
    - o **Windows** *installation\_dir*\ui\Liberty\usr\servers\guiServer
- For example:
- o **AIX** | **Linux** /opt/tivoli/tsm/ui/Liberty/usr/servers/guiServer
  - o **Windows** c:\Program Files\Tivoli\TSM\ui\Liberty\usr\servers\guiServer
3. In the guiServer directory, delete the serverConnection.properties file.
  4. Start the Operations Center web server.
  5. Open the Operations Center.
  6. Use the configuration wizard to reconfigure the Operations Center. Specify a new password for the monitoring administrator ID.
  7. On any spoke servers that were previously connected to the hub server, update the password for the monitoring administrator ID by issuing the following command from the IBM Spectrum Protect™ command-line interface:

```
UPDATE ADMIN IBM-OC-hub_server_name new_password
```

Restriction: Do not change any other settings for this administrator ID. After you specify the initial password, this password is managed automatically by the Operations Center.

## Changing the hub server

---

You can use the Operations Center to remove the hub server of IBM Spectrum Protect™, and configure another hub server.

### Procedure

---

1. Restart the initial configuration wizard of the Operations Center. As part of this procedure, you delete the existing hub server connection.
2. Use the wizard to configure the Operations Center to connect to the new hub server.

#### Related tasks:

Restarting the initial configuration wizard

# Restoring the configuration to the preconfiguration state

---

If certain problems occur, you might want to restore the Operations Center configuration to the preconfigured state where the IBM Spectrum Protect™ servers are not defined as hub or spoke servers.

## Procedure

---

To restore the configuration, complete the following steps:

1. Stop the Operations Center web server.
2. Unconfigure the hub server by completing the following steps:

- a. On the hub server, issue the following commands:

```
SET MONITORINGADMIN ""
SET MONITOREDSEVERGROUP ""
SET STATUSMONITOR OFF
SET ALERTMONITOR OFF
REMOVE ADMIN IBM-OC-hub_server_name
```

Tip: *IBM-OC-hub\_server\_name* represents the monitoring administrator ID that was automatically created when you initially configured the hub server.

- b. Reset the password for the hub server by issuing the following command on the hub server:

```
SET SERVERPASSWORD ""
```

Attention: Do not complete this step if the hub server is configured with other servers for other purposes, such as library sharing, exporting and importing of data, or node replication.

3. Unconfigure any spoke servers by completing the following steps:

- a. On the hub server, to determine whether any spoke servers remain as members of the server group, issue the following command:

```
QUERY SERVERGROUP IBM-OC-hub_server_name
```

Tip: *IBM-OC-hub\_server\_name* represents the name of the monitored server group that was automatically created when you configured the first spoke server. This server group name is also the same as the monitoring administrator ID that was automatically created when you initially configured the hub server.

- b. On the hub server, to delete spoke servers from the server group, issue the following command for each spoke server:

```
DELETE GRPMEMBER IBM-OC-hub_server_name spoke_server_name
```

- c. After all spoke servers are deleted from the server group, issue the following commands on the hub server:

```
DELETE SERVERGROUP IBM-OC-hub_server_name
SET MONITOREDSEVERGROUP ""
```

- d. On each spoke server, issue the following commands:

```
REMOVE ADMIN IBM-OC-hub_server_name
SETOPT PUSHSTATUS NO
SET ALERTMONITOR OFF
SET STATUSMONITOR OFF
```

- e. On each spoke server, delete the definition of the hub server by issuing the following command:

```
DELETE SERVER hub_server_name
```

Attention: Do not complete this step if the definition is used for other purposes, such as library sharing, exporting and importing of data, or node replication.

- f. On the hub server, delete the definition of each spoke server by issuing the following command:

```
DELETE SERVER spoke_server_name
```

Attention: Do not complete this step if the server definition is used for other purposes, such as library sharing, exporting and importing of data, or node replication.

4. Restore the default settings on each server by issuing the following commands:

```
SET STATUSREFRESHINTERVAL 5
SET ALERTUPDATEINTERVAL 10
SET ALERTACTIVEDURATION 480
SET ALERTINACTIVEDURATION 480
SET ALERTCLOSEDDURATION 60
SET STATUSATRISKINTERVAL TYPE=AP INTERVAL=24
SET STATUSATRISKINTERVAL TYPE=VM INTERVAL=24
SET STATUSATRISKINTERVAL TYPE=SY INTERVAL=24
SET STATUSSKIPASFAILURE YES TYPE=ALL
```

5. Restart the initial configuration wizard of the Operations Center.



**Related tasks:**

Restarting the initial configuration wizard  
Starting and stopping the web server

## Configuring virtual tape libraries

---

A virtual tape library (VTL) does not use physical tape media. When you implement VTL storage, you can exceed the capacity of a physical tape library. The ability to define many volumes and drives can provide greater flexibility for the storage environment.

- Considerations for using virtual tape libraries  
There are some considerations for defining a library as a virtual tape library (VTL), including enhancements for performance and setup of your hardware.
- Adding a virtual tape library to your environment  
Define a virtual tape library (VTL) to take advantage of mount performance and scalability advantages.
- Defining all drives and paths for a single library  
Use the PERFORM LIBACTION command to set up a single SCSI or virtual tape library (VTL) in one step.
-  Example: Configure a SCSI or virtual tape library with a single drive device type  
Configure a VTL or SCSI library that contains two LTO tape drives.
-  Example: Configure a SCSI or virtual tape library with multiple drive device types  
You can configure a library with multiple drive device types, for example, a StorageTek L40 library that contains one DLT drive and one LTO Ultrium drive.

## Considerations for using virtual tape libraries

---

There are some considerations for defining a library as a virtual tape library (VTL), including enhancements for performance and setup of your hardware.

### About this task

---

Defining a VTL to the IBM Spectrum Protect™ server can help improve performance because the server handles mount point processing for VTLs differently than real tape libraries. The physical limitations for real tape hardware are not applicable to a VTL, affording options for better scalability.

You can use a VTL for any virtual tape library when the following conditions are true:

- There is no mixed media involved in the VTL. Only one type and generation of drive and media is emulated in the library.
- Every server and storage agent with access to the VTL has paths that are defined for all drives in the library.

If either of these conditions are not met, any mount performance advantage from defining a VTL library to the IBM Spectrum Protect server can be reduced or negated.

VTLs are compatible with earlier versions of both library clients and storage agents. The library client or storage agent is not affected by the type of library that is used for storage. If mixed media and path conditions are true for a SCSI library, it can be defined or updated as LIBTYPE=VTL.

- Storage capacity for virtual tape libraries  
Because virtual tape libraries (VTLs) do not have the physical limitations that real tape hardware does, their capacity for storage is more flexible.
- Drive configuration for virtual tape libraries  
Drive configuration in a virtual tape library (VTL) is variable, depending on the needs of your environment.

## Storage capacity for virtual tape libraries

---

Because virtual tape libraries (VTLs) do not have the physical limitations that real tape hardware does, their capacity for storage is more flexible.

The concept of storage capacity in a virtual tape library is different from capacity in physical tape hardware. In a physical tape library, each volume has a defined capacity, and the library's capacity is defined in terms of the total number of volumes in the library. The capacity of a VTL, alternatively, is defined in terms of total available disk space. You can increase or decrease the number and size of volumes on disk.

This variability affects what it means to run out of space in a VTL. For example, a volume in a VTL can run out of space before reaching its assigned capacity if the total underlying disk runs out of space. In this situation, the server can receive an end-of-volume message without any warning, resulting in backup failures.

When out-of-space errors and backup failures occur, disk space is usually still available in the VTL. It is hidden in volumes that are not in use. For example, volumes that are logically deleted or returned to scratch status in the IBM Spectrum Protect™ server are deleted only in the server database. The VTL is not notified, and the VTL maintains the full size of the volume as allocated in its capacity considerations.

To help prevent out-of-space errors, ensure that any SCSI library that you update to LIBTYPE=VTL is updated with the RELABELSCRATCH parameter set to YES. The RELABELSCRATCH option enables the server to overwrite the label for any volume that is deleted and to return the volume to scratch status in the library. The RELABELSCRATCH parameter defaults to YES for any library defined as a VTL.

### **Related reference:**

UPDATE LIBRARY (Update a library)

## Drive configuration for virtual tape libraries

---

Drive configuration in a virtual tape library (VTL) is variable, depending on the needs of your environment.

Most VTL environments use as many drives as possible to maximize the number of concurrent tape operations. A single tape mount in a VTL environment is typically faster than a physical tape mount. However, using many drives increases the amount of time that the IBM Spectrum Protect™ server requires when a mount is requested. The selection process takes longer as the number of drives that are defined in a single library object in the server increases. Virtual tape mounts can take as long or longer than physical tape mounts depending on the number of drives in the VTL.

For best results when you create drives, check with your VTL vendor about device-specific recommendations. If more than 300-500 drives for each VTL are required, you can logically partition the VTL into multiple libraries and assign drives to each library. Operating system and SAN hardware configurations could impose limitations on the number of devices that can be utilized within the VTL library.

## Adding a virtual tape library to your environment

---

Define a virtual tape library (VTL) to take advantage of mount performance and scalability advantages.

### About this task

---

VTLs are identified by using the DEFINE LIBRARY command and specifying the LIBTYPE=VTL parameter. Because a VTL library functionally interacts with the server in the same way that a SCSI library does, you can use the UPDATE LIBRARY command to change the library type of a SCSI library that is already defined. You do not have to redefine the library.

### Procedure

---

- Add a new VTL library. Define the library as a VTL to the server, as shown in the following example:

```
define library chester libtype=vtl
```

This sets up the new VTL library and enables the RELABELSCRATCH option to relabel volumes that have been deleted and returned to scratch status.

- Update a SCSI library to a VTL. If you have a SCSI library and you want to change it to a VTL, use the UPDATE LIBRARY command to change the library type:

```
update library calzone libtype=vtl
```

You can issue this command only if the library that is being updated is defined with the LIBTYPE=SCSI parameter.

**Related reference:**

DEFINE LIBRARY (Define a library)

UPDATE LIBRARY (Update a library)

## Defining all drives and paths for a single library

Use the PERFORM LIBACTION command to set up a single SCSI or virtual tape library (VTL) in one step.

### About this task

If you are setting up or modifying your hardware environment and must create or change large numbers of drive definitions, the PERFORM LIBACTION command can make this task much simpler. You can define a new library and then define all drives and paths to the drives. Or, if you have an existing library that you want to delete, you can delete all existing drives and their paths in one step.

The PREVIEW parameter allows you to view the output of commands before they are processed to verify the action that you want to perform. If you are defining a library, a path to the library must already be defined if you want to specify the PREVIEW parameter. You cannot use the PREVIEW and DEVICE parameters together.

The PERFORM LIBACTION command can be used only for SCSI and VTL libraries. If you are defining drives and paths for a library, the SANDISCOVERY option must be supported and enabled. The tape library must be able to return the drive serial number address association.

### Procedure

To set up a VTL library named ODIN, complete these steps:

1. Define the library.

```
define library odin libtype=vtl
```

2. Define two drives and their paths for your new library, ODIN.

**AIX**

```
perform libaction odin action=define device=/dev/lb3 prefix=dr
```

The server then issues the following commands:

```
define path tsmserver odin srct=server destt=library device=/dev/
lb3 define drive odin dr0
define path tsmserver dr0 srct=server destt=drive library=odin
device=/dev/mt1 define drive odin dr1
define path tsmserver dr1 srct=server destt=drive library=odin
device=/dev/mt2
```

**Linux**

```
perform libaction odin action=define device=/dev/tsm SCSI/lb3 prefix=dr
```

The server then issues the following commands:

```
define path tsmserver odin srct=server destt=library device=/dev/tsm SCSI/lb3
define drive odin dr0
define path tsmserver dr0 srct=server destt=drive library=odin
device=/dev/tsm SCSI/mt1 define drive odin dr1
define path tsmserver dr1 srct=server destt=drive library=odin
device=/dev/tsm SCSI/mt2
```

**Windows**

```
perform libaction odin action=define device=lb0.0.0.2 prefix=dr
```

The server then issues the following commands:

```
define path tsmserver odin srct=server destt=library device=lb0.0.0.2
define drive odin dr0
define path tsmserver dr0 srct=server destt=drive library=odin
device=mt0.1.0.2 define drive odin dr1
define path tsmserver dr1 srct=server destt=drive library=odin
device=mt0.2.0.2
```

**Related reference:**

DEFINE LIBRARY (Define a library)

DEFINE PATH (Define a path when the destination is a drive)

PERFORM LIBACTION (Define or delete all drives and paths for a library)

## Example: Configure a SCSI or virtual tape library with a single drive device type

---

Configure a VTL or SCSI library that contains two LTO tape drives.

### About this task

---

This procedure is an example of configuring an automated SCSI library that contains two drives to the server system. The library is not shared with other IBM Spectrum Protect™ servers or with storage agents and is typically attached to the server system by using SCSI cables.

In this configuration, both drives in the library are the same device type. Define one device class. The procedure is the same for both SCSI libraries and VTLs, except for the step to define the library. For SCSI libraries, define the library with libtype=scsi. For VTL libraries, define the library with libtype=vtl.

### Procedure

---

1. Define a SCSI library that is named AUTODTLIB.

```
define library autoltolib libtype=scsi
```

If the library has a bar code reader and you would like to automatically label tapes before they are checked in, you can set the AUTOLABEL parameter to YES. For example:

```
define library autoltolib libtype=scsi autolabel=yes
```

2. Define a path from the server to the library.

**AIX**

```
define path server1 autoltolib srctype=server desttype=library
device=/dev/lb3
```

**Linux**

```
define path server1 autoltolib srctype=server desttype=library
device=/dev/tsm SCSI/lb3
```

**Windows**

```
define path server1 autoltolib srctype=server desttype=library
device=lb0.0.0.3
```

3. Define the drives in the library. Both drives belong to the AUTODTLIB library.

```
define drive autoltolib drive01
define drive autoltolib drive02
```

Tip: You can use the PERFORM LIBACTION command to define drives and paths for a library in one step.

4. Define a path from the server to each drive.

**AIX**

```
define path server1 drive01 srctype=server desttype=drive
library=autoltolib device=/dev/mt4
define path server1 drive02 srctype=server desttype=drive
library=autoltolib device=/dev/mt5
```



#### Linux

```
define path server1 drive01 srctype=server desttype=drive
library=autoltolib device=/dev/tsm SCSI/mt4
define path server1 drive02 srctype=server desttype=drive
library=autoltolib device=/dev/tsm SCSI/mt5
```

#### Windows

```
define path server1 drive01 srctype=server desttype=drive
library=autoltolib device=mt0.0.0.4
define path server1 drive02 srctype=server desttype=drive
library=autoltolib device=mt0.0.0.5
```

If you did not include the element address when you defined the drive, the server now queries the library to obtain the default element address for the drive.

5. Define a device class that is named AUTODLT\_CLASS for the two drives in the AUTODTLIB library.

```
define devclass autolto_class library=autodltlib devtype=lto
```

6. Define a storage pool that is named AUTOLTO\_POOL associated with the device class named AUTOLTO\_CLASS.

```
define stgpool autolto_pool autolto_class maxscratch=20
```

7. Label and check in library volumes.

```
label libvolume autoltolib search=yes labelsource=barcode checkin=scratch
```

8. Verify your definitions by issuing the following commands:

```
query library
query drive
query path
query devclass
query stgpool
query libvolume
```

#### Related reference:

DEFINE DEVCLASS (Define a device class)

DEFINE LIBRARY (Define a library)

DEFINE PATH (Define a path when the destination is a drive)

## Example: Configure a SCSI or virtual tape library with multiple drive device types

---

You can configure a library with multiple drive device types, for example, a StorageTek L40 library that contains one DLT drive and one LTO Ultrium drive.

### About this task

---

This procedure is an example of configuring an automated SCSI library that contains two drives to the server system. The library is not shared with other IBM Spectrum Protect™ servers or with storage agents and is typically attached to the server system by SCSI cables.

In this configuration, the drives are different device types. Define a device class for each drive device type. Drives with different device types are supported in a single library if you define a device class for each type of drive. If you are configuring this way, you must include the specific format for the drive's device type by using the FORMAT parameter with a value other than DRIVE.

The procedure is the same for both SCSI libraries and VTLs, except for the step to define the library. For SCSI libraries, define the library with libtype=scsi. For VTL libraries, define the library with libtype=vtl.

### Procedure

---

1. Define a SCSI library named MIXEDLIB.

```
define library mixedlib libtype=scsi
```

2. Define a path from the server to the library.

**AIX**

```
define path server1 mixedlib srctype=server desttype=library
device=/dev/lb3
```

**Linux**

```
define path server1 mixedlib srctype=server desttype=library
device=/dev/tmscsi/lb3
```

**Windows**

```
define path server1 mixedlib srctype=server desttype=library
device=lb0.0.0.3
```

3. Define the drives in the library. Both drives belong to the MIXEDLIB library.

```
define drive mixedlib dlt1
define drive mixedlib lto1
```

4. Define a path from the server to each drive. The DEVICE parameter specifies the device driver's name for the drive, which is the device special file name.

**AIX**

```
define path server1 dlt1 srctype=server desttype=drive
library=mixedlib device=/dev/mt4
define path server1 lto1 srctype=server desttype=drive
library=mixedlib device=/dev/mt5
```

**Linux**

```
define path server1 dlt1 srctype=server desttype=drive
library=mixedlib device=/dev/tmscsi/mt4
define path server1 lto1 srctype=server desttype=drive
library=mixedlib device=/dev/tmscsi/mt5
```

**Windows**

```
define path server1 drive01 srctype=server desttype=drive
library=autoltolib device=mt0.0.0.4
define path server1 drive02 srctype=server desttype=drive
library=autoltolib device=mt0.0.0.5
```

If you did not include the element address when you defined the drive, the server now queries the library to obtain the element address for the drive.

5. Define device classes.

Important: Do not use the DRIVE format, which is the default. Because the drives are different types, the server uses the format specification to select a drive. The results of using the DRIVE format in a mixed media library are unpredictable.

```
define devclass dlt_class library=mixedlib devtype=dlt format=dlt40
define devclass lto_class library=mixedlib devtype=lto format=ultriumc
```

6. Define storage pools that are associated with the device classes.

```
define stgpool lto_pool lto_class maxscratch=20
define stgpool dlt_pool dlt_class maxscratch=20
```

7. Label and check in library volumes.

```
label libvolume mixedlib search=yes labelsource=barcode checkin=scratch
```

8. Verify your definitions by issuing the following commands:

```
query library
query drive
query path
query devclass
query stgpool
query libvolume
```

## Protecting NAS file servers

---

You can configure and manage a backup environment that protects a network-attached storage (NAS) file server.

You can use the IBM Spectrum Protect™ server, the IBM Spectrum Protect backup-archive client, or IBM Spectrum Protect Snapshot to back up and restore a NAS file server as described in the following table.

Product	Description
IBM Spectrum Protect server	<p>To back up and restore NAS file server data by using the IBM Spectrum Protect server, you must have IBM Spectrum Protect Extended Edition installed.</p> <p>You can configure the IBM Spectrum Protect server to use the network data management protocol (NDMP) to back up and restore data as described in the following topics in this section.</p> <p>To protect large NetApp file systems, you can alternatively configure IBM Spectrum Protect to use NetApp SnapMirror to Tape (also known as SMTape). SnapMirror to Tape uses a block-level copy of data for backup, which is faster than a traditional NDMP full backup and can be used when NDMP full backups are impractical.</p> <p>For information about using SnapMirror to Tape to back up and restore data, see Backup and restore operations by using the NetApp SnapMirror to Tape feature.</p>
IBM Spectrum Protect backup-archive client	<p>You can configure the backup-archive client to back up and restore file server data by using the Network File System (NFS) or Common Internet File System (CIFS) protocol.</p> <p>For information about using the backup-archive client to back up and restore data, see Back up and restore data with backup-archive clients.</p>
IBM Spectrum Protect Snapshot	<p>You can use IBM Spectrum Protect Snapshot to back up and restore file server data by using the advanced snapshot technologies of storage systems.</p> <p>For information about using IBM Spectrum Protect Snapshot to back up and restore data, see IBM Spectrum Protect Snapshot for UNIX and Linux overview or IBM Spectrum Protect Snapshot for VMware overview.</p>

- NDMP requirements
  - To use NDMP for operations with NAS file servers, you must have IBM Spectrum Protect Extended Edition installed and your file server environment must meet certain requirements.
- NDMP operations management
  - There are several administrator activities for NDMP operations.
- Configuring IBM Spectrum Protect for NDMP operations
  - You can configure IBM Spectrum Protect to back up and recover data on NAS file servers by using NDMP. The configuration procedure differs depending on whether you plan to back up data from a nonclustered or clustered NAS file server.
- Backing up and restoring NAS file servers using NDMP
  - After you configure IBM Spectrum Protect for NDMP operations, you are ready to begin using NDMP.
- File-level backup and restore for NDMP operations
  - When you back up data by using NDMP, you can specify that the IBM Spectrum Protect server collects and stores file-level information in a table of contents (TOC).
- Directory-level backup and restore operations
  - If you have a large NAS file system, initiating a backup at a directory level reduces backup and restore times and provides more flexibility in configuring NAS backups. By defining virtual file spaces, a file system backup can be partitioned among several NDMP backup operations and multiple tape drives. You can also use different backup schedules to back up subtrees of a file system.
- Backup and restore operations by using the NetApp SnapMirror to Tape feature
  - You can back up large NetApp file systems by using the NetApp SnapMirror to Tape feature (also known as SMTape). Using a block-level copy of data for backup, the SnapMirror to Tape method is faster than a traditional NDMP full backup and can be used when NDMP full backups are impractical.
- NDMP backup operations using Celerra file server-integrated checkpoints
  - When the IBM Spectrum Protect server initiates an NDMP backup operation on a Celerra data mover, the backup of a large file system might take several hours to complete. Without Celerra integrated checkpoints, any changes that occur on the file system are written to the backup image.
- Replicating NAS nodes
  - You can replicate a NAS node that uses NDMP for backup operations. Before you configure the replication operation, review the restrictions that apply.

## NDMP requirements

To use NDMP for operations with NAS file servers, you must have IBM Spectrum Protect™ Extended Edition installed and your file server environment must meet certain requirements.

#### NAS file server

The operating system on the file server must be supported by IBM Spectrum Protect. For information about the NAS file servers that are supported, see technote 1054144.

The combination of file server model and operating system must be supported by the NAS file server. For more specifics, see the product information for the NAS file server.

#### Tape libraries

This requirement is necessary only for a backup to a locally attached NAS device. The IBM Spectrum Protect server supports the following types of libraries for operations that use NDMP:

##### SCSI

A SCSI library can be attached directly to the IBM Spectrum Protect server or to the NAS file server. When the library is attached directly to the IBM Spectrum Protect server, that server controls the library operations by passing the SCSI commands directly to the library. When the library is attached directly to the NAS file server, the IBM Spectrum Protect server controls the library by passing SCSI commands to the library through the NAS file server.

##### ACSLs

An automated cartridge system library software (ACSLs) library can be directly connected only to the IBM Spectrum Protect server. The IBM Spectrum Protect server controls the library by passing the library request through TCP/IP to the library control server.

Restriction: The IBM Spectrum Protect server does not include External Library support for the ACSLS library when the library is used for NDMP operations.

##### VTL

A virtual tape library (VTL) can be attached directly either to the IBM Spectrum Protect server or to the NAS file server. A virtual tape library is essentially the same as a SCSI library, but is enhanced for virtual tape library characteristics and allows for better mount performance.

If you are defining a VTL, your environment must not include mixed media. Paths must be defined between all drives in the library and all defined servers, including storage agents, that use the library. If these conditions are not met, the overall performance can degrade to the same levels as the SCSI library type, especially during times of high stress.

##### 349X

A 349X library can be directly connected only to the IBM Spectrum Protect server. The IBM Spectrum Protect server controls the library by passing the library request through TCP/IP to the library manager.

Library sharing: The IBM Spectrum Protect server that runs NDMP operations can be a library manager for either an ACSLS, SCSI, VTL, or 349X library, but cannot be a library client. The IBM Spectrum Protect server can also be a library client in a configuration where the NAS file server sends data to the server by using TCP/IP rather than to a tape library attached to the file server. If the IBM Spectrum Protect server that runs NDMP operations is a library manager, that server must control the library directly and not by passing commands through the NAS file server.

#### Tape drives

A tape drive is necessary only for backup to a locally attached NAS device. The NAS file server must be able to access the drives. A NAS device is not supported in a mixed device library. The drives must be supported for tape backup operations by the NAS file server and its operating system. For complete NDMP device support, refer to the NAS file server product documentation.

Drive sharing: The tape drives can be shared by the IBM Spectrum Protect server and one or more NAS file servers. Also, when a SCSI, VTL, or a 349X library is connected to the server and not to the NAS file server, the drives can be shared by one or more NAS file servers. The drives can also be shared by one or more IBM Spectrum Protect library clients and storage agents.

Drive reservations: When tape drives are attached to NAS devices and the RESETDRIVES=YES parameter for the DEFINE LIBRARY command is specified, the following limitations apply:

- If a tape drive is shared by an IBM Spectrum Protect server and a NAS device, drive reservation preemption is supported when the NAS device supports persistent reserve and it is enabled. For more information about setting persistent reserve, see the documentation for your NAS device.
- If a tape drive is attached only to a NAS device and not shared with an IBM Spectrum Protect server, drive reservation preemption is not supported. If you enable persistent reserve on the NAS device for these drives and a reservation is set by the NAS device but never cleared, you must use another method to clear the reservation.

Verify the compatibility of specific combinations of a NAS file server, tape devices, and SAN-attached devices with the hardware manufacturers.

Tip: IBM Spectrum Protect supports NDMP Version 4 for all NDMP operations. IBM Spectrum Protect continues to support all NDMP backup and restore operations with a NAS device that runs NDMP version 3. The IBM Spectrum Protect server negotiates the highest protocol level (either Version 3 or Version 4) with the NDMP server when it establishes an NDMP connection. If you experience any issues with Version 4, you might want to try Version 3.

- Interfaces for NDMP operations  
You can use several interfaces to run NDMP operations. You can schedule an NDMP operation by using the BACKUP NODE or RESTORE NODE command, and creating a schedule to process the command.
- Data formats for NDMP backup operations  
Data that is backed up using NDMP is not in the same format as the data that is used for typical IBM Spectrum Protect backup operations. The NAS file server controls the format of the backup data.

## Interfaces for NDMP operations

---

You can use several interfaces to run NDMP operations. You can schedule an NDMP operation by using the BACKUP NODE or RESTORE NODE command, and creating a schedule to process the command.

Client interfaces:

- Backup-archive command-line client (on a Windows, 64-bit AIX®, or 64-bit Oracle Solaris system)
- Web client

Server interfaces:

- Server console
  - Command line on the administrative client
- Tip: All examples for NDMP operations use server commands.

The IBM Spectrum Protect™ web client interface, available with the backup-archive client, displays the file systems of the NAS file server in a graphical view. The client function is not required, but you can use the client interfaces for NDMP operations. The client function is the preferred method for file-level restore operations. For more information about file-level restore operations, see File-level backup and restore for NDMP operations.

IBM Spectrum Protect prompts you for an administrator ID and password when you complete NDMP functions by using either of the client interfaces. For more information about installing and activating client interfaces, see Installing the IBM Spectrum Protect backup-archive clients.

To use the IBM Spectrum Protect backup-archive client or web client for NAS operations, the file system names on the NAS device must have a forward slash (/) as the first character. This restriction does not affect NAS operations that are initiated from the IBM Spectrum Protect server command line.

## Data formats for NDMP backup operations

---

Data that is backed up using NDMP is not in the same format as the data that is used for typical IBM Spectrum Protect™ backup operations. The NAS file server controls the format of the backup data.

Data that is backed up to a library that is directly attached to the file server must be directed to a storage pool with the proper data format. When you define a storage pool for NDMP operations, you specify one of the following data formats:

- NETAPPDUMP if the NAS file server is a NetApp or an IBM® System Storage® N Series device.
- CELERRADUMP if the NAS file server is an EMC Celerra device.
- NDMPDUMP for all other devices.

Data that is backed up over the network to the local IBM Spectrum Protect hierarchy can be directed to any random-access or sequential-access primary storage pool. However, the format of the data does not change.

## NDMP operations management

---

There are several administrator activities for NDMP operations.

- Managing NAS file server nodes  
You can query, update, rename, and remove NAS file server nodes.

- Managing data movers that are used in NDMP operations  
You can query, update, and delete the data movers that you define for NAS file servers.
- Dedicating an IBM Spectrum Protect drive to NDMP operations  
If you are already using a drive for IBM Spectrum Protect™ operations, you can dedicate that drive to NDMP operations.
- Storage pool management for NDMP operations  
When NETAPPDUMP, CELERRADUMP, or NDMPDUMP is designated as the storage-pool type, managing the storage pools that are produced by NDMP operations is different from managing storage pools that contain media for traditional IBM Spectrum Protect backups.
- Managing tables of contents  
You can use several commands to manage different aspects of your data contents.
- Preventing long-running, inactive NDMP connections from closing  
To prevent firewalls from closing NDMP connections that are long-running but inactive, you can enable Transmission Control Protocol (TCP) keepalive on the NDMP control connections.

## Managing NAS file server nodes

---

You can query, update, rename, and remove NAS file server nodes.

### Procedure

---

Use one of the following commands to manage NAS file server nodes:

Command	Procedure
<b>QUERY NODE</b>	To query a node, issue the QUERY NODE command with the appropriate parameters. For example, if you want to query the NAS node NASNODE1, issue the following command:  <code>query node nasnode1 type=nas</code>
<b>UPDATE NODE</b>	To update a node, issue the UPDATE NODE command with the appropriate parameters. For example, if you created a new policy domain that is named NASDOMAIN for NAS nodes and you want to update the node NASNODE1 to include the node in the new domain, issue the following command:  <code>update node nasnode1 domain=nasdomain</code>

Command	Procedure
<b>RENAME NODE</b>	<p>To rename a NAS node, you must also rename the corresponding NAS data mover; both must have the same name.</p> <p>For example, to rename NASNODE1 to NAS1, complete the following steps:</p> <ol style="list-style-type: none"> <li>1. Delete all paths between the data mover NASNODE1 and libraries and between the data mover NASNODE1 and drives.</li> <li>2. Delete the data mover that is defined for the NAS node.</li> <li>3. To rename NASNODE1 to NAS1, issue the following command: <pre>rename node nasnode1 nas1</pre> </li> <li>4. Define the data mover by using the new node name. In this example, you must define a new data mover that is named NAS1 with the same parameters that were used to define NASNODE1. Important: When you define a new data mover for a node that you renamed, ensure that the data mover name matches the new node name. Also, ensure that the new data mover parameters are duplicates of the original data mover parameters. Any mismatch between a node name and a data mover name or between new data mover parameters and original data mover parameters can prevent you from establishing a session with the NAS file server.</li> <li>5. For SCSI or 349X libraries, define a path between the NAS data mover and a library only if the tape library is physically connected directly to the NAS file server.</li> <li>6. Define paths between the NAS data mover and any drives that are used for NDMP operations.</li> </ol>
<b>REMOVE NODE</b>	<p>To remove a node, complete the following steps:</p> <ol style="list-style-type: none"> <li>1. Delete any virtual file space definitions for the node.</li> <li>2. Delete all paths between the data mover and libraries and between the data mover and drives.</li> <li>3. Delete the node. For example, if you want to remove a node that is named NAS1, issue the following command: <pre>remove node nas1</pre> </li> </ol>

**Related reference:**

- QUERY NODE (Query nodes)
- UPDATE NODE (Update node attributes)
- RENAME NODE (Rename a node)
- REMOVE NODE (Delete a node or an associated machine node)

## Managing data movers that are used in NDMP operations

You can query, update, and delete the data movers that you define for NAS file servers.

### Procedure

Use one of the following commands to manage data movers:

Command	Procedure

Command	Procedure
<b>QUERY DATAMOVER</b>	To query a data mover, issue the QUERY DATAMOVER command with the appropriate parameters. For example, if you want to query the data mover NASNODE1, issue the following command:  <code>query datamover nasnode1</code>
<b>UPDATE DATAMOVER</b>	To update a data mover, issue the UPDATE DATAMOVER command with the appropriate parameters. For example, if you shut down a NAS file server for maintenance and you want to take the data mover offline, issue the following command:  <code>update datamover nasnode1 online=no</code>
<b>DELETE DATAMOVER</b>	To delete a data mover, issue the DELETE DATAMOVER command. For example, if you want to delete the data mover NASNODE1, issue the following command:  <code>delete datamover nasnode1</code>  Restriction: If the data mover has a path to a library, and you delete the data mover or take the data mover offline, you disable access to the library.

**Related reference:**

QUERY DATAMOVER (Display data mover definitions)

UPDATE DATAMOVER (Update a data mover)

DELETE DATAMOVER (Delete a data mover)

## Dedicating an IBM Spectrum Protect drive to NDMP operations

If you are already using a drive for IBM Spectrum Protect™ operations, you can dedicate that drive to NDMP operations.

### Procedure

Remove IBM Spectrum Protect server access by deleting the path definition. For example, if the server name is SERVER1 and the drive is NASDRIVE1, issue the following command:

```
delete path server1 nasdrive1 srctype=server desttype=drive library=naslib
```

## Storage pool management for NDMP operations

When NETAPPDUMP, CELERRADUMP, or NDMPDUMP is designated as the storage-pool type, managing the storage pools that are produced by NDMP operations is different from managing storage pools that contain media for traditional IBM Spectrum Protect™ backups.

The following guidelines and restrictions apply to storage pools of the NETAPPDUMP, CELERRADUMP, and NDMPDUMP type that are produced by NDMP operations:

- You can query and update storage pools, but you cannot update the DATAFORMAT parameter.
- You cannot designate a CENTERA, directory-container, or cloud-container storage pool as a target pool of NDMP operations.
- Maintaining separate storage pools for data from different NAS vendors is the preferred practice, even when the data format for both is NDMPDUMP.
- The following DEFINE STGPOOL and UPDATE STGPOOL command parameters are ignored because storage pool hierarchies, reclamation, and migration are not supported for these storage pools:
  - MAXSIZE
  - NEXTSTGPOOL
  - LOWMIG
  - HIGHMIG
  - MIGDELAY
  - MIGCONTINUE
  - RECLAIMSTGPOOL



- o OVFLOCATION

Important: Ensure that you do not accidentally use storage pools that were defined for NDMP operations in traditional IBM Spectrum Protect operations. Be especially careful when you assign the storage pool name as the value for the DESTINATION parameter of the DEFINE COPYGROUP command. Unless the destination is a storage pool with the appropriate data format, the backup fails.

## Managing tables of contents

---

You can use several commands to manage different aspects of your data contents.

### About this task

---

The SET TOCLOADRETENTION command can be used to specify the approximate number of minutes that an unreferenced table of contents (TOC) remains loaded in the IBM Spectrum Protect™ database. The IBM Spectrum Protect server-wide TOC retention value determines how long a loaded TOC is retained in the database after the latest access to information in the TOC.

Because TOC information is loaded into temporary database tables, this information is lost if the server is halted, even if the TOC retention period did not elapse. At installation, the retention time is set to 120 minutes. Use the QUERY STATUS command to see the TOC retention time.

Issue the QUERY NASBACKUP command to display information about the file system image objects that are backed up for a specific NAS node and file space. By issuing the command, you can see a display of all backup images that are generated by NDMP and whether each image has a corresponding TOC.

Tip: The IBM Spectrum Protect server can store a full backup in excess of the number of versions you specified if that full backup has dependent differential backups. Full NAS backups with dependent differential backups behave like other base files with dependent subfiles. Due to the retention time specified in the RETEXTRA setting, the full NAS backup is not expired, and the version is displayed in the output of a QUERY NASBACKUP command. For information about setting data retention policies, see Customizing policies.

Use the QUERY TOC command to display files and directories in a backup image that is generated by NDMP. By issuing the QUERY TOC server command, you can display all directories and files within a single specified TOC. The specified TOC is accessed in a storage pool each time the QUERY TOC command is issued because this command does not load TOC information into the IBM Spectrum Protect database. Then, use the RESTORE NODE command with the FILELIST parameter to restore individual files.

## Preventing long-running, inactive NDMP connections from closing

---

To prevent firewalls from closing NDMP connections that are long-running but inactive, you can enable Transmission Control Protocol (TCP) keepalive on the NDMP control connections.

### About this task

---

The IBM Spectrum Protect™ server initiates control connections to NAS devices during NDMP backup or restore operations. These control connections might remain open and inactive for an extended amount of time. For example, suppose that two NDMP operations are started for the same NAS device. The control connection for one NDMP operation might remain open but inactive if the operation requires a resource, for example, a tape drive or sequential volume, that is being used by the other NDMP operation.

Some firewall software is configured to automatically close network connections that are inactive for a specified length of time. If a firewall exists between an IBM Spectrum Protect server and a NAS device, it is possible that the firewall can close NDMP control connections unexpectedly and cause the NDMP operation to fail.

The IBM Spectrum Protect server provides a mechanism, TCP keepalive, that you can enable to prevent long-running, inactive connections from being closed. If TCP keepalive is enabled, small packets are sent across the network at predefined intervals to the connection partner.

Restriction: To prevent errors, do not enable TCP keepalive in certain types of environments. One example is environments that do not have firewalls between the IBM Spectrum Protect server and a NAS device. Another example is environments with firewalls that tolerate long-running, inactive connections. Enabling TCP keepalive in these types of environments can cause an idle connection to be inadvertently closed if the connection partner temporarily fails to respond to TCP keepalive packets.

- Enabling TCP keepalive  
To enable TCP keepalive, which keeps NDMP connections open, use the NDMPENABLEKEEPALIVE server option.

- **AIX** | **Linux** | **Windows** Specifying connection idle time for TCP keepalive  
To specify the amount of connection idle time, in minutes, before the first TCP keepalive packet is sent, use the NDMPKEEPIDLEMINUTES server option.

## Enabling TCP keepalive

---

To enable TCP keepalive, which keeps NDMP connections open, use the NDMPENABLEKEEPALIVE server option.

### Procedure

---

Add the option to the server options file dsmserv.opt:

```
ndmpenablekeepalive yes
```

**Related reference:**

NDMPENABLEKEEPALIVE

**AIX** | **Linux** | **Windows**

## Specifying connection idle time for TCP keepalive

---

To specify the amount of connection idle time, in minutes, before the first TCP keepalive packet is sent, use the NDMPKEEPIDLEMINUTES server option.

### Procedure

---

Add the option to the server options file dsmserv.opt:

```
ndmpkeepidleminutes minutes
```

**Related reference:**

NDMPKEEPIDLEMINUTES

## Configuring IBM Spectrum Protect for NDMP operations

---

You can configure IBM Spectrum Protect™ to back up and recover data on NAS file servers by using NDMP. The configuration procedure differs depending on whether you plan to back up data from a nonclustered or clustered NAS file server.

- **Configuring IBM Spectrum Protect for NDMP operations in a nonclustered environment**  
Before you configure IBM Spectrum Protect for NDMP operations in a nonclustered environment, register the required license.
- **Configuring IBM Spectrum Protect for NDMP operations in a NetApp clustered environment**  
You can back up data from a NetApp cluster to a directly attached tape device or to an IBM Spectrum Protect server, which stores the data in a storage pool. You can back up the entire cluster to a single IBM Spectrum Protect node or parts of the cluster to multiple nodes.

## Configuring IBM Spectrum Protect for NDMP operations in a nonclustered environment

---

Before you configure IBM Spectrum Protect™ for NDMP operations in a nonclustered environment, register the required license.

### Procedure

---

1. Set up the tape library and media. See Configuring a tape library for NDMP operations, where the following steps are described in more detail.
  - a. Attach the SCSI or virtual tape library (VTL) library to the NAS file server or to the IBM Spectrum Protect server, or attach the ACSLS library or 349X library to the IBM Spectrum Protect server.
  - b. Define the library with a library type of SCSI, VTL, ACSLS, or 349X.
  - c. Define a device class for the tape drives.
  - d. Define a storage pool for NAS backup media.
  - e. Optional: Define a storage pool for storing a table of contents.

2. Configure IBM Spectrum Protect policy for managing NAS image backups. See [Configuring an IBM Spectrum Protect policy for NDMP operations](#).
3. Register a NAS file server node with the IBM Spectrum Protect server. See [Registering NAS nodes with the IBM Spectrum Protect server](#).
4. Define a data mover for the NAS file server. See [Defining a data mover for a NAS file server](#).
5. Define a path from either the IBM Spectrum Protect server or the NAS file server to the library. See [Defining paths to libraries for NDMP operations](#).
6. Define the tape drives to IBM Spectrum Protect, and define the paths to those drives from the NAS file server and optionally from the IBM Spectrum Protect server. See [Defining paths for NDMP operations](#).
7. Check tapes into the library and label them.

**AIX Linux** Tape volumes must be labeled before the server can use them. You can use the LABEL LIBVOLUME command, or you can use the AUTOLABEL parameter with the DEFINE LIBRARY and UPDATE LIBRARY commands.

**Windows** All media must be labeled. Labeling media with an automated library requires you to check media into the library. To label volumes with the LABEL LIBVOLUME command, specify the CHECKIN parameter. To automatically label tape volumes in SCSI-type libraries, use the AUTOLABEL parameter on the DEFINE LIBRARY and UPDATE LIBRARY commands.

For instructions, see LABEL LIBVOLUME, DEFINE LIBRARY, and UPDATE LIBRARY.

8. Optional: Set up scheduled backups for NAS file servers. See [Scheduling NDMP operations](#).
  9. Optional: Define a virtual file space name. See [Defining virtual file spaces](#).
  10. Optional: Configure for tape-to-tape copy to back up data. See [Backing up data with the tape-to-tape function](#).
  11. Optional: Configure for tape-to-tape copy to move data to a different tape technology. See [Moving data with the tape-to-tape copy function](#).
- [Configuring an IBM Spectrum Protect policy for NDMP operations](#)  
With policies, you can manage the number and retention time of NDMP image backup versions.
  - [Tape libraries and drives for NDMP operations](#)  
Most of the planning that is required to implement backup and recovery operations that use NDMP is related to device configuration. You have choices about how to connect and use the libraries and drives.
  - [Attaching tape library robotics for NAS-attached libraries](#)  
If you plan to back up NAS data to a library that is directly attached to the NAS device and use a SCSI tape library, you must determine where to attach the library.
  - [Registering NAS nodes with the IBM Spectrum Protect server](#)  
Register the NAS file server as an IBM Spectrum Protect node, specifying TYPE=NAS. This node name is used to track the image backups for the NAS file server.
  - [Defining a data mover for a NAS file server](#)  
Define a data mover for each NAS file server by using NDMP operations in your environment. The data mover name must match the node name that you specified when you registered the NAS node to the IBM Spectrum Protect server.
  - [Defining paths for NDMP operations](#)  
For NDMP operations, you create paths to drives and to libraries.
  - [Scheduling NDMP operations](#)  
You can schedule backup or restore operations for images that are produced by NDMP operations. Use administrative schedules that process the BACKUP NODE or RESTORE NODE administrative commands.
  - [Defining virtual file spaces](#)  
Use a virtual file space definition to complete NAS directory-level backups. To reduce backup and restore times for large file systems, map a directory path from a NAS file server to a virtual file space name on the IBM Spectrum Protect server.
  - [Backing up data with the tape-to-tape function](#)  
When you use the NDMP tape-to-tape function to back up data, the library type can be SCSI, 349X, or ACSLS (automated cartridge system library software). Drives can be shared between the NAS devices and the IBM Spectrum Protect server.
  - [Moving data with the tape-to-tape copy function](#)  
To move data from a previous tape technology to a new tape technology by using the NDMP tape-to-tape copy operation, you must complete the standard steps in your configuration setup and additional steps.

## Configuring an IBM Spectrum Protect policy for NDMP operations

---

With policies, you can manage the number and retention time of NDMP image backup versions.

### About this task

---

For more information, see [Policies for backups initiated with an IBM Spectrum Protect server](#).

## Procedure

---

Complete the following steps to configure a policy for NDMP operations:

1. Create a policy domain for NAS (network-attached storage) file servers. For example, to define a policy domain that is named NASDOMAIN, enter the following command:

```
define domain nasdomain description='Policy domain for NAS file servers'
```

2. Create a policy set in that domain. For example, to define a policy set named STANDARD in the policy domain that is named NASDOMAIN, issue the following command:

```
define policyset nasdomain standard
```

3. Define a management class, and then assign the management class as the default for the policy set. For example, to define a management class that is named MC1 in the STANDARD policy set, and assign it as the default, issue the following commands:

```
define mgmtclass nasdomain standard mc1  
assign defmgmtclass nasdomain standard mc1
```

4. Define a backup copy group in the default management class. The destination must be the storage pool that you created for backup images that are produced by NDMP operations. In addition, you can specify the number of backup versions to retain. For example, to define a backup copy group for the MC1 management class where up to four versions of each file system are retained in the storage pool that is named NASPOOL, issue the following command:

```
define copygroup nasdomain standard mc1 destination=naspool verexists=4
```

If you want to create a table of contents for your backups, the TOCDESTINATION parameter of the copy group must contain the name of the primary storage pool.

```
define copygroup nasdomain standard mc1 destination=naspool  
tocdestination=tocpool verexists=4
```

Important: When you define a copy group for a management class to which a file system image produced by NDMP is bound, be sure that the DESTINATION parameter specifies the name of a storage pool that is defined for NDMP operations. If the DESTINATION parameter specifies an invalid storage pool, backups by NDMP fail.

5. Activate the policy set. For example, to activate the STANDARD policy set in the NASDOMAIN policy domain, issue the following command:

```
activate policyset nasdomain standard
```

The policy is ready to be used. Nodes are associated with a policy when they are registered. For more information, see [Registering NAS nodes with the IBM Spectrum Protect server](#).

- Policies for backups initiated with an IBM Spectrum Protect server  
You can register a network-attached storage (NAS) file server as a node by using network data management protocol (NDMP) operations. Under the direction of the IBM Spectrum Protect server, the NAS file server backs up and restores a file system and directory images to a tape library.
- Policies for backups initiated with the client interface  
When a client node initiates a backup, the policy is affected by the option file for that client node.
- Determination of the NAS backup location  
When IBM Spectrum Protect uses NDMP to protect NAS file servers, the IBM Spectrum Protect server controls operations. During this time, the NAS file server transfers the data, either to an attached library or directly to the IBM Spectrum Protect server.

## Policies for backups initiated with an IBM Spectrum Protect server

---

You can register a network-attached storage (NAS) file server as a node by using network data management protocol (NDMP) operations. Under the direction of the IBM Spectrum Protect™ server, the NAS file server backs up and restores a file system and directory images to a tape library.

The IBM Spectrum Protect server initiates the backup, allocates a drive, and selects and mounts the media. The NAS file server then transfers the data to tape.

Because the NAS file server backs up the data, the data is stored in its own format. For most NAS file servers, the data is stored in the NDMPDUMP data format. For NetApp file servers, the data is stored in the NETAPPDUMP data format. For EMC file servers, the data is stored in the CELERRADUMP data format. To manage NAS file server image backups, copy groups for NAS nodes must point to a storage pool that has a data format of NDMPDUMP, NETAPPDUMP, or CELERRADUMP.

The following backup copy group attributes are ignored for NAS images:

- Frequency
- Mode
- Retain Only Versions
- Serialization
- Versions Data Deleted

To set up the required policy for NAS nodes, you can define a new, separate policy domain.

When the IBM Spectrum Protect server creates a table of contents (TOC), you can view a collection of individual files and directories that are backed up by using NDMP. Then, you can select which file and directories to restore. To establish where to send data and store the table of contents, set the policy in the following way:

- Ensure that image backup data is sent to a storage pool with an NDMPDUMP, NETAPPDUMP, or CELERRADUMP format.
- Ensure that the table of contents is sent to a storage pool with a NATIVE or NONBLOCK format.

## Policies for backups initiated with the client interface

When a client node initiates a backup, the policy is affected by the option file for that client node.

You can control the management classes that are applied to backup images produced by NDMP (network data management protocol) operations regardless of which node initiates the backup. You can complete this task by creating a set of options to be used by the client nodes. The option set can include an `include.fs.nas` statement to specify the management class for NAS (network-attached storage) file server backups.

Tip: You can define an option set by using the DEFINE CLOPTSET command. Then, add a client option to the option set by using the DEFINE CLIENTOPT command. You can assign an option set to a client by completing the following steps:

1. Open the Operations Center Overview page and click Clients.
2. Double-click the client and click Properties.
3. In the Option set field, select an option set and click Save.

For instructions about using the DEFINE CLOPTSET command, see DEFINE CLOPTSET (Define a client option set name). For instructions about using the DEFINE CLIENTOPT command, see DEFINE CLIENTOPT (Define an option to an option set).

## Determination of the NAS backup location

When IBM Spectrum Protect™ uses NDMP to protect NAS file servers, the IBM Spectrum Protect server controls operations. During this time, the NAS file server transfers the data, either to an attached library or directly to the IBM Spectrum Protect server.

You can also use a backup-archive client to back up a NAS file server by mounting the NAS file system on the client computer and then backing up as usual. You can use either a Network File System (NFS) mount or a Common Internet File System (CIFS) map.

For a description of the backup-and-restore methods, see Table 1.

Tip: You can use a single method or a combination of methods in your individual storage environment.

Table 1. Comparing methods for backing up NDMP data

Property	NDMP: File server to server	NDMP: File server to attached library	Backup-archive client to server
Network data traffic	All backup data goes across the LAN from the NAS file server to the server.	The server controls operations remotely, but the NAS device moves the data locally.	All backup data goes across the LAN from the NAS device to the client and then to the server.

<b>Property</b>	<b>NDMP: File server to server</b>	<b>NDMP: File server to attached library</b>	<b>Backup-archive client to server</b>
File server processing during backup	Less file server processing is required, compared to the backup-archive client method, because the backup does not use file access protocols such as NFS and CIFS.	Less file server processing is required, compared to the backup-archive client method, because the backup does not use file access protocols such as NFS and CIFS.	File backup operations require more server processing resources for file access protocols such as NFS and CIFS.
Distance between devices	The IBM Spectrum Protect server must be within SCSI or Fibre Channel range of the tape library.	The IBM Spectrum Protect server can be distant from the NAS file server and the tape library.	The IBM Spectrum Protect server must be within SCSI or Fibre Channel range of the tape library.
Firewall considerations	More stringent than filer-to-attached-library because communications can be initiated by either the IBM Spectrum Protect server or the NAS file server.	Less stringent than filer-to-server because communications can be initiated only by the IBM Spectrum Protect server.	Client passwords and data are encrypted.
Security considerations	Data is sent decrypted from a NAS file server to an IBM Spectrum Protect server.	This method must be used in a trusted environment because port numbers are not secure.	Port number configuration allows for secure administrative sessions within a private network.
Load on the IBM Spectrum Protect server	Higher CPU workload is required to manage all back-end data processes (for example, migration).	CPU workload is reduced because migration and reclamation are not supported.	Higher CPU workload is required to manage all back-end data processes.
Backup of primary storage pools to copy storage pools	Data can be backed up only to copy storage pools that have the NATIVE data format.	Data can be backed up only to copy storage pools that have the same NDMP data format (NETAPPDUMP, CELERRADUMP, or NDMPDUMP).	Data can be backed up only to copy storage pools that have the NATIVE data format.
Restore of primary storage pools and volumes from copy storage pools	Data can be restored only to storage pools and volumes that have the NATIVE data format.	Data can be restored only to storage pools and volumes that have the same NDMP data format.	Data can be restored only to storage pools and volumes that have the NATIVE data format.
Moving NDMP data from storage pool volumes	Data can be moved to another storage pool only if it has a NATIVE data format.	Data can be moved to another storage pool only if it has the same NDMP data format.	Data can be moved to another storage pool only if it has a NATIVE data format.
Migration from one primary storage pool to another	Supported	Not supported	Supported
Reclamation of a storage pool	Supported	Not supported	Supported
Simultaneous-write operations during backups	Not supported	Not supported	Supported
Export and import operations	Not supported	Not supported	Supported
Backup set generation	Not supported	Not supported	Supported
Cyclic Redundancy Checking (CRC) when data is moved by using IBM Spectrum Protect processes	Supported	Not supported	Supported
Validation by using IBM Spectrum Protect audit commands	Supported	Not supported	Supported

Property	NDMP: File server to server	NDMP: File server to attached library	Backup-archive client to server
Disaster recovery manager	Supported	Supported	Supported

## Tape libraries and drives for NDMP operations

Most of the planning that is required to implement backup and recovery operations that use NDMP is related to device configuration. You have choices about how to connect and use the libraries and drives.

Many of the configuration choices you have for libraries and drives are determined by the hardware features of your libraries. You can set up NDMP operations with any supported library and drives. However, the more features your library has, the more flexibility you can exercise in your implementation.

You might start by answering the following questions:

- What type of library (SCSI, ACSLS, or 349X) will you use?
- If you are using a SCSI library, do you want to attach tape library robotics to the IBM Spectrum Protect™ server or to the network-attached storage (NAS) file server?
- Will you want to move your NDMP data to tape?
- How do you want to use the tape drives in the library?
  - Dedicate all tape drives to NDMP operations.
  - Dedicate some tape drives to NDMP operations and others to traditional IBM Spectrum Protect operations.
  - Share tape drives between NDMP operations and traditional IBM Spectrum Protect operations.
- Will you back up data tape-to-tape for disaster recovery functions?
- Will you send backup data to a single IBM Spectrum Protect server instead of attaching a tape library to each NAS device?
- Do you want to keep all hardware on the IBM Spectrum Protect server and send NDMP data over the LAN?
- Determining library drive usage when backing up to NAS-attached libraries  
Drives can be used for multiple purposes because of the flexible configurations that are allowed by IBM Spectrum Protect. For NDMP operations, the NAS file server must have access to the drive. The IBM Spectrum Protect server can also have access to the same drive, depending on your hardware connections and limitations.
- Configuring a tape library for NDMP operations  
You can configure a tape library to back up a network-attached storage (NAS) device to tape.

## Determining library drive usage when backing up to NAS-attached libraries

Drives can be used for multiple purposes because of the flexible configurations that are allowed by IBM Spectrum Protect™. For NDMP operations, the NAS file server must have access to the drive. The IBM Spectrum Protect server can also have access to the same drive, depending on your hardware connections and limitations.

### About this task

All drives are defined to the IBM Spectrum Protect server. However, the same drive can be defined for both traditional IBM Spectrum Protect operations and NDMP operations. Figure 1 illustrates one possible configuration. The IBM Spectrum Protect server has access to drives 2 and 3, and each NAS file server has access to drives 1 and 2.

Figure 1. IBM Spectrum Protect drive usage example

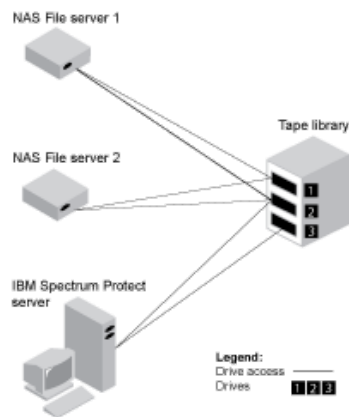

To create the configuration that is shown in Figure 1, complete the following steps:

## Procedure

1. Define all three drives to IBM Spectrum Protect.
2. Define paths from the IBM Spectrum Protect server to drives 2 and 3. Because drive 1 is not accessed by the server, no path is defined.
3. Define each NAS file server as a separate data mover.
4. Define paths from each data mover to drive 1 and to drive 2.

## Results

To use the IBM Spectrum Protect back-end data movement operations, the IBM Spectrum Protect server requires two available drive paths from a single NAS data mover. The drives can be in different libraries and can have different device types that are supported by NDMP. You can make copies between two different tape devices. For example, the source tape drive can be a DLT drive in a library and the target drive can be an LTO drive in another library.

During IBM Spectrum Protect back-end data movements, the IBM Spectrum Protect server locates a NAS data mover that supports the same data format as the data to be copied from and that has two available mount points and paths to the drives. If the IBM Spectrum Protect server cannot locate such a data mover, the requested data movement operation is not performed. The number of available mount points and drives depends on the mount limits of the device classes for the storage pools that are involved in the back-end data movements.

If the back-end data movement function supports multiprocessing, each concurrent IBM Spectrum Protect back-end data movement process requires two available mount points and two available drives. To run two IBM Spectrum Protect processes concurrently, at least four mount points and four drives must be available.

For more information, see [Defining paths for NDMP operations](#).

## Configuring a tape library for NDMP operations

You can configure a tape library to back up a network-attached storage (NAS) device to tape.

### Procedure

Complete the following steps to set up tape libraries for NDMP operations:

1. Connect the library and drives to be used for NDMP operations.
  - a. Connect the SCSI library. Before you set up a SCSI tape library for NDMP operations, determine whether you want to attach your library robotics control to the IBM Spectrum Protect™ server or to the NAS file server. See [Tape libraries and drives for NDMP operations](#). Connect the SCSI tape library robotics to the IBM Spectrum Protect server or to the NAS file server. Refer to your device manufacturer documentation for instructions.

If the library is connected to IBM Spectrum Protect, make a SCSI or Fibre Channel connection between the IBM Spectrum Protect server and the library robotics control port. Then, connect the NAS file server with the drives.



If the library is connected to the NAS file server, make a SCSI or Fibre Channel connection between the NAS file server and the library robotics and drives.

- b. Connect the ACSLS Library. Connect the ACSLS tape library to the IBM Spectrum Protect server.
- c. Connect the 349X Library. Connect the 349X tape library to the IBM Spectrum Protect server.

2. Define the library for your library device by issuing the DEFINE LIBRARY command. The library must be a single device type, not a mixed device. Issue one of the following commands to define the library depending on the type of device that you are configuring:

#### SCSI Library

```
define library tsmlib libtype=scsi
```

#### ACSLs Library

```
define library acslib libtype=acsls acsid=1
```

#### 349X Library

```
define library tsmlib libtype=349x
```

3. Define a device class for your NDMP device by issuing the DEFINE DEVCLASS command.

Tip: A device class that is defined with a device type of NAS is not explicitly associated with a specific drive type, for example, LTO. However, the preferred practice is to define a separate device class for different drive types.

In the DEFINE DEVCLASS command, use the following parameters and values:

- o Specify `DEVTYPE=NAS`.
- o Specify `MOUNTRETENTION=0`. It is required for NDMP operations.
- o Specify a value for the `ESTCAPACITY` parameter.

For example, to define a device class that is named `NASCLASS` for a library that is named `NASLIB` with an estimated capacity is 40 GB for the media, issue the following command:

```
define devclass nasclass devtype=nas library=naslib mountretention=0  
estcapacity=40g
```

4. Define a storage pool for NDMP media by issuing the DEFINE STGPOOL command. When `NETAPPDUMP`, `CELERRADUMP`, or `NDMPDUMP` is designated as the type of storage pool, managing the storage pools that are produced by NDMP operations is different from managing storage pools that contain media for traditional IBM Spectrum Protect backups. IBM Spectrum Protect operations use storage pools that are defined with a `NATIVE` or `NONBLOCK` data format. If you select `NETAPPDUMP`, `CELERRADUMP`, or `NDMPDUMP`, NDMP operations require storage pools with a data format that matches the NAS file server and the selected backup method. Maintaining separate storage pools for data from different NAS vendors is optimal, even though the data format for both is `NDMPDUMP`. For example, to define a storage pool that is named `NDMPPOOL` for a file server, which is not a NetApp or a Celerra file server, issue the following command:

```
define stgpool ndmpool nasclass maxscratch=10 dataformat=ndmpdump
```

To define a storage pool that is named `NASPOOL` for a NetApp file server, issue the following command:

```
define stgpool naspool nasclass maxscratch=10 dataformat=netappdump
```

To define a storage pool that is named `CELERRAPOOL` for an EMC Celerra file server, issue the following command:

```
define stgpool celerrapool nasclass maxscratch=10 dataformat=celerradump
```

Attention: Ensure that you do not accidentally use storage pools that are defined for NDMP operations in traditional IBM Spectrum Protect operations. Be especially careful when you assign the storage pool name as the value for the `DESTINATION` parameter of the `DEFINE COPYGROUP` command. Unless the destination is a storage pool with the appropriate data format, the backup can fail.

5. Optional: Define a storage pool for a table of contents. If you plan to create a table of contents, you must also define a disk storage pool in which to store the table of contents. You must set up policy so that the IBM Spectrum Protect server stores the table of contents in a different storage pool from the one where the backup image is stored. The table of contents is treated like any other object in that storage pool. For example, to define a storage pool that is named `TOCPOOL` for a DISK device class, issue the following command:

```
define stgpool tocpool disk
```

Then define volumes for the storage pool.

**AIX** | **Linux** For more information about defining volumes, see Configuring random access volumes on disk devices (V7.1.1).

**Windows** For more information about defining volumes, see Configuring random access volumes on disk devices (V7.1.1).

**AIX** | **Linux** For more information about configuring libraries, see Configuring libraries for use by a server.

**Related reference:**

DEFINE DEVCLASS (Define a device class)

## Attaching tape library robotics for NAS-attached libraries

If you plan to back up NAS data to a library that is directly attached to the NAS device and use a SCSI tape library, you must determine where to attach the library.

### About this task

You must determine whether to attach the library robotics to the IBM Spectrum Protect™ server or to the NAS file server. Regardless of where you connect library robotics, tape drives must always be connected to the NAS file server for NDMP operations.

Distance and your available hardware connections are factors to consider for SCSI libraries. If the library does not have separate ports for robotics control and drive access, the library must be attached to the NAS file server because the NAS file server must have access to the drives. If your SCSI library has separate ports for robotics control and drive access, you can choose to attach the library robotics to either the IBM Spectrum Protect server or the NAS file server. If the NAS file server is at a different location from the IBM Spectrum Protect server, the distance might mean that you must attach the library to the NAS file server.

Whether you are using a SCSI, ACSLS, or 349X library, you have the option of dedicating the library to NDMP operations, or of using the library for NDMP operations. You can also use the library for most traditional IBM Spectrum Protect operations.

Table 1. Summary of configurations for NDMP operations

Configuration	Distance between IBM Spectrum Protect server and library	Library sharing	Drive sharing between IBM Spectrum Protect and NAS file server	Drive sharing between NAS file servers	Drive sharing between storage agent and NAS file server
Configuration 1 (SCSI library that is connected to the IBM Spectrum Protect server)	Limited by SCSI or FC connection	Supported	Supported	Supported	Supported
Configuration 2 (SCSI library that is connected to the NAS file server)	No limitation	Not supported	Supported	Supported	Not supported
Configuration 3 (349X library)	Might be limited by 349X connection	Supported	Supported	Supported	Supported
<b>AIX</b>   <b>Windows</b> Configuration 4 (ACSLs library)	<b>AIX</b>   <b>Windows</b> Might be limited by ACSLS connection	<b>AIX</b>   <b>Windows</b> Supported	<b>AIX</b>   <b>Windows</b> Supported	<b>AIX</b>   <b>Windows</b> Supported	<b>AIX</b>   <b>Windows</b> Supported

- Configuration 1: SCSI library connected to the IBM Spectrum Protect server  
In this configuration, the tape library must have separate ports for robotics control and for drive access. In addition, the library must be within Fibre Channel range or SCSI bus range of both the IBM Spectrum Protect server and the NAS file server.
- Configuration 2: SCSI library connected to the NAS file server  
In this configuration, the library robotics and the drives must be physically connected directly to the NAS file server. Paths must be defined from the NAS data mover to the library and drives. No physical connection is required between the IBM Spectrum Protect server and the SCSI library.
- Configuration 3: 349x library connected to the IBM Spectrum Protect server  
For this configuration, you connect the tape library to the system as for traditional operations.

- Configuration 4: ACSLS library connected to the IBM Spectrum Protect server  
For this configuration, connect the tape library to the system as you do for traditional IBM Spectrum Protect operations.

## Configuration 1: SCSI library connected to the IBM Spectrum Protect server

In this configuration, the tape library must have separate ports for robotics control and for drive access. In addition, the library must be within Fibre Channel range or SCSI bus range of both the IBM Spectrum Protect™ server and the NAS file server.

In this configuration, the IBM Spectrum Protect server controls the SCSI library through a direct, physical connection to the library robotics control port. For NDMP operations, the drives in the library are connected directly to the NAS file server, and a path must be defined from the NAS data mover to each of the drives to be used. The NAS file server transfers data to the tape drive at the request of the IBM Spectrum Protect server. To also use the drives for IBM Spectrum Protect operations, connect the IBM Spectrum Protect server to the tape drives and define paths from the server to the tape drives.

This configuration also supports an IBM Spectrum Protect storage agent having access to the drives for its LAN-free operations, and the IBM Spectrum Protect server can be a library manager.

Figure 1. Configuration 1: SCSI library connected to IBM Spectrum Protect server

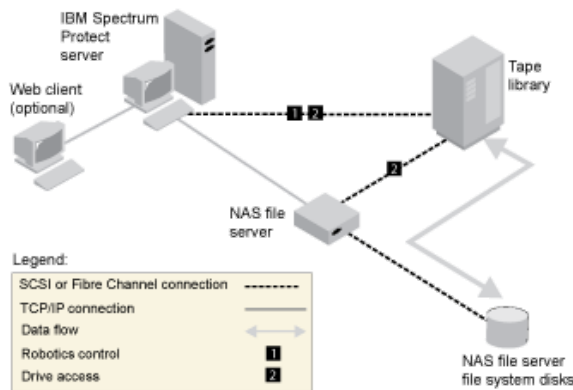

## Configuration 2: SCSI library connected to the NAS file server

In this configuration, the library robotics and the drives must be physically connected directly to the NAS file server. Paths must be defined from the NAS data mover to the library and drives. No physical connection is required between the IBM Spectrum Protect™ server and the SCSI library.

The IBM Spectrum Protect server controls library robotics by sending library commands across the network to the NAS file server. The NAS file server passes the commands to the tape library. Any responses that are generated by the library are sent to the NAS file server, and passed back across the network to the IBM Spectrum Protect server. This configuration supports a physically distant IBM Spectrum Protect server and NAS file server. For example, the IBM Spectrum Protect server is in one city, while the NAS file server and tape library are in another city.

Figure 1. Configuration 2: SCSI library connected to the NAS file server

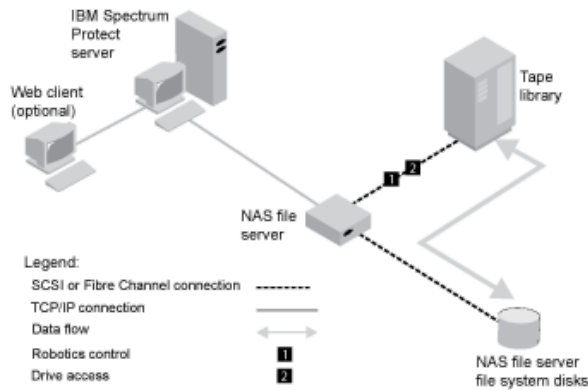

## Configuration 3: 349x library connected to the IBM Spectrum Protect server

For this configuration, you connect the tape library to the system as for traditional operations.

In this configuration, the 349X tape library is controlled by the IBM Spectrum Protect™ server. The IBM Spectrum Protect server controls the library by passing the request to the 349X library manager through TCP/IP.

To complete NAS (network-attached storage) backup or restore operations, the NAS file server must be able to access one or more tape drives in the 349X library. Any tape drives used for NAS operations must be physically connected to the NAS file server, and paths need to be defined from the NAS data mover to the drives. The NAS file server transfers data to the tape drive at the request of the IBM Spectrum Protect server. Follow the manufacturer's instructions to attach the device to the server system.

This configuration supports a physically distant IBM Spectrum Protect server and NAS file server. For example, the IBM Spectrum Protect server might be in one city, while the NAS file server and tape library are in another city.

Figure 1. Configuration 3: 349x library connected to the IBM Spectrum Protect server

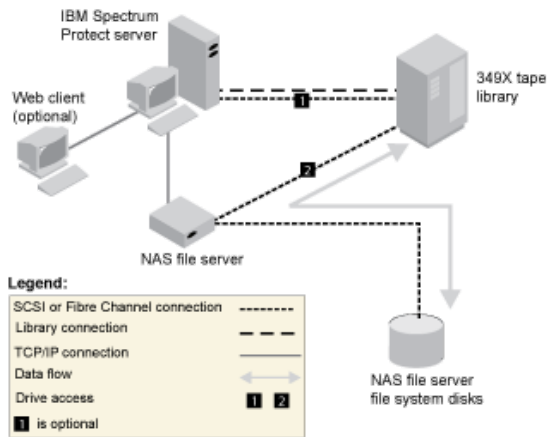

### Related tasks:

[Attaching devices for the server \(V7.1.1\)](#)

## Configuration 4: ACSLS library connected to the IBM Spectrum Protect server

For this configuration, connect the tape library to the system as you do for traditional IBM Spectrum Protect™ operations.

The ACSLS (automated cartridge system library software) tape library is controlled by the IBM Spectrum Protect server. The IBM Spectrum Protect server controls the library by passing the request to the ACSLS library server through TCP/IP. The ACSLS library supports library sharing and LAN-free operations.

**Windows Restriction:** To use ACSLS functions, StorageTek Library Attach software must be installed. For more information, see ACSLS-managed libraries (V7.1.1).

To complete NAS (network-attached storage) backup or restore operations, the NAS file server must be able to access one or more tape drives in the ACSLS library. Any tape drives used for NAS operations must be physically connected to the NAS file server, and any paths need to be defined from the NAS data mover to the drives. The NAS file server transfers data to the tape drive at the request of the IBM Spectrum Protect server. Follow the manufacturer's instructions to attach the device to the server system.

This configuration supports a physically distant IBM Spectrum Protect server and NAS file server. For example, the IBM Spectrum Protect server might be in one city while the NAS file server and tape library are in another city.

To also use the drives for IBM Spectrum Protect operations, connect the IBM Spectrum Protect server to the tape drives and define paths from the IBM Spectrum Protect server to the tape drives.

Figure 1. Configuration 4: ACSLS library connected to the IBM Spectrum Protect server

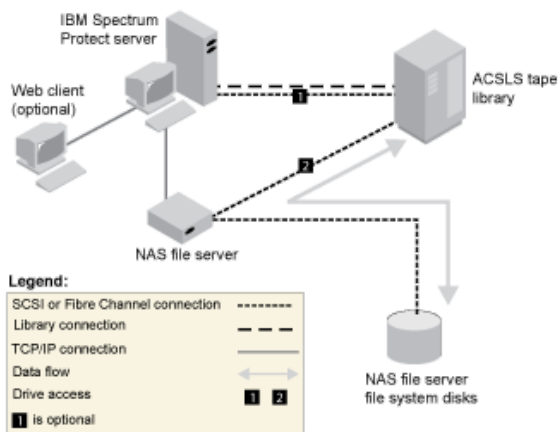

#### Related tasks:

🔗 [Attaching devices for the server \(V7.1.1\)](#)

## Registering NAS nodes with the IBM Spectrum Protect server

Register the NAS file server as an IBM Spectrum Protect™ node, specifying TYPE=NAS. This node name is used to track the image backups for the NAS file server.

### Procedure

To register a NAS file server as a node named NASNODE1, with a password of NASPWD1, in a policy domain that is named NASDOMAIN, issue the following example command:

```
register node nasnode1 naspwd1 domain=nasdomain type=nas
```

If you are using a client option set, specify the option set when you register the node. You can verify that this node is registered by issuing the following command:

```
query node type=nas
```

Remember: You must specify TYPE=NAS so that only NAS nodes are displayed.

## Defining a data mover for a NAS file server

Define a data mover for each NAS file server by using NDMP operations in your environment. The data mover name must match the node name that you specified when you registered the NAS node to the IBM Spectrum Protect™ server.

### About this task

IBM Spectrum Protect supports two types of data movers:

- For NDMP operations, data movers are NAS file servers. The definition for a NAS data mover contains the network address, authorization, and data formats that are required for NDMP operations. A data mover enables communication and ensures authority for NDMP operations between the IBM Spectrum Protect server and the NAS file server.
- For server-free data movement, data movers are devices such as the IBM® SAN Data Gateway, which move data between disk devices and tape devices on the SAN.

## Procedure

---

To define a data mover, use the DEFINE DATAMOVER command.

## Example

---

For example, define a data mover with these parameters:

- The NAS node is named NASNODE1.
- The high-level address is an IP address for the NAS file server, either a numerical address or a host name.
- The low-level address is the IP port for NDMP sessions with the NAS file server. The default is port number 10000.
- The user ID is the ID defined to the NAS file server that authorizes an NDMP session with the NAS file server. For this example, the user ID is the administrative ID for the NetApp file server.
- The password parameter is a valid password for authentication to an NDMP session with the NAS file server.
- The data format is NETAPPDUMP. This is the data format that the NetApp file server uses for tape backup. This data format must match the data format of the target storage pool.

Enter the following command:

```
define datamover nasnode1 type=nas haddress=netapp2 lladdress=10000 userid=root  
password=admin dataformat=netappdump
```

### Related reference:

DEFINE DATAMOVER (Define a data mover)

## Defining paths for NDMP operations

---

For NDMP operations, you create paths to drives and to libraries.

- Defining paths to drives for NDMP operations  
The method that you choose for creating paths to drives depends on whether the drives are accessed by a NAS file server and the IBM Spectrum Protect server or only by a NAS file server.
- Defining paths to libraries for NDMP operations  
Define a path to the SCSI library from either the IBM Spectrum Protect server or the NAS file server.

## Defining paths to drives for NDMP operations

---

The method that you choose for creating paths to drives depends on whether the drives are accessed by a NAS file server and the IBM Spectrum Protect™ server or only by a NAS file server.

- Defining paths for drives attached to a NAS file server and to the IBM Spectrum Protect server  
If a tape drive must be accessed by a network-attached storage (NAS) file server and the IBM Spectrum Protect server, you must create two paths. One path exists between the tape drive and the NAS file server. The other path exists between the tape drive and the IBM Spectrum Protect server.
- Defining paths for drives attached only to NAS file servers  
If a tape drive must be accessed only by a NAS file server and not by the IBM Spectrum Protect server, only a single path between the tape drive and the NAS file server is required.
- Obtaining names for devices attached to NAS file servers  
For paths from a NAS data mover, the value of the DEVICE parameter in the DEFINE PATH command is the name by which the NAS file server knows a library or drive.

## Defining paths for drives attached to a NAS file server and to the IBM Spectrum Protect server

---

If a tape drive must be accessed by a network-attached storage (NAS) file server and the IBM Spectrum Protect™ server, you must create two paths. One path exists between the tape drive and the NAS file server. The other path exists between the tape drive and the IBM Spectrum Protect server.

## Procedure

---

Complete the following steps:

1. If the drive is not defined for the IBM Spectrum Protect server, create the drive definition. For example, to define a drive NASDRIVE1 for a library NASLIB, issue the following command:

```
define drive naslib nasdrive1 element=autodetect
```

Remember: If the drive is attached to the IBM Spectrum Protect server, the element address is automatically detected.

2. Map the NAS drive name to the corresponding drive definition on the IBM Spectrum Protect server:
  - o On the IBM Spectrum Protect server, issue the QUERY DRIVE FORMAT=DETAILED command to obtain the worldwide name (WWN) and serial number for the drive that will be connected to the NAS file server.
  - o On the NAS device, obtain the tape device name, serial number, and WWN for the drive.

If the WWN or serial number matches, a drive on a NAS file server is the same as the drive on the IBM Spectrum Protect server.

3. Using the drive name, define a path to the drive from the NAS file server and a path to the drive from the IBM Spectrum Protect server.
  - o For example, to define a path between a tape drive with a device name of rst01 and a NetApp file server, issue the following command:

```
define path nasnode1 nasdrive1 srctype=datamover desttype=drive
  library=naslib device=rst01
```

- o To define a path between the tape drive and the IBM Spectrum Protect server, issue the following command:

**AIX**

```
define path server1 nasdrive1 srctype=server desttype=drive
  library=naslib device=/dev/rmt0
```

**Linux**

```
define path server1 nasdrive1 srctype=server desttype=drive
  library=naslib device=/dev/tmscsi/mt0
```

**Windows**

```
define path server1 nasdrive1 srctype=server desttype=drive
  library=naslib device=mt3.0.0.2
```

## Defining paths for drives attached only to NAS file servers

---

If a tape drive must be accessed only by a NAS file server and not by the IBM Spectrum Protect™ server, only a single path between the tape drive and the NAS file server is required.

## Procedure

---

Complete the following steps:

1. Obtain the SCSI element addresses, worldwide name (WWN), and serial numbers for the drive to be connected to NAS file server.

Restriction: If the SCSI drive is connected only to a NAS file server, the element address is not automatically detected, and you must supply it. If a library has more than one drive, you must specify an element address for each drive.

To obtain a SCSI element address, go to the following device-support websites:

- o **AIX** | **Windows** Supported devices for AIX and Windows
- o **Linux** Supported devices for Linux

Element number assignment and device WWN assignments are also available from tape-library device manufacturers.

2. Create drive definitions by specifying the element addresses identified in the preceding step. Specify the element address in the ELEMENT parameter of the DEFINE DRIVE command. For example, to define a drive NASDRIVE1 with the element address 82 for the library NASLIB, issue the following command:

```
define drive naslib nasdrive1 element=82
```

Attention: For a drive connected only to the NAS file server, do not specify ASNEEDED as the value for the CLEANFREQUENCY parameter of the DEFINE DRIVE command.

3. Obtain the device name, serial number, and WWN for the drive on the NAS device.
4. Using the information that is obtained in steps 1 and 3, map the NAS device name to the element address in the drive definition in the IBM Spectrum Protect server.
5. Define a path between the tape drive and the NAS file server. For example, to define a path between a NetApp file server and a tape drive with a device name of rst01, issue the following command:

```
define path nasnode1 nasdrive1 srctype=datamover desttype=drive
library=naslib device=rst01
```

## Obtaining names for devices attached to NAS file servers

---

For paths from a NAS data mover, the value of the DEVICE parameter in the DEFINE PATH command is the name by which the NAS file server knows a library or drive.

### About this task

---

You can obtain these device names, also known as *special file names*, by querying the NAS file server. For information about how to obtain names for devices that are connected to a NAS file server, see the product information for the file server.

### Procedure

---

- To obtain the device names for tape libraries on a NetApp Release ONTAP 10.0 GX, or later, file server, connect to the file server by using telnet and issue the SYSTEM HARDWARE TAPE LIBRARY SHOW command. To obtain the device names for tape drives on a NetApp Release ONTAP 10.0 GX, or later, file server, connect to the file server by using telnet and issue the SYSTEM HARDWARE TAPE DRIVE SHOW command. For details about these commands, see the NetApp ONTAP GX file server product documentation.
- For releases earlier than NetApp Release ONTAP 10.0 GX, continue to use the SYSCONFIG command. For example, to display the device names for tape libraries, connect to the file server by using telnet and issue the following command:

```
sysconfig -m
```

To display the device names for tape drives, issue the following command:

```
sysconfig -t
```

- For Fibre Channel attached drives and the Celerra data mover, complete the following steps:
  1. Log on to the EMC Celerra control workstation by using an administrative ID. Issue the following command:

```
server_devconfig server_1 -l -s -n
```

Tip: The -l option for this command lists only the device information that was saved in the database of the data mover. The command and option do not display changes to the device configuration that occurred after the last database refresh on the data mover. For details about how to obtain the most recent device configuration for your data mover, see the EMC Celerra documentation.

The output for the server\_devconfig command includes the device names for the devices that are attached to the data mover. The device names are listed in the *addr* column, for example:

```
server_1:
Scsi Device Table
name      addr      type  info
tape1     c64t010  tape  IBM ULT3580-TD2 53Y2
ttape1    c96t010  tape  IBM ULT3580-TD2 53Y2
```

2. Map the Celerra device name to the device worldwide name (WWN):
  - a. To list the WWN, log on to the EMC Celerra control workstation and issue the following command. Remember to enter a period (.) as the first character in this command.

```
.server_config server_# -v "fcp bind show"
```

The output for this command includes the WWN, for example:

```
Chain 0064: WWN 500507630f418e29 HBA 2 N_PORT Bound
Chain 0096: WWN 500507630f418e18 HBA 2 N_PORT Bound
```



Tip: The `.server_config` command is an undocumented EMC Celerra command. For more information about how to use it, contact EMC.

- b. Use the chain number to identify the tape device that was listed in the output of the `server_devconfig` command and that has the same WWN, for example:

Tape device name	Chain number	WWN
c64t0l0	0064	500507630f418e29
c96t0l0	0096	500507630f418e18

Celerra commands might behave differently on different EMC Celerra systems and operating system levels. For details, see the EMC Celerra documentation or contact EMC.

## Defining paths to libraries for NDMP operations

---

Define a path to the SCSI library from either the IBM Spectrum Protect™ server or the NAS file server.

### Procedure

---

1. For a SCSI library connected to IBM Spectrum Protect, issue the following example command to define a path from the server, named `SERVER1`, to the SCSI library named `TSMLIB`:

#### AIX

```
define path server1 tsmlib srctype=server desttype=library
device=/dev/lb1
```

#### Linux

```
define path server1 tsmlib srctype=server desttype=library
device=/dev/tmscsi/lb1
```

#### Windows

```
define path server1 tsmlib srctype=server desttype=library
device=lb0.0.0.2
```

2. For a SCSI library connected to a NAS file server, issue the following example command to define a path between a NetApp NAS data mover that is named `NASNODE1` and a library named `NASLIB`:

```
define path nasnode1 naslib srctype=datamover desttype=library device=mc0
```

3. For a 349X library, define a path to the library from the IBM Spectrum Protect server. For example, issue the following command to define a path from the server, named `SERVER1`, to the 349X library named `TSMLIB`:

#### AIX

```
define path server1 tsmlib srctype=server desttype=library
device=/dev/lmcp0
```

#### Linux | Windows

```
define path server1 tsmlib srctype=server desttype=library
device=library1
```

Tip: The `DEFINE PATH` command is not required for an automated cartridge system library software (ACSL) library.

## Scheduling NDMP operations

---

You can schedule backup or restore operations for images that are produced by NDMP operations. Use administrative schedules that process the `BACKUP NODE` or `RESTORE NODE` administrative commands.

### Procedure

---

Create an administrative schedule by using the `DEFINE SCHEDULE` command. For example, to create an administrative schedule that is named `NASSCHED` to back up all file systems for node `NASNODE1`, enter the following command:

```
define schedule nassched type=administrative cmd='backup node nasnode1' active=yes
starttime=20:00 period=1 perunits=days
```

The schedule is active, and is set to run at 8 p.m. every day.

Restriction: The BACKUP NODE and RESTORE NODE commands can be used only for nodes of TYPE=NAS.

**Related tasks:**

🔗 [Tuning the schedule for daily operations](#)

**Related reference:**

BACKUP NODE (Back up a NAS node)

RESTORE NODE (Restore a NAS node)

DEFINE SCHEDULE (Define a schedule for an administrative command)

## Defining virtual file spaces

---

Use a virtual file space definition to complete NAS directory-level backups. To reduce backup and restore times for large file systems, map a directory path from a NAS file server to a virtual file space name on the IBM Spectrum Protect™ server.

### Procedure

---

To create a virtual file space name for the directory path on the NAS device, issue the DEFINE VIRTUALFSMAPPING command:

```
define virtualfsmapping nas1 /mikesdir /vol/vol1 /mikes
```

This command defines a virtual file space name of /MIKESDIR on the server, which represents the directory path of /VOL/VOL1/MIKES on the NAS file server that is represented by node NAS1. For more information, see [Directory-level backup and restore for NDMP operations](#).

## Backing up data with the tape-to-tape function

---

When you use the NDMP tape-to-tape function to back up data, the library type can be SCSI, 349X, or ACSLS (automated cartridge system library software). Drives can be shared between the NAS devices and the IBM Spectrum Protect™ server.

### About this task

---

When you use the NDMP tape-to-tape copy function, your configuration setup might affect the performance of the IBM Spectrum Protect back-end data movement.

### Procedure

---

To have one NAS device with paths to four drives in a library, use the MOVE DATA command after you complete your configuration setup. This moves data on the volume VOL1 to any available volumes in the same storage pool as VOL1:

```
move data vol1
```

## Moving data with the tape-to-tape copy function

---

To move data from a previous tape technology to a new tape technology by using the NDMP tape-to-tape copy operation, you must complete the standard steps in your configuration setup and additional steps.

### About this task

---

When you use the NDMP tape-to-tape copy function, your configuration setup might affect the performance of the IBM Spectrum Protect™ back-end data movement.

### Procedure

---

In addition to the standard steps in your configuration setup, complete the following steps:

1. Define one drive in the library, lib1, that has previous tape technology:

```
define drive lib1 drv1 element=1035
```

2. Define one drive in the library, lib2, that has new tape technology:

```
define drive lib2 drv1 element=1036
```

3. Define paths from the NAS file server to each drive:

```
define path nas1 drv1 sourcetype=datamover desttype=drive library=lib1 device=rst11  
define path nas1 drv1 sourcetype=datamover desttype=drive library=lib2 device=rst21
```

4. Move data on volume vol1 in the primary storage pool to the volumes in another primary storage pool, nasprimpool2:

```
move data vol1 stgpool=nasprimpool2
```

## Configuring IBM Spectrum Protect for NDMP operations in a NetApp clustered environment

You can back up data from a NetApp cluster to a directly attached tape device or to an IBM Spectrum Protect™ server, which stores the data in a storage pool. You can back up the entire cluster to a single IBM Spectrum Protect node or parts of the cluster to multiple nodes.

### Before you begin

For an overview of NDMP functionality in IBM Spectrum Protect and NetApp file servers, see technote 7046965. This technote also lists system requirements.

### About this task

You can back up data in a NetApp clustered environment to the following storage media:

Tape device that is directly attached to a NAS file server

You can back up data to a tape device that is directly attached to a NAS file server. This is the preferred method. Typically, it is faster to back up data to a directly attached tape device than it is to back up data to an IBM Spectrum Protect storage pool by using a network connection.

Storage pool in the local IBM Spectrum Protect hierarchy

You can back up data to an IBM Spectrum Protect server, which stores the data in a storage pool of type DISK, FILE, or tape. The advantage of storing data in a storage pool is that you can replicate the data for added data protection. You can use existing storage pools or create storage pools. You must have a network connection between the NAS file server and the IBM Spectrum Protect server. The network connection must have sufficient bandwidth to transfer the NAS backup data. Tip: This type of backup is sometimes called a filer-to-server backup.

You can use one of the following backup methods:

Full cluster backup

When you apply this method, the backup data of the entire cluster is owned by a single IBM Spectrum Protect node. Even if you move the volumes within the cluster, full cluster backup operations continue and you do not have to reconfigure backup operations. This is the preferred method.

Partial cluster backup

When you apply this method, you specify a NetApp storage virtual machine (SVM), which determines the scope of the backup operation. The SVM is a virtual server that provides access to part of a cluster. You can specify that each SVM in the cluster backs up data to a separate IBM Spectrum Protect node. This method requires more configuration than the full cluster backup method, and it requires a network connection to transfer data from the SVM to the IBM Spectrum Protect node.

Restriction: You cannot use this method to back up data to a tape device because SVMs do not have direct access to tape devices.

### Procedure

1. Select the storage media based on the following questions:

Question	Storage media
Based on your business requirements, is it necessary to back up data to a local tape device?	If the answer is yes, use a directly attached tape device. If the answer is no, use either a directly attached tape device or a local IBM Spectrum Protect storage pool.

Question	Storage media
Does your organization require high-speed backup operations?	If the answer is yes, use a directly attached tape device.  If the answer is no, use either a directly attached tape device or a local IBM Spectrum Protect storage pool.
Does your organization have sufficient network bandwidth for NAS backup data?	If the answer is yes, use either a directly attached tape device or a local IBM Spectrum Protect storage pool.  If the answer is no, use a directly attached tape device.
Does your organization want to enhance data protection by using replication?	If the answer is yes, use a local IBM Spectrum Protect storage pool.  If the answer is no, use either a directly attached tape device or a local IBM Spectrum Protect storage pool.
Are your NAS file servers at remote locations without access to directly attached tape libraries?	If the answer is yes, use a local IBM Spectrum Protect storage pool.  If the answer is no, use either a directly attached tape device or a local IBM Spectrum Protect storage pool.

2. Select a backup method based on the following questions:

Question	Backup method
Based on your business requirements, is it necessary to back up data to a directly attached tape device?	If the answer is yes, use the full backup method.  If the answer is no, use either the full or partial backup method.
Does your system have sufficient network bandwidth to back up several SVMs without affecting network performance?	If the answer is yes, use either the full or partial backup method.  If the answer is no, use the full backup method. The partial backup method might adversely affect system performance.
Are the SVMs distributed across several organizations? For example, are any SVMs controlled by third parties, such as cloud-platform providers?	If the answer is yes, use the partial backup method because SVM owners can control backup operations for individual SVMs. If an SVM owner also owns an IBM Spectrum Protect server, the owner can set up backup operations from the SVM to a server node. In this way, the owner can control the end-to-end process.  If the answer is no, use either the full or partial backup method.

3. Configure the system environment based on the storage media and backup method that you chose. Follow the instructions for your selected method:

- Configuring full cluster backups to directly attached tape devices
- Configuring full cluster backups to an IBM Spectrum Protect server
- Configuring partial cluster backups to an IBM Spectrum Protect server

Tip: If you configured IBM Spectrum Protect to back up NetApp clusters by using node-scoped NDMP, consider reconfiguring IBM Spectrum Protect to use NDMP Cluster Aware Backup (CAB). In this way, you can optimize backup operations for NetApp clusters. Follow the instructions in Reconfiguring IBM Spectrum Protect to optimize clustered backups.

- **Configuring full cluster backups to directly attached tape devices**  
You can configure IBM Spectrum Protect to back up all volumes in a NetApp cluster to a directly attached tape device.
- **Configuring full cluster backups to an IBM Spectrum Protect server**  
You can configure IBM Spectrum Protect to back up all volumes in a NetApp cluster to an IBM Spectrum Protect server, which stores the data in a storage pool. Even if you move volumes within the cluster, backup operations continue and no reconfiguration is required.
- **Configuring partial cluster backups to an IBM Spectrum Protect server**  
You can configure IBM Spectrum Protect to complete a partial backup of a NetApp cluster. This method is useful when multiple organizations own data in the cluster. Each organization can manage backup operations for its data.
- **Reconfiguring IBM Spectrum Protect to optimize clustered backups**  
If you configured IBM Spectrum Protect to back up NetApp clusters by using node-scoped NDMP, you can reconfigure IBM Spectrum Protect to use NDMP Cluster Aware Backup (CAB). In this way, you can optimize backup operations for NetApp clusters.

## Configuring full cluster backups to directly attached tape devices

You can configure IBM Spectrum Protect™ to back up all volumes in a NetApp cluster to a directly attached tape device.

## Before you begin

---

For an overview of NDMP functionality in IBM Spectrum Protect and NetApp file servers, see technote 7046965. This technote also lists system requirements.

If the NetApp Clustered Data ONTAP 8.2 or later, or 9.1 or later, operating system is installed on your NetApp file server, use the following procedure. After you configure your NetApp file server to work with IBM Spectrum Protect, you can use the NetApp Cluster Aware Backup (CAB) extension to back up all volumes.

If the NetApp Clustered Data ONTAP 8.2 or later, or 9.1 or later, operating system is not installed on your NetApp file server, back up data by following the instructions in Configuring IBM Spectrum Protect for NDMP operations in a nonclustered environment.

## About this task

---

The preferred method is to back up the full cluster by using a node and data mover that are associated with the clusterwide network. In this way, you ensure that the backup data is owned by a single IBM Spectrum Protect node. Even if you move volumes within the cluster, backup operations continue and no reconfiguration is required.

## Procedure

---

To configure full cluster backup operations to a directly attached tape device, complete the following steps:

1. Verify that IBM Spectrum Protect Extended Edition is installed, and that the license is registered. If the license is not registered, issue the following IBM Spectrum Protect command:

```
register license file=tsmee.lic
```

2. Obtain cluster administrator privileges for the NetApp file server. This step is required to access the cluster console.
3. On the NetApp file server, enable the use of NDMP by following the instructions in the *Clustered Data ONTAP® Data Protection Tape Backup and Recovery Guide*. Complete the following steps:
  - a. Enable SVM-scoped NDMP backup operations at the cluster level. In this way, you disable node-scoped NDMP backup operations on the NAS file server. Ensure that the node-scoped-ndmp option on the NAS file server is set to OFF.
  - b. Create a backup user ID for NDMP operations.
  - c. Configure a network interface for NDMP control connections at the cluster level.
4. Register the IBM Spectrum Protect node that will own all backup data for the cluster. On the IBM Spectrum Protect server, issue the REGISTER NODE command:

```
register node node_name password domain=nas_domain type=nas
```

where *node\_name* specifies the node name, *password* specifies the node password, and *nas\_domain* specifies the domain of the node. Assign the node to a domain that has a policy to back up data to an appropriate storage pool.

5. Determine the IP address of the NetApp cluster management interface on the NAS file server. The interface provides access to the entire cluster. On the NAS file server, issue the following Data ONTAP operating system command:

```
network interface show -role cluster-mgmt
```

The IP address that is shown in the command output is required when you specify the HLADDRESS parameter in step 6.

6. Define a data mover for the IBM Spectrum Protect node that will own the backup data. On the IBM Spectrum Protect server, issue the DEFINE DATAMOVER command on one line:

```
define datamover data_mover_name type=nascluster  
hladdress=cluster_management_interface lladdress=port  
USER=user_name password=password dataformat=netappdump
```

where *cluster\_management\_interface* is the value that you obtained in step 5 and *data\_mover\_name* is the node name that you registered in step 4. For information about specifying the other parameters, see DEFINE DATAMOVER (Define a data mover).

Tip: After you define the data mover, additional data movers are defined automatically for each node in the cluster. The name of each data mover matches the name of the physical node in the cluster. You will use these data movers when you define paths to tape drives in step 3 of Configuring tape devices for full cluster backups.

## What to do next

---

To configure the tape device for the full cluster backup, follow the instructions in [Configuring tape devices for full cluster backups](#).

- [Configuring tape devices for full cluster backups](#)

If you plan to back up all volumes in a NetApp cluster to a directly attached tape device, you must configure the tape device.

**Related reference:**

[REGISTER NODE \(Register a node\)](#)

## Configuring full cluster backups to an IBM Spectrum Protect server

---

You can configure IBM Spectrum Protect™ to back up all volumes in a NetApp cluster to an IBM Spectrum Protect server, which stores the data in a storage pool. Even if you move volumes within the cluster, backup operations continue and no reconfiguration is required.

### Before you begin

---

For an overview of NDMP functionality in IBM Spectrum Protect and NetApp file servers, see [technote 7046965](#). This technote also lists system requirements.

If the NetApp Clustered Data ONTAP 8.2 or later, or 9.1 or later, operating system is installed on your NetApp file server, use the following procedure. After you configure your NetApp file server to work with IBM Spectrum Protect, you can use the NetApp Cluster Aware Backup (CAB) extension to back up all volumes in the cluster. All backed-up data will be owned by a single IBM Spectrum Protect node.

If the NetApp Clustered Data ONTAP 8.2 or later, or 9.1 or later, operating system is not installed on your NetApp file server, back up data by following the instructions in [Configuring IBM Spectrum Protect for NDMP operations in a nonclustered environment](#).

### Procedure

---

1. Verify that IBM Spectrum Protect Extended Edition is installed, and that the license is registered. If the license is not registered, issue the following IBM Spectrum Protect command:

```
register license file=tsmee.lic
```

2. Obtain cluster administrator privileges for the NetApp file server. This step is required to access the cluster console.
3. Enable the use of NDMP by following the instructions in the *Clustered Data ONTAP® Data Protection Tape Backup and Recovery Guide*. Complete the following steps:
  - a. Enable the NetApp SVM to control NDMP backup operations at the cluster level.
  - b. Create a backup user ID for NDMP operations.
  - c. Configure a network interface for NDMP control connections at the cluster level.
4. Register the IBM Spectrum Protect node that will own all backup data for the cluster. On the IBM Spectrum Protect server, issue the REGISTER NODE command:

```
register node node_name password domain=nas_domain type=nas
```

where *node\_name* specifies the node name, *password* specifies the node password, and *nas\_domain* specifies the domain of the node.

5. Determine the numerical IP address or the domain name that is used to access the NAS file server. The interface provides access to the entire cluster. On the NAS file server, issue the following Data ONTAP operating system command:

```
network interface show -role cluster-mgmt
```

The IP address in the output is required when you specify a value for the HLADDRESS parameter in step 6.

6. Define a data mover for the node by issuing the DEFINE DATAMOVER command and specifying TYPE=NASCLUSTER. On the IBM Spectrum Protect server, issue the following command on one line:

```
define datamover data_mover_name type=nascluster  
hladdress=cluster_management_interface lladdress=port  
USER=user_name password=password dataformat=netappdump
```

where *cluster\_management\_interface* is the value that you obtained in step 5 and *data\_mover\_name* is the node name that you registered in step 4. For information about specifying the other parameters, see [DEFINE DATAMOVER \(Define a data mover\)](#).

7. Configure an IBM Spectrum Protect policy for managing NAS image backups. Follow the instructions in Configuring an IBM Spectrum Protect policy for NDMP operations.
8. Update the cluster node that you registered in step 4 to the domain that was configured in step 7. On the IBM Spectrum Protect server, issue the UPDATE NODE command:

```
update node node_name domain=domain_name
```

9. Optional: Identify the volumes in the cluster and schedule backups for the volumes:
  - a. On the NAS file server, identify the volumes in the cluster by issuing the following Data ONTAP command:

```
volume show
```

- b. Schedule backup operations by following the instructions in Scheduling NDMP operations.

## What to do next

---

The following tasks are optional:

- To verify that volumes in the NetApp cluster are backed up, complete the following steps:
  1. On the Operations Center menu bar, click Clients.
  2. Double-click a NAS device client and click Volumes.
  3. To determine when the last full volume backup was completed, review the information in the Last Full column. To determine when the most recent differential backup was completed, review the information in the Last Differential column.
- To set up copy storage pools for added data protection, configure the tape-to-tape function to back up data. For instructions, see Backing up data with the tape-to-tape function.

### Related reference:

REGISTER NODE (Register a node)

## Configuring partial cluster backups to an IBM Spectrum Protect server

---

You can configure IBM Spectrum Protect™ to complete a partial backup of a NetApp cluster. This method is useful when multiple organizations own data in the cluster. Each organization can manage backup operations for its data.

## Before you begin

---

For an overview of NDMP functionality in IBM Spectrum Protect and NetApp file servers, see technote 7046965. This technote also lists system requirements.

If the NetApp Clustered Data ONTAP 8.2 or later, or 9.1 or later, operating system is installed on your NetApp file server, use the following procedure. After you configure your NetApp file server to work with IBM Spectrum Protect, you can use the NetApp Cluster Aware Backup (CAB) extension to back up a partial cluster. When you configure a partial cluster backup, you determine the scope of the backup by specifying a virtual server, the NetApp storage virtual machine (SVM). The SVM provides access to part of a cluster.

If the NetApp Clustered Data ONTAP 8.2 or later, or 9.1 or later, operating system is not installed on your NetApp file server, back up data by following the instructions in Configuring IBM Spectrum Protect for NDMP operations in a nonclustered environment.

## Procedure

---

1. Verify that IBM Spectrum Protect Extended Edition is installed, and that the license is registered. If the license is not registered, issue the following IBM Spectrum Protect command:

```
register license file=tsmee.lic
```

2. Obtain cluster administrator privileges for the NetApp file server. This step is required to access the cluster console.
3. On the NetApp file server, enable the use of NDMP by following the instructions in the *Clustered Data ONTAP® Data Protection Tape Backup and Recovery Guide*. Complete the following steps:
  - a. Enable the NetApp SVM to control NDMP backup operations.
  - b. Create a backup user ID for NDMP operations.
  - c. Configure a network interface for NDMP control connections at the SVM level.
4. Register the IBM Spectrum Protect node that will own the backed-up data. On the IBM Spectrum Protect server, issue the REGISTER NODE command:

```
register node node_name password domain=nas_domain type=nas
```

where *node\_name* specifies the node name, *password* specifies the node password, and *nas\_domain* specifies the domain of the node.

5. Determine the numerical IP address or the domain name of the cluster interface that is used by the SVM. To determine the value, on the NAS file server, issue the following ONTAP operating system command:

```
network interface show -vserver vserver_name -role data
```

where *vserver\_name* specifies the name of the SVM. This value that you obtain is required in step 6.

6. Define an associated data mover for the IBM Spectrum Protect node by issuing the DEFINE DATAMOVER command and specifying TYPE=NASVSERVER. On the IBM Spectrum Protect server, issue the following command on one line:

```
define datamover data_mover_name type=nasvserver  
hladdress=svm_data_interface lladdress=port  
USER=user_name password=password dataformat=netappdump
```

where *svm\_data\_interface* is the value that you obtained in step 5 and *data\_mover\_name* is the name of the node that you registered in step 4.

For information about specifying the other parameters, see DEFINE DATAMOVER (Define a data mover).

7. Configure an IBM Spectrum Protect policy for managing NAS image backups. Follow the instructions in Configuring an IBM Spectrum Protect policy for NDMP operations.
8. Update the node that you registered in step 4 to the domain that you configured in step 7. On the IBM Spectrum Protect server, issue the UPDATE NODE command:

```
update node node_name domain=domain_name
```

9. Optional: Identify the volumes in the cluster and schedule backup operations. Take the following steps:
  - a. On the NAS file server, identify the volumes in the cluster by issuing the following Data ONTAP command:

```
volume show -vserver vserver_name
```

where *vserver\_name* specifies the name of the SVM.

- b. Schedule backup operations by following the instructions in Scheduling NDMP operations.

## What to do next

---

To verify that volumes in the NetApp cluster are backed up, complete the following steps:

1. On the Operations Center menu bar, click Clients.
2. Double-click a NAS device client and click Volumes.
3. To determine when the last full volume backup was completed, review the information in the Last Full column. To determine when the most recent differential backup was completed, review the information in the Last Differential column.

### Related reference:

REGISTER NODE (Register a node)

## Reconfiguring IBM Spectrum Protect to optimize clustered backups

---

If you configured IBM Spectrum Protect™ to back up NetApp clusters by using node-scoped NDMP, you can reconfigure IBM Spectrum Protect to use NDMP Cluster Aware Backup (CAB). In this way, you can optimize backup operations for NetApp clusters.

## Before you begin

---

For an overview of NDMP functionality in IBM Spectrum Protect and NetApp file servers, see technote 7046965. This technote also lists system requirements.

## About this task

---

When you reconfigure IBM Spectrum Protect to use CAB, you can optimize backup operations in the following ways:

- You can configure IBM Spectrum Protect to back up all volumes in a NetApp cluster to a directly attached tape device or to an IBM Spectrum Protect server. In both cases, the data is owned by a single IBM Spectrum Protect node. Even if you move



volumes within the cluster, backup operations continue and no reconfiguration is required.

- You can complete a partial backup of a NetApp cluster to an IBM Spectrum Protect server. This method is useful when multiple organizations own data in the cluster. Each organization can manage backup operations for its data. You set the scope of a partial backup by specifying a NetApp storage virtual machine (SVM), which provides access to part of a cluster.

To reconfigure IBM Spectrum Protect to use CAB, you must define a new IBM Spectrum Protect node and a new data mover.

## Procedure

---

1. Verify that NetApp Clustered Data ONTAP 8.2 or later, or 9.1 or later, is installed on the NetApp file server.
2. Enable the use of NDMP by following the instructions in the *Clustered Data ONTAP® Data Protection Tape Backup and Recovery Guide*. Take one of the following actions:

For a full cluster backup

Complete the following steps:

- a. Enable SVM-scoped NDMP backup operations at the cluster level. In this way, you disable node-scoped NDMP backup operations on the NAS file server. Ensure that the node-scoped-ndmp option on the NAS file server is set to OFF.
- b. Create a backup user ID for NDMP operations.
- c. Configure a network interface for NDMP control connections at the cluster level.

For a partial cluster backup

Complete the following steps:

- a. Enable SVM-scoped NDMP to control NDMP backup operations.
- b. Create a backup user ID for NDMP operations.
- c. Configure a network interface for NDMP control connections at the SVM level.

3. Register the IBM Spectrum Protect node that will own the backup data. On the IBM Spectrum Protect server, issue the REGISTER NODE command:

```
register node node_name password password domain=nas_domain type=nas
```

where *node\_name* specifies the node name, *password* specifies the node password, and *nas\_domain* specifies the domain of the node.

4. If you plan to back up a full cluster, determine the IP address of the NetApp cluster management interface on the NAS file server. The interface provides access to the entire cluster. On the NAS file server, issue the following Data ONTAP operating system command:

```
network interface show -role cluster-mgmt
```

The IP address in the output is required when you specify the HLADDRESS parameter in step 6.

5. If you plan to back up a partial cluster, determine the numerical IP address or the domain name of the cluster interface that is used by the SVM. To determine the value, issue the following Data ONTAP operating system command on the NAS file server:

```
network interface show -vserver vserver_name -role data
```

where *vserver\_name* specifies the name of the SVM. The value that you obtain is required in step 6.

6. Define a data mover for the IBM Spectrum Protect node. Take one of the following actions:

For a full cluster backup

Define a data mover for the IBM Spectrum Protect node that will own the backup data. On the IBM Spectrum Protect server, issue the DEFINE DATAMOVER command on one line:

```
define datamover data_mover_name type=nascluster  
hladdress=cluster_management_interface lladdress=port  
USER=user_name password=password dataformat=netappdump
```

where *cluster\_management\_interface* is the value that you obtained in step 4 and *data\_mover\_name* is the node name that you registered in step 3.

Tip: After you define the data mover, additional data movers are defined automatically for each node in the cluster. The name of each data mover matches the name of the physical node in the cluster. You will use these data movers when you define paths to tape drives that are attached to the cluster.

For a partial cluster backup

Define a data mover for the node by issuing the DEFINE DATAMOVER command and specifying TYPE=NASVSERVER. On the IBM Spectrum Protect server, issue the following command on one line:

```
define datamover data_mover_name type=nasvserver
hladdress=svm_data_interface lladdress=port
USER=user_name password=password dataformat=netappdump
```

where *svm\_data\_interface* is the value that you obtained in step 5 and *data\_mover\_name* is the node name that you registered in step 3.

For information about specifying the other parameters on the DEFINE DATAMOVER command, see DEFINE DATAMOVER (Define a data mover).

7. To back up data to a directly attached tape device, for each tape drive that is attached to the cluster, identify the device name and the physical node to which the drive is attached:

- a. On the NAS file server, issue the following Data ONTAP command:

```
storage tape show-tape-drive
```

- b. Review the output to find the serial number of the tape drive, and the node of the cluster to which the drive is attached. The same stanza includes the device name, for example, *st1*, *st2*, or *st3*.

8. To configure a full cluster backup to a directly attached tape device, follow the instructions in Configuring tape devices for full cluster backups.
9. To configure a full or partial cluster backup to an IBM Spectrum Protect server, configure a policy for managing NAS image backups. Follow the instructions in Configuring an IBM Spectrum Protect policy for NDMP operations.
10. Disable scheduled backup operations for all nodes that were previously used to back up the NetApp cluster.
11. Identify the volumes in the cluster and optionally schedule backup operations for the volumes. Take one of the following actions:

For a full cluster backup

- a. On the NAS file server, identify the volumes in the cluster by using the following Data ONTAP command:

```
volume show
```

- b. Run a full backup of the entire cluster.
- c. Optional: To schedule backup operations, follow the instructions in Scheduling NDMP operations.

For a partial cluster backup

- a. On the NAS file server, identify the volumes in the cluster by using the following Data ONTAP command:

```
volume show -vserver vserver_name
```

where *vserver\_name* specifies the name of the SVM.

- b. Run a full backup of the partial cluster.
- c. Optional: To schedule backup operations, follow the instructions in Scheduling NDMP operations.

## What to do next

---

To verify that volumes in the NetApp cluster are backed up, complete the following steps:

1. On the Operations Center menu bar, click Clients.
2. Double-click a NAS device client and click Volumes.
3. To determine when the last full volume backup was completed, review the information in the Last Full column. To determine when the most recent differential backup was completed, review the information in the Last Differential column.

### Related reference:

DEFINE DATAMOVER (Define a data mover)  
DEFINE PATH (Define a path when the destination is a drive)  
REGISTER NODE (Register a node)

## Backing up and restoring NAS file servers using NDMP

---

After you configure IBM Spectrum Protect™ for NDMP operations, you are ready to begin using NDMP.

### Procedure

---

Use either a client interface or an administrative interface to perform a file system image backup. For example, to use the Windows backup-archive client interface to back up a file system that is named */vol/vol1* on a NAS file server that is named *NAS1*, issue the following command:

```
dsmc backup nas -nasnodename=nas1 {/vol/vol1}
```

For more information about the command, see Backup Image.

Tip: Whenever you use the client interface, you are asked to authenticate yourself as an IBM Spectrum Protect administrator before the operation can begin. The administrator ID must have at least client owner authority for the NAS node.

You can complete the same backup operation with a server interface. For example, from the administrative command-line client, back up the file system that is named /vol/vol1 on a NAS file server that is named NAS1, by issuing the following command:

```
backup node nas1 /vol/vol1
```

Restriction: The BACKUP NAS and BACKUP NODE commands do not include snapshots. To back up snapshots, see Backing up and restoring with snapshots.

You can restore the image by using either interface. Backups are identical whether they are backed up using a client interface or a server interface. For example, suppose that you want to restore the image that is backed up in the previous examples. For this example, the file system that is named /vol/vol1 is being restored to /vol/vol2. Restore the file system with the following command, issued from a Windows backup-archive client interface:

```
dsmc restore nas -nasnodename=nas1 {/vol/vol1} {/vol/vol2}
```

You can choose to restore the file system by using a server interface. For example, to restore the file system name /vol/vol1 to file system /vol/vol2, for a NAS file server that is named NAS1, enter the following command:

```
restore node nas1 /vol/vol1 /vol/vol2
```

You can restore data from one NAS vendor system to another NAS vendor system when you use the NDMPDUMP data format. However, you must either verify compatibility between systems or maintain a separate storage pool for each NAS vendor.

- NAS file servers: backups to a single IBM Spectrum Protect server  
If you have several NAS file servers in different locations, you might prefer to send the backup data to a single IBM Spectrum Protect server rather than attaching a tape library to each NAS device.
- Backing up NDMP file servers to an IBM Spectrum Protect server  
You can back up data to a single IBM Spectrum Protect server rather than attaching a tape library to each NAS device.

## NAS file servers: backups to a single IBM Spectrum Protect server

---

If you have several NAS file servers in different locations, you might prefer to send the backup data to a single IBM Spectrum Protect™ server rather than attaching a tape library to each NAS device.

When you store NAS backup data in the IBM Spectrum Protect server's storage hierarchy, you can apply IBM Spectrum Protect back-end data management functions. In this way, you can take advantage of migration, reclamation, disaster recovery, and other features.

To back up a NAS device to an IBM Spectrum Protect native storage pool, set the destination storage pool in the copy group to point to the wanted native storage pool. The destination storage pool provides the information about the library and drives that are used for backup and restore. You must ensure that there is sufficient space in your target storage pool to contain the NAS data, which can be backed up to sequential, disk, or file type devices. Defining a separate device class is not necessary.

If you are creating a table of contents, a management class must be specified with the TOCDESTINATION parameter in the DEFINE and UPDATE COPYGROUP commands. When you back up a NAS file server to IBM Spectrum Protect native pools, the TOCDESTINATION can be the same as the destination of the data that is backed up by using NDMP.

Firewall considerations are more stringent than they are for filer-to-attached-library because communications can be initiated by either the IBM Spectrum Protect server or the NAS file server. NDMP tape servers run as threads within the IBM Spectrum Protect server and the tape server accepts connections on port of 10001. This port number can be changed through the following option in the IBM Spectrum Protect server options file: NDMPPORTRANGE port-number-low, port-number-high.

During NDMP filer-to-server backup operations, you can use the NDMPREFDATAINTERFACE option to specify which network interface the IBM Spectrum Protect server uses to receive backup data. The value for this option is a host name or IPV4 address that is associated with one of the active network interfaces of the system on which the IBM Spectrum Protect server is running. This interface must be IPV4 enabled.

Before you use this option, verify that your NAS device supports NDMP operations that use a different network interface for NDMP control and NDMP data connections. NDMP control connections are used by IBM Spectrum Protect to authenticate with an NDMP server and monitor an NDMP operation while NDMP data connections are used to transmit and receive back up data during NDMP operations. You must still configure your NAS device to route backup and restore data to the appropriate network interface.

When enabled, the NDMPREFDATAINTERFACE option affects all subsequent NDMP filer-to-server operations. It does not affect NDMP control connections because they use the system's default network interface. You can update this server option without stopping and restarting the server by using the SETOPT command.

NetApp file servers provide an NDMP option (ndmpd.preferred\_interface) to change the interface that is used for NDMP data connections. For more information, see the documentation for your NAS device.

For instructions about completing NDMP filer-to-server backup operations, see Backing up NDMP file servers to an IBM Spectrum Protect server.

For information about server options, see Server options.

## Backing up NDMP file servers to an IBM Spectrum Protect server

---

You can back up data to a single IBM Spectrum Protect™ server rather than attaching a tape library to each NAS device.

### Procedure

---

To back up a server on a NAS file system, complete the following steps:

1. Select an existing storage pool or set up a storage pool for the NAS data by issuing the following command:

```
define stgpool naspool disk
```

2. Define volumes to add to the storage pool. For example, define a volume that is named naspool\_volAB:

```
define volume naspool /usr/storage/naspool_volAB formatsize=100
```

3. Set the copy destination to the storage pool defined previously and activate the associated policy set.

```
update copygroup standard standard standard destination=naspool  
tocdestination=naspool  
activate policyset standard standard
```

The destination for NAS data is determined by the destination in the copy group. The storage size estimate for NAS differential backups uses the occupancy of the file space, the same value that is used for a full backup. You can use this size estimate as one of the considerations in choosing a storage pool. One of the attributes of a storage pool is the MAXSIZE value, which indicates that data is sent to the NEXT storage pool when the MAXSIZE value is exceeded by the estimated size. Because NAS differential backups to IBM Spectrum Protect native storage pools use the base file space occupancy size as a storage size estimate, differential backups end up in the same storage pool as the full backup. Depending on collocation settings, differential backups might end up on the same media as the full backup.

4. Set up a node and data mover for the NAS device. The data format signifies that the backup images created by this NAS device are a dump type of backup image in a NetApp specific format.

```
register node nas1 nas1 type=nas domain=standard  
define datamover nas1 type=nas hla=nas1 user=root  
password=***** dataformat=netappdump
```

The NAS device is now ready to be backed up to an IBM Spectrum Protect server storage pool. Paths can be defined to local drives, but the destination that is specified by the management class determines the target location for this backup operation.

5. Back up the NAS device to the IBM Spectrum Protect storage pool by issuing the following command:

```
backup node nas1 /vol/vol0
```

6. Restore a NAS device from the IBM Spectrum Protect storage pool by issuing the following command:

```
restore node nas1 /vol/vol0
```

## File-level backup and restore for NDMP operations

---

When you back up data by using NDMP, you can specify that the IBM Spectrum Protect™ server collects and stores file-level information in a table of contents (TOC).

If you specify this option at the time of backup, you can later display the TOC of the backup image. Through the backup-archive web client, you can select individual files or directories to restore directly from the backup images generated.

Collecting file-level information requires extra processing time, network resources, storage pool space, temporary database space, and possibly additional storage device interaction. For instructions about configuring storage devices, see [Configuring storage devices](#). You must consider dedicating more space in the IBM Spectrum Protect server database. You must set up policy so that the IBM Spectrum Protect server stores the TOC in a different storage pool from the one where the backup image is stored. The TOC is treated like any other object in that storage pool.

You can also do a backup by using NDMP without collecting file-level restore information.

To allow creation of a TOC for a backup by using NDMP, you must define the TOCDESTINATION attribute in the backup copy group for the management class to which this backup image is bound. You cannot specify a copy storage pool or an active-data pool as the destination. The storage pool that you specify for the TOC destination must have a data format of either NATIVE or NONBLOCK, so it cannot be the tape storage pool that is used for the backup image.

If you choose to collect file-level information, specify the TOC parameter in the BACKUP NODE server command. Or, if you initiate your backup by using the client, you can specify the TOC option in the client options file, client option set, or client command line. You can specify NO, PREFERRED, or YES. When you specify PREFERRED or YES, the IBM Spectrum Protect server stores file information for a single NDMP-controlled backup in a TOC. The TOC is placed into a storage pool. After that, the IBM Spectrum Protect server can access the TOC so that file and directory information can be queried by the server or client. Use of the TOC parameter allows a TOC to be generated for some images and not others, without requiring different management classes for the images.

For more information about the BACKUP NODE command, see [BACKUP NODE \(Back up a NAS node\)](#).

To avoid mount delays and ensure sufficient space, use random access storage pools (DISK device class) as the destination for the TOC. For sequential access storage pools, no labeling or other preparation of volumes is necessary if scratch volumes are allowed.

For more information, see [Managing tables of contents](#).

- **Interfaces for file-level restore operations**  
When you restore individual files and directories, you have the choice of using one of two interfaces to initiate the restore: the backup-archive web client or the server interface.
- **International characters for NetApp file servers**  
All systems that create or access data on a particular NAS file server volume must do so in a manner compatible with the volume language setting.
- **File-level restore operations from a directory-level backup image**  
File-level restore operations are supported for directory-level backup images.

## Interfaces for file-level restore operations

---

When you restore individual files and directories, you have the choice of using one of two interfaces to initiate the restore: the backup-archive web client or the server interface.

Restore operations by using the backup-archive web client

The backup-archive web client requires that a TOC exists to restore files and directories. The web client must be on a Windows system. The IBM Spectrum Protect™ server accesses the TOC from the storage pool and loads TOC information into a temporary database table. Then, you can use the backup-archive web client to examine directories and files that are contained in one or more file system images, and select individual files or directories to restore directly from the backup images generated.

Restore operations by using the server interface

- If you have a TOC, use the QUERY NASBACKUP command to display information about backup images that are generated by NDMP and to see which images have a corresponding TOC. Then, use the RESTORE NODE command with the FILELIST parameter.
- If you did not create a TOC, the contents of the backup image cannot be displayed. You can restore individual files, directories, or both if you know the name of the file or directory, and in which image the backup is located. Use the RESTORE NODE command with the FILELIST parameter.

## International characters for NetApp file servers

---

All systems that create or access data on a particular NAS file server volume must do so in a manner compatible with the volume language setting.

You must install Data ONTAP 6.4.1 or later, if it is available, on your NetApp NAS file server to garner full support of international characters in the names of files and directories.

If your level of Data ONTAP is earlier than 6.4.1, you must have one of the following two configurations to collect and restore file-level information. Results with configurations other than the two listed are unpredictable. The IBM Spectrum Protect™ server issues a warning message (ANR4946W) during backup operations. The message indicates that the character encoding of NDMP file history messages is unknown, and UTF-8 is assumed to build a table of contents. It is safe to ignore this message only for the following two configurations.

- Your data has directory and file names that contain only English (7-bit ASCII) characters.
- Your data has directory and file names that contain non-English-language characters and the volume language is set to the UTF-8 version of the proper locale (for example, `de.UTF-8` for German).

If your level of Data ONTAP is 6.4.1 or later, you must have one of the following three configurations to collect and restore file-level information. Results with configurations other than the three listed are unpredictable.

- Your data has directory and file names that contain only English (7-bit ASCII) characters and the volume language is either not set or is set to one of the following values:
  - `C` (POSIX)
  - `en`
  - `en_US`
  - `en.UTF-8`
  - `en_US.UTF-8`
- Your data has directory and file names that contain non-English-language characters, and the volume language is set to the proper locale (for example, `de.UTF-8` or `de` for German).  
Tip: Using the UTF-8 version of the volume language setting is more efficient in terms of IBM Spectrum Protect server processing and table of contents storage space.
- You use CIFS only to create and access your data.

## File-level restore operations from a directory-level backup image

---

File-level restore operations are supported for directory-level backup images.

As with a NAS file system backup, a table of contents (TOC) is created during a directory-level backup and you are able to browse the files in the image by using the web client. The default is that the files are restored to the original location. During a file-level restore from a directory-level backup, however, you can either select a different file system or another virtual file space name as a destination.

For a TOC of a directory-level backup image, the path names for all files are relative to the directory that is specified in the virtual file space definition, not the root of the file system.

## Directory-level backup and restore operations

---

If you have a large NAS file system, initiating a backup at a directory level reduces backup and restore times and provides more flexibility in configuring NAS backups. By defining virtual file spaces, a file system backup can be partitioned among several NDMP backup operations and multiple tape drives. You can also use different backup schedules to back up subtrees of a file system.

The virtual file space name cannot be identical to any file system on the NAS node. If a file system is created on the NAS device with the same name as a virtual file system, a name conflict occurs on the IBM Spectrum Protect™ server when the new file space is backed up. For instructions about issuing commands for mapping virtual file spaces, see `DEFINE VIRTUALFSMAPPING` (Define a virtual file space mapping).

Restriction: Virtual file space mappings are supported only for NAS nodes.

- Directory-level backup and restore for NDMP operations  
The `DEFINE VIRTUALFSMAPPING` command maps a directory path of a NAS file server to a virtual file space name on the IBM Spectrum Protect server. After a mapping is defined, you can conduct NAS operations such as `BACKUP NODE` and `RESTORE NODE` by using the virtual file space names as if they were actual NAS file spaces.
- Backing up and restoring with snapshots  
NDMP directory-level backup operations give you the ability to back up user-created snapshots of a NAS file system. Those snapshots are then stored as subdirectories. The snapshots can be taken at any time, and the backup to tape can be deferred to a more convenient time.

## Directory-level backup and restore for NDMP operations

---

The DEFINE VIRTUALFSMAPPING command maps a directory path of a NAS file server to a virtual file space name on the IBM Spectrum Protect™ server. After a mapping is defined, you can conduct NAS operations such as BACKUP NODE and RESTORE NODE by using the virtual file space names as if they were actual NAS file spaces.

To start a backup of the directory, issue the BACKUP NODE command and specify the virtual file space name instead of a file space name. To restore the directory subtree to the original location, run the RESTORE NODE command and specify the virtual file space name.

Virtual file space definitions can also be specified as the destination in a RESTORE NODE command. In this way, you can restore backup images (either file system or directory) to a directory on any file system of the NAS device.

You can use the web client to select files for restore from a directory-level backup image because the IBM Spectrum Protect client treats the virtual file space names as NAS file spaces.

## Backing up and restoring with snapshots

---

NDMP directory-level backup operations give you the ability to back up user-created snapshots of a NAS file system. Those snapshots are then stored as subdirectories. The snapshots can be taken at any time, and the backup to tape can be deferred to a more convenient time.

### Procedure

---

For example, to back up a snapshot that is created for a NetApp file system, complete the following steps:

1. On the console for the NAS device, issue the command to create the snapshot. SNAP CREATE is the command for a NetApp device.

```
snap create vol2 february17
```

This example creates a snapshot that is named FEBRUARY 17 of the /vol/vol2 file system. The physical location for the snapshot data is in the directory /vol/vol2/.snapshot/february17. The stored location for snapshot data depends on the NAS vendor implementation. For NetApp, the SNAP LIST command can be used to display all snapshots for a file system.

2. Define a virtual file space mapping definition on the IBM Spectrum Protect™ server for the snapshot data that is created in the previous step.

```
define virtualfsmapping nas1 /feb17snapshot /vol/vol2 /.snapshot/february17
```

This example creates a virtual file space mapping definition named /feb17snapshot.

3. Back up the virtual file space mapping.

```
backup node nas1 /feb17snapshot mode=full toc=yes
```

4. After the backup is created, you can either restore the entire snapshot image or restore an individual file. Before you restore the data, you can create a virtual file space mapping name for the target directory. You can select any file system name as a target. The target location in this example is the directory /feb17snaprestore on the file system /vol/vol1.

```
define virtualfsmapping nas1 /feb17snaprestore /vol/vol1 /feb17snaprestore
```

5. Restore the snapshot backup image.

```
restore node nas1 /feb17snapshot /feb17snaprestore
```

This example restores a copy of the /vol/vol2 file system to the directory /vol/vol1/feb17snaprestore in the same state as when the snapshot was created in the first step.

## Backup and restore operations by using the NetApp SnapMirror to Tape feature

---

You can back up large NetApp file systems by using the NetApp SnapMirror to Tape feature (also known as SMTape). Using a block-level copy of data for backup, the SnapMirror to Tape method is faster than a traditional NDMP full backup and can be used when NDMP full backups are impractical.



Use the NDMP SnapMirror to Tape feature as a disaster recovery option for copying large NetApp file systems to auxiliary storage. For most NetApp file systems, use the standard NDMP full or differential backup method.

By specifying a parameter on the BACKUP NODE and RESTORE NODE commands, you can back up and restore file systems by using SnapMirror to Tape. There are several limitations and restrictions on how SnapMirror images can be used. Consider the following guidelines before you use it as a backup method:

- If you installed NetApp ONTAP 8.2 or later, you must define a data mover of type NASCLUSTER or NASVSERVER for SnapMirror to Tape operations.
- You cannot initiate a SnapMirror to Tape backup or restore operation from the IBM Spectrum Protect™ Operations Center, web client, or command-line client.
- You cannot perform differential backups of SnapMirror images.
- You cannot perform a directory-level backup by using SnapMirror to Tape. Therefore, IBM Spectrum Protect does not permit SnapMirror to Tape backup operations on a server virtual file space.
- You cannot perform an NDMP file-level restore operation from SnapMirror to Tape images. Therefore, a table of contents is never created during SnapMirror to Tape image backups.
- At the start of a SnapMirror to Tape copy operation, the file server generates a snapshot of the file system. NetApp provides an NDMP environment variable to control whether this snapshot is removed at the end of the SnapMirror to Tape operation. IBM Spectrum Protect always sets this variable to remove the snapshot.
- After a SnapMirror to Tape image is retrieved and copied to a NetApp file system, the target file system remains configured as a SnapMirror partner. NetApp provides an NDMP environment variable to control whether this SnapMirror relationship should be broken. IBM Spectrum Protect always "breaks" the SnapMirror relationship during the retrieval. After the restore operation is complete, the target file system is in the same state as that of the original file system at the time of backup.

For more information about the SnapMirror to Tape feature, see BACKUP NODE (Back up a NAS node) and RESTORE NODE (Restore a NAS node).

## NDMP backup operations using Celerra file server-integrated checkpoints

---

When the IBM Spectrum Protect™ server initiates an NDMP backup operation on a Celerra data mover, the backup of a large file system might take several hours to complete. Without Celerra integrated checkpoints, any changes that occur on the file system are written to the backup image.

As a result, the backup image includes changes that are made to the file system during the entire backup operation. The backup image is not a true point-in-time image of the file system.

If you are performing NDMP backup operations from Celerra file servers, upgrade the operating system of your data mover to Celerra file server version T5.5.25.1 or later. This version of the operating system allows enablement of integrated checkpoints for all NDMP backup operations from the Celerra Control Workstation. By enabling this feature, you ensure that the backup data represents true point-in-time images of the file system that is being backed up.

For instructions about enabling integrated checkpoints during all NDMP backup operations, see the Celerra file server documentation.

If your version of the Celerra file server operating system is earlier than version T5.5.25.1 and if you use NDMP to back up Celerra data movers, manually generate a snapshot of the file system by using Celerra's command-line checkpoint feature. Then, initiate an NDMP backup operation for the checkpoint file system rather than the original file system.

For instructions about creating and scheduling checkpoints from the Celerra control workstation, see the Celerra file server documentation.

## Replicating NAS nodes

---

You can replicate a NAS node that uses NDMP for backup operations. Before you configure the replication operation, review the restrictions that apply.

### About this task

---

Restrictions:



- The backup data must be in a storage pool with the NATIVE data format. You cannot replicate backup data in storage pools that have the following data formats:
  - NETAPPDUMP
  - CELERRADUMP
  - NDMPDUMP
- A differential backup can be replicated only if its full backup is replicated.

## Procedure

---

1. Enable the NAS node for replication by issuing the UPDATE NODE command:

```
update node node_name replstate=enabled
```

where *node\_name* specifies the name of the NAS node.

2. Replicate the node by issuing the REPLICATE NODE command:

```
replicate node node_name
```

where *node\_name* specifies the name of the NAS node.

3. To ensure that the replicated data can be restored, define a data mover on the target server for the node by issuing the DEFINE DATAMOVER command:

```
define datamover node_name type=nas hladdress=hl_address lladdress=ll_address  
  userid=user_id password=user_password dataformat=netappdump
```

where:

*node\_name*

Specifies the name of the NAS node.

*hl\_address*

Specifies either the numerical IP address or the domain name that is used to access the NAS file server.

*ll\_address*

Specifies the TCP port number to access the NAS device for NDMP sessions.

*user\_id*

Specifies the ID of a user who is authorized to initiate an NDMP session with the NAS file server.

*user\_password*

Specifies the password of the user who is authorized to initiate an NDMP session with the NAS file server.

## Results

---

The format of the backup data does not change during the replication process. If backup data is replicated, its associated table of contents is also replicated.

## Data protection by using the NetApp SnapLock licensed feature

---

You can use the NetApp SnapLock licensed feature to meet strict regulatory requirements for archived data. When you enable the SnapLock feature, you can use IBM Spectrum Protect™ to set a retention date for files and to commit a file to a Write Once Read Many (WORM) state.

Data that is stored with a retention date cannot be deleted from the file system before the retention period expires. The SnapLock feature can be used by IBM Spectrum Protect servers only if the servers are enabled for data retention protection.

Data that is archived by data retention protection servers and stored to NetApp NAS file servers is stored as IBM Spectrum Protect FILE volumes. At the end of a write transaction, a retention date is set for the FILE volume, through the SnapLock interface. This date is calculated by using the RETVER and RETMIN parameters of the archive copy group that is used when you archive the data. By associating a retention date with the FILE volume, the FILE volume does not destroy or overwrite the data until the retention date passes. These FILE volumes are referred to as WORM FILE volumes. After a retention date is set, the WORM FILE volume cannot be deleted until the retention date passes. IBM Spectrum Protect for Data Retention combined with WORM FILE volume reclamation ensures protection for the life of the data.

Storage pools can be managed either by threshold or by data retention period. The RECLAMATIONTYPE storage pool parameter indicates that a storage pool is managed based on a data retention period. When a traditional storage pool is queried with the FORMAT=DETAILED parameter, this output is displayed:

Reclamation Type: THRESHOLD

If an IBM Spectrum Protect server is enabled with data retention protection through IBM Spectrum Protect for Data Retention, and the server has access to a NetApp filer with the SnapLock licensed feature, you can define a storage pool with the RECLAMATIONTYPE parameter set to SNAPLOCK. This means that data that is created on volumes in this storage pool is managed by retention date. When a SnapLock storage pool is queried with the FORMAT=DETAILED parameter, the output indicates that the storage pools are managed by data retention period:

Reclamation Type: SNAPLOCK

For more information about the SnapLock filer, see the NetApp documentation *Data ONTAP Archive and Compliance Management Guide for 7-Mode*.

Attention: Do not use this feature to protect data with a retention period of less than three months.

- Reclamation and the SnapLock feature  
To help ensure that data is always protected, set the NetApp default retention period to 30 days to match the default reclamation period of the WORM FILE volume. IBM Spectrum Protect reclaims any remaining data on a WORM FILE volume just before the retention date expiration.
- Retention periods  
IBM Spectrum Protect policies manage the retention time for the WORM FILE volume. The retention of some files might exceed the retention time for the WORM FILE volume that they are stored on. You might need to move some files to another volume to ensure that the files are stored on WORM media.
- Configuration of the SnapLock feature for event-based retention  
Data that is stored in SnapLock volumes that are managed by IBM Spectrum Protect for Data Retention and event-based retention can result in excessive reclamation, which causes performance degradation of the server.
- Continuous data protection with the SnapLock feature  
If data is stored on a volume with the SnapLock feature enabled, and the data is moved or copied to a non-SnapLock volume, the data loses the unique hardware protection that is provided by NetApp WORM volumes.
- Setting up SnapLock volumes as IBM Spectrum Protect WORM FILE volumes  
To meet strict requirements for archived data, enable the NetApp SnapLock feature.

## Reclamation and the SnapLock feature

---

To help ensure that data is always protected, set the NetApp default retention period to 30 days to match the default reclamation period of the WORM FILE volume. IBM Spectrum Protect™ reclaims any remaining data on a WORM FILE volume just before the retention date expiration.

The reclamation of a WORM FILE volume to another WORM FILE volume before the retention date expiration helps to ensure that data is always protected by the SnapLock feature.

Because this protection is at an IBM Spectrum Protect volume level, the data on the volumes can be managed by IBM Spectrum Protect policy without consideration of where the data is stored. Data that is stored on WORM FILE volumes is protected both by data retention protection and by the retention period that is stored with the physical file on the SnapLock volume. If an IBM Spectrum Protect administrator issues a command to delete the data, the command fails. If someone attempts to delete the file by using a series of network file system calls, the SnapLock feature prevents the data from being deleted.

During reclamation processing, if the IBM Spectrum Protect server cannot move data from an expiring SnapLock volume to a new SnapLock volume, a warning message is issued.

## Retention periods

---

IBM Spectrum Protect™ policies manage the retention time for the WORM FILE volume. The retention of some files might exceed the retention time for the WORM FILE volume that they are stored on. You might need to move some files to another volume to ensure that the files are stored on WORM media.

Some objects on the volume might need to be retained longer than other objects on the volume for the following reasons:

- The objects are bound to management classes with different retention times.
- The objects cannot be removed because of a deletion hold.
- The objects are waiting for an event to occur before expiration.
- The retention period for a copy group is increased, requiring a longer retention time than the time that is specified in the SnapLock feature when the WORM FILE volume was committed.

To manage a WORM FILE volume by retention time, you must issue the DEFINE STGPOOL command and specify RECLAMATIONTYPE=SNAPLOCK. In this way, you define a storage pool as a SnapLock storage pool. After that, you cannot update the RECLAMATIONTYPE parameter to a value of THRESHOLD. When you define a SnapLock storage pool, the system verifies that the specified directories are in the device class are SnapLock WORM volumes. When a file class is defined and storage pools are created with the reclamation type of SNAPLOCK, all volumes must be WORM volumes or the operation fails. If a device class is updated to contain extra directories and SnapLock storage pools are assigned to the device class, the same check is made to ensure that all directories are SnapLock WORM volumes.

Three retention periods are available for the NetApp SnapLock feature. The retention periods must be configured correctly so that the IBM Spectrum Protect server can properly manage WORM data that is stored in SnapLock volumes. The IBM Spectrum Protect server sets the retention period for data that is stored on NetApp SnapLock volumes based on the values in the copy group for the data that is archived. The NetApp file server must not conflict with the ability of the IBM Spectrum Protect server to set the retention period. The preferred method is to configure the following settings for retention periods in the NetApp file server:

- Minimum Retention Period. Set the higher value: either 30 days or the minimum number of days that is specified by any copy group (by using a NetApp SnapLock file server for WORM FILE storage) for the data retention period. The copy group is the one in use that stores data on NetApp SnapLock volumes.
- Maximum Retention Period. Leave the default value of 30 years. This retention period allows the IBM Spectrum Protect server to set the actual volume retention period based on the settings in the archive copy group.
- Default Retention Period. Set to 30 days. If you do not set this value and you do not set the maximum retention period, each volume's retention period is set to 30 years. If this occurs, the IBM Spectrum Protect server cannot manage expiration and reuse of NetApp SnapLock volumes. As a result, no volume can be reused for 30 years.

With the NetApp SnapLock retention periods set, IBM Spectrum Protect can manage the data in SnapLock storage pools with maximum efficiency. For each volume that is in a SNAPLOCK storage pool, an IBM Spectrum Protect reclamation period is created. The IBM Spectrum Protect reclamation period has a start date, BEGIN RECLAIM PERIOD, and an end date, END RECLAIM PERIOD. You can view these dates by issuing the QUERY VOLUME command with the FORMAT=DETAILED parameter on a SnapLock volume. The output is similar to this example:

```
Begin Reclaim Period: 09/05/2017
End Reclaim Period: 10/06/2017
```

When IBM Spectrum Protect archives files to a SnapLock volume, the server tracks the latest expiration date of those files, and the BEGIN RECLAIM PERIOD value is set to that latest expiration date. When more files are added to the SnapLock volume, the starting date is set to that later date if you have a file with a later expiration date than the one currently on the volume. The start date is set to the latest expiration date for any file on that volume. The expectation is that all files on that volume are already either expired, or are expiring on that day. On the following day, no valid data remains on that volume.

The END RECLAIM PERIOD is set to a month later than the BEGIN RECLAIM PERIOD. The retention date set in the NetApp file server for that volume is set to the END RECLAIM PERIOD date. The NetApp file server prevents deletion of that volume until the END RECLAIM PERIOD date is reached. This date is approximately a month after the data has expired in the IBM Spectrum Protect server. When the IBM Spectrum Protect server calculates an END RECLAIM PERIOD date for a volume, and the date is later than the current END RECLAIM PERIOD, the date is reset in the NetApp file server for that volume to the later date. Resetting the data to a later date guarantees that the IBM Spectrum Protect WORM FILE volume is not deleted until all data on the volume expires, or the data is moved to another SnapLock volume.

The IBM Spectrum Protect reclamation period is the amount of time between the begin date and the end date. During the reclamation period, the IBM Spectrum Protect server deletes volumes on which all the data is expired, or moves files that are not expired on expiring SnapLock volumes to new SnapLock volumes with new dates. This month is critical to how the server safely and efficiently manages the data on WORM FILE volumes. Data on a SnapLock volume typically expires by the time the beginning date arrives, and the volume must be empty. When the end date arrives, the volume can be safely deleted from the IBM Spectrum Protect inventory and the SnapLock file server.

However, some events might cause valid data to be on a SnapLock volume:

- Expiration processing in the IBM Spectrum Protect server for that volume might be delayed or is incomplete.
- The retention parameters on the copy group or associated management classes might be altered for a file after it was archived, and that file is not going to expire for some time.
- A deletion hold might be placed on one or more of the files on the volume.
- Reclamation processing is either disabled or is encountering errors by moving data to new SnapLock volumes on a SnapLock storage pool.
- A file is waiting for an event to occur before the IBM Spectrum Protect server can begin the expiration of the file.

When the beginning date arrives and files are not expired on a SnapLock volume, the files must be moved to a new SnapLock volume with a new begin and end date. However, if expiration processing is delayed on the IBM Spectrum Protect server, and

those files expire when expiration processing on the IBM Spectrum Protect server runs, it is inefficient to move those files to a new SnapLock volume. To ensure that unnecessary data movement does not occur for files that are due to expire, movement of files on expiring SnapLock volumes will be delayed by a number of days after the BEGIN RECLAIM PERIOD date. Since the data is protected in the SnapLock file server until the END RECLAIM PERIOD date, there is no risk to the data in delaying this movement. This allows IBM Spectrum Protect expiration processing to finish. After that number of days, if valid data is on an expiring SnapLock volume, the data is moved to a new SnapLock volume, thus continuing the protection of the data.

Since the data was initially archived, there might be changes in the retention parameters for that data (for example, changes in the management class or copy pool parameters) or there might be a deletion hold on that data. However, the data on that volume is protected by SnapLock only until the END RECLAIM PERIOD date. Data that is not expired is moved to new SnapLock volumes during the IBM Spectrum Protect reclamation period. If errors occur when data is moved to a new SnapLock volume, a warning message is issued indicating that the data will soon be unprotected. If the error persists, issue a MOVE DATA command for the problem volume.

Attention: Do not disable reclamation processing on a SnapLock storage pool. After the processing is disabled, the IBM Spectrum Protect server has no way to issue warning messages that data will become unprotected. This situation can also occur if reclamation and migration are disabled for the entire server (for example, NOMIGRRECL set in the server options file). Ensure that your data is protected when you manage SnapLock storage pools.

## Configuration of the SnapLock feature for event-based retention

---

Data that is stored in SnapLock volumes that are managed by IBM Spectrum Protect™ for Data Retention and event-based retention can result in excessive reclamation, which causes performance degradation of the server.

If data is managed by event-based retention, IBM Spectrum Protect initially sets the retention period to the greater of the RETVER and RETMIN values for the archive copy group. When the volume enters the reclamation period and data that remains on the volume is moved, the retention period for the target volume is set to the remaining retention period of the data, which is typically 0. The new volume then enters the reclamation period shortly after the volume receives the data, resulting in the reclamation of volumes that were just created.

You can avoid this situation by using the RETENTIONEXTENSION server option. This option allows the server to set or extend the retention date of a SnapLock volume. You can specify a value in the range 30 - 9999 days. The default is 365 days.

When you select volumes in a SnapLock storage pool for reclamation, the server verifies whether the volume is within the reclamation period:

- If the volume is not within the reclamation period, no action is taken. The volume is not reclaimed, and the retention date is unchanged.
- If the volume is within the reclamation period, the server verifies whether the percentage of reclaimable space on the volume is greater than the reclamation threshold of the storage pool or of the threshold percentage that is passed in on the THRESHOLD parameter of a RECLAIM STGPOOL command:
  - If the reclaimable space is greater than the threshold, the server reclaims the volume and sets the retention date of the target volume is set to the greater of these values:
    - The remaining retention time of the data plus 30 days for the reclamation period.
    - The RETENTIONEXTENSION value plus 30 days for the reclamation period.
  - If the reclaimable space is not greater than the threshold, the server resets the retention date of the volume by the amount that is specified in the RETENTIONEXTENSION option. The new retention period is calculated by adding the number of days that are specified to the current date.

In the following examples, the SnapLock volume, VolumeA, is in a storage pool whose reclamation threshold is set to 60%. The RETENTIONEXTENSION server option is set to 365 days. The retention period for VolumeA is in the reclamation period. The following situations show how retention is affected:

- The reclaimable space on VolumeA is less than 60%. The retention date of VolumeA is extended by 365 days.
- The reclaimable space on VolumeA is greater than 60%, and the remaining retention time of the data is more than 365 days. VolumeA is reclaimed, and the retention date of the target volume is set based on the remaining retention period of the data plus 30 days for the reclamation period.
- The reclaimable space on VolumeA is greater than 60%, and the retention time of the data is less than 365 days. VolumeA is reclaimed, and its retention date is set to 365 days, the RETENTIONEXTENSION value, plus 30 days for the reclamation period.

## Continuous data protection with the SnapLock feature

---

If data is stored on a volume with the SnapLock feature enabled, and the data is moved or copied to a non-SnapLock volume, the data loses the unique hardware protection that is provided by NetApp WORM volumes.

The IBM Spectrum Protect™ server allows this type of movement. However, if data is moved from a WORM FILE volume to another type of media, the data might no longer be protected from inadvertent or malicious deletion. If this data is on WORM volumes to meet data retention and protection requirements for legal purposes and is moved to other media, the data might no longer meet those requirements. You must configure your storage pools so that this type of data is kept in storage pools that consist of SnapLock WORM volumes during the entire data retention period.

## Setting up SnapLock volumes as IBM Spectrum Protect WORM FILE volumes

---

To meet strict requirements for archived data, enable the NetApp SnapLock feature.

### About this task

---

When you define or update configurations that involve SnapLock storage pools, ensure that the RECLAMATIONTYPE=SNAPLOCK option is specified for the storage pools that are selected for the NEXTSTGPOOL, RECLAIMSTGPOOL, and COPYSTGPOOLS parameters.

When you configure the storage pools in this way, you help to ensure that your data is properly protected. If you define a next, reclaim, copy storage pool, or active-data pool without selecting the RECLAMATIONTYPE=SNAPLOCK option, the storage pool is not protected. The command succeeds, but a warning message is issued.

### Procedure

---

To set up a SnapLock volume for use as an IBM Spectrum Protect™ WORM FILE volume, complete the following steps:

1. Install and set up SnapLock on the NetApp file server. Ensure that you configure the minimum, maximum, and default retention periods. For instructions, see the NetApp documentation.
2. Install and configure an IBM Spectrum Protect server.
3. Enable archive data retention protection by issuing the SET ARCHIVERETENTIONPROTECTION command:  

```
set archiveretentionprotection on
```
4. Set up policy by using the DEFINE COPYGROUP command. Select RETVER and RETMIN values in the archive copy group that meet your requirements for protecting this data in WORM storage. If the RETVER or RETMIN values are not specified, the default management classes values are used.
5. Set up storage by using the DEFINE DEVCLASS command.
  - o Use the FILE device class.
  - o Specify the DIRECTORY parameter to point to the directory or directories on the SnapLock volumes.
6. Define a storage pool by using the device class that is defined in step 5 by issuing the DEFINE STGPOOL command and specifying the RECLAMATIONTYPE=SNAPLOCK parameter.
7. Update the copy group to point to the storage pool by issuing the UPDATE COPYGROUP command.
8. Use the IBM Spectrum Protect API to archive your objects into the SnapLock storage pool. This feature is not available on standard IBM Spectrum Protect backup-archive clients.

## Repairing and recovering data in directory-container storage pools

---

You can repair damaged data extents in directory-container storage pools and recover lost data after a disaster.

Data extents are part of a file that is created during the data-deduplication process. Extents are compared with other file extents to identify duplicates. If you have damaged files or directories in your directory-container storage pool, you can repair deduplicated data extents from either the target replication server, the source replication server, or from container-copy storage pool tape volumes.

- Repairing storage pools from a target replication server  
If files, directories, or storage pools on a source replication server are damaged, you can repair deduplicated data extents in a directory-container storage pool on the source replication server from a target replication server.
- Repairing storage pools from container-copy storage pool volumes  
If files, directories, or storage pools on a source server are damaged, you can repair data extents in a directory-container

storage pool on the source server by retrieving the deduplicated data extents from onsite or offsite container-copy storage pool tape volumes.

- Repairing storage pools in an environment with both a replication server and container-copy storage pool volumes  
If files, directories, or storage pools on a source server are damaged, you can repair data extents in a directory-container storage pool on the source replication server by retrieving the deduplicated data extents from either the target replication server or from container-copy storage pool tape volumes.
- Repairing storage pools on a target replication server  
If files, directories, or storage pools on a target replication server are damaged, you can repair data extents in a directory-container storage pool on the target replication server by retrieving the deduplicated data extents from the source replication server.
- Repairing storage pools after a disaster  
You can repair directory-container storage pools and recover their lost data after a disaster.
- Replacing a damaged container-copy storage pool tape volume  
If a tape volume that is storing a copy of deduplicated data extents in a container-copy storage pool becomes damaged, you can replace the volume.

**Related concepts:**

Strategies for disaster protection

**Related tasks:**

Data protection solutions

Recovering from data loss or system outages

## Repairing storage pools from a target replication server

---

If files, directories, or storage pools on a source replication server are damaged, you can repair deduplicated data extents in a directory-container storage pool on the source replication server from a target replication server.

### Before you begin

---

Evaluate your storage environment to determine whether outages, network issues, or hardware failures are causing damage to data or causing the data to appear damaged. If issues in your environment are causing damage to data, identify and resolve the issues.

Ensure that there is enough available space in the directory-container storage pool for the recovered data. The `PREVIEW=YES` parameter in the `REPAIR STGPOOL` command specifies how much data will be repaired. If there is not enough space, use the `DEFINE STGPOOLDIRECTORY` command to provision space.

### About this task

---

Use the procedure to repair the following types of damage:

- Minor damage that is caused by accidental deletion of files or directories, overwritten files, accidental changes in file permissions, or disk errors caused by hardware issues.
- Moderate damage that is caused by disk errors or disk mount errors. This type of damage results in the loss of one or more directories, but not a loss of the entire storage pool.

Damaged deduplicated extents are repaired with extents that were protected to the target replication server.

Restriction: You can issue the `REPAIR STGPOOL` command for a specified storage pool only if you already copied the data to another storage pool on a target replication server by using the `PROTECT STGPOOL` command.

When you repair a directory-container storage pool from a replication server, the `REPAIR STGPOOL` command fails if any of the following conditions occur:

- The target replication server is unavailable.
- The target storage pool is damaged.
- A network outage occurs.

### Procedure

---

1. If you suspect minor damage, issue the `AUDIT CONTAINER` command for the container storage pool at the directory level to identify inconsistencies between the database and the directory-container storage pool. By identifying the damaged data extents in the directory-container storage pool, you can determine which data extents to repair. To conserve time and

resources, audit only containers that you suspect are damaged. If you suspect that your directory-container storage pool has more serious damage, issue the AUDIT CONTAINER command at the storage pool level.

For example, to audit a directory, n:\pooldir, in a storage pool that is named STGPOOL1, issue the following command:

```
audit container stgpool=stgpool1 stgpooldirectory=n:\pooldir
```

To audit a storage pool that is named STGPOOL1, issue the following command:

```
audit container stgpool=stgpool1
```

The audit process might run for several hours.

2. To repair a directory-container storage pool, issue the REPAIR STGPOOL command and specify the SRCLOCATION=REPLSERVER parameter. For example, to repair a storage pool that is named STGPOOL1 from a replication server, issue the following command:

```
repair stgpool stgpool1 srclocation=replserver
```

When you issue the REPAIR STGPOOL command, the damaged extents are deleted from the volume immediately after they are repaired. The damaged extents are not retained according to the value specified by the REUSEDELAY parameter.

3. Identify any additional damaged extents by issuing the QUERY DAMAGED command.
4. If damage is detected and deduplicated extents cannot be repaired from the replication server, it is still possible that they will be repaired. In some cases, the client node resends data during a backup operation and the damaged extents are repaired. Wait two backup cycles to allow client backup operations to occur. After two backup cycles, complete the following steps:
  - a. To confirm that the damage is repaired, reissue the QUERY DAMAGED command.
  - b. If an entire storage pool directory is damaged, create a new replacement storage pool directory using the DEFINE STGPOOLDIRECTORY command.
  - c. To remove objects that refer to damaged data, issue the AUDIT CONTAINER command and specify the ACTION=REMOVEDAMAGED parameter.  
For example, to audit a directory-container storage pool that is named STGPOOL1 and remove damaged objects, issue the following command:

```
audit container stgpool=stgpool1 action=removedamaged
```
  - d. Optionally, issue the DELETE STGPOOLDIRECTORY command to delete the empty storage pool directory that you replaced with a new directory in step 4.b.

## What to do next

---

If you continue to detect damaged data over time, issue the AUDIT CONTAINER command for the directory-container storage pool to determine whether there is more widespread damage. For example, to audit a storage pool that is named STGPOOL1, issue the following command:

```
audit container stgpool=stgpool1
```

### Related reference:

AUDIT CONTAINER (Verify the consistency of database information for a directory-container)  
DEFINE SCHEDULE (Define a schedule for an administrative command)  
QUERY DAMAGED (Query damaged storage pool data)  
PROTECT STGPOOL (Protect storage pool data)  
REPAIR STGPOOL (Repair a directory-container storage pool)  
DEFINE STGPOOLDIRECTORY (Define a storage pool directory)  
DELETE STGPOOLDIRECTORY (Deleting a storage pool directory)

## Repairing storage pools from container-copy storage pool volumes

---

If files, directories, or storage pools on a source server are damaged, you can repair data extents in a directory-container storage pool on the source server by retrieving the deduplicated data extents from onsite or offsite container-copy storage pool tape volumes.

## Before you begin

---



Evaluate your storage environment to determine whether outages, network issues, or hardware failures are causing damage to data or causing the data to appear damaged. If issues in your environment are causing damage to data, identify and resolve the issues.

## About this task

---

Use the procedure to repair the following types of damage:

- Minor damage that is caused by accidental deletion of files or directories, overwritten files, accidental changes in file permissions, or disk errors caused by hardware issues.
- Moderate damage that is caused by disk errors or disk mount errors. This type of damage results in the loss of one or more directories, but not a loss of the entire storage pool.

Damaged deduplicated extents are repaired with extents that were protected to container-copy storage pools.

Restriction: You can issue the REPAIR STGPOOL command for a specified storage pool only if you already copied the data to container-copy storage pools by using the PROTECT STGPOOL command.

When you repair a directory-container storage pool from container-copy pools, the REPAIR STGPOOL command fails if any of the following conditions occur:

- The container-copy storage pool is unavailable.
- The container-copy storage pool is damaged.
- The container-copy storage pool volumes are unavailable or damaged.

## Procedure

---

1. If you suspect minor damage, issue the AUDIT CONTAINER command for the container storage pool at the directory level to identify inconsistencies between the database and the directory-container storage pool. By identifying the damaged data extents in the directory-container storage pool, you can determine which data extents to repair. To conserve time and resources, audit only containers that you suspect are damaged. If you suspect that your container storage pool has more serious damage, issue the AUDIT CONTAINER command at the storage pool level. For example, to audit a directory, `n:\pooldir`, in a storage pool that is named `STGPOOL1`, issue the following command:

```
audit container stgpool=stgpool1 stgpooldirectory=n:\pooldir
```

To audit a storage pool that is named `STGPOOL1`, issue the following command:

```
audit container stgpool=stgpool1
```

The audit process might run for several hours.

During the repair operation, the server prompts you for the volumes that it requires. In step 3, you will bring the volumes onsite and check them into the library. The required volumes must be brought onsite and checked into the library.

2. To preview the repair operation and generate the list of tape volumes that are needed for the repair operation, issue the REPAIR STGPOOL command and specify the `SRCLOCATION=LOCAL` and `PREVIEW=YES` parameters. For example, to preview the repair operation for a storage pool that is named `STGPOOL1` from container-copy storage pools, issue the following command:

```
repair stgpool stgpool1 srclocation=local preview=yes
```

The preview process might take some time to finish.

3. If some of the required volumes are offsite, complete the following steps:
  - a. Use the list from the preview operation to determine which volumes need to be brought onsite.
  - b. When the volumes are back onsite, check them into the library by issuing the `CHECKIN LIBVOLUME` command and specifying the `STATUS=PRIVATE` parameter.
  - c. Update the status of the volumes by issuing the `UPDATE STGPOOL` command and specifying the `ACCESS=READWRITE` parameter.

For detailed instructions about the disaster recovery manager (DRM) function, see *Using disaster recovery manager for tape environments (V7.1.1)*.

4. Based on the information that you obtained during the preview operation, ensure that the storage pool contains enough space for the recovered data. If there is not enough space, use the `DEFINE STGPOOLDIRECTORY` command to provision space.
5. To repair the directory-container storage pool, issue the `REPAIR STGPOOL` command and specify the `SRCLOCATION=LOCAL` parameter.



For example, to repair a storage pool that is named STGPOOL1 from a container-copy storage pool, issue the following command:

```
repair stgpool stgpool1 srclocation=local
```

When you issue the REPAIR STGPOOL command, the damaged extents are deleted from the volume immediately after they are repaired. The damaged extents are not retained according to the value specified by the REUSEDELAY parameter.

6. Identify any additional damaged extents by issuing the QUERY DAMAGED command.
7. If damage is detected and deduplicated extents cannot be repaired from the container-copy storage pools, it is still possible that they will be repaired. In some cases, the client node resends data during a backup operation and the damaged extents are repaired. Wait two backup cycles to allow client backup operations to occur. After two backup cycles, complete the following steps:
  - a. To confirm that the damage is repaired, reissue the QUERY DAMAGED command.
  - b. If an entire storage pool directory is damaged, create a new replacement storage pool directory using the DEFINE STGPOOLDIRECTORY command.
  - c. To remove objects that refer to damaged data, issue the AUDIT CONTAINER command and specify the ACTION=REMOVEDAMAGED parameter.  
For example, to audit a directory-container storage pool that is named STGPOOL1 and remove damaged objects, issue the following command:

```
audit container stgpool=stgpool1 action=removedamaged
```
  - d. Optionally, issue the DELETE STGPOOLDIRECTORY command to delete the empty storage pool directory that you replaced with a new directory in step 7.b.
8. If you repaired an entire storage pool directory, delete the original directory, which is empty and was replaced by a new directory. Delete the original directory by issuing the DELETE STGPOOLDIRECTORY command.

## What to do next

---

If you continue to detect damaged data over time, issue the AUDIT CONTAINER command for the directory-container storage pool to determine whether there is more widespread damage. For example, to audit a storage pool that is named STGPOOL1, issue the following command:

```
audit container stgpool=stgpool1
```

### Related reference:

AUDIT CONTAINER (Verify the consistency of database information for a directory-container)  
DEFINE SCHEDULE (Define a schedule for an administrative command)  
QUERY DAMAGED (Query damaged storage pool data)  
PROTECT STGPOOL (Protect storage pool data)  
REPAIR STGPOOL (Repair a directory-container storage pool)  
DEFINE STGPOOLDIRECTORY (Define a storage pool directory)  
DELETE STGPOOLDIRECTORY (Deleting a storage pool directory)

## Repairing storage pools in an environment with both a replication server and container-copy storage pool volumes

---

If files, directories, or storage pools on a source server are damaged, you can repair data extents in a directory-container storage pool on the source replication server by retrieving the deduplicated data extents from either the target replication server or from container-copy storage pool tape volumes.

## Before you begin

---

Evaluate your storage environment to determine whether outages, network issues, or hardware failures are causing damage to data or causing the data to appear damaged. If issues in your environment are causing damage to data, identify and resolve the issues.

Ensure that there is enough available space in the directory-container storage pool for the recovered data. The PREVIEW=YES parameter in the REPAIR STGPOOL command specifies how much data will be repaired. If there is not enough space, use the DEFINE STGPOOLDIRECTORY command to provision space.

## About this task

---

Use the procedure to repair the following types of damage:

- Minor damage that is caused by accidental deletion of files or directories, overwritten files, accidental changes in file permissions, or disk errors caused by hardware issues.
- Moderate damage that is caused by disk errors or disk mount errors. This type of damage results in the loss of one or more directories, but not a loss of the entire storage pool.

Damaged deduplicated extents are repaired with extents that were protected to the target replication server or to container-copy storage pools on a source server.

Restriction: You can issue the REPAIR STGPOOL command for a specified storage pool only if you already copied the data to another storage pool on a target replication server or to container-copy storage pools by using the PROTECT STGPOOL command. When you repair a directory-container storage pool from a target replication server, the REPAIR STGPOOL command fails if any of the following conditions occur:

- The target replication server is unavailable.
- The target storage pool is damaged.
- A network outage occurs.

When you repair a directory-container storage pool from container-copy pools, the REPAIR STGPOOL command fails if any of the following conditions occur:

- The container-copy storage pool is unavailable.
- The container-copy storage pool is damaged.
- The container-copy storage pool volumes are unavailable or damaged.

## Procedure

---

1. Attempt to repair the storage pool from the target replication server by completing the steps in Repairing storage pools from a target replication server.
2. If the damaged extents cannot be repaired from the target replication server, repair the damaged extents from container-copy storage pools by completing the steps in Repairing storage pools from container-copy storage pool volumes.
3. If you repaired damaged extents from container-copy storage pools, issue the PROTECT STGPOOL command and specify the TYPE=REPLSERVER parameter for the storage pools on the source replication server.

## What to do next

---

If you continue to detect damaged data over time, issue the AUDIT CONTAINER command for the directory-container storage pool to determine whether there is more widespread damage. For example, to audit a storage pool that is named STGPOOL1, issue the following command:

```
audit container stgpool=stgpool1
```

### Related reference:

AUDIT CONTAINER (Verify the consistency of database information for a directory-container)

DEFINE SCHEDULE (Define a schedule for an administrative command)

QUERY DAMAGED (Query damaged storage pool data)

PROTECT STGPOOL (Protect storage pool data)

REPAIR STGPOOL (Repair a directory-container storage pool)

DEFINE STGPOOLDIRECTORY (Define a storage pool directory)

DELETE STGPOOLDIRECTORY (Deleting a storage pool directory)

## Repairing storage pools on a target replication server

---

If files, directories, or storage pools on a target replication server are damaged, you can repair data extents in a directory-container storage pool on the target replication server by retrieving the deduplicated data extents from the source replication server.

## Before you begin

---

Evaluate your storage environment to determine whether outages, network issues, or hardware failures are causing damage to data or causing the data to appear damaged. If issues in your environment are causing damage to data, identify and resolve the issues.

## About this task

---

Use the procedure to repair the following types of damage:

- Minor damage that is caused by accidental deletion of files or directories, overwritten files, accidental changes in file permissions, or disk errors caused by hardware issues.
- Moderate damage that is caused by disk errors or disk mount errors. This type of damage results in the loss of one or more directories, but not a loss of the entire storage pool.

As part of the operation of the PROTECT STGPOOL command, damaged extents in the target storage pool are repaired. To be repaired, extents must already be marked as damaged on the target server. For example, an AUDIT CONTAINER command might identify damage in the target storage pool before the PROTECT STGPOOL command is issued.

## Procedure

---

1. Protect data extents in a directory-container storage pool on a source server by issuing the PROTECT STGPOOL command. For example, to protect a directory-container storage pool that is named POOL1, issue the following command:

```
protect stgpool pool1
```

Wait for the protection process to finish.

2. To identify the damaged data extents in the directory-container storage pool on the target server, issue the AUDIT CONTAINER command. For example, to audit a storage pool that is named STGPOOL1, issue the following command:

```
audit container stgpool=stgpool1
```

3. Repair damaged extents in the target storage pool by reissuing the PROTECT STGPOOL command on the source server. The damaged extents in the target storage pool are marked as damaged and are repaired.
4. Confirm that there are no additional damaged extents by issuing the QUERY DAMAGED command.

### Related reference:

AUDIT CONTAINER (Verify the consistency of database information for a directory-container)

DEFINE SCHEDULE (Define a schedule for an administrative command)

QUERY DAMAGED (Query damaged storage pool data)

PROTECT STGPOOL (Protect storage pool data)

REPAIR STGPOOL (Repair a directory-container storage pool)

DEFINE STGPOOLDIRECTORY (Define a storage pool directory)

DELETE STGPOOLDIRECTORY (Deleting a storage pool directory)

## Repairing storage pools after a disaster

---

You can repair directory-container storage pools and recover their lost data after a disaster.

If a disaster occurs and your primary site is no longer available, you can repair your directory-container storage pools by restoring them on a new target server at your recovery site.

- Repairing storage pools from container-copy storage pool volumes after a disaster  
If a disaster occurs on a source server, you can repair deduplicated data extents in a directory-container storage pool from offsite container-copy storage pool tape volumes. The directory-container storage pool is repaired on a target server at a recovery site.
- Repairing storage pools from a target replication server after a disaster  
If a disaster occurs on a source replication server, you can repair deduplicated data extents in a directory-container storage pool from a target replication server. The directory-container storage pool is repaired on a target server at a recovery site.
- Repairing storage pools in an environment with both a replication server and container-copy storage pool volumes after a disaster  
If a disaster occurs on a source server, you can repair deduplicated data extents in a directory-container storage pool from a replication target server or from offsite container-copy storage pool tape volumes. The directory-container storage pool is repaired on a target server at a recovery site.

**Related reference:**

Determining whether to use container-copy storage pools for disaster protection

## Repairing storage pools from container-copy storage pool volumes after a disaster

---

If a disaster occurs on a source server, you can repair deduplicated data extents in a directory-container storage pool from offsite container-copy storage pool tape volumes. The directory-container storage pool is repaired on a target server at a recovery site.

### About this task

---

Use the procedure to repair the following types of major damage:

- Complete loss of all container storage pools on the source server
- Complete loss of the primary site

The following assumptions are made for this disaster recovery scenario:

- You were using the PROTECT STGPOOL command to back up data to offsite container-copy storage pools from a source server. You retrieved the offsite tape volumes and have them at your recovery site.
- You were not using the PROTECT STGPOOL command to back up data to a target replication server.
- You used the IBM Spectrum Protect™ Blueprints to configure the IBM Spectrum Protect source server, and you also used the Blueprint configuration scripts to restore the environment by setting up a new target server at a recovery site. The scripts copied backup versions of the IBM Spectrum Protect database, the server options file (dsmserv.opt), the volume history file (volhist.out), and device configuration file (devconfig.out) to their original locations on the recovery server. After the scripts run, you see the newly created, empty directories on the recovery server.

When you attempt to repair a directory-container storage pool from container-copy pools, the REPAIR STGPOOL command fails if any of the following conditions occur:

- The container-copy storage pool is unavailable.
- The container-copy storage pool is damaged.
- The container-copy storage pool volumes are unavailable or damaged.

### Procedure

---

1. Mark all data extents in the container storage pool as damaged by issuing the AUDIT CONTAINER command for the container storage pool at the storage pool level, and specifying the ACTION=MARKDAMAGED parameter. For example, to audit a storage pool that is named STGPOOL1 and mark it as damaged, issue the following command:

```
audit container stgpool=stgpool1 action=markdamaged
```

2. If you protected the directory-container storage pool by using both onsite and offsite container-copy storage pools, issue the UPDATE STGPOOL command for the onsite copy of the container-copy storage pools, and specify the ACCESS=UNAVAILABLE parameter.
3. When the offsite container-copy storage pool volumes are back onsite, check them into the library by issuing the CHECKIN LIBVOLUME command and specifying the STATUS=PRIVATE parameter.
4. Update the status of the volumes by issuing the UPDATE STGPOOL command and specifying the ACCESS=READWRITE parameter.
5. Repair the storage pool by issuing the REPAIR STGPOOL command and specifying the SRCLOCATION=LOCAL parameter. For example, to repair a storage pool that is named STGPOOL1 from offsite container-copy storage pools, issue the following command:

```
repair stgpool stgpool1 srclocation=local
```

When you issue the REPAIR STGPOOL command, the damaged extents are deleted from the volume immediately after they are repaired. The damaged extents are not retained according to the value specified by the REUSEDELAY parameter.

6. Confirm that there are no additional damaged extents by issuing the QUERY DAMAGED command.
7. Repeat this procedure to repair all of your storage pools.

## Repairing storage pools from a target replication server after a disaster

---

If a disaster occurs on a source replication server, you can repair deduplicated data extents in a directory-container storage pool from a target replication server. The directory-container storage pool is repaired on a target server at a recovery site.

## About this task

---

Use the procedure to repair the following types of major damage:

- Complete loss of all container storage pools on the source replication server
- Complete loss of the primary site

The following assumptions are made for this disaster recovery scenario:

- You were using the PROTECT STGPOOL command to back up data from a source replication server to a target replication server. The target replication server is running at your recovery site.
- You were not using the PROTECT STGPOOL command to back up data to offsite container-copy storage pools.
- You used the IBM Spectrum Protect™ Blueprints to configure the IBM Spectrum Protect source server, and you also used the Blueprint configuration scripts to restore the environment by setting up a new target server at a recovery site. The scripts copied backup versions of the IBM Spectrum Protect database, the server options file (dsmserv.opt), the volume history file (volhist.out), and device configuration file (devconfig.out) to their original locations on the recovery server. After the scripts run, you see the newly created, empty directories on the recovery server.

When you attempt to repair a directory-container storage pool from a target replication server, the REPAIR STGPOOL command fails if any of the following conditions occur:

- The target replication server is unavailable.
- The target storage pool is damaged.
- A network outage occurs.

## Procedure

---

1. Mark all data extents in the container storage pool as damaged by issuing the AUDIT CONTAINER command for the container storage pool at the storage pool level, and specifying the ACTION=MARKDAMAGED parameter. For example, to audit a storage pool that is named STGPOOL1 and mark it as damaged, issue the following command:

```
audit container stgpool=stgpool1 action=markdamaged
```

2. Repair the storage pool by issuing the REPAIR STGPOOL command and specifying the SRCLOCATION=REPLSERVER parameter. For example, to repair a storage pool that is named STGPOOL1 from a target replication server, issue the following command:

```
repair stgpool stgpool1 srclocation=replserver
```

When you issue the REPAIR STGPOOL command, the damaged extents are deleted from the volume immediately after they are repaired. The damaged extents are not retained according to the value specified by the REUSEDELAY parameter.

3. If you did not use Blueprint configuration scripts to set up your target replication server, the file structure on the target replication server might not match the information that is stored in the database. Optionally, remove the storage pool directories that do not exist on the target replication server by issuing the DELETE STGPOOLDIRECTORY command.
4. Confirm that there are no additional damaged extents by issuing the QUERY DAMAGED command.
5. If damage is detected and deduplicated extents cannot be repaired from the replication server, it is still possible that they will be repaired. In some cases, the client node resends data during a backup operation and the damaged extents are repaired. Wait two backup cycles to allow client backup operations to occur. After two backup cycles, complete the following steps:
  - a. To confirm that the damage is repaired, reissue the QUERY DAMAGED command.
  - b. To remove objects that refer to damaged data, issue the AUDIT CONTAINER command and specify the ACTION=REMOVEDAMAGED parameter. For example, to audit a directory-container storage pool that is named STGPOOL1 and remove damaged objects, issue the following command:

```
audit container stgpool=stgpool1 action=removedamaged
```

6. Repeat this procedure to repair all of your storage pools.

**Related reference:**

## Repairing storage pools in an environment with both a replication server and container-copy storage pool volumes after a disaster

---

If a disaster occurs on a source server, you can repair deduplicated data extents in a directory-container storage pool from a replication target server or from offsite container-copy storage pool tape volumes. The directory-container storage pool is repaired on a target server at a recovery site.

### About this task

---

Use the procedure to repair the following types of major damage:

- Complete loss of all container storage pools on the source server
- Complete loss of the primary site

The following assumptions are made for this disaster recovery scenario:

- You were using the PROTECT STGPOOL command to back up data from a source replication server to a target replication server. The target replication server is running at your recovery site.
- You were using the PROTECT STGPOOL command to back up data to offsite container-copy storage pools.
- You used the IBM Spectrum Protect™ Blueprints to configure the IBM Spectrum Protect source server, and you also used the Blueprint configuration scripts to restore the environment by setting up a new target server at a recovery site. The scripts copied backup versions of the IBM Spectrum Protect database, the server options file (dsmserv.opt), the volume history file (volhist.out), and device configuration file (devconfig.out) to their original locations on the recovery server. After the scripts run, you see the newly created, empty directories on the recovery server.

When you attempt to repair a directory-container storage pool from a target replication server, the REPAIR STGPOOL command fails if any of the following conditions occur:

- The target replication server is unavailable.
- The target storage pool is damaged.
- A network outage occurs.

When you repair a directory-container storage pool from container-copy pools, the REPAIR STGPOOL command fails if any of the following conditions occur:

- The container-copy storage pool is unavailable.
- The container-copy storage pool is damaged.
- The container-copy storage pool volumes are unavailable or damaged.

### Procedure

---

1. Mark all data extents in the container storage pool as damaged by issuing the AUDIT CONTAINER command for the container storage pool at the storage pool level, and specifying the ACTION=MARKDAMAGED parameter. For example, to audit a storage pool that is named STGPOOL1 and mark it as damaged, issue the following command:  

```
audit container stgpool=stgpool1 action=markdamaged
```
2. If you protected the directory-container storage pool by using both onsite and offsite container-copy storage pools, issue the UPDATE STGPOOL command for the onsite copy of the container-copy storage pools, and specify the ACCESS=UNAVAILABLE parameter.
3. When the offsite container-copy storage pool volumes are back onsite, check them into the library by issuing the CHECKIN LIBVOLUME command and specifying the STATUS=PRIVATE parameter. By moving the tape volumes onsite now, you are prepared to repair damaged extents from the container-copy tape volumes if the damaged extents cannot be repaired from the target replication server.
4. Update the status of the volumes by issuing the UPDATE STGPOOL command and specifying the ACCESS=READWRITE parameter.
5. Repair the storage pool by issuing the REPAIR STGPOOL command and specifying the SRCLOCATION=REPLSERVER parameter. For example, to repair a storage pool that is named STGPOOL1 from a target replication server, issue the following command:

```
repair stgpool stgpool1 srclocation=replserver
```

When you issue the REPAIR STGPOOL command, the damaged extents are deleted from the volume immediately after they are repaired. The damaged extents are not retained according to the value specified by the REUSEDELAY parameter.

6. If you did not use Blueprint configuration scripts to set up your target replication server, the file structure on the target replication server might not match the information that is stored in the database. Optionally, remove the storage pool directories that do not exist on the target replication server. Issue the DELETE STGPOOLDIRECTORY command to delete directories that are not on the target replication server.
7. Confirm that there are no additional damaged extents by issuing the QUERY DAMAGED command.
8. If the damaged extents cannot be repaired from the target replication server, you can repair the damaged extents from offsite container-copy storage pools. For instructions, see [Repairing storage pools from container-copy storage pool volumes after a disaster](#).
9. Confirm that there are no additional damaged extents by reissuing the QUERY DAMAGED command.
10. If damage is detected and deduplicated extents cannot be repaired from the replication server, it is still possible that they will be repaired. In some cases, the client node resends data during a backup operation and the damaged extents are repaired. Wait two backup cycles to allow client backups to occur. After two backup cycles, complete the following steps:
  - a. To confirm that the damage is repaired, reissue the QUERY DAMAGED command.
  - b. To remove objects that refer to damaged data, issue the AUDIT CONTAINER command and specify the ACTION=REMOVEDAMAGED parameter.  
For example, to audit a directory-container storage pool that is named STGPOOL1 and remove damaged objects, issue the following command:

```
audit container stgpool=stgpool1 action=removedamaged
```

11. Repeat this procedure to repair all of your storage pools.

## Replacing a damaged container-copy storage pool tape volume

---

If a tape volume that is storing a copy of deduplicated data extents in a container-copy storage pool becomes damaged, you can replace the volume.

### Procedure

---

1. Delete the damaged tape volume by issuing the DELETE VOLUME command and specifying the DISCARDATA=YES parameter.

For example, to delete a volume that is named VOLUME1, issue the following command:

```
delete volume volume1 discarddata=yes
```

2. Protect data extents in the directory-container storage pool by copying the data to existing volumes in the container-copy storage pool. Issue the PROTECT STGPOOL command from the source server.

For example, to protect a directory-container storage pool that is named POOL1, issue the following command:

```
protect stgpool pool1 type=local
```

#### Related reference:

PROTECT STGPOOL (Protect storage pool data)

DELETE VOLUME (Delete a storage pool volume)

## Server commands, options, and utilities

---

Use commands to administer and configure the server, options to customize the server, and utilities to perform special tasks when the server is not running.

- **Managing the server from the command line**  
IBM Spectrum Protect™ provides several different command-line interfaces for managing IBM Spectrum Protect servers.
- **Administrative commands**  
Administrative commands are available to manage and configure the server.
- **Server options**  
At installation, IBM Spectrum Protect provides a server options file that contains a set of default options to start the server.
- **Server utilities**  
Use server utilities to perform special tasks on the server while the server is not running.



- Return codes for use in IBM Spectrum Protect scripts  
You can write IBM Spectrum Protect scripts that use return codes to determine how script processing proceeds. The return codes can be one of three severities: OK, WARNING, ERROR.
- Device utilities  
You can use device utilities for tasks that are related to configuring storage devices for the IBM Spectrum Protect server.
- Server scripts and macros for automation  
You can automate common administrative tasks by creating IBM Spectrum Protect server scripts or administrative client macros. Server scripts are stored in the server database and can be scheduled to run with an administrative schedule command. Administrative client macros are stored as files on the administrative client.

## Managing the server from the command line

---

IBM Spectrum Protect™ provides several different command-line interfaces for managing IBM Spectrum Protect servers.

### About this task

---

The following command-line interfaces are available:

#### Administrative command-line client

The administrative command-line client is a program that runs on a file server, workstation, or mainframe. It is installed as part of the IBM Spectrum Protect server installation process. The administrative client can be accessed remotely.

From the administrative client, you can issue any server commands.

#### Server console

The server console is a command-line window on the system where the server is installed. Therefore, to use the server console, you must be at the physical location of the server system.

Compared to the administrative client, the capabilities of the server console are limited. From the server console, you cannot issue certain commands, and you cannot route commands to other servers. Also, you cannot specify that certain commands process before other commands can be issued. However, this limitation can be useful if, for example, you want to run two commands in quick succession.

#### Operations Center command line

From the Operations Center, you can access the IBM Spectrum Protect command line. You might want to use this command line to issue server commands to complete certain IBM Spectrum Protect tasks that are not supported in the Operations Center.

Server scripts provide for automation of common administrative tasks. A macro is a file that contains one or more IBM Spectrum Protect administrative commands. When you issue the MACRO command, the server processes all commands in the macro file in order, including commands that are contained in any nested macros.

- Issuing commands from the administrative client  
The administrative command-line client is a program that runs on a file server, workstation, or mainframe.
- Issuing commands from the Operations Center  
From the Operations Center command-line interface, you can issue commands to manage IBM Spectrum Protect servers that are configured as hub or spoke servers.
- Issuing commands from the server console  
IBM Spectrum Protect provides a user ID named SERVER\_CONSOLE that allows you to issue commands and administer the server from the server console after IBM Spectrum Protect is installed. At installation, SERVER\_CONSOLE is automatically registered as an administrator and is given system authority.
- Entering administrative commands  
Commands consist of command names and usually parameters and variables. Syntax diagrams depict the rules to follow when entering commands.
- Controlling command processing  
You can run some IBM Spectrum Protect commands sequentially or concurrently with other commands. You can also route commands from one server to other servers for processing.
- Performing tasks concurrently on multiple servers  
Command routing allows you to route commands to one or more servers for processing and then collect the output from these servers.
- Privilege classes for commands  
The authority granted to an administrator through the privilege class determines which administrative commands that the administrator can issue.



**Related concepts:**

Server scripts

**Related reference:**

Administrative client macros

## Issuing commands from the administrative client

---

The administrative command-line client is a program that runs on a file server, workstation, or mainframe.

### About this task

---

Ensure that your administrative client and your server are running in compatible languages. See LANGUAGE for language and locale options. If your client and server are using different languages, the messages that IBM Spectrum Protect™ generates might not be understandable.

Tip: Text strings that are sent from the client to the server do not depend on the server language setting. The text is displayed properly if the administrative client runs in the same locale when sending the string and when receiving the string.

For example, assume that you update a node contact field with a value that contains national characters (`update node myNode contact=NLcontact_info`), and later query the node (`query node myNode format=detailed`). If the client is running in the same locale when you update as when you query, the `NLcontact_info` displays properly. If you update the node contact field when the client is running in one locale, and query the node when the client is running in a different locale, the `NLcontact_info` might not display properly.

- Starting and stopping the administrative client  
Use the DSMADMC command to start an administrative client session.
- Monitoring server activities from the administrative client  
To monitor IBM Spectrum Protect activities, such as server migration and client logons, run the administrative client in console mode. You cannot enter any administrative commands in console mode.
- Monitoring removable-media mounts from the administrative client  
To monitor the mounting and dismounting of removable media, run the administrative client in mount mode. When the client is running in mount mode, you cannot enter any administrative commands.
- Processing individual commands from the administrative client  
Use batch mode to enter a single administrative command. Your administrative client session automatically ends when the command is processed.
- Processing a series of commands from the administrative client  
Use the interactive mode to process a series of administrative commands.
- Formatting output from commands  
IBM Spectrum Protect formats the output processed from commands according to your screen or window width.
- Saving command output to a specified location  
The most common use for redirecting output is to save the output from query commands to a specified file or program. You can then browse the contents of the file or in some cases, print the contents.
- Administrative client options  
In all administrative client modes, you can use options to modify administrative client session responses.

## Starting and stopping the administrative client

---

Use the DSMADMC command to start an administrative client session.

### About this task

---

The IBM Spectrum Protect™ server must be running before an administrative client can connect.

### Procedure

---

- To start an administrative client session in command-line mode, enter this command on your workstation:

```
dsmadmc -id=admin -password=admin -dataonly=yes
```

By entering the DSMADMC command with the `-ID` and `-PASSWORD` options as shown, you are not prompted for a user ID and password.

- To stop an administrative command-line client session, enter the following command:

```
quit
```

- To interrupt a DSMADMC command before the IBM Spectrum Protect server finishes processing it, use the UNIX `kill -9` command from an available command line. Do not press `Ctrl+C` because, while it ends the session, it can lead to unexpected results.

## Monitoring server activities from the administrative client

---

To monitor IBM Spectrum Protect™ activities, such as server migration and client logons, run the administrative client in console mode. You cannot enter any administrative commands in console mode.

### Procedure

---

- To start an administrative client session in console mode, enter the following command:

```
dsmadmc -consolemode
```

You are prompted for a password if authentication is turned on for the server. If you do not want to be prompted for your user ID and password, enter the DSMADMC command with the `-ID` and `-PASSWORD` options.

- To end an administrative client session in console mode, use a keyboard break sequence.

Operating system	Break sequence
UNIX and Linux clients	Ctrl+C
Windows clients	Ctrl+C or Ctrl+Break

## Monitoring removable-media mounts from the administrative client

---

To monitor the mounting and dismounting of removable media, run the administrative client in mount mode. When the client is running in mount mode, you cannot enter any administrative commands.

### Procedure

---

- To start an administrative client session in mount mode, enter the following command:

```
dsmadmc -mountmode
```

You are prompted for a password if authentication is turned on for the server. If you do not want to be prompted for your user ID and password, enter the DSMADMC command with the `-ID` and `-PASSWORD` options.

- To end an administrative client session in mount mode, use a keyboard break sequence.

Operating system	Break sequence
UNIX and Linux clients	Ctrl+C
Windows clients	Ctrl+C or Ctrl+Break

## Processing individual commands from the administrative client

---

Use batch mode to enter a single administrative command. Your administrative client session automatically ends when the command is processed.

### Procedure

---

To start an administrative client session in batch mode, use the following command: `dsmadmc server_command`

If you do not want to be prompted for your user ID and password, you can enter the DSMADMC command with the `-ID` and `-PASSWORD` options.

In batch mode, you must enter the complete command on one line. If a command does not fit on one line, enter the command by using a macro or a script. If you specify a parameter with a string of text using batch mode, enclose the text in single quotation marks ( ' ') in the macro. Do not use double quotation marks for commands in batch mode, because your operating system might not parse the quotation marks correctly.

**Windows** You can bypass this batch mode double quotation mark restriction for Windows clients by using the back slash (\) escape character. For example, on the OBJECTS parameter of the DEFINE CLIENTACTION command, you could enter the string with the \ character preceding the double quotation marks in the command.

```
dsmadmc -id=admin -password=admin define clientaction test_node domain=test_dom  
action=restore objects='\"C:\program files\test\*\"'
```

## Processing a series of commands from the administrative client

---

Use the interactive mode to process a series of administrative commands.

### About this task

---

To start an administrative client session in interactive mode, a server session must be available. To ensure the availability of server sessions for both administrative and client node sessions, the interactive mode of the administrative client is disconnected if one or more of the following conditions is true:

- The server was stopped by using the HALT command.
- Commands were not issued from the administrative client session for the length of time that is specified with the IDLETIMEOUT server option.
- The administrative client session was canceled with the CANCEL SESSION command.

### Procedure

---

To start an administrative session in interactive mode, use the following command: `dsmadmc`

You can use continuation characters when you use interactive mode. For more information, see [Using continuation characters to enter long commands](#).

You can automatically restart your administrative client session by entering another command each time the `tsm: servername >` prompt appears.

Do not enter a server command with the DSMADMC command. Doing so starts the administrative client in batch, not interactive, mode. For example, do not enter:

```
dsmadmc server_command
```

## Formatting output from commands

---

IBM Spectrum Protect™ formats the output processed from commands according to your screen or window width.

### Procedure

---

- If the width of your screen or window is not wide enough to display the output horizontally, IBM Spectrum Protect arranges and displays the information vertically.
- You can format the output of QUERY commands using the DISPLAYMODE and OUTFILE administrative client options.

## Saving command output to a specified location

---

The most common use for redirecting output is to save the output from query commands to a specified file or program. You can then browse the contents of the file or in some cases, print the contents.

### About this task

---

On some operating systems, you can redirect output of a command by using special characters such as >, >>, and |. Redirection characters direct the output of a command to a file or program that you specify instead of to your screen. You can save the output

from a command by entering redirection characters at the end of the command. To redirect output, leave a blank between the redirection character and the file or program name. See the following examples.

When redirecting output, follow the naming conventions of the operating system where you are running the administrative client.

## Procedure

The examples in the following table show how to redirect command output.

Task	Procedure
Redirect the output of a QUERY DOMAIN command to a new file in batch or interactive mode	Use a single greater-than sign (>) to redirect the output to a new file or write over an existing file: <code>dsmadmc -id=xxx -pa=xxx query domain acctg &gt; dominfo.acc</code>
Append the output of a QUERY DOMAIN command to the end of an existing file in batch or interactive mode	Use two consecutive greater-than signs (>>) to append the output to the end of an existing file: <code>dsmadmc -id=xxx -pa=xxx query domain acctg &gt;&gt; dominfo.acc</code>
Redirect all output from an administrative client session in console mode to a program called filter.exe	Use the vertical bar ( ) to direct all output for a session to a program: <code>dsmadmc -console -id=admin -password=xxx   filter.exe</code> The program can be set up to monitor the output for individual messages as they occur and take appropriate action, such as sending mail to another user.
In console mode, redirect all output to a file	Specify the -OUTFILE option with a destination file name. For example, the following command redirects all output to the save.out file: <code>dsmadmc -id=sullivan -password=secret -consolemode -outfile=save.out</code>

## Administrative client options

In all administrative client modes, you can use options to modify administrative client session responses.

### Syntax

```

>>-DSMADMC-----+-----+----->>
      |               |
      v               |
      '-admin_client_option-'   '-server_command-'

```

### Example of using administrative client options

You can enter the DSMADMC command with your user ID and password by using the -ID and -PASSWORD options so that you are not prompted for that information. To have IBM Spectrum Protect™ redirect all output to a file, specify the -OUTFILE option with a destination file name. For example, to issue the QUERY NODE command in batch mode with the output redirected to the SAVE.OUT file, enter:

```
dsmadmc -id=sullivan -password=secret -outfile=save.out query node
```

### Options

Administrative client options can be specified with the DSMADMC command and are valid from an administrative client session only. You can type an option in uppercase letters, lowercase letters, or any combination. Uppercase letters denote the shortest acceptable abbreviation. If an option appears entirely in uppercase letters, you cannot abbreviate it.

#### -ALWAYS Prompt

Specifies that a command prompt is displayed if the input is from the keyboard or if it is redirected (for example, from a file). If this option is not specified and the input is redirected, the command prompt is not written.

If the input is redirected, only the command output is displayed. If this option is specified, the command prompt and the command output are displayed.

**-CHECKAlias**

Allows the administrative client to recognize an alias for the HALT command as set in the ALIASHALT server option. See ALIASHALT for details.

**-COMMA**

Specifies that any tabular output from a server query is to be formatted as comma-separated strings rather than in readable format. This option is intended to be used primarily when you redirect the output of an SQL query (SELECT command). The comma-separated value format is a standard data format, which can be processed by many common programs, including spreadsheets, databases, and report generators.

**-CONSOLE**

Specifies that IBM Spectrum Protect runs in console mode. Most server console output is echoed to your screen. The exception are items such as responses to query commands that are issued from the console, trace output, or any system messages that displayed on the console.

**-DATAONLY=NO or YES**

Specifies whether product version information and output headers display with the output. The default is NO.

NO

Specifies that the product version information and output column headers display.

YES

Suppresses the product version information and output column headers.

**-DISPLAYMODE=LIST or TABLE**

You can force the QUERY output to tabular or list format regardless of the command-line window column width.

If you are using the -DISPLAYMODE option and you want the output to go to a file, do not specify the -OUTFILE option. Use redirection to write to the file.

**-ID=userid**

Specifies the administrator's user ID.

**-ITEM**

Specifies that IBM Spectrum Protect commits commands inside a script or a macro as each command is processed.

**-MOUNT**

Specifies that IBM Spectrum Protect runs in mount mode. All server removable-media mount messages are echoed to your screen.

**-NEWLINEAFTER**

Specifies that a newline character is written after the command prompt and commands that are entered from the keyboard are displayed underneath the prompt. If this option is not specified, commands entered from the keyboard are displayed to the right side of the prompt.

**-NOCONFIRM**

Specifies that you do not want IBM Spectrum Protect to request confirmation before processing commands that affect the availability of the server or data that is managed by the server.

**-OUTFILE**

Specifies that output from a server query is displayed in one row. If the output in a row exceeds the column width that is defined by the server, the output is displayed on multiple lines in that row. This option is available in batch mode only.

**-OUTFILE=filename**

Specifies that output from a server query is redirected to a specified file. In batch mode, output is redirected to a file you specify and the format of the output matches the format of the output on your screen.

In interactive, console, or mount mode sessions, output displays on your screen.

**-PASSWORD=password**

Specifies the administrator's password.

**-QUIET**

Specifies that IBM Spectrum Protect does not display standard output messages to your screen. However, when you use this option, certain error messages still appear.

**AIX Linux -SERVERADDRESS**

**AIX Linux** Specifies the server stanza in the dsm.sys file. The client uses the server stanza to determine the server it connects to. The SERVERADDRESS option is supported by administrative clients that are running on UNIX, Linux, and Macintosh operating systems only.

**-TAB**

Specifies that any tabular output from a server query is to be formatted as tab-separated strings rather than in readable format. This option is intended to be used primarily when you redirect the output of an SQL query (SELECT command). The tab-separated value format is a standard data format, which can be processed by many common programs, including spreadsheets, databases, and report generators.

#### -TCPport

Specifies a TCP/IP port address for an IBM Spectrum Protect server. The TCPPORT option is only supported by administrative clients that are running on Windows operating systems and is valid on the Windows administrative client command line.

#### -TCPserveraddress

Specifies a TCP/IP server address for an IBM Spectrum Protect server. The TCPSEVERADDRESS option is only supported by administrative clients that are running on Windows operating systems and is valid on the Windows administrative client command line.

In addition to the options that are listed here, you can also specify any option that is in the client options file. Each option must be preceded with a hyphen and delimited with a space.

## Issuing commands from the Operations Center

---

From the Operations Center command-line interface, you can issue commands to manage IBM Spectrum Protect™ servers that are configured as hub or spoke servers.

### Procedure

---

To open the command-line interface, hover over the globe icon  in the Operations Center menu bar, and click Command Builder.

## Issuing commands from the server console

---

IBM Spectrum Protect™ provides a user ID named SERVER\_CONSOLE that allows you to issue commands and administer the server from the server console after IBM Spectrum Protect is installed. At installation, SERVER\_CONSOLE is automatically registered as an administrator and is given system authority.

### About this task

---

If you have system privilege, you can revoke or grant new privileges to the SERVER\_CONSOLE user ID. You cannot take any of the following actions:

- Register or update the SERVER\_CONSOLE user ID
- Lock or unlock the SERVER\_CONSOLE user ID
- Rename the SERVER\_CONSOLE user ID
- Remove SERVER\_CONSOLE user ID
- Route commands from the SERVER\_CONSOLE user ID

Not all IBM Spectrum Protect commands are supported by the server console. You cannot specify the WAIT parameter from the server console.

## Entering administrative commands

---

Commands consist of command names and usually parameters and variables. Syntax diagrams depict the rules to follow when entering commands.

### About this task

---

To display command-line help for server commands that have unique names, you can type `help commandName`, where *commandName* is the name of the server command for which you want information. For example, to display help for the REGISTER NODE command, type `help register node`. Command syntax and parameter descriptions are displayed in the output.

You can also type `help` followed by the topic number for the command. Topic numbers are listed in the table of contents for command-line help, for example:

```
3.0 Administrative commands
  3.46 REGISTER
    3.46.1 REGISTER ADMIN (Register an administrator)
    3.46.2 REGISTER LICENSE (Register a new license)
    3.46.3 REGISTER NODE (Register a node)
```

To display help about the REGISTER NODE command, type:

```
help 3.46.3
```

Use topic numbers to display command-line help for subcommands. DEFINE DEVCLASS is an example of a command that has subcommands. For example, you can specify the DEFINE DEVCLASS command for 3590 device classes and for 3592 device classes:

```
3.0 Administrative commands
...
3.13.10 DEFINE DEVCLASS (Define a device class)
    3.13.10.1 DEFINE DEVCLASS (Define a 3590 device class)
    3.13.10.2 DEFINE DEVCLASS (Define a 3592 device class)
    ...
```

To display help for the DEFINE DEVCLASS command for 3590 device classes, type:

```
help 3.13.10.1
```

- Reading syntax diagrams  
To read a syntax diagram for entering a command, follow the path of the line. Read from left to right and from top to bottom.
- Using continuation characters to enter long commands  
Continuation characters are useful when you want to process a command that is longer than your screen or window width. You can use continuation characters in the interactive mode of the administrative client.
- Naming IBM Spectrum Protect objects  
IBM Spectrum Protect restricts the number and type of characters that you can use to name objects.
- Using wildcard characters to specify object names  
In some commands, such as the query commands, you can use wildcard characters to create a pattern-matching expression that specifies more than one object. Using wildcard characters makes it easier to tailor a command to your needs.
- Specifying descriptions in keyword parameters  
If a description (a string of text) for a parameter begins with a single or double quotation mark, or contains any embedded blanks or equal signs, you must surround the value with either single (') or double (") quotation marks.

## Reading syntax diagrams

---

To read a syntax diagram for entering a command, follow the path of the line. Read from left to right and from top to bottom.

- The >>--- symbol indicates the beginning of a syntax diagram.
- The ---> symbol at the end of a line indicates that the syntax diagram continues onto the next line.
- The >--- symbol at the beginning of a line indicates that a syntax diagram continues from the previous line.
- The --->< symbol indicates the end of a syntax diagram.

## Command names

---

The command name can consist of a single action word, such as HALT, or it can consist of an action word and an object for the action, such as DEFINE DOMAIN. You can enter the command in any column of the input line.

Enter the entire command name or the abbreviation that is specified in the syntax diagram for the command. Uppercase letters denote the shortest acceptable abbreviation. If a command appears entirely in uppercase letters, you cannot abbreviate it. You can enter the command in uppercase letters, lowercase letters, or any combination. In this example, you can enter CMDNA, CMDNAM, or CMDNAME in any combination of uppercase and lowercase letters.

```
>>--CMDNAme-----><
```

Note: Command names in descriptive text are always capitalized.

## Required parameters

---

When a parameter is on the same line as the command name, the parameter is required. When two or more parameter values are in a stack and one of them is on the line, you *must* specify one value.

In this example, you must enter PARMNAME=A, PARMNAME=B, or PARMNAME=C. Do not include any blanks immediately before or after the equal sign (=).

```
>>-PARMName-----+A+-----><
      +-B-+
      '-C-'
```

## Optional parameters

---

When a parameter is below the line, the parameter is optional. In this example, you can enter PARMNAME=A or nothing at all. Do not include any blanks immediately before or after the equal sign (=).

```
>>-+-----+-----><
      '-PARMName-----A-'
```

When two or more parameter values are in a stack below the line, all of them are optional. In this example, you can enter PARMNAME=A, PARMNAME=B, PARMNAME=C, or nothing at all. Do not include any blanks immediately before or after the equal sign (=).

```
>>-+-----+-----><
      '-PARMName-----A-+-'
      +-B-+
      '-C-'
```

## Defaults

---

Defaults are above the line. The system uses the default unless you override it. You can override the default by entering an option from the stack below the line.

In this example, PARMNAME=A is the default. You can also enter PARMNAME=A, PARMNAME=B, or PARMNAME=C. Do not include any blanks before or after the equal sign (=).

```
.-PARMName-----A-----
>>-+-----+-----><
      '-PARMName-----A-+-'
      +-B-+
      '-C-'
```

## Variables

---

Highlighted lowercase items (like this) denote variables. In these examples, var\_name represents variables::

```
>>-CMDName--var_name-----><

>>-+-----+-----><
      '-PARMname-----var_name-'
```

## Special characters

---

You must code these symbols exactly as they appear in the syntax diagram.

- \* Asterisk
- :
- Colon
- ,



,	Comma
=	Equal sign
-	Hyphen
()	Parentheses
.	Period

## Repeating values

An arrow returning to the left means that the item can be repeated. A character within the arrow means that you must separate repeated items with that character.

```

      .- ,----- .
      v         |
>>---file_name+-----><

```

## Repeatable choices

A stack of values followed by an arrow returning to the left means that you can select more than one value or, when permitted, repeat a single item. In this example, you can choose more than one value, with each name delimited with a comma. Do not include any blanks before or after the equal sign (=).

```

      .- ,----- .
      v         |
>>-PARMName---+-----+value1+--+-----><
                +-value2--+
                '-value3-'

```

## Footnotes

Footnotes are enclosed in parentheses.

```

      .- ,----- .
      v (1)         |
>>-----file_name+-----><

```

Notes:

1. You can specify up to five file names.

## Entering parameters

The order in which you enter parameters can be important. The following example shows a portion of the command for defining a copy storage pool:

```

>>-DEFine STGpool--pool_name--device_class_name----->
>>-POOLtype----Copy--+-----+----->
                        '-DESCRIPTION----description-'
      .-REclaim----100----- .
>>+-----+-----><
      '-REclaim----percent-'

```

The first two parameters in this command (*pool\_name* and *device\_class\_name*) are required parameters. *pool\_name* and *device\_class\_name* are also positional. That is, they must be entered in the order shown, immediately after the command name. The POOLTYPE parameter is a required keyword parameter. DESCRIPTION and RECLAIM, are optional keyword parameters.

Keyword parameters are identified by an equal sign that specifies a specific value or a variable. Keyword parameters must follow any positional parameters in a command.

The following command entries, in which the keyword parameters are ordered differently, are both acceptable:

```
define stgpool mycopypool mydeviceclass pooltype=copy description=engineering
    reclaim=50
define stgpool mycopypool mydeviceclass description=engineering pooltype=copy
    reclaim=50
```

The following example, in which one of the positional parameters follows a keyword parameter, is not acceptable:

```
define stgpool mycopypool pooltype=copy mydeviceclass description=engineering
    reclaim=50
```

## Syntax fragments

---

Some diagrams, because of their length, must display parts of the syntax with fragments. The fragment name appears between vertical bars in the diagram.

The expanded fragment appears in the diagram after all other parameters or at the bottom of the diagram. A heading with the fragment name identifies the expanded fragment. Commands appearing directly on the line are required.

In this example, the fragment is named "Fragment".

```
>>-| Fragment |-----><
Fragment
    .-A-.
|---+-----|
    +-B-+
    '-C-'
```

## Using continuation characters to enter long commands

---

Continuation characters are useful when you want to process a command that is longer than your screen or window width. You can use continuation characters in the interactive mode of the administrative client.

### About this task

---

Without continuation characters, you can enter up to 256 characters. With continuation characters, you can enter up to 1500 characters.

Note: In the MACRO command, the maximums apply after any substitution variables have been applied.

With continuation characters, you can do the following:

- Enter a dash at the end of the line you want to continue.

For example:

```
register admin pease mypasswd -
contact="david, ext1234"
```

- Continue a list of values by entering a dash or a back slash, with no preceding blank spaces, after the last comma of the list that you enter on the first line. Then, enter the remaining items in the list on the next line with no preceding blank spaces.

For example:

```
stgpools=stg1, stg2, stg3, -
stg4, stg5, stg6
```

- Continue a string of values that are enclosed in quotation marks by entering the first part of the string that is enclosed in quotation marks, followed by a dash or a back slash at the end of the line. Then, enter the remainder of the string on the next line, enclosed in the same type of quotation marks.

For example:

```
contact="david pease, bldg. 100, room 2b, san jose,"-
"ext. 1234, alternate contact-norm pass,ext 2345"
```

IBM Spectrum Protect™ concatenates the two strings with no intervening blanks. You must use only this method to continue a quoted string of values across more than one line.

## Naming IBM Spectrum Protect objects

IBM Spectrum Protect™ restricts the number and type of characters that you can use to name objects.

### About this task

The following characters are available for defining object names.

Character	Description
A–Z	Any letter, A through Z
0–9	Any number, 0 through 9
_	Underscore
.	Period
-	Hyphen
+	Plus
&	Amperсанд

The following table shows the maximum length of characters permitted for naming objects.

Type of Name	Maximum Length
Administrators, client option sets, client nodes, passwords, server groups, server, names, virtual file space names	64
Restartable export identifiers	64
High-level and low-level TCP/IP (IPv4 or IPv6) addresses	64
Device classes, drives, libraries, management classes, policy domains, profiles, schedules scripts, backup sets, storage pools	30

The following characters are available for defining password names:

```
a b c d e f g h i j k l m n o p q r s t u v w x y z
A B C D E F G H I J K L M N O P Q R S T U V W X Y Z
0 1 2 3 4 5 6 7 8 9 . ! @ # $ % ^ & * _ - + = ` ( )
| { } [ ] : ; < > , ? / ~
```

Passwords considered "LOCAL" are those passwords that authenticate with the IBM Spectrum Protect server and are not case-sensitive. Once a node or administrator is updated to use the SESSIONSECURITY=STRICT parameter, the password becomes case-sensitive the next time you change the it. Passwords considered "LDAP" are those passwords that authenticate with an LDAP directory server and are case-sensitive.

When you use DEFINE commands to define database, recovery log, and storage pool volumes, the naming convention for the volume name is dependent on the type of sequential access media or random access media that you are using. Refer to the specific VOLUME command for details.

## Using wildcard characters to specify object names

In some commands, such as the query commands, you can use wildcard characters to create a pattern-matching expression that specifies more than one object. Using wildcard characters makes it easier to tailor a command to your needs.

### About this task

The wildcard characters you use depend on the operating system from which you issue commands. For example, you can use wildcard characters such as an asterisk (\*) to match any (0 or more) characters, or you can use a question mark (?) or a percent sign (%) to match exactly one character.

Table 1 provides references to wildcard characters for some operating systems. Use wildcard characters appropriate for your system.

Table 1. Wildcard characters by operating system

Operating system	Match any	Match exactly one
AIX®, Linux, Windows	*	?
TSO	*	%

For example, if you want to query all the management classes whose names begin with DEV in all the policy sets in DOMAIN1, and your system uses an asterisk as the *match-any* character, you can enter:

```
query mgmtclass domain1 * dev*
```

If your system uses a question mark as the *match-exactly-one* character, and you want to query the management classes in POLICYSET1 in DOMAIN1, you can enter:

```
query mgmtclass domain1 policyset1 mc?
```

IBM Spectrum Protect™ displays information about management classes with names MC.

Table 2 shows additional examples of using wildcard characters to match any characters.

Table 2. Match-any character

Pattern	Matches	Does not match
ab*	ab, abb, abxxx	a, b, aa, bb
ab*rs	abrs, abtrs, abrsrs	ars, aabrs, abrss
ab*ef*rs	abefrs, abefghrs	abefr, abers

Table 3 shows additional examples of using wildcard characters to match exactly one character. The question mark (?) can be replaced by a percent sign (%) if your platform uses that character instead of (?).

Table 3. Match-exactly-one character

Pattern	Matches	Does not match
ab?	abc	ab, abab, abzzzz
ab?rs	abfrs	abrs, abllrs
ab?ef?rs	abdefjrs	abefrs, abdefrs, abefjrs
ab??rs	abcdrs, abzzrs	abrs, abjrs, abkkrs

## Specifying descriptions in keyword parameters

If a description (a string of text) for a parameter begins with a single or double quotation mark, or contains any embedded blanks or equal signs, you must surround the value with either single (') or double (") quotation marks.

### About this task

The opening and closing quotation marks must be the same type of quotation marks. For example, if the opening quotation is a single quotation mark, the closing quotation mark must also be a single quotation mark.

For example, to register a new client node named Louie, with a password of secret, and with his title included as contact information, enter:

```
register node louie secret contact="manager of dept. 61f"
```

The following table presents ways of entering a description for the CONTACT parameter. The value can contain quotation marks, embedded blanks, or equal signs.

For this description	Enter this
----------------------	------------

For this description	Enter this
manager	contact=manager
manager's	contact="manager's" or contact='manager's'
"manager"	contact=""manager"" or contact=""manager""
manager's report	contact="manager's report" or contact='manager's report'
manager's "report"	contact='manager's "report"'
manager=dept. 61f	contact='manager=dept. 61f'
manager reports to dept. 61f	contact='manager reports to dept. 61f' or contact="manager reports to dept. 61f"

## Controlling command processing

You can run some IBM Spectrum Protect™ commands sequentially or concurrently with other commands. You can also route commands from one server to other servers for processing.

### About this task

- Server command processing  
IBM Spectrum Protect processes administrator commands either in the foreground or in the background. Commands that process in the foreground must complete before you can issue another command. When commands are processing in the background, you can issue additional commands at any time.
- Stopping background processes  
Use the CANCEL PROCESS command to cancel commands that generate background processes.

## Server command processing

IBM Spectrum Protect™ processes administrator commands either in the foreground or in the background. Commands that process in the foreground must complete before you can issue another command. When commands are processing in the background, you can issue additional commands at any time.

Most IBM Spectrum Protect commands process in the foreground. For some commands that normally process in the background (for example, BACKUP DB), you can specify the WAIT parameter (WAIT=YES) with the command so that the command processes in the foreground. You might want to process a command in the foreground rather than in the background for any of the following reasons:

- To quickly determine whether a command completed successfully. When you issue a command that processes in the foreground, IBM Spectrum Protect sends a confirmation message that indicates that the command completed successfully. If you process the command in the background, you need to open operational reporting or query the activity log to determine whether the command completed successfully.
- To monitor server activities (for example, messages) on the administrative client as a command is being processed. This might be preferable to searching a long activity log after the command has completed.
- To be able to start another process immediately after a command completed. For example, you might specify WAIT=YES for a command that takes a short time to process so that, when the processing completes, you can immediately start processing another command.
- To serialize commands in an administrative script when it is important that one command completes before another begins.

Check the individual command description to determine whether a command has a WAIT parameter.

You can cancel commands that are processed in the foreground from the server console or from another administrative client session.

Each background process is assigned a process number. Use the QUERY PROCESS command to obtain the status and process number of a background process.

Note:

- If you are defining a schedule with a command that specifies WAIT=NO (the default), and you issue QUERY EVENT to determine the status of your scheduled operation, failed operations report an event status of COMPLETED with a return of

OK. In order for the QUERY EVENT output to reflect the failed status, the WAIT parameter must be set to YES. This runs the scheduled operation in the foreground and informs you of the status when it completes.

- You cannot process commands in the foreground from the server console.

## Stopping background processes

---

Use the CANCEL PROCESS command to cancel commands that generate background processes.

### About this task

---

Use the QUERY PROCESS command to obtain the status and process number of a background process. If a background process is active when you cancel it, the server stops the process. Any changes that are uncommitted are rolled back. However, changes that are committed are not rolled back.

When you issue a QUERY command from the administrative client, multiple screens of output might be generated. If this occurs and additional output is not needed, you can cancel the display of output to the client workstation. Doing so does not end the processing of the command.

## Performing tasks concurrently on multiple servers

---

Command routing allows you to route commands to one or more servers for processing and then collect the output from these servers.

### About this task

---

To route commands to other servers, you must have the same administrator ID and password as well as the required administrative authority on each server to which the command is being routed. You cannot route commands to other servers from the server console.

After the command has completed processing on all servers, the output displays, in its entirety, for each server. For example, the output from SERVER\_A displays in its entirety, followed by the output from SERVER\_B. The output includes summary messages for each individual server and identifies which server processed the output. Return codes indicate whether commands processed on the servers successfully. These return codes include one of three severities: 0, ERROR, or WARNING.

Each server that is identified as the target of a routed command must first be defined using the DEFINE SERVER command. The command is automatically routed to all servers specified as members of a server group or to individual servers specified with the command.

The following examples describe how to route the QUERY STGPOOL command to one server, multiple servers, a server group, multiple server groups, or a combination of servers and server groups. Each server or server group in a list must be separated with a comma, without spaces.

## Routing commands to a single server

---

### Procedure

To route the QUERY STGPOOL command to a server named ASTRO, enter:

```
astro: query stgpool
```

The colon after the server name indicates the end of the routing information. This is also called the *server prefix*. Another way to indicate the end of routing information is to use parentheses around the server name, for example:

```
(astro) query stgpool
```

## Routing commands to multiple servers

---

### About this task

### Procedure

To route the QUERY STGPOOL command to multiple servers named HD\_QTR, MIDAS, SATURN, enter:

```
hd_qtr,midas,saturn: query stgpool
```

If the first server has not been defined to IBM Spectrum Protect, the command is routed to the next defined server in the list of servers.

You can also enter the command this way:

```
(hd_qtr,midas,saturn) query stgpool
```

## Routing commands to a server group

---

### About this task

In this example, the server group ADMIN has servers named SECURITY, PAYROLL, PERSONNEL defined as group members. The command is routed to each of these servers.

### Procedure

To route the QUERY STGPOOL command to the server group named ADMIN, enter:

```
admin: query stgpool
```

You can also enter the command this way:

```
(admin) query stgpool
```

## Routing commands to server groups

---

### About this task

In this example, the server group ADMIN2 has servers SERVER\_A, SERVER\_B, and SERVER\_C defined as group members, and server group ADMIN3 has servers ASTRO, GUMBY, and CRUSTY defined as group members. The command is routed to servers SERVER\_A, SERVER\_B, SERVER\_C, ASTRO, GUMBY, and CRUSTY.

### Procedure

To route the QUERY STGPOOL command to two server groups that are named ADMIN2 and ADMIN3, enter:

```
admin2,admin3: query stgpool
```

You can also enter the command this way:

```
(admin2,admin3) query stgpool
```

## Routing commands to two servers and a server group

---

### About this task

In this example, the server group DEV\_GROUP has servers SALES, MARKETING, and STAFF defined as group members. The command is routed to servers SALES, MARKETING, STAFF, MERCURY, and JUPITER.

### Procedure

To route the QUERY STGPOOL command to a server group named DEV\_GROUP and to the servers named MERCURY and JUPITER, enter:

```
dev_group,mercury,jupiter: query stgpool
```

You can also enter the command this way:

```
(dev_group,mercury,jupiter) query stgpool
```

## Routing commands inside scripts

---

### About this task

When routing commands inside scripts, you must enclose the server or server group in parentheses and omit the colon. Otherwise, the command will not be routed when the RUN command is issued, and will only be run on the server where the RUN command is issued.

For example, to route the QUERY STGPOOL command inside a script:

## Procedure

1. Define a script called QU\_STG to route it to the DEV\_GROUP server group.

```
define script qu_stg "(dev_group) query stgpool"
```

2. Run the QU\_STG script:

```
run qu_stg
```

## Results

In this example, the server group DEV\_GROUP has servers SALES, MARKETING, and STAFF defined as group members. The QUERY STGPOOL command is routed to these servers.

## Privilege classes for commands

---

The authority granted to an administrator through the privilege class determines which administrative commands that the administrator can issue.

There are four administrator privilege classes in IBM Spectrum Protect™:

- System
- Policy
- Storage
- Operator

After an administrator has been registered using the REGISTER ADMIN command, the administrator can issue a limited set of commands, including all query commands. When you install IBM Spectrum Protect, the server console is defined as a system administrator named SERVER\_CONSOLE and is granted system privilege.

- **Commands requiring system privilege**  
An administrator with system privilege has the highest level of authority for the server. With system privilege, an administrator can issue any administrative command and has authority to manage all policy domains and all storage pools.
- **Commands requiring policy privilege**  
An administrator with policy privilege can issue commands that relate to policy management objects such as policy domains, policy sets, management classes, copy groups, and schedules. The policy privilege can be unrestricted, or can be restricted to specific policy domains.
- **Commands requiring storage privilege**  
An administrator with storage privilege can issue commands that allocate and control storage resources for the server. The storage privilege can be unrestricted, or can be restricted to specific storage pools.
- **Commands requiring operator privilege**  
An administrator with operator privilege can issue commands that control the immediate operation of the server and the availability of storage media.
- **Commands any administrator can issue**  
A limited number of commands can be used by any administrator, even if that administrator has not been granted any specific administrator privileges.

## Commands requiring system privilege

---

An administrator with system privilege has the highest level of authority for the server. With system privilege, an administrator can issue any administrative command and has authority to manage all policy domains and all storage pools.

Table 1 lists the commands that administrators with system privilege can issue. In some cases administrators with lower levels of authority, for example, unrestricted storage privilege, can also issue these commands. In addition, the REQSYSAUTHOUTFILE server option can be used to specify that certain commands require system privilege if they cause the server to write to an external file. For more information about this server option, review REQSYSAUTHOUTFILE.



Table 1. System privilege commands

Command name	Command name
<ul style="list-style-type: none"> <li>• AUDIT LDAPDIRECTORY</li> <li>• AUDIT LICENSES</li> <li>• ACCEPT DATE</li> <li>• BEGIN EVENTLOGGING</li> <li>• CANCEL EXPIRATION</li> <li>• CANCEL PROCESS</li> <li>• CANCEL REPLICATION</li> <li>• CANCEL REQUEST</li> <li>• CANCEL RESTORE</li> <li>• CLEAN DRIVE</li> <li>• COPY ACTIVATEDATA</li> <li>• COPY DOMAIN</li> <li>• COPY POLICYSET</li> <li>• COPY PROFILE</li> <li>• COPY SCHEDULE (Review note.)</li> <li>• COPY SCRIPT</li> <li>• COPY SERVERGROUP</li> <li>• DEFINE BACKUPSET</li> <li>• DEFINE CLIENTACTION</li> <li>• DEFINE CLIENTOPT</li> <li>• DEFINE CLOPTSET</li> <li>• DEFINE COLLOGGROUP</li> <li>• DEFINE COLLOCMEMBER</li> <li>• DEFINE DEVCLASS</li> <li>• DEFINE DOMAIN</li> <li>• DEFINE DRIVE</li> <li>• DEFINE EVENTSERVER</li> <li>• DEFINE GRPMEMBER</li> <li>• DEFINE LIBRARY</li> <li>• DEFINE MACHINE</li> <li>• DEFINE MACHNODEASSOCIATION</li> <li>• DEFINE NODEGROUP</li> <li>• DEFINE NODEGROUPMEMBER</li> <li>• DEFINE PATH</li> <li>• DEFINE PROFASSOCIATION</li> <li>• DEFINE PROFILE</li> <li>• DEFINE RECMEDMACHASSOCIATION</li> <li>• DEFINE RECOVERYMEDIA</li> <li>• DEFINE SCHEDULE (Review note.)</li> <li>• DEFINE SCRIPT</li> <li>• DEFINE SERVER</li> <li>• DEFINE SERVERGROUP</li> </ul>	<ul style="list-style-type: none"> <li>• DEFINE SPACETRIGGER</li> <li>• DEFINE STGPOOL</li> <li>• DEFINE SUBSCRIPTION</li> <li>• DEFINE VIRTUALFSMAPPING</li> <li>• DEFINE VOLUME</li> <li>• DELETE BACKUPSET</li> <li>• DELETE CLIENTOPT</li> <li>• DELETE CLOPTSET</li> <li>• DEFINE COLLOGGROUP</li> <li>• DEFINE COLLOCMEMBER</li> <li>• DELETE DOMAIN</li> <li>• DELETE DRIVE</li> <li>• DELETE EVENTSERVER</li> <li>• DELETE GRPMEMBER</li> <li>• DELETE LIBRARY</li> <li>• DELETE MACHINE</li> <li>• DELETE MACHNODEASSOCIATION</li> <li>• DELETE NODEGROUP</li> <li>• DELETE NODEGROUPMEMBER</li> <li>• DELETE PROFASSOCIATION</li> <li>• DELETE PROFILE</li> <li>• DELETE RECMEDMACHASSOCIATION</li> <li>• DELETE RECOVERYMEDIA</li> <li>• DELETE SCHEDULE (Review note.)</li> <li>• DELETE SCRIPT</li> <li>• DELETE SERVER</li> <li>• DELETE SERVERGROUP</li> <li>• DELETE SPACETRIGGER</li> <li>• DELETE STGPOOL</li> <li>• DELETE SUBSCRIBER</li> <li>• DELETE SUBSCRIPTION</li> <li>• DELETE VIRTUALFSMAPPING</li> <li>• DISABLE EVENTS</li> <li>• ENABLE EVENTS</li> <li>• END EVENTLOGGING</li> <li>• EXPIRE INVENTORY</li> <li>• EXPORT ADMIN</li> <li>• EXPORT NODE</li> <li>• EXPORT POLICY</li> <li>• EXPORT SERVER</li> <li>• GENERATE BACKUPSET</li> <li>• GRANT AUTHORITY</li> </ul>

Command name	Command name
<ul style="list-style-type: none"> <li>• GRANT PROXYNODE</li> <li>• IDENTIFY DUPLICATES</li> <li>• IMPORT NODE</li> <li>• IMPORT POLICY</li> <li>• IMPORT SERVER</li> <li>• INSERT MACHINE</li> <li>• LABEL LIBVOLUME</li> <li>• LOCK ADMIN</li> <li>• LOCK PROFILE</li> <li>• MIGRATE STGPOOL</li> <li>• MOVE DRMEDIA</li> <li>• MOVE MEDIA</li> <li>• MOVE GRPMEMBER</li> <li>• NOTIFY SUBSCRIBERS</li> <li>• PERFORM LIBACTION</li> <li>• PING SERVER</li> <li>• PREPARE</li> <li>• QUERY BACKUPSETCONTENTS</li> <li>• QUERY MEDIA</li> <li>• QUERY RPFCONTENT</li> <li>• QUERY TOC</li> <li>• RECLAIM STGPOOL</li> <li>• RECONCILE VOLUMES</li> <li>• REGISTER ADMIN</li> <li>• REGISTER LICENSE</li> <li>• REMOVE ADMIN</li> <li>• REMOVE REPLNODE</li> <li>• RENAME ADMIN</li> <li>• RENAME SCRIPT</li> <li>• RENAME SERVERGROUP</li> <li>• RENAME STGPOOL</li> <li>• REPLICATE NODE</li> <li>• RESET PASSEXP</li> <li>• RESTORE NODE</li> <li>• REVOKE AUTHORITY</li> <li>• REVOKE PROXYNODE</li> <li>• RUN</li> <li>• SET ACCOUNTING</li> <li>• SET ACTLOGRETENTION</li> <li>• SET ARCHIVERETENTIONPROTECTION</li> <li>• SET ARREPLRULEDEFAULT</li> <li>• SET BKREPLRULEDEFAULT</li> <li>• SET CLIENTACTDURATION</li> </ul>	<ul style="list-style-type: none"> <li>• SET CONFIGMANAGER</li> <li>• SET CONFIGREFRESH</li> <li>• SET CONTEXTMESSAGING</li> <li>• SET CROSSDEFINE</li> <li>• SET DBRECOVERY</li> <li>• SET DEFAULTAUTHENTICATION</li> <li>• SET DRMACTIVEDATASTGPOOL</li> <li>• SET DRMCHECKLABEL</li> <li>• SET DRMCMDFILENAME</li> <li>• SET DRMCOPYCONTAINERSTGPOOL</li> <li>• SET DRMCOPYSTGPOOL</li> <li>• SET DRMCOURIERNAME</li> <li>• SET DRMDBBACKUPEXPIREDAYS</li> <li>• SET DRMFILEPROCESS</li> <li>• SET DRMINSTRPREFIX</li> <li>• SET DRMNOTMOUNTABLENAME</li> <li>• SET DRMPLANPREFIX</li> <li>• SET DRMPLANVPOSTFIX</li> <li>• SET DRMPRIMSTGPOOL</li> <li>• SET DRMRPFEXPIREDAYS</li> <li>• SET DRMVaultNAME</li> <li>• SET EVENTRETENTION</li> <li>• SET INVALIDPWLIMIT</li> <li>• SET LDAPPASSWORD</li> <li>• SET LDAPUSER</li> <li>• SET LICENSEAUDITPERIOD</li> <li>• SET MAXCMDRETRIES</li> <li>• SET MAXSCHEDSESSIONS</li> <li>• SET MINPWLENGTH</li> <li>• SET PASSEXP</li> <li>• SET QUERYSCHEDPERIOD</li> <li>• SET RANDOMIZE</li> <li>• SET REPLRETENTION</li> <li>• SET REPLSERVER</li> <li>• SET RETRYPERIOD</li> <li>• SET SCHEDMODES</li> <li>• SET SERVERHLADDRESS</li> <li>• SET SERVERLLADDRESS</li> <li>• SET SERVERNAME</li> <li>• SET SERVERPASSWORD</li> <li>• SET SPREPLRULEDEFAULT</li> <li>• SET SUBFILE</li> <li>• SET TOCLOADRETENTION</li> </ul>
<ul style="list-style-type: none"> <li>• SETOPT</li> <li>• UNLOCK ADMIN</li> <li>• UNLOCK PROFILE</li> <li>• UPDATE ADMIN</li> <li>• UPDATE BACKUPSET</li> <li>• UPDATE CLIENTOPT</li> <li>• UPDATE CLOPTSET</li> <li>• UPDATE COLLOGGROUP</li> <li>• UPDATE DEVCLASS</li> <li>• UPDATE DRIVE</li> <li>• UPDATE LIBRARY</li> <li>• UPDATE LIBVOLUME</li> <li>• UPDATE MACHINE</li> </ul>	<ul style="list-style-type: none"> <li>• UPDATE NODEGROUP</li> <li>• UPDATE PATH</li> <li>• UPDATE PROFILE</li> <li>• UPDATE RECOVERYMEDIA</li> <li>• UPDATE REPLRULE</li> <li>• UPDATE SCHEDULE (Review note.)</li> <li>• UPDATE SCRIPT</li> <li>• UPDATE SERVER</li> <li>• UPDATE SERVERGROUP</li> <li>• UPDATE SPACETRIGGER</li> <li>• UPDATE VIRTUALFSMAPPING</li> <li>• UPDATE VOLHISTORY</li> <li>• VALIDATE LANFREE</li> <li>• VALIDATE REPLICATION</li> </ul>

Command name	Command name
Note: This command is restricted by the authority that is granted to an administrator. System privilege is required only for administrative command schedules. System or policy privilege is required for client operation schedules.	

## Commands requiring policy privilege

An administrator with policy privilege can issue commands that relate to policy management objects such as policy domains, policy sets, management classes, copy groups, and schedules. The policy privilege can be unrestricted, or can be restricted to specific policy domains.

With unrestricted policy privilege, you can issue all of the administrator commands that require policy privilege. You can issue commands that affect all existing policy domains as well as any policy domains that are defined in the future. An unrestricted policy administrator cannot define, delete, or copy policy domains.

With restricted policy privilege, you can issue administrator commands that affect one or more policy domains for which authority is granted. For example, the DELETE MGMTCLASS command requires you to have policy privilege for the policy domain to which the management class belongs.

Table 1 lists the commands that an administrator with policy privilege can issue.

Table 1. Policy privilege commands

Command name	Command name
<ul style="list-style-type: none"> <li>• ACTIVATE POLICYSET</li> <li>• ASSIGN DEFMGMTCLASS</li> <li>• CLEAN DRIVE</li> <li>• BACKUP NODE</li> <li>• COPY MGMTCLASS</li> <li>• COPY POLICYSET</li> <li>• COPY SCHEDULE (Review note 2.)</li> <li>• DEFINE ASSOCIATION</li> <li>• DEFINE BACKUPSET</li> <li>• DEFINE COPYGROUP</li> <li>• DEFINE CLIENTACTION</li> <li>• DEFINE CLIENTOPT</li> <li>• DEFINE MGMTCLASS</li> <li>• DEFINE NODEGROUP</li> <li>• DEFINE NODEGROUPMEMBER</li> <li>• DEFINE POLICYSET</li> <li>• DEFINE SCHEDULE</li> <li>• DELETE ASSOCIATION</li> <li>• DELETE BACKUPSET</li> <li>• DELETE COPYGROUP</li> <li>• DELETE EVENT (Review note 1.)</li> <li>• DELETE FILESPACE</li> <li>• DELETE MGMTCLASS</li> <li>• DELETE NODEGROUP</li> <li>• DELETE NODEGROUPMEMBER</li> </ul>	<ul style="list-style-type: none"> <li>• DELETE POLICYSET</li> <li>• DELETE PATH</li> <li>• DELETE SCHEDULE (Review note 2.)</li> <li>• GENERATE BACKUPSET</li> <li>• LOCK NODE</li> <li>• QUERY BACKUPSETCONTENTS</li> <li>• REGISTER NODE</li> <li>• REMOVE NODE</li> <li>• RENAME FILESPACE</li> <li>• RENAME NODE</li> <li>• SET SUMMARYRETENTION</li> <li>• RESTORE NODE</li> <li>• QUERY TOC</li> <li>• UNLOCK NODE</li> <li>• UPDATE BACKUPSET</li> <li>• UPDATE COPYGROUP</li> <li>• UPDATE DOMAIN</li> <li>• UPDATE MGMTCLASS</li> <li>• UPDATE NODE</li> <li>• UPDATE NODEGROUP</li> <li>• UPDATE POLICYSET</li> <li>• UPDATE SCHEDULE (Review note 2.)</li> <li>• VALIDATE POLICYSET</li> </ul>
Notes:	
<ol style="list-style-type: none"> <li>1. This command can be restricted by policy domain. An administrator with unrestricted policy privilege or restricted policy privilege for a specified policy domain can issue this command.</li> <li>2. This command is restricted by the authority that is granted to an administrator. System privilege is required only for administrative command schedules. System or policy privilege is required for client operation schedules.</li> </ol>	

## Commands requiring storage privilege

An administrator with storage privilege can issue commands that allocate and control storage resources for the server. The storage privilege can be unrestricted, or can be restricted to specific storage pools.

Unrestricted storage privilege permits you to issue all of the administrator commands that require storage privilege. You can issue commands that affect all existing storage pools as well as any storage pools that are defined in the future. You can also issue commands that affect the database and the recovery log. An unrestricted storage administrator cannot define or delete storage pools.

Restricted storage privilege permits you to issue administrator commands that only affect a storage pool for which you have been granted authority. For example, the DELETE VOLUME command only affects a storage pool volume that is defined to a specific storage pool.

Table 1 lists the commands an administrator with storage privilege can issue.

Table 1. Storage privilege commands

Command name	Command name
<ul style="list-style-type: none"> <li>• AUDIT LIBRARY</li> <li>• AUDIT VOLUME (Review note.)</li> <li>• BACKUP DB</li> <li>• BACKUP DEVCONFIG</li> <li>• BACKUP STGPOOL</li> <li>• BACKUP VOLHISTORY</li> <li>• CHECKIN LIBVOLUME</li> <li>• CHECKOUT LIBVOLUME</li> <li>• COPY ACTIVATEDATA (Review note.)</li> <li>• DEFINE COLLOGGROUP</li> <li>• DEFINE COLLOCMEMBER</li> <li>• DEFINE DATAMOVER</li> <li>• DEFINE DEVCLASS</li> <li>• DEFINE DRIVE</li> <li>• DEFINE LIBRARY</li> <li>• DEFINE PATH</li> <li>• DEFINE VIRTUALFSMAPPING</li> <li>• DEFINE VOLUME (Review note.)</li> <li>• DEFINE SPACETRIGGER</li> <li>• DELETE COLLOGGROUP</li> <li>• DELETE COLLOCMEMBER</li> <li>• DELETE DATAMOVER</li> <li>• DELETE DEVCLASS</li> <li>• DELETE DRIVE</li> <li>• DELETE LIBRARY</li> <li>• DELETE PATH</li> </ul>	<ul style="list-style-type: none"> <li>• DELETE SPACETRIGGER</li> <li>• DELETE VIRTUALFSMAPPING</li> <li>• DELETE VOLHISTORY</li> <li>• DELETE VOLUME (Review note.)</li> <li>• GRANT PROXYNODE</li> <li>• LABEL LIBVOLUME</li> <li>• MIGRATE STGPOOL</li> <li>• MOVE DATA (Review note.)</li> <li>• MOVE MEDIA</li> <li>• QUERY TAPEALERTMSG</li> <li>• RECLAIM STGPOOL</li> <li>• RESTORE STGPOOL</li> <li>• RESTORE VOLUME</li> <li>• REVOKE PROXYNODE</li> <li>• SET TAPEALERTMSG</li> <li>• UPDATE COLLOGGROUP</li> <li>• UPDATE DATAMOVER</li> <li>• UPDATE DEVCLASS</li> <li>• UPDATE DRIVE</li> <li>• UPDATE LIBRARY</li> <li>• UPDATE PATH</li> <li>• UPDATE SPACETRIGGER</li> <li>• UPDATE STGPOOL (Review note.)</li> <li>• UPDATE VIRTUALFSMAPPING</li> </ul>
<p>Note: This command can be restricted by storage pool. An administrator with unrestricted storage privilege or restricted storage privilege for a specified storage pool can issue this command.</p>	

## Commands requiring operator privilege

An administrator with operator privilege can issue commands that control the immediate operation of the server and the availability of storage media.

Table 1 lists the commands an administrator with operator privilege can issue.

Table 1. Operator privilege commands

Command Name	Command Name

Command Name	Command Name
<ul style="list-style-type: none"> <li>• CANCEL SESSION</li> <li>• DISABLE SESSIONS</li> <li>• DISMOUNT VOLUME</li> <li>• ENABLE SESSIONS</li> <li>• HALT</li> </ul>	<ul style="list-style-type: none"> <li>• MOVE DRMEDIA</li> <li>• MOVE MEDIA</li> <li>• QUERY MEDIA</li> <li>• REPLY</li> <li>• UPDATE VOLUME</li> <li>• VARY</li> </ul>

## Commands any administrator can issue

A limited number of commands can be used by any administrator, even if that administrator has not been granted any specific administrator privileges.

Table 1 lists the commands any registered administrator can issue.

Table 1. Commands issued by all administrators

Command Name	Command Name
<ul style="list-style-type: none"> <li>• COMMIT</li> <li>• HELP</li> <li>• ISSUE MESSAGE</li> <li>• MACRO</li> <li>• PARALLEL</li> <li>• QUERY ACTLOG</li> <li>• QUERY ADMIN</li> <li>• QUERY ASSOCIATION</li> <li>• QUERY AUDITOCUPANCY</li> <li>• QUERY BACKUPSET</li> <li>• QUERY CLOPTSET</li> <li>• QUERY COLLOGROUP</li> <li>• QUERY CONTENT</li> <li>• QUERY COPYGROUP</li> <li>• QUERY DATAMOVER</li> <li>• QUERY DB</li> <li>• QUERY DBSPACE</li> <li>• QUERY DEVCLASS</li> <li>• QUERY DIRSPACE</li> <li>• QUERY DOMAIN</li> <li>• QUERY DRIVE</li> <li>• QUERY DRMEDIA</li> <li>• QUERY DRMSTATUS</li> <li>• QUERY ENABLED</li> <li>• QUERY EVENT</li> <li>• QUERY EVENTRULES</li> <li>• QUERY EVENTSERVER</li> <li>• QUERY FILESPACE</li> <li>• QUERY LIBRARY</li> <li>• QUERY LIBVOLUME</li> <li>• QUERY LICENSE</li> <li>• QUERY LOG</li> <li>• QUERY MACHINE</li> <li>• QUERY MGMTCLASS</li> <li>• QUERY MOUNT</li> <li>• QUERY NASBACKUP</li> </ul>	<ul style="list-style-type: none"> <li>• QUERY NODE</li> <li>• QUERY NODEDATA</li> <li>• QUERY NODEGROUP</li> <li>• QUERY OCCUPANCY</li> <li>• QUERY OPTION</li> <li>• QUERY PATH</li> <li>• QUERY POLICYSET</li> <li>• QUERY PROCESS</li> <li>• QUERY PROFILE</li> <li>• QUERY PROXYNODE</li> <li>• QUERY RECOVERYMEDIA</li> <li>• QUERY REPLICATION</li> <li>• QUERY REPLNODE</li> <li>• QUERY REPLRULE</li> <li>• QUERY REQUEST</li> <li>• QUERY RESTORE</li> <li>• QUERY RPFIL</li> <li>• QUERY SCHEDULE</li> <li>• QUERY SCRIPT</li> <li>• QUERY SERVER</li> <li>• QUERY SERVERGROUP</li> <li>• QUERY SESSION</li> <li>• QUERY SPACETRIGGER</li> <li>• QUERY STATUS</li> <li>• QUERY STGPOOL</li> <li>• QUERY SUBSCRIBER</li> <li>• QUERY SUBSCRIPTION</li> <li>• QUERY SYSTEM</li> <li>• QUERY VIRTUALFSMAPPING</li> <li>• QUERY VOLHISTORY</li> <li>• QUERY VOLUME</li> <li>• QUIT</li> <li>• ROLLBACK</li> <li>• SELECT</li> <li>• SERIAL</li> </ul>

## Administrative commands

Administrative commands are available to manage and configure the server.

Information for each command includes:

- A description of the tasks a command performs
  - The administrator privilege class required to use the command
  - A syntax diagram that identifies the required and optional parameters for the command
  - Descriptions of each parameter of the command
  - Examples of using the command
  - A list of related commands
- **ACCEPT DATE** (Accepts the current system date)  
Use this command to allow the server to begin normal processing, when the server does not start normal processing because of a discrepancy between the server date and the current date on the system.
  - **ACTIVATE POLICYSET** (Activate a new policy set)  
Use this command to copy the contents of a policy set to the ACTIVE policy set for the domain. The server uses the rules in the ACTIVE policy set to manage client operations in the domain. You can define multiple policy sets for a policy domain, but only one policy set can be active. The current ACTIVE policy set is replaced by the one you specify when you issue this command. You can modify the ACTIVE policy set only by activating another policy set.
  - **ASSIGN DEFMGMTCLASS** (Assign a default management class)  
Use this command to specify a management class as the default management class for a policy set. You must assign a default management class for a policy set before you can activate that policy set.
  - **AUDIT** commands  
Use the AUDIT commands to review or examine the adequacy of the database information and the storage pool volume. The AUDIT LDAPDIRECTORY command deletes nodes or administrator IDs from an LDAP directory server, that do not authenticate their passwords with the LDAP directory server.
  - **BACKUP** commands  
Use the BACKUP commands to create backup copies of IBM Spectrum Protect™ information or objects.
  - **BEGIN EVENTLOGGING** (Begin logging events)  
Use this command to begin logging events to one or more receivers. A receiver for which event logging has begun is an *active receiver*.
  - **CANCEL** commands  
Use the CANCEL commands to end a task or process before it is completed.
  - **CHECKIN LIBVOLUME** (Check a storage volume into a library)  
Use this command to add a sequential access storage volume or a cleaning tape to the server inventory for an automated library. The server cannot use a volume that physically resides in an automated library until that volume is checked in.
  - **CHECKOUT LIBVOLUME** (Check a storage volume out of a library)  
Use this command to remove a sequential access storage volume from the server inventory for an automated library. This command creates a background process that can be canceled with the CANCEL PROCESS command. To display information on background processes, use the QUERY PROCESS command.
  - **CLEAN DRIVE** (Clean a drive)  
Use this command when you want IBM Spectrum Protect to immediately load a cleaner cartridge into a drive regardless of the cleaning frequency.
  - **COMMIT** (Control committing of commands in a macro)  
Use this command to control when a command is committed in a macro and to update the database when commands complete processing. When issued from the console mode of the administrative client, this command does not generate a message.
  - **CONVERT STGPOOL** (Convert a storage pool to a container storage pool)  
Use this command to convert a primary storage pool that uses a FILE device class, a tape device class, or a virtual tape library (VTL) to a directory-container or a cloud-container storage pool. You can use container storage pools for both inline and client-side data deduplication.
  - **COPY** commands  
Use the COPY commands to create a copy of IBM Spectrum Protect objects or data.
  - **DEACTIVATE DATA** (Deactivate data for a client node)  
Use this command to specify that active data that was backed up for an application client node before a specified date is no longer needed. The command marks the data as inactive so it can be deleted according to your data retention policies.
  - **DECOMMISSION** commands  
Use the DECOMMISSION commands to remove client nodes from the production environment. Client nodes include applications, systems, and virtual machines.
  - **DEFINE** commands  
Use the DEFINE commands to create IBM Spectrum Protect objects.
  - **DELETE** commands  
Use the DELETE commands to delete or remove an IBM Spectrum Protect object.

- **DISABLE commands**  
Use DISABLE commands to prevent some types of operations by the server.
- **DISMOUNT command**  
Use the DISMOUNT command to dismount a volume by the real device address or by volume name.
- **DISPLAY OBJNAME (Display a full object name)**  
Use this command when you want IBM Spectrum Protect to display a full object name if the name displayed in a message or query output has been abbreviated due to length. Object names that are very long can be difficult to display and use through normal operating system facilities. The IBM Spectrum Protect server will abbreviate long names and assign them a token ID which might be used if the object path name exceeds 1024 bytes. The token ID is displayed in a string that includes identifiers for the node, filespace, and object name. The format is: [TSMOBJ:nID.fsID.objID]. When specified with the DISPLAY OBJNAME command, the token ID can be used to show the full object name.
- **ENABLE commands**  
Use ENABLE commands to allow some types of operations by the server.
- **ENCRYPT STGPOOL (Encrypt data in a storage pool)**  
Use this command to encrypt data in a directory-container or cloud-container storage pool.
- **END EVENTLOGGING (Stop logging events)**  
Use this command to stop logging events to an active receiver.
- **EXPIRE INVENTORY (Manually start inventory expiration processing)**  
Use this command to manually start inventory expiration processing. The inventory expiration process removes client backup and archive file copies from server storage. Removal is based on policy specifications in the backup and archive copy groups of the management classes to which the files are bound.
- **EXPORT commands**  
Use the EXPORT commands to copy information from an IBM Spectrum Protect server to sequential removable media.
- **EXTEND DBSPACE (Increase space for the database)**  
Use this command to increase space for the database by adding directories for the database to use.
- **GENERATE commands**  
Use the GENERATE commands for backup sets for a selected filespace or client node.
- **GRANT commands**  
Use the GRANT command to grant appropriate privileges or access.
- **HALT (Shut down the server)**  
Use this command to shut down the server. The HALT command forces an abrupt shutdown, which cancels all the administrative and client node sessions even if they are not completed.
- **HELP (Get help on commands and error messages)**  
Use this command to display administrative commands and error messages. You can issue the command from an administrative command line client.
- **IDENTIFY DUPLICATES (Identify duplicate data in a storage pool)**  
Use this command to start or stop processes that identify duplicate data in a storage pool. You can specify the number of duplicate-identification processes and their duration.
- **IMPORT commands**  
Use the IMPORT commands to import information from export media to an IBM Spectrum Protect server.
- **INSERT MACHINE (Insert machine characteristics information or recovery instructions)**  
Use this command to add client machine characteristics or recovery instructions to existing machine information in the database.
- **ISSUE MESSAGE (Issue a message from a server script)**  
Use this command with return code processing in a script to issue a message from a server script to determine where the problem is with a command in the script.
- **LABEL LIBVOLUME (Label a library volume)**  
Use this command to label tape volumes or, in an automated library, to label the volumes automatically as they are checked in. With this command, the server uses the full-length label with which the volumes are often pre-labeled.
- **LOAD DEFALERTTRIGGERS (Load the default set of alert triggers)**  
Use this command to load the default set of alert triggers to the IBM Spectrum Protect server.
- **LOCK commands**  
Use the LOCK command to prevent users from accessing the server.
- **MACRO (Invoke a macro)**  
Use this command to invoke a file from the administrative command line that contains one or more IBM Spectrum Protect administrative commands to be performed.
- **MIGRATE STGPOOL (Migrate storage pool to next storage pool)**  
Use this command to migrate files from one storage pool to the next storage pool in the storage hierarchy.
- **MOVE commands**  
Use the MOVE commands to either transfer backup or archive data between storage pools, or to move disaster recovery media on and off site.

- NOTIFY SUBSCRIBERS (Notify managed servers to update profiles)  
Use this command on a configuration manager to notify one or more managed servers to request that their configuration information be immediately refreshed.
- PERFORM LIBACTION (Define or delete all drives and paths for a library)  
Use this command to define or delete all drives and their paths for a single library in one step.
- PING SERVER (Test the connection between servers)  
Use this command to test the connection between the local server and a remote server.
- PREPARE (Create a recovery plan file)  
Use this command to create a recovery plan file, which contains the information that is needed to recover an IBM Spectrum Protect server. You can store a recovery plan file on a file system that is accessible to the source server or on a target server.
- PROTECT STGPOOL (Protect data that belongs to a storage pool)  
Use this command to protect data in a directory-container storage pool by storing a copy of the data in another storage pool on a replication target server or on the same server by protecting the data to tape. When you protect the directory-container storage pool, you can later try to repair damage in the storage pool by using the REPAIR STGPOOL command.
- QUERY commands  
Use the QUERY commands to request or display information about IBM Spectrum Protect objects.
- QUIT (End the interactive mode of the administrative client)  
Use this command to end an administrative client session in interactive mode.
- RECLAIM STGPOOL (Reclaim volumes in a sequential-access storage pool)  
Use this command to reclaim volumes in a sequential-access storage pool. Reclamation does not move inactive versions of backup data from volumes in active-data pools.
- RECONCILE VOLUMES (Reconcile differences in the virtual volume definitions)  
Issue this command from the source server to reconcile differences between virtual volume definitions on the source server and archive files on the target server. IBM Spectrum Protect finds all volumes of the specified device class on the source server and all corresponding archive files on the target server. The target server inventory is also compared to the local definition for virtual volumes to see if inconsistencies exist.
- REGISTER commands  
Use the REGISTER commands to define or add objects to IBM Spectrum Protect.
- REMOVE commands  
Use the REMOVE commands to remove an object from IBM Spectrum Protect.
- RENAME commands  
Use the RENAME commands to change the name of an existing object.
- REPAIR STGPOOL (Repair a directory-container storage pool)  
Use this command to repair deduplicated extents in a directory-container storage pool. Damaged deduplicated extents are repaired with extents that are backed up to the target replication server or to container-copy storage pools on the same server.
- REPLICATE NODE (Replicate data in file spaces that belong to a client node)  
Use this command to replicate data in file spaces that belong to one or more client nodes or defined groups of client nodes.
- REPLY (Allow a request to continue processing)  
Use this command and an identification number to inform the server that you have completed a requested operation. Not all server requests require a reply. This command is required only if the request message specifically indicates that a reply is needed.
- RESET PASSEXP (Reset password expiration)  
Use the RESET PASSEXP command to reset the password expiration period to the common expiration period for administrator and client node passwords. The RESET PASSEXP command does not apply to passwords that are stored on an LDAP directory server.
- RESTART EXPORT (Restart a suspended export operation)  
Use this command to restart a suspended export operation.
- RESTORE commands  
Use the RESTORE commands to restore IBM Spectrum Protect storage pools or volumes.
- REVOKE commands  
Use the REVOKE commands to revoke privileges or access.
- ROLLBACK (Rollback uncommitted changes in a macro)  
Use this command within a macro to undo any processing changes made by commands run by the server but not yet committed to the database. A committed change is permanent and cannot be rolled back. The ROLLBACK command is useful for testing macros.
- RUN (Run an IBM Spectrum Protect script)  
Use this command to run an IBM Spectrum Protect script. To issue this command on another server, the script being run must be defined on that server.
- SELECT (Perform an SQL query of the IBM Spectrum Protect database)  
Use the SELECT command to create and format a customized query of the IBM Spectrum Protect database.



- **SET commands**  
Use the SET commands to specify values that affect many different IBM Spectrum Protect operations.
- **SETOPT (Set a server option for dynamic update)**  
You can use the SETOPT command to update most server options dynamically without stopping and restarting the server. For the DBDIAGLOGSIZE option, you must stop and start the server. A SETOPT command contained in a macro or a script cannot be rolled back.
- **SHRED DATA (Shred data)**  
Use this command to manually start the process of shredding deleted sensitive data. Manual shredding is possible only if automatic shredding is disabled.
- **SUSPEND EXPORT (Suspend a currently running export operation)**  
Use this command to suspend a currently running server-to-server export operation which has a FILEDATA value that is not NONE. The export operation that you want to suspend must be past the initialization phase to be eligible for suspension. The state of the export operation is saved. The operation can be restarted by issuing the RESTART EXPORT command.
- **UNLOCK commands**  
Use the UNLOCK commands to reestablish access after an object was locked.
- **UPDATE commands**  
Use the UPDATE command to modify one or more attributes of an existing IBM Spectrum Protect object.
- **VALIDATE commands**  
Use the VALIDATE command to verify that an object is complete or valid for IBM Spectrum Protect.
- **VARY (Bring a random access volume online or offline)**  
Use this command to make a random access storage pool volume online or offline to the server.

## ACCEPT DATE (Accepts the current system date)

---

Use this command to allow the server to begin normal processing, when the server does not start normal processing because of a discrepancy between the server date and the current date on the system.

When the server does not start normal processing because of a discrepancy between the server date and the current date, this command forces the server to accept the current date and time as valid. If the system time is valid and the server has not been run for an extended time, this command should be run to allow the server to begin normal processing.

Attention: If the system date is invalid or the server was created or run previously with an invalid system date and this command is issued, any server processing or command that uses dates can have unexpected results. File expiration can be affected, for example. When the server is started with the correct date, files backed up with future dates will not be considered for expiration until that future date is reached. Files backed up with dates that have passed will expire faster. When the server processing encounters a future date, an error message is issued.

If the server detects an invalid date or time, server sessions become disabled (as if the DISABLE SESSIONS command had been issued). Expiration, migration, reclamation, and volume history deletion operations are not able to continue processing.

Use the ENABLE SESSIONS ALL command after you issue the ACCEPT DATE command to re-enable sessions to start.

### Privilege class

---

To issue this command, you must have system privilege.

### Syntax

---

```
>>-ACcEpt Date-----<<
```

### Parameters

---

None.

### Example: Accept the current system date

---

Allow the server to accept the current date as the valid date.

```
accept date
```

## Related commands

---

Table 1. Command related to ACCEPT DATE

Command	Description
ENABLE SESSIONS	Resumes server activity following the DISABLE command or the ACCEPT DATE command.

## ACTIVATE POLICYSET (Activate a new policy set)

---

Use this command to copy the contents of a policy set to the ACTIVE policy set for the domain. The server uses the rules in the ACTIVE policy set to manage client operations in the domain. You can define multiple policy sets for a policy domain, but only one policy set can be active. The current ACTIVE policy set is replaced by the one you specify when you issue this command. You can modify the ACTIVE policy set only by activating another policy set.

Before activating a policy set, check that the policy set is complete and valid by using the VALIDATE POLICYSET command.

The ACTIVATE POLICYSET command fails if any of the following conditions exist:

- A copy group specifies a copy storage pool as a destination.
- A management class specifies a copy storage pool as the destination for files that were migrated by an IBM Spectrum Protect™ for Space Management client.
- The policy set has no default management class.
- A TOCDESTINATION parameter is specified, and the storage pool is either a copy pool or has a data format other than NATIVE or NONBLOCK.

The ACTIVE policy set and the last activated policy set are not necessarily identical. You can modify the original policy set that you activated without affecting the ACTIVE policy set.

If the server has data retention protection enabled, the following conditions must exist:

- All management classes in the policy set to be activated must contain an archive copy group.
- If a management class exists in the active policy set, a management class with the same name must exist in the policy set to be activated.
- If an archive copy group exists in the active policy set, the corresponding copy group in the policy set to be activated must have a RETVER value at least as large as the corresponding values in the active copy group.

Attention: Retention protection only applies to archive objects.

## Privilege class

---

To issue this command, you must have system privilege, unrestricted policy privilege, or restricted policy privilege for the policy domain to which the policy set belongs.

## Syntax

---

```
>>-ACTivate Policyset--domain_name--policy_set_name-----><
```

## Parameters

---

domain\_name (Required)

Specifies the policy domain for which you want to activate a policy set.

policy\_set\_name (Required)

Specifies the policy set to activate.

## Example: Activate a policy set on a specific policy domain

---

Activate the VACATION policy set in the EMPLOYEE\_RECORDS policy domain.

```
activate policyset employee_records vacation
```

## Related commands

Table 1. Commands related to ACTIVATE POLICYSET

Command	Description
COPY POLICYSET	Creates a copy of a policy set.
DEFINE POLICYSET	Defines a policy set within the specified policy domain.
DELETE POLICYSET	Deletes a policy set, including its management classes and copy groups, from a policy domain.
QUERY DOMAIN	Displays information about policy domains.
QUERY POLICYSET	Displays information about policy sets.
UPDATE POLICYSET	Changes the description of a policy set.
VALIDATE POLICYSET	Verifies and reports on conditions the administrator must consider before activating the policy set.

## ASSIGN DEFMGMTCLASS (Assign a default management class)

Use this command to specify a management class as the default management class for a policy set. You must assign a default management class for a policy set before you can activate that policy set.

To ensure that clients can always back up and archive files, choose a default management class that contains both an archive copy group and a backup copy group.

The server uses the default management class to manage client files when a management class is not otherwise assigned or appropriate. For example, the server uses the default management class when a user does not specify a management class in the include-exclude list.

### Privilege class

To issue this command, you must have system privilege, unrestricted policy privilege, or restricted policy privilege for the policy domain to which the policy set belongs.

### Syntax

```
>>-ASsign DEFMGmtclass--domain_name--policy_set_name--class_name-><
```

### Parameters

domain\_name (Required)

Specifies the policy domain to which the management class belongs.

policy\_set\_name (Required)

Specifies the policy set for which you want to assign a default management class. You cannot assign a default management class to the ACTIVE policy set.

class\_name (Required)

Specifies the management class that is to be the default management class for the policy set.

### Example: Assign a default management class

Assign DEFAULT1 as the default management class for policy set SUMMER in the PROG1 policy domain.

```
assign defmgmtclass prog1 summer default1
```

## Related commands

Table 1. Commands related to ASSIGN DEFMGMTCLASS

Command	Description
---------	-------------

Command	Description
ACTIVATE POLICYSET	Validates and activates a policy set.
DEFINE COPYGROUP	Defines a copy group for backup or archive processing within a specified management class.
DEFINE MGMTCLASS	Defines a management class.
DEFINE POLICYSET	Defines a policy set within the specified policy domain.
DELETE MGMTCLASS	Deletes a management class and its copy groups from a policy domain and policy set.
QUERY COPYGROUP	Displays the attributes of a copy group.
QUERY MGMTCLASS	Displays information about management classes.
QUERY POLICYSET	Displays information about policy sets.
UPDATE COPYGROUP	Changes one or more attributes of a copy group.
UPDATE MGMTCLASS	Changes the attributes of a management class.
VALIDATE POLICYSET	Verifies and reports on conditions the administrator must consider before activating the policy set.

## AUDIT commands

Use the AUDIT commands to review or examine the adequacy of the database information and the storage pool volume. The AUDIT LDAPDIRECTORY command deletes nodes or administrator IDs from an LDAP directory server, that do not authenticate their passwords with the LDAP directory server.

- AUDIT CONTAINER
  - AUDIT CONTAINER (Verify the consistency of database information for a cloud container)
  - AUDIT CONTAINER (Verify the consistency of database information for a directory-container)
- AUDIT LDAPDIRECTORY (Audit an LDAP directory server)
- AUDIT LIBRARY (Audit volume inventories in an automated library)
- AUDIT LIBVOLUME (Verify database information for a tape volume)
- AUDIT LICENSES (Audit server storage usage)
- AUDIT VOLUME (Verify database information for a storage pool volume)

AIX

Linux

Windows

## AUDIT CONTAINER commands

Use the AUDIT CONTAINER command to scan for inconsistencies between database information and a container in either a cloud or a directory storage pool.

- AUDIT CONTAINER (Verify the consistency of database information for a cloud container)  
Use this command to scan for inconsistencies between database information and a container in a cloud-container storage pool. Cloud-container storage pools are not supported on Linux on System z®.
- AUDIT CONTAINER (Verify the consistency of database information for a directory-container)  
Use this command to scan for inconsistencies between database information and a container in a directory-container storage pool.

## AUDIT CONTAINER (Verify the consistency of database information for a cloud container)

Use this command to scan for inconsistencies between database information and a container in a cloud-container storage pool. Cloud-container storage pools are not supported on Linux on System z®.

You can use this command to complete the following actions for a container in a cloud-container storage pool:

- Scan the contents of a container to validate the integrity of the data extents

- Remove data from a container that is marked as *damaged*, such as when a file has references in the server database, but has missing or corrupted data in the cloud
- Mark an entire container as damaged
- Remove data that is marked as *orphaned*, such as when an object stored in the cloud does not have a reference in the server database

## Privilege class

To use this command, you must have system privilege, or unrestricted storage privilege.

## Syntax

```
>>-AUDit CONTainer--+--container_name-----+-->
      +-STGpool---pool_name-----+
      '-STGpool---pool_name--STGPOOLDIrectory---directory_name-'

.-Action---SCANAll-----.
>--+-----+----->
  '-Action---+SCANAll-----'
      +-REMOVEDamaged-+
      +-MARKDamaged---+
      '-SCANDamaged---'

.-FORCEOrphandbdel---No-----.
>--+-----+----->
  '-FORCEOrphandbdel---+No---+'
      '-Yes-'

.-MAXProcess---4-----.-Wait---No-----.
>--+-----+-----+----->
  '-MAXProcess---number-' '-Wait---+No---+'
      '-Yes-'

.-BEGINDate---before_first_audit-.
>--+-----+----->
  '-BEGINDate---begin_date-----'

.-BEGINTime---00:00:00---.
>--+-----+----->
  '-BEGINTime---begin_time-'

.-ENDDate---after_last_audit-. .-ENDTime---23:59:59-.
>--+-----+-----+-----><
  '-ENDDate---end_date-----' '-ENDTime---end_time-'
```

## Parameters

### container\_name

Specifies the name of the container that you want to audit. If you do not specify this parameter, you must specify a cloud-container storage pool.

### STGpool

Specifies the name of the cloud-container storage pool that you want to audit. This parameter is optional. If you specify only this parameter, all containers that are defined to the storage pool are audited. If you do not specify this parameter, you must specify a container.

### STGPOOLDIrectory

Specifies the name of the cloud-container storage pool directory that you want to audit. This parameter is optional. Restriction: You must specify a storage pool that uses local storage.

### Action

Specifies what action the server takes when a container in a cloud-container storage pool is audited. This parameter is optional. You can specify one of the following values:

#### SCANAll

Specifies that the server identifies database records that refer to data extents with inconsistencies. A check is done for data in the cloud-container storage pool that does not match data in the server database. This value is the default. The server marks the data extent as damaged in the database.

Tip: If you specify the ACTION=SCANALL parameter on an IBM® Cloud Object Storage storage pool that uses a vault with name indexing disabled, the audit operation scans the entire vault to identify orphaned extents in each container. In this situation, specify WAIT=YES if you want the audit operation to wait for the scan for orphaned extents to complete before it reports the audit as complete. This scan for orphaned extents occurs only if you do not specify a container name. If you specify a container that is in a vault with name indexing disabled, the audit operation does not scan for orphaned extents.

**REMOVEDamaged**

Specifies that the server removes any references to damaged extents from the server database. The damaged extents are also removed from the cloud-container storage pool if found. The server also removes any orphaned extents from the cloud-container storage pool, and removes the references to these orphaned extents from the database, as specified by the FORCEORPHANDBDEL parameter.

**MARKDamaged**

Specifies that the server explicitly marks all data extents in the container as damaged.

**SCANDamaged**

Specifies that the server checks only the existing damaged extents in the container.

Important: If no connection to the cloud exists, the ACTION=SCANALL and ACTION=SCANDAMAGED parameters do not run. However, the ACTION=MARKDAMAGED parameter runs as expected without a cloud connection, and the ACTION=REMOVEDAMAGED parameter marks any damaged data as orphaned. As soon as the connection to the cloud returns, the server deletes the orphaned extents.

State reset condition: If the audit does not detect an error with a data extent that is marked as damaged, the state of the data extent is reset. The data extent can then be used. This condition provides a means for resetting the state of damaged data extents if errors are caused by a correctable problem. The SCANALL and SCANDAMAGED options are the only options that reset a damaged extent if it is found not to be damaged.

**FORCEOrphandbdel**

Specifies that the server forces the deletion of orphaned extents from the server database, even if they are not deleted from the cloud-container storage pool. This parameter is optional. If you specify this parameter, you must also specify the ACTION=REMOVEDAMAGED parameter. The following options are available:

**Yes**

Specifies that the server deletes any orphaned extents from the server database, even if they are not deleted from the cloud-container storage pool.

**No**

Specifies that the server keeps the orphaned extents in the server database if they cannot be deleted from the cloud-container storage pool. This value is the default.

**MAXProcess**

Specifies the maximum number of parallel processes to use for checking a container in a cloud-container storage pool. This parameter is optional. Enter a value in the range 1 - 99. The default value is 4.

Restriction: The server ignores this parameter when you use MAXPROCESS with the ACTION=REMOVEDAMAGED parameter.

**Wait**

Specifies whether the audit or verification operation is completed in the foreground or background. This parameter is optional. The following options are available:

**No**

Specifies that the operation is completed in the background. You can continue with other tasks when the command is processing. Messages that are related to the background process are displayed in the activity log file or the server console, depending on where the messages are logged. This value is the default.

**Yes**

Specifies that the operation is completed in the foreground. It might take a long time to complete the operation. The operation must complete before you can continue with other tasks. Messages are displayed in the activity log file or the server console, or both, depending on where the messages are logged.

Restriction: You cannot specify the WAIT=YES parameter from the server console.

**BEGINDate**

Specifies the date range value at which auditing should start. Containers that were last audited within the specified date range are audited. If you specify a time but do not specify a beginning date, the current date is used. If you do not specify a beginning and end date, all containers are audited. The default is the date before the first audit was completed for the container. This parameter is optional.

You can specify the date to begin the audit in one of the following ways:

Value	Description	Example
-------	-------------	---------

Value	Description	Example
MM/DD/YYYY	A specific date.	09/15/2016
TODAY	The current date.	TODAY
TODAY-days <b>or</b> -days	The current date minus days specified. The maximum number of days you can specify is 9999.	TODAY -7 <i>or</i> -7.  To audit all containers that were audited in the last week, specify BEGINDATE=TODAY-7 or BEGINDATE= -7.
EOLM (End Of Last Month)	The last day of the previous month.	EOLM
EOLM-days	The last day of the previous month minus days specified.	EOLM-1  To include containers that were audited a day before the last day of the previous month.
BOTM (Beginning Of This Month)	The first day of the current month.	BOTM
BOTM+days	The first day of the current month, plus days specified.	BOTM+9  To include containers that were audited on the 10th day of the current month.

#### BEGINTime

Specifies the time range value at which auditing should start. Containers that were last audited within the specified time range are audited. If you do not specify a beginning and end time, the time range is set from 00:00:00 to 23:59:59. The default is 00:00:00. If you did not specify a date range, the default is today's date. This parameter is optional.

You can specify the date to begin the audit in one of the following ways:

Value	Description	Example
HH:MM:SS	A specific time on the specified begin date.	10:30:08
NOW	The current time on the specified begin date.	NOW
NOW+HH:MM <i>or</i> +HH:MM	The current time plus hours and minutes on the specified begin date.	NOW+03:00 <i>or</i> +03:00.  If you issue this command at 9:00 with BEGINTIME=NOW+3 or BEGINTIME=+3, containers with a last audit time of 12:00 or later on the begin date are audited.
NOW-HH:MM <i>or</i> -HH:MM	The current time minus hours and minutes on the specified begin date.	NOW-04:00 <i>or</i> -04:00.  If you issue this command at 9:00 with BEGINTime=NOW-3:30 or BEGINTime= -3:30, IBM Spectrum Protect™ audits containers with a last audit time of 5:30 or later on the begin date.

#### ENDDate

Specifies the date range value at which auditing should stop. Containers that were last audited within the specified date range are audited. If you specify a time but do not specify a value, the current date is used. If you do not specify a beginning and end date, all containers are audited. The default is the date after the last audit was completed for the container. This parameter is optional.

You can specify the date by using one of the following values:

Value	Description	Example
MM/DD/YYYY	A specific date.	09/15/2016
TODAY	The current date.	TODAY

Value	Description	Example
TODAY-days or -days	The current date minus days specified. The maximum number of days you can specify is 9999.	TODAY-1 or -1.  To include containers that were audited up to yesterday, you can specify ENDDATE=TODAY-1 or ENDDATE= -1.
EOLM (End Of Last Month)	The last day of the previous month.	EOLM
EOLM-days	The last day of the previous month minus days specified.	EOLM-1  To include containers that were audited a day before the last day of the previous month.
BOTM (Beginning Of This Month)	The first day of the current month.	BOTM
BOTM+days	The first day of the current month, plus days specified.	BOTM+9  To include containers that were audited on the 10th day of the current month.

#### ENDTime

Specifies the time range value at which auditing should stop. Containers that were last audited within the specified time range are audited. If you do not specify a beginning and end time, the time range is set to 00:00:00 to 23:59:59. The default is 23:59:59. This parameter is optional.

You can specify the time using one of the following values:

Value	Description	Example
HH:MM:SS	A specific time on the specified end date.	10:30:08
NOW	The current time on the specified end date.	NOW
NOW+HH:MM or +HH:MM	The current time plus hours and minutes on the specified end date.	NOW+03:00 or +03:00.  If you issue this command at 9:00 with ENDTIME=NOW+3:00 or ENDTIME= +3:00, containers with a last audit time of 12:00 or earlier on the end date you specify are audited.
NOW-HH:MM or -HH:MM	The current time minus hours and minutes on the specified end date.	NOW-03:30 or -03:30.  If you issue this command at 9:00 with ENDTIME=NOW-3:30 or ENDTIME= -3:30, containers with a last audit time of 5:30 or earlier on the end date you specify are audited.

### Example: Audit a specific container in a cloud-container storage pool

Audit the 42-00000my000example000container000 container in a cloud-container storage pool.

```
audit container 42-00000my000example000container000 action=scanall
```

### Example: Audit a cloud-container storage pool within a specific time frame

Audit a cloud-container storage pool that is named POOL3 and only include containers from yesterday between 9:30 and 12:30.

```
audit container stgpool=pool3 begindate=today-1  
begintime=09:30:00 endtime=12:30:00
```

Table 1. Commands related to AUDIT CONTAINER

Command	Description
CANCEL PROCESS	Cancels a background server process.
QUERY CONTAINER	Displays information about a container.



Command	Description
QUERY DAMAGED	Displays information about damaged files.

AIX Linux Windows

## AUDIT CONTAINER (Verify the consistency of database information for a directory-container)

Use this command to scan for inconsistencies between database information and a container in a directory-container storage pool.

You can use this command to complete the following actions for a container in a directory-container storage pool:

- Scan the contents of a container to validate the integrity of the data extents
- Remove damaged data from a container
- Mark an entire container as damaged

### Privilege class

To issue this command, you must have system privilege, or unrestricted storage privilege.

### Syntax

```
>>-AUDit CONTainer--+-container_name-----+-->
                    +-STGpool---pool_name-----+
                    '-STGpool---pool_name--STGPOOLDIrectory---directory_name-'

.-Action---SCANAll-----.
>--+-----+----->
'-Action---SCANAll-----'
      +-REMOVEDamaged+
      +-MARKDamaged---+
      '-SCANDamaged---'

.-MAXProcess---4-----.-Wait---No-----.
>--+-----+----->
'-MAXProcess---number-' '-Wait---No---+'
                               '-Yes-'

.-BEGINDate---before_first_audit-.
>--+-----+----->
'-BEGINDate---begin_date-----'

.-BEGINTime---00:00:00---.
>--+-----+----->
'-BEGINTime---begin_time-'

.-ENDDate---after_last_audit-. .-ENDTime---23:59:59-.
>--+-----+-----><
'-ENDDate---end_date-----' '-ENDTime---end_time-'
```

### Parameters

#### container\_name

Specifies the name of the container that you want to audit. If you do not specify this parameter, you must specify a directory-container storage pool.

#### STGpool

Specifies the name of the directory-container storage pool that you want to audit. This parameter is optional. If you specify only this parameter, all containers that are defined to the storage pool are audited. If you do not specify this parameter, you must specify a container.

#### STGPOOLDIrectory

Specifies the name of the container storage pool directory that you want to audit. This parameter is optional. If you specify this parameter, all containers that are defined to the container storage pool directory are audited. To specify this parameter,

you must also specify a storage pool.

**Action**

Specifies what action the server takes when a container in a directory-container storage pool is audited. This parameter is optional. You can specify one of the following values:

**SCANAll**

Specifies that the server identifies database records that refer to data extents with inconsistencies. This value is the default. The server marks the data extent as damaged in the database.

Tip: If you used the PROTECT STGPOOL command on a directory-container storage pool on the target server, you can repair the damaged data extent by using the REPAIR STGPOOL command.

**REMOVEDamaged**

Specifies that the server removes any files from the database that reference the damaged data extent.

**MARKDamaged**

Specifies that the server explicitly marks all data extents in the container as damaged.

**SCANDamaged**

Specifies that the server checks only the existing damaged extents in the container.

State reset condition: If the audit does not detect an error with a data extent that is marked as damaged, the state of the data extent is reset. The data extent can then be used. This condition provides a means for resetting the state of damaged data extents if errors are caused by a correctable problem. The SCANALL and SCANDAMAGED options are the only options that reset a damaged extent if it is found not to be damaged.

**MAXProcess**

Specifies the maximum number of parallel processes to use for checking a container in a directory-container storage pool. This parameter is optional. Enter a value in the range 1 - 99. The default value is 4.

**Wait**

Specifies whether the audit or verification operation is completed in the foreground or background. This parameter is optional. The following options are available:

**No**

Specifies that the operation is completed in the background. You can continue with other tasks when the command is processing. Messages that are related to the background process are displayed in the activity log file or the server console, depending on where the messages are logged. This is the default value.

**Yes**

Specifies that the operation is completed in the foreground. It might take a long time to complete the operation. The operation must complete before you can continue with other tasks. Messages are displayed in the activity log file or the server console, or both, depending on where the messages are logged.

Restriction: You cannot specify the WAIT=YES parameter from the server console.

**BEGINDate**

Specifies the date range value at which auditing should start. Containers that were last audited within the specified date range are audited. If you specify a time but do not specify a beginning date, the current date is used. If you do not specify a beginning and end date, all containers are audited. The default is the date before the first audit was completed for the container. This parameter is optional.

You can specify the date to begin the audit in one of the following ways:

Value	Description	Example
MM/DD/YYYY	A specific date.	09/15/2016
TODAY	The current date.	TODAY
TODAY-days or -days	The current date minus days specified. The maximum number of days you can specify is 9999.	TODAY -7 or -7.  To audit all containers that were audited in the last week, specify BEGINDATE=TODAY-7 or BEGINDATE= -7.
EOLM (End Of Last Month)	The last day of the previous month.	EOLM
EOLM-days	The last day of the previous month minus days specified.	EOLM-1  To include containers that were audited a day before the last day of the previous month.
BOTM (Beginning Of This Month)	The first day of the current month.	BOTM

Value	Description	Example
BOTM+days	The first day of the current month, plus days specified.	BOTM+9  To include containers that were audited on the 10th day of the current month.

#### BEGINTime

Specifies the time range value at which auditing should start. Containers that were last audited within the specified time range are audited. If you do not specify a beginning and end time, the time range is set from 00:00:00 to 23:59:59. The default is 00:00:00. If you did not specify a date range, the default is today's date. This parameter is optional.

You can specify the date to begin the audit in one of the following ways:

Value	Description	Example
HH:MM:SS	A specific time on the specified begin date.	10:30:08
NOW	The current time on the specified begin date.	NOW
NOW+HH:MM <i>or</i> +HH:MM	The current time plus hours and minutes on the specified begin date.	NOW+03:00 <i>or</i> +03:00.  If you issue this command at 9:00 with BEGINTIME=NOW+3 or BEGINTIME=+3, containers with a last audit time of 12:00 or later on the begin date are audited.
NOW-HH:MM <i>or</i> -HH:MM	The current time minus hours and minutes on the specified begin date.	NOW-04:00 <i>or</i> -04:00.  If you issue this command at 9:00 with BEGINTime=NOW-3:30 or BEGINTime= -3:30, IBM Spectrum Protect™ audits containers with a last audit time of 5:30 or later on the begin date.

#### ENDDate

Specifies the date range value at which auditing should stop. Containers that were last audited within the specified date range are audited. If you specify a time but do not specify a value, the current date is used. If you do not specify a beginning and end date, all containers are audited. The default is the date after the last audit was completed for the container. This parameter is optional.

You can specify the date by using one of the following values:

Value	Description	Example
MM/DD/YYYY	A specific date.	09/15/2016
TODAY	The current date.	TODAY
TODAY-days <b>or</b> -days	The current date minus days specified. The maximum number of days you can specify is 9999.	TODAY-1 <i>or</i> -1.  To include containers that were audited up to yesterday, you can specify ENDDATE=TODAY-1 or ENDDATE= -1.
EOLM (End Of Last Month)	The last day of the previous month.	EOLM
EOLM-days	The last day of the previous month minus days specified.	EOLM-1  To include containers that were audited a day before the last day of the previous month.
BOTM (Beginning Of This Month)	The first day of the current month.	BOTM
BOTM+days	The first day of the current month, plus days specified.	BOTM+9  To include containers that were audited on the 10th day of the current month.

#### ENDTime

Specifies the time range value at which auditing should stop. Containers that were last audited within the specified time range are audited. If you do not specify a beginning and end time, the time range is set to 00:00:00 to 23:59:59. The

default is 23:59:59. This parameter is optional.

You can specify the time using one of the following values:

Value	Description	Example
HH:MM:SS	A specific time on the specified end date.	10:30:08
NOW	The current time on the specified end date.	NOW
NOW+HH:MM <i>or</i> +HH:MM	The current time plus hours and minutes on the specified end date.	NOW+03:00 <i>or</i> +03:00.  If you issue this command at 9:00 with ENDTIME=NOW+3:00 or ENDTIME= +3:00, containers with a last audit time of 12:00 or earlier on the end date you specify are audited.
NOW-HH:MM <i>or</i> -HH:MM	The current time minus hours and minutes on the specified end date.	NOW-03:30 <i>or</i> -03:30.  If you issue this command at 9:00 with ENDTIME=NOW-3:30 or ENDTIME= -3:30, containers with a last audit time of 5:30 or earlier on the end date you specify are audited.

### Example: Audit a specific storage pool container

Audit the 0000000000000721.dcf storage pool container.

```
audit container n:\ddcont2\07\0000000000000721.dcf action=scanall
```

### Example: Remove damaged data from a directory-container storage pool

Audit a directory-container storage pool that is named NEWDEDUP and remove damaged files.

```
audit container stgpool=newdedup action=removedamaged
```

### Example: Mark as damaged all of the data in a directory-container storage pool

Audit a directory-container storage pool that is named NEWDEDUP and mark all files as damaged.

```
audit container stgpool=newdedup maxprocess=2 action=markdamaged
```

### Example: Audit a directory-container storage pool within a specific time frame

Audit a directory-container storage pool that is named POOL2 and only include containers before yesterday between 9:30 and 12:30.

```
audit container stgpool=pool2 begindate=today-1  
begintime=09:30:00 endtime=12:30:00
```

Table 1. Commands related to AUDIT CONTAINER

Command	Description
CANCEL PROCESS	Cancel a background server process.
MOVE CONTAINER	Moves the contents of a storage pool container to another container.
QUERY DAMAGED	Displays information about damaged files.

## AUDIT LDAPDIRECTORY (Audit an LDAP directory server)

Use this command to audit an IBM Spectrum Protect™ controlled namespace on a Lightweight Directory Access Protocol (LDAP) server. The LDAP server and namespace are specified by using one or more LDAPURL options.

Restriction: Use this command only if you configured password authentication as described in Authenticating users by using an LDAP server. Information that is provided about the AUDIT LDAPDIRECTORY command applies only to environments in which

password authentication is configured as described in Authenticating users by using an LDAP server.

Nodes and administrator user IDs that do not authenticate their passwords with the LDAP directory server are deleted with the AUDIT LDAPDIRECTORY FIX=YES command. Nodes or administrator user IDs that no longer exist in the IBM Spectrum Protect database are also deleted.

Before you issue this command, ensure that the LDAPURL option is specified in the dsmserv.opt file. See the LDAPURL option for more information. If you specified more than one LDAPURL option in the dsmserv.opt file, each option is validated in the order in which they are placed. If the LDAPURL option is not specified, the command fails.

## Privilege class

---

You must have system privileges to issue this command.

## Syntax

---

```

>>-AUDIT LDAPdirectory--+-Fix-----No-----+----->
                          '-Fix-----+No--+-'
                          '-Yes-'

.-Wait-----No-----.
>--+-----+----->>
  '-Wait-----+No--+-'
  '-Yes-'
```

## Parameters

---

### Fix

This optional parameter specifies how the IBM Spectrum Protect server resolves inconsistencies between the database and the external directory. The default is NO. You can specify the following values:

#### No

The server reports all inconsistencies but does not change the external directory.

#### Yes

The server resolves any inconsistencies that it can and suggests further actions, if needed.

Important: If there are LDAP entries that are shared with other IBM Spectrum Protect servers, choosing YES might cause those servers to become out-of-sync.

### Wait

This optional parameter specifies whether to wait for the IBM Spectrum Protect server to complete processing this command in the foreground. The default is NO. You can specify the following values:

#### No

The server processes this command in the background and you can continue with other tasks while the command is processing. Messages related to the background process are shown either in the activity log file or the server console, depending on where the messages are logged.

#### Yes

The server processes this command in the foreground. The operation must complete before you can continue with other tasks. Messages are shown either in the activity log file or the server console, or both, depending on where the messages are logged.

Restriction: You cannot specify WAIT=YES from the server console.

## Example: Audit an LDAP directory and repair inconsistencies

---

Audit the LDAP directory that you specified in the LDAPURL option. The IBM Spectrum Protect server resolves some inconsistencies.

```
audit ldapdirectory fix=yes
```

```
ANR2749W Admin ADMIN1 was located in the LDAP directory server but not
in the database.
```

```
ANR2749W Admin ADMIN2 was located in the LDAP directory server but not
in the database.
```

ANR2749W Admin NODE1 was located in the LDAP directory server but not in the database.  
 ANR2749W Admin NODE2 was located in the LDAP directory server but not in the database.  
 ANR2748W Node NODE1 was located in the LDAP directory server but not in the database.  
 ANR2748W Node NODE2 was located in the LDAP directory server but not in the database.  
 ANR2745I AUDIT LDAPDIRECTORY command completed: 4 administrator entries are only in the LDAP directory server (not in the IBM Spectrum Protect server), 0 administrator entries are only in the IBM Spectrum Protect server (not in the LDAP directory server), 2 node entries are only in the LDAP directory server (not in the IBM Spectrum Protect server), 0 node entries are only in the IBM Spectrum Protect server, (not in the LDAP directory server), 6 entries were deleted from the LDAP server in total.

## Related commands

Table 1. Commands related to AUDIT LDAPDIRECTORY

Command	Description
SET DEFAULTAUTHENTICATION	Specifies the default password authentication method for any REGISTER NODE or REGISTER ADMIN commands.
SET LDAPPASSWORD	Sets the password for the LDAPUSER.
SET LDAPUSER	Sets the user who oversees the passwords and administrators on the LDAP directory server.

## AUDIT LIBRARY (Audit volume inventories in an automated library)

Use this command to audit and synchronize volume inventories in an automated library.

When the AUDIT LIBRARY command is issued on a library client, the client synchronizes its inventory with the inventory on the library manager. If the library client detects inconsistencies, it corrects them by changing the ownership of the volume on the library manager.

When the AUDIT LIBRARY command is issued on a server where the library is SCSI, 349X, or ACSLS (LIBTYPE=SCSI, LIBTYPE=349X, or LIBTYPE=ACSL), the server synchronizes its inventory with the inventory of the library device. If the server detects inconsistencies, it deletes missing volumes from its inventory.

- In SCSI libraries, the server also updates the locations of volumes in its inventory that have been moved since the last audit.
- In 349X libraries, the server also ensures that scratch volumes are in the scratch category and that private volumes are in the private category.

When the AUDIT LIBRARY command is issued on a server that is a library manager for the library (SHARED=YES), the server updates ownership of its volumes if it detects inconsistencies.

Regardless the type of server or type of library, issuing the AUDIT LIBRARY command does not automatically add new volumes to a library. To add new volumes, you must use the CHECKIN LIBVOLUME command.

Attention: The following precautions apply to SCSI, 349X, and ACSLS libraries only (LIBTYPE=SCSI, LIBTYPE=349X, and LIBTYPE=ACSL):

- Running the AUDIT LIBRARY command prevents any other library activity until the audit completes. For example, the server will not process restore or retrieve requests that involve the library when the AUDIT LIBRARY command is running.
- If other activity is occurring in the library, do not issue the AUDIT LIBRARY command. Issuing the AUDIT LIBRARY command when a library is active can produce unpredictable results (for example, a hang condition) if a process currently accessing the library attempts to acquire a new tape mount.

This command creates a background process that you can cancel with the CANCEL PROCESS command. To display information about background processes, use the QUERY PROCESS command.

## Privilege class

To issue this command, you must have system privilege or unrestricted storage privilege.

## Syntax

```
>>-AUDIT LIBRARY--library_name----->
.-CHECKLabel----Yes-----
>--+-----+----->
'-CHECKLabel---+Yes---+'
          '-Barcode-'

.-REFRESHstate----No-----
>--+-----+----->>
'-REFRESHstate---+No---+'
          '-Yes-'
```

## Parameters

library\_name (Required)

Specifies the name of the library to audit.

CHECKLabel

Specifies how the storage volume label is checked during the audit. This parameter applies to SCSI libraries only. The parameter is ignored for other library types. The default is YES. Possible values are:

Yes

Specifies that the server checks each volume label to verify the identity of the volume.

Barcode

Specifies that the server uses the barcode reader to read the storage label. Using the barcode decreases the audit processing time. This parameter applies only to SCSI libraries.

Attention: If the scanner cannot read the barcode label or the barcode label is missing, the server loads that tape in a drive to read the label.

REFRESHstate

Specifies whether the server's information about a library, which is normally obtained during initialization, is refreshed, so that any changes in configuration are reflected. By setting the REFRESHSTATE parameter to Yes, this action is completed without having to restart the server or re-define the library. The default is No. Possible values are:

No

Specifies that the server does not refresh the library's state when the library is audited.

Yes

Specifies that the server does refresh the library's state when the AUDIT LIBRARY command is issued.

## Example: Audit an automated library

Audit the EZLIFE automated library.

```
audit library ezlife
```

## Related commands

Table 1. Commands related to AUDIT LIBRARY

Command	Description
CANCEL PROCESS	Cancels a background server process.
DEFINE LIBRARY	Defines an automated or manual library.
DELETE LIBRARY	Deletes a library.
DISMOUNT VOLUME	Dismounts a sequential, removable volume by the volume name.
QUERY LIBRARY	Displays information about one or more libraries.
QUERY LIBVOLUME	Displays information about a library volume.

Command	Description
QUERY PROCESS	Displays information about background processes.
UPDATE LIBRARY	Changes the attributes of a library.

## AUDIT LIBVOLUME (Verify database information for a tape volume)

Use this command to determine whether a tape volume is intact and to audit data on any tape volume.

You can issue the AUDIT LIBVOLUME command from any tape volume that is checked in to a library. The command runs in the background by default. You can issue the command from the following library types that have IBM® TS1140, IBM LTO 5, or a later generation tape drive:

- SCSI tape library
- Virtual tape library (VTL)

The following table outlines the tape drives that can verify tape volumes with media types for IBM TS1140 and IBM LTO 5 and later generation LTO tape drives:

Table 1. Tape drives and the media types

Drive	Media type
TS1140	JB, JX, JA, JW, JJ, JR, JC, JY, and JK
IBM LTO 5	LTO 3, LTO 4, and LTO 5
IBM LTO 6	LTO 4, LTO 5, and LTO 6
IBM LTO 7	LTO 5, LTO 6, and LTO 7

The following table outlines the minimum device driver level that you require to run the command:

Table 2. Minimum IBM device driver level

Driver name	Device driver level
Atape driver on AIX®	12.3.5.00
lin_tape driver on Linux	1.6.7.00
IBM tape driver on Windows	6.2.2.00

Restriction: You cannot issue the CANCEL PROCESS command while the AUDIT LIBVOLUME command is in progress.

### Privilege class

To issue this command, you must have system privilege, or unrestricted storage privilege for the library to which the tape volume is defined.

### Syntax

```
>>-AUDit LIBVolume--library_name--volume_name----->
      .-Wait-----No-----.
>--+-----+----->>
      '-Wait-----+No--+-'
          '-Yes-'
```

### Parameters

library\_name (Required)

Specifies the name of the library volume where the tape volume is located that you want to audit.

volume\_name (Required)

Specifies the name of the physical tape volume that you want to audit.

Wait (Optional)

Specifies whether the audit or verification operation is completed in the foreground or background. This parameter is optional. The following options are available:



No

Specifies that the operation is completed in the background. The NO value is the default value.

Yes

Specifies that the operation is completed in the foreground. It might take a long time to complete the operation.

## Example: Audit a tape volume

---

Audit the EZLIFE library that has a tape volume that is called KM0347L5.

```
audit libvolume ezlife KM0347L5
```

## AUDIT LICENSES (Audit server storage usage)

---

Use this command to audit the server storage used by client nodes and to audit the server licenses. The audit determines whether the current configuration is in compliance with the license terms.

An audit creates a background process you can cancel with the CANCEL PROCESS command. If you halt and restart the server, an audit is run automatically as specified by the SET LICENSEAUDITPERIOD. To view audit results, use the QUERY LICENSE command.

Attention: The audit of server storage can take a lot of CPU time. You can use the AUDITSTORAGE server option to specify that storage is not to be audited.

## Privilege class

---

To issue this command, you must have system privilege.

## Syntax

---

```
>>-AUDit LICenses-----<<
```

## Parameters

---

None.

## Example: Audit server licenses

---

Issue the AUDIT LICENSES command.

```
audit licenses
```

## Related commands

---

Table 1. Commands related to AUDIT LICENSES

Command	Description
CANCEL PROCESS	Cancels a background server process.
QUERY AUDITOCCUPANCY	Displays the server storage utilization for a client node.
QUERY LICENSE	Displays information about licenses and audits.
QUERY PROCESS	Displays information about background processes.
QUERY STATUS	Displays the settings of server parameters, such as those selected by the SET commands.
REGISTER LICENSE	Registers a license with the IBM Spectrum Protect server.
SET LICENSEAUDITPERIOD	Specifies the number of days between automatic license audits.

## AUDIT VOLUME (Verify database information for a storage pool volume)

Use this command to check for inconsistencies between database information and a storage pool volume. Processing information generated during an audit is sent to the activity log and server console.

Restriction: You cannot use this command for volumes that are assigned to copy-container storage pools. You can only audit volumes that belong to storage pools with DATAFORMAT=NATIVE and DATAFORMAT=NONBLOCK.

You cannot audit a volume if it is being deleted from a primary or copy storage pool.

While an audit process is active, clients cannot restore data from the specified volume or store new data to that volume.

If the server detects a file with errors, handling of the file will depend on the type of storage pool to which the volume belongs, whether the FIX option is specified on this command, and whether the file is also stored on a volume assigned to other pools.

If IBM Spectrum Protect™ does not detect errors for a file that was marked as damaged, the state of the file is reset so that it can be used.

The server will not delete archive files that are on deletion hold. If archive retention protection is enabled, the server will not delete archive files whose retention period has not expired.

To display information about the contents of a storage pool volume, use the QUERY CONTENT command.

To audit multiple volumes, you can use the FROMDATE and TODATE parameters. Use the STGPOOL parameter to audit all volumes in a storage pool. When you use the parameters FROMDATE, TODATE, or both, the server limits the audit to only the sequential media volumes that meet the date criteria, and automatically includes all online disk volumes in storage. To limit the number of volumes that may include disk volumes, use the FROMDATE, TODATE, and STGPOOL parameters.

If you are running a server with archive retention protection enabled, and you have data stored in storage pools which are defined with the parameter RECLAMATIONTYPE=SNAPLOCK, the Last Access Date on the NetApp SnapLock Filer for a volume should be equal to the End Reclaim Period date that you see when you issue a QUERY VOLUME F=D command on that volume. During AUDIT VOLUME processing, these dates are compared. If they do not match and the AUDIT VOLUME command is being run with the FIX=NO parameter, a message will be issued to you indicating that the command should be run with the FIX=YES parameter to resolve the inconsistency. If they do not match and the AUDIT VOLUME command is being run with the FIX=YES parameter, the inconsistencies will be resolved.

Attention: Use the FIX=Yes parameter only if your tape drive and storage area network (SAN) infrastructure is stable. Ensure that the tape heads are clean and that the tape device drivers are stable and reliable. Otherwise, you risk deleting data that is error free when you use this parameter. The server cannot determine whether a tape is physically damaged or whether a tape infrastructure is unstable.

This command creates a background process that can be canceled with the CANCEL PROCESS command. To display information on background processes, use the QUERY PROCESS command.

### Privilege class

To issue this command, you must have system privilege, unrestricted storage privilege, or restricted storage privilege for the storage pool to which the volume is defined.

### Syntax

```

                                .-Fix-----No-----.
>>-AUDit Volume---+volume_name+-----+----->
                '-| A |-----' '-Fix-----+No---+'
                                '-Yes-'

    .-SKIPPartial-----No-----.  .-Quiet-----No-----.
>--+-----+-----+-----+-----><
    '-SKIPPartial-----+No---+' '-Quiet-----+No---+'
                                '-Yes-'          '-Yes-'

A (at least one of these parameters must be specified)

|-----+-----+-----+----->
| (1)                                     |
```

```
'-----STGPool---poolname-'
      (1)                                (1)
.------FROMDate---TODAY-.  .-TODate---TOday-----
>--+-----+-----+-----+-----+-----+-----+
'-FROMDate---date-----'  '-TODate---date-----'
```

Notes:

1. You cannot specify a volume name if you specify a storage pool name, FROMDATE, or TODATE.

## Parameters

---

volume\_name

Specifies the name of the storage pool volume you want to audit. This parameter is required if you do not specify a storage pool. You cannot specify a volume name together with the FROMDATE and TODATE parameters.

Fix

Specifies how the server resolves inconsistencies between the database inventory and the specified storage pool volume. This parameter is optional. The default is NO.

The actions the server performs depend on whether the volume is assigned to a primary or a copy storage pool.

### Primary Storage Pool:

Note: If the AUDIT VOLUME command does not detect an error in a file that was previously marked as damaged, IBM Spectrum Protect resets the state of the file so that it can be used. This provides a means for resetting the state of damaged files if it is determined that the errors were caused by a correctable hardware problem such as a dirty tape head.

Fix=No

IBM Spectrum Protect reports, but does not delete, database records that refer to files with inconsistencies:

- IBM Spectrum Protect marks the file as damaged in the database. If a backup copy is stored in a copy storage pool, you can restore the file using the RESTORE VOLUME or RESTORE STGPOOL command.
- If the file is a cached copy, you must delete references to the file on this volume by issuing the AUDIT VOLUME command and specifying FIX=YES. If the physical file is not a cached copy, and a duplicate is stored in a copy storage pool, it can be restored by using the RESTORE VOLUME or RESTORE STGPOOL command.

Fix=Yes

The server fixes any inconsistencies as they are detected:

- If the physical file is a cached copy, the server deletes the database records that refer to the cached file. The primary file is stored on another volume.
- If the physical file is not a cached copy, and the file is also stored in one or more copy storage pools, the error will be reported and the physical file marked as damaged in the database. You can restore the physical file by using the RESTORE VOLUME or RESTORE STGPOOL command.
- If the physical file is not a cached copy, and the physical file is not stored in a copy storage pool, each logical file for which inconsistencies are detected are deleted from the database.
- If archive retention protection is enabled by using the SET ARCHIVERETENTIONPROTECTION command, a cached copy of data can be deleted if needed. Data in primary and copy storage pools can only be marked damaged and never deleted.

Do not use the AUDIT VOLUME command with FIX=YES if a restore process (RESTORE STGPOOL or RESTORE VOLUME) is running. The AUDIT VOLUME command could cause the restore to be incomplete.

### Copy Storage Pool:

Fix=No

The server reports the error and marks the physical file copy as damaged in the database.

Fix=Yes

The server deletes any references to the physical file and any database records that point to a physical file that does not exist.

SKIPPPartial

Specifies whether IBM Spectrum Protect ignores partial files, which are files that span multiple storage pool volumes. This parameter is optional. The default value is NO. When performing an audit operation on a sequential access media volume,

this parameter prevents additional sequential access media mounts that may be necessary to audit any partial files.  
Possible values are:

No

IBM Spectrum Protect audits files that span multiple volumes.  
Unless you specify SKIPPARTIAL=YES, IBM Spectrum Protect attempts to process each file stored on the volume, including files that span into and out of other volumes. To audit files that span multiple volumes, the following conditions must be true:

- For sequential access volumes, the additional sequential access volumes must have an access mode of read/write or read-only.
- For random access volumes, the additional volumes must be online.

Yes

IBM Spectrum Protect audits only files that are stored on the volume to be audited. The status of any partial files is unknown.

Quiet

Specifies whether IBM Spectrum Protect sends detailed informational messages to the activity log and the server console about irretrievable files on the volume. This parameter is optional. The default is NO. Possible values are:

No

Specifies that IBM Spectrum Protect sends detailed informational messages and a summary. Each message contains the node, file space, and client name for the file.

Yes

Specifies that IBM Spectrum Protect sends only a summary report.

FROMDate

Specifies the beginning date of the range to audit volumes. The default is the current date. All sequential media volumes meeting the time range criteria that were written to after this date are audited. The server includes all online disk volumes in storage. The server starts one audit process for each volume and runs the process serially. You cannot use this parameter if you have specified a volume. This parameter is optional. To limit the number of volumes that may include disk volumes, use the FROMDATE, TODATE, and STGPOOL parameters.

You can specify the date by using one of the following values:

Value	Description	Example
MM/DD/YYYY	A specific date	10/15/2001  If a date is entered, all candidate volumes written on that day (starting at 12:00:01 am) will be evaluated.
TODAY	The current date	TODAY
TODAY-days <b>or</b> -days	The current date minus days specified. The maximum number of days you can specify is 9999.	TODAY -7 <i>or</i> -7.  To display information beginning with volumes written a week ago, you can specify FROMDATE=TODAY-7 <i>or</i> FROMDATE= -7.
EOLM (End Of Last Month)	The last day of the previous month.	EOLM
EOLM-days	The last day of the previous month minus days specified.	EOLM-1  To include files that were active a day before the last day of the previous month.
BOTM (Beginning Of This Month)	The first day of the current month.	BOTM
BOTM+days	The first day of the current month, plus days specified.	BOTM+9  To include files that were active on the 10th day of the current month.

TODate

Specifies the ending date of the range for volumes to audit. All sequential media volumes meeting the time range criteria that were written to before this date are audited. The server includes all online disk volumes in storage. If you do not specify a value, the server defaults to the current date. You cannot use this parameter if you have specified a volume. This parameter is optional. To limit the number of volumes that may include disk volumes, use the FROMDATE, TODATE, and STGPPOOL parameters.

You can specify the date by using one of the following values:

Value	Description	Example
MM/DD/YYYY	A specific date	10/15/2001  If a date is entered, all candidate volumes written on that day (ending at 11:59:59 pm) will be evaluated.
TODAY	The current date	TODAY
TODAY-days <b>or</b> -days	The current date minus days specified. The maximum number of days you can specify is 9999.	TODAY-1 <b>or</b> -1.  To display information created up to yesterday, you can specify TODATE=TODAY-1 or simply TODATE=-1.
EOLM (End Of Last Month)	The last day of the previous month.	EOLM
EOLM-days	The last day of the previous month minus days specified.	EOLM-1  To include files that were active a day before the last day of the previous month.
BOTM (Beginning Of This Month)	The first day of the current month.	BOTM
BOTM+days	The first day of the current month, plus days specified.	BOTM+9  To include files that were active on the 10th day of the current month.

#### STGPool

This parameter specifies that the server only audits the volumes from the specified storage pool. This parameter is optional. You cannot use this parameter if you have specified a volume.

### Example: Verify database information for a specific storage pool volume

Verify that the database information for storage pool volume PROG2 is consistent with the data stored on the volume. IBM Spectrum Protect fixes any inconsistencies.

```
audit volume prog2 fix=yes
```

### Example: Verify database information for all volumes written to during a specific date range

Verify that the database information for all eligible volumes written to from 3/20/2002 to 3/22/2002 is consistent with data stored on the volume.

```
audit volume fromdate=03/20/2002 todate=03/22/2002
```

### Example: Verify database information for all volumes in a specific storage pool

Verify that the database information for all volumes in storage pool STPOOL3 is consistent with data stored on the volume for today.

```
audit volume stgpool=STPOOL3
```

### Example: Verify database information for all volumes in a specific storage pool written to in the last two days

Verify that the database information for all volumes in storage pool STPOOL3 is consistent with data stored on the volume for the last two days.

## Related commands

Table 1. Commands related to AUDIT VOLUME

Command	Description
CANCEL PROCESS	Cancels a background server process.
QUERY CONTENT	Displays information about files in a storage pool volume.
QUERY PROCESS	Displays information about background processes.
QUERY VOLUME	Displays information about storage pool volumes.
SET ARCHIVERETENTIONPROTECTION	Specifies whether data retention protection is activated.

## BACKUP commands

Use the BACKUP commands to create backup copies of IBM Spectrum Protect™ information or objects.

- BACKUP DB (Back up the database)
- BACKUP DEVCONFIG (Create backup copies of device configuration information)
- BACKUP NODE (Back up a NAS node)
- BACKUP STGPPOOL (Back up primary storage pool data to a copy storage pool)
- BACKUP VOLHISTORY (Save sequential volume history information)

### BACKUP DB (Back up the database)

Use this command to back up an IBM Spectrum Protect™ database to sequential access volumes.

Attention: To restore a database, the server must use information from the volume history file and the device configuration file. You must make and save copies of the volume history file and the device configuration file. These files cannot be recreated.

To determine how much extra storage space a backup requires, issue the QUERY DB command.

Restrictions: You cannot restore a server database if the release level of the server database backup is different from the release level of the server that is being restored. For example, an error occurs when you restore a Version 6.3 database and you are using a Version 7.1 server.

After the database backup is complete, the IBM Spectrum Protect server backs up information, depending on the options that are specified in the server options file. The following information is backed up:

- Sequential volume-history information is backed up to all files that the VOLUMEHISTORY option specifies
- Information about device configuration is backed up to all files that the DEVCONFIG option specifies
- The server's master encryption key

If there is not enough space available on the defined active log directory volume or file space, you can define the DB2® option, *overflowlogpath*, to use a directory with the required space available. For example, use the following command to use the /home/tsminst2/overflow\_dir directory:

```
db2 update db cfg for TSMDB1 using overflowlogpath /home/tsminst2/overflow_dir
```

## Privilege class

To issue this command, you must have system privilege or unrestricted storage privilege.

## Syntax

```
>>-BBackup DB--DEVclass-----device_class_name----->
      .-Type-----Full-----+
>--+-----+----->
      '-Type-----+Incremental-+-'
              +-Full-----+
```

```

'-DBSnapshot--'
>-----+-----+-----+-----+-----+----->
|           .-,-----|.           |
|           v           |           |
'-VOLumenames-----+---volume_name+---+-'
|           '-FILE:-- file_name-'
|
.-NUMStreams-----1-----|. -Scratch-----Yes-----|.
>-----+-----+-----+-----+-----+----->
'-NUMStreams-----number-' '-Scratch-----+Yes+-'
|                                     '-No--'
|
.-Wait-----No-----|. -DEDUPDEvice-----No-----|.
>-----+-----+-----+-----+-----+----->
'-Wait-----+No--+-' '-DEDUPDEvice-----+No--+-'
|                                     '-Yes-'
|                                     '-Yes-'
|
.-COMPRESS-----No-----|. -PROTECTKeys-----Yes-----|.
>-----+-----+-----+-----+-----+----->
|           (1) | '-PROTECTKeys-----+No--+-'
'-COMPRESS-----+No--+-'
|                                     '-Yes-'
|                                     '-Yes-'
|
>-----+-----+-----+-----+-----+----->>
'-PASSWORD-----password_name-'

```

#### Notes:

1. The default value of the COMPRESS parameter is conditional. If you specify the COMPRESS parameter in the BACKUP DB command, it overrides any COMPRESS parameter value that is set in the SET DBRECOVERY command. Otherwise, the value that is set in the SET DBRECOVERY command is the default.

## Parameters

### DEVclass (Required)

Specifies the name of the sequential access device class to use for the backup. If you issue the BACKUP DB command, and the device class is not the one that is specified in the SET DBRECOVERY command, a warning message is issued. However, the backup operation continues and is not affected.

If the SET DBRECOVERY command is not issued to set a device class, the BACKUP DB command fails.

### Restriction:

- You cannot use a device class with a device type of NAS or CENTERA.
- A restore database operation fails if the source for the restore is a FILE library. A FILE library is created if the FILE device class specifies SHARED=YES.

If all drives for this device class are busy when the backup runs, IBM Spectrum Protect cancels lower priority operations, such as reclamation, to make a drive available for the backup.

### Type

Specifies the type of backup to run. This parameter is optional. The default is FULL. The following values are possible:

#### Full

Specifies that you want to run a full backup of the IBM Spectrum Protect database.

#### Incremental

Specifies that you want to run an incremental backup of the IBM Spectrum Protect database. An incremental (or cumulative) backup image contains a copy of all database data that is changed since the last successful full backup operation.

#### DBSnapshot

Specifies that you want to run a full snapshot database backup. The entire contents of a database are copied and a new snapshot database backup is created without interrupting the existing full and incremental backup series for the database.

### VOLumenames

Specifies the volumes that are used to back up the database. This parameter is optional. However, if you specify SCRATCH=NO, you must specify a list of volumes.

#### volume\_name

Specifies the volumes that are used to back up the database. Specify multiple volumes by separating the names with commas and no intervening spaces.

#### FILE:filename

Specifies the name of a file that contains a list of volumes that are used to back up the database. Each volume name must be on a separate line. Blank lines and comment lines, which begin with an asterisk, are ignored.

For example, to use volumes DB0001, DB0002, and DB0003, create a file that contains these lines:

```
DB0001
DB0002
DB0003
```

Name the file appropriately. For example:

- **AIX** | **Linux** TAPEVOL
- **Windows** TAPEVOL.DATA

You can then specify the volumes for the command as follows:

```
AIX | Linux
VOLUMENAMES=FILE:TAPEVOL
```

```
Windows
VOLUMENAMES=FILE:TAPEVOL.DATA
```

#### NUMStreams

Specifies the number of parallel data movement streams to use when you back up the database. The minimum value is 1, and the maximum value is 32. Increasing the value causes a corresponding increase in the number of database backup sessions to be used and the number of drives to be used for the device class. If you specify a NUMSTREAMS value in the BACKUP DB command, it overrides any value that is set in the SET DBRECOVERY command. Otherwise, the value that is set in the SET DBRECOVERY command is used. The NUMSTREAMS value is used for all types of database backups.

If a value is specified that is greater than the number of drives available for the device class, only the number of available drives are used. The available drives are those defined to the device class by the MOUNTLIMIT parameter or by the number of online drives for the specified device class. The session is displayed in the QUERY SESSION output.

If you increase the number of streams, more volumes are used from the corresponding device class for this operation.

Using more volumes might improve the speed of the database backups, but at the cost of more volumes that are not fully used.

#### Scratch

Specifies whether scratch volumes can be used for the backup. This parameter is optional. The default is YES. The following values are possible:

##### Yes

Specifies that scratch volumes can be used.

If you specify SCRATCH=YES and the VOLUMENAMES parameter, IBM Spectrum Protect uses only scratch volumes if space is unavailable on the specified volumes.

If you do not include a list of volumes by using the VOLUMENAMES parameter, you must either specify SCRATCH=YES or use the default.

##### No

Specifies that scratch volumes cannot be used.

If you specify volumes by using the VOLUMENAMES parameter and SCRATCH=NO, the backup fails if there is not enough space available to store the backup data on the specified volumes.

#### Wait

Specifies whether to wait for the server to complete processing this command in the foreground. The default is NO. The following values are possible:

##### No

Specifies that the server processes this command in the background. You can continue with other tasks while the command is being processed.



Messages that are created from the background process are displayed either in the activity log or the server console, depending on where messages are logged.

To cancel a background process, use the CANCEL PROCESS command. If a BACKUP DB background process is canceled, some of the database might have already been backed up before the cancellation.

Yes

Specifies that the server processes this command in the foreground. Wait for the command to complete before you continue with other tasks. The server then displays the output messages to the administrative client when the command completes.

Restriction: You cannot specify WAIT=YES from the server console.

#### DEDUPDEvice

Specifies that a target storage device supports data deduplication. When set to YES, the format for backup images is optimized for data deduplication devices, making backup operations more efficient. The following values are possible:

No

Specifies that a target storage device does not support data deduplication. NO is the default.

Ensure that this parameter is set to NO for the following devices:

- SCSI libraries
- All devices that are defined with a FILE device class
- Virtual tape libraries (VTL) that do not support the data deduplication function

Yes

Specifies that a target device supports data deduplication and that you want to optimize backups for this function. You can set this parameter to YES if you are using VTLs that support data deduplication.

#### COMPRESS

Specifies whether volumes that are created by the BACKUP DB command are compressed. The COMPRESS value is used for all types of database backups. This parameter is optional. The default value is conditional. If you specify the COMPRESS parameter on the BACKUP DB command, it overrides any value that is set in the SET DBRECOVERY command. Otherwise, the value that is set in the SET DBRECOVERY command is the default. You can specify one of the following values:

No

Specifies that the volumes that are created by the BACKUP DB command are not compressed.

Yes

Specifies that the volumes that are created by the BACKUP DB command are compressed.

Restrictions:

- Use caution when you specify the COMPRESS parameter. Using compression during database backups can reduce the size of the backup files. However, compression can increase the time that is required to complete database backup processing.
- Do not back up compressed data to tape. If your system environment stores database backups on tape, set the COMPRESS parameter to No in the SET DBRECOVERY and BACKUP DB commands.

AIX	Linux	Windows	PROTECTKeys
-----	-------	---------	-------------

AIX	Linux	Windows	Specifies that database backups include a copy of the server master encryption key that is used to encrypt storage pool data. This parameter is optional. The default is the value that is specified for the PROTECTKEYS parameter on the SET DBRECOVERY command. You can specify one of the following values:
-----	-------	---------	--

No

Specifies that database backups do not include a copy of the server master encryption key.

Attention: If you specify PROTECTKEYS=NO, you must manually back up the master encryption key for the server and make the key available when you implement disaster recovery.

Yes

Specifies that database backups include a copy of the server master encryption key.

Attention: If you specify PROTECTKEYS=YES, you must also specify the PASSWORD parameter.

AIX	Linux	Windows	PASSword
-----	-------	---------	----------

AIX	Linux	Windows	Specifies the password that is used to protect the database backup. The default is the value that is specified for the PASSWORD parameter on the SET DBRECOVERY command.
-----	-------	---------	--

Important: Ensure that you remember this password. If you specify a password for database backups, you must specify the same password on the RESTORE DB command to restore the database.

## Example: Run an incremental backup by using a scratch volume

Run an incremental backup of the database by using a scratch volume. Use a device class of FILE for the backup.

```
backup db devclass=file type=incremental
```

AIX

Linux

Windows

## Example: Encrypt storage pool data in database backups

Encrypt storage pool data by specifying that database backups include a copy of the server master encryption key. Issue the following command:

```
backup db protectkeys=yes password=password_name
```

## Related commands

Table 1. Commands related to BACKUP DB

Command	Description
BACKUP DEVCONFIG	Backs up IBM Spectrum Protect device information to a file.
BACKUP VOLHISTORY	Records volume history information in external files.
CANCEL PROCESS	Cancels a background server process.
DELETE VOLHISTORY	Removes sequential volume history information from the volume history file.
EXPIRE INVENTORY	Manually starts inventory expiration processing.
MOVE DRMEDIA	Moves DRM media onsite and offsite.
PREPARE	Creates a recovery plan file.
QUERY DB	Displays allocation information about the database.
QUERY PROCESS	Displays information about background processes.
QUERY VOLHISTORY	Displays sequential volume history information that has been collected by the server.
SET DBRECOVERY	Specifies the device class to be used for automatic backups.
SET DRMDBBACKUPEXPIREDDAYS	Specifies criteria for database backup series expiration.

## BACKUP DEVCONFIG (Create backup copies of device configuration information)

Use this command to back up information about device configuration for the server.

Attention: To restore a database, the server must use information from the volume history file and the device configuration file. You must make and save copies of the volume history file and the device configuration file. These files cannot be recreated. This command backs up the following information in one or more files:

- Device class definitions
- Library definitions
- Drive definitions
- Path definitions when SRCTYPE=SERVER
- Server definitions
- Server name
- Server password
- Volume location information for LIBTYPE=SCSI libraries

**AIX** | **Linux** You can use the DEVCONFIG server option to specify one or more files in which to store device configuration information. IBM Spectrum Protect™ updates the files whenever a device class, library, or drive is defined, updated, or deleted.

**Windows** At installation, the server options file includes a DEVCONFIG option that specifies a device configuration file named devcnfg.out. IBM Spectrum Protect updates this file whenever a device class, library, or drive is defined, updated, or deleted.

To ensure updates are complete before the server is halted:

- Do not halt the server for a few minutes after issuing the BACKUP DEVCONFIG command.
- Specify multiple DEVCONFIG options in the server options file.
- Examine the device configuration file to see if the file has been updated.

## Privilege class

Any administrator can issue this command unless it includes the FILENAMES parameter. If the FILENAMES parameter is specified and the REQSYSAUTHOUTFILE server option is set to YES, the administrator must have system privilege. If the FILENAMES parameter is specified and the REQSYSAUTHOUTFILE server option is set to NO, the administrator must have operator, policy, storage or system privilege.

## Syntax

```
>>-Backup DEVCONFig-----><
|                               .-./-----|
|                               V           |
|'-Filenames-----filename-----'
```

## Parameters

### Filenames

Specifies the files in which to store device configuration information. You can specify multiple files by separating the names with commas and no intervening spaces. This parameter is optional.

If you do not specify a file name, IBM Spectrum Protect stores the information in all files specified with the DEVCONFIG option in the server options file.

## Example: Backup device configuration information to a file

Back up device configuration information to a file named DEVICE.

```
backup devconfig filenames=device
```

## Related commands

Table 1. Commands related to BACKUP DEVCONFIG

Command	Description
CHECKIN LIBVOLUME	Checks a storage volume into an automated library.
CHECKOUT LIBVOLUME	Checks a storage volume out of an automated library.
DEFINE DEVCLASS	Defines a device class.
<b>AIX</b>   <b>Linux</b> DEFINE DEVCLASS (z/OS® media server)	<b>AIX</b>   <b>Linux</b> Defines a device class to use storage managed by a z/OS media server.
DEFINE DRIVE	Assigns a drive to a library.
DEFINE LIBRARY	Defines an automated or manual library.
DEFINE PATH	Defines a path from a source to a destination.
DEFINE SERVER	Defines a server for server-to-server communications.
LABEL LIBVOLUME	Labels volumes in manual or automated libraries.
QUERY LIBVOLUME	Displays information about a library volume.

Command	Description
SET SERVERNAME	Specifies the name by which the server is identified.
SET SERVERPASSWORD	Specifies the server password.
UPDATE DEVCLASS	Changes the attributes of a device class.
<b>AIX</b>   <b>Linux</b> UPDATE DEVCLASS (z/OS media server)	<b>AIX</b>   <b>Linux</b> Changes the attributes of a device class for storage managed by a z/OS media server.
UPDATE DRIVE	Changes the attributes of a drive.
UPDATE LIBRARY	Changes the attributes of a library.
UPDATE LIBVOLUME	Changes the status of a storage volume.
UPDATE PATH	Changes the attributes associated with a path.
UPDATE SERVER	Updates information about a server.

## BACKUP NODE (Back up a NAS node)

Use this command to start a backup operation for a network-attached storage (NAS) node.

Backups that are created for NAS nodes with this BACKUP NODE command are functionally equivalent to backups that are created by using the BACKUP NAS command on an IBM Spectrum Protect™ client. You can restore these backups with either the server's RESTORE NODE command or the client's RESTORE NAS command.

### Privilege class

To issue this command, you must have system privilege, policy privilege for the domain to which the node is assigned, or client owner authority over the node.

### Syntax

```
>>-Backup Node--node_name-+-----+----->
                        | .-,------. |
                        | V                | |
                        '----file_system_name----+'

                        .-TOC-----Preferred-----.
>--+-----+-----+-----+----->
  '-MGmtclass-----mcname-' '-TOC-----+No-----+'
                                +-Preferred-+
                                '-Yes-----'

  .-Wait-----No-----.  .-MODE-----DIFFerential-----.
>--+-----+-----+-----+----->
  '-Wait-----+No--+-' '-MODE-----+FULL-----+'
        '-Yes-'          '-DIFFerential-'

  .-TYPE-----BACKUPImage-----.
>--+-----+-----+-----+-----><
  '-TYPE-----+BACKUPImage--+-'
        '-SNAPMirror--'
```

### Parameters

node\_name (Required)

Specifies the node for which the backup will be performed. You cannot use wildcard characters or specify a list of names.

file\_system\_name

Specifies the name of one or more file systems to back up. You can also specify names of virtual file spaces that have been defined for the NAS node. The file system name that you specify cannot contain wildcard characters. You can specify more than one file system by separating the names with commas and no intervening spaces.

If you do not specify a file system, all file systems will be backed up. Any virtual file spaces defined for the NAS node are backed up as part of the file system image, not separately.

If a file system exists on the NAS device with the same name as the virtual file space specified, IBM Spectrum Protect automatically renames the existing virtual file space in the server database, and backs up the NAS file system which matches the name specified. If the virtual file space has backup data, the file space definition associated with the virtual file space will also be renamed.

Tip: See the virtual file space name parameter in the DEFINE VIRTUALFSMAPPING command for more naming considerations.

In determining the file systems to process, the server will not use any DOMAIN.NAS, INCLUDE.FS.NAS, or EXCLUDE.FS.NAS statements in any client option file or client option set. If you back up multiple file systems, the backup of each file system is a separate server process.

#### MGmtclass

Specifies the name of the management class to which this backup data is bound. If you do not specify a management class, the backup data is bound to the default management class of the policy domain to which the node is assigned. In determining the management class, the server will *not* use any INCLUDE.FS.NAS statements in any client option file or client option set. The destination management class might refer to an IBM Spectrum Protect native pool, in which case Network Data Management Protocol (NDMP) data is sent into the IBM Spectrum Protect native hierarchy. After this occurs, the data stays in the IBM Spectrum Protect hierarchy. Data flowing to IBM Spectrum Protect native pools goes over the LAN and data flowing to NAS pools can be directly attached or over a SAN.

When you specify a management class with the BACKUP NODE command, all versions of the backup data that belong to the NAS node are rebound to the new management class.

#### TOC

Specifies whether a table of contents (TOC) is saved for each file system backup. Consider the following in determining whether you want to save a table of contents:

- If a table of contents is saved, you will be able to use the QUERY TOC command to determine the contents of a file system backup in conjunction with the RESTORE NODE command to restore individual files or directory trees. You can also use the IBM Spectrum Protect web backup-archive client to examine the entire file system tree and choose files and directories to restore. Creation of a table of contents requires that you define the TOCDESTINATION attribute in the backup copy group for the management class to which this backup image is bound. Creating a table of contents requires additional processing, network resources, storage pool space, and possibly a mount point during the backup operation.
- A table of contents for a NAS file system cannot have a directory path greater than 1024 characters.
- If a table of contents is not saved for a file system backup, you will still be able to restore individual files or directory trees using the RESTORE NODE command, provided that you know the fully qualified name of each file or directory to be restored and the image in which that object was backed up.

This parameter is optional. The default value is Preferred. Possible values are:

No

Specifies that table of contents information is not saved for file system backups.

Preferred

Specifies that table of contents information should be saved for file system backups. However, a backup does not fail just because an error occurs during creation of the table of contents. This is the default value.

Yes

Specifies that table of contents information must be saved for each file system backup. A backup fails if an error occurs during creation of the table of contents.

Attention: If MODE=DIFFERENTIAL is specified and a table of contents is requested (TOC=PREFERRED or TOC=YES), but the last full image does not have a table of contents, a full backup will be performed and a table of contents will be created for that full backup.

#### Wait

Specifies whether to wait for the server to complete processing this command in the foreground. The default is NO. Possible values are:

No

Specifies that the server processes this command in the background. Use the QUERY PROCESS command to monitor the background processing of this command.

Yes

Specifies that the server processes this command in the foreground. You wait for the command to complete before continuing with other tasks. The server then displays the output messages to the administrative client when the command completes. If you are backing up multiple file systems, all backup processes must complete before the command is complete.

Attention: You cannot specify WAIT=YES from the server console.

## MODE

Specifies whether the file system backups are full or differential. The default is DIFFERENTIAL.

### FULL

Specifies to back up the entire file system.

### DIFFERENTIAL

Specifies that only the files that have changed since the most recent full backup should be backed up. If you choose a differential backup, and a full backup is not found, a full backup is performed. You cannot specify TYPE=SNAPMIRROR when the MODE parameter is set to DIFFERENTIAL.

## TYPE

Specifies the backup method used to perform the NDMP backup operation. The default value for this parameter is BACKUPIMAGE and it should be used to perform a standard NDMP base or differential backup. Other image types represent backup methods that might be specific to a particular file server. Possible values are:

### BACKUPImage

Specifies that the file system should be backed up using an NDMP dump operation. This is the default method for performing an NDMP backup. The BACKUPIMAGE type operation supports full and differential backups, file-level restore processing and directory-level backup.

### SNAPMirror

Specifies that the file system should be copied to an IBM Spectrum Protect storage pool using the NetApp SnapMirror to Tape function. SnapMirror images are block level full backup images of a file system. Typically, a SnapMirror backup takes significantly less time to perform than a traditional NDMP full file system backup. However there are limitations and restrictions on how SnapMirror images can be used. The SnapMirror to Tape function is intended to be used as a disaster-recovery option for copying very large NetApp file systems to secondary storage.

For most NetApp file systems, use the standard NDMP full or differential backup method. Refer to the documentation that came with your NetApp file server for more information.

When setting the TYPE parameter to SNAPMirror, the following restrictions apply:

Restrictions:

- You cannot specify TOC=YES or TOC=PREFERRED.
- The file\_system\_name cannot be a virtual filesystem name.
- The snapshot which is created automatically by the file server during the SnapMirror copy operation will be deleted at end of the operation.
- This parameter is valid for NetApp and IBM® N-Series file servers only.

## Example: Perform a full backup

---

Perform a full backup on the /vol/vol10 file system of NAS node NAS1.

```
backup node nas1 /vol/vol10 mode=full
```

## Example: Perform a backup on a directory and create a table of contents

---

Back up the directory /vol/vol2/mikes on the node NAS1 and create a table of contents for the image. For the following two examples, assume Table 1 contains the virtual file space definitions exist on the server for the node NAS1.

```
backup node nas1 /mikesdir
```

Table 1. Virtual file space definitions

Virtual file space name	File system	Path
/mikesdir	/vol/vol2	/mikes
/DataDirVol2	/vol/vol2	/project1/data

Virtual file space name	File system	Path
/TestDirVol1	/vol/vol1	/project1/test

## Example: Perform a backup on two directories

Back up the directories /vol/vol2/project1/data and /vol/vol1/project1/test of the node NAS1. Refer to Table 1 for the virtual file space definitions that exist on the server for the node NAS1.

```
backup node nas1 /DataDirVol2,/testdirvol1 mode=full toc=yes
```

## Related commands

Table 2. Commands related to BACKUP NODE

Command	Description
BACKUP NAS (client command)	Creates a backup of NAS node data.
CANCEL PROCESS	Cancels a background server process.
DEFINE COPYGROUP	Defines a copy group for backup or archive processing within a specified management class.
DEFINE VIRTUALFSMAPPING	Define a virtual file space mapping.
QUERY NASBACKUP	Displays information about NAS backup images.
QUERY TOC	Displays details about the table of contents for a specified backup image.
QUERY COPYGROUP	Displays the attributes of a copy group.
RESTORE NAS (client command)	Restores a backup of NAS node data.
RESTORE NODE	Restores a network-attached storage (NAS) node.
UPDATE COPYGROUP	Changes one or more attributes of a copy group.

### Related concepts:

Backup and restore using NetApp SnapMirror to Tape feature

## BACKUP STGPOOL (Back up primary storage pool data to a copy storage pool)

Use this command to back up primary storage pool files to a copy storage pool.

You can back up data from a primary storage pool that is defined with the NATIVE, NONBLOCK, or any of the NDMP formats (NETAPPDUMP, CELERRADUMP, or NDMPDUMP). The copy storage pool to which data is to be backed up must have the same data format as the primary storage pool. IBM Spectrum Protect™ supports back-end data movement for NDMP images.

If a file exists in the copy storage pool, the file is not backed up unless the copy of the file in the copy storage pool is marked as damaged. However, a new copy is not created if the file in the primary storage pool is also marked as damaged. In a random-access storage pool, cached copies of migrated files and damaged primary files are not backed up.

Tip: Issuing this command for a primary storage pool that is set up for data deduplication removes duplicate data, if the copy storage pool is also set up for data deduplication.

If migration for a storage pool starts during a storage pool backup, some files might be migrated before they are backed up. You might want to back up storage pools that are higher in the migration hierarchy before you back up storage pools that are lower.

### Restrictions:

- Do not run the MOVE DRMEDIA and BACKUP STGPOOL commands concurrently. Ensure that the storage pool backup processes are complete before you issue the MOVE DRMEDIA command.
- You cannot back up data from or to storage pools defined with a CENTERA device class.

## Privilege class

To issue this command, you must have system privilege, unrestricted storage privilege, or restricted storage privilege for the copy storage pool in which backup copies are to be produced.

## Syntax

```
>>-BACkup STGpool--primary_pool_name--copy_pool_name----->
. -MAXPRocess-----1-----
>--+-----+----->
' -MAXPRocess-----number-'

. -Preview-----No-----
>--+-----+----->
' -Preview-----+No-----+
      +-Yes-----+
      |               (1) |
      '-VOLumesonly-----'

. -SHREDTONOshred-----No----- . -Wait-----No-----
>--+-----+-----+-----><
' -SHREDTONOshred-----+No--+-' ' -Wait-----+No--+-'
      '-Yes-'                '-Yes-'
```

Notes:

1. Valid only for storage pools that are associated with a sequential-access device class.

## Parameters

**primary\_pool** (Required)

Specifies the primary storage pool.

**copy\_pool** (Required)

Specifies the copy storage pool.

**MAXPRocess**

Specifies the maximum number of parallel processes to use for backing up files. This parameter is optional. Enter a value 1 - 999. The default is 1.

Using multiple, parallel processes can improve throughput for the backup. The expectation is that the time needed to complete the storage pool backup is decreased by using multiple processes. However, when multiple processes are running, in some cases one or more of the processes needs to wait to use a volume that is already in use by a different backup process.

When you determine this value, consider the number of logical and physical drives that can be dedicated to this operation. To access a sequential access volume, IBM Spectrum Protect uses a mount point and, if the device type is not FILE, a physical drive. The number of available mount points and drives depends on other IBM Spectrum Protect and system activity and on the mount limits of the device classes for the sequential access storage pools that are involved in the backup.

Each process needs a mount point for copy storage pool volumes, and, if the device type is not FILE, each process also needs a drive. If you are backing up a sequential storage pool, each process needs an extra mount point for primary storage pool volumes and, if the device type is not FILE, an extra drive. For example, suppose that you specify a maximum of three processes to back up a primary sequential storage pool to a copy storage pool of the same device class. Each process requires two mount points and two drives. To run all three processes, the device class must have a mount limit of at least 6, and at least six mount points and six drives must be available.

To preview a backup, only one process is used and no mount points or drives are needed.

**Preview**

Specifies whether you want to preview but not run the backup. The preview displays the number of files and bytes to be backed up and a list of the primary storage pool volumes that you must mount. This parameter is optional. The default is NO. You can specify the following values:

No

Specifies that the backup is done.

Yes



Specifies that you want to preview the backup but not do the backup.

#### VOLUMESONLY

Specifies that you want to preview the backup only as a list of the volumes that must be mounted. This choice requires the least processing time. The VOLUMESONLY option is valid only for storage pools that are associated with a sequential-access device class.

The VOLUMESONLY option can be used to obtain a list of volumes that are needed by the storage pool backup process. For example:

```
backup stgpool primary_pool copystg preview=volumesonly
```

The list of volumes are logged in the server activity log with the ANR1228I message. Query the server activity log to get the list of volumes required. For example:

```
query actlog msg=1228
```

#### SHREDTONOSHRED

Specifies whether data is backed up to a copy storage pool from a primary storage pool that enforces shredding. This parameter is optional. The default value is NO. You can specify the following values:

##### No

Specifies that the server does not allow data to be backed up to a copy storage pool from a primary storage pool that enforces shredding. If the primary storage pool enforces shredding, the operation fails.

##### Yes

Specifies that the server does allow data to be backed up to a copy storage pool from a primary storage pool that enforces shredding. The data in the copy storage pool is not shredded when it is deleted.

#### WAIT

Specifies whether to wait for the server to complete processing this command in the foreground. This parameter is optional. The default is NO. You can specify the following values:

##### No

Specifies that the server processes this command in the background.

You can continue with other tasks while the command is being processed. Messages that are created from the background process are displayed either in the activity log or the server console, depending on where messages are logged.

To cancel a background process, use the CANCEL PROCESS command. If you cancel this process, some files might already have been backed up before the cancellation.

##### Yes

Specifies that the server processes this operation in the foreground. You must wait for the operation to complete before you continue with other tasks. The server displays the output messages to the administrative client when the operation completes.

Note: You cannot specify WAIT=YES from the server console.

## Example: Back up the primary storage pool

Back up the primary storage pool that is named PRIMARY\_POOL to the copy storage pool named COPYSTG.

```
backup stgpool primary_pool copystg
```

## Related commands

Table 1. Commands related to BACKUP STGPOOL

Command	Description
CANCEL PROCESS	Cancel a background server process.
MOVE DRMEDIA	Moves DRM media onsite and offsite.
QUERY DRMEDIA	Displays information about disaster recovery volumes.
QUERY PROCESS	Displays information about background processes.
QUERY SHREDSTATUS	Displays information about data waiting to be shredded.

Command	Description
QUERY STGPOOL	Displays information about storage pools.
RESTORE STGPOOL	Restores files to a primary storage pool from copy storage pools.
RESTORE VOLUME	Restores files stored on specified volumes in a primary storage pool from copy storage pools.
SHRED DATA	Manually starts the process of shredding deleted data.

## BACKUP VOLHISTORY (Save sequential volume history information)

Use this command to back up sequential volume history information to one or more files.

Tip: You must use volume history information when you reload the database and audit affected storage pool volumes. If you cannot start the server, you can use the volume history file to query the database about these volumes.

The volume history includes information about the following types of volumes:

- Archive log volumes
- Database backup volumes
- Export volumes
- Backup set volumes
- Database snapshot volumes
- Database recovery plan file volumes
- Recovery plan file volumes
- Recovery plan file snapshot volumes
- The following sequential access storage pool volumes:
  - Volumes added to storage pools
  - Volumes reused through reclamation or MOVE DATA operations
  - Volumes removed by using the DELETE VOLUME command or during reclamation of scratch volumes

Attention: To restore a database, the server must use information from the volume history file and the device configuration file. You must make and save copies of the volume history file and the device configuration file. These files cannot be recreated.

**AIX** | **Linux** You must use the VOLUMEHISTORY server option to specify one or more volume history files. IBM Spectrum Protect™ updates volume history files whenever server sequential volume history information is changed.

**Windows** At installation, the server options file includes a VOLUMEHISTORY option that specifies a default volume history file named volhist.out. IBM Spectrum Protect updates volume history files whenever server sequential volume history information is changed.

To ensure that updates are complete before the server is halted, follow these steps:

- Do not halt the server for a few minutes after you issue the BACKUP VOLHISTORY command.
- Specify multiple VOLUMEHISTORY options in the server options file.
- Examine the volume history file to see if the file has been updated.

## Privilege class

Any administrator can issue this command unless it includes the FILENAMES parameter. If the FILENAMES parameter is specified and the REQSYSAUTHOUTFILE server option is set to YES, the administrator must have system privilege. If the FILENAMES parameter is specified and the REQSYSAUTHOUTFILE server option is set to NO, the administrator must have operator, policy, storage or system privilege.

## Syntax

```
>>-Backup VOLHistory-----+----->>
|                               .-'.-----'. |
|                               v             | |
|'-Filenames-----file_name-----+'
```

## Parameters

### Filenames

Specifies the names of one or more files in which to store a backup copy of volume history information. Separate multiple file names with commas and no intervening spaces. This parameter is optional.

If you do not specify a file name, IBM Spectrum Protect stores the information in all files specified with the VOLUMEHISTORY option in the server options file.

## Example: Back up the volume history information to a file

Back up the volume history information to a file called VOLHIST.

```
backup volhistory filenames=volhist
```

## Related commands

Table 1. Commands related to BACKUP VOLHISTORY

Command	Description
DELETE VOLHISTORY	Removes sequential volume history information from the volume history file.
DELETE VOLUME	Deletes a volume from a storage pool.
QUERY VOLHISTORY	Displays sequential volume history information that has been collected by the server.
UPDATE VOLHISTORY	Adds or changes location information for a volume in the volume history file.

## BEGIN EVENTLOGGING (Begin logging events)

Use this command to begin logging events to one or more receivers. A receiver for which event logging has begun is an *active receiver*.

When the server is started, event logging automatically begins for the console and activity log and for any receivers that are started automatically based on entries in the server options file. You can use this command to begin logging events to receivers for which event logging is *not* automatically started at server startup. You can also use this command after you have disabled event logging to one or more receivers.

## Privilege class

To issue this command, you must have system privilege.

## Syntax

```
>>-BEgin EVentlogging-+-----+----->>
| .-,----- . |
| V | |
'---+--CONSOLE-----+--'
+-ACTLOG-----+
+-EVENTSERVER----+
+-FILE-----+
+-FILETEXT-----+
| (1) |
+-NTEVENTLOG-----+
| (2) |
+-SYSLOG-----+
+-TIVOLI-----+
'-USEREXIT-----'
```

Notes:

1. This parameter is only available for the Windows operating system.
2. This parameter is only available for the Linux operating system.

## Parameters

Specify one or more receivers. You can specify multiple receivers by separating them with commas and no intervening spaces. If you specify ALL, logging begins for all receivers that are configured. The default is ALL.

ALL

Specifies all receivers that are configured for event logging.

CONSOLE

Specifies the server console as a receiver.

ACTLOG

Specifies the IBM Spectrum Protect™ activity log as a receiver.

EVENTSERVER

Specifies the event server as a receiver.

FILE

Specifies a user file as a receiver. Each logged event is a record in the file and a person cannot read each logged event easily.

FILETEXT

Specifies a user file as a receiver. Each logged event is a fixed-size, readable line.

**Windows** NTEVENTLOG

Specifies the Windows application log as a receiver.

**Linux** SYSLOG

Specifies the Linux system log as a receiver.

TIVOLI

Specifies the Tivoli Management Environment (TME) as a receiver.

USEREXIT

Specifies a user-written routine to which IBM Spectrum Protect writes information as a receiver.

## Example: Begin logging events

Begin logging events to the IBM Spectrum Protect activity log.

```
begin eventlogging actlog
```

## Related commands

Table 1. Commands related to BEGIN EVENTLOGGING

Command	Description
DISABLE EVENTS	Disables specific events for receivers.
ENABLE EVENTS	Enables specific events for receivers.
END EVENTLOGGING	Ends event logging to a specified receiver.
QUERY ENABLED	Displays enabled or disabled events for a specific receiver.
QUERY EVENTRULES	Displays information about rules for server and client events.
QUERY STATUS	Displays the settings of server parameters, such as those selected by the SET commands.

## CANCEL commands

Use the CANCEL commands to end a task or process before it is completed.

- CANCEL EXPIRATION (Cancel an expiration process)
- CANCEL EXPORT (Delete a suspended export operation)
- CANCEL PROCESS (Cancel an administrative process)
- CANCEL REPLICATION (Cancel node replication processes)
- CANCEL REQUEST (Cancel one or more mount requests)
- CANCEL RESTORE (Cancel a restartable restore session)

- CANCEL SESSION (Cancel one or more client sessions)

## CANCEL EXPIRATION (Cancel an expiration process)

Use this command to cancel a process with an unknown process number that is running as a result of an inventory expiration operation.

Use the CANCEL EXPIRATION command if the expiration process number is not known, otherwise use the CANCEL PROCESS and specify the process number of the expiration process. Both commands call the same code to end the expiration process.

You can use the CANCEL EXPIRATION command to automate the cancellation of an expiration process. For example, if you start inventory expiration at midnight and, due to the maintenance workload on the server, the process must finish at 03:00, you can schedule a CANCEL EXPIRATION command to run at 03:00 without knowing the process number.

### Privilege class

To issue this command, you must have system privilege.

### Syntax

```
>>-CANcel EXPIration-----<<
```

### Example: Cancel an inventory expiration process

Cancel the process that was generated by an inventory expiration operation.

```
cancel expiration
```

### Related commands

Table 1. Command related to CANCEL EXPIRATION

Command	Description
QUERY PROCESS	Displays information about background processes.
EXPIRE INVENTORY	Manually starts inventory expiration processing.

## CANCEL EXPORT (Delete a suspended export operation)

Use this command to delete a suspended server-to-server export operation. After issuing the CANCEL EXPORT command, you cannot restart the export operation. Issue the CANCEL PROCESS command to delete a currently running export operation.

### Privilege class

You must have system privilege to issue this command.

### Syntax

```
>>-CANcel EXPort .-*-----
+-----+-----<<
'---export_identifier---
```

### Parameters

export\_identifier

The unique identifier of the suspended export operation that you wish to delete. You can also enter wildcard characters for the identifier. Issue the QUERY EXPORT command to list the currently suspended export operations.

## Example: Delete a specific suspended export operation

Cancel the suspended server-to-server export operation EXPORTALLACCTNODES.

```
cancel export exportallacctnodes
```

## Example: Delete all suspended server-to-server export operations

Cancel all suspended server-to-server export processes.

```
cancel export *
```

## Related commands

Table 1. Commands related to CANCEL EXPORT

Command	Description
CANCEL PROCESS	Cancels a background server process.
EXPORT NODE	Copies client node information to external media or directly to another server.
EXPORT SERVER	Copies all or part of the server to external media or directly to another server.
QUERY EXPORT	Displays the export operations that are currently running or suspended.
RESTART EXPORT	Restarts a suspended export operation.
SUSPEND EXPORT	Suspends a running export operation.

## CANCEL PROCESS (Cancel an administrative process)

Use this command to cancel a background process started by an administrative command or by a process, such as storage pool migration.

The following commands generate background processes:

- AUDIT CONTAINER
- AUDIT LIBRARY
- AUDIT LICENSES
- AUDIT VOLUME
- BACKUP DB
- BACKUP NODE
- BACKUP STGPOOL
- CHECKIN LIBVOLUME
- CHECKOUT LIBVOLUME
- AIX Linux Windows CONVERT STGPOOL
- DELETE FILESPACE
- DELETE VOLUME
- EXPIRE INVENTORY
- EXPORT ADMIN
- EXPORT NODE
- EXPORT POLICY
- EXPORT SERVER
- GENERATE BACKUPSET
- IMPORT ADMIN
- IMPORT NODE
- IMPORT POLICY
- IMPORT SERVER
- MIGRATE STGPOOL
- MOVE DATA
- MOVE DRMEDIA

- MOVE MEDIA
- PREPARE
- PROTECT STGPOOL
- RECLAIM STGPOOL
- REPLICATE NODE
- RESTORE NODE
- RESTORE STGPOOL
- RESTORE VOLUME
- VARY

The following internal server operations generate background processes:

- Inventory expiration
- Migration
- Reclamation

To cancel a process, you must have the process number, which you can obtain by issuing the QUERY PROCESS command.

Some processes, such as reclamation, generate mount requests to complete processing. If a process has a pending mount request, the process might not respond to a CANCEL PROCESS command until the mount request is answered or canceled by using the REPLY or CANCEL REQUEST command, or by timing out.

Issue the QUERY REQUEST command to list open requests, or query the activity log to determine whether a process has a pending mount request. A mount request indicates that a volume is needed for the current process, but the volume is not available in the library. The volume might not be available if the administrator issues the MOVE MEDIA or CHECKOUT LIBVOLUME command, or manually removes the volume from the library.

After you issue a CANCEL PROCESS command for an export operation, the process cannot be restarted. To stop a server-to-server export operation but allow it to be restarted later, issue the SUSPEND EXPORT command.

## Privilege class

To issue this command, you must have system privilege.

## Syntax

```
>>-CANcel PProcess--process_number-----<<
```

## Parameters

process\_number (Required)  
Specifies the number of the background process you want to cancel.





## Example: Cancel a background process by using its process number

Cancel background process number 3.

```
cancel process 3
```

## Related commands

Table 1. Commands related to CANCEL PROCESS

Command	Description
CANCEL EXPORT	Deletes a suspended export operation.
CANCEL REQUEST	Cancels pending volume mount requests.
 CONVERT STGPOOL	 Convert a storage pool to a directory-container storage pool.
 PROTECT STGPOOL	 Protects a directory-container storage pool.

Command	Description
QUERY EXPORT	Displays the export operations that are currently running or suspended.
QUERY PROCESS	Displays information about background processes.
REPLICATE NODE	Replicates data in file spaces that belong to a client node.
REPLY	Allows a request to continue processing.
RESTART EXPORT	Restarts a suspended export operation.
SUSPEND EXPORT	Suspends a running export operation.

## CANCEL REPLICATION (Cancel node replication processes)

Use this command to cancel all node replication processes.

Issue this command on the server that acts as a source for replicated data.

### Privilege class

To issue this command, you must have system privilege.

### Syntax

```
>>-CANcel REPLication-----<<
```

### Parameters

None.

### Example: Cancel node replication processes

Cancel all node replication processes.

```
cancel replication
```

### Related commands

Table 1. Commands related to CANCEL REPLICATION

Command	Description
QUERY PROCESS	Displays information about background processes.
QUERY REPLICATION	Displays information about node replication processes.

## CANCEL REQUEST (Cancel one or more mount requests)

Use this command to cancel one or more pending media mount requests. To cancel a mount request, you need to know the request number assigned to the request. This number is included in the mount request message and can also be shown by using the QUERY REQUEST command.

### Privilege class

To issue this command, you must have system privilege or operator privilege.

### Syntax

```
>>-CANcel REQuest---request_number-----<<
```



'-All-----' '-PERManent-'

## Parameters

---

- request\_number  
Specifies the request number of the mount request to cancel.
- ALL  
Specifies to cancel all pending mount requests.
- PERManent  
Specifies that you want the server to flag the volumes for which you are canceling a mount request as unavailable. This parameter is optional.

## Example: Cancel a mount request

---

Cancel request number 2.

```
cancel request 2
```

## Related commands

---

Table 1. Commands related to CANCEL REQUEST

Command	Description
QUERY REQUEST	Displays information about all pending mount requests.
UPDATE VOLUME	Updates the attributes of storage pool volumes.

## CANCEL RESTORE (Cancel a restartable restore session)

---

Use this command to cancel a restartable restore session. You can cancel restore sessions in the active or restartable state. Any outstanding mount requests related to this session are automatically canceled.

To display restartable restore sessions, use the QUERY RESTORE command.

## Privilege class

---

To issue this command, you must have system or operator privilege.

## Syntax

---

```
>>>-CANcel--REStore--+-session_number-+----->>>  
                '-All-----'
```

## Parameters

---

- session\_number  
Specifies the number for the restartable restore session. An active session is a positive number, and a restartable session is a negative number.
- ALL  
Specifies that all the restartable restore sessions are to be canceled.

## Example: Cancel restore operations

---

Cancel all restore operations.

```
cancel restore all
```

## Related commands

---

Table 1. Commands related to CANCEL RESTORE

Command	Description
QUERY RESTORE	Displays information about restartable restore sessions.

## CANCEL SESSION (Cancel one or more client sessions)

Use this command to cancel existing administrative or client node sessions, and to force an administrative or client node session off the server. Any outstanding mount requests related to this session are automatically canceled. The client node must start a new session to resume activities.

If you cancel a session that is in the idle wait (IdleW) state, the client session is automatically reconnected to the server when it starts to send data again.

If this command interrupts a process, such as backup or archive, the results of any processing active at the time of interruption are rolled back and not committed to the database.

### Privilege class

To issue this command, you must have system or operator privilege.

### Syntax

```
>>-CANcel SEssion---+--session_number-+-----><
                    '-ALL-----'
```

### Parameters

session\_number

Specifies the number of the administrative, server, or client node sessions that you want to cancel.

ALL

Specifies that all client node sessions are canceled. You cannot use this parameter to cancel administrative client or server sessions.

### Example: Cancel a specific client node session

Cancel the client node session with NODEP (session 3).

```
cancel session 3
```

### Related commands

Table 1. Commands related to CANCEL SESSION

Command	Description
DISABLE SESSIONS	Prevents new sessions from accessing IBM Spectrum Protect but permits existing sessions to continue.
LOCK ADMIN	Prevents an administrator from accessing IBM Spectrum Protect.
LOCK NODE	Prevents a client from accessing the server.
QUERY SESSION	Displays information about all active administrator and client sessions with IBM Spectrum Protect.

## CHECKIN LIBVOLUME (Check a storage volume into a library)

Use this command to add a sequential access storage volume or a cleaning tape to the server inventory for an automated library. The server cannot use a volume that physically resides in an automated library until that volume is checked in.

Important:

1. The CHECKIN LIBVOLUME command processing does not wait for a drive to become available, even if the drive is only in the IDLE state. If necessary, you can make a library drive available issuing the DISMOUNT VOLUME command to dismount the volume. After a library drive is available, reissue the CHECKIN LIBVOLUME command.
2. You do not define the drives, check in media, or label the volumes in an external library. The server provides an interface that external media management systems use to operate with the server.
3. When you check in WORM tapes other than 3592, you must use CHECKLABEL=YES or they are checked in as normal read/write tapes.

This command creates a background process that you can cancel with the CANCEL PROCESS command. To display information about background processes, use the QUERY PROCESS command.

For detailed and current drive and library support information, see the Supported Devices website for your operating system:

- [AIX](#) [Windows](#) Supported devices for AIX and Windows
- [Linux](#) Supported devices for Linux

## Privilege class

---

To issue this command, you must have system privilege or unrestricted storage privilege.

## Syntax for SCSI libraries

---

```
>>-CHECKIn LIBVolume--library_name----->
                                     .-SEARCH-----No-.
>-----+volume_name--+-----+----->
+-SEARCH-----Yes--+-----+
|          '-| A |-'          |
'-SEARCH-----Bulk--+-----+'
|          '-| A |-'          |
                                     .-OWNeR-----"------
>--STATus-----+PRIVate+--+-----+----->
+-SCRatch+   '-OWNeR-----server_name-'
'-CLEaner-'

.-CHECKLabel-----Yes----- .-SWAP-----No-----
>--+-----+-----+-----+----->
'-CHECKLabel-----+Yes-----+'   '-SWAP-----+No--+-'
+-No-----+                          '-Yes-'
'-Barcode-'

.-WAITTime-----60-----
>--+-----+-----+-----+-----><
'-WAITTime-----value-'   '-CLEanings-----number---'

A (SEARCH=Yes, SEARCH=Bulk)

|--+VOLRange-----+-----+-----+-----|
|          .-,----- .          |
|          V          |          |
'-VOLList-----+-----+-----+-----+'
'-FILE:--file_name-'
```

## Syntax for 349X libraries

---

```
>>-CHECKIn LIBVolume--library_name----->
                                     .-SEARCH-----No-.
>-----+volume_name--+-----+----->
'-SEARCH-----Yes--+-----+'
|          '-| A |-'          |
                                     .-OWNeR-----"------
>--STATus-----+PRIVate+--+-----+----->
```

```

'-SCRatch-' '-OWNer-----server_name-'

.-CHECKLabel-----Yes-----
>-----+-----+-----+-----+-----+-----+-----+-----+----->
'-CHECKLabel-----+Yes+-' '-DEVType-----+3590+-'
          '-No--'          '-3592-'

.-SWAP-----No-----.  .-WAITTime-----60-----
>-----+-----+-----+-----+-----+-----+-----+-----+-----><
'-SWAP-----+No+-' '-WAITTime-----value-'
          '-Yes-'

A (SEARCH=Yes)

|---+VOLRange--=====volume_name1,volume_name2---+-----|
|          .,-----|
|          V          |
'-VOLList-----+---volume_name+---+-----'
          '-FILE:--file_name-'

```

## Syntax for ACSLS libraries

---

```

>>-CHECKIn LIBVolume--library_name----->

          .-SEARCH-----No-.
>-----+volume_name---+-----+-----+-----+----->
'-SEARCH-----Yes---+-----'
          '-| A |-'

          .-OWNer-----"------
>--STATus-----+PRIVate+---+-----+-----+----->
          '-SCRatch-' '-OWNer-----server_name-'

.-CHECKLabel-----Yes-----.  .-SWAP-----No-----
>-----+-----+-----+-----+-----+-----+-----+-----+----->
'-CHECKLabel-----+Yes+-' '-SWAP-----+No+-'
          '-No--'          '-Yes-'

.-WAITTime-----60-----
>-----+-----+-----+-----+-----+-----+-----+-----+-----><
'-WAITTime-----value-'

A (SEARCH=Yes)

|---+VOLRange--=====volume_name1,volume_name2---+-----|
|          .,-----|
|          V          |
'-VOLList-----+---volume_name+---+-----'
          '-FILE:--file_name-'

```

## Parameters

---

library\_name (Required)

Specifies the name of the library.

volume\_name

Specifies the volume name of the storage volume that is being checked in. This parameter is required if SEARCH equals NO. Do not enter this parameter if the SEARCH parameter equals YES or BULK. If you are checking a volume into a SCSI library with multiple entry/exit ports, the volume in the lowest numbered slot is checked in.

STATus (Required)

Specifies the volume status. Possible values are:

PRIVate

Specifies that the volume is a private volume that is mounted only when it is requested by name.

SCRatch

Specifies that the volume is a new scratch volume. This volume can be mounted to satisfy scratch mount requests during either data storage operations or export operations.

If a volume has an entry in volume history, you cannot check it in as a scratch volume.

#### CLEaner

Specifies that the volume is a cleaner cartridge and not a data cartridge. The CLEANINGS parameter is required for a cleaner cartridge and must be set to the number of cleaner uses.

CHECKLABEL=YES is not valid for checking in a cleaner cartridge. Use STATUS=CLEANER to check in a cleaner cartridge separately from a data cartridge.

#### OWNer

Specifies which library client owns a private volume in a library that is shared across a SAN. The volume for which you specify ownership must be a private volume. You cannot specify ownership for a scratch volume. Furthermore, you cannot specify an owner when you use SEARCH=YES or SEARCH=BULK.

When you issue the CHECKIN LIBVOLUME command, the server validates the owner. If you did not specify this parameter, then the server uses the default and delegates volume ownership to the owning library client, as recorded in the volume history file on the library manager. If the volume is not owned by any library client, then the server delegates ownership to the library manager.

#### SEARCH

Specifies whether the server searches the library to find volumes that were not checked in. This parameter is optional. The default is NO.

Possible values are:

##### No

Specifies that only the named volume is checked into the library.

**For SCSI libraries:** The server issues a request to have the volume inserted into a cartridge slot in the library or, if available, into an entry port. The cartridge slot or entry port is identified by its element address. **For 349X libraries:** The volume might already be in the library, or you can put it into the I/O station when prompted.

##### Yes

Specifies that the server searches the library for volumes to be checked in. You can use the VOLRANGE or VOLLIST parameter to limit the search. When you use this parameter, consider the following restrictions:

- If the library is shared between applications, the server might examine a volume that is required by another application. For 349X libraries, the server queries the library manager to determine all volumes that are assigned to the SCRATCH or PRIVATE category and to the INSERT category.
- For SCSI libraries, do not specify both SEARCH=YES and CHECKLABEL=NO in the same command.

##### Bulk

Specifies that the server searches the library's entry/exit ports for volumes that can be checked in automatically. This option applies to only SCSI libraries.

Important:

1. Do not specify both CHECKLABEL=NO and SEARCH=BULK.
2. You can use the VOLRANGE or VOLLIST parameter to limit the search.

#### VOLRange

Specifies a range of volume names that are separated by commas. You can use this parameter to limit the search for volumes to be checked in when you specify SEARCH=YES (349X, ACSLS, and SCSI libraries) or SEARCH=BULK (SCSI libraries only). If there are no volumes in the library that are within the specified range, the command completes without errors.

Specify only volume names that can be numerically incremented. In addition to the incremental area, a volume name can include an alphanumeric prefix and an alphanumeric suffix, for example:

Parameter	Description
volrange=bar110,bar130	The 21 volumes are checked in: bar110, bar111, bar112,...bar129, bar130.
volrange=bar11a,bar13a	The 3 volumes are checked in: bar11a, bar12a, bar13a.

Parameter	Description
volrange=123400,123410	The 11 volumes are checked in: 123400, 123401, ...123409, 123410.

#### VOLLIST

Specifies a list of volumes. You can use this parameter to limit the search for volumes to be checked in when you specify SEARCH=YES (349X, ACSLS, and SCSI libraries) or SEARCH=BULK (SCSI libraries only). If there are no volumes in the library that are in the list, the command completes without errors.

Possible values are:

##### volume\_name

Specifies one or more volumes names that are separated by commas and no intervening spaces. For example:  
VOLLIST=TAPE01,TAPE02.

##### FILE: file\_name

Specifies the name of a file that contains a list of volumes for the command. In the file, each volume name must be on a separate line. Blank lines and comment lines that begin with an asterisk are ignored. For example, to use volumes TAPE01, TAPE02 and TAPE03, create a file, TAPEVOL, that contains these lines:

```
TAPE01
TAPE02
TAPE03
```

You can specify the volumes for the command as follows: VOLLIST=FILE:TAPEVOL.

Attention: The file name is case-sensitive.

#### CHECKLabel

Specifies how or whether the server should read sequential media labels of volumes. This parameter is optional. The default is YES.

Possible values are:

##### Yes

Specifies that an attempt is made to read the media label during check-in.

Attention:

1. For SCSI libraries, do not specify both SEARCH=YES and CHECKLABEL=NO in the same command.
2. For WORM media other than 3592, you must specify YES.

##### No

Specifies that the media label is not read during check-in. However, suppressing label checking can result in future errors (for example, either a wrong label or an improperly labeled volume can cause an error). For 349X and ACSLS libraries, specify NO to avoid loading cartridges into a drive to read the media label. These libraries always return the external label information about cartridges, and IBM Spectrum Protect™ uses that information.

##### Barcode

Specifies that the server reads the bar code label if the library has a bar code reader and the volumes have external bar code labels. You can decrease the check-in time by using the bar code. This parameter applies only to SCSI libraries.

If the bar code reader cannot read the bar code label, or if the tape does not have a bar code label, the server mounts the tape and reads the internal label.

#### DEVType

Specifies the device type for the volume that is being checked in. This parameter is required if none of the drives in this library have defined paths.

##### 3590

Specifies that the device type for the volume that is being checked in is 3590.

##### 3592

Specifies that the device type for the volume that is being checked in is 3592.

#### SWAP

Specifies whether the server swaps volumes if an empty library slot is not available. The volume that is selected for the swap operation (target swap volume) is ejected from the library and replaced with the volume that is being checked in. The server identifies a target swap volume by checking for an available scratch volume. If none exists, the server identifies the least frequently mounted volume.

This parameter is optional. The default is NO. This parameter applies only if there is a volume name that is specified in the command. Possible values are:

No

Specifies that the server checks in the volume only if an empty slot is available.

Yes

Specifies that if an empty slot is not available, the server swaps cartridges to check in the volume.

#### WAITTime

Specifies the number of minutes that the server waits for you to reply or respond to a request. Specify a value in the range 0-9999. If you want to be prompted by the server, specify a wait time greater than zero. The default value is 60 minutes. For example, suppose the server prompts you to insert a tape into the entry/exit port of a library. If you specified a wait time of 60 minutes, the server issues a request and waits 60 minutes for you to reply. Suppose, on the other hand, you specify a wait time of 0. If you already inserted a tape, a wait time of zero causes the operation to continue without prompting. If you have *not* inserted a tape, a wait time of zero will cause the operation to fail.

#### CLEAnings

Enter the recommended value for the individual cleaner cartridge (usually indicated on the cartridge). Cleanings apply only to SCSI libraries. This parameter is required if STATUS=CLEANER.

If more than one cleaner is checked into the library, only one is used until its CLEANINGS value decreases to zero. Another cleaner is then selected, and the first cleaner can be checked out and discarded.

### Example: Check a volume into a SCSI library

---

Check in a volume named WPDV00 into the SCSI library named AUTO.

```
checkin libvolume auto wpdv00 status=scratch
```

### Example: Use a bar code reader to scan a library for a cleaner cartridge

---

Scan a SCSI library named AUTOLIB1 and, using the bar code reader, look for cleaner cartridge CLNV. Use SEARCH=YES, but limit the search by using the VOLLIST parameter.

```
checkin libvolume autolib1 search=yes vollist=cleanv status=cleaner  
cleanings=10 checklabel=barcode
```

### Example: Scan a library to put unused volumes in a specific range in scratch status

---

Scan a 349X library named ABC, and limit the search to a range of unused volumes BAR110 to BAR130 and put them in scratch status.

```
checkin libvolume abc search=yes volrange=bar110,bar130  
status=scratch
```

### Example: Scan a library to put a specific volume in scratch status

---

Use the barcode reader to scan a SCSI library named MYLIB for VOL1, and put it in scratch status.

```
checkin libvolume mylib search=yes vollist=voll status=scratch  
checklabel=barcode
```

### Related commands

---

Table 1. Commands related to CHECKIN LIBVOLUME

Command	Description
AUDIT LIBRARY	Ensures that an automated library is in a consistent state.
CANCEL PROCESS	Cancels a background server process.
CHECKOUT LIBVOLUME	Checks a storage volume out of an automated library.

Command	Description
DEFINE LIBRARY	Defines an automated or manual library.
DEFINE VOLUME	Assigns a volume to be used for storage within a specified storage pool.
DISMOUNT VOLUME	Dismounts a sequential, removable volume by the volume name.
LABEL LIBVOLUME	Labels volumes in manual or automated libraries.
QUERY LIBRARY	Displays information about one or more libraries.
QUERY LIBVOLUME	Displays information about a library volume.
QUERY PROCESS	Displays information about background processes.
REPLY	Allows a request to continue processing.
UPDATE LIBVOLUME	Changes the status of a storage volume.

## CHECKOUT LIBVOLUME (Check a storage volume out of a library)

Use this command to remove a sequential access storage volume from the server inventory for an automated library. This command creates a background process that can be canceled with the CANCEL PROCESS command. To display information on background processes, use the QUERY PROCESS command.

Restrictions:

1. Check out processing does not wait for a drive to become available, even if the drive is in the IDLE state. If necessary, you can make a library drive available by dismounting the volume with the DISMOUNT VOLUME command. After a drive is available, the CHECKOUT LIBVOLUME command can be reissued.
2. Before checking out volumes from a 349X library, ensure that the 349x Cartridge Input and Output facility has enough empty slots for the volumes to be checked out. The 3494 Library Manager does not inform an application that the Cartridge Input and Output facility is full. It accepts requests to eject a cartridge and waits until the Cartridge Input and Output facility is emptied before returning to the server. IBM Spectrum Protect™ might appear to be hung when it is not. Check the library and clear any intervention requests.
3. Before checking volumes out of an ACSLS library, ensure that the CAP priority in ACSLS is greater than zero. If the CAP priority is zero, then you must specify a value for the CAP parameter on the CHECKOUT LIBVOLUME command.

For detailed and current drive and library support information, see the Supported Devices website for your operating system:

- **AIX** | **Windows** Supported devices for AIX and Windows
- **Linux** Supported devices for Linux

### Privilege class

To issue this command, you must have system privilege or unrestricted storage privilege.

### Syntax for SCSI library

```
>>-CHECKOut LIBVolume--library_name-----+volume_name-+----->
                                     '-| A |-----'
      .-REMove-----Bulk----- . -CHECKLabel-----Yes-----
>--+-----+-----+-----+-----+----->
```





Specify only volume names that can be numerically incremented. In addition to the incremental area, a volume name can include an alphanumeric prefix and an alphanumeric suffix, for example:

Parameter	Description
volrange=bar110,bar130	The 21 volumes are checked out: bar110, bar111, bar112,...bar129, bar130.
volrange=bar11a,bar13a	The 3 volumes are checked out: bar11a, bar12a, bar13a.
volrange=123400,123410	The 11 volumes are checked out: 123400, 123401, ...123409, 123410.

#### VOLLIST

Specifies a list of volumes to check out. If there are no volumes in the library that are in the list, the command completes without errors.

Possible values are:

volume\_name

Specifies the names of one or more values that are used for the command. Example: VOLLIST=TAPE01,TAPE02.

FILE:file\_name

Specifies the name of a file that contains a list of volumes for the command. In the file, each volume name must be on a separate line. Blank lines and comment lines that begin with an asterisk are ignored. For example, to use volumes TAPE01, TAPE02 and TAPE03, create a file, TAPEVOL, that contains these lines:

```
TAPE01
TAPE02
TAPE03
```

You can specify the volumes for the command as follows: VOLLIST=FILE:TAPEVOL.

Attention: The file name is case-sensitive.

#### REMOVe

Specifies that the server tries to move the volume out of the library and into the convenience I/O station or entry/exit ports. This parameter is optional. Possible values, depending on the type of library, are YES, BULK, and NO. The response of the server to each of those options and the default values are described in the following sections.

**349X libraries:** The default is BULK. The following table shows how the server responds for 349X libraries.

Table 1. How the server responds for 349X libraries

REMOVE=YES	REMOVE=BULK	REMOVE=NO
The 3494 Library Manager ejects the cartridge to the convenience I/O station.	The 3494 Library Manager ejects the cartridge to the high-capacity output facility.	The 3494 Library Manager does not eject the volume.  The server leaves the cartridge in the library in the INSERT category for use by other applications.

**SCSI libraries:** The default is BULK. The following table shows how the server responds for a SCSI libraries.

Table 2. How the server responds for SCSI libraries

If a library . . .	And REMOVE=YES, then...	And REMOVE=BULK, then...	And REMOVE=NO, then...
Does not have entry/exit ports	The server leaves the cartridge in its current slot within the library and specifies the slot address in a message.  The server then prompts you to remove the cartridge from the slot and to issue a REPLY command.	The server leaves the cartridge in its current slot within the library and specifies the slot address in a message.  The server does not prompt you to remove the cartridge and does not require a REPLY command.	The server leaves the cartridge in its current slot within the library and specifies the slot address in a message.  The server does not prompt you to remove the cartridge and does not require a REPLY command.

<b>If a library . . .</b>	<b>And REMOVE=YES, then...</b>	<b>And REMOVE=BULK, then...</b>	<b>And REMOVE=NO, then...</b>
<i>Has entry/exit ports and an entry/exit port is available</i>	The server moves the cartridge to the available entry/exit port and specifies the port address in a message.  The server then prompts you to remove the cartridge from the slot and to issue a REPLY command.	The server moves the cartridge to the available entry/exit port and specifies the port address in a message.  The server does not prompt you to remove the cartridge and does not request a REPLY command.	The server leaves the cartridge in its current slot within the library and specifies the slot address in a message.  The server does not prompt you to remove the cartridge and does not require a REPLY command.
<i>Has entry/exit ports, but no ports are available</i>	The server leaves the cartridge in its current slot within the library and specifies the slot address in a message.  The server then prompts you to remove the cartridge from the slot and to issue a REPLY command.	The server waits for an entry/exit port to be made available.	The server leaves the cartridge in its current slot within the library and specifies the slot address in a message.  The server does not prompt you to remove the cartridge and does not require a REPLY command.

**ACSLs libraries:** The default is YES. If the parameter is set to YES, and the cartridge access port (CAP) has an automatic selection priority value of 0, you must specify a CAP ID. The following table shows how the server responds for ACSLS libraries.

Table 3. How the server responds for ACSLS libraries

<b>REMOVE=YES or REMOVE=BULK</b>	<b>REMOVE=NO</b>
The server ejects the cartridge to the convenience I/O station, and deletes the volume entry from the server library inventory.	The server does not eject the cartridge. The server deletes the volume entry from the server library inventory and leaves the volume in the library.

**CHECKLabel**

Specifies how or whether the server reads sequential media labels of volumes.

Attention: This parameter does not apply to IBM® 349X or ACSLS libraries.

This parameter is optional. The default is YES. Possible values are:

Yes

Specifies that the server attempts to read the media label to verify that the correct volume is being checked out.

No

Specifies that during checkout the media label is not read. This improves performance because the read process does not occur.

**FORCE**

Specifies whether the server checks out a volume if an input/output (I/O) error occurs when reading the label.

Attention: This parameter does not apply to IBM 349X or ACSLS libraries.

This parameter is optional. The default is NO. Possible values are:

No

The server does not check out a storage volume if an I/O error occurs when reading the label.

Yes

The server checks out the storage volume even if an I/O error occurs.

**CAP**

Specifies which cartridge access port (CAP) to use for ejecting volumes if you specify REMOVE=YES. This parameter applies to volumes in ACSLS libraries only. If the CAP priority value is set to 0 in the library, this parameter is required. If a CAP priority value greater than 0 is set in the library, this parameter is optional. By default, all CAPs initially have a priority value of 0, which means that ACSLS does not automatically select the CAP.

To display valid CAP identifiers (x,y,z), issue the QUERY CAP command with ALL specified from the Automated Cartridge System System Administrator (ACSSA) console on the ACSLS server host. The identifiers are as follows:

- x The Automated Cartridge System (ACS) ID. This identifier can be a number in the range 0 - 126.
- y The Library Storage Module (LSM) ID. This identifier can be a number in the range 0 - 23.
- z The CAP ID. This identifier can be a number in the range 0 - 11.

For more information, see the StorageTek documentation.

## Example: Check out a volume and check the label

Check out the volume that is named EXB004 from the library named FOREST. Read the label to verify the volume name, but do not move the volume out of the library.

```
checkout libvolume forest exb004 checklabel=yes remove=no
```

## Related commands

Table 4. Commands related to CHECKOUT LIBVOLUME

Command	Description
AUDIT LIBRARY	Ensures that an automated library is in a consistent state.
CANCEL PROCESS	Cancels a background server process.
CHECKIN LIBVOLUME	Checks a storage volume into an automated library.
DEFINE LIBRARY	Defines an automated or manual library.
DEFINE VOLUME	Assigns a volume to be used for storage within a specified storage pool.
LABEL LIBVOLUME	Labels volumes in manual or automated libraries.
QUERY LIBRARY	Displays information about one or more libraries.
QUERY LIBVOLUME	Displays information about a library volume.
QUERY PROCESS	Displays information about background processes.
REPLY	Allows a request to continue processing.
UPDATE LIBVOLUME	Changes the status of a storage volume.

## CLEAN DRIVE (Clean a drive)

Use this command when you want IBM Spectrum Protect™ to immediately load a cleaner cartridge into a drive regardless of the cleaning frequency.

There are special considerations if you plan to use this command with a SCSI library that provides automatic drive cleaning through its device hardware.

Restriction: You cannot run the CLEAN DRIVE command for a drive whose only path source is a NAS file server.

## Privilege class

To issue this command, you must have system privilege or unrestricted storage privilege.

## Syntax

```
>>-CLEAN DRIVE--library_name--drive_name-----<<
```

## Parameters

library\_name (Required)

Specifies the name of the library to which the drive is assigned.  
drive\_name (Required)  
Specifies the name of the drive.

## Example: Clean a specific tape drive

---

You have already defined a library named AUTOLIB by using the DEFINE LIBRARY command, and you have already checked a cleaner cartridge into the library using the CHECKIN LIBVOL command. Inform the server that TAPE DRIVE3 in this library requires cleaning.

```
clean drive autolib tapedrive3
```

## Related commands

---

Table 1. Commands related to CLEAN DRIVE

Command	Description
CHECKIN LIBVOLUME	Checks a storage volume into an automated library.
CHECKOUT LIBVOLUME	Checks a storage volume out of an automated library.
DEFINE DRIVE	Assigns a drive to a library.
DEFINE LIBRARY	Defines an automated or manual library.
DELETE DRIVE	Deletes a drive from a library.
QUERY DRIVE	Displays information about drives.
UPDATE DRIVE	Changes the attributes of a drive.

## COMMIT (Control committing of commands in a macro)

---

Use this command to control when a command is committed in a macro and to update the database when commands complete processing. When issued from the console mode of the administrative client, this command does not generate a message.

If an error occurs while processing the commands in a macro, the server stops processing the macro and rolls back any changes (since the last COMMIT). After a command is committed, it cannot be rolled back.

Ensure that your administrative client session is not running with the ITEMCOMMIT option if you want to control command processing. The ITEMCOMMIT option commits commands inside a script or a macro as *each* command is processed.

## Privilege class

---

Any administrator can issue this command.

## Syntax

---

```
>>-COMMIT-----><
```

## Parameters

---

None.

## Example: Control committing of commands in a macro

---

From the interactive mode of the administrative client, register and grant authority to new administrators using a macro named REG.ADM. Changes are committed after each administrator is registered and is granted authority.

Macro Contents:

```
/* REG.ADM-register policy admin & grant authority*/  
REGister Admin sara hobby  
GRant AUTHority sara CClasses=Policy
```

```

COMMIT /* Commits changes */
REGister Admin ken plane
GRant AUTHority ken CLasses=Policy
COMMIT /* Commits changes */

```

Command  
macro reg.adm

## Related commands

Table 1. Commands related to COMMIT

Command	Description
MACRO	Runs a specified macro file.
ROLLBACK	Discards any uncommitted changes to the database since the last COMMIT was executed.

### Related concepts:

Administrative client macros

AIX Linux Windows

## CONVERT STGPOOL (Convert a storage pool to a container storage pool)

Use this command to convert a primary storage pool that uses a FILE device class, a tape device class, or a virtual tape library (VTL) to a directory-container or a cloud-container storage pool. You can use container storage pools for both inline and client-side data deduplication.

Restrictions: The following restrictions apply to storage pool conversion:

- You can convert a storage pool only once.
- You cannot update the storage pool during conversion processing. Migration and data movement processes are unavailable.
- You must update all policies to ensure that the destination specifies a storage pool that is not converted or undergoing conversion.

During conversion processing, all data from the source storage pool is moved to the target storage pool. When the process is completed, the source storage pool becomes unavailable. When a storage pool is unavailable, you are unable to write any data to it. The source storage pool is eligible for deletion but is not automatically deleted. You can restore data from the source storage pool if necessary.

Attention: During storage pool conversion, data is deleted from copy storage pools and active-data storage pools. This action occurs even if you specified the number of days that must elapse after all files are deleted from a volume before the volume can be rewritten or returned to the scratch pool.

## Privilege class

To issue this command, you must have restricted storage privilege.

## Syntax

```

>>-CONvert STGpool--source_stgpool--target_stgpool----->
. -MAXPProcess-----8-----
>--+-----+-----+-----+-----<
' -MAXPProcess-----number---' '-DURATION====minutes-'

```

## Parameters

source\_stgpool (Required)

Specify a primary storage pool that uses a FILE device class, a tape device class, or a virtual tape library (VTL) for backup and archive processing. This parameter is required.

target\_stgpool (Required)

Specify the name of an existing directory-container or cloud-container storage pool that the storage pool is converted to. This parameter is required the first time that you issue this command.

Tip: If you restart storage pool conversion and the target storage pool is different than the value that is specified the first time that you issued the CONVERT STGPOOL command, the command fails.

#### MAXProcess

Specifies the maximum number of parallel processes that can be used to convert data in the storage pool. This parameter is optional. You can specify a number in the range 1 - 99. The default value is 8.

Tip: Changes to the default value are automatically saved. If you restart storage pool conversion and the parameter value is different than the value that is specified the first time that you issued the CONVERT STGPOOL command, the most recently specified value is used.

#### DURATION

Specifies the maximum number of minutes that a conversion should take before it is canceled. When the specified number of minutes elapses, the server cancels all conversion processes for the storage pool. You can specify a number in the range 1 - 9999. This parameter is optional. If you do not specify this parameter, the conversion runs until it is completed.

Tip: Storage pool conversion for large storage pools can take days to complete. Use this parameter to limit the amount of time for storage pool conversion daily. As a best practice, schedule conversion for at least 2 hours for a storage pool that uses a FILE type device class and at least 4 hours for VTL.

## Example: Convert a storage pool and specify a maximum number of processes

Convert a storage pool that is named DEDUPPOOL1, move the data to a container storage pool that is named DIRPOOL1, and specify 25 maximum processes.

```
convert stgpool deduppool1 dirpool1 maxprocess=25
```

Table 1. Commands related to CONVERT STGPOOL

Command	Description
CANCEL PROCESS	Cancels a background server process.
QUERY CLEANUP	Query the cleanup status of a source storage pool.
QUERY CONVERSION	Query conversion status of a storage pool.
PROTECT STGPOOL	Protects a directory-container storage pool.
REMOVE DAMAGED	Removes damaged data from a source storage pool.

## COPY commands

Use the COPY commands to create a copy of IBM Spectrum Protect™ objects or data.

- COPY ACTIVE DATA (Copy active backup data from a primary storage pool to an active-data pool)
- COPY CLOPTSET (Copy a client option set)
- COPY DOMAIN (Copy a policy domain)
- COPY MGMTCLASS (Copy a management class)
- COPY POLICYSET (Copy a policy set)
- COPY PROFILE (Copy a profile)
- COPY SCHEDULE (Copy a client or an administrative command schedule)
- COPY SCRIPT (Copy an IBM Spectrum Protect script)
- COPY SERVERGROUP (Copy a server group)

## COPY ACTIVE DATA (Copy active backup data from a primary storage pool to an active-data pool)

Use this command to copy active versions of backup data from a primary storage pool to an active-data pool. The primary benefit of active-data pools is fast client restores. Copy your active data regularly to ensure that the data is protected in case of a disaster.

If a file already exists in the active-data pool, the file is not copied unless the copy of the file in the active-data pool is marked damaged. However, a new copy is not created if the file in the primary storage pool is also marked damaged. In a random-access storage pool, neither cached copies of migrated files nor damaged primary files are copied.

If migration for a storage pool starts while active data is being copied, some files might be migrated before they are copied. For this reason, you should copy active data from storage pools that are higher in the migration hierarchy before copying active data from storage pools that are lower. Be sure a copy process is complete before beginning another.

Remember:

- You can only copy active data from storage pools that have a data format of NATIVE or NONBLOCK.
- Issuing this command for a primary storage pool that is set up for data deduplication removes duplicate data, if the active-data pool is also set up for data deduplication.

## Privilege class

---

To issue this command, you must have system privilege, unrestricted storage privilege, or restricted storage privilege for the active-data pool from which active versions of backup data are being copied.

## Syntax

---

```
>>-COPY ACTIVEdata--primary_pool_name--active-data_pool_name---->
. -MAXProcess-----1-----
>--+-----+----->
' -MAXProcess-----number--- '

. -Preview-----No----- . -Wait-----No-----
>--+-----+-----+----->
' -Preview-----+No-----+ ' ' -Wait-----+No--+ '
      +-Yes-----+          ' -Yes- '
      |                   (1) |
      ' -VOLumesonly----- '

. -SHREDTONOshred-----No-----
>--+-----+-----><
' -SHREDTONOshred-----+No--+ '
      ' -Yes- '

```

Notes:

1. The VOLUMESONLY parameter applies to sequential-access storage pools only.

## Parameters

---

primary\_pool\_name (Required)

Specifies the primary storage pool.

active\_data\_pool\_name (Required)

Specifies the active-data pool.

MAXProcess

Specifies the maximum number of parallel processes to use for copying files. This parameter is optional. Enter a value from 1 to 999. The default is 1.

Using multiple, parallel processes may improve throughput for the COPY ACTIVE DATA command. The expectation is that the time needed to copy active data will be decreased by using multiple processes. However, when multiple processes are running, in some cases one or more of the processes might need to wait to use a volume that is already in use by a different COPY ACTIVE DATA process.

When determining this value, consider the number of logical and physical drives that can be dedicated to this operation. To access a sequential-access volume, the server uses a mount point and, if the device type is not FILE, a physical drive. The number of available mount points and drives depends on other server and system activity, and also on the mount limits of the device classes for the sequential-access storage pools that are involved when copying active data.

Each process needs a mount point for active-data pool volumes, and, if the device type is not FILE, each process also needs a drive. If you are copying active data from a sequential-access storage pool, each process needs an additional mount point for primary storage pool volumes and, if the device type is not FILE, an additional drive. For example, suppose you specify a maximum of 3 processes to copy a primary sequential storage pool to an active-data pool of the same device class. Each process requires two mount points and two drives. To run all three processes, the device class must have a mount limit of at least six, and at least six mount points and six drives must be available.

To use the PREVIEW parameter, only one process is used, and no mount points or drives are needed.

Preview



Specifies whether you want to preview but not actually copy any active data. The preview displays the number of files and bytes to be copied and a list of the primary storage pool volumes that you must mount. This parameter is optional. The default is NO. Possible values are:

No

Specifies that active data will be copied.

Yes

Specifies that you want to preview the process but not copy any data.

VOLUMESonly

Specifies that you want to preview the process only as a list of the volumes that must be mounted. This choice requires the least processing time.

Wait

Specifies whether to wait for the server to complete processing this command in the foreground. This parameter is optional. The default is NO. Possible values are:

No

Specifies that the server processes this command in the background.

You can continue with other tasks while the command is being processed. Messages created from the background process are displayed either in the activity log or the server console, depending on where messages are logged.

To cancel a background process, use the CANCEL PROCESS command. If you cancel this process, some files may have already been copied prior to the cancellation.

Yes

Specifies that the server performs this operation in the foreground. You must wait for the operation to complete before continuing with other tasks. The server displays the output messages to the administrative client when the operation completes.

You cannot specify WAIT=YES from the server console.

SHREDTONOshred

Specifies whether data should be copied from a primary storage pool that enforces shredding to an active-data pool that does not enforce shredding. This parameter is optional. The default value is NO. Possible values are:

No

Specifies that the server does not allow data to be copied from a primary storage pool that enforces shredding to an active-data pool that does not enforce shredding. If the primary storage pool enforces shredding and the active-data pool does not, the operation will fail.

Yes

Specifies that the server does allow data to be copied from a primary storage pool that enforces shredding to an active-data pool that does not enforce shredding. The data in the active-data pool will not be shredded when it is deleted.

## Example: Copy primary storage pool data to active-data pool

Copy the active data from a primary storage pool named PRIMARY\_POOL to the active-data pool named ACTIVEPOOL. Issue the command:

```
copy activedata primary_pool activepool
```

## Related commands

Table 1. Commands related to COPY ACTIVE DATA

Command	Description
DEFINE DOMAIN	Defines a policy domain that clients can be assigned to.
DEFINE STGPOOL	Defines a storage pool as a named collection of server storage media.
EXPORT NODE	Copies client node information to external media or directly to another server.

Command	Description
EXPORT SERVER	Copies all or part of the server to external media or directly to another server.
IMPORT NODE	Restores client node information from external media.
IMPORT SERVER	Restores all or part of the server from external media.
MOVE NODEDATA	Moves data for one or more nodes, or a single node with selected file spaces.
QUERY CONTENT	Displays information about files in a storage pool volume.
QUERY DOMAIN	Displays information about policy domains.
QUERY NODE	Displays partial or complete information about one or more clients.
QUERY NODEDATA	Displays information about the location and size of data for a client node.
QUERY STGPOOL	Displays information about storage pools.
RESTORE STGPOOL	Restores files to a primary storage pool from copy storage pools.
RESTORE VOLUME	Restores files stored on specified volumes in a primary storage pool from copy storage pools.
UPDATE DOMAIN	Changes the attributes of a policy domain.
UPDATE STGPOOL	Changes the attributes of a storage pool.

## COPY CLOPTSET (Copy a client option set)

Use this command to copy a client option set.

### Privilege class

To issue this command, you must have system privilege, unrestricted policy privilege, or restricted policy privilege for the policy domain to which the client node is assigned.

### Syntax

```
>>-COpy CLOptset--current_option_set_name--new_option_set_name-><
```

### Parameters

current\_option\_set\_name (Required)

Specifies the name of the client option set to be copied.

new\_option\_set\_name (Required)

Specifies the name of the new client option set. The maximum length of the name is 64 characters.

### Example: Copy a client option set

Copy a client option set named ENG to a new client option set named ENG2.

```
copy cloptset eng eng2
```

### Related commands

Table 1. Commands related to COPY CLOPTSET

Command	Description
---------	-------------

Command	Description
DEFINE CLIENTOPT	Adds a client option to a client option set.
DEFINE CLOPTSET	Defines a client option set.
DELETE CLIENTOPT	Deletes a client option from a client option set.
DELETE CLOPTSET	Deletes a client option set.
QUERY CLOPTSET	Displays information about a client option set.
UPDATE CLIENTOPT	Updates the sequence number of a client option in a client option set.
UPDATE CLOPTSET	Updates the description of a client option set.

## COPY DOMAIN (Copy a policy domain)

Use this command to create a copy of a policy domain.

The server copies the following information to the new domain:

- Policy domain description
- Policy sets in the policy domain (including the ACTIVE policy set, if a policy set is activated)
- Management classes in each policy set (including the default management class, if assigned)
- Copy groups in each management class

### Privilege class

To issue this command, you must have system privilege.

### Syntax

```
>>-COPY Dmain--current_domain_name--new_domain_name-----<<
```

### Parameters

current\_domain\_name (Required)

Specifies the policy domain to copy.

new\_domain\_name (Required)

Specifies the name of the new policy domain. The maximum length of this name is 30 characters.

### Example: Copy a policy domain to a new policy domain

Copy the STANDARD policy domain to a new policy domain, ENGPOLDOM, by entering the following command:

```
copy domain standard engpoldom
```

ENGPOLDOM now contains the standard policy set, management class, backup copy group, and archive copy group.

### Related commands

Table 1. Commands related to COPY DOMAIN

Command	Description
ACTIVATE POLICYSET	Validates and activates a policy set.
COPY MGMTCLASS	Creates a copy of a management class.
DEFINE COPYGROUP	Defines a copy group for backup or archive processing within a specified management class.
DEFINE DOMAIN	Defines a policy domain that clients can be assigned to.

Command	Description
DEFINE MGMTCLASS	Defines a management class.
DEFINE POLICYSET	Defines a policy set within the specified policy domain.
DELETE COPYGROUP	Deletes a backup or archive copy group from a policy domain and policy set.
DELETE DOMAIN	Deletes a policy domain along with any policy objects in the policy domain.
DELETE MGMTCLASS	Deletes a management class and its copy groups from a policy domain and policy set.
QUERY COPYGROUP	Displays the attributes of a copy group.
QUERY DOMAIN	Displays information about policy domains.
QUERY MGMTCLASS	Displays information about management classes.
QUERY POLICYSET	Displays information about policy sets.
REGISTER NODE	Defines a client node to the server and sets options for that user.
UPDATE COPYGROUP	Changes one or more attributes of a copy group.
UPDATE DOMAIN	Changes the attributes of a policy domain.
UPDATE MGMTCLASS	Changes the attributes of a management class.
UPDATE POLICYSET	Changes the description of a policy set.
VALIDATE POLICYSET	Verifies and reports on conditions the administrator must consider before activating the policy set.

## COPY MGMTCLASS (Copy a management class)

Use this command to create a copy of a management class within the same policy set.

The server copies the following information to the new management class:

- Management class description
- Copy groups defined to the management class
- Any attributes for managing files for IBM Spectrum Protect™ for Space Management clients

### Privilege class

To issue this command, you must have system privilege, unrestricted policy privilege, or restricted policy privilege for the policy domain to which the new management class belongs.

### Syntax

```
>>-COPy MGmtclass--domain_name--policy_set_name----->
>--current_class_name--new_class_name-----<
```

### Parameters

- domain\_name (Required)  
Specifies the policy domain to which the management class belongs.
- policy\_set\_name (Required)  
Specifies the policy set to which the management class belongs.
- current\_class\_name (Required)  
Specifies the management class to copy.
- new\_class\_name (Required)

Specifies the name of the new management class. The maximum length of this name is 30 characters.

## Example: Copy a management class to a new management class

Copy the management class ACTIVEFILES to a new management class, FILEHISTORY. The management class is in policy set VACATION in the EMPLOYEE\_RECORDS policy domain.

```
copy mgmtclass employee_records vacation
activefiles filehistory
```

## Related commands

Table 1. Commands related to COPY MGMTCLASS

Command	Description
DEFINE COPYGROUP	Defines a copy group for backup or archive processing within a specified management class.
DELETE MGMTCLASS	Deletes a management class and its copy groups from a policy domain and policy set.
QUERY COPYGROUP	Displays the attributes of a copy group.
QUERY MGMTCLASS	Displays information about management classes.
QUERY POLICYSET	Displays information about policy sets.
UPDATE COPYGROUP	Changes one or more attributes of a copy group.
UPDATE MGMTCLASS	Changes the attributes of a management class.

## COPY POLICYSET (Copy a policy set)

Use this command to copy a policy set (including the ACTIVE policy set) within the same policy domain.

The server copies the following information to the new policy set:

- Policy set description
- Management classes in the policy set (including the default management class, if assigned)
- Copy groups in each management class

The policies in the new policy set do not take effect unless you make the new set the ACTIVE policy set.

## Privilege class

To issue this command, you must have system privilege, unrestricted policy privilege, or restricted policy privilege for the policy domain to which the new policy set belongs.

## Syntax

```
>>-COPY Policyset--domain_name--current_set_name--new_set_name-><
```

## Parameters

domain\_name (Required)

Specifies the policy domain to which the policy set belongs.

current\_set\_name (Required)

Specifies the policy set to copy.

new\_set\_name (Required)

Specifies the name of the new policy set. The maximum length of this name is 30 characters.

## Example: Copy a policy set to a new policy set

Copy the policy set `VACATION` to the new policy set `HOLIDAY` in the `EMPLOYEE_RECORDS` policy domain.

```
copy policyset employee_records vacation holiday
```

## Related commands

Table 1. Commands related to COPY POLICYSET

Command	Description
ACTIVATE POLICYSET	Validates and activates a policy set.
COPY MGMTCLASS	Creates a copy of a management class.
DEFINE MGMTCLASS	Defines a management class.
DELETE POLICYSET	Deletes a policy set, including its management classes and copy groups, from a policy domain.
QUERY POLICYSET	Displays information about policy sets.
UPDATE POLICYSET	Changes the description of a policy set.
VALIDATE POLICYSET	Verifies and reports on conditions the administrator must consider before activating the policy set.

## COPY PROFILE (Copy a profile)

Use this command on a configuration manager to copy a profile and all its associated object names to a new profile.

### Privilege class

To issue this command, you must have system privilege.

### Syntax

```
>>-COpy PROFIle--current_profile_name--new_profile_name-----<<
```

### Parameters

`current_profile_name` (Required)

Specifies the profile to copy.

`new_profile_name` (Required)

Specifies the name of the new profile. The maximum length of the profile name is 30 characters.

### Example: Make a copy of a profile

Copy a profile named `VAL` to a new profile named `VAL2`.

```
copy profile val val2
```

## Related commands

Table 1. Commands related to COPY PROFILE

Command	Description
DEFINE PROFASSOCIATION	Associates objects with a profile.
DEFINE PROFILE	Defines a profile for distributing information to managed servers.
DEFINE SUBSCRIPTION	Subscribes a managed server to a profile.
DELETE PROFASSOCIATION	Deletes the association of an object with a profile.

Command	Description
DELETE PROFILE	Deletes a profile from a configuration manager.
DELETE SUBSCRIBER	Deletes obsolete managed server subscriptions.
DELETE SUBSCRIPTION	Deletes a specified profile subscription.
LOCK PROFILE	Prevents distribution of a configuration profile.
NOTIFY SUBSCRIBERS	Notifies servers to refresh their configuration information.
QUERY PROFILE	Displays information about configuration profiles.
QUERY SUBSCRIBER	Displays information about subscribers and their subscriptions to profiles.
QUERY SUBSCRIPTION	Displays information about profile subscriptions.
SET CONFIGMANAGER	Specifies whether a server is a configuration manager.
UNLOCK PROFILE	Enables a locked profile to be distributed to managed servers.
UPDATE PROFILE	Changes the description of a profile.

## **COPY SCHEDULE (Copy a client or an administrative command schedule)**

Use this command to create a copy of a schedule.

The COPY SCHEDULE command takes two forms, depending on whether the schedule applies to client operations or administrative commands. The syntax and parameters for each form are defined separately.

Table 1. Commands related to COPY SCHEDULE

Command	Description
DEFINE ASSOCIATION	Associates clients with a schedule.
DEFINE SCHEDULE	Defines a schedule for a client operation or an administrative command.
DELETE SCHEDULE	Deletes a schedule from the database.
QUERY SCHEDULE	Displays information about schedules.
UPDATE SCHEDULE	Changes the attributes of a schedule.

- COPY SCHEDULE (Create a copy of a schedule for client operations)  
Use the COPY SCHEDULE command to create a copy of a schedule for client operations. You can copy a schedule within a policy domain or from one policy domain to another policy domain. Use the DEFINE ASSOCIATION command to associate the new schedule with the client nodes.
- COPY SCHEDULE (Create a copy of a schedule for administrative operations)  
Use the COPY SCHEDULE command to create a copy of an administrative command schedule.

## **COPY SCHEDULE (Create a copy of a schedule for client operations)**

Use the COPY SCHEDULE command to create a copy of a schedule for client operations. You can copy a schedule within a policy domain or from one policy domain to another policy domain. Use the DEFINE ASSOCIATION command to associate the new schedule with the client nodes.

### **Privilege class**

To copy a client schedule, you must have system privilege, unrestricted policy privilege, or restricted policy privilege for the policy domain to which you are copying the schedule.

### **Syntax**

```
>>-COPY SCHEDULE--current_domain_name--current_sched_name----->
```

```

      .-current_sched_name-.
>--new_domain_name--+-----+----->
      '-new_sched_name-----'

      .-REPlace----No-----
>--+-----+----->>
      '-REPlace----+No--+-'
              '-Yes-'

```

## Parameters

---

current\_domain\_name (Required)

Specifies the name of the policy domain that contains the schedule you want to copy.

current\_sched\_name (Required)

Specifies the name of the schedule you want to copy.

new\_domain\_name (Required)

Specifies the name of a policy domain to which you want to copy the new schedule.

new\_sched\_name

Specifies the name of the new schedule. You can specify up to 30 characters for the name.

If you do not specify this name, the name of the original schedule is used.

If the schedule name is already defined in the policy domain, you must specify REPLACE=YES, or the command fails.

REPlace

Specifies whether to replace a client schedule. The default is NO. The values are:

No

Specifies that a client schedule is not replaced.

Yes

Specifies that a client schedule is replaced.

## Example: Copy a schedule from one policy domain to another

---

Copy the WEEKLY\_BACKUP schedule that belongs to policy domain EMPLOYEE\_RECORDS to the PROG1 policy domain and name the new schedule WEEKLY\_BACK2. If there is already a schedule with this name defined in the PROG1 policy domain, do not replace it.

```

copy schedule employee_records weekly_backup
prog1 weekly_back2

```

## COPY SCHEDULE (Create a copy of a schedule for administrative operations)

---

Use the COPY SCHEDULE command to create a copy of an administrative command schedule.

### Privilege class

---

To copy an administrative command schedule, you must have system privilege.

### Syntax

---

```

>>-COPY SCHEDULE--current_sched_name--new_sched_name----->
      .-REPlace----No-----
>--Type----Administrative--+-----+----->>
      '-REPlace----+No--+-'
              '-Yes-'

```

## Parameters

---



current\_schedule\_name (Required)

Specifies the name of the schedule you want to copy.

new\_schedule\_name (Required)

Specifies the name of the new schedule. You can specify up to 30 characters for the name.

If the schedule name is already defined, you must specify REPLACE=YES, or the command fails.

Type=Administrative

Specifies that an administrative command schedule is to be copied.

REPlace

Specifies whether to replace an administrative command schedule. The default is NO. The values are:

No

Specifies that an administrative command schedule is not replaced.

Yes

Specifies that an administrative command schedule is replaced.

## Example: Copy an administrative command schedule to another schedule

---

Copy the administrative command schedule, DATA\_BACKUP and name the schedule DATA\_ENG. If there is already a schedule with this name, replace it.

```
copy schedule data_backup data_eng  
type=administrative replace=yes
```

## COPY SCRIPT (Copy an IBM Spectrum Protect script)

---

Use this command to copy an existing IBM Spectrum Protect™ script to a new script with a different name.

### Privilege class

---

To issue this command, you must have operator, policy, storage, or system privilege.

### Syntax

---

```
>>-COpy SCRipt--current_script_name--new_script_name -----><
```

### Parameters

---

current\_script\_name (Required)

Specifies the name of the script you want to copy.

new\_script\_name (Required)

Specifies the name of the new script. You can specify up to 30 characters for the name.

## Example: Make a copy of a script

---

Copy script TESTDEV to a new script and name it ENGDEV.

```
copy script testdev engdev
```

### Related commands

---

Table 1. Commands related to COPY SCRIPT

Command	Description
DEFINE SCRIPT	Defines a script to the IBM Spectrum Protect server.
DELETE SCRIPT	Deletes the script or individual lines from the script.
QUERY SCRIPT	Displays information about scripts.
RENAME SCRIPT	Renames a script to a new name.

Command	Description
RUN	Runs a script.
UPDATE SCRIPT	Changes or adds lines to a script.

## COPY SERVERGROUP (Copy a server group)

Use this command to create a copy of a server group.

### Privilege class

To issue this command, you must have system privilege.

### Syntax

```
>>-COPY SERVERGroup--current_group_name--new_group_name-----><
```

### Parameters

current\_group\_name (Required)

Specifies the server group to copy.

new\_group\_name (Required)

Specifies the name of the new server group. The maximum length of this name is 64 characters.

### Example: Make a copy of a server group

Copy the server group GRP\_PAYROLL to the new group HQ\_PAYROLL.

```
copy servergroup grp_payroll hq_payroll
```

### Related commands

Table 1. Commands related to COPY SERVERGROUP

Command	Description
DEFINE GRPMEMBER	Defines a server as a member of a server group.
DEFINE SERVER	Defines a server for server-to-server communications.
DEFINE SERVERGROUP	Defines a new server group.
DELETE GRPMEMBER	Deletes a server from a server group.
DELETE SERVER	Deletes the definition of a server.
DELETE SERVERGROUP	Deletes a server group.
MOVE GRPMEMBER	Moves a server group member.
QUERY SERVER	Displays information about servers.
QUERY SERVERGROUP	Displays information about server groups.
RENAME SERVERGROUP	Renames a server group.
UPDATE SERVER	Updates information about a server.
UPDATE SERVERGROUP	Updates a server group.

## DEACTIVATE DATA (Deactivate data for a client node)

Use this command to specify that active data that was backed up for an application client node before a specified date is no longer needed. The command marks the data as inactive so it can be deleted according to your data retention policies.

Restriction: The DEACTIVATE DATA command applies only to application clients that protect Oracle databases.

When you issue the DEACTIVATE DATA command, all active backup data that was stored before the specified date becomes inactive. The data can no longer be retrieved, and is deleted when it expires.

The DEACTIVATE DATA command affects only the files that were copied to the server before the specified date and time. Files that were copied after the specified date are still accessible, and the client can still access the server.

## Privilege class

To issue this command, you must have system privilege.

## Syntax

```
>>-DEACTivate Data--node_name--TODate-----date----->
      .-TOTime-----23:59:59-.  .-Wait-----No-----.
>--+-----+-----+-----+-----+-----+-----+----->>
      '-TOTime-----time-----'  '-Wait-----+No--+-'
                                     '-Yes-'
```

## Parameters

node\_name (Required)

Specifies the name of an application client node whose data is to be deactivated.

TODate (Required)

Specifies the date to use to select the backup files to deactivate. IBM Spectrum Protect™ deactivates only those files with a date on or before the date you specify. You can specify the date by using one of the following values:

Value	Description	Example
MM/DD/YYYY	A specific date	01/23/2014
TODAY	The current date	TODAY
TODAY-days or -days	The current date minus days specified. The maximum number of days you can specify is 9999.	TODAY-30 or -30. To deactivate files that are 30 or more days old, you can specify TODAY-30 or -30.
EOLM	End of last month. The last day of the previous month.	EOLM
EOLM-days	The last day of the previous month minus days specified.	EOLM-1 To deactivate files that were active a day before the last day of the previous month.
BOTM	Beginning of this month. The first day of the current month.	BOTM
BOTM+days	The first day of the current month, plus days specified.	BOTM+9 To deactivate files that were active on the 10th day of the current month.

TOTime

Specifies that you want to deactivate files that were created on the server before this time on the specified date. This parameter is optional. The default is the end of the day (23:59:59). Specify the time by using one of the following values:

Value	Description	Example
HH:MM:SS	A specific time on the specified date	12:30:22
NOW	The current time on the specified date	NOW

Value	Description	Example
NOW+HH:MM or +HH:MM	The current time plus hours and minutes on the specified date	NOW+03:00 or +03:00.  If you issue the DEACTIVATE DATA command at 9:00 with TOTIME=NOW+03:00 or TOTIME=+03:00, IBM Spectrum Protect deactivates files that were put on the server at 12:00 or earlier on the specified date.
NOW-HH:MM or -HH:MM	The current time minus hours and minutes on the specified date	NOW-03:30 or -03:30.  If you issue the DEACTIVATE DATA command at 9:00 with TOTIME=NOW-3:30 or TOTIME=-3:30, IBM Spectrum Protect deactivates files that were put on the server at 5:30 or earlier on the specified date.

#### Wait

Specifies whether to wait for the server to complete processing this command in the foreground. This parameter is optional. The default value is NO. Specify the following values:

#### No

The server processes this command in the background and you can continue with other tasks while the command is processing. Messages that are related to the background process are shown either in the activity log file or the server console, depending on where the messages are logged.

#### Yes

The server processes this command in the foreground. The operation must complete before you can continue with other tasks. Messages are shown either in the activity log file or the server console, or both, depending on where the messages are logged.

Restriction: You cannot specify WAIT=YES from the server console.

## Example: Deactivate data for a data protection client node

The client node BANDIT is an IBM Spectrum Protect for Databases: Data Protection for Oracle application client. All of the backup data is active, and so all of the backup data is retained. The following command deactivates data that was backed up before January 3, 2014, so it can be deleted when it expires.

```
deactivate data bandit todate=01/23/2014
```

To periodically deactivate data so it can be deleted when it expires, you might run the following command from within a client schedule.

```
deactivate data bandit todate=today
```

## Related commands

Table 1. Commands related to DEACTIVATE DATA

Command	Description
DECOMMISSION NODE	Decommissions an application or system.
DECOMMISSION VM	Decommissions a virtual machine.

## DECOMMISSION commands

Use the DECOMMISSION commands to remove client nodes from the production environment. Client nodes include applications, systems, and virtual machines.

- DECOMMISSION NODE (Decommission an application or system)
- DECOMMISSION VM (Decommission a virtual machine)

## DECOMMISSION NODE (Decommission an application or system)

Use this command to remove an application or system client node from the production environment. Any backup data that is stored for the client node expires according to policy settings unless you explicitly delete the data.

Attention: This action cannot be reversed and causes deletion of data. Although this command does not delete the client node definition until after its data expires, you cannot recommission the client node. After you issue this command, the client node cannot access the server and its data is not backed up. The client node is locked, and can be unlocked only to restore files. File spaces that belong to the client node, and the client node itself, are eventually removed.

By using this command, you can decommission the following types of client nodes:

#### Application client nodes

Application client nodes include email servers, databases, and other applications. For example, any of the following applications can be an application client node:

- IBM Spectrum Protect™ Snapshot
- IBM Spectrum Protect for Databases
- IBM Spectrum Protect for Enterprise Resource Planning
- IBM Spectrum Protect for Mail
- IBM Spectrum Protect for Virtual Environments

#### System client nodes

System client nodes include workstations, network-attached storage (NAS) file servers, and API clients.

When a client node is no longer needed in the production environment, you can issue this command to initiate a gradual, controlled decommission operation. The command completes the following actions:

- Deletes all schedule associations for the client node. Schedules are no longer run on the client node. This action is equivalent to issuing the DELETE ASSOCIATION command for every schedule with which the client node is associated.
- Prevents the client from accessing the server. This action is equivalent to issuing the LOCK NODE command.

After the command finishes, client node data is no longer backed up to the server. Data that was backed up before the client node was decommissioned is not immediately deleted from the server. However, all backup file versions, including the most recent backup, are now inactive copies. The client files are retained on the server according to your storage management policies.

After all data retention periods expire, and all client backup and archive file copies are removed from server storage, IBM Spectrum Protect deletes the file spaces that belong to the decommissioned node. This action is equivalent to issuing the DELETE FILESPACE command.

After the file spaces for the decommissioned node are deleted, the node definition is deleted from the server. This action is equivalent to issuing the REMOVE NODE command.

After you decommission a client node, but before it is removed from the server, you can use the QUERY NODE command to verify that the client node is decommissioned.

Restriction: You cannot decommission a client node that is configured for replication. You can determine a client node's replication state by using the QUERY NODE command. If a client node is configured for replication, you can remove the client node from replication by using the REMOVE REPLNODE command.

## Privilege class

---

To issue this command, you must have system privilege.

## Syntax

---

```
>>-DECommission Node--node_name--+-----+-----><
                               .-Wait----No-----
                               '-Wait----+No--+'
                                   '-Yes-'
```

## Parameters

---

node\_name (Required)

Specifies the name of the client node to be decommissioned.

Wait

Specifies whether to wait for the server to complete processing this command in the foreground. This parameter is optional. The default value is NO. You can specify the following values:

No

The server processes this command in the background and you can continue with other tasks while the command is processing. Messages that are related to the background process are shown either in the activity log file or the server console, depending on where the messages are logged.

Yes

The server processes this command in the foreground. The operation must complete before you can continue with other tasks. Messages are shown either in the activity log file or the server console, or both, depending on where the messages are logged.

Restriction: You cannot specify WAIT=YES from the server console.

## Example: Decommission a client node

Decommission the client node CODY.

```
decommission node cody
```

## Related commands

Table 1. Commands related to DECOMMISSION NODE

Command	Description
DECOMMISSION VM	Decommissions a virtual machine.
DEACTIVATE DATA	Deactivates data for a client node.

## DECOMMISSION VM (Decommission a virtual machine)

Use this command to remove an individual virtual machine within a data center node. The file space that represents the virtual machine is deleted from the server only after its backup data expires.

Attention: This command cannot be reversed and causes deletion of data. Although this command does not delete the virtual machine file space until after its data expires, you cannot recommission the virtual machine.

When a virtual machine is no longer needed in your production environment, you can issue this command to initiate a staged removal of the virtual machine file space from the server. The DECOMMISSION VM command marks all data that was backed up for the virtual machine as inactive, so it can be deleted according to your data retention policies. After all data that was backed up for the virtual machine expires, the file space that represents the virtual machine is deleted. The DECOMMISSION VM command affects only the virtual machine that you identify. The data center node, and the other virtual machines that are hosted by the data center node are not affected.

## Privilege class

To issue this command, you must have system privilege.

## Syntax

```
>>>-DEComMission VM--node_name--vm_name----->
                                     .-Wait----No-----
>--+-----+-----+-----+----->>
  '-NAMEType--FSID--' '-Wait-----+Yes--+'
                               '-No--'
```

## Parameters

node\_name (Required)

Specifies the name of the data center node that hosts the virtual machine to be decommissioned.

vm\_name (Required)

Identifies the file space that represents the virtual machine to be decommissioned. Each virtual machine that is hosted by a data center node is represented as a file space.

If the name includes one or more spaces, you must enclose the name in double quotation marks when you issue the command.

By default, the server interprets the file space name that you enter by using the server code page and also attempts to convert the file space name from the server code page to the UTF-8 code page. Conversion might fail if the string includes characters that are not available in the server code page, or if the server cannot access system conversion routines.

If the name of the virtual machine is a non-English-language name, this parameter must specify the file space ID (FSID). By specifying the NAMETYPE parameter, you can instruct the server to interpret the file space name by its file space ID (FSID) instead.

#### NAMETYPE

Specify how you want the server to interpret the file space name that you enter to identify the virtual machine. This parameter is useful when the server has clients with Unicode support. You can specify the following value:

##### FSID

The server interprets the file space name by its file space ID (FSID).

#### Wait

Specifies whether to wait for the server to complete processing this command in the foreground. This parameter is optional. The default value is No. You can specify the following values:

##### No

The server processes this command in the background and you can continue with other tasks while the command is processing. Messages that are related to the background process are shown either in the activity log file or the server console, depending on where the messages are logged.

##### Yes

The server processes this command in the foreground. The operation must complete before you can continue with other tasks. Messages are shown either in the activity log file or the server console, or both, depending on where the messages are logged.

Restriction: You cannot specify WAIT=YES from the server console.

## Examples: Decommission a virtual machine

---

Decommission the virtual machine CODY.

```
decommission vm dept06node cody
```

Decommission the virtual machine CODY 2.

```
decommission vm dept06node "cody 2"
```

Decommission a virtual machine by specifying its file space ID.

```
decommission vm dept06node 7 nametype=fsid
```

## Related commands

---

Table 1. Commands related to DECOMMISSION VM

Command	Description
DECOMMISSION NODE	Decommissions an application or system.
DEACTIVATE DATA	Deactivates data for a client node.

## DEFINE commands

---

Use the DEFINE commands to create IBM Spectrum Protect™ objects.

- DEFINE ALERTTRIGGER (Define an alert trigger)
- DEFINE ASSOCIATION (Associate client nodes with a schedule)

- DEFINE BACKUPSET (Define a backup set)
- DEFINE CLIENTACTION (Define a one-time client action)
- DEFINE CLIENTOPT (Define an option to an option set)
- DEFINE CLOPTSET (Define a client option set name)
- DEFINE COLLOGGROUP (Define a collocation group)
- DEFINE COLLOCMEMBER (Define collocation group member)
- DEFINE COPYGROUP (Define a copy group)
- DEFINE DATAMOVER (Define a data mover)
- DEFINE DEVCLASS (Define a device class)
- DEFINE DOMAIN (Define a new policy domain)
- DEFINE DRIVE (Define a drive to a library)
- DEFINE EVENTSERVER (Define a server as the event server)
- DEFINE GRPMEMBER (Add a server to a server group)
- DEFINE LIBRARY (Define a library)
- DEFINE MACHINE (Define machine information for disaster recovery)
- DEFINE MACHNODEASSOCIATION (Associate a node with a machine)
- DEFINE MGMTCLASS (Define a management class)
- DEFINE NODEGROUP (Define a node group)
- DEFINE NODEGROUPMEMBER (Define node group member)
- DEFINE PATH (Define a path)
- DEFINE POLICYSET (Define a policy set)
- DEFINE PROFASSOCIATION (Define a profile association)
- DEFINE PROFILE (Define a profile)
- DEFINE RECMEDMACHASSOCIATION (Associate recovery media with a machine)
- DEFINE RECOVERYMEDIA (Define recovery media)
- DEFINE SCHEDULE (Define a client or an administrative command schedule)
- DEFINE SCRIPT (Define an IBM Spectrum Protect script)
- DEFINE SERVER (Define a server for server-to-server communications)
- DEFINE SERVERGROUP (Define a server group)
- DEFINE SPACETRIGGER (Define the space trigger)
- DEFINE STATUSTHRESHOLD (Define a status monitoring threshold)
- DEFINE STGPOOL (Define a storage pool)
- DEFINE STGPOOLDIRECTORY (Define a storage pool directory)
- DEFINE SUBSCRIPTION (Define a profile subscription)
- DEFINE VIRTUALFSMAPPING (Define a virtual file space mapping)
- DEFINE VOLUME (Define a volume in a storage pool)

## DEFINE ALERTTRIGGER (Define an alert trigger)

---

Use this command to trigger an alert whenever a server issues a specific error message. You can define a message number to be an alert trigger, assign it to a category, or specify administrators who can be notified of the alert by email.

### Privilege class

---

To issue this command, you must have system privilege.

### Syntax

---

```

      .-,------.
      v          |
>>-DEfINE ALERTTrigger---+--message_number+----->

      .-CATegory--==--SErver-----.
>--+-----+-----+----->
      '-CATegory--==--+APplication+-'
          +-INventory---+
          +-CLient-----+
          +-DEvice-----+
          +-SErver-----+
          +-STorage-----+
          +-SYstem-----+
          '-VMclient----'
```





Command	Description
DELETE ALERTTRIGGER (Remove a message from an alert trigger)	Removes a message number that can trigger an alert.
QUERY ALERTSTATUS (Query the status of an alert)	Displays information about alerts that have been issued on the server.
QUERY ALERTTRIGGER (Query the list of defined alert triggers)	Displays message numbers that trigger an alert.
QUERY MONITORSETTINGS (Query the configuration settings for monitoring alerts and server status)	Displays information about monitoring alerts and server status settings.
UPDATE ALERTTRIGGER (Update a defined alert trigger)	Updates the attributes of one or more alert triggers.
UPDATE ALERTSTATUS (Update the status of an alert)	Updates the status of a reported alert.

## DEFINE ASSOCIATION (Associate client nodes with a schedule)

Use this command to associate one or more clients with a schedule. You must assign a client node to the policy domain to which a schedule belongs. Client nodes process operations according to the schedules associated with the nodes.

Note:

1. IBM Spectrum Protect™ cannot run multiple schedules concurrently for the same client node.
2. In a macro, the server may stall if some commands (such as REGISTER NODE and DEFINE ASSOCIATION) are not committed as soon as you issue them. You could follow each command in a macro with a COMMIT command. However, a simpler solution is to include the -ITEMCOMMIT option with the DSMADMC command.

### Privilege class

To issue this command, you must have one of the following privilege classes:

- System privilege
- Unrestricted policy privilege
- Restricted policy privilege for the policy domain to which the schedule belongs

### Syntax

```
>>-DEFine ASSOCIation--domain_name--schedule_name----->
      .-,-----
      v          |
>-----node_name+-----<<
```

### Parameters

domain\_name (Required)

Specifies the name of the policy domain to which the schedule belongs.

schedule\_name (Required)

Specifies the name of the schedule that you want to associate with one or more clients.

node\_name (Required)

Specifies the name of a client node or a list of client nodes to associate with the specified schedule. Use commas to separate the items in the list. Do not leave spaces between the items and commas. You can use a wildcard character to specify a name. The command will not associate a listed client to the schedule if:

- The client is already associated with the specified schedule.
- The client is not assigned to the policy domain to which the schedule belongs.
- The client is a NAS node name. All NAS nodes are ignored.

### Example: Associate client nodes with a schedule

Associate the client nodes SMITH or JOHN with the WEEKLY\_BACKUP schedule. The associated clients are assigned to the EMPLOYEE\_RECORDS policy domain.

```
define association employee_records
weekly_backup smith*,john*
```

## Example: Associate client nodes with a schedule

Associate the client nodes JOE, TOM, and LARRY with the WINTER schedule. The associated clients are assigned to the EMPLOYEE\_RECORDS policy domain; however, the client JOE is already associated with the WINTER schedule.

```
define association employee_records
winter joe,tom,larry
```

## Related commands

Table 1. Commands related to DEFINE ASSOCIATION

Command	Description
DEFINE SCHEDULE	Defines a schedule for a client operation or an administrative command.
DELETE ASSOCIATION	Deletes the association between clients and a schedule.
DELETE SCHEDULE	Deletes a schedule from the database.
QUERY ASSOCIATION	Displays the clients associated with one or more schedules.
REGISTER NODE	Defines a client node to the server and sets options for that user.

## DEFINE BACKUPSET (Define a backup set)

Use this command to define a client backup set that was previously generated on one server and make it available to the server that is running this command. The client node has the option of restoring the backup set from the server that is running this command rather than the one on which the backup set was generated.

Any backup set generated on one server can be defined to another server when the servers share a common device type. The level of the server to which the backup set is being defined must be equal to or greater than the level of the server that generated the backup set.

You can also use the DEFINE BACKUPSET command to redefine a backup set that was deleted on a server.

## Privilege class

If the REQSYSAUTHOUTFILE server option is set to YES (the default), the administrator must have system privilege. If the REQSYSAUTHOUTFILE server option is set to NO, the administrator must have system privilege or policy privilege for the domain to which the client node is assigned.

## Syntax

```

      .-,-----
      v |
>>-DEFINE BACKUPSET-----+node_name-----+----->
      '-node_group_name-'

>--backup_set_name_prefix--DEVclass----device_class_name----->

      .-,-----
      v |
>>-VOLumes-----volume_names----->

      .-RETention-----365-----
>-------+----->
      '-RETention-----+days-----'
      '-NOLimit-'

```

```

>----->
'-DESCRIPTION----description-'

.-WHEREDATATYPE----ALL-----
>----->
|          .-.-.-.-.-|
|          V          |
'-WHEREDATATYPE-----FILE-----'
          '-IMAGE-'

>-----><
'-TOC-----PREFERRED+-' '-TOCMgmtclass----class_name-'
      +-YES-----+
      '-NO-----'

```

## Parameters

### node\_name or node\_group\_name (Required)

Specifies the name of the client nodes or node groups whose data is contained in the specified backup set volumes. To specify multiple node and node group names, separate the names with commas and no intervening spaces. Node names can contain wildcard characters, but node group names cannot. If the backup set volumes contain backup sets from multiple nodes, every backup set whose node name matches one of the specified node names is defined. If the volumes contain a backup set for a node that is not currently registered, the DEFINE BACKUPSET command does not define the backup set for that node.

### backup\_set\_name\_prefix (Required)

Specifies the name of the backup set to define to this server. The maximum length of the name is 30 characters.

When you select a name, IBM Spectrum Protect™ adds a suffix to construct the backup set name. For example, if you name your backup set *mybackupset*, IBM Spectrum Protect adds a unique number such as 3099 to the name. Your backup set name is then identified as *mybackupset.3099*. To later display information about this backup set, you can include a wildcard with the name, such as *mybackupset\** or you can specify the fully qualified name, such as *mybackupset.3099*.

If the backup set volumes contain backup sets for multiple nodes, then backup sets are defined for each of the nodes by using the same backup set name prefix and suffix.

### DEVclass (Required)

Specifies the device class name for the volumes from which the backup set is read.

**Note:** The device type that is associated with the device class you specify must match the device class with which the backup set was originally generated.

### VOLUMes (Required)

Specifies the names of the volumes that are used to store the backup set. You can specify multiple volumes by separating the names with commas and no intervening spaces. The volumes that you specify must be available to the server that is defining the backup set.

**Note:** The volumes that you specify must be listed in the order they were created, or the DEFINE BACKUPSET command fails.

The server does not verify that every volume specified for a multiple-volume backup set contains part of the backup set. The first volume is always checked, and in some cases extra volumes are also checked. If these volumes are correct, the backup set is defined and all of the volumes that are listed in the command are protected from being overwritten. If a volume that contains part of the backup set is not listed in the command, the volume is not protected and can potentially be overwritten during normal server operations.

**Note:** By default, the server attempts to create a table of contents when a backup set is defined. If an incorrect volume is specified, or if volumes are not listed in the correct order, the table of contents creation fails. If this failure occurs, check the volume list in the command and consider using the QUERY BACKUPSETCONTENTS command to verify the contents of the backup set.

### RETention

Specifies the number of days that the backup set is retained on the server. You can specify an integer 0 - 30000. The default is 365 days. The values are:

#### days

Specifies the number of days to retain the backup set on the server.

#### NOLimit

Specifies that the backup set must be retained on the server indefinitely.

If you specify NOLIMIT, IBM Spectrum Protect retains the volumes that contain the backup set forever, unless a user or administrator deletes the volumes from server storage.

#### DEScRiption

Specifies the description to associate with the backup set that belongs to the client node. This parameter is optional. The maximum length of the description is 255 characters. Enclose the description in quotation marks if it contains any blank characters.

#### WHEREDATAType

Specifies the backup sets containing the specified types of data are to be defined. This parameter is optional. The default is that backup sets for all types of data (file level, image, and application) are to be defined. To specify multiple data types, separate the data types with commas and no intervening spaces. Possible values are:

##### ALL

Specifies that backup sets for all types of data (file level, image, and application) are to be defined. ALL is the default value.

##### FILE

Specifies that a file level backup set is to be defined. File level backup sets contain files and directories that are backed up by the backup client.

##### IMAGE

Specifies that an image backup set is to be defined. Image backup sets contain images that are created by the backup-archive client BACKUP IMAGE command.

#### TOC

Specifies whether a table of contents (TOC) must be created for the file level backup set when it is defined. The TOC parameter is ignored when you define image and application data backup sets because a table of contents is always created for these backup sets.

Consider the following in determining whether you want to create a table of contents:

- If a table of contents is created, you can use the IBM Spectrum Protect web backup-archive client to examine the entire file system tree and choose files and directories to restore. Creation of a table of contents requires that you define the TOCDESTINATION attribute in the backup copy group for the management class that is specified by the TOCMGMTCLASS parameter. To create a table of contents extra processing, storage pool space, and possibly a mount point during the backup set operation is required.
- If a table of contents is not saved for a backup set, you can still restore individual files or directory trees by using the backup-archive client RESTORE BACKUPSET command if you know the fully qualified name of each file or directory to be restored.

This parameter is optional. The default value is Preferred. Possible values are:

##### No

Specifies that table of contents information is not saved for file level backup sets.

##### Preferred

Specifies that table of contents information must be saved for file level backup sets. However, a backup set does not fail just because an error occurs during creation of the table of contents.

##### Yes

Specifies that table of contents information must be saved for each file level backup set. A backup set fails if an error occurs during creation of the table of contents.

#### TOCMGmtclass

Specifies the name of the management class to which the table of contents must be bound. If you do not specify a management class, the table of contents is bound to the default management class for the policy domain to which the node is assigned. In this case, creation of a table of contents requires that you define the TOCDESTINATION attribute in the backup copy group for the specified management class.

## Example: Define a backup set

---

Define the PERS\_DATA backup set that belongs to client node JANE to the server that is running this command. Retain the backup set on the server for 50 days. Specify that volumes VOL001 and VOL002 contain the data for the backup set. The volumes are to be read by a device that is assigned to the AGADM device class. Include a description.

```
define backupset jane pers_data devclass=agadm
volumes=vol1,vol2 retention=50
description="sector 7 base image"
```

## Related commands

Table 1. Commands related to DEFINE BACKUPSET

Command	Description
DEFINE NODEGROUP	Defines a group of nodes.
DEFINE NODEGROUPMEMBER	Adds a client node to a node group.
DELETE NODEGROUP	Deletes a node group.
DELETE BACKUPSET	Deletes a backup set.
DELETE NODEGROUPMEMBER	Deletes a client node from a node group.
GENERATE BACKUPSET	Generates a backup set of a client's data.
GENERATE BACKUPSETTOC	Generates a table of contents for a backup set.
QUERY BACKUPSET	Displays backup sets.
QUERY BACKUPSETCONTENTS	Displays contents contained in backup sets.
QUERY NODEGROUP	Displays information about node groups.
UPDATE BACKUPSET	Updates a retention value associated with a backup set.
UPDATE NODEGROUP	Updates the description of a node group.

## DEFINE CLIENTACTION (Define a one-time client action)

Use this command to schedule one or more clients to process a command for a one-time action.

The server automatically defines a schedule and associates the client node to the schedule. The server assigns the schedule priority 1, sets the PERUNITS to ONETIME, and determines the number of days to keep the schedule active. The number of days is based on the value set with the SET CLIENTACTDURATION command.

How quickly the client processes this command depends on whether the scheduling mode for the client is set to server-prompted or client-polling. The client scheduler must be started on the client workstation in order for the server to process the schedule.

Remember: The start of the IBM Spectrum Protect™ scheduler depends on the processing of other threads in the server and other processes on the IBM Spectrum Protect server host system. The amount of time it takes to start the scheduler also depends on network traffic and how long it takes to open a socket, to connect with the IBM Spectrum Protect client, and to receive a response from the client. In general, the greater the processing and connectivity requirements on the IBM Spectrum Protect server and client, the longer it can take to start the scheduler.

## Privilege class

To issue this command, you must have system privilege, unrestricted policy privilege, or restricted policy for the policy domain to which the schedule belongs.

## Syntax

```

      .-,-,------.
      v             |
>>- DEFINE CLIENTAction-----node_name+----->
      .-DOmain-----*------.
>--+-----+-----+-----+----->
      |             .-,-,------. |
      |             v             | |
      |'-DOmain-----domain_name-+-'|
      .-ACTION-----Incremental------.
>--+-----+-----+-----+-----+----->
      |'-ACTION-----+Incremental-----+-----+
      |   +Selective-----+-----+
      |   +-Archive--+-----+-----+

```

```

|          |          .-"-----' | |
|          | -SUBACTion---+-----+-' | |
|          |          +-FASTBack----+ | |
|          |          +-SYSTEMState++ | |
|          |          '-VM-----' | |
+-Backup-+-----+-----+-----+
|          |          .-"-----' | |
|          | -SUBACTion---+-----+-' | |
|          |          +-FASTBack----+ | |
|          |          +-SYSTEMState++ | |
|          |          '-VM-----' | |
+-REStore-----+-----+-----+
+-RETriev-----+-----+-----+
+-IMAGEBACKup-----+-----+-----+
+-IMAGERESore-----+-----+-----+
+-Command-----+-----+-----+
'-Macro-----+-----+-----+'

>--+-----+-----+-----+----->
'-OPTions---option_string-'

|          |          .-Wait---No-----'
>--+-----+-----+-----+-----><
'-OBJects---object_string-' '-Wait---+No---+'
|          |          '-Yes-'

```

## Parameters

### node\_name (Required)

Specifies the name of the client node that will process the schedule associated with the action. If you specify multiple node names, separate the names with commas; do not use intervening spaces. You can use the asterisk wildcard character to specify multiple names.

### DOmain

Specifies the list of policy domains used to limit the list of client nodes. Only client nodes that are assigned to one of the specified policy domains will be scheduled. All clients assigned to a matching domain will be scheduled. Separate multiple domain names with commas and no intervening spaces. If you do not specify a value, all policy domains will be included in the list.

### ACTion

Specifies the action that occurs when this schedule is processed. Possible values are:

#### Incremental

Specifies that the schedule backs up all files that are new or that have changed since the last incremental backup. Incremental also backs up any file for which all existing backups might have expired.

#### Selective

Specifies that the schedule backs up only files that are specified with the OBJECTS parameter.

#### Archive

Specifies that the schedule archives files that are specified with the OBJECTS parameter.

#### Backup

Specifies that the schedule backs up files that are specified with the OBJECTS parameter.

#### REStore

Specifies that the schedule restores files that are specified with the OBJECTS parameter.

When you specify ACTION=RESTORE for a scheduled operation, and the REPLACE option is set to PROMPT, no prompting occurs. If you set the option to PROMPT, the files are skipped.

If you specify a second file specification, this second file specification acts as the restore destination. If you need to restore multiple groups of files, schedule one for each file specification that you need to restore.

#### RETriev

Indicates that the schedule retrieves files that are specified with the OBJECTS parameter.

Remember: A second file that is specified acts as the retrieve destination. If you need to retrieve multiple groups of files, create a separate schedule for each group of files.

#### IMAGEBACKup

Specifies that the schedule backs up logical volumes that are specified with the OBJECTS parameter.

#### IMAGERESore

Specifies that the schedule restores logical volumes that are specified with the OBJECTS parameter.

## Command

Specifies that the schedule processes a client operating system command or script that is specified with the OBJECTS parameter.

## Macro

Specifies that a client processes a macro whose file name is specified with the OBJECTS parameter.

## SUBACTiOn

You can specify one of the following values:

""

When a null string (two double quotes) is specified with ACTION=BACKUP the backup is an incremental.

## FASTBACk

Specifies that a FastBack client operation that is identified by the ACTION parameter is to be scheduled for processing. The ACTION parameter must be either ARCHIVE or BACKUP.

## SYSTEMStAte

Specifies that a client Systemstate backup is scheduled.

## VApp

Specifies that a client vApp backup is scheduled. A vApp is a collection of pre-deployed virtual machines.

## VM

Specifies that a client VMware backup operation is scheduled.

## OPTiOns

Specifies the client options that you specify to the scheduled command at the time the schedule is processed. This parameter is optional.

Only those options that are valid on the scheduled command can be specified for this parameter. Refer to the appropriate client manual for information about options that are valid from the command line. All options described there as valid only on the initial command line result in an error or are ignored when running the schedule from the server. For example, do not include the following options because they have no effect when the client processes the scheduled command:

- MAXCMDRETRIES
- OPTFILE
- QUERYSCHEDPERIOD
- RETRYPERIOD
- SCHEDLOGNAME
- SCHEDMODE
- SERVERNAME
- TCPCLIENTADDRESS
- TCPCLIENTPORT

**Windows** When you define a scheduler service by using the DSMCUTIL command or the backup-archive client GUI wizard, you specify an options file. You cannot override the options in that options file by issuing the scheduled command. You must modify the options in your scheduler service.

If the option string contains multiple options or options with embedded spaces, surround the entire option string with one pair of apostrophes. Enclose individual options that contain spaces in quotation marks. A leading minus sign is required in front of the option. Errors can occur if the option string contains spaces that are not quoted correctly.

The following examples show how to specify some client options:

- To specify `subdir=yes` and domain `all-local -systemobject`, enter:
  - `options='-subdir=yes -domain="all-local -c: -systemobject"'`
- To specify domain `all-local -c: -d:`, enter:
  - `options='-domain="all-local -c: -d:"'`

**Windows** Tip:

For Windows clients running in batch mode, if the use of quotation marks is necessary, use interactive mode or operating system escape characters. For additional information, see the following topics:

- Processing a series of commands from the administrative client
- Processing individual commands from the administrative client

## OBJects

Specifies the objects for which the specified action is performed. Use a single space between each object. This parameter is required except when ACTION=INCREMENTAL. If the action is a backup, archive, retrieve, or restore operation, the



objects are file spaces, directories, or logical volumes. If the action is to run a command or macro, the object is the name of the command or macro to run.

When you specify ACTION=INCREMENTAL without specifying a value for this parameter, the scheduled command is invoked without specified objects and attempts to process the objects as defined in the client option file. To select all file spaces or directories for an action, explicitly list them in the object string. Entering only an asterisk in the object string causes the backup to occur only for the directory where the scheduler was started.

**Important:**

- If you specify a second file specification, and it is not a valid destination, you receive this error:

```
ANS1082E Invalid destination file specification <filespec> entered.
```

- If you specify more than two file specifications, you receive this error:

```
ANS1102E Excessive number of command line arguments passed to the program!
```

When you specify ACTION=ARCHIVE, INCREMENTAL, or SELECTIVE for this parameter, you can list a maximum of twenty (20) file specifications.

Enclose the object string in double quotes if it contains blank characters (spaces), and then surround the double quotes with single quotes. If the object string contains multiple file names, enclose each file name with its own pair of double quotes, then surround the entire string with one pair of single quotes. Errors can occur if file names contain a space that is not quoted correctly.

**Windows** If you are using characters that have a special meaning for Windows users, such as commas, surround the entire argument in two pairs of double quotes, then surround the entire string with single quotes. The following examples show you how to specify some file names:

- To specify C:\FILE 2, D:\GIF FILES, and E:\MY TEST FILE, enter:
  - OBJECTS="\"C:\FILE 2" \"D:\GIF FILES" \"E:\MY TEST FILE"\""
- To specify D:\TEST FILE, enter:
  - OBJECTS="\"D:\TEST FILE"\""
- To specify D:TEST,FILE:
  - OBJECTS="\"\"D:\TEST,FILE"\"\""

**AIX** | **Linux** The following examples show how to specify some file names:

- To specify /home/file 2, /home/gif files, and /home/my test file, enter:
  - OBJECTS="\"/home/file 2" \"/home/gif files" \"/home/my test file"\""
- To specify /home/test file, enter:
  - OBJECTS="\"/home/test file"\""

**Windows** Tip:

For Windows clients running in batch mode, if the use of double quotes is necessary, use interactive mode or operating system escape characters. For additional information, see the following topics:

- Processing a series of commands from the administrative client
- Processing individual commands from the administrative client

## Wait

Specifies whether to wait for a scheduled client operation to complete. This parameter is useful when defining client actions from a command script or macro. This parameter is optional. The default is No. Possible values are:

### No

Specifies that you do not wait for the scheduled client operation to complete. If you specify this value and the value of the ACTION parameter is COMMAND, the return code indicates whether the client action was defined.

### Yes

Specifies that you wait for the scheduled client operation to complete. If you specify this value and the value of the ACTION parameter is COMMAND, the return code indicates the status of the client operation.

You cannot issue the DEFINE CLIENTACTION command with WAIT=YES from the server console. However, from the server console, you can:

- Specify WAIT=YES with DEFINE CLIENTACTION as the command line of a DEFINE SCRIPT command.
- Specify WAIT=YES with DEFINE CLIENTACTION as the command line of a file whose contents will be read into the script that is defined by a DEFINE SCRIPT command.

Restriction: If you specify the DEFINE CLIENTACTION command with WAIT=YES in a macro, the immediate schedules defined by the command will not roll back if the macro does not complete successfully.

## Example: Perform a one-time incremental backup

Issue an incremental backup command for client node TOM assigned to policy domain EMPLOYEE\_RECORDS. IBM Spectrum Protect defines a schedule and associates the schedule to client node TOM (assuming that the client scheduler is running).

```
define clientaction tom domain=employee_records
action=incremental
```

## Related commands

Table 1. Commands related to DEFINE CLIENTACTION

Command	Description
DELETE SCHEDULE	Deletes a schedule from the database.
QUERY ASSOCIATION	Displays the clients associated with one or more schedules.
QUERY EVENT	Displays information about scheduled and completed events for selected clients.
QUERY SCHEDULE	Displays information about schedules.
SET CLIENTACTDURATION	Specifies the duration of a schedule defined using the DEFINE CLIENTACTION command.

## DEFINE CLIENTOPT (Define an option to an option set)

Use this command to add a client option to an option set.

## Privilege class

To issue this command, you must have system privilege or unrestricted policy privilege.

## Syntax

```
>>-DEFine CLIENTOpt--option_set_name--option_name--option_value-->
  .-Force-----No-----
>--+-----+-----+-----+-----+-----+-----+----->>
  '-Force-----+No--+-'  '-SEQnumber-----number-'
  '-Yes-'
```

## Parameters

option\_set\_name (Required)  
Specifies the name of the option set.

option\_name (Required)  
Specifies a client option to add to the option set.

See Client options that can be set by the server for a list of valid options.

Note: To define include-exclude values, specify the include or exclude option with *option-name*, and use *option\_value* to specify any valid include or exclude statement, as you would in the client options file. For example:

```
define clientopt option_set_name inclexcl "include c:\proj\text\devel.*"
```

**option\_value (Required)**

Specifies the value for the option. If the option includes more than one value, enclose the value in quotation marks.

**Note:**

1. The QUIET and VERBOSE options do not have an option value in the client option's file. To specify these values in a server client option set, specify a value of YES or NO.
2. To add an INCLUDE or EXCLUDE option for a file name that contains one or more spaces, put single quotation marks around the file specification, and double quotation marks around the entire option. See Example: Add an option to a client option set for more information.
3. The *option\_value* is limited to 1024 characters.

**Force**

Specifies whether the server forces the client to use the option set value. The value is ignored for additive options, such as INCLEXCL and DOMAIN. The default is NO. This parameter is optional. The values are:

**Yes**

Specifies that the server forces the client to use the value. (The client cannot override the value.)

**No**

Specifies that the server does not force the client to use the value. (The client can override the value.)

**SEQnumber**

Specifies a sequence number when an option name is specified more than once. This parameter is optional.

## Example: Add an option to a client option set

---

Add a client option (MAXCMDRETRIES 5) to a client option set named ENG.

```
define clientopt eng maxcmdretries 5
```

## Example: Add an option to exclude a file from backup

---

Add a client option to the option set ENGBACKUP to exclude the c:\admin\file.txt from backup services.

```
define clientopt engbackup inclexcl "exclude c:\admin\file.txt"
```

## Example: Add an option to exclude a directory from backup

---

Add a client option to the option set WINSPEC to exclude a temporary internet directory from backup services. When you use the EXCLUDE or INCLUDE option with file names that contain spaces, put single quotation marks around the file specification, then double quotation marks around the entire option.

```
define clientopt winspec inclexcl "exclude.dir '*:\...\Temporary Internet Files'"
```

## Example: Add an option to bind files in specified directories

---

Add client options to the option set WINSPEC to bind all files in directories C:\Data and C:\Program Files\My Apps to a management class named PRODCLASS.

```
define clientopt winspec inclexcl "include C:\Data\...\* prodclass"  
define clientopt winspec inclexcl "include 'C:\Program  
Files\My Apps\...\*' prodclass"
```

## Related commands

---

Table 1. Commands related to DEFINE CLIENTOPT

Command	Description
COPY CLOPTSET	Copies a client option set.
DEFINE CLOPTSET	Defines a client option set.
DELETE CLIENTOPT	Deletes a client option from a client option set.
DELETE CLOPTSET	Deletes a client option set.

Command	Description
REGISTER NODE	Defines a client node to the server and sets options for that user.
QUERY CLOPTSET	Displays information about a client option set.
UPDATE CLIENTOPT	Updates the sequence number of a client option in a client option set.
UPDATE CLOPTSET	Updates the description of a client option set.
UPDATE NODE	Changes the attributes that are associated with a client node.

## DEFINE CLOPTSET (Define a client option set name)

Use this command to define a name for a set of options you can assign to clients for archive, backup, restore, and retrieve operations.

To add options to the new set, issue the DEFINE CLIENTOPT command.

### Privilege class

To issue this command, you must have system privilege or unrestricted policy privilege.

### Syntax

```
>>-DEFine CLOptset--option_set_name----->
>--+-----+-----><
  '-DESCription----description-'
```

### Parameters

option\_set\_name (Required)

Specifies the name of the client option set. The maximum length of the name is 64 characters.

DESCription

Specifies a description of the client option set. The maximum length of the description is 255 characters. The description must be enclosed in quotation marks if it contains any blank characters. This parameter is optional.

### Example: Define a client option set

To define a client option set named ENG issue the following command.

```
define cloptset eng
```

### Related commands

Table 1. Commands related to DEFINE CLOPTSET

Command	Description
COPY CLOPTSET	Copies a client option set.
DEFINE CLIENTOPT	Adds a client option to a client option set.
DELETE CLIENTOPT	Deletes a client option from a client option set.
DELETE CLOPTSET	Deletes a client option set.
QUERY CLOPTSET	Displays information about a client option set.
UPDATE CLIENTOPT	Updates the sequence number of a client option in a client option set.
UPDATE CLOPTSET	Updates the description of a client option set.

## DEFINE COLLOGROUP (Define a collocation group)

Use this command to define a collocation group. A *collocation group* is a group of nodes or file spaces on a node whose data is collocated on a minimal number of sequential access volumes. Their data is collocated only if the storage pool definition is set to collocate by group (COLLOCATE=GROUP).

### Privilege class

To issue this command, you must have system or unrestricted storage privilege.

### Syntax

```
>>-DEFine COLLOGGroup--group_name----->
>--+-----+-----><
  '-DESCRiption----description-'
```

### Parameters

group\_name

Specifies the name of the collocation group name that you want to create. The maximum length of the name is 30 characters.

DESCRiption

Specifies a description of the collocation group. This parameter is optional. The maximum length of the description is 255 characters. Enclose the description in quotation marks if it contains any blank characters.

### Define a collocation group

To define a node or file space collocation group named GROUP1, issue the following command:

```
define collogroup group1
```

### Related commands

Table 1. Commands related to DEFINE COLLOGROUP

Command	Description
DEFINE COLLOCMEMBER	Adds a client node or file space to a collocation group.
DEFINE STGPOOL	Defines a storage pool as a named collection of server storage media.
DELETE COLLOGROUP	Deletes a collocation group.
DELETE COLLOCMEMBER	Deletes a client node or file space from a collocation group.
MOVE NODEDATA	Moves data for one or more nodes, or a single node with selected file spaces.
QUERY COLLOGROUP	Displays information about collocation groups.
QUERY NODE	Displays partial or complete information about one or more clients.
QUERY NODEDATA	Displays information about the location and size of data for a client node.
QUERY STGPOOL	Displays information about storage pools.
REMOVE NODE	Removes a client from the list of registered nodes for a specific policy domain.
UPDATE COLLOGROUP	Updates the description of a collocation group.
UPDATE STGPOOL	Changes the attributes of a storage pool.

## DEFINE COLLOCMEMBER (Define collocation group member)

---

Issue this command to add a client node to a collocation group or to add a file space from a node to a collocation group. A collocation group is a group of nodes or file spaces on a node whose data is collocated on a minimal number of sequential access volumes.

### Privilege class

---

To issue this command, you must have system or unrestricted storage privilege.

### Syntax

---

Add a node to a collocation group

```
                .-,-----  
                v          |  
>>-DEFine COLLOCMember--group_name----node_name-+-----><
```

### Parameters

---

#### group\_name

Specifies the name of the collocation group to which you want to add a client node.

#### node\_name

Specifies the name of the client node that you want to add to the collocation group. You can specify one or more names. Separate multiple names with commas; do not use intervening spaces. You can also use wildcard characters to specify multiple names.

Add a file space from a node to a collocation group

```
>>-DEFine COLLOCMember--group_name--node_name----->  
  
                .-,-----  
                v          |  
>>-Filespace-------file_space_name-+----->  
  
    .-NAMEType-----SERVER-----  
>--+-----+----->  
    '-NAMEType-----+SERVER--+-'  
        +-UNICODE-+  
        '-FSID----'  
  
    .-CODEType-----BOTH-----  
>--+-----+-----><  
    '-CODEType-----+BOTH-----+'  
        +-UNICODE-----+  
        '-NONUNICODE-'
```

### Parameters

---

#### group\_name

Specifies the name of the collocation group to which you want to add a file space.

#### node\_name

Specifies the client node where the file space is located.

#### Filespace

Specifies the *file\_space\_name* on the client node that you want to add to the collocation group. You can specify one or more file space names that are on a specific client node. If you specify multiple file space names, separate the names with commas with no intervening spaces. You can also use wildcard characters to specify multiple file space names. For example:

```
define collocmember manufacturing linux237 filespace=*_linux_fs
```

This command places all file spaces on the linux237 node with a name that ends with `_linux_fs` into the manufacturing collocation group.

See the following list for tips about working with collocation groups:

- When you add members to a new collocation group, the type of the first collocation group member determines the type of the collocation group. The group can either be a node collocation group or a file space collocation group. Restriction: After the collocation group type is set, it cannot be changed.
- You cannot mix collocation group member types when you add members to a collocation group (either a node group or a file space group).
- For a file space collocation group, you can add file spaces to the group. The file spaces must use the same value as the `node_name` parameter that is specified when the collocation group is established.
- A client node can be included in multiple file space groups. However, if a node is a member of a node collocation group, it cannot be a member of a file space collocation group.
- A file space can be a member of only one file space group.

#### NAMETYPE

Specify how you want the server to interpret the file space names that you enter. Specify this parameter when the server communicates with clients that have Unicode support. A backup-archive client with Unicode support is available only for Windows, Macintosh OS 9, Macintosh OS X, and NetWare systems. The filespace name cannot be a wildcard character when NAMETYPE is specified for a filespace collocation group. The default value is SERVER. You can specify one of the following values:

##### SERVER

The server uses the server code page to interpret the file space names.

##### UNICODE

The server converts the file space names from the server code page to the UTF-8 code page. Whether the name can be converted depends on the characters in the names and the server code page. Conversion might fail if the string includes characters that are not available in the server code page, or if the server cannot access system conversion routines.

##### FSID

The server interprets the file space names by their file space IDs (FSIDs).

#### CODETYPE

Specify how you want the server to interpret the file space names that you enter. Use this parameter when you use a wildcard character for the file space name. For example:

```
define collocmember production Win_3419 filespace=* codetype=unicode
```

This example command adds all file spaces from the Win\_3419 node to the production collocation group. The default is BOTH, so the file spaces are included, regardless of code page type. You can specify one of the following values:

##### BOTH

Include the file spaces, regardless of code page type.

##### UNICODE

Include file spaces that are only in Unicode.

##### NONUNICODE

Include file spaces that are not in Unicode.

## Define two collocation group members

---

Define two members, NODE1 and NODE2, to a collocation group, GROUP1.

```
define collocmember group1 node1,node2
```

## Define one file space group member CNTR90524, on node clifton to collocation group TSM\_alpha\_1

---

```
define collocmember TSM_alpha_1 clifton filespace=CNTR90524
```

## Related commands

---

Table 1. Commands related to DEFINE COLLOCMEMBER

Command	Description
DEFINE COLLOGROUP	Defines a collocation group.
DEFINE STGPOOL	Defines a storage pool as a named collection of server storage media.
DELETE COLLOGROUP	Deletes a collocation group.
DELETE COLLOCMEMBER	Deletes a client node or file space from a collocation group.
DELETE FILESPACE	Deletes data associated with client file spaces. If a file space is part of a collocation group and you remove the file space from a node, the file space is removed from the collocation group.
MOVE NODEDATA	Moves data for one or more nodes, or a single node with selected file spaces.
QUERY COLLOGROUP	Displays information about collocation groups.
QUERY NODE	Displays partial or complete information about one or more clients.
QUERY NODEDATA	Displays information about the location and size of data for a client node.
QUERY STGPOOL	Displays information about storage pools.
REMOVE NODE	Removes a client from the list of registered nodes for a specific policy domain.
UPDATE COLLOGROUP	Updates the description of a collocation group.
UPDATE STGPOOL	Changes the attributes of a storage pool.

## DEFINE COPYGROUP (Define a copy group)

Use this command to define a new backup or archive copy group within a specific management class, policy set, and policy domain. The server uses the backup and archive copy groups to control how clients back up and archive files, and to manage the backed-up and archived files.

To enable clients to use the new copy group, you must activate the policy set that contains the new copy group.

You can define one backup and one archive copy group for each management class. To ensure that client nodes can back up files, include a backup copy group in the default management class for a policy set.

Attention: The DEFINE COPYGROUP command fails if you specify a copy storage pool as a destination.

The DEFINE COPYGROUP command has two forms, one for defining a backup copy group and one for defining an archive copy group. The syntax and parameters for each form are defined separately.

Table 1. Commands related to DEFINE COPYGROUP

Command	Description
ASSIGN DEFMGMTCLASS	Assigns a management class as the default for a specified policy set.
BACKUP NODE	Backs up a network-attached storage (NAS) node.
COPY MGMTCLASS	Creates a copy of a management class.
DEFINE MGMTCLASS	Defines a management class.
DEFINE STGPOOL	Defines a storage pool as a named collection of server storage media.
DELETE COPYGROUP	Deletes a backup or archive copy group from a policy domain and policy set.



Command	Description
DELETE MGMTCLASS	Deletes a management class and its copy groups from a policy domain and policy set.
EXPIRE INVENTORY	Manually starts inventory expiration processing.
QUERY COPYGROUP	Displays the attributes of a copy group.
QUERY MGMTCLASS	Displays information about management classes.
SET ARCHIVERETENTIONPROTECTION	Specifies whether data retention protection is activated.
UPDATE COPYGROUP	Changes one or more attributes of a copy group.

- DEFINE COPYGROUP (Define a backup copy group)  
Use this command to define a new backup copy group within a specific management class, policy set, and policy domain.
- DEFINE COPYGROUP (Define an archive copy group)  
Use this command to define a new archive copy group within a specific management class, policy set, and policy domain.

## DEFINE COPYGROUP (Define a backup copy group)

Use this command to define a new backup copy group within a specific management class, policy set, and policy domain.

### Privilege class

To issue this command, you must have system privilege, unrestricted policy privilege, or restricted policy privilege for the policy domain to which the copy group belongs.

### Syntax

```
>>-DEFine COpYgroup--domain_name--policy_set_name--class_name--->
    .-STANDARD-. .-Type----Backup-.
>--+-----+-----+-----+-----+-----+-----+-----+----->
    '-STANDARD-' '-Type----Backup-'
                                     .-FREQuency----0----.
>--DESTination----pool_name--+-----+-----+-----+----->
                                     '-FREQuency----days-'
    .-VERExists----2------.
>--+-----+-----+-----+-----+-----+-----+-----+----->
    '-VERExists----+number--+'
                                     '-NOLimit-'
    .-VERDeleted----1------.
>--+-----+-----+-----+-----+-----+-----+-----+----->
    '-VERDeleted----+number--+'
                                     '-NOLimit-'
    .-RETEExtra----30------. .-RETOOnly----60------.
>--+-----+-----+-----+-----+-----+-----+-----+----->
    '-RETEExtra----+days----+' '-RETOOnly----+days----+'
                                     '-NOLimit-' '-NOLimit-'
    .-MODE----MODified-----.
>--+-----+-----+-----+-----+-----+-----+-----+----->
    '-MODE----+MODified--+'
                                     '-ABSolute-'
    .-SERialization----SHRStatic------.
>--+-----+-----+-----+-----+-----+-----+-----+----->
    '-SERialization----+SHRStatic--+'
                                     +-Static-----+
                                     +-SHRDYnamic+
                                     '-DYnamic----'
>--+-----+-----+-----+-----+-----+-----+-----+-----><
```

'-TOCDestination--=----pool\_name--'

## Parameters

---

domain\_name (Required)

Specifies the policy domain for which you are defining the copy group.

policy\_set\_name (Required)

Specifies the policy set for which you are defining the copy group.

You cannot define a copy group for a management class that belongs to the ACTIVE policy set.

class\_name (Required)

Specifies the management class for which you are defining the copy group.

STANDARD

Specifies the name of the copy group, which must be STANDARD. This parameter is optional. The default value is STANDARD.

Type=Backup

Specifies that you want to define a backup copy group. The default parameter is BACKUP. This parameter is optional.

DESTINATION (Required)

Specifies the primary storage pool where the server initially stores backup data. You cannot specify a copy storage pool as the destination.

FREQUENCY

Specifies how frequently IBM Spectrum Protect™ can back up a file. This parameter is optional. IBM Spectrum Protect backs up a file only when the specified number of days has elapsed since the last backup. The FREQUENCY value is used only during a full incremental backup operation. This value is ignored during selective backup or partial incremental backup. You can specify an integer from 0 to 9999. The default value is 0, meaning that IBM Spectrum Protect can back up a file regardless of when the file was last backed up.

VERExists

Specifies the maximum number of backup versions to retain for files that are currently on the client file system. This parameter is optional. The default value is 2.

If an incremental backup operation causes the limit to be exceeded, the server expires the oldest backup version that exists in server storage. Possible values are:

number

Specifies the number of backup versions to retain for files that are currently on the client file system. You can specify an integer from 1 to 9999.

NOLimit

Specifies that you want the server to retain all backup versions.

The number of backup versions to retain is controlled by this parameter until versions exceed the retention time specified by the RETEXTRA parameter.

VERDeleted

Specifies the maximum number of backup versions to retain for files that have been deleted from the client file system after being backed up using IBM Spectrum Protect. This parameter is optional. The default value is 1.

If a user deletes a file from the client file system, the next incremental backup causes the server to expire the oldest versions of the file in excess of this number. The expiration date for the remaining versions is determined by the retention time specified by the RETEXTRA or RETONLY parameter. Possible values are:

number

Specifies the number of backup versions to retain for files that are deleted from the client file system after being backed up. You can specify an integer from 0 to 9999.

NOLimit

Specifies that you want the server to retain all backup versions for files that are deleted from the client file system after being backed up.

RETEExtra

Specifies the number of days to retain a backup version after that version becomes inactive. A version of a file becomes inactive when the client stores a more recent backup version, or when the client deletes the file from the workstation and then runs a full incremental backup. The server deletes inactive versions based on retention time even if the number of inactive versions does not exceed the number allowed by the VEREXISTS or VERDELETED parameters. This parameter is optional. The default value is 30 days. Possible values are:

days

Specifies the number of days to retain inactive backup versions. You can specify an integer from 0 to 9999.

NOLimit

Specifies that you want to retain inactive backup versions indefinitely.

If you specify NOLIMIT, the server deletes inactive backup versions based on the VEREXISTS parameter (when the file still exists on the client file system) VERDELETED parameter (when the file no longer exists on the client file system).

REOnly

Specifies the number of days to retain the last backup version of a file that has been deleted from the client file system. This parameter is optional. The default value is 60. Possible values are:

days

Specifies the number of days to retain the last remaining inactive version of a file. You can specify an integer from 0 to 9999.

NOLimit

Specifies that you want to keep the last remaining inactive version of a file indefinitely.

If you specify NOLIMIT, the server retains the last remaining backup version forever, unless a user or administrator deletes the file from server storage.

MODE

Specifies whether IBM Spectrum Protect backs up a file only if the file has changed since the last backup, or whenever a client requests a backup. This parameter is optional. The default value is MODIFIED. Possible values are:

MODified

Specifies that IBM Spectrum Protect backs up the file only if it has changed since the last backup. IBM Spectrum Protect considers a file changed if any of the following is true:

- The date last modified is different
- The file size is different
- The file owner is different
- The file permissions are different

ABSolute

Specifies that IBM Spectrum Protect backs up the file regardless of whether it has been modified.

The MODE value is used only for full incremental backup. This value is ignored during partial incremental backup or selective backup.

SERialization

Specifies how IBM Spectrum Protect processes files or directories when they are modified during backup processing. This parameter is optional. The default value is SHRSTATIC. Possible values are:

SHRStatic

Specifies that IBM Spectrum Protect backs up a file or directory only if it is not being modified during backup. IBM Spectrum Protect attempts to perform a backup as many as four times, depending on the value specified for the CHANGINGRETRIES client option. If the file or directory is modified during each backup attempt, IBM Spectrum Protect does not back it up.

Static

Specifies that IBM Spectrum Protect backs up a file or directory only if it is not being modified during backup. IBM Spectrum Protect attempts to perform the backup only once.

Platforms that do not support the STATIC option default to SHRSTATIC.

SHRDYnamic

Specifies that if the file or directory is being modified during a backup attempt, IBM Spectrum Protect backs up the file or directory during the last attempt even though the file or directory is being modified. IBM Spectrum Protect attempts to perform a backup as many as four times, depending on the value specified for the CHANGINGRETRIES client option.

DYnamic

Specifies that IBM Spectrum Protect backs up a file or directory on the first attempt, regardless of whether the file or directory is being modified during backup processing.

Attention: Be careful about using the SHRDYNAMIC and DYNAMIC values. IBM Spectrum Protect uses these values to determine if it backs up a file or directory while modifications are occurring. As a result, the backup version might be a fuzzy backup. A fuzzy backup does not accurately reflect what is currently in the file or directory because it contains some, but not all, modifications. If a file that contains a fuzzy backup is restored, the file may or may not be usable, depending on the application that uses the file. If a fuzzy backup is not acceptable, set SERIALIZATION to SHRSTATIC or STATIC so that IBM Spectrum Protect creates a backup version only if the file or directory is not being modified.

#### TOCDestination

Specifies the primary storage pool in which a table of contents (TOC) will initially be stored for any Network Data Management Protocol (NDMP) backup or backup set operation for which a TOC is generated. This parameter is optional. You cannot specify a copy storage pool as the destination. The storage pool specified for the destination must have NATIVE or NONBLOCK data format. To avoid mount delays, it is recommended that the storage pool have a device class of DISK or DEVTYPE=FILE. TOC generation is an option for NDMP backup operations, but is not supported for other image-backup operations.

If TOC creation is requested for a backup operation that uses NDMP and the image is bound to a management class whose backup copy group does not specify a TOC destination, the outcome will depend on the TOC parameter for the backup operation.

- If TOC=PREFERRED (the default), the backup proceeds without creation of a TOC.
- If TOC=YES, the entire backup fails because no TOC can be created.

### Example: Create a backup copy group

Create a backup copy group named STANDARD for management class ACTIVEFILES in policy set VACATION in the EMPLOYEE\_RECORDS policy domain. Set the backup destination to BACKUPPOOL. Set the minimum interval between backups to three days, regardless of whether the files have been modified. Retain up to five backup versions of a file while the file exists on the client file system.

```
define copygroup employee_records
vacation activefiles standard type=backup
destination=backuppools frequency=3
verexists=5 mode=absolute
```

## DEFINE COPYGROUP (Define an archive copy group)

Use this command to define a new archive copy group within a specific management class, policy set, and policy domain.

### Privilege class

To issue this command, you must have system privilege, unrestricted policy privilege, or restricted policy privilege for the policy domain to which the copy group belongs.

### Syntax

```
>>-DEFine COpYgroup--domain_name--policy_set_name--class_name--->
. -STANDARD- .
>>-+-----+---Type-----Archive--DESTination-----pool_name----->
' -STANDARD- '

. -FREquency-----Cmd- . . -RETVer-----365----- .
>>-+-----+-----+-----+-----+-----+----->
' -FREquency-----Cmd- ' ' -RETVer-----+days-----+ '
' -NOLimit- '

. -RETInit-----CREATION-- . . -RETMin-----365----- .
>>-+-----+-----+-----+-----+-----+----->
' -RETInit-----EVENT--- ' ' -RETMin-----days--- '

. -MODE-----ABSolute- .
>>-+-----+-----+-----+-----+-----+----->
' -MODE-----ABSolute- '
```

```

.-SERialization---SHRStatic-----
>-----+-----+-----+-----+----->>
'-SERialization---+SHRStatic---+'
          +-Static-----+
          +-SHRDynamic--+
          '-Dynamic-----'

```

## Parameters

### domain\_name (Required)

Specifies the name of the policy domain for which you are defining the copy group.

### policy\_set\_name (Required)

Specifies the name of the policy set for which you are defining the copy group.

You cannot define a copy group for a management class that belongs to the ACTIVE policy set.

### class\_name (Required)

Specifies the name of the management class for which you are defining the copy group.

### STANDARD

Specifies the name of the copy group, which must be STANDARD. This parameter is optional. The default value is STANDARD.

### Type=Archive (Required)

Specifies that you want to define an archive copy group.

### DESTINATION (Required)

Specifies the primary storage pool where the server initially stores the archive copy. You cannot specify a copy storage pool as the destination.

### FREQUENCY=Cmd

Specifies the copy frequency, which must be CMD. This parameter is optional. The default value is CMD.

### RETVer

Specifies the number of days to keep an archive copy. This parameter is optional. The default value is 365. Possible values are:

#### days

Specifies the length of time to keep an archive copy. You can specify an integer in the range 0 - 30000.

The RETENTIONEXTENSION server option can affect the volume retention if the following conditions are true:

- You specify zero for the number of days
- The destination storage pool for the archive copy group is a SnapLock storage pool (RECLAMATIONTYPE=SNAPLOCK)

If the two conditions are met, retention of the volumes is defined by the value of the RETENTIONEXTENSION server option. The RETENTIONEXTENSION server option value also applies if data is copied or moved into the SnapLock storage pool by a server process such as migration, or by using the MOVE DATA or MOVE NODEDATA commands.

#### NOLimit

Specifies that you want to keep an archive copy indefinitely.

If you specify NOLIMIT, the server retains archive copies forever, unless a user or administrator deletes the file from server storage. If you specify NOLIMIT, you cannot also specify EVENT for the RETINIT parameter.

The value of the RETVER parameter can affect the management class to which the server binds an archived directory. If the client does not use the ARCHMC option, the server binds directories that are archived to the default management class. If the default management class has no archive copy group, the server binds directories that are archived to the management class with the shortest retention period.

The RETVER parameter of the archive copy group of the management class to which an object is bound determines the retention criterion for each object. See the SET ARCHIVERETENTIONPROTECTION command for a description of data protection.

If the primary storage pool specified in the DESTINATION parameter belongs to a Centera device class and data protection is enabled, then the RETVER value is sent to Centera for retention management purposes. See the SET ARCHIVERETENTIONPROTECTION command for a description of data protection.

### REInit

Specifies when the retention time specified by the RETVER attribute is initiated. This parameter is optional. If you define the RETINIT value during copy group creation, you cannot modify it later. The default value is CREATION. Possible values are:

#### CREATION

Specifies that the retention time specified by the RETVER attribute is initiated at the time an archive copy is stored on the IBM Spectrum Protect™ server.

#### Event

Specifies that the retention time specified in the RETVER parameter is initiated at the time a client application notifies the server of a retention-initiating event for the archive copy. If you specify RETINIT=EVENT, you cannot also specify RETVER=NOLIMIT.

Tip: You can place a deletion hold on an object that was stored with RETINIT=EVENT for which the event has not been signaled. If the event is signaled while the deletion hold is in effect, the retention period is initiated, but the object is not deleted while the hold is in effect.

#### REMin

Specifies the minimum number of days to keep an archive copy after it is archived. This parameter is optional. The default value is 365. If you specify RETINIT=CREATION, this parameter is ignored.

#### MODE=ABSolute

Specifies that a file is always archived when the client requests it. The MODE must be ABSOLUTE. This parameter is optional. The default value is ABSOLUTE.

#### SERialization

Specifies how IBM Spectrum Protect processes files that are modified during archive. This parameter is optional. The default value is SHRSTATIC. Possible values are:

#### SHRStatic

Specifies that IBM Spectrum Protect archives a file only if it is not being modified. IBM Spectrum Protect attempts to perform an archive operation as many as four times, depending on the value that is specified for the CHANGINGRETRIES client option. If the file is modified during the archive attempt, IBM Spectrum Protect does not archive the file.

#### Static

Specifies that IBM Spectrum Protect archives a file only if it is not being modified. IBM Spectrum Protect attempts to perform the archive operation only once.

Platforms that do not support the STATIC option default to SHRSTATIC.

#### SHRDynamic

Specifies that if the file is being modified during an archive attempt, IBM Spectrum Protect archives the file during its last attempt even though the file is being modified. IBM Spectrum Protect attempts to archive the file as many as four times, depending on the value that is specified for the CHANGINGRETRIES client option.

#### Dynamic

Specifies that IBM Spectrum Protect archives a file on the first attempt, regardless of whether the file is being modified during archive processing.

Attention: Be careful about using the SHRDYNAMIC and DYNAMIC values. IBM Spectrum Protect uses them to determine if it archives a file while modifications are occurring. As a result, the archive copy might be a fuzzy backup. A fuzzy backup does not accurately reflect what is in the file because it contains some, but not all, modifications. If a file that contains a fuzzy backup is retrieved, the file might or might not be usable, depending on the application that uses the file. If a fuzzy backup is not acceptable, set SERIALIZATION to SHRSTATIC or STATIC so that IBM Spectrum Protect creates an archive copy only if the file is not being modified.

## Example: Define an archive copy group for event-based retention

---

Create an archive copy group named STANDARD for management class EVENTMC in policy set SUMMER in the PROG1 policy domain. Set the archive destination to ARCHIVEPOOL, where the archive copy is kept until the server is notified of an event to initiate the retention time, after which the archive copy is kept for 30 days. The archive copy will be kept for a minimum of 90 days after being stored on the server, regardless of when the server is notified of an event to initiate the retention time.

```
define copygroup prog1 summer eventmc standard type=archive
destination=archivepool retinit=event retver=30 retmin=90
```

## DEFINE DATAMOVER (Define a data mover)

---

Use this command to define a data mover. A data mover is a named device that accepts a request from IBM Spectrum Protect™ to transfer data. A data mover can be used to complete outboard copy operations.

## Privilege class

---

To issue this command, you must have system privilege or unrestricted storage privilege.

## Syntax

---

```
>>-DEFine DATAMover--data_mover_name----->
. -Type-----NAS-----
>--+-----+-----HLAddress---address--->
|                                     (1) (2) |
' -Type-----+--NASCLUSTER--+-----'
      '-NASVSERVER-'

. -LLAddress-----10000-----
>--+-----+-----USERid---userid----->
' -LLAddress---tcp_port-'

. -ONLine-----Yes-----
>--PASsword---password--+-----+----->
      '-ONLine-----+--Yes+-'
                        '-No--'

>--DATAFormat---+--NETAPPDump--+-----><
                        +-CELERRADump--+
                        '-NDMPDump-----'
```

### Notes:

1. You can specify `TYPE=NASCLUSTER` and `TYPE=NASVSERVER` only on an AIX®, Linux, or Windows operating system.
2. You can specify `TYPE=NASCLUSTER` and `TYPE=NASVSERVER` only if `DATAFORMAT=NETAPPDUMP`.

## Parameters

---

### data\_mover\_name (Required)

Specifies the name of the data mover. This name must be the same as a node name that you previously registered by using the `REGISTER NODE TYPE=NAS` command. The data that is backed up from this NAS data mover will be assigned to this node name in the server database. A maximum of 64 characters can be used to specify the name.

### Type

Specifies the type of data mover. This parameter is optional. The default value is `NAS`.

#### NAS

Specifies that the data mover is a NAS file server.

#### NASCLUSTER

Specifies that the data mover is a clustered NAS file server.

Restriction: You can specify the `NASCLUSTER` value only if `DATAFORMAT=NETAPPDUMP`.

#### NASVSERVER

Specifies that the data mover is a virtual storage device within a cluster.

Restriction: You can specify the `NASVSERVER` value only if `DATAFORMAT=NETAPPDUMP`.

### HLAddress (Required)

Specifies either the numerical IP address or the domain name that is used to access the NAS file server.

Tip: To determine the numerical IP address, access the NAS file server. Then, follow the instructions in the file server documentation for obtaining the address.

### LLAddress

Specifies the TCP port number to access the NAS device for Network Data Management Protocol (NDMP) sessions. This parameter is optional. The default value is 10000.

### USERid (Required)

Specifies the user ID for a user that is authorized to initiate an NDMP session with the NAS file server. For example, enter the user ID that is configured on the NetApp file server for NDMP connections.

Tip: To determine the user ID, access the NAS file server. Then, follow the instructions in the file server documentation for obtaining the user ID.

**PASsword (Required)**

Specifies the password for the user ID to log on to the NAS file server.

Tip: To determine the password, access the NAS file server. Then, follow the instructions in the file server documentation for obtaining the password.

**ONLine**

Specifies whether the data mover is available for use. This parameter is optional. The default is YES.

**Yes**

The default value. Specifies that the data mover is available for use.

**No**

Specifies that the data mover is not available for use. When the hardware is being maintained, you can use the UPDATE DATAMOVER command to set the data mover offline.

If a library is controlled by using a path from a NAS data mover to the library, and the NAS data mover is offline, the server is not able to access the library. If the server is halted and restarted while the NAS data mover is offline, the library is not initialized.

**DATAFormat (Required)**

Specifies the data format that is used by this data mover.

**NETAPPDump**

Must be used for NetApp NAS file servers and the IBM® System Storage® N Series.

**CELERRADump**

Must be used for EMC Celerra NAS file servers.

**NDMPDump**

Must be used for NAS file servers other than NetApp or EMC file servers.

## Example: Define a data mover by domain name

---

Define a data mover for the node named NAS1. The domain name for the data mover is NETAPP2.EXAMPLE.COM at port 10000.

```
define datamover nas1 type=nas hladdress=netapp2.example.com lladdress=10000
userid=root password=admin dataformat=netappdump
```

## Example: Define a data mover by IP address

---

Define a data mover for the node named NAS2. The numerical IP address for the data mover is 203.0.113.0, at port 10000. The NAS file server is not a NetApp or EMC file server.

```
define datamover nas2 type=nas hladdress=203.0.113.0 lladdress=10000
userid=root password=admin dataformat=ndmpdump
```

## Example: Define a data mover for a clustered file server by IP address

---

Define a data mover for the clustered file server named NAS3. The NAS file server is a NetApp device. The numerical IP address for the data mover is 198.51.100.0, at port 10000.

```
define datamover nas3 type=nascluster hladdress=198.51.100.0
lladdress=10000 userid=root password=admin dataformat=netappdump
```

## Related commands

---

Table 1. Commands related to DEFINE DATAMOVER

Command	Description
DEFINE PATH	Defines a path from a source to a destination.
DELETE DATAMOVER	Deletes a data mover.
QUERY DATAMOVER	Displays data mover definitions.
REGISTER NODE	Defines a client node to the server and sets options for that user.



Command	Description
UPDATE DATAMOVER	Changes the definition for a data mover.

## DEFINE DEVCLASS (Define a device class)

Use this command to define a device class for a type of storage device. The server requires that a device class be defined to allow the use of a device.

For the most up-to-date list of supported devices and valid device class formats, see the IBM Spectrum Protect™ Supported Devices website: [AIX](#) | [Windows](#)

- Supported devices for AIX and Windows

### Linux

- Supported devices for Linux

Note: The DISK device class is defined by IBM Spectrum Protect and cannot be modified with the DEFINE DEVCLASS command.

[AIX](#) | [Linux](#) If you are defining a device class for devices that are to be accessed through a z/OS® media server, see DEFINE DEVCLASS - z/OS media server (Define device class for z/OS media server).

The following IBM Spectrum Protect device classes are ordered by device type.

- DEFINE DEVCLASS (Define a 3590 device class)
- DEFINE DEVCLASS (Define a 3592 device class)
- DEFINE DEVCLASS (Define a 4MM device class)
- DEFINE DEVCLASS (Define an 8MM device class)
- DEFINE DEVCLASS (Define a CENTERA device class)
- DEFINE DEVCLASS (Define a DLT device class)
- DEFINE DEVCLASS (Define an ECARTRIDGE device class)
- DEFINE DEVCLASS (Define a FILE device class)
- [AIX](#) | [Windows](#) DEFINE DEVCLASS (Define a GENERICTAPE device class)
- DEFINE DEVCLASS (Define an LTO device class)
- DEFINE DEVCLASS (Define a NAS device class)
- DEFINE DEVCLASS (Define a REMOVABLEFILE device class)
- DEFINE DEVCLASS (Define a SERVER device class)
- DEFINE DEVCLASS (Define a VOLSAFE device class)

Table 1. Commands related to DEFINE DEVCLASS

Command	Description
BACKUP DEVCONFIG	Backs up IBM Spectrum Protect device information to a file.
DEFINE LIBRARY	Defines an automated or manual library.
DELETE DEVCLASS	Deletes a device class.
QUERY DEVCLASS	Displays information about device classes.
QUERY DIRSPACE	Displays information about FILE directories.
UPDATE DEVCLASS	Changes the attributes of a device class.

## DEFINE DEVCLASS (Define a 3590 device class)

Use the 3590 device class when you are using 3590 tape devices.

[AIX](#) | [Linux](#) If you are defining a device class for devices that are to be accessed through a z/OS® media server, see DEFINE DEVCLASS (Define a 3590 device class for z/OS media server).

### Privilege class

To issue this command, you must have system privilege or unrestricted storage privilege.

## Syntax

```
>>-DEFine DEVclass--device_class_name----->
>--LIBRARY----library_name--DEVType----3590----->
.-FORMAT----DRIVE-----.
>--+-----+-----+-----+----->
'-FORMAT----+DRIVE----+' '-ESTCAPacity----size-'
      +-3590B----+
      +-3590C----+
      +-3590E-B--+
      +-3590E-C--+
      +-3590H-B--+
      '-3590H-C-'

.-PREFIX----ADSM-----.
>--+-----+-----+-----+----->
'-PREFIX----+ADSM-----+'
      '-tape_volume_prefix-'

.-MOUNTRetention----60-----.-MOUNTWait----60-----.
>--+-----+-----+-----+----->
'-MOUNTRetention----minutes-' '-MOUNTWait----minutes-'

.-MOUNTLimit----DRIVES-----.
>--+-----+-----+-----+-----><
'-MOUNTLimit----+DRIVES--+-'
      +-number-+
      '-0-----'
```

## Parameters

**device\_class\_name** (Required)

Specifies the name of the device class to be defined. The maximum length of the device class name is 30 characters.

**LIBRARY** (Required)

Specifies the name of the defined library object that contains the tape drives that can be used by this device class.

For information about defining a library object, see the DEFINE LIBRARY command.

**DEVType=3590** (Required)

Specifies the 3590 device type is assigned to the device class. 3590 indicates that IBM® 3590 cartridge tape devices are assigned to this device class.

**FORMAT**

Specifies the recording format to be used when data is written to sequential access media. This parameter is optional. The default value is DRIVE.

If the drives are in a library that includes drives of different tape technology, do not use the DRIVE value. Use the specific format that the drives use.

The following tables list the recording formats, estimated capacities, and recording format options for 3590 devices:

Table 1. Recording formats and default estimated capacities for 3590

Format	Estimated Capacity	Description
DRIVE	–	The server selects the highest format that is supported by the drive on which a volume is mounted. Attention: Avoid specifying DRIVE when a mixture of drives is used within the same library. For example, do not use this option for a library that contains some drives that support recording formats superior to other drives.
3590B	10.0 GB	Uncompressed (basic) format

Format	Estimated Capacity	Description
3590C	See note  20.0 GB	Compressed format
3590E-B	10.0 GB	Uncompressed (basic) format, similar to the 3590B format
3590E-C	See note  20.0 GB	Compressed format, similar to the 3590C format
3590H-B	30.0 GB (J cartridge – standard— length)  60.0 GB (K cartridge - extended length)	Uncompressed (basic) format, similar to the 3590B format
3590H-C	See note  60.0 GB (J cartridge - standard length)  120.0 GB (K cartridge - extended length)	Compressed format, similar to the 3590C format
Note: If this format uses the tape drive hardware compression feature, depending on the effectiveness of compression, the actual capacity might be greater than the listed value.		

Table 2. 3590 device recording format selections

Device	Format					
	3590B	3590C	3590E-B	3590E-C	3590H-B	3590H-C
3590	Read/Write	Read/Write	–	–	–	–
Ultra SCSI	Read/Write	Read/Write	–	–	–	–
3590E	Read	Read	Read/Write	Read/Write	–	–
3590H	Read	Read	Read	Read	Read/Write	Read/Write

#### ESTCAPacity

Specifies the estimated capacity for the volumes that are assigned to this device class. This parameter is optional.

You can specify this parameter if the default estimated capacity for the device class is inaccurate due to compression of data.

You must specify this value as an integer followed by one of the following unit indicators: **K** (kilobytes), **M** (megabytes), **G** (gigabytes), or **T** (terabytes). The smallest value that is accepted is 1 MB (ESTCAPACITY=1M).

For example, specify that the estimated capacity is 9 GB with the parameter ESTCAPACITY=9G.

#### PREFIX

Specifies the high-level qualifier of the data set name that the server writes into the sequential access media labels. For each sequential access volume assigned to this device class, the server uses this prefix to create the data set name. This parameter is optional. The default value is ADSM. The maximum length of this prefix is 8 characters.

If you have a naming convention for media labels to support your current management system, use a volume prefix that conforms to your naming conventions.

Values that are specified for this parameter must meet the following conditions:

- The value is to be made up of qualifiers, which can be a maximum of eight characters including periods. For example, the following value is acceptable:

AB.CD2.E

- The qualifiers must be separated by a single period.
- The first letter of each qualifier must be alphabetic or national (@,#,\$), followed by alphabetic, national, hyphen, or numeric characters.

An example of a tape volume data set name using the default prefix is ADSM.BFS.

#### MOUNTRetention

Specifies the number of minutes that an idle sequential access volume is retained before it is dismounted. This parameter is optional. The default value is 60 minutes. You can specify a number 0 - 9999.

This parameter can improve response time for sequential access media mounts by leaving previously mounted volumes online.

However, for EXTERNAL library types, setting this parameter to a low value (for example, two minutes) enhances device sharing between applications.

Note: For environments in which devices are shared across storage applications, the MOUNTRETENTION setting must be carefully considered. This parameter determines how long an idle volume remains in a drive. Some media managers do not dismount an allocated drive to satisfy pending requests. You might need to tune this parameter to satisfy competing mount requests while maintaining optimal system performance. Typically, problems arise more frequently when the MOUNTRETENTION parameter is set to a value that is too small, for example, zero.

#### MOUNTWait

Specifies the maximum number of minutes the server waits for an operator to respond to a request to either mount a volume in a drive in a manual library or check in a volume to be mounted in an automated library. This parameter is optional. If the mount request is not satisfied within the specified amount of time, the mount request is canceled. The default value is 60 minutes. You can specify a number 0 - 9999.

Restriction: If the library that is associated with this device class is external (LIBTYPE=EXTERNAL), do not specify the MOUNTWAIT parameter.

#### MOUNTLimit

Specifies the maximum number of sequential access volumes that can be simultaneously mounted for the device class. This parameter is optional. The default is DRIVES. You can specify a number 0 - 4096.

If you plan to use the simultaneous-write function, ensure that sufficient drives are available for the write operation. If the number of drives needed for a simultaneous-write operation is greater than the value of the MOUNTLIMIT parameter for a device class, the transaction fails.

The following are possible values:

#### DRIVES

Specifies that every time a mount point is allocated, the number of drives that are defined and online in the library is used to calculate the true value.

Note: For EXTERNAL library types, do not specify DRIVES for the MOUNTLIMIT value. Specify the number of drives for the library as the MOUNTLIMIT value.

#### number

Specifies the maximum number of drives in this device class that are used concurrently by the server. This value must never exceed the number of drives that are defined and online in the library that services this device class.

#### 0 (zero)

Specifies that no new transactions can gain access to the storage pool. Any current transactions continue and complete, but new transactions are terminated.

## DEFINE DEVCLASS (Define a 3592 device class)

---

Use the 3592 device class when you are using 3592 tape devices.

**AIX** | **Linux** If you are defining a device class for devices that are to be accessed through a z/OS® media server, see DEFINE DEVCLASS (Define a 3592 device class for z/OS media server).

### Privilege class

---

To issue this command, you must have system privilege or unrestricted storage privilege.

### Syntax

---

```
>>-DEFine DEVclass--device_class_name----->  
>--LIBRary----library_name--DEVType----3592----->
```

```

(1)
.-LBProtect---No----- .-WORM---No-----
>-----+-----+----->
'LBProtect---+READWrite+-' '-WORM---+Yes+-'
      +-WRITEOnly+      '-No--'
      '-No-----'

.-SCALECapacity---100---- .-FORMAT---DRIVE-----
>-----+-----+----->
'SCALECapacity---+100+-' '-FORMAT---+DRIVE---+-'
      +-90--+      +-3592----+
      '-20--'      +-3592C---+
                  +-3592-2--+
                  +-3592-2C--+
                  +-3592-3--+
                  +-3592-3C--+
                  +-3592-4--+
                  '-3592-4C-'

>-----+-----+----->
'-ESTCapacity---size-'

.-PREFIX---ADSM-----
>-----+-----+----->
'PREFIX---+ADSM-----+'
      '-tape_volume_prefix-'

.-MOUNTRetention---60----- .-MOUNTWait---60-----
>-----+-----+----->
'MOUNTRetention---minutes-' '-MOUNTWait---minutes-'

.-MOUNTLimit---DRIVES-----
>-----+-----+----->
'MOUNTLimit---+DRIVES+-'
      +-number+
      '-0-----'

(1) (2)
.-DRIVEEncryption---ALLOW-----
>-----+-----+----->>
'DRIVEEncryption---+ON-----+'
      +-ALLOW----+
      +-EXTERNAL+
      '-OFF-----'

```

Notes:

1. You cannot specify both WORM=Yes and DRIVEENCRYPTION=ON.
2. Drive encryption is supported only for 3592 Generation 2 or later drives.

## Parameters

device\_class\_name (Required)

Specifies the name of the device class to be defined. The maximum length of the device class name is 30 characters.

LIBRARY (Required)

Specifies the name of the defined library object that contains the tape drives that can be used by this device class.

For information about defining a library object, see the DEFINE LIBRARY command.

DEVType=3592 (Required)

Specifies that the 3592 device type is assigned to the device class.

LBProtect

Specifies whether logical block protection is used to ensure the integrity of data stored on tape. When LBPROTECT is set to READWRITE or to WRITEONLY, the server uses this feature of the tape drive for logical block protection and generates cyclic redundancy check (CRC) protection information for each data block written on tape. The server also validates the CRC protection information when data is read from the tape.

The default is NO.

The following values are possible:

#### READWrite

Specifies that logical block protection is enabled in the server and the tape drive for both read and write operations. Data is stored with CRC information in each block. This mode affects performance because additional processor usage is required for IBM Spectrum Protect™ and the tape drive to calculate and compare CRC values. The READWRITE value does not affect backup sets and data that is generated by the BACKUP DB command.

When the LBPROTECT parameter is set to READWRITE, you do not have to specify the CRCDATA parameter in a storage pool definition because logical block protection provides better protection against data corruption.

#### WRITEOnly

Specifies that logical block protection is enabled in the server and the tape drive for write operations only. Data is stored containing CRC information in each block. For read operations, the server and the tape drive do not validate the CRC. This mode affects performance because additional processor usage is required for IBM Spectrum Protect to generate the CRC and for the tape drive to calculate and compare CRC values for write operations. The WRITEONLY value does not affect backup sets and data that are generated by the BACKUP DB command.

#### No

Specifies that logical block protection is not enabled in the server and the tape drive for read and write operations. However, the server enables logical block protection on write operations for a filling volume that already has data with logical block protection.

Restriction: Logical block protection is supported only on IBM® 3592 Generation 3 drives and later with 3592 Generation 2 media and later.

See Technote 1634851, Additional information on the IBM Spectrum Protect LBProtect option, for an explanation about when to use the LBProtect parameter.

#### WORM

Specifies whether the drives use WORM (write once, read many) media. This parameter is optional. The default is No. The field can contain one of the following values:

#### Yes

Specifies that the drives use WORM media.

#### No

Specifies that the drives do not use WORM media.

#### Remember:

1. To use 3592 WORM support in 3584 libraries, you must specify the WORM parameter. The server distinguishes between WORM and non-WORM scratch volumes. However, to use 3592 WORM support in 349X libraries, you also must set the WORMSCRATCHCATEGORY on the DEFINE LIBRARY command. For details, see DEFINE LIBRARY (Define a library).
2. When WORM=Yes, the only valid value for the SCALECAPACITY parameter is 100.
3. Verify with your hardware vendors that your hardware is at the appropriate level of support.

#### SCALECAPacity

Specifies the percentage of the media capacity that can be used to store data. This parameter is optional. The default is 100. Possible values are 20, 90, or 100.

Setting the scale capacity percentage to 100 provides maximum storage capacity. Setting it to 20 provides fastest access time.

Note: The scale capacity value takes effect only when data is first written to a volume. Any updates to the device class for scale capacity do not affect volumes that already have data that is written to them until the volume is returned to scratch status.

#### FORMAT

Specifies the recording format to be used when data is written to sequential access media. This parameter is optional. The default value is DRIVE.

If the drives are in a library that includes drives of different tape technology, do not use the DRIVE value. Use the specific format that the drives use.

The following table lists the recording formats, estimated capacities, and recording format options for 3592 devices:

Table 1. Recording formats and default estimated capacities for 3592

Format	Estimated Capacity	Description
DRIVE	–	The server selects the highest format that is supported by the drive on which a volume is mounted. Attention: Avoid specifying DRIVE when a mixture of drives is used within the same library. For example, do not use this option for a library that contains some drives that support recording formats superior to other drives.
3592	300 GB	Uncompressed (basic) format
3592C	See note 900 GB	Compressed format
3592-2	500 GB 700 GB	Uncompressed (basic) format JA tapes Uncompressed (basic) format JB tapes
3592-2C	1.5 TB 2.1 TB	Compressed format JA tapes Compressed format JB tapes
3592-3	640 GB 1 TB	Uncompressed (basic) format JA tapes Uncompressed (basic) format JB tapes
3592-3C	1.9 TB 3 TB	Compressed format JA tapes Compressed format JB tapes
3592-4	400 GB 1.5 TB 3.1 TB	Uncompressed (basic) format JK tapes Uncompressed (basic) format JB tapes Uncompressed (basic) format JC tape
3592-4C	1.2 TB 4.4 TB 9.4 TB	Compressed format JK tapes Compressed format JB tapes Compressed format JC tapes
Note: If this format uses the tape drive hardware compression feature, depending on the effectiveness of compression, the actual capacity might be different from the listed value.		

Important: For optimal performance, avoid mixing different generations of drives in a single SCSI library. If you must mix drive generations in a SCSI library, use one of the special configurations that are described in the topic about mixing generations of 3592 media.

Special configurations are also required for mixing different generations of 3592 drives in 349x and ACSLS libraries.

#### ESTCAPacity

Specifies the estimated capacity for the volumes that are assigned to this device class. This parameter is optional.

You can specify this parameter if the default estimated capacity for the device class is inaccurate due to compression of data.

You must specify this value as an integer followed by one of the following unit indicators: **K** (kilobytes), **M** (megabytes), **G** (gigabytes), or **T** (terabytes). The smallest value that is accepted is 1 MB (ESTCAPACITY=1M).

For example, specify that the estimated capacity is 9 GB with the parameter ESTCAPACITY=9G.

#### PREFIX

Specifies the high-level qualifier of the data set name that the server writes into the sequential access media labels. For each sequential access volume assigned to this device class, the server uses this prefix to create the data set name. This parameter is optional. The default value is ADMS. The maximum length of this prefix is 8 characters.

If you have a naming convention for media labels to support your current management system, use a volume prefix that conforms to your naming conventions.

Values that are specified for this parameter must meet the following conditions:

- The value is to be made up of qualifiers, which can be a maximum of eight characters including periods. For example, the following value is acceptable:

AB . CD2 . E

- The qualifiers must be separated by a single period.
- The first letter of each qualifier must be alphabetic or national (@,#,\$), followed by alphabetic, national, hyphen, or numeric characters.

An example of a tape volume data set name using the default prefix is ADSM.BFS.

#### MOUNTRetention

Specifies the number of minutes that an idle sequential access volume is retained before it is dismounted. This parameter is optional. The default value is 60 minutes. You can specify a number 0 - 9999.

This parameter can improve response time for sequential access media mounts by leaving previously mounted volumes online.

However, for EXTERNAL library types, setting this parameter to a low value (for example, two minutes) enhances device sharing between applications.

Note: For environments in which devices are shared across storage applications, the MOUNTRETENTION setting must be carefully considered. This parameter determines how long an idle volume remains in a drive. Some media managers do not dismount an allocated drive to satisfy pending requests. You might need to tune this parameter to satisfy competing mount requests while maintaining optimal system performance. Typically, problems arise more frequently when the MOUNTRETENTION parameter is set to a value that is too small, for example, zero.

#### MOUNTWait

Specifies the maximum number of minutes the server waits for an operator to respond to a request to either mount a volume in a drive in a manual library or check in a volume to be mounted in an automated library. This parameter is optional. If the mount request is not satisfied within the specified amount of time, the mount request is canceled. The default value is 60 minutes. You can specify a number 0 - 9999.

Restriction: If the library that is associated with this device class is external (LIBTYPE=EXTERNAL), do not specify the MOUNTWAIT parameter.

#### MOUNTLimit

Specifies the maximum number of sequential access volumes that can be simultaneously mounted for the device class. This parameter is optional. The default is DRIVES. You can specify a number 0 - 4096.

If you plan to use the simultaneous-write function, ensure that sufficient drives are available for the write operation. If the number of drives needed for a simultaneous-write operation is greater than the value of the MOUNTLIMIT parameter for a device class, the transaction fails.

The following are possible values:

#### DRIVES

Specifies that every time a mount point is allocated, the number of drives that are defined and online in the library is used to calculate the true value.

Note: For EXTERNAL library types, do not specify DRIVES for the MOUNTLIMIT value. Specify the number of drives for the library as the MOUNTLIMIT value.

#### number

Specifies the maximum number of drives in this device class that are used concurrently by the server. This value must never exceed the number of drives that are defined and online in the library that services this device class.

#### 0 (zero)

Specifies that no new transactions can gain access to the storage pool. Any current transactions continue and complete, but new transactions are terminated.

#### DRIVEEncryption

Specifies whether drive encryption is allowed. This parameter is optional. The default is ALLOW.

#### ON

Specifies that IBM Spectrum Protect is the key manager for drive encryption and allows drive encryption for empty storage pool volumes only if the application method is enabled. (Other types of volumes-for example, back up sets, export volumes, and database backup volumes-will not be encrypted.) If you specify ON and you enable either the library or system method of encryption, drive encryption is not allowed and backup operations fail.

#### ALLOW



Specifies that IBM Spectrum Protect does not manage the keys for drive encryption. However, drive encryption for empty volumes is allowed if either the library or system method of encryption is enabled.

#### EXTERNAL

Specifies that IBM Spectrum Protect does not manage the keys for drive encryption. Use this setting with an encryption methodology that is provided by another vendor and that is used with Application Method Encryption (AME) enabled on the drive.

When you specify EXTERNAL and IBM Spectrum Protect detects that AME encryption is enabled, IBM Spectrum Protect does not turn off encryption.

By contrast, when you specify ALLOW and IBM Spectrum Protect detects that AME encryption is enabled, IBM Spectrum Protect turns off encryption.

#### OFF

Specifies that drive encryption is not allowed. If you enable either the library or system method of encryption, backups fail. If you enable the application method, IBM Spectrum Protect disables encryption and backups are attempted.

## DEFINE DEVCLASS (Define a 4MM device class)

---

Use the 4MM device class when you are using 4 mm tape devices.

### Privilege class

---

To issue this command, you must have system privilege or unrestricted storage privilege.

### Syntax

---

```
>>-DEFine DEVclass--device_class_name----->
>>-LIBRary----library_name--DEVType-----4MM----->
.-FORMAT----DRIVE-----
>--+-----+-----+-----+----->
'-FORMAT----+DRIVE+-' '-ESTCAPacity----size-'
      +-DDS1--+
      +-DDS1C+
      +-DDS2--+
      +-DDS2C+
      +-DDS3--+
      +-DDS3C+
      +-DDS4--+
      +-DDS4C+
      +-DDS5--+
      +-DDS5C+
      +-DDS6--+
      '-DDS6C-'

.-PREFIX----ADSM-----
>--+-----+-----+-----+----->
'-PREFIX----+ADSM-----+-'
      '-tape_volume_prefix-'

.-MOUNTWait----60-----.-MOUNTRetention----60-----
>--+-----+-----+-----+----->
'-MOUNTWait----minutes-' '-MOUNTRetention----minutes-'

.-MOUNTLimit----DRIVES-----
>--+-----+-----+-----+----->>
'-MOUNTLimit----+DRIVES+-'
      +-number+
      '-0-----'
```

### Parameters

---

device\_class\_name (Required)

Specifies the name of the device class to be defined. The maximum length of the device class name is 30 characters.

LIBRary (Required)

Specifies the name of the defined library object that contains the 4 mm tape drives used by this device class. For information about defining a library object, see the DEFINE LIBRARY command.

DEVType=4MM (Required)

Specifies that the 4MM device type is assigned to the device class. The 4MM indicates that 4 mm tape devices are assigned to this device class.

FORMAT

Specifies the recording format to be used when data is written to sequential access media. This parameter is optional. The default value is DRIVE.

If the drives are in a library that includes drives of different tape technology, do not use the DRIVE value. Use the specific format that the drives use.

The following table lists the recording formats and estimated capacities for 4 mm devices:

Table 1. Recording formats and default estimated capacities for 4 mm tapes

Format	Estimated Capacity	Description
DRIVE	–	The server selects the highest format that is supported by the drive on which a volume is mounted. Attention: Avoid specifying DRIVE when a mixture of drives is used within the same library. For example, do not use this option for a library that contains some drives that support recording formats superior to other drives.
DDS1	2.6 GB (60 meter) 4.0 GB (90 meter)	Uncompressed format, applies only to 60-meter and 90-meter tapes
DDS1C	See note 1.3 GB (60 meter) 2.0 GB (90 meter)	Compressed format, applies only to 60-meter and 90-meter tapes
DDS2	4.0 GB	Uncompressed format, applies only to 120-meter tapes
DDS2C	See note 8.0 GB	Compressed format, applies only to 120-meter tapes
DDS3	12.0 GB	Uncompressed format, applies only to 125-meter tapes
DDS3C	See note 24.0 GB	Compressed format, applies only to 125-meter tapes
DDS4	20.0 GB	Uncompressed format, applies only to 150-meter tapes
DDS4C	See note 40.0 GB	Compressed format, applies only to 150-meter tapes
DDS5	36 GB	Uncompressed format, when using DAT 72 media
DDS5C	See note 72 GB	Compressed format, when using DAT 72 media
DDS6	80 GB	Uncompressed format, when using DAT 160 media
DDS6C	See note 160 GB	Compressed format, when using DAT 160 media
Note: If this format uses the tape drive hardware compression feature, depending on the effectiveness of compression, the actual capacity might be greater than the listed value.		

ESTCAPacity

Specifies the estimated capacity for the volumes that are assigned to this device class. This parameter is optional.

You can specify this parameter if the default estimated capacity for the device class is inaccurate due to compression of data.

You must specify this value as an integer followed by one of the following unit indicators: **K** (kilobytes), **M** (megabytes), **G** (gigabytes), or **T** (terabytes). The smallest value that is accepted is 1 MB (ESTCAPACITY=1M).

For example, specify that the estimated capacity is 9 GB with the parameter ESTCAPACITY=9G.

For more information about the default estimated capacity for 4 mm tapes, see Table 1

#### PREFIX

Specifies the high-level qualifier of the file name that the server writes into the sequential access media labels. For each sequential access volume assigned to this device class, the server uses this prefix to create the data set name. This parameter is optional. The default is ADSM. The maximum length of this prefix is 8 characters.

If you have a naming convention for media labels to support your current management system, use a volume prefix that conforms to your naming conventions.

Values that are specified for this parameter must meet the following conditions:

- The value is to be made up of qualifiers, which can be a maximum of eight characters including periods. For example, the following value is acceptable:

AB.CD2.E

- The qualifiers must be separated by a single period.
- The first letter of each qualifier must be alphabetic or national (@,#,\$), followed by alphabetic, national, hyphen, or numeric characters.

An example of a tape volume data set name using the default prefix is ADSM.BFS.

#### MOUNTRetention

Specifies the number of minutes that an idle sequential access volume is retained before it is dismounted. This parameter is optional. The default value is 60 minutes. You can specify a number 0 - 9999.

This parameter can improve response time for sequential access media mounts by leaving previously mounted volumes online.

However, for EXTERNAL library types (that is, a library that is managed by an external media management system), set this parameter to a low value (for example, two minutes) to enhance device sharing between applications.

Note: For environments in which devices are shared across storage applications, the MOUNTRETENTION setting must be carefully considered. This parameter determines how long an idle volume remains in a drive. Some media managers do not dismount an allocated drive to satisfy pending requests. You might need to tune this parameter to satisfy competing mount requests while maintaining optimal system performance. Typically, problems arise more frequently when the MOUNTRETENTION parameter is set to a value that is too small, for example, zero.

#### MOUNTWait

Specifies the maximum number of minutes the server waits for an operator to respond to a request to either mount a volume in a drive in a manual library or check in a volume to be mounted in an automated library. This parameter is optional. If the mount request is not satisfied within the specified amount of time, the mount request is canceled. The default value is 60 minutes. You can specify a number 0 - 9999.

Restriction: If the library that is associated with this device class is external (LIBTYPE=EXTERNAL), do not specify the MOUNTWAIT parameter.

#### MOUNTLimit

Specifies the maximum number of sequential access volumes that can be simultaneously mounted for the device class. This parameter is optional. The default is DRIVES. You can specify a number 0 - 4096.

If you plan to use the simultaneous-write function, ensure that sufficient drives are available for the write operation. If the number of drives needed for a simultaneous-write operation is greater than the value of the MOUNTLIMIT parameter for a device class, the transaction fails.

The following are possible values:

#### DRIVES

Specifies that every time a mount point is allocated, the number of drives that are defined and online in the library is used to calculate the true value.

Note: For EXTERNAL library types, do not specify DRIVES for the MOUNTLIMIT value. Specify the number of drives for the library as the MOUNTLIMIT value.

number

Specifies the maximum number of drives in this device class that are used concurrently by the server. This value must never exceed the number of drives that are defined and online in the library that services this device class.

0 (zero)

Specifies that no new transactions can gain access to the storage pool. Any current transactions continue and complete, but new transactions are terminated.

## DEFINE DEVCLASS (Define an 8MM device class)

---

Use the 8MM device class when you are using 8 mm tape devices.

### Privilege class

---

To issue this command, you must have system privilege or unrestricted storage privilege.

### Syntax

---

```
>>-DEFine DEVclass--device_class_name----->
>>-LIBRARY----library_name--DEVType----8MM----->
.-WORM----No----- .-FORMAT----DRIVE-----
>--+-----+-----+-----+-----+----->
'-WORM----+No--+-' '-FORMAT----+DRIVE--+-'
      '-Yes-'                +-8200--+
                          +-8200C--+
                          +-8500--+
                          +-8500C--+
                          +-8900--+
                          +-AIT--+
                          +-AITC--+
                          +-M2----+
                          +-M2C---+
                          +-SAIT--+
                          +-SAITC--+
                          +-VXA2--+
                          +-VXA2C--+
                          +-VXA3--+
                          '-VXA3C-'

>--+-----+-----+-----+-----+----->
'-ESTCAPacity----size-'

.-PREFIX----ADSM-----
>--+-----+-----+-----+-----+----->
'-PREFIX----+ADSM-----+-'
      '-tape_volume_prefix-'

.-MOUNTRetention----60----- .-MOUNTWait----60-----
>--+-----+-----+-----+-----+----->
'-MOUNTRetention----minutes-' '-MOUNTWait----minutes-'

.-MOUNTLimit----DRIVES-----
>--+-----+-----+-----+-----+-----><
'-MOUNTLimit----+DRIVES--+-'
      +-number+
      '-0-----'
```

### Parameters

---

device\_class\_name (Required)

Specifies the name of the device class to be defined. The maximum length of the device class name is 30 characters.

LIBRARY (Required)

Specifies the name of the defined library object that contains the 8 mm tape drives used by this device class. For information about defining a library object, see the DEFINE LIBRARY command.

DEVType=8MM (Required)

Specifies that the 8MM device type is assigned to the device class. 8MM indicates that 8 mm tape devices are assigned to this device class.

#### WORM

Specifies whether the drives use WORM (write once, read many) media. This parameter is optional. The default is No. The field can contain one of the following values:

Yes

Specifies that the drives use WORM media.

No

Specifies that the drives do not use WORM media.

Note: If you select Yes, the only options available for the FORMAT parameter are:

- DRIVE
- AIT
- AITC

#### FORMAT

Specifies the recording format to be used when data is written to sequential access media. This parameter is optional. The default value is DRIVE.

If the drives are in a library that includes drives of different tape technology, do not use the DRIVE value. Use the specific format that the drives use.

The following table lists the recording formats and estimated capacities for 8 mm devices:

Table 1. Recording format and default estimated capacity for 8 mm tape

Format		Description
Medium Type	Estimated Capacity	
DRIVE	–	The server selects the highest format that is supported by the drive on which a volume is mounted. Attention: Avoid specifying DRIVE when a mixture of drives is used within the same library. For example, do not use this option for a library that contains some drives that support recording formats superior to other drives.
8200	2.3 GB	Uncompressed (standard) format, using standard 112-meter tape cartridges
8200C	See note 3.5 GB 4.6 GB	Compressed format, using standard 112-meter tape cartridges
8500	See note	Drives (Read Write)
15m	600 MB	Eliaint 820 (RW)
15m	600 MB	Exabyte 8500/8500C (RW)
15m	600 MB	Exabyte 8505 (RW)
54m	2.35 GB	Eliaint 820 (RW)
54m	2.35 GB	Exabyte 8500/8500C (RW)
54m	2.35 GB	Exabyte 8505 (RW)
112m	5 GB or 10.0 GB	Eliaint 820 (RW)
112m	5 GB or 10.0 GB	Exabyte 8500/8500C (RW)
112m	5 GB or 10.0 GB	Exabyte 8505 (RW)
160m XL	7 GB	Eliaint 820 (RW)

<b>Format</b>		<b>Description</b>
<b>Medium Type</b>	<b>Estimated Capacity</b>	
8500C	See note	Drives (Read Write)
15m	1.2 GB	Eliant 820 (RW)
15m	1.2 GB	Exabyte 8500/8500C (RW)
15m	1.2 GB	Exabyte 8505 (RW)
54m	4.7 GB	Eliant 820 (RW)
54m	4.7 GB	Exabyte 8500/8500C (RW)
54m	4.7 GB	Exabyte 8505 (RW)
112m	5 GB or 10.0 GB	Eliant 820 (RW)
112m	5 GB or 10.0 GB	Exabyte 8500/8500C (RW)
112m	5 GB or 10.0 GB	Exabyte 8505 (RW)
160m XL	7 GB	Eliant 820 (RW)
8900	See note	Drive (Read Write)
15m	–	Mammoth 8900 (R)
54m	–	Mammoth 8900 (R)
112m	–	Mammoth 8900 (R)
160m XL	–	Mammoth 8900 (R)
22m	2.5 GB	Mammoth 8900 (RW)
125m	–	Mammoth 8900 (RW with upgrade)
170m	40 GB	Mammoth 8900 (RW)
AIT	See note	Drive
SDX1–25C	25 GB	AIT, AIT2 and AIT3 drives
SDX1–35C	35 GB	AIT, AIT2 and AIT3 drives
SDX2–36C	36 GB	AIT2 and AIT3 drives
SDX2–50C	50 GB	AIT2 and AIT3 drives
SDX3–100C	100 GB	AIT3, AIT4, and AIT5 drives
SDX3X-150C	150 GB	AIT3-Ex, AIT4, and AIT5 drives
SDX4–200C	200 GB	AIT4 and AIT5 drives
SDX5-400C	400 GB	AIT5 drive
AITC	See note	Drive
SDX1–25C	50 GB	AIT, AIT2 and AIT3 drives
SDX1–35C	91 GB	AIT, AIT2 and AIT3 drives
SDX2–36C	72 GB	AIT2 and AIT3 drives
SDX2–50C	130 GB	AIT2 and AIT3 drives
SDX3–100C	260 GB	AIT3, AIT4, and AIT5 drives
SDX3X-150C	390 GB	AIT3-Ex, AIT4, and AIT5 drives
SDX4–200C	520 GB	AIT4 and AIT5 drives
SDX5-400C	1040 GB	AIT5 drive
M2	See note	Drive (Read Write)
75m	20.0 GB	Mammoth II (RW)
150m	40.0 GB	Mammoth II (RW)
225m	60.0 GB	Mammoth II (RW)
M2C	See note	Drive (Read Write)
75m	50.0 GB	Mammoth II (RW)
150m	100.0 GB	Mammoth II (RW)
225m	150.0 GB	Mammoth II (RW)
SAIT	See note	Drive (Read Write)
	500 GB	Sony SAIT1–500(RW)
SAITC	See note	Drive (Read Write)
	1300 GB (1.3 TB)	Sony SAIT1–500(RW)

<b>Format</b>		<b>Description</b>
<b>Medium Type</b>	<b>Estimated Capacity</b>	
VXA2	See note	Drive (Read Write)
V6 (62m)	20 GB	VXA-2
V10 (124m)	40 GB	
V17 (170m)	60 GB	
VXA2C	See note	Drive (Read Write)
V6 (62m)	40 GB	VXA-2
V10 (124m)	80 GB	
V17 (170m)	120 GB	
VXA3	See note	Drive (Read Write)
X6 (62m)	40 GB	VXA-3
X10 (124m)	86 GB	
X23 (230m)	160 GB	
VXA3C	See note	Drive (Read Write)
X6 (62m)	80 GB	VXA-3
X10 (124m)	172 GB	
X23 (230m)	320 GB	
<p>Note: The actual capacities might vary depending on which cartridges and drives are used.</p> <ul style="list-style-type: none"> <li>• For the M2C format, the normal compression ratio is 2.5:1.</li> <li>• For the AITC and SAITC formats, the normal compression ratio is 2.6:1.</li> </ul>		

#### ESTCAPACITY

Specifies the estimated capacity for the volumes that are assigned to this device class. This parameter is optional.

You can specify this parameter if the default estimated capacity for the device class is inaccurate due to compression of data.

You must specify this value as an integer followed by one of the following unit indicators: **K** (kilobytes), **M** (megabytes), **G** (gigabytes), or **T** (terabytes). The smallest value that is accepted is 1 MB (ESTCAPACITY=1M).

For example, specify that the estimated capacity is 9 GB with the parameter ESTCAPACITY=9G.

For more information about the default estimated capacity for 8 mm tapes, see Table 1.

#### PREFIX

Specifies the high-level qualifier of the data set name that the server writes into the sequential access media labels. For each sequential access volume assigned to this device class, the server uses this prefix to create the data set name. This parameter is optional. The default value is ADSM. The maximum length of this prefix is 8 characters.

If you have a naming convention for media labels to support your current management system, use a volume prefix that conforms to your naming conventions.

Values that are specified for this parameter must meet the following conditions:

- The value is to be made up of qualifiers, which can be a maximum of eight characters including periods. For example, the following value is acceptable:

AB.CD2.E

- The qualifiers must be separated by a single period.
- The first letter of each qualifier must be alphabetic or national (@,#,\$), followed by alphabetic, national, hyphen, or numeric characters.

An example of a tape volume data set name using the default prefix is ADSM.BFS.

#### MOUNTRETENTION

Specifies the number of minutes that an idle sequential access volume is retained before it is dismounted. This parameter is optional. The default value is 60 minutes. You can specify a number 0 - 9999.

This parameter can improve response time for sequential access media mounts by leaving previously mounted volumes online.

However, for EXTERNAL library types (that is, a library that is managed by an external media management system), set this parameter to a low value (for example, two minutes) to enhance device sharing between applications.

Note: For environments in which devices are shared across storage applications, the MOUNTRETENTION setting must be carefully considered. This parameter determines how long an idle volume remains in a drive. Some media managers do not dismount an allocated drive to satisfy pending requests. You might need to tune this parameter to satisfy competing mount requests while maintaining optimal system performance. Typically, problems arise more frequently when the MOUNTRETENTION parameter is set to a value that is too small, for example, zero.

#### MOUNTWait

Specifies the maximum number of minutes the server waits for an operator to respond to a request to either mount a volume in a drive in a manual library or check in a volume to be mounted in an automated library. This parameter is optional. If the mount request is not satisfied within the specified amount of time, the mount request is canceled. The default value is 60 minutes. You can specify a number 0 - 9999.

Restriction: If the library that is associated with this device class is external (LIBTYPE=EXTERNAL), do not specify the MOUNTWAIT parameter.

#### MOUNTLimit

Specifies the maximum number of sequential access volumes that can be simultaneously mounted for the device class. This parameter is optional. The default is DRIVES. You can specify a number 0 - 4096.

If you plan to use the simultaneous-write function, ensure that sufficient drives are available for the write operation. If the number of drives needed for a simultaneous-write operation is greater than the value of the MOUNTLIMIT parameter for a device class, the transaction fails.

The following are possible values:

#### DRIVES

Specifies that every time a mount point is allocated, the number of drives that are defined and online in the library is used to calculate the true value.

Note: For EXTERNAL library types, do not specify DRIVES for the MOUNTLIMIT value. Specify the number of drives for the library as the MOUNTLIMIT value.

#### number

Specifies the maximum number of drives in this device class that are used concurrently by the server. This value must never exceed the number of drives that are defined and online in the library that services this device class.

#### 0 (zero)

Specifies that no new transactions can gain access to the storage pool. Any current transactions continue and complete, but new transactions are terminated.

## Example: Define an 8 mm device class

---

Define a device class that is named 8MMTAPE for an 8 mm device in a library named AUTO. The format is DRIVE, mount limit is 2, mount retention is 10, tape volume prefix is named ADSMVOL, and the estimated capacity is 6 GB.

```
define devclass 8mmtape devtype=8mm library=auto
format=drive mountlimit=2 mountretention=10
prefix=adsmvol estcapacity=6G
```

## DEFINE DEVCLASS (Define a CENTERA device class)

---

Use the CENTERA device class when you are using EMC Centera storage devices. The CENTERA device type uses files as volumes to store data sequentially. It is similar to the FILE device class.

### Privilege class

---

To issue this command, you must have system privilege or unrestricted storage privilege.

### Syntax

---



```
>>-DEfINE DEVclass--device_class_name--DEVType---CENTERA----->
      .-,-----
      (1)  V      |
>>-HLAddress-----ip_address+-?PEA_file----->
      .-MINCAPacity----100M-.  .-MOUNTLimit----1-----
>--+-----+-----><
      '-MINCAPacity----size-'  '-MOUNTLimit----number-'
```

#### Notes:

1. For each Centera device class, you must specify one or more IP addresses. However, a Pool Entry Authorization (PEA) file name and path are optional, and up to one PEA file specification can follow the IP addresses. Use the "?" character to separate the PEA file name and path from the IP addresses.

## Parameters

#### device\_class\_name (Required)

Specifies the name of the device class to be defined. The maximum length of the device class name is 30 characters.

#### DEVType=CENTERA (Required)

Specifies that the Centera device type is assigned to this device class. All volumes that belong to a storage pool that is defined to this device class are logical volumes that are a form of sequential access media.

#### HLAddress

Specifies one or more IP addresses for the Centera storage device and, optionally, the name and path of one Pool Entry Authorization (PEA) file. Specify the IP addresses with the dotted decimal format (for example, 9.10.111.222). A Centera device might have multiple IP addresses. If multiple IP addresses are specified, then the store or retrieve operation attempts a connection by using each IP address that is specified until a valid address is found.

**AIX** The PEA file name and path name are case-sensitive.

If you append the name and path of a PEA file, ensure that the file is stored in a directory on the system that runs the server. Separate the PEA file name and path from the IP address with the "?" character, for example: **Windows**

```
HLADDRESS=9.10.111.222,9.10.111.223?c:\controlFiles\TSM.PEA
```

**AIX**

```
HLADDRESS=9.10.111.222,9.10.111.223?/user/ControlFiles/TSM.PEA
```

Specify only one PEA file name and path for each device class definition. If you specify two different Centera device classes that point to the same Centera storage device and if the device class definitions contain different PEA file names and paths, the server uses the PEA file that is specified in the device class HLADDRESS parameter that was first used to open the Centera storage device.

#### Tips:

1. The server does not include a PEA file during installation. If you do not create a PEA file, the server uses the Centera default profile, which can allow applications to read, write, delete, purge, and query data on a Centera storage device. To provide tighter control, create a PEA file with the command-line interface that is provided by EMC Centera. For details about Centera authentication and authorization, refer to the EMC Centera *Programmer's Guide*.
2. You can also specify the PEA file name and path in an environment variable with the syntax `CENTERA_PEA_LOCATION=filePath_fileName`. The PEA file name and path that is specified with this environment variable apply to all Centera clusters. If you use this variable, you do not have to specify the PEA file name and path with the HLADDRESS parameter.

#### MINCAPacity

Specifies the minimum size for Centera volumes that are assigned to a storage pool in this device class. This value represents the minimum amount of data that is stored on a Centera volume before the server marks it full. Centera volumes continue to accept data until the minimum amount of data is stored. This parameter is optional.

Specify this value as an integer followed by **K** (kilobytes), **M** (megabytes), **G** (gigabytes), or **T** (terabytes). The default value is 100 MB (MINCAPACITY=100M). The minimum value that is allowed is 1 MB (MINCAPACITY=1M). The maximum value that is allowed is 128 GB (MINCAPACITY=128G).

#### MOUNTLimit

Specifies the maximum number of files that can be simultaneously open for input and output. The default value is 1. This parameter is optional. You can specify any number from 0 or greater; however, the sum of all mount limit values for all device classes that are assigned to the same Centera device must not exceed the maximum number of sessions that are allowed by Centera.

## DEFINE DEVCLASS (Define a DLT device class)

Use the DLT device class when you are using DLT tape devices.

### Privilege class

To issue this command, you must have system privilege or unrestricted storage privilege.

### Syntax

```
>>-DEFine DEVclass--device_class_name----->
>--LIBRARY----library_name--DEVType----DLT----->
.-WORM----No----- .-FORMAT----DRIVE-----
>--+-----+-----+-----+----->
'-WORM----+-No-+-' '-FORMAT----+-DRIVE----+'
      '-Yes-'          +-DLT1-----+
                        +-DLT1C----+
                        +-DLT10----+
                        +-DLT10C---+
                        +-DLT15----+
                        +-DLT15C---+
                        +-DLT20----+
                        +-DLT20C---+
                        +-DLT35----+
                        +-DLT35C---+
                        +-DLT40----+
                        +-DLT40C---+
                        +-DLT2-----+
                        +-DLT2C----+
                        +-DLT4-----+
                        +-DLT4C----+
                        +-SDLT-----+
                        +-SDLTC----+
                        +-SDLT320---+
                        +-SDLT320C--+
                        +-SDLT600---+
                        +-SDLT600C--+
                        +-DLTS4-----+
                        '-DLTS4C---'
```

```
>--+-----+-----+-----+----->
'-ESTCAPacity----size-'
.-PREFIX----ADSM-----
>--+-----+-----+-----+----->
'-PREFIX----+-ADSM-----+'
      '-tape_volume_prefix-'
```

```
.-MOUNTRetention----60----- .-MOUNTWait----60-----
>--+-----+-----+-----+----->
'-MOUNTRetention----minutes-' '-MOUNTWait----minutes-'
```

```
.-MOUNTLimit----DRIVES-----
>--+-----+-----+-----+----->
'-MOUNTLimit----+-DRIVES-+-'
      +-number-+
      '-0-----'
```

### Parameters

device\_class\_name (Required)

Specifies the name of the device class to be defined. The maximum length of the device class name is 30 characters.

LIBRARY (Required)

Specifies the name of the defined library object that contains the DLT tape drives used by this device class. For information about defining a library object, see the DEFINE LIBRARY command.

DEVType=DLT (Required)

Specifies that the DLT device type is assigned to the device class. DLT indicates that DLT tape devices are assigned to this device class.

WORM

Specifies whether the drives use WORM (write once, read many) media. This parameter is optional. The default is No. The field can contain one of the following values:

Yes

Specifies that the drives use WORM media.

No

Specifies that the drives do not use WORM media.

Note: Support for DLT WORM media is available only for SDLT-600, Quantum DLT-V4, and Quantum DLT-S4 drives in manual, SCSI, and ACSLS libraries.

FORMAT

Specifies the recording format to be used when data is written to sequential access media. This parameter is optional. The default value is DRIVE.

If the drives are in a library that includes drives of different tape technology, do not use the DRIVE value. Use the specific format that the drives use.

The following table lists the recording formats and estimated capacities for DLT devices:

Table 1. Recording format and default estimated capacity for DLT

Format	Estimated Capacity	Description
DRIVE	–	The server selects the highest format that is supported by the drive on which a volume is mounted. Attention: Avoid specifying DRIVE when a mixture of drives is used within the same library. For example, do not use this option for a library that contains some drives that support recording formats superior to other drives.
DLT1	40.0 GB	Uncompressed format, using only CompacTape III cartridges Valid with DLT4000, DLT7000, and DLT8000 drives
DLT1C	See note 1. 80.0 GB	Compressed format, using only CompacTape III cartridges Valid with DLT4000, DLT7000, and DLT8000 drives
DLT10	10.0 GB	Uncompressed format, using only CompacTape III cartridges Valid with DLT4000, DLT7000, and DLT8000 drives
DLT10C	See note 1. 20.0 GB	Compressed format, using only CompacTape III cartridges Valid with DLT4000, DLT7000, and DLT8000 drives
DLT15	15.0 GB	Uncompressed format, using only CompacTape IIIxt cartridges Valid with DLT4000, DLT7000, and DLT8000 drives
DLT15C	See note 1. 30.0 GB	Compressed format, using only CompacTape IIIxt cartridges Valid with DLT4000, DLT7000, and DLT8000 drives
DLT20	20.0 GB	Uncompressed format, using only CompacTape IV cartridges Valid with DLT4000, DLT7000, and DLT8000 drives
DLT20C	See note 1. 40.0 GB	Compressed format, using only CompacTape IV cartridges Valid with DLT4000, DLT7000, and DLT8000 drives

Format	Estimated Capacity	Description
DLT35	35.0 GB	Uncompressed format, using only CompacTape IV cartridges Valid with DLT7000 and DLT8000 drives
DLT35C	See note 1. 70.0 GB	Compressed format, using only CompacTape IV cartridges Valid with DLT7000 and DLT8000 drives
DLT40	40.0 GB	Uncompressed format, using CompacTape IV cartridges Valid with a DLT8000 drive
DLT40C	See note 1. 80.0 GB	Compressed format, using CompacTape IV cartridges Valid with a DLT8000 drive
DLT2	80.0 GB	Uncompressed format, using Quantum DLT tape VS1 media
DLT2C	See note 1. 160.0 GB	Compressed format, using Quantum DLT tape VS1 media
DLT4	160.0 GB	Uncompressed format, using Quantum DLTtape VS1 cartridges. Valid with Quantum DLT-V4 drive
DLT4C	See note 1. 320.0 GB	Compressed format, using Quantum DLTtape VS1 cartridges. Valid with Quantum DLT-V4 drive
SDLT See note 2.	100.0 GB	Uncompressed format, using Super DLT Tape 1 cartridges Valid with a Super DLT drive
SDLTC See note 2.	See note 1. 200.0 GB	Compressed format, using Super DLT Tape 1 cartridges Valid with a Super DLT drive
SDLT320 See note 2.	160.0 GB	Uncompressed format, using Quantum SDLT I media Valid with a Super DLT drive
SDLT320C See note 2.	See note 1. 320.0 GB	Compressed format, using Quantum SDLT I media Valid with a Super DLT drive
SDLT600	300.0 GB	Uncompressed format, using SuperDLTtape-II media Valid with a Super DLT drive
SDLT600C	See note 1. 600.0 GB	Compressed format, using SuperDLTtape-II media Valid with a Super DLT drive
DLTS4	800 GB	Uncompressed format, using Quantum DLT S4 media. Valid with a DLT-S4 drive
DLTS4C	See note 1. 1.6 TB	Compressed format, using Quantum DLT S4 media. Valid with a DLT-S4 drive
<p>Note:</p> <ol style="list-style-type: none"> <li>1. Depending on the effectiveness of compression, the actual capacity might be greater than the listed value.</li> <li>2. IBM Spectrum Protect™ does not support a library that contains both Backward Read Compatible (BRC) SDLT and Non-Backward Read Compatible (NBRC) SDLT drives.</li> </ol>		

#### ESTCAPacity

Specifies the estimated capacity for the volumes that are assigned to this device class. This parameter is optional.

You can specify this parameter if the default estimated capacity for the device class is inaccurate due to compression of data.

You must specify this value as an integer followed by one of the following unit indicators: **K** (kilobytes), **M** (megabytes), **G** (gigabytes), or **T** (terabytes). The smallest value that is accepted is 1 MB (ESTCAPACITY=1M).

For example, specify that the estimated capacity is 9 GB with the parameter ESTCAPACITY=9G.

For more information about estimated capacities, see Table 1.

#### PREFIX

Specifies the high-level qualifier of the data set name that the server writes into the sequential access media labels. For each sequential access volume assigned to this device class, the server uses this prefix to create the data set name. This parameter is optional. The default value is ADSM. The maximum length of this prefix is 8 characters.

If you have a naming convention for media labels to support your current management system, use a volume prefix that conforms to your naming conventions.

Values that are specified for this parameter must meet the following conditions:

- The value is to be made up of qualifiers, which can be a maximum of eight characters including periods. For example, the following value is acceptable:

AB.CD2.E

- The qualifiers must be separated by a single period.
- The first letter of each qualifier must be alphabetic or national (@,#,\$), followed by alphabetic, national, hyphen, or numeric characters.

An example of a tape volume data set name using the default prefix is ADSM.BFS.

#### MOUNTRetention

Specifies the number of minutes that an idle sequential access volume is retained before it is dismounted. This parameter is optional. The default value is 60 minutes. You can specify a number 0 - 9999.

This parameter can improve response time for sequential access media mounts by leaving previously mounted volumes online.

However, for EXTERNAL library types (that is, a library that is managed by an external media management system), set this parameter to a low value (for example, two minutes) to enhance device sharing between applications.

Note: For environments in which devices are shared across storage applications, the MOUNTRETENTION setting must be carefully considered. This parameter determines how long an idle volume remains in a drive. Some media managers do not dismount an allocated drive to satisfy pending requests. You might need to tune this parameter to satisfy competing mount requests while maintaining optimal system performance. Typically, problems arise more frequently when the MOUNTRETENTION parameter is set to a value that is too small, for example, zero.

#### MOUNTWait

Specifies the maximum number of minutes the server waits for an operator to respond to a request to either mount a volume in a drive in a manual library or check in a volume to be mounted in an automated library. This parameter is optional. If the mount request is not satisfied within the specified amount of time, the mount request is canceled. The default value is 60 minutes. You can specify a number 0 - 9999.

Restriction: If the library that is associated with this device class is external (LIBTYPE=EXTERNAL), do not specify the MOUNTWAIT parameter.

#### MOUNTLimit

Specifies the maximum number of sequential access volumes that can be simultaneously mounted for the device class. This parameter is optional. The default is DRIVES. You can specify a number 0 - 4096.

If you plan to use the simultaneous-write function, ensure that sufficient drives are available for the write operation. If the number of drives needed for a simultaneous-write operation is greater than the value of the MOUNTLIMIT parameter for a device class, the transaction fails.

The following are possible values:

#### DRIVES

Specifies that every time a mount point is allocated, the number of drives that are defined and online in the library is used to calculate the true value.

Note: For EXTERNAL library types, do not specify DRIVES for the MOUNTLIMIT value. Specify the number of drives for the library as the MOUNTLIMIT value.

number

Specifies the maximum number of drives in this device class that are used concurrently by the server. This value must never exceed the number of drives that are defined and online in the library that services this device class.

0 (zero)

Specifies that no new transactions can gain access to the storage pool. Any current transactions continue and complete, but new transactions are terminated.

## DEFINE DEVCLASS (Define an ECARTRIDGE device class)

Use the ECARTRIDGE device class when you are using StorageTek drives such as the StorageTek T9840 or T10000.

**AIX** | **Linux** If you are defining a device class for devices that are to be accessed through a z/OS® media server, see DEFINE DEVCLASS (Define an ECARTRIDGE device class for z/OS media server).

### Privilege class

To issue this command, you must have system privilege or unrestricted storage privilege.

### Syntax

```
>>-DEfine DEVclass--device_class_name----->
>>-LIBRARY----library_name--DEVType----ECARtridge----->
                                     (1)
.-LBProtect---No-----.-WORM---No-----
>+-----+-----+-----+-----+----->
'-LBProtect---+READWrite+-' '-WORM---+No---+'
      +WRITEOnly+          '-Yes-'
      '-No-----'

.-FORMAT----DRIVE-----
>+-----+-----+-----+-----+----->
'-FORMAT---+DRIVE---+' '-ESTCAPacity----size-'
      +T9840C---+
      +T9840C-C--+
      +T9840D---+
      +T9840D-C--+
      +T10000A---+
      +T10000A-C+
      +T10000B---+
      +T10000B-C+
      +T10000C---+
      +T10000C-C+
      +T10000D---+
      '-T10000D-C-'

.-PREFIX----ADSM-----
>+-----+-----+-----+-----+----->
'-PREFIX---+ADSM---+'
      '-tape_volume_prefix-'

.-MOUNTRetention---60-----.-MOUNTWait---60-----
>+-----+-----+-----+-----+----->
'-MOUNTRetention---minutes-' '-MOUNTWait---minutes-'

.-MOUNTLimit----DRIVES-----
>+-----+-----+-----+-----+----->
'-MOUNTLimit---+DRIVES+-'
      +-number+
      '-0-----'

                                     (1) (2)
.-DRIVEEncryption---ALLOW-----
>+-----+-----+-----+-----+-----><
'-DRIVEEncryption---+ON-----+'
      +-ALLOW----+
      +-EXternal+
      '-OFF-----'
```

Notes:

1. You cannot specify both WORM=Yes and DRIVEENCRYPTION=ON.
2. You can use drive encryption only for Oracle StorageTek T10000B drives with a format value of DRIVE, T10000B, or T10000B-C, for Oracle StorageTek T10000C drives with a format value of DRIVE, T10000C or T10000C-C, and for Oracle StorageTek T10000D drives with a format value of DRIVE, T10000D and T10000D-C.

## Parameters

---

device\_class\_name (Required)

Specifies the name of the device class to be defined. The maximum length of the device class name is 30 characters.

LIBRARY (Required)

Specifies the name of the defined library object that contains the ECARTRIDGE tape drives that can be used by this device class. For information about defining a library object, see the DEFINE LIBRARY command.

DEVType=ECARTRIDGE (Required)

Specifies that the ECARTRIDGE device type is assigned to the device class. ECARTRIDGE indicates that a specific type of cartridge tape device (StorageTek) is assigned to this device class.

LBProtect

Specifies whether logical block protection is used to ensure the integrity of data stored on tape. When LBPROTECT is set to READWRITE or to WRITEONLY, the server uses this feature of the tape drive for logical block protection and generates cyclic redundancy check (CRC) protection information for each data block written on tape. The server also validates the CRC protection information when data is read from the tape.

The default is NO.

The following values are possible:

READWRITE

Specifies that logical block protection is enabled in the server and the tape drive for both read and write operations. Data is stored with CRC information in each block. This mode affects performance because additional processor usage is required for IBM Spectrum Protect™ and the tape drive to calculate and compare CRC values. The READWRITE value does not affect backup sets and data that is generated by the BACKUP DB command.

When the LBPROTECT parameter is set to READWRITE, you do not have to specify the CRCDATA parameter in a storage pool definition because logical block protection provides better protection against data corruption.

WRITEONLY

Specifies that logical block protection is enabled in the server and the tape drive for write operations only. Data is stored containing CRC information in each block. For read operations, the server and the tape drive do not validate the CRC. This mode affects performance because additional processor usage is required for IBM Spectrum Protect to generate the CRC and for the tape drive to calculate and compare CRC values for write operations. The WRITEONLY value does not affect backup sets and data that are generated by the BACKUP DB command.

No

Specifies that logical block protection is not enabled in the server and the tape drive for read and write operations. However, the server enables logical block protection on write operations for a filling volume that already has data with logical block protection.

Restriction: Logical block protection is supported only on Oracle StorageTek T10000C and Oracle StorageTek T10000D drives.

WORM

Specifies whether the drives use WORM (write once, read many) media. This parameter is optional. The default is No. The field can contain one of the following values:

Yes

Specifies that the drives use WORM media.

No

Specifies that the drives do not use WORM media.

Restriction: If you select Yes, the only options that are available for the FORMAT parameter are:

- DRIVE
- T9840C
- T9840C-C

- T9840D
- T9840D-C
- T10000A
- T10000A-C
- T10000B
- T10000B-C
- T10000C
- T10000C-C
- T10000D
- T10000D-C

## FORMAT

Specifies the recording format to be used when data is written to sequential access media. This parameter is optional. The default value is DRIVE.

If the drives are in a library that includes drives of different tape technology, do not use the DRIVE value. Use the specific format that the drives use.

Important: If you specify DRIVE for a device class that has non-compatible sequential access devices, then you must mount volumes on devices that are capable of reading or writing the format that is established when the volume was first mounted. This can cause delays if the only sequential access device that can access the volume is already in use.

The following table lists the recording formats and estimated capacities for ECARTRIDGE devices:

Table 1. Recording formats and default estimated capacities for ECARTRIDGE tapes

Format	Estimated capacity	Description
DRIVE	–	The server selects the highest format that is supported by the drive on which a volume is mounted. Attention: Avoid specifying DRIVE when a mixture of drives is used within the same library. For example, do not use this option for a library that contains some drives that support recording formats superior to other drives.
T9840C	40 GB	Uncompressed T9840C format, using a StorageTek 9840 cartridge
T9840C-C	80 GB	Compressed T9840C format, using a StorageTek 9840 cartridge
T9840D	75 GB	Uncompressed T9840D format, using a StorageTek 9840 cartridge
T9840D-C	150 GB	Compressed T9840D format, using a StorageTek 9840 cartridge
T10000A	500 GB	Uncompressed T10000A format, using a StorageTek T10000 cartridge
T10000A-C	1 TB	Compressed T10000A format, using a StorageTek T10000 cartridge
T10000B	1 TB	Uncompressed T10000B format, using an Oracle StorageTek T10000 cartridge
T10000B-C	2 TB	Compressed T10000B format, using an Oracle StorageTek T10000 cartridge
T10000C	5 TB	Uncompressed T10000C format, using an Oracle StorageTek T10000 T2 cartridge
T10000C-C	10 TB	Compressed T10000C format, using an Oracle StorageTek T10000 T2 cartridge
T10000D	8 TB	Uncompressed T10000D format, using an Oracle StorageTek T10000 T2 cartridge
T10000D-C	15 TB	Compressed T10000D format, using an Oracle StorageTek T10000 T2 cartridge



Format	Estimated capacity	Description
Notes:		
<ul style="list-style-type: none"> <li>Some formats use a tape drive hardware compression feature. Depending on the effectiveness of compression, the actual capacity might be double or more than the listed value.</li> <li>T10000A drives can read and write the T10000A format only. T10000B drives can read, but cannot write, the T10000A format. T10000C drives can read, but cannot write, the T10000A and T10000B formats. T10000D drives can read, but cannot write, the T10000A, T10000B, and T10000C formats.</li> </ul>		

#### ESTCAPacity

Specifies the estimated capacity for the volumes that are assigned to this device class. This parameter is optional.

You can specify this parameter if the default estimated capacity for the device class is inaccurate due to compression of data.

You must specify this value as an integer followed by one of the following unit indicators: **K** (kilobytes), **M** (megabytes), **G** (gigabytes), or **T** (terabytes). The smallest value that is accepted is 1 MB (ESTCAPACITY=1M).

For example, specify that the estimated capacity is 9 GB with the parameter ESTCAPACITY=9G.

#### PREFIX

Specifies the high-level qualifier of the data set name that the server writes into the sequential access media labels. For each sequential access volume assigned to this device class, the server uses this prefix to create the data set name. This parameter is optional. The default value is ADMS. The maximum length of this prefix is 8 characters.

If you have a naming convention for media labels to support your current management system, use a volume prefix that conforms to your naming conventions.

Values that are specified for this parameter must meet the following conditions:

- The value is to be made up of qualifiers, which can be a maximum of eight characters including periods. For example, the following value is acceptable:

AB.CD2.E

- The qualifiers must be separated by a single period.
- The first letter of each qualifier must be alphabetic or national (@,#,\$), followed by alphabetic, national, hyphen, or numeric characters.

An example of a tape volume data set name using the default prefix is ADMS.BFS.

#### MOUNTRetention

Specifies the number of minutes that an idle sequential access volume is retained before it is dismounted. This parameter is optional. The default value is 60 minutes. You can specify a number 0 - 9999.

This parameter can improve response time for sequential access media mounts by leaving previously mounted volumes online.

However, for EXTERNAL library types (that is, a library that is managed by an external media management system), set this parameter to a low value (for example, two minutes) to enhance device sharing between applications.

Note: For environments in which devices are shared across storage applications, the MOUNTRETENTION setting must be carefully considered. This parameter determines how long an idle volume remains in a drive. Some media managers do not dismount an allocated drive to satisfy pending requests. You might need to tune this parameter to satisfy competing mount requests while maintaining optimal system performance. Typically, problems arise more frequently when the MOUNTRETENTION parameter is set to a value that is too small, for example, zero.

#### MOUNTWait

Specifies the maximum number of minutes the server waits for an operator to respond to a request to either mount a volume in a drive in a manual library or check in a volume to be mounted in an automated library. This parameter is optional. If the mount request is not satisfied within the specified amount of time, the mount request is canceled. The default value is 60 minutes. You can specify a number 0 - 9999.

Restriction: If the library that is associated with this device class is external (LIBTYPE=EXTERNAL), do not specify the MOUNTWAIT parameter.

#### MOUNTLimit

Specifies the maximum number of sequential access volumes that can be simultaneously mounted for the device class. This parameter is optional. The default is DRIVES. You can specify a number 0 - 4096.

If you plan to use the simultaneous-write function, ensure that sufficient drives are available for the write operation. If the number of drives needed for a simultaneous-write operation is greater than the value of the MOUNTLIMIT parameter for a device class, the transaction fails.

The following are possible values:

#### DRIVES

Specifies that every time a mount point is allocated, the number of drives that are defined and online in the library is used to calculate the true value.

Note: For EXTERNAL library types, do not specify DRIVES for the MOUNTLIMIT value. Specify the number of drives for the library as the MOUNTLIMIT value.

#### number

Specifies the maximum number of drives in this device class that are used concurrently by the server. This value must never exceed the number of drives that are defined and online in the library that services this device class.

#### 0 (zero)

Specifies that no new transactions can gain access to the storage pool. Any current transactions continue and complete, but new transactions are terminated.

#### DRIVEEncryption

Specifies whether drive encryption is allowed. This parameter is optional. The default is ALLOW.

Restrictions:

1. You can use drive encryption only for the following drives:
  - o Oracle StorageTek T10000B drives that have a format value of DRIVE, T10000B, or T10000B-C
  - o Oracle StorageTek T10000C drives that have a format value of DRIVE, T10000C, or T10000C-C
  - o Oracle StorageTek T10000D drives that have a format value of DRIVE, T10000D, or T10000D-C
2. You cannot specify IBM Spectrum Protect as the key manager for drive encryption of write once, read many (WORM) media. You cannot specify both WORM=Yes and DRIVEENCRYPTION=ON.
3. If encryption is enabled for a device class, and the device class is associated with a storage pool, the storage pool should not share a scratch pool with other device classes that cannot be encrypted. If a tape is encrypted, and you plan to use it on a drive that cannot be encrypted, you must manually relabel the tape before it can be used on that drive.

#### ON

Specifies that IBM Spectrum Protect is the key manager for drive encryption and allows drive encryption for empty storage pool volumes only if the application method is enabled. (Other types of volumes are not encrypted. For example, back up sets, export volumes, and database backup volumes are not encrypted.) If you specify ON and you enable another method of encryption, drive encryption is not allowed and backup operations fail.

#### ALLOW

Specifies that IBM Spectrum Protect does not manage the keys for drive encryption. However, drive encryption for empty volumes is allowed if another method of encryption is enabled.

#### EXtErnal

Specifies that IBM Spectrum Protect does not manage the keys for drive encryption. Use this setting with an encryption methodology that is provided by another vendor and that is used with Application Method Encryption (AME) enabled on the drive. When you specify EXTERNAL and IBM Spectrum Protect detects that AME encryption is enabled, IBM Spectrum Protect does not turn off encryption. By contrast, when you specify ALLOW and IBM Spectrum Protect detects that AME encryption is enabled, IBM Spectrum Protect turns off encryption.

#### OFF

Specifies that drive encryption is not allowed. If you enable another method of encryption, backups fail. If you enable the application method, IBM Spectrum Protect disables encryption and backups are attempted.

## DEFINE DEVCLASS (Define a FILE device class)

---

Use the FILE device class when you are using files on magnetic disk storage as volumes that store data sequentially (as on tape).

**AIX** | **Linux** The FILE device class does not support EXTERNAL libraries.

**Windows** The FILE device class does not support EXTERNAL or Remote Storage Manager libraries.

**AIX** | **Linux** If you are defining a device class for devices that are to be accessed through a z/OS® media server, see DEFINE DEVCLASS (Define a FILE device class for z/OS media server).

## Privilege class

To issue this command, you must have system privilege or unrestricted storage privilege.

## Syntax

```
>>-DEfINE DEVclass--device_class_name--DEVType====FILE----->
    .-MOUNTLimit-----20----- .-MAXCAPacity====10G--.
>+-----+-----+-----+-----+-----+----->
    '-MOUNTLimit-----number-' '-MAXCAPacity-----size-'

    .-DIRectory-----current_directory_name-.
>+-----+-----+-----+-----+-----+----->
    |                                     |
    |          .-,----- .              |
    |          v                          |
    |                                     |
    '-DIRectory-----directory_name-+-----'

    .-SHARed-----No----- .
>+-----+-----+-----+-----+-----+----->>
    '-SHARed-----+No--+-'
    '-Yes-'
```

## Parameters

**device\_class\_name** (Required)

Specifies the name of the device class to be defined. The maximum length of the device class name is 30 characters.

**DEVType=FILE** (Required)

Specifies that the FILE device type is assigned to the device class. FILE indicates that a file is assigned to this device class. When the server must access a volume that belongs to this device class, it opens a file and reads or writes file data.

A file is a form of sequential-access media.

**MOUNTLimit**

Specifies the maximum number of files that can be simultaneously open for input and output. This parameter is optional. The default value is 20. You can specify a number from 0 to 4096.

**Windows** If the device class is shared with a storage agent (by specifying the SHARED=YES parameter), drives are defined or deleted to match the mount limit value.

If you plan to use the simultaneous-write function, ensure that sufficient drives are available for the write operation. If the number of drives needed for a simultaneous-write operation is greater than the value of the MOUNTLIMIT parameter for a device class, the transaction fails.

**MAXCAPacity**

Specifies the maximum size of any data storage files that are defined to a storage pool in this device class.

The value of the MAXCAPACITY parameter is also used as the unit of allocation when storage pool space triggers create volumes. The default value is 10 GB (MAXCAPACITY=10G). The value that is specified must be less than or equal to the maximum supported size of a file on the target file system.

Specify this value as an integer followed by **K** (kilobytes), **M** (megabytes), **G** (gigabytes), or **T** (terabytes). The minimum size is 1 MB (MAXCAPACITY=1M). If you are defining a FILE device class for database-backup volumes, specify a value for MAXCAPACITY that is appropriate for the size of the database and that minimizes the number of database volumes.

**AIX** | **Linux** Do not define a MAXCAPACITY value greater than 640M when this file is for REMOVABLEFILE CD support. A value less than a CD's usable space (650 MB) enables a one-to-one match between files from the FILE device class and copies that are on CD.

**DIRectory**

Specifies the directory location or locations of the files that are used in this device class. Enclose the entire list of directories within quotation marks, and use commas to separate individual directory names. Special characters (for

example, blank spaces) are allowed within directory names. For example, the directory list "abc def,xyz" contains two directories: abc def and xyz.

This parameter is optional.

**AIX Linux** The default is the current working directory of the server at the time the command is issued.

**Windows** The default is the current working directory of the server at the time the command is issued. Windows registry information is used to determine the default directory.

By specifying a directory name or names, you identify the location where the server places the files that represent storage volumes for this device class.

For NetApp SnapLock support (storage pools with RECLAMATIONTYPE=SNAPLOCK, which are going to use this device class), the directory, or directories that are specified with DIRECTORY parameter must point to the directory or directories on the NetApp SnapLock volumes.

**AIX Linux** While the command is processed, the server expands the specified directory name or names into their fully qualified forms, starting from the root directory.

If the server must allocate a scratch volume, it creates a new file in one of these directories. (The server can choose any of the directories in which to create new scratch volumes.) For scratch volumes used to store client data, the file that is created by the server has a file name extension of .bfs. For scratch volumes used to store export data, a file name extension of .exp is used.

**AIX Linux** For example, if you define a device class with a directory of tsmstor and the server needs a scratch volume in this device class to store export data, the file that the server creates might be named tsmstor/00566497.exp.

**Windows** For example, if you define a device class with a directory of c:\server and the server needs a scratch volume in this device class to store export data, the file that the server creates might be named c:\server\00566497.exp.

Important: You must ensure that storage agents can access newly created FILE volumes. Failure of the storage agent to access a FILE volume can cause operations to be retried on a LAN-only path or to fail. For more information, see the description of the DIRECTORY parameter in DEFINE PATH (Define a path).

Tip: If you specify multiple directories for a device class, ensure that the directories are associated with separate file systems. Space trigger functions and storage pool space calculations take into account the space that remains in each directory. If you specify multiple directories for a device class and the directories are in the same file system, the server calculates space by adding values that represent the space that remains in each directory. These space calculations are inaccurate. Rather than choosing a storage pool with sufficient space for an operation, the server might choose the wrong storage pool and run out of space prematurely. For space triggers, an inaccurate calculation might result in a failure to expand the space available in a storage pool. Failure to expand space in a storage pool is one of the conditions that can cause a trigger to become disabled. If a trigger is disabled because the space in a storage pool could not be expanded, you can re-enable the trigger by issuing the following command: `update spacetrigger stg`. No further changes are required to the space trigger.

#### SHARED

Specifies that this FILE device class is shared between the server and one or more storage agents. To prepare for sharing, a library is automatically defined along with a number of drives corresponding to the MOUNTLIMIT parameter value. The drive names are the name of the library plus a number from 1 to the mount limit number. For example, if the library name is FILE and the mount limit is set to 4, the drives are named FILE11, FILE12, FILE13, FILE14.

For information about prerequisites when storage is shared by the server and storage agent, see IBM® Support Portal for IBM Spectrum Protect™.

## Example: Define a FILE device class with multiple directories

Define a device class that specifies multiple directories.

**AIX**

```
define devclass multidir devtype=file
  directory=/usr/xyz,/usr/abc,/usr/uvw
```

**Linux**

```
define devclass multidir devtype=file
  directory=/opt/xyz,/opt/abc,/opt/uvw
```

```
define devclass multidir devtype=file
    directory=e:\xyz,f:\abc,g:\uvw
```

## Example: Define a FILE device class with a 50 MB capacity

Define a device class named PLAINFILES with a FILE device type and a maximum capacity of 50 MB.

```
define devclass plainfiles devtype=file
maxcapacity=50m
```

## DEFINE DEVCLASS (Define a GENERICTAPE device class)

Use the GENERICTAPE device class for tape drives that are supported by operating system device drivers.

When you use this device type, the server does not recognize either the type of device or the cartridge recording format. Because the server does not recognize the type of device, if an I/O error occurs, error information is less detailed compared to error information for a specific device type (for example, 8MM). When you define devices to the server, do not mix various types of devices within the same device type.

### Privilege class

To issue this command, you must have system privilege or unrestricted storage privilege.

### Syntax

```
>>-DEFine DEVclass--device_class_name----->>
>>-LIBRARY-----library_name--DEVType-----GENERICTape----->
      .-MOUNTRetention-----60-----.
>>+-----+-----+-----+-----+----->
  '-ESTCAPacity-----size-' '-MOUNTRetention-----minutes-'
      .-MOUNTWait-----60-----.   .-MOUNTLimit-----DRIVES-----.
>>+-----+-----+-----+-----+----->>
  '-MOUNTWait-----minutes-' '-MOUNTLimit-----+DRIVES++-'
                                     +-number+
                                     '-0-----'
```

### Parameters

**device\_class\_name** (Required)

Specifies the name of the device class to be defined. The maximum length of the device class name is 30 characters.

**LIBRARY** (Required)

Specifies the name of the defined library object that contains the tape drives that can be used by this device class.

For information about defining a library object, see the DEFINE LIBRARY command.

**DEVType=GENERICTape** (Required)

Specifies that the GENERICTAPE device type is assigned to the device class. GENERICTAPE indicates that the volumes for this device class are used in tape drives that are supported by the operating system's tape device driver.

The server recognizes that the media can be removed and that more media can be inserted, subject to limits set with the MOUNTLIMIT parameter for the device class and the MAXSCRATCH parameter for the storage pool.

Volumes in a device class with device type GENERICTAPE are sequential access volumes.

**ESTCAPacity**

Specifies the estimated capacity for the volumes that are assigned to this device class. This parameter is optional.

You can specify this parameter if the default estimated capacity for the device class is inaccurate due to compression of data.

Specify a capacity appropriate to the particular tape drive that is being used.

You must specify this value as an integer followed by one of the following unit indicators: **K** (kilobytes), **M** (megabytes), **G** (gigabytes), or **T** (terabytes). The smallest value that is accepted is 1 MB (ESTCAPACITY=1M).

For example, specify that the estimated capacity is 9 GB with the parameter ESTCAPACITY=9G.

#### **MOUNTRetention**

Specifies the number of minutes that an idle sequential access volume is retained before it is dismounted. This parameter is optional. The default value is 60 minutes. You can specify a number 0 - 9999.

This parameter can improve response time for sequential access media mounts by leaving previously mounted volumes online.

However, for EXTERNAL library types, setting this parameter to a low value (for example, two minutes) enhances device sharing between applications.

**Note:** For environments in which devices are shared across storage applications, the MOUNTRETENTION setting must be carefully considered. This parameter determines how long an idle volume remains in a drive. Some media managers do not dismount an allocated drive to satisfy pending requests. You might need to tune this parameter to satisfy competing mount requests while maintaining optimal system performance. Typically, problems arise more frequently when the MOUNTRETENTION parameter is set to a value that is too small, for example, zero.

#### **MOUNTWait**

Specifies the maximum number of minutes the server waits for an operator to respond to a request to either mount a volume in a drive in a manual library or check in a volume to be mounted in an automated library. This parameter is optional. If the mount request is not satisfied within the specified amount of time, the mount request is canceled. The default value is 60 minutes. You can specify a number 0 - 9999.

**Restriction:** If the library that is associated with this device class is external (LIBTYPE=EXTERNAL), do not specify the MOUNTWAIT parameter.

#### **MOUNTLimit**

Specifies the maximum number of sequential access volumes that can be simultaneously mounted for the device class. This parameter is optional. The default is DRIVES. You can specify a number 0 - 4096.

If you plan to use the simultaneous-write function, ensure that sufficient drives are available for the write operation. If the number of drives needed for a simultaneous-write operation is greater than the value of the MOUNTLIMIT parameter for a device class, the transaction fails.

The following are possible values:

##### **DRIVES**

Specifies that every time a mount point is allocated, the number of drives that are defined and online in the library is used to calculate the true value.

**Note:** For EXTERNAL library types, do not specify DRIVES for the MOUNTLIMIT value. Specify the number of drives for the library as the MOUNTLIMIT value.

##### **number**

Specifies the maximum number of drives in this device class that are used concurrently by the server. This value must never exceed the number of drives that are defined and online in the library that services this device class.

##### **0 (zero)**

Specifies that no new transactions can gain access to the storage pool. Any current transactions continue and complete, but new transactions are terminated.

## **DEFINE DEVCLASS (Define an LTO device class)**

---

Use the LTO device class when you are using LTO tape devices.

### **Privilege class**

---

To issue this command, you must have system privilege or unrestricted storage privilege.

### **Syntax**

---

```

>>-DEFine DEVclass--device_class_name----->
>>-LIBRary----library_name--DEVType-----LTO----->
(1)
.-LBProtect---No----- .-WORM---No-----
>--+-----+-----+-----+----->
'-LBProtect---+READWrite--' '-WORM---+No---'
      +-WRITEOnly+          '-Yes-'
      '-No-----'

.-FORMAT---DRIVE-----
>--+-----+-----+-----+----->
'-FORMAT---+DRIVE---+' '-ESTCAPacity---size-'
      +-ULTRIUM---+
      +-ULTRIUMC--+
      +-ULTRIUM2--+
      +-ULTRIUM2C+
      +-ULTRIUM3--+
      +-ULTRIUM3C+
      +-ULTRIUM4--+
      +-ULTRIUM4C+
      +-ULTRIUM5--+
      +-ULTRIUM5C+
      +-ULTRIUM6--+
      '-ULTRIUM6C-'

.-PREFIX---ADSM-----
>--+-----+-----+-----+----->
'-PREFIX---+ADSM-----+'
      '-tape_volume_prefix-'

.-MOUNTRetention---60----- .-MOUNTWait---60-----
>--+-----+-----+-----+----->
'-MOUNTRetention---minutes-' '-MOUNTWait---minutes-'

.-MOUNTLimit---DRIVES-----
>--+-----+-----+-----+----->
'-MOUNTLimit---+DRIVES--+'
      +-number+
      '-0-----'

(1) (2)
.-DRIVEEncryption---ALLOW-----
>--+-----+-----+-----+-----><
'-DRIVEEncryption---+ON-----+'
      +-ALLOW-----+
      +-EXTERNAL+
      '-OFF-----'

```

#### Notes:

1. You cannot specify both WORM=Yes and DRIVEENCRYPTION=ON.
2. Drive encryption is supported only for Ultrium 4, Ultrium 5, and Ultrium 6 drives and media.

## Parameters

### device\_class\_name (Required)

Specifies the name of the device class to be defined. The maximum length of the device class name is 30 characters.

### LIBRary (Required)

Specifies the name of the defined library object that contains the LTO tape drives used by this device class. For information about defining a library object, see the DEFINE LIBRARY command.

### DEVType=LTO (Required)

Specifies that the linear tape open (LTO) device type is assigned to the device class.

### LBProtect

Specifies whether logical block protection is used to ensure the integrity of data stored on tape. When LBPROTECT is set to READWRITE or to WRITEONLY, the server uses this feature of the tape drive for logical block protection and generates

cyclic redundancy check (CRC) protection information for each data block written on tape. The server also validates the CRC protection information when data is read from the tape.

The default is NO.

The following values are possible:

**READWrite**

Specifies that logical block protection is enabled in the server and the tape drive for both read and write operations. Data is stored with CRC information in each block. This mode affects performance because additional processor usage is required for IBM Spectrum Protect™ and the tape drive to calculate and compare CRC values. The READWRITE value does not affect backup sets and data that is generated by the BACKUP DB command.

When the LBPROTECT parameter is set to READWRITE, you do not have to specify the CRCDATA parameter in a storage pool definition because logical block protection provides better protection against data corruption.

**WRITEOnly**

Specifies that logical block protection is enabled in the server and the tape drive for write operations only. Data is stored containing CRC information in each block. For read operations, the server and the tape drive do not validate the CRC. This mode affects performance because additional processor usage is required for IBM Spectrum Protect to generate the CRC and for the tape drive to calculate and compare CRC values for write operations. The WRITEONLY value does not affect backup sets and data that are generated by the BACKUP DB command.

**No**

Specifies that logical block protection is not enabled in the server and the tape drive for read and write operations. However, the server enables logical block protection on write operations for a filling volume that already has data with logical block protection.

Restriction: Logical block protection is supported only on IBM® LTO5 and supported LTO6 drives.

**WORM**

Specifies whether the drives use WORM (write once, read many) media. This parameter is optional. The default is No. The field can contain one of the following values:

**Yes**

Specifies that the drives use WORM media.

**No**

Specifies that the drives do not use WORM media.

**Note:**

1. To use WORM media in a library, all the drives in the library must be WORM capable.
2. You cannot specify IBM Spectrum Protect as the key manager for drive encryption of WORM (write once, read many) media. (Specifying both WORM=Yes and DRIVEENCRYPTION=ON is not supported.)

**FORMAT**

Specifies the recording format to be used when data is written to sequential access media. This parameter is optional. The default value is DRIVE.

If the drives are in a library that includes drives of different tape technology, do not use the DRIVE value. Use the specific format that the drives use.

When migrating all drives from Ultrium to Ultrium 2 devices:

- Delete all existing Ultrium drive definitions and the paths that are associated with them.
- Define the new Ultrium 2 drives and paths.

If you are considering mixing different generations of LTO media and drives, be aware of the following restrictions.

**Table 1. Read - write capabilities for different generations of LTO drives**

<b>Drives</b>	<b>Generation 1 media</b>	<b>Generation 2 media</b>	<b>Generation 3 media</b>	<b>Generation 4 media</b>	<b>Generation 5 media</b>	<b>Generation 6 media</b>
Generation 1	Read and write	n/a	n/a	n/a	n/a	n/a
Generation 2	Read and write	Read and write	n/a	n/a	n/a	n/a
Generation 3 <sup>1</sup>	Read only	Read and write	Read and write	n/a	n/a	n/a



Drives	Generation 1 media	Generation 2 media	Generation 3 media	Generation 4 media	Generation 5 media	Generation 6 media
Generation 4 <sup>2</sup>	n/a	Read only	Read and write	Read and write	n/a	n/a
Generation 5 <sup>3</sup>	n/a	n/a	Read only	Read and write	Read and write	n/a
Generation 6 <sup>4</sup>	n/a	n/a	n/a	Read only	Read and write	Read and write

<sup>1</sup> In a library with a Generation 3 drive, all Generation 1 scratch volumes must be checked out, and all Generation 1 storage pool volumes must be updated to read-only.

<sup>2</sup> In a library with a Generation 4 drive, all Generation 2 scratch volumes must be checked out, and all Generation 2 storage pool volumes must be updated to read-only.

<sup>3</sup> In a library with a Generation 5 drive, all Generation 3 scratch volumes must be checked out, and all Generation 3 storage pool volumes must be updated to read-only.

<sup>4</sup> In a library with a Generation 6 drive, all Generation 4 scratch volumes must be checked out, and all Generation 4 storage pool volumes must be updated to read-only.

The following table lists the recording formats and estimated capacities for LTO devices:

Table 2. Recording format and default estimated capacity for LTO

Format	Estimated capacity	Description
DRIVE	–	The server selects the highest format that is supported by the drive on which a volume is mounted. Attention: Avoid specifying DRIVE when a mixture of drives is used within the same library. For example, do not use this option for a library that contains some drives that support recording formats superior to other drives.
ULTRIUM	100 GB	Uncompressed format, using Ultrium cartridges
ULTRIUMC	See note 200 GB	Compressed format, using Ultrium cartridges
ULTRIUM2	200 GB	Uncompressed (standard) format, using Ultrium 2 cartridges
ULTRIUM2C	See note 400 GB	Compressed format, using Ultrium 2 cartridges
ULTRIUM3	400 GB	Uncompressed (standard) format, using Ultrium 3 cartridges
ULTRIUM3C	See note 800 GB	Compressed format, using Ultrium 3 cartridges
ULTRIUM4	800 GB	Uncompressed (standard) format, using Ultrium 4 cartridges
ULTRIUM4C	See note 1.6 TB	Compressed format, using Ultrium 4 cartridges
ULTRIUM5	1.5 TB	Uncompressed (standard) format, using Ultrium 5 cartridges
ULTRIUM5C	See note 3.0 TB	Compressed format, using Ultrium 5 cartridges
ULTRIUM6	2.5 TB	Uncompressed (standard) format, using Ultrium 6 cartridges
ULTRIUM6C	See note 6.25 TB	Compressed format, using Ultrium 6 cartridges

Note: If this format uses the tape-drive hardware-compression feature, depending on the effectiveness of compression, the actual capacity might be greater than the listed value.

#### ESTCAPacity

Specifies the estimated capacity for the volumes that are assigned to this device class. This parameter is optional.

You can specify this parameter if the default estimated capacity for the device class is inaccurate due to compression of data.

You must specify this value as an integer followed by one of the following unit indicators: **K** (kilobytes), **M** (megabytes), **G** (gigabytes), or **T** (terabytes). The smallest value that is accepted is 1 MB (ESTCAPACITY=1M).

For example, specify that the estimated capacity is 9 GB with the parameter ESTCAPACITY=9G.

For more information about estimated capacities, see Table 2.

#### PREFIX

Specifies the high-level qualifier of the data set name that the server writes into the sequential access media labels. For each sequential access volume assigned to this device class, the server uses this prefix to create the data set name. This parameter is optional. The default value is ADSM. The maximum length of this prefix is 8 characters.

If you have a naming convention for media labels to support your current management system, use a volume prefix that conforms to your naming conventions.

Values that are specified for this parameter must meet the following conditions:

- The value is to be made up of qualifiers, which can be a maximum of eight characters including periods. For example, the following value is acceptable:

AB.CD2.E

- The qualifiers must be separated by a single period.
- The first letter of each qualifier must be alphabetic or national (@,#,\$), followed by alphabetic, national, hyphen, or numeric characters.

An example of a tape volume data set name using the default prefix is ADSM.BFS.

#### MOUNTRetention

Specifies the number of minutes that an idle sequential access volume is retained before it is dismounted. This parameter is optional. The default value is 60 minutes. You can specify a number 0 - 9999.

This parameter can improve response time for sequential access media mounts by leaving previously mounted volumes online.

However, for EXTERNAL library types, setting this parameter to a low value (for example, two minutes) enhances device sharing between applications.

Note: For environments in which devices are shared across storage applications, the MOUNTRETENTION setting must be carefully considered. This parameter determines how long an idle volume remains in a drive. Some media managers do not dismount an allocated drive to satisfy pending requests. You might need to tune this parameter to satisfy competing mount requests while maintaining optimal system performance. Typically, problems arise more frequently when the MOUNTRETENTION parameter is set to a value that is too small, for example, zero.

#### MOUNTWait

Specifies the maximum number of minutes the server waits for an operator to respond to a request to either mount a volume in a drive in a manual library or check in a volume to be mounted in an automated library. This parameter is optional. If the mount request is not satisfied within the specified amount of time, the mount request is canceled. The default value is 60 minutes. You can specify a number 0 - 9999.

Restriction: If the library that is associated with this device class is external (LIBTYPE=EXTERNAL), do not specify the MOUNTWAIT parameter.

#### MOUNTLimit

Specifies the maximum number of sequential access volumes that can be simultaneously mounted for the device class. This parameter is optional. The default is DRIVES. You can specify a number 0 - 4096.

If you plan to use the simultaneous-write function, ensure that sufficient drives are available for the write operation. If the number of drives needed for a simultaneous-write operation is greater than the value of the MOUNTLIMIT parameter for a device class, the transaction fails.

The following are possible values:

#### DRIVES

Specifies that every time a mount point is allocated, the number of drives that are defined and online in the library is used to calculate the true value.

Note: For EXTERNAL library types, do not specify DRIVES for the MOUNTLIMIT value. Specify the number of drives for the library as the MOUNTLIMIT value.

number

Specifies the maximum number of drives in this device class that are used concurrently by the server. This value must never exceed the number of drives that are defined and online in the library that services this device class.

0 (zero)

Specifies that no new transactions can gain access to the storage pool. Any current transactions continue and complete, but new transactions are terminated.

DRIVEEncryption

Specifies whether drive encryption is allowed. This parameter is optional. The default is ALLOW. Drive encryption is supported only for Ultrium 4, Ultrium 5, and Ultrium 6 drives and media.

Restriction: If encryption is enabled for a device class, and the device class is associated with a storage pool, the storage pool should not share a scratch pool with other device classes that cannot be encrypted. If a tape is encrypted, and you plan to use it on a drive that cannot be encrypted, you must manually relabel the tape before it can be used on that drive.

ON

Specifies that IBM Spectrum Protect is the key manager for drive encryption and allows drive encryption for empty storage pool volumes only if the application method is enabled. (Other types of volumes are not encrypted. For example, back up sets, export volumes, and database backup volumes are not encrypted.) If you specify ON and you enable another method of encryption, drive encryption is not allowed and backup operations fail.

Note: You cannot specify IBM Spectrum Protect as the key manager for drive encryption of WORM (write once, read many) media. (Specifying both WORM=Yes and DRIVEENCRYPTION=ON is not supported.)

ALLOW

Specifies that IBM Spectrum Protect does not manage the keys for drive encryption. However, drive encryption for empty volumes is allowed if another method of encryption is enabled.

EXTERNAL

Specifies that IBM Spectrum Protect does not manage the keys for drive encryption. Use this setting with an encryption methodology that is provided by another vendor and that is used with Application Method Encryption (AME) enabled on the drive. When you specify EXTERNAL and IBM Spectrum Protect detects that AME encryption is enabled, IBM Spectrum Protect does not turn off encryption. By contrast, when you specify ALLOW and IBM Spectrum Protect detects that AME encryption is enabled, IBM Spectrum Protect turns off encryption.

OFF

Specifies that drive encryption is not allowed. If you enable another method of encryption, backups fail. If you enable the application method, IBM Spectrum Protect disables encryption and backups are attempted.

## Example: Define an LTO device class

---

Define a device class that is named LTOTAPE for an LTO drive in a library named LTOLIB. The format is ULTRIUM, mount limit is 12, mount retention is 5, tape volume prefix is named SMVOL, and the estimated capacity is 100 GB.

```
define devclass ltotape devtype=lto library=ltolib
format=ultrium mountlimit=12 mountretention=5
prefix=smvol estcapacity=100G
```

## DEFINE DEVCLASS (Define a NAS device class)

---

Use the NAS device class when you are using NDMP (Network Data Management Protocol) operations to back up network-attached storage (NAS) file servers. The device class is for drives that are supported by the NAS file server for backups.

**AIX** | **Linux** The NAS device class does not support EXTERNAL libraries.

**Windows** The NAS device class does not support EXTERNAL or Remote Storage Manager libraries.

## Privilege class

---

To issue this command, you must have system privilege or unrestricted storage privilege.

## Syntax

---

```
>>-DEFine DEVclass--device_class_name--DEVType----NAS----->
```

```

>--LIBRARY----library_name--MOUNTRetention----0----->

.-MOUNTWait----60-----.-MOUNTLimit----DRIVES-----
>--+-----+-----+-----+-----+-----+----->
'-MOUNTWait----minutes-' '-MOUNTLimit----+DRIVES+-'
                                     +-number+
                                     '-0-----'

>--ESTCAPacity----size----->

.-PREFIX----ADSM-----
>--+-----+-----+-----+-----+----->>
'-PREFIX----+ADSM-----+-'
      '-tape_volume_prefix-'

```

## Parameters

### device\_class\_name (Required)

Specifies the name of the device class to be defined. The maximum length of the device class name is 30 characters.

### DEVType=NAS (Required)

Specifies that the network-attached storage (NAS) device type is assigned to the device class. The NAS device type is for drives that are attached to and used by a NAS file server for backup of NAS file systems.

### LIBRARY (Required)

Specifies the name of the defined library object that contains the SCSI tape drives used by this device class. For information about defining a library object, see the DEFINE LIBRARY command.

### MOUNTRetention=0 (Required)

Specifies the number of minutes that an idle sequential access volume is retained before it is dismounted. Zero (0) is the only supported value for device classes with DEVType=NAS.

### MOUNTWait

Specifies the maximum number of minutes the server waits for an operator to respond to a request to either mount a volume in a drive in a manual library or check in a volume to be mounted in an automated library. This parameter is optional. If the mount request is not satisfied within the specified amount of time, the mount request is canceled. The default value is 60 minutes. You can specify a number 0 - 9999.

Restriction: If the library that is associated with this device class is external (LIBTYPE=EXTERNAL), do not specify the MOUNTWAIT parameter.

### MOUNTLimit

Specifies the maximum number of sequential access volumes that can be simultaneously mounted for the device class. This parameter is optional. The default is DRIVES. You can specify a number 0 - 4096.

If you plan to use the simultaneous-write function, ensure that sufficient drives are available for the write operation. If the number of drives needed for a simultaneous-write operation is greater than the value of the MOUNTLIMIT parameter for a device class, the transaction fails.

The following are possible values:

#### DRIVES

Specifies that every time a mount point is allocated, the number of drives that are defined and online in the library is used to calculate the true value.

Note: For EXTERNAL library types, do not specify DRIVES for the MOUNTLIMIT value. Specify the number of drives for the library as the MOUNTLIMIT value.

#### number

Specifies the maximum number of drives in this device class that are used concurrently by the server. This value must never exceed the number of drives that are defined and online in the library that services this device class.

#### 0 (zero)

Specifies that no new transactions can gain access to the storage pool. Any current transactions continue and complete, but new transactions are terminated.

### ESTCAPacity (Required)

Specifies the estimated capacity for the volumes that are assigned to this device class.

You must specify this value as an integer followed by one of the following unit indicators: K (kilobytes), M (megabytes), G (gigabytes), or T (terabytes). The smallest value that is accepted is 1 MB (ESTCAPACITY=1M).

For example, specify that the estimated capacity is 9 GB with the parameter ESTCAPACITY=9G.

## PREFIX

Specifies the high-level qualifier of the data set name that the server writes into the sequential access media labels. For each sequential access volume assigned to this device class, the server uses this prefix to create the data set name. This parameter is optional. The default value is ADSM. The maximum length of this prefix is 8 characters.

If you have a naming convention for media labels to support your current management system, use a volume prefix that conforms to your naming conventions.

Values that are specified for this parameter must meet the following conditions:

- The value is to be made up of qualifiers, which can be a maximum of eight characters including periods. For example, the following value is acceptable:

```
AB.CD2.E
```

- The qualifiers must be separated by a single period.
- The first letter of each qualifier must be alphabetic or national (@,#,\$), followed by alphabetic, national, hyphen, or numeric characters.

An example of a tape volume data set name using the default prefix is ADSM.BFS.

## Example: Define a NAS device class

---

Define a device class that is named NASTAPE for a NAS drive in a library named NASLIB. The mount limit is DRIVES, mount retention is 0, tape volume prefix is named SMVOL, and the estimated capacity is 200 GB.

```
define devclass nastape devtype=nas library=naslib
mountretention=0 mountlimit=drives
prefix=smvol estcapacity=200G
```

## DEFINE DEVCLASS (Define a REMOVABLEFILE device class)

---

Use the REMOVABLEFILE device class for removable media devices that are attached as local, removable file systems.

## Privilege class

---

To issue this command, you must have system privilege or unrestricted storage privilege.

## Syntax

---

```
>>-DEFine DEVclass--device_class_name----->
>>-LIBRARY----library_name--DEVType----REMOVABLEfile----->
  .-MAXCAPacity----space_remaining-.
>--+-----+-----+----->
  '-MAXCAPacity----size-----'
  .-MOUNTRetention----60----- .-MOUNTWait----60-----
>--+-----+-----+----->
  '-MOUNTRetention----minutes-' '-MOUNTWait----minutes-'
  .-MOUNTLimit----DRIVES-----
>--+-----+----->>
  '-MOUNTLimit----+DRIVES+-'
      +-number-+
      '-0-----'
```

## Parameters

---

device\_class\_name (Required)

Specifies the name of the device class to be defined. The maximum length of the device class name is 30 characters.

LIBRARY (Required)

Specifies the name of the defined library object that contains the removable media drives used by this device class. For information about defining a library object, see the DEFINE LIBRARY command.

DEVType=REMOVABLEfile (Required)

Specifies that the REMOVABLEFILE device type is assigned to the device class. REMOVABLEFILE indicates that the volumes for this device class are files on local, removable media.

Volumes in a device class with device type REMOVABLEFILE are sequential access volumes.

Use the device manufacturer's utilities to format (if necessary) and label the media. The label on the media must meet the following restrictions:

- The label can have no more than 11 characters.
- The volume label and the name of the file on the volume must match exactly.
- **AIX** | **Windows** The MAXCAPACITY parameter value must be specified at less than the capacity of the media.

MAXCAPacity

Specifies the maximum size of any volumes that are defined to a storage pool categorized by this device class. This parameter is optional.

The MAXCAPACITY parameter must be set at less value than the capacity of the media. For CD media, the maximum capacity can be no greater than 650 MB.

**AIX** | **Windows** Because the server opens only one file per physical removable medium, specify a capacity that enables one file to make full use of your media capacity.

space\_remaining

The default maximum capacity is the space that remains on the media after it is first used.

size

You must specify this value as an integer followed by **K** (kilobytes), **M** (megabytes), **G** (gigabytes), or **T** (terabytes).

For example, MAXCAPACITY=5M specifies that the maximum capacity for a volume in this device class is 5 MB. The smallest value that is allowed is 1 MB (that is, MAXCAPACITY=1M).

MOUNTRetention

Specifies the number of minutes that an idle sequential access volume is retained before it is dismounted. This parameter is optional. The default value is 60 minutes. You can specify a number 0 - 9999.

This parameter can improve response time for sequential access media mounts by leaving previously mounted volumes online.

Note: For environments in which devices are shared across storage applications, the MOUNTRETENTION setting must be carefully considered. This parameter determines how long an idle volume remains in a drive. Some media managers do not dismount an allocated drive to satisfy pending requests. You might need to tune this parameter to satisfy competing mount requests while maintaining optimal system performance. Typically, problems arise more frequently when the MOUNTRETENTION parameter is set to a value that is too small, for example, zero.

MOUNTWait

Specifies the maximum number of minutes the server waits for an operator to respond to a request to either mount a volume in a drive in a manual library or check in a volume to be mounted in an automated library. This parameter is optional. If the mount request is not satisfied within the specified amount of time, the mount request is canceled. The default value is 60 minutes. You can specify a number 0 - 9999.

Restriction: If the library that is associated with this device class is external (LIBTYPE=EXTERNAL), do not specify the MOUNTWAIT parameter.

MOUNTLimit

Specifies the maximum number of sequential access volumes that can be simultaneously mounted for the device class. This parameter is optional. The default is DRIVES. You can specify a number 0 - 4096.

If you plan to use the simultaneous-write function, ensure that sufficient drives are available for the write operation. If the number of drives needed for a simultaneous-write operation is greater than the value of the MOUNTLIMIT parameter for a device class, the transaction fails.

The following are possible values:

DRIVES

Specifies that every time a mount point is allocated, the number of drives that are defined and online in the library is used to calculate the true value.

Note: For EXTERNAL library types, do not specify DRIVES for the MOUNTLIMIT value. Specify the number of drives for the library as the MOUNTLIMIT value.

number

Specifies the maximum number of drives in this device class that are used concurrently by the server. This value must never exceed the number of drives that are defined and online in the library that services this device class.

0 (zero)

Specifies that no new transactions can gain access to the storage pool. Any current transactions continue and complete, but new transactions are terminated.

## DEFINE DEVCLASS (Define a SERVER device class)

---

Use the SERVER device class to use storage volumes or files that are archived in another IBM Spectrum Protect™ server.

If data retention protection is activated with the SET ARCHIVERETENTIONPROTECTION command, you cannot define a server device class.

### Privilege class

---

To issue this command, you must have system privilege or unrestricted storage privilege.

### Syntax

---

```
>>-DEFine DEVclass--device_class_name--DEVType-----SERVER----->
                                     .-MAXCAPacity---500M-.
>--SERVERName-----server_name--+-----+----->
                                     '-MAXCAPacity---size-'

    .-MOUNTLimit---1----- .-MOUNTRetention---60-----.
>--+-----+-----+----->
    '-MOUNTLimit---number-' '-MOUNTRetention---minutes-'

    .-PREFIX---ADSM----- .
>--+-----+-----+----->
    '-PREFIX---+ADSM-----+'
                                     '-volume_prefix-'

    .-RETRYPeriod---10----- .
>--+-----+-----+----->
    '-RETRYPeriod---retry_value_(minutes)-'

    .-RETRYInterval---30----- .
>--+-----+-----+-----><
    '-RETRYInterval---retry_value_(seconds)-'
```

### Parameters

---

device\_class\_name (Required)

Specifies the name of the device class to be defined. The maximum length of the device class name is 30 characters.

DEVType=SERVER (Required)

Specifies a remote connection that supports virtual volumes.

SERVERName (Required)

Specifies the name of the server. The SERVERNAME parameter must match a defined server.

MAXCAPacity

Specifies the maximum size for objects that are created on the target server; the default for this value is 500M. This parameter is optional.

500M

Specifies that the maximum capacity is 500M (500 MB).

size

Specify this value as an integer followed by K (kilobytes), M (megabytes), G (gigabytes), or T (terabytes). The minimum value that is allowed is 1 MB (MAXCAPACITY=1M).

#### MOUNTLimit

Specifies the maximum number of simultaneous sessions between the source server and the target server. Any attempts to access more sessions than indicated by the mount limit cause the requester to wait. This parameter is optional. The default value is 1. You can specify a number 1 - 4096.

The following are possible values:

1

Specifies that only one session between the source server and the target server is allowed.

number

Specifies the number of simultaneous sessions between the source server and the target server.

#### MOUNTRetention

Specifies the number of minutes to retain an idle connection with the target server before the connection closes. This parameter is optional. The default value is 60. You can specify a number 0 - 9999.

Note: For environments in which devices are shared across storage applications, the MOUNTRETENTION setting must be carefully considered. This parameter determines how long an idle volume remains in a drive. Some media managers do not dismount an allocated drive to satisfy pending requests. You might need to tune this parameter to satisfy competing mount requests while maintaining optimal system performance. Typically, problems arise more frequently when the MOUNTRETENTION parameter is set to a value that is too small, for example, zero.

#### PREFIX

Specifies the beginning portion of the high-level archive file name on the target server. This parameter is optional. The default is ADSM. The maximum length of this prefix is 8 characters.

If you have a naming convention for media labels to support your current management system, use a volume prefix that conforms to your naming conventions.

Values that are specified for this parameter must meet the following conditions:

- The value is to be made up of qualifiers, which can be a maximum of eight characters including periods. For example, the following value is acceptable:

AB.CD2.E

- The qualifiers must be separated by a single period.
- The first letter of each qualifier must be alphabetic or national (@,#,\$), followed by alphabetic, national, hyphen, or numeric characters.

An example of a high-level archive file name that uses the default prefix is ADSM.volume1.

#### RETRYPeriod

Specifies the retry period in minutes. The retry period is the interval during which the server attempts to contact a target server if there is a suspected communications failure. This parameter is optional. You can specify a number 0 - 9999. The default value is 10 minutes.

#### RETRYInterval

Specifies the retry interval in seconds. The retry interval is how often retries are done within a specific time period. This parameter is optional. You can specify a number 1 - 9999. The default value is 30 seconds.

## DEFINE DEVCLASS (Define a VOLSAFE device class)

---

Use the VOLSAFE device type to work with StorageTek VolSafe brand media and drives. This technology uses media that cannot be overwritten. Therefore, do not use these media for short-term backups of client files, the server database, or export tapes.

Restrictions:

1. NAS-attached libraries are not supported.
2. VolSafe media and read/write media must be in separate storage pools.
3. Check in cartridges with CHECKLABEL=YES on the CHECKIN LIBVOLUME command.
4. Label cartridges with OVERWRITE=NO on the LABEL LIBVOLUME command. If VolSafe cartridges are labeled more than one time, no additional data can be written to them.

### Privilege class

---

To issue this command, you must have system privilege or unrestricted storage privilege.



## Syntax

```
>>-DEFine DEVclass--device_class_name----->
>--LIBRARY----library_name--DEVType----VOLSAFE----->
      .-FORMAT----DRIVE-----.
>--WORM----Yes--+-----+----->
      '-FORMAT----DRIVE----+'
              +-9840-----+
              +-9840-C----+
              +-T9840C----+
              +-T9840C-C--+
              +-T9840D----+
              +-T9840D-C--+
              +-T10000A----+
              +-T10000A-C--+
              +-T10000B----+
              +-T10000B-C--+
              +-T10000C----+
              +-T10000C-C--+
              +-T10000D----+
              '-T10000D-C-'

      .-MOUNTRetention----60-----.
>--+-----+-----+----->
      '-ESTCAPacity----size-' '-MOUNTRetention----minutes-'

      .-PREFIX----ADSM-----.
>--+-----+----->
      '-PREFIX----ADSM----+'
              '-volume_prefix-'

      .-MOUNTWait----60-----. .-MOUNTLimit----DRIVES-----.
>--+-----+-----+-----><
      '-MOUNTWait----minutes-' '-MOUNTLimit----DRIVES--+'
                                  +-number+
                                  '-0-----'
```

## Parameters

### device\_class\_name (Required)

Specifies the name of the device class to be defined. The maximum length of the device class name is 30 characters.

### LIBRARY (Required)

Specifies the name of the defined library object that contains the VolSafe drives that can be used by this device class. If any drives in a library are VolSafe-enabled, all drives in the library must be VolSafe-enabled. Consult your hardware documentation to enable VolSafe on the 9840 and T10000 drives.

For information about defining a library object, see DEFINE LIBRARY (Define a library).

### DEVType=VOLSAFE (Required)

Specifies that the VOLSAFE device type is assigned to the device class. The label on this type of cartridge can be overwritten one time, which IBM Spectrum Protect™ does when it writes the first block of data. Therefore, it is important to limit the use of the LABEL LIBVOLUME command to one time per volume by using the OVERWRITE=NO parameter.

### WORM

Specifies whether the drives use WORM (write once, read many) media. The parameter is required. The value must be Yes.

#### Yes

Specifies that the drives use WORM media.

### FORMAT

Specifies the recording format to be used when data is written to sequential access media. This parameter is optional. The default value is DRIVE.

Important: If you specify DRIVE for a device class that has non-compatible sequential access devices, then you must mount volumes on devices that are capable of reading or writing the format that is established when the volume was first mounted. This can cause delays if the only sequential access device that can access the volume is already in use.

The following table lists the recording formats and estimated capacities for VolSafe devices:

Table 1. Recording formats and default estimated capacities for Volsafe media

Format	Estimated Capacity	Description
DRIVE	–	The server selects the highest format that is supported by the drive on which a volume is mounted. Attention: Avoid specifying DRIVE when a mixture of drives is used within the same library. For example, do not use this option for a library that contains some drives that support recording formats superior to other drives.
9840	20 GB	Uncompressed (standard) format, using a 20 GB cartridge with 270 meters (885 feet) of tape
9840-C	See note 80 GB	LZ-1 Enhanced (4:1) compressed format, using an 80 GB cartridge with 270 meters (885 feet) of tape
T9840C	40 GB	Uncompressed T9840C format, using a StorageTek 9840 cartridge
T9840C-C	80 GB	Compressed T9840C format, using a StorageTek 9840 cartridge
T9840D	75 GB	Uncompressed T9840D format, using a StorageTek 9840 cartridge
T9840D-C	150 GB	Compressed T9840D format, using a StorageTek 9840 cartridge
T10000A	500 GB	Uncompressed T10000A format, using a StorageTek T10000 cartridge
T10000A-C	1 TB	Compressed T10000A format, using a StorageTek T10000 cartridge
T10000B	1 TB	Uncompressed T10000B format, using an Oracle StorageTek T10000 cartridge
T10000B-C	2 TB	Compressed T10000B format, using an Oracle StorageTek T10000 cartridge
T10000C	5 TB	Uncompressed T10000C format, using an Oracle StorageTek T10000 T2 cartridge
T10000C-C	10 TB	Compressed T10000C format, using an Oracle StorageTek T10000 T2 cartridge
T10000D	8 TB	Uncompressed T10000D format, using an Oracle StorageTek T10000 T2 cartridge
T10000D-C	15 TB	Compressed T10000D format, using an Oracle StorageTek T10000 T2 cartridge

#### ESTCAPacity

Specifies the estimated capacity for the volumes that are assigned to this device class. This parameter is optional.

You can specify this parameter if the default estimated capacity for the device class is inaccurate due to compression of data.

You must specify this value as an integer followed by one of the following unit indicators: K (kilobytes), M (megabytes), G (gigabytes), or T (terabytes). The smallest value that is accepted is 1 MB (ESTCAPACITY=1M).

For example, specify that the estimated capacity is 9 GB with the parameter ESTCAPACITY=9G.

For more information about the default estimated capacity for cartridge tapes, see Table 1.

#### MOUNTRetention

Specifies the number of minutes that an idle sequential access volume is retained before it is dismounted. This parameter is optional. The default value is 60 minutes. You can specify a number 0 - 9999.

This parameter can improve response time for sequential access media mounts by leaving previously mounted volumes online.

However, for EXTERNAL library types (that is, a library that is managed by an external media management system), set this parameter to a low value (for example, two minutes) to enhance device sharing between applications.

Note: For environments in which devices are shared across storage applications, the MOUNTRETENTION setting must be carefully considered. This parameter determines how long an idle volume remains in a drive. Some media managers do not dismount an allocated drive to satisfy pending requests. You might need to tune this parameter to satisfy competing mount

requests while maintaining optimal system performance. Typically, problems arise more frequently when the MOUNTRETENTION parameter is set to a value that is too small, for example, zero.

#### PREFIX

Specifies the beginning portion of the high-level archive file name on the target server. This parameter is optional. The default is ADSM. The maximum length of this prefix is 8 characters.

If you have a naming convention for media labels to support your current management system, use a volume prefix that conforms to your naming conventions.

Values that are specified for this parameter must meet the following conditions:

- The value is to be made up of qualifiers, which can be a maximum of eight characters including periods. For example, the following value is acceptable:

AB.CD2.E

- The qualifiers must be separated by a single period.
- The first letter of each qualifier must be alphabetic or national (@,#,\$), followed by alphabetic, national, hyphen, or numeric characters.

An example of a high-level archive file name that uses the default prefix is ADSM.volume1.

#### MOUNTWait

Specifies the maximum number of minutes the server waits for an operator to respond to a request to either mount a volume in a drive in a manual library or check in a volume to be mounted in an automated library. This parameter is optional. If the mount request is not satisfied within the specified amount of time, the mount request is canceled. The default value is 60 minutes. You can specify a number 0 - 9999.

Restriction: If the library that is associated with this device class is external (LIBTYPE=EXTERNAL), do not specify the MOUNTWAIT parameter.

#### MOUNTLimit

Specifies the maximum number of sequential access volumes that can be simultaneously mounted for the device class. This parameter is optional. The default is DRIVES. You can specify a number 0 - 4096.

If you plan to use the simultaneous-write function, ensure that sufficient drives are available for the write operation. If the number of drives needed for a simultaneous-write operation is greater than the value of the MOUNTLIMIT parameter for a device class, the transaction fails.

The following are possible values:

#### DRIVES

Specifies that every time a mount point is allocated, the number of drives that are defined and online in the library is used to calculate the true value.

Note: For EXTERNAL library types, do not specify DRIVES for the MOUNTLIMIT value. Specify the number of drives for the library as the MOUNTLIMIT value.

#### number

Specifies the maximum number of drives in this device class that are used concurrently by the server. This value must never exceed the number of drives that are defined and online in the library that services this device class.

#### 0 (zero)

Specifies that no new transactions can gain access to the storage pool. Any current transactions continue and complete, but new transactions are terminated.

AIX

Linux

## DEFINE DEVCLASS - z/OS media server (Define device class for z/OS media server)

---

Use the DEFINE DEVCLASS command to define a device class for a type of storage device. The server requires that a device class be defined to allow the use of a device. A limited set of device class types is available for devices that are accessed through a z/OS® media server.

- DEFINE DEVCLASS (Define a 3590 device class for z/OS media server)
- DEFINE DEVCLASS (Define a 3592 device class for z/OS media server)
- DEFINE DEVCLASS (Define an ECARTRIDGE device class for z/OS media server)
- DEFINE DEVCLASS (Define a FILE device class for z/OS media server)

Table 1. Commands related to DEFINE DEVCLASS

Command	Description
BACKUP DEVCONFIG	Backs up IBM Spectrum Protect device information to a file.
DEFINE LIBRARY	Defines an automated or manual library.
DELETE DEVCLASS	Deletes a device class.
QUERY DEVCLASS	Displays information about device classes.
UPDATE DEVCLASS (z/OS media server)	Changes the attributes of a device class for storage managed by a z/OS media server.

AIX Linux

## DEFINE DEVCLASS (Define a 3590 device class for z/OS media server)

To use a z/OS® media server to access 3590 devices, you must define a 3590 device class. In the device class definition, specify a library that was defined with the LIBTYPE=ZOSMEDIA parameter.

### Privilege class

To issue this command, you must have system privilege or unrestricted storage privilege.

### Syntax

```
>>-DEFine DEVclass--device_class_name----->
>>-LIBRary-----zos_media_library--DEVType-----3590----->
. -ESTCAPacity-----9G-----.
>--+-----+-----+-----+----->
'-FORMAT-----+DRIVE-----' '-ESTCAPacity-----size---'
      +-3590B----+
      +-3590C----+
      +-3590E-B-+
      +-3590E-C-+
      +-3590H-B-+
      '-3590H-C-'

. -PREFIX-----ADSM-----.
>--+-----+-----+-----+----->
'-PREFIX-----+ADSM-----+-'
      '-tape_volume_prefix-'

. -MOUNTRetention-----60-----. .-MOUNTWait-----60-----.
>--+-----+-----+-----+----->
'-MOUNTRetention-----minutes-' '-MOUNTWait-----minutes-'

. -MOUNTLimit-----2-----. .-COMPrESSION-----Yes-----.
>--+-----+-----+-----+----->
'-MOUNTLimit-----+DRIVES-+-' '-COMPrESSION-----+Yes-+-'
      +-number-+
      '-0-----'

>--+-----+-----+-----+----->
+-EXPIration-----yyyyddd-+
'-RETention-----days-----'

. -PROtection-----No-----. .-UNIT-----3590-----.
>--+-----+-----+-----+-----><
'-PROtection-----+No-----+' '-UNIT-----unit_name-'
      +-Yes-----+
      '-Automatic-'
```

### Parameters

device\_class\_name (Required)

Specifies the name of the device class to be defined. The maximum length of the device class name is 30 characters.

LIBRARY (Required)

Specifies the name of a library that was defined with the LIBTYPE=ZOSMEDIA parameter. The library and the tape drives that can be used by this device class are controlled by the z/OS media server.

For information about defining a library, see the DEFINE LIBRARY command.

DEVtype=3590 (Required)

Specifies the 3590 device type is assigned to the device class. 3590 indicates that 3590 cartridge tape devices are assigned to the device class.

Restriction: The z/OS media server supports 256 KB data blocks when writing to 3590 tape drives. Verify that your hardware supports this capability.

FORMAT

Specifies the recording format to be used when data is written to sequential access media. This parameter is optional. See the following table for the recording formats.

Table 1. Recording formats for 3590

Format	Description
3590B	Uncompressed (basic) format
3590C	Compressed format
3590E-B	Uncompressed (basic) format, similar to the 3590B format
3590E-C	Compressed format, similar to the 3590C format
3590H-B	Uncompressed (basic) format, similar to the 3590B format
3590H-C	Compressed format, similar to the 3590C format

Note: If the format uses the tape drive hardware compression feature the actual capacity can increase, depending on the effectiveness of compression.

ESTCAPacity

Specifies the estimated capacity for the volumes that are assigned to this device class. This parameter is optional. The default estimated capacity for 3590 tapes is 9 GB.

You can specify this parameter if the default estimated capacity for the device class is inaccurate because of compression of data. The value does not determine the amount of data stored on the volume. The server uses the value to estimate the usage before a volume is filled. After a volume is full, the actual amount of data stored on the tape is used for the usage calculation.

Specify the value as an integer with one of the following unit indicators: K (KB), M (MB), G (GB), or T (TB). For example, specify that the estimated capacity is 9 GB with the parameter ESTCAPACITY=9G. The smallest value that is accepted is 100 KB (ESTCAPACITY=100K).

PREFIX

Specifies the high-level qualifier of the data set name that the server writes into the sequential access media labels. For each sequential access volume assigned to this device class, the server uses this prefix to create the data set name. This parameter is optional. The default value is ADSM. The maximum length of this prefix is 8 characters.

If you have a naming convention for media labels to support your current management system, use a volume prefix that conforms to your naming conventions.

Values that are specified for this parameter must meet the following conditions:

- The value is to be made up of qualifiers, which can be a maximum of eight characters including periods. For example, the following value is acceptable:

AB.CD2.E

- The qualifiers must be separated by a single period.
- The first letter of each qualifier must be alphabetic or national (@,#,\$), followed by alphabetic, national, hyphen, or numeric characters.

An example of a tape volume data set name using the default prefix is ADSM.BFS.

#### MOUNTRetention

Specifies the number of minutes that an idle tape volume is retained before it is dismounted. The time span for mount retention begins after the idle timeout period has expired. This parameter is optional. The default value is 60 minutes. Specify a number 0 - 9999.

This parameter can improve response time for sequential access media mounts by leaving previously mounted volumes online.

#### MOUNTWait

Specifies the maximum number of minutes that the z/OS media server waits for a volume mount. If the mount request is not satisfied within the specified time, the mount request fails. If a device is successfully allocated and the device-open request does not complete within the specified time, the device-open request ends and the mount request fails.

This parameter is optional. The default value is 60. Specify a number, 1 - 9999.

Restriction: If the library that is associated with this device class is external (LIBTYPE=EXTERNAL), do not specify the MOUNTWAIT parameter.

#### MOUNTLimit

Specifies the maximum number of sequential access volumes that can be simultaneously mounted for the device class. This parameter is optional. The default is 2.

If you plan to use the simultaneous-write function, ensure that sufficient drives are available for the write operation. If the number of drives needed for a simultaneous-write operation is greater than the value of the MOUNTLIMIT parameter for a device class, the transaction fails.

You can specify one of the following values:

##### DRIVES

Specifies that every time a mount point is allocated, the number of drives that are defined and online in the library is used to calculate the true value.

##### number

Specifies the maximum number of drives in this device class that are used concurrently by the server. This value must never exceed the number of drives that are defined and online in the library that services this device class. You can specify a number, 0 - 4096.

##### 0 (zero)

Specifies that no new transactions can gain access to the storage pool.

#### COMPression

Specifies whether file compression is used for this device class. This parameter is optional. The default value is YES.

You can specify one of the following values:

##### Yes

Specifies that the data for each tape volume is compressed.

##### No

Specifies that the data for each tape volume is not compressed.

#### EXPIration

Specifies the expiration date that is placed on the tape labels for this device class. This parameter is optional. There is no default value.

Specify the date when the server no longer requires the tape. The server does not use this information, but this information is passed to the z/OS media server for use by z/OS or tape management systems.

Specify the expiration date using the format, *yyyymmdd* (four digits for the year and three digits for the day). For example, January 7, 2014 is specified as 2014007 (the seventh day of year 2014).

If you specify the EXPIRATION parameter, you cannot specify the RETENTION parameter.

#### RETention

Specifies the number of days to retain the tape. This parameter is optional.

Specify the number of days (1 - 9999) that the server is expected to use the tape. The server does not use this information, but this information is passed to the z/OS media server for use by z/OS or tape management systems.

If you specify the RETENTION parameter, you cannot specify the EXPIRATION parameter.

## PROtection

Specifies whether the RACF® program, if installed, protects volumes that are assigned to this device class. If protection is provided, RACF profiles are created when volumes are first used. This parameter is optional. The default value is NO. You can specify one of the following values:

### No

Specifies that the RACF program does not protect volumes that are assigned to this device class.

### Yes

Specifies that the RACF program protects volumes that are assigned to this device class. RACF profiles are created for volumes when the server first uses the volumes, but the profiles are not deleted when volumes are deleted from the server. Profiles must be manually deleted.

Tip: If sensitive data is stored on volumes that are assigned to this device class, use PROTECTION=YES and manually delete RACF profiles only after tape volumes have been erased.

The profiles that are created for volumes depend on the system RACF settings. The protection that is provided is the same as using PROTECT=YES in JCL. If the RACF program is active and both TAPEVOL and TAPEDSN are inactive, allocation of tapes fails.

### Automatic

Specifies that the RACF program protects volumes that are assigned to this device class. RACF profiles are created for volumes when the server first uses the volumes. RACF profiles are deleted when volumes are deleted from the server.

The profiles that are created for volumes depend on the system RACF settings. The protection that is provided is the same as using PROTECT=YES in JCL. If the RACF program is active and both TAPEVOL and TAPEDSN are inactive, allocation of tapes fails.

Important: If you specify PROTECTION=AUTOMATIC, when a volume is deleted, its RACF profile is deleted. The volume therefore is no longer protected by the RACF program. The data on these volumes can be accessed by other users.

If you specify PROTECTION=AUTOMATIC, the z/OS media server issues RACROUTE commands to delete profiles when a volume is deleted from the server. The deletion commands that are issued depend on the current system settings for TAPEVOL and TAPEDSN. If the system settings are changed, the z/OS media server might not delete existing profiles.

Do not change the setting to PROTECTION=AUTOMATIC for a device class that was set to PROTECTION=NO. Volumes without profiles might exist and error messages are generated when such volumes are deleted. If a different value for PROTECTION is required, define a new device class.

Profile creation and deletion occur based on the protection setting when the volume is first used and when it is deleted. The server does not attempt to create profiles for volumes that it has already used. If protection is set to AUTOMATIC, the server attempts to delete profiles when volumes are deleted.

See the documentation for the RACF program for details about the TAPEVOL and TAPEDSN settings and the profiles that are created when these settings are active.

## UNIT

Specifies an esoteric unit name to specify a group of tape devices that support 3590 tape. This parameter is optional. The default unit name is 3590. The unit name can be up to 8 characters.

AIX | Linux

## DEFINE DEVCLASS (Define a 3592 device class for z/OS media server)

To use a z/OS® media server to access 3592 devices, you must define a 3592 device class. In the device class definition, specify a library that was defined with the LIBTYPE=ZOSMEDIA parameter.

### Privilege class

To issue this command, you must have system privilege or unrestricted storage privilege.

### Syntax

```

>>-DEFine DEVclass--device_class_name----->
>--LIBRARY----zos_media_library--DEVType----3592----->
  .-FORMAT----Drive----- .-WORM----No-----
>--+-----+-----+-----+----->
  '-FORMAT----+DRIVE----+' '-WORM----+Yes--+'
      +-3592-----+
      +-3592C----+
      +-3592-2---+
      +-3592-2C--+
      +-3592-3---+
      +-3592-3C--+
      +-3592-4---+
      '-3592-4C-'

  .-ESTCAPacity----300G-.
>--+-----+-----+-----+----->
  '-ESTCAPacity----size-'

  .-PREFIX----ADSM-----
>--+-----+-----+-----+----->
  '-PREFIX----+ADSM-----+'
      '-tape_volume_prefix-'

  .-MOUNTRetention---60----- .-MOUNTWait----60-----
>--+-----+-----+-----+----->
  '-MOUNTRetention---minutes-' '-MOUNTWait----minutes-'

  .-MOUNTLimit----2----- .-COMPrESSION----Yes-----
>--+-----+-----+-----+----->
  '-MOUNTLimit----+DRIVES--++' '-COMPrESSION----+Yes--+'
      +-number--+
      '-0-----'

>--+-----+-----+-----+----->
  +-EXPIration----yyyyddd+
  '-RETention----days----'

  .-PROtection----No----- .-UNIT----3592-----
>--+-----+-----+-----+----->>
  '-PROtection----+No-----+' '-UNIT----unit_name-'
      +-Yes-----+
      '-Automatic-'

```

## Parameters

device\_class\_name (Required)

Specifies the name of the device class to be defined. The maximum length of the device class name is 30 characters.

LIBRARY (Required)

Specifies the name of a library that was defined with the LIBTYPE=ZOSMEDIA parameter. The library and the tape drives that can be used by this device class are controlled by the z/OS media server.

For information about defining a library, see the DEFINE LIBRARY command.

DEVType=3592 (Required)

Specifies the 3592 device type is assigned to the device class.

FORMAT

Specifies the recording format to be used when data is written to sequential access media. This parameter is optional. The default value is DRIVE.

See the following table for the recording formats.

Table 1. Recording formats for 3592

Format	Description
3592	Uncompressed (basic) format
3592C	Compressed format



Format	Description
3592-2	Uncompressed (basic) format, similar to the 3592 format
3592-C	Compressed format, similar to the 3592C format
3592-3	Uncompressed (basic) format, similar to the 3592 format
3592-3C	Compressed format, similar to the 3592C format
3592-4	Uncompressed (basic) format, similar to the 3592 format
3592-4C	Compressed format, similar to the 3592C format
DRIVE	The server selects the highest format that is supported by the drive on which a volume is mounted. Attention: Avoid specifying DRIVE when a mixture of drives is used within the same library. For example, do not use this option for a library containing some drives that support recording formats superior to other drives.
Note: If this format uses the tape drive hardware compression feature, depending on the effectiveness of compression, the actual capacity might be different from the listed value.	

If the drives are in a library that includes drives of different tape technology, do not use the DRIVE value. Use the specific format that the drives use. For optimal results, do not mix generations of drives in the same library. If a library contains mixed generations, media problems can result. For example, generation 1 and generation 2 drives cannot read generation 3 media. If possible, upgrade all drives to 3592 generation 3. If you cannot upgrade all drives to 3592 generation 3, you must use a special configuration.

#### WORM

Specifies whether the drives use WORM (write once, read many) media. This parameter is optional. The default is No. You can specify one of the following values:

Yes

Specifies that the drives use WORM media.

No

Specifies that the drives do not use WORM media.

Tip: The IBM Spectrum Protect™ server does not automatically delete scratch volumes in WORM storage pools after the volumes are emptied by expiration or other processes. To delete these volumes and remove them from WORM storage pools, you must use the DELETE VOLUME command. IBM Spectrum Protect cannot reuse WORM volumes that were written to by the server and then deleted from a storage pool.

#### ESTCAPacity

Specifies the estimated capacity for the volumes that are assigned to this device class. This parameter is optional.

You can specify this parameter if the default estimated capacity for the device class is inaccurate because of compression of data. The value does not determine the amount of data stored on the volume. The server uses the value to estimate the usage before a volume is filled. After a volume is full, the actual amount of data stored on the tape is used for the usage calculation.

Specify the value as an integer with one of the following unit indicators: K (KB), M (MB), G (GB), or T (TB). For example, specify that the estimated capacity is 9 GB with the parameter ESTCAPACITY=9G. The smallest value that is accepted is 100 KB (ESTCAPACITY=100K).

#### PREFIX

Specifies the high-level qualifier of the data set name that the server writes into the sequential access media labels. For each sequential access volume assigned to this device class, the server uses this prefix to create the data set name. This parameter is optional. The default value is AD5M. The maximum length of this prefix is 8 characters.

If you have a naming convention for media labels to support your current management system, use a volume prefix that conforms to your naming conventions.

Values that are specified for this parameter must meet the following conditions:

- The value is to be made up of qualifiers, which can be a maximum of eight characters including periods. For example, the following value is acceptable:

AB.CD2.E

- The qualifiers must be separated by a single period.
- The first letter of each qualifier must be alphabetic or national (@,#,\$), followed by alphabetic, national, hyphen, or numeric characters.

An example of a tape volume data set name using the default prefix is ADSM.BFS.

#### MOUNTRetention

Specifies the number of minutes that an idle tape volume is retained before it is dismounted. The time span for mount retention begins after the idle timeout period has expired. This parameter is optional. The default value is 60 minutes. Specify a number 0 - 9999.

This parameter can improve response time for sequential access media mounts by leaving previously mounted volumes online.

#### MOUNTWait

Specifies the maximum number of minutes that the z/OS media server waits for a volume mount. If the mount request is not satisfied within the specified time, the mount request fails. If a device is successfully allocated and the device-open request does not complete within the specified time, the device-open request ends and the mount request fails.

This parameter is optional. The default value is 60. Specify a number, 1 - 9999.

Restriction: If the library that is associated with this device class is external (LIBTYPE=EXTERNAL), do not specify the MOUNTWAIT parameter.

#### MOUNTLimit

Specifies the maximum number of sequential access volumes that can be simultaneously mounted for the device class. This parameter is optional. The default is 2.

If you plan to use the simultaneous-write function, ensure that sufficient drives are available for the write operation. If the number of drives needed for a simultaneous-write operation is greater than the value of the MOUNTLIMIT parameter for a device class, the transaction fails.

You can specify one of the following values:

#### DRIVES

Specifies that every time a mount point is allocated, the number of drives that are defined and online in the library is used to calculate the true value.

#### number

Specifies the maximum number of drives in this device class that are used concurrently by the server. This value must never exceed the number of drives that are defined and online in the library that services this device class. You can specify a number, 0 - 4096.

#### 0 (zero)

Specifies that no new transactions can gain access to the storage pool.

#### COMPression

Specifies whether file compression is used for this device class. This parameter is optional. The default value is YES. You can specify one of the following values:

#### Yes

Specifies that the data for each tape volume is compressed.

#### No

Specifies that the data for each tape volume is not compressed.

#### EXPIration

Specifies the expiration date that is placed on the tape labels for this device class. This parameter is optional. There is no default value.

Specify the date when the server no longer requires the tape. The server does not use this information, but this information is passed to the z/OS media server for use by z/OS or tape management systems.

Specify the expiration date using the format, *yyyymmdd* (four digits for the year and three digits for the day). For example, January 7, 2014 is specified as 2014007 (the seventh day of year 2014).

If you specify the EXPIRATION parameter, you cannot specify the RETENTION parameter.

#### RETention

Specifies the number of days to retain the tape. This parameter is optional.

Specify the number of days (1 - 9999) that the server is expected to use the tape. The server does not use this information, but this information is passed to the z/OS media server for use by z/OS or tape management systems.

If you specify the RETENTION parameter, you cannot specify the EXPIRATION parameter.

#### PROtection

Specifies whether the RACF® program, if installed, protects volumes that are assigned to this device class. If protection is provided, RACF profiles are created when volumes are first used. This parameter is optional. The default value is NO. You can specify one of the following values:

##### No

Specifies that the RACF program does not protect volumes that are assigned to this device class.

##### Yes

Specifies that the RACF program protects volumes that are assigned to this device class. RACF profiles are created for volumes when the server first uses the volumes, but the profiles are not deleted when volumes are deleted from the server. Profiles must be manually deleted.

Tip: If sensitive data is stored on volumes that are assigned to this device class, use PROTECTION=YES and manually delete RACF profiles only after tape volumes have been erased.

The profiles that are created for volumes depend on the system RACF settings. The protection that is provided is the same as using PROTECT=YES in JCL. If the RACF program is active and both TAPEVOL and TAPEDSN are inactive, allocation of tapes fails.

#### Automatic

Specifies that the RACF program protects volumes that are assigned to this device class. RACF profiles are created for volumes when the server first uses the volumes. RACF profiles are deleted when volumes are deleted from the server.

The profiles that are created for volumes depend on the system RACF settings. The protection that is provided is the same as using PROTECT=YES in JCL. If the RACF program is active and both TAPEVOL and TAPEDSN are inactive, allocation of tapes fails.

Important: If you specify PROTECTION=AUTOMATIC, when a volume is deleted, its RACF profile is deleted. The volume therefore is no longer protected by the RACF program. The data on these volumes can be accessed by other users.

If you specify PROTECTION=AUTOMATIC, the z/OS media server issues RACROUTE commands to delete profiles when a volume is deleted from the server. The deletion commands that are issued depend on the current system settings for TAPEVOL and TAPEDSN. If the system settings are changed, the z/OS media server might not delete existing profiles.

Do not change the setting to PROTECTION=AUTOMATIC for a device class that was set to PROTECTION=NO. Volumes without profiles might exist and error messages are generated when such volumes are deleted. If a different value for PROTECTION is required, define a new device class.

Profile creation and deletion occur based on the protection setting when the volume is first used and when it is deleted. The server does not attempt to create profiles for volumes that it has already used. If protection is set to AUTOMATIC, the server attempts to delete profiles when volumes are deleted.

See the documentation for the RACF program for details about the TAPEVOL and TAPEDSN settings and the profiles that are created when these settings are active.

#### UNIT

Specifies an esoteric unit name to specify a group of tape devices that support 3592 tape. This parameter is optional. The default value is 3592. The unit name can be up to 8 characters.

AIX | Linux

## DEFINE DEVCLASS (Define an ECARTRIDGE device class for z/OS media server)

---

To use a z/OS® media server to access StorageTek drives such as the StorageTek T9840 or T10000, you must define an ECARTRIDGE device class. In the device class definition, specify a library that was defined with the LIBTYPE=ZOSMEDIA parameter.

## Privilege class

---

To issue this command, you must have system privilege or unrestricted storage privilege.

## Syntax

---

```
>>-DEFine DEVclass--device_class_name----->
>--LIBRary----zos_media_library--DEVType----ECARTridge----->
  .-FORMAT----DRIVE----- .-ESTCAPacity----9G---.
>--+-----+-----+-----+----->
  '-FORMAT----+DRIVE----+' '-ESTCAPacity----size-'
      +-T9840C----+
      +-T9840C-C--+
      +-T9840D----+
      +-T9840D-C--+
      +-T10000A---+
      +-T10000A-C++
      +-T10000B---+
      +-T10000B-C++
      +-T10000C---+
      +-T10000C-C++
      +-T10000D---+
      '-T10000D-C-'

  .-PREFIX----ADSM----- .
>--+-----+-----+-----+----->
  '-PREFIX----+ADSM-----+'
      '-tape_volume_prefix-'

  .-MOUNTRetention----60----- .-MOUNTWait----60----- .
>--+-----+-----+-----+----->
  '-MOUNTRetention----minutes-' '-MOUNTWait----minutes-'

  .-MOUNTLimit----2----- .-COMPrEsson----Yes----- .
>--+-----+-----+-----+----->
  '-MOUNTLimit----+DRIVES--+-' '-COMPrEsson----+Yes--+-'
      +-number++          '-No--'
      '-0-----'

>--+-----+-----+-----+----->
  +-EXPIration----yyyymmdd-+
  '-RETention----days----'

  .-PROtEction----No----- .-UNIT----9840----- .
>--+-----+-----+-----+-----><
  '-PROtEction----+No-----+' '-UNIT----unit_name-'
      +-Yes-----+
      '-Automatic-'
```

## Parameters

---

**device\_class\_name** (Required)

Specifies the name of the device class to be defined. The maximum length of the device class name is 30 characters.

**LIBRARY** (Required)

Specifies the name of a library that was defined with the LIBTYPE=ZOSMEDIA parameter. The library and the tape drives that can be used by this device class are controlled by the z/OS media server.

For information about defining a library, see the DEFINE LIBRARY command.

**DEVType=ECARTridge** (Required)

Specifies that the ECARTRIDGE device type is assigned to the device class. The ECARTRIDGE device type is for StorageTek drives such as the StorageTek T9840 or T10000.

**FORMAT**

Specifies the recording format to be used when data is written to sequential access media. This parameter is optional.

See the following table for the recording formats.

Table 1. Recording formats for ECARTRIDGE tapes

Format	Estimated Capacity	Description
DRIVE	-	The server selects the highest format that is supported by the drive on which a volume is mounted. DRIVE is the default value. Attention: Avoid specifying DRIVE when a mixture of drives is used within the same library. For example, do not use this option for a library containing some drives that support recording formats superior to other drives.
T9840C	40 GB	Uncompressed T9840C format, using a StorageTek 9840 cartridge
T9840C-C	80 GB	Compressed T9840C format, using a StorageTek 9840 cartridge
T9840D	75 GB	Uncompressed T9840D format, using a StorageTek 9840 cartridge
T9840D-C	150 GB	Compressed T9840D format, using a StorageTek 9840 cartridge
T10000A	500 GB	Uncompressed T10000A format, using a StorageTek T10000 cartridge
T10000A-C	1 TB	Compressed T10000A format, using a StorageTek T10000 cartridge
T10000B	1 TB	Uncompressed T10000B format, using an Oracle StorageTek T10000 cartridge
T10000B-C	2 TB	Compressed T10000B format, using an Oracle StorageTek T10000 cartridge
T10000C	5 TB	Uncompressed T10000C format, using an Oracle StorageTek T10000 T2 cartridge
T10000C-C	10 TB	Compressed T10000C format, using an Oracle StorageTek T10000 T2 cartridge
T10000D	8 TB	Uncompressed T10000D format, using an Oracle StorageTek T10000 T2 cartridge
T10000D-C	15 TB	Compressed T10000D format, using an Oracle StorageTek T10000 T2 cartridge
<p>Note:</p> <ul style="list-style-type: none"> <li>Some formats use a compression feature of the tape drive hardware. Depending on the effectiveness of compression, the actual capacity might be double or more than the listed value.</li> <li>T10000A drives can read and write the T10000A format only. T10000B drives can read, but cannot write, the T10000A format. T10000C drives can read, but cannot write, the T10000A and T10000B formats. T10000D drives can read, but cannot write, the T10000A, T10000B, and T10000C formats.</li> </ul>		

#### ESTCAPacity

Specifies the estimated capacity for the volumes that are assigned to this device class. This parameter is optional. The default estimated capacity is 9 GB.

You can specify this parameter if the default estimated capacity for the device class is inaccurate because of compression of data. The value does not determine the amount of data stored on the volume. The server uses the value to estimate the usage before a volume is filled. After a volume is full, the actual amount of data stored on the tape is used for the usage calculation.

Specify the value as an integer with one of the following unit indicators: **K** (KB), **M** (MB), **G** (GB), or **T** (TB). For example, specify that the estimated capacity is 9 GB with the parameter ESTCAPACITY=9G. The smallest value that is accepted is 100 KB (ESTCAPACITY=100K).

#### PREFIX

Specifies the high-level qualifier of the data set name that the server writes into the sequential access media labels. For each sequential access volume assigned to this device class, the server uses this prefix to create the data set name. This parameter is optional. The default value is ADMS. The maximum length of this prefix is 8 characters.

If you have a naming convention for media labels to support your current management system, use a volume prefix that conforms to your naming conventions.

Values that are specified for this parameter must meet the following conditions:

- The value is to be made up of qualifiers, which can be a maximum of eight characters including periods. For example, the following value is acceptable:

AB.CD2.E

- The qualifiers must be separated by a single period.
- The first letter of each qualifier must be alphabetic or national (@,#,\$), followed by alphabetic, national, hyphen, or numeric characters.

An example of a tape volume data set name using the default prefix is AD\$M.BFS.

#### MOUNTRetention

Specifies the number of minutes that an idle tape volume is retained before it is dismounted. The time span for mount retention begins after the idle timeout period has expired. This parameter is optional. The default value is 60 minutes. Specify a number 0 - 9999.

This parameter can improve response time for sequential access media mounts by leaving previously mounted volumes online.

#### MOUNTWait

Specifies the maximum number of minutes that the z/OS media server waits for a volume mount. If the mount request is not satisfied within the specified time, the mount request fails. If a device is successfully allocated and the device-open request does not complete within the specified time, the device-open request ends and the mount request fails.

This parameter is optional. The default value is 60. Specify a number, 1 - 9999.

Restriction: If the library that is associated with this device class is external (LIBTYPE=EXTERNAL), do not specify the MOUNTWAIT parameter.

#### MOUNTLimit

Specifies the maximum number of sequential access volumes that can be simultaneously mounted for the device class. This parameter is optional. The default is 2.

If you plan to use the simultaneous-write function, ensure that sufficient drives are available for the write operation. If the number of drives needed for a simultaneous-write operation is greater than the value of the MOUNTLIMIT parameter for a device class, the transaction fails.

You can specify one of the following values:

#### DRIVES

Specifies that every time a mount point is allocated, the number of drives that are defined and online in the library is used to calculate the true value.

#### number

Specifies the maximum number of drives in this device class that are used concurrently by the server. This value must never exceed the number of drives that are defined and online in the library that services this device class. You can specify a number, 0 - 4096.

#### 0 (zero)

Specifies that no new transactions can gain access to the storage pool.

#### COMPRESSION

Specifies whether file compression is used for this device class. This parameter is optional. The default value is YES. You can specify one of the following values:

#### Yes

Specifies that the data for each tape volume is compressed.

#### No

Specifies that the data for each tape volume is not compressed.

#### EXPIRATION

Specifies the expiration date that is placed on the tape labels for this device class. This parameter is optional. There is no default value.

Specify the date when the server no longer requires the tape. The server does not use this information, but this information is passed to the z/OS media server for use by z/OS or tape management systems.

Specify the expiration date using the format, *yyyymmdd* (four digits for the year and three digits for the day). For example, January 7, 2014 is specified as 2014007 (the seventh day of year 2014).

If you specify the EXPIRATION parameter, you cannot specify the RETENTION parameter.

#### RETENTION

Specifies the number of days to retain the tape. This parameter is optional.

Specify the number of days (1 - 9999) that the server is expected to use the tape. The server does not use this information, but this information is passed to the z/OS media server for use by z/OS or tape management systems.

If you specify the RETENTION parameter, you cannot specify the EXPIRATION parameter.

#### PROtection

Specifies whether the RACF® program, if installed, protects volumes that are assigned to this device class. If protection is provided, RACF profiles are created when volumes are first used. This parameter is optional. The default value is NO. You can specify one of the following values:

##### No

Specifies that the RACF program does not protect volumes that are assigned to this device class.

##### Yes

Specifies that the RACF program protects volumes that are assigned to this device class. RACF profiles are created for volumes when the server first uses the volumes, but the profiles are not deleted when volumes are deleted from the server. Profiles must be manually deleted.

Tip: If sensitive data is stored on volumes that are assigned to this device class, use PROTECTION=YES and manually delete RACF profiles only after tape volumes have been erased.

The profiles that are created for volumes depend on the system RACF settings. The protection that is provided is the same as using PROTECT=YES in JCL. If the RACF program is active and both TAPEVOL and TAPEDSN are inactive, allocation of tapes fails.

#### Automatic

Specifies that the RACF program protects volumes that are assigned to this device class. RACF profiles are created for volumes when the server first uses the volumes. RACF profiles are deleted when volumes are deleted from the server.

The profiles that are created for volumes depend on the system RACF settings. The protection that is provided is the same as using PROTECT=YES in JCL. If the RACF program is active and both TAPEVOL and TAPEDSN are inactive, allocation of tapes fails.

Important: If you specify PROTECTION=AUTOMATIC, when a volume is deleted, its RACF profile is deleted. The volume therefore is no longer protected by the RACF program. The data on these volumes can be accessed by other users.

If you specify PROTECTION=AUTOMATIC, the z/OS media server issues RACROUTE commands to delete profiles when a volume is deleted from the server. The deletion commands that are issued depend on the current system settings for TAPEVOL and TAPEDSN. If the system settings are changed, the z/OS media server might not delete existing profiles.

Do not change the setting to PROTECTION=AUTOMATIC for a device class that was set to PROTECTION=NO. Volumes without profiles might exist and error messages are generated when such volumes are deleted. If a different value for PROTECTION is required, define a new device class.

Profile creation and deletion occur based on the protection setting when the volume is first used and when it is deleted. The server does not attempt to create profiles for volumes that it has already used. If protection is set to AUTOMATIC, the server attempts to delete profiles when volumes are deleted.

See the documentation for the RACF program for details about the TAPEVOL and TAPEDSN settings and the profiles that are created when these settings are active.

#### UNIT

Specifies an esoteric unit name to specify a group of tape devices that support ECARTRIDGE tapes. Use the unit name that represents the subset of drives in the library that are attached to the z/OS system. This parameter is optional. The default value is 9840. The unit name can be up to 8 characters.

### Example: Define a device class with the ECARTRIDGE device type

---

Define a device class named E1 with the ECARTRIDGE device type and with RACF protection active for all tape volumes that are assigned to this device class. All data is compressed for this device class. The device class is for a z/OS media server library named ZOSELIB.

```
define devclass e1 devtype=ecartridge library=zoselib compression=yes
  protection=yes
```

## DEFINE DEVCLASS (Define a FILE device class for z/OS media server)

To use a z/OS® media server to access storage volumes on magnetic disk devices, you must define a FILE device class. In the device class definition, specify a library that was defined with the LIBTYPE=ZOSMEDIA parameter.

A volume in this device class is a Virtual Storage Access Method (VSAM) linear data set that is accessed by the z/OS media server. SCRATCH volumes can be used with device class and the z/OS media server can dynamically allocate the VSAM LDS. It is not necessary to define volumes for the server to use the device class. If you define volumes, set the high-level qualifier (HLQ) so that SMS recognizes the allocation request by the z/OS media server. If you are using defined volumes, the format volume function is not supported for the server when this device class is used. The z/OS media server uses a FormatWrite feature of DFSMS Media Manager when filling FILE volumes.

You can define volumes for the FILE device class by using the DEFINE VOLUME command. However, the z/OS media server does not allocate space for a defined volume until the volume is opened for its first use.

### Privilege class

To issue this command, you must have system privilege or unrestricted storage privilege.

### Syntax

```
>>-DEfIne DEVclAss--device_class_name--DEVType----FILE----->
                                     .-MAXCAPacity----10G--.
>>-LIBRary----library_name--+-----+----->
                                     '-MAXCAPacity----size-'

    .-PRIMARYalloc----2600M-.    .-SECONDARYalloc----2600M-.
>>-+-----+-----+----->
    '-PRIMARYalloc----size--'    '-SECONDARYalloc----size--'

    .-PREFIX----ADSM-----,
>>-+-----+----->
    '-PREFIX----file_volume_prefix-'

    .-MOUNTLimit----20-----.
>>-+-----+----->>
    '-MOUNTLimit----number-'
```

### Parameters

#### DEVType=FILE (Required)

Specifies that the FILE device type is assigned to the device class.

#### LIBRary (Required)

Specifies the name of a library that was defined with the LIBTYPE=ZOSMEDIA parameter. The disk storage that is used by this device class is accessed by the z/OS media server and managed by SMS.

For information about defining a library, see the DEFINE LIBRARY command.

#### MAXCAPacity

Specifies the maximum size of file volumes that are defined to a storage pool in this device class. This parameter is optional. The default value is 10 GB (MAXCAPACITY=10G).

Specify this value as an integer followed by K (KB), M (MB), G (GB), or T (TB). The minimum size is 1 MB (MAXCAPACITY=1M). The maximum size is 16384 GB (MAXCAPACITY=16384G).

#### PRIMARYalloc

Specifies the initial amount of space that is dynamically allocated when a new volume is opened. Enough space must be available to satisfy the primary allocation amount. Storage Management Subsystem (SMS) policy determines whether multiple physical volumes can be used to satisfy the primary allocation request.



This parameter is optional. Specify this value as an integer followed by **K** (KB), **M** (MB), **G** (GB), or **T** (TB). The minimum size is 100 KB (PRIMARYALLOC=100K). The maximum size is 16384 GB (MAXCAPACITY=16384G). The default size is 2600 MB (PRIMARYALLOC=2600M). All values are rounded to the next higher multiple of 256 KB.

To avoid wasted space, the dynamic allocation operation uses the smaller of the values that are specified in the two parameters, PRIMARYALLOC and MAXCAPACITY.

SMS automatic class selection (ACS) routines can affect whether the PRIMARYALLOC and SECONDARYALLOC parameter values are used.

#### SECONDARYalloc

Specifies the amount of space by which a file volume is extended when space that is already allocated to the file volume is used up. The data set for a file volume is extended up to the size set by the MAXCAPACITY parameter, then the volume is marked full.

Because secondary allocation of a linear data set cannot span a physical volume, consider the size of the physical volume when you select a secondary allocation size. For example, physical volumes for a 3390 Model 3 are approximately 2.8 GB. To ensure that each extend request occupies nearly an entire physical volume but not more, use a secondary allocation size that is just less than 2.8 GB. A secondary allocation amount of 2600 MB allots enough space for the VSAM volume data set (VVDS), the volume label, and the volume table of contents (VTOC).

This parameter is optional. Specify this value as an integer followed by **K** (KB), **M** (MB), **G** (GB), or **T** (TB). The minimum value is 0 KB (SECONDARYALLOC=0K). The default value is 2600 MB. The maximum value is 16384 GB. Except for 0, all values are rounded to the next higher multiple of 256 KB.

If you specify 0 (SECONDARYALLOC=0), the file volume cannot be extended beyond the primary allocation amount.

SMS automatic class selection (ACS) routines can affect whether the PRIMARYALLOC and SECONDARYALLOC parameter values are used.

If you specify a value for the SECONDARYALLOCATION parameter that is not 0, or if you allow the value to default to 2600M, the SMS DATACLAS associated with the PREFIX identifier (for example, High Level Qualifier) must have the Extended Addressability (EA) attribute specified. Without the EA attribute, the SMS DATACLAS limits the allocation of the VSAM LDS FILE volume to the primary extent. (See the description of the PRIMARYALLOCATION parameter). With the data set limited to primary allocation size, the data set cannot be extended by the z/OS media server, and the volume is marked FULL before the maximum capacity is reached.

**Restriction:** Ensure that the values that you specify for the PRIMARYALLOC and SECONDARYALLOC parameters are within practical limits for the storage device. The server cannot check whether the values exceed practical device limits, and does not check whether the two values together exceed the current MAXCAPACITY setting.

**Tip:** To fill volumes when you specify a large value for the MAXCAPACITY parameter, specify large values for the PRIMARYALLOC and SECONDARYALLOC parameters. Use larger MVS™ volume sizes to reduce the chance of extend failure.

#### PREFIX

Specifies the high-level qualifier of the data set name that is used to allocate scratch volume data sets. For all scratch file volumes created in this device class, the server uses this prefix to create the data set name. This parameter is optional. The default is ADSM. The maximum length of the prefix, including periods, is 32 characters.

Values that are specified for this parameter must meet the following conditions:

- The value is to be made up of qualifiers, which can be a maximum of eight characters including periods. For example, the following value is acceptable:

AB.CD2.E

- The qualifiers must be separated by a single period.
- The first letter of each qualifier must be alphabetic or national (@,#,\$), followed by alphabetic, national, hyphen, or numeric characters.

An example of a file volume data set name using the default prefix is ADSM.B0000021.BFS.

If you have a data set naming convention, use a prefix that conforms to your naming conventions. For example, the following value is acceptable: TSM.SERVER2.VSAMFILE.

If you are running multiple server instances for either IBM Spectrum Protect™ or Tivoli® Storage Manager for z/OS Media you must use a unique value for the PREFIX parameter for each device class that you define.

#### MOUNTLimit



Specifies the number of days (from the date of archive) to retain archive copies. This parameter is optional. You can specify an integer from 0 to 30000. The default value is 365. The server uses the archive retention value to manage archive copies of files when either of the following conditions occur:

- The management class to which a file is bound no longer exists. The default management class does not contain an archive copy group.
- The archive copy group is deleted from the management class to which a file is bound. The default management class does not contain an archive copy group.

#### ACTIVEDESTINATION

This optional parameter specifies the names of active-data pools that store active versions of backup data for nodes that are assigned to the domain. You can specify up to 10 active-data pools for a domain, which is separated by commas. Spaces are not permitted between the names.

Before the IBM Spectrum Protect™ server writes data to an active-data pool, it verifies that the node owning the data is assigned to a domain that has the active-data pool that is listed in the ACTIVEDESTINATION list. If the server verifies that the node meets this criteria, the data is stored in the active-data pool. If the node does not meet the criteria, then the data is not stored in the active-data pool. If the simultaneous-write function is used to write data to an active-data pool, the server verifies that the node meets the criteria during backup operations by IBM Spectrum Protect backup-archive clients or by application clients by using the IBM Spectrum Protect API. The verification is also performed when active-data is being copied by using the COPY ACTIVE DATA command.

### Example: Define a policy domain

Define a policy domain with a name of PROG1 and the description, Programming Group Domain. Specify that archive copies are retained for 90 days when management classes or archive copy groups are deleted and the default management class does not contain an archive copy group. Also, specify that backup versions are retained for 60 days when management classes or copy groups are deleted and the default management class does not contain a backup copy group.

```
define domain prog1
description="Programming Group Domain"
backretention=60 archretention=90
```

### Related commands

Table 1. Commands related to DEFINE DOMAIN

Command	Description
ACTIVATE POLICYSET	Validates and activates a policy set.
COPY DOMAIN	Creates a copy of a policy domain.
DEFINE POLICYSET	Defines a policy set within the specified policy domain.
DELETE DOMAIN	Deletes a policy domain along with any policy objects in the policy domain.
QUERY DOMAIN	Displays information about policy domains.
UPDATE DOMAIN	Changes the attributes of a policy domain.

## DEFINE DRIVE (Define a drive to a library)

Use this command to define a drive. Each drive is assigned to a library, and so the library must be defined before you issue this command.

A path must be defined after you issue the DEFINE DRIVE command to make the drive usable by IBM Spectrum Protect™. For more information, see DEFINE PATH (Define a path). If you are using a SCSI or VTL library type, see PERFORM LIBACTION (Define or delete all drives and paths for a library).

You can define more than one drive for a library by issuing the DEFINE DRIVE command for each drive. Stand-alone drives always require a manual library.

**Windows** Restriction: Before you issue the DEFINE DRIVE command, for a removable media device such as a Jaz, Zip, or CD drive, you must load the drive with properly formatted and labeled media.

For detailed and current drive support information, see the Supported Devices website for your operating system:

- **AIX** | **Windows** Supported devices for AIX and Windows
- **Linux** Supported devices for Linux

## Privilege class

---

To issue this command, you must have system privilege or unrestricted storage privilege.

## Syntax

---

```
>>-DEFine DRive--library_name--drive_name----->
. -SERial----AUTODetect----- . -ONLine----Yes-----
>+-----+-----+-----+-----+-----+----->
'-SERial----+AUTODetect----+' '-ONLine----+Yes--+'
      '-serial_number-'          '-No--'

      (1)
. -ELEMent----AUTODetect-----
>+-----+-----+-----+-----+-----+----->
'-ELEMent----+AUTODetect--+'
      '-address-----'

>+-----+-----+-----+-----+-----+----->
|                                     (2) |
'-ACSDRVID----drive_id-----'

>+-----+-----+-----+-----+-----+-----><
|                                     (3) |
'-CLEANFREQuency-----+NONE-----+'
|                                     (4) |
+--ASNEEDED-----+
      '-gigabytes-----'
```

Notes:

1. The ELEMENT parameter is only necessary for drives in SCSI libraries when the drive type is a network attached SCSI (NAS) drive.
2. ACSDRVID is required for drives in ACSLS libraries. This parameter is not valid for non-ACSLs libraries.
3. The CLEANFREQUENCY parameter is valid only for drives in SCSI libraries.
4. The CLEANFREQUENCY=ASNEEDED parameter value does not work for all tape drives. For more information, see the parameter description.

## Parameters

---

library\_name (Required)

Specifies the name of the library to which the drive is assigned. This parameter is required for all drives, including stand-alone drives. The specified library must have been previously defined by using the DEFINE LIBRARY command.

drive\_name (Required)

Specifies the name that is assigned to the drive. The maximum length of this name is 30 characters.

SERial

Specifies the serial number for the drive that is being defined. This parameter is optional. The default is AUTODETECT.

If SERIAL=AUTODETECT, then the serial number reported by the drive when you define the path is used as the serial number.

If SERIAL=serial\_number, then the serial number that is entered is used to verify that the path to the drive is correct when you define the path.

Note: Depending on the capabilities of the device, SERIAL=AUTODETECT might not be supported. In this case, the serial number is reported as blank.

ONLine

Specifies whether the drive is available for use. This parameter is optional. The default is YES.

Yes

Specifies that the drive is available for use.

No

Specifies that the drive is not available for use.

#### ELEMent

Specifies the element address of a drive within a SCSI or virtual tape library (VTL). The server uses the element address to connect the physical location of the drive to the SCSI or VTL address of the drive. The default is AUTODETECT.

If ELEMENT=AUTODETECT, then the element number is automatically detected by the server when the path to the drive is defined.

To find the element address for your library configuration, consult the information from the manufacturer.

Restriction:

- The ELEMENT parameter is valid only for drives in SCSI libraries or VTLs when the drive type is not a network attached SCSI (NAS) drive.
- This parameter is not effective when the command is issued from a library client server (that is, when the library type is SHARED).
- Depending on the capabilities of the library, ELEMENT=AUTODETECT might not be supported. In this case, you must supply the element address.

#### ACSDRVID

Specifies the ID of the drive that is being accessed in an ACSLS library. The drive ID is a set of numbers that indicates the physical location of a drive within an ACSLS library. This drive ID must be specified as *a,l,p,d*, where *a* is the ACSID, *l* is the LSM (library storage module), *p* is the panel number, and *d* is the drive ID. The server needs the drive ID to connect the physical location of the drive to the drive's SCSI address. See the StorageTek documentation for details.

 Restriction: To use ACSLS functions, the installation of StorageTek Library Attach software is required.

#### CLEANFREQuency

Specifies how often the server activates drive cleaning. This parameter is optional. For the most complete automation of cleaning for an automated library, you must have a cleaner cartridge that is checked into the library's volume inventory.

If you are using library-based cleaning, NONE is advised when your library type supports this function.

This parameter is not valid for externally managed libraries, such as 3494 libraries or StorageTek libraries that are managed under ACSLS.

Important: There are special considerations if you plan to use server-activated drive cleaning with a SCSI library that provides automatic drive cleaning support in its device hardware.

NONE

Specifies that the server does not track cleaning for this drive. This value can be used for libraries that have their own automatic cleaning.

ASNEEDED

Specifies that the server loads the drive with a checked-in cleaner cartridge only when a drive reports to the device driver that it needs cleaning.

The CLEANFREQUENCY=ASNEEDED parameter value does not work for all tape drives. See the Supported Devices website for your operating system to view detailed drive information. If ASNEEDED is not supported, you can use the gigabytes value for automatic cleaning.

For IBM 3592 and LTO drives, library-based cleaning is advised. If library-based cleaning is not supported, then ASNEEDED must be used. Gigabytes is not recommended.

Restriction: IBM Spectrum Protect does not control the drives that are connected to the NAS file server. If a drive is attached only to a NAS file server (no connection to a storage agent or server), do not specify ASNEEDED for the cleaning frequency.

gigabytes

Specifies, in gigabytes, how much data is processed on the drive before the server loads the drive with a cleaner cartridge. The server resets the gigabytes-processed counter each time it loads a cleaner cartridge in the drive.

Important: When CLEANFREQUENCY=gigabyte, drive cleaning can occur before the gigabyte setting is reached, if the drive notifies the device driver that a cleaning is necessary.

Consult the information from the drive manufacturer for cleaning recommendations. If the information gives recommendations for cleaning frequency in terms of hours of use, convert to a gigabytes value by doing the following:

1. Use the bytes-per-second rating for the drive to determine a gigabytes-per-hour value.
2. Multiply the gigabytes-per-hour value by the recommended hours of use between cleanings.
3. Use the result as the cleaning frequency value.

Using the cleaning frequency that is recommended by IBM® for IBM drives ensures that the drives are not overcleaned.

For IBM 3590 drives, specify a gigabyte value for the cleaning frequency to ensure that the drives receive adequate cleaning.

## Example: Define a drive to library

---

Define a drive in a manual library with a library name of LIB01 and a drive name of DRIVE01.

```
define drive lib01 drive01
```

### AIX

```
define path server01 drive01 srctype=server desttype=drive  
library=lib01 device=/dev/rmt0
```

### Linux

```
define path server01 drive01 srctype=server desttype=drive  
library=lib01 device=/dev/tmscsi/mt0
```

### Windows

```
define path server01 drive01 srctype=server desttype=drive  
library=lib01 device=mt3.0.0.0
```

## Example: Define a drive in an ACSLS library

---

Define a drive in an ACSLS library with a library name of ACSLIB and a drive name of ACSDRV1.

```
define drive acslib acsdrv1 acsdrv1=1,2,3,4
```

### AIX

```
define path server01 acsdrv1 srctype=server desttype=drive  
library=acslib device=/dev/rmt0
```

### Linux

```
define path server01 acsdrv1 srctype=server desttype=drive  
library=acslib device=/dev/tmscsi/mt0
```

### Windows

```
define path server01 acsdrv1 srctype=server desttype=drive  
library=acslib device=mt3.0.0.0
```

## Example: Define a drive in an automated library

---

Define a drive in an automated library with a library name of AUTO8MMLIB and a drive name of DRIVE01.

```
define drive auto8mmlib drive01 element=82
```

### AIX

```
define path server01 drive01 srctype=server desttype=drive  
library=auto8mmlib device=/dev/rmt0
```

### Linux

```
define path server01 drive01 srctype=server desttype=drive  
library=auto8mmlib device=/dev/tmscsi/mt0
```

### Windows

```
define path server01 drive01 srctype=server desttype=drive
library=auto8mmlib device=mt3.0.0.0
```

## Related commands

Table 1. Commands related to DEFINE DRIVE

Command	Description
DEFINE LIBRARY	Defines an automated or manual library.
DEFINE PATH	Defines a path from a source to a destination.
DELETE DRIVE	Deletes a drive from a library.
DELETE LIBRARY	Deletes a library.
PERFORM LIBACTION	Defines all drives and paths for a library.
QUERY DRIVE	Displays information about drives.
QUERY LIBRARY	Displays information about one or more libraries.
QUERY PATH	Displays information about the path from a source to a destination.
UPDATE DRIVE	Changes the attributes of a drive.
UPDATE PATH	Changes the attributes associated with a path.

## DEFINE EVENTSERVER (Define a server as the event server)

Use this command to identify a server as the event server.

If you define an event server, one IBM Spectrum Protect™ server can send events to another IBM Spectrum Protect server that will log those events.

### Privilege class

To issue this command, you must have system privilege.

### Syntax

```
>>-DEFine EVENTSErver--server_name-----><
```

### Parameters

server\_name (Required)

Specifies the name of the event server. The server you specify must have already been defined with the DEFINE SERVER command.

### Example: Designate the event server

Designate ASTRO to be the event server.

```
define eventserver astro
```

## Related commands

Table 1. Commands related to DEFINE EVENTSERVER

Command	Description
DEFINE SERVER	Defines a server for server-to-server communications.
DELETE EVENTSERVER	Deletes reference to the event server.

Command	Description
DISABLE EVENTS	Disables specific events for receivers.
ENABLE EVENTS	Enables specific events for receivers.
PING SERVER	Tests the connections between servers..
QUERY EVENTSERVER	Displays the name of the event server.
QUERY SERVER	Displays information about servers.

**Related information:**

[Enterprise event logging: logging events to another server](#)

## DEFINE GRPMEMBER (Add a server to a server group)

Use this command to add a server as a member of a server group. You can also add one server group to another server group. A server group lets you route commands to multiple servers by specifying only the server group name.

### Privilege class

To issue this command, you must have system privilege.

### Syntax

```

      .-------.
      v           |
>>-DEfIne GRPMEMber--group_name---member_name+----->>

```

### Parameters

group\_name (Required)

Specifies the name of the server group to which the member will be added.

member\_name (Required)

Specifies the names of the servers or groups to be added to the group. To specify multiple servers and groups, separate the names with commas and no intervening spaces. The servers or server groups must already be defined to the server.

### Example: Define a server to a server group

Define the server SANJOSE to server group CALIFORNIA.

```
define grpmember california sanjose
```

### Example: Define a server and a server group to a server group

Define the server TUCSON and the server group CALIFORNIA to server group WEST\_COMPLEX.

```
define grpmember west_complex tucson,california
```

### Related commands

Table 1. Commands related to DEFINE GRPMEMBER

Command	Description
DEFINE SERVER	Defines a server for server-to-server communications.
DEFINE SERVERGROUP	Defines a new server group.
DELETE GRPMEMBER	Deletes a server from a server group.
DELETE SERVERGROUP	Deletes a server group.
MOVE GRPMEMBER	Moves a server group member.



Command	Description
QUERY SERVER	Displays information about servers.
RENAME SERVERGROUP	Renames a server group.
UPDATE SERVERGROUP	Updates a server group.

## DEFINE LIBRARY (Define a library)

Use this command to define a library. A library is a collection of one or more drives, and possibly robotic devices (depending on the library type), which can be used to access storage volumes.

A library can be accessed by only one source: an IBM Spectrum Protect™ server or a data mover. However, the drives in a library can be accessed by multiple sources.

The following library types can be defined to the server. Syntax and parameter descriptions are available for each type.

- DEFINE LIBRARY (Define a 349X library)
- DEFINE LIBRARY (Define an ACSLS library)
- DEFINE LIBRARY (Define an External library)
- DEFINE LIBRARY (Define a FILE library)
- DEFINE LIBRARY (Define a manual library)
- DEFINE LIBRARY (Define a SCSI library)
- DEFINE LIBRARY (Define a shared library)
- DEFINE LIBRARY (Define a VTL library)
- **AIX** **Linux** DEFINE LIBRARY (Define a ZOSMEDIA library type)

For detailed and current library support information, see the Supported Devices website for your operating system:

- **AIX** **Windows** Supported devices for AIX and Windows
- **Linux** Supported devices for Linux

### Windows

To automatically label tape volumes in SCSI-type libraries, use the AUTOLABEL parameter on the DEFINE LIBRARY and UPDATE LIBRARY commands. Using this parameter eliminates the need to pre-label a set of tapes. It is also more efficient than using the LABEL LIBVOLUME command, which requires you to mount volumes separately. If you use the AUTOLABEL parameter, you must check in tapes by specifying CHECKLABEL=BARCODE on the CHECKIN LIBVOLUME command.

A label cannot include embedded blanks or periods and must be valid when used as a file name on the media.

You must label CD-ROM, Zip, or Jaz volumes with the device utilities from the manufacturer or the Windows utilities because IBM Spectrum Protect does not provide utilities to format or label these media types. The operating system utilities include the Disk Administrator program (a graphical user interface) and the label command.

## Related commands

Table 1. Commands related to DEFINE LIBRARY

Command	Description
AUDIT LIBRARY	Ensures that an automated library is in a consistent state.
CHECKIN LIBVOLUME	Checks a storage volume into an automated library.
CHECKOUT LIBVOLUME	Checks a storage volume out of an automated library.
DEFINE DRIVE	Assigns a drive to a library.
DEFINE PATH	Defines a path from a source to a destination.
DEFINE SERVER	Defines a server for server-to-server communications.
DELETE DRIVE	Deletes a drive from a library.
DELETE LIBRARY	Deletes a library.
DELETE PATH	Deletes a path from a source to a destination.

Command	Description
LABEL LIBVOLUME	Labels volumes in manual or automated libraries.
PERFORM LIBACTION	Defines all drives and paths for a library.
QUERY DRIVE	Displays information about drives.
QUERY LIBRARY	Displays information about one or more libraries.
QUERY LIBVOLUME	Displays information about a library volume.
QUERY PATH	Displays information about the path from a source to a destination.
UPDATE DRIVE	Changes the attributes of a drive.
UPDATE LIBRARY	Changes the attributes of a library.
UPDATE LIBVOLUME	Changes the status of a storage volume.
UPDATE PATH	Changes the attributes associated with a path.

## DEFINE LIBRARY (Define a 349X library)

Use this syntax to define a 349X library.

### Privilege class

To issue this command, you must have system privilege or unrestricted storage privilege.

### Syntax

```
>>-DEfIne LIBRary--library_name--LIBType-----349X----->
. -SHARed-----No----- . -RESEtDrives-----No-----
>-----+-----+-----+-----+----->
' -SHARed-----+Yes--+ | (1) |
      '-No--'      '-RESEtDrives-----+Yes+-----'
                          '-No--'

. -AUTOLabel-----Yes-----
>-----+-----+-----+-----+----->
' -AUTOLabel-----+No-----+
      +-Yes-----+
      '-OVERWRITE-'

. -SCRATCHCAtEgory-----301-----
>-----+-----+-----+-----+----->
' -SCRATCHCAtEgory-----number- '

. -PRIVATECAtEgory-----300-----
>-----+-----+-----+-----+----->
' -PRIVATECAtEgory-----number- '

>-----+-----+-----+-----+-----><
' -WORMSCRatchcategory-----number- '

```

Notes:

1. The default value of the RESETDRIVES parameter is conditional. If the SHARED parameter is set to NO, the value of the RESETDRIVES parameter is NO. If the SHARED parameter is set to YES, the value of the RESETDRIVES parameter is YES.

### Parameters

*library\_name* (Required)

Specifies the name of the library to be defined. The maximum length of this name is 30 characters.

LIBType=349X (Required)

**AIX**

**Linux**

Specifies that the library is an IBM 3494 or 3495 Tape Library Dataserver.

**Windows**

Specifies that the library is an IBM 3494 Tape Library Dataserver or an IBM Tape System Library Manager emulating a 3494 Tape Library Dataserver.

Restriction: IBM 3494 libraries support only one unique device type at a time.

#### SHARED

Specifies whether this library is shared with other servers in a storage area network (SAN). This parameter is required when you define a library to the library manager.

YES

Specifies that this library can be shared with other servers. When you specify YES, the library manager server mounts volumes as requested by other servers and tracks drive and volume allocation to other servers.

NO

Specifies that this library cannot be shared with other servers. SHARED=NO is required if the library is controlled by passing commands through a NAS file server.

#### AUTOLabel

Specifies whether the server attempts to automatically label tape volumes. This parameter is optional. The default is YES.

To use this option, you must check in the tapes with CHECKLABEL=BARCODE on the CHECKIN LIBVOLUME command.

Restriction: If you are defining a library that has drives that are attached to a network-attached storage (NAS) device, you must use the LABEL LIBVOLUME command to label the volumes for this library.

No

Specifies that the server does not attempt to label any volumes.

Yes

Specifies that the server labels only unlabeled volumes.

#### OVERWRITE

Specifies that the server attempts to overwrite an existing label. The server overwrites existing labels only if both the existing label and the bar code label are not already defined in any server storage pool or volume history list.

#### SCRATCHCATegory

Specifies the category number to be used for scratch volumes in the library. This parameter is optional. The default value is 301 (becomes X'12D' on the IBM 3494 since it uses hexadecimal values). You can specify a number from 1 to 65279. This number must be unique. It cannot be shared with other applications or defined libraries, and it must be different from the other category numbers in this library.

#### PRIVATECATegory

Specifies the category number for private volumes that must be mounted by name. This parameter is optional. The default value is 300 (this value becomes X'12C' on the IBM 3494 because it uses hexadecimal values). You can specify a number from 1 to 65279. This number must be unique. It cannot be shared with other applications or defined libraries, and it must be different from the other category numbers in this library.

#### WORMSCRatchcategory

Specifies the category number to be used for WORM scratch volumes in the library. This parameter is required if you use WORM volumes. You can specify a number from 1 to 65279. This number must be unique. It cannot be shared with other applications or defined libraries, and it must be different from the other category numbers in this library. This parameter is only valid when 3592 WORM volumes are used.

Restriction: If the WORMSCRATCHCATEGORY is not defined and the WORM parameter is set to YES for the device class, the mount operation fails with an error message.

#### RESETDrives

Specifies whether the server preempts a drive reservation with persistent reserve when the server is restarted or when a library client or storage agent reconnection is established. If, for example, a storage agent becomes unavailable but is still holding the path to a drive, persistent reserve allows the server to break the storage agent's reservation and access the drive.

**AIX**

**Windows**

If persistent reserve is not supported, the server completes a reset of the path to the target device.

**Linux**

If persistent reserve is not supported, the server is not able to reset the path to the target device.

Support for persistent reservation has the following limitations:

- If you are using the IBM Spectrum Protect™ device driver, persistent reserve is only supported on some tape drives. See Technote 1470319 for details.

- If you are using the IBM® device driver, persistent reserve must be enabled at the device driver level. See the *IBM Tape Device Drivers Installation and User's Guide* for information about driver configuration.
- If you are using a virtual tape library that is emulating a supported drive, it might not support persistent reserve.

The following table describes the three possible configurations for drives that are attached to NAS devices.

Table 1. Configurations for drives that are attached to NAS devices.

Library device configuration	The behavior for persistent reserve
The library device is attached to the IBM Spectrum Protect server, and the tape drives are shared by the server and the NAS device.	Drive reservation preemption is supported when the NAS device supports persistent reserve and it is enabled. For more information about setting persistent reserve, see the documentation for your NAS device.
The library device is attached to the IBM Spectrum Protect server and the tape drives are accessed only from the NAS device.	Drive reservation preemption is not supported. If you enable persistent reserve on the NAS device for these drives and a reservation is set by the NAS device but never cleared, you must use another method to clear the reservation.

AIX Windows

Yes

Specifies that drive preemption through persistent reserve or target reset are used. YES is the default for a library that is defined with SHARED=YES.

No

Specifies that drive preemption through persistent reserve or target reset are not used. NO is the default for a library that is defined with SHARED=NO. The RESETDRIVES parameter must be set to YES in a clustered environment when SHARED=NO.

Linux

Yes

Specifies that drive preemption through persistent reserve is used. YES is the default for a library that is defined with SHARED=YES.

No

Specifies that drive preemption through persistent reserve is not used. NO is the default for a library that is defined with SHARED=NO.

Note: A library manager will not be able to break a drive reservation if the system that has the drive reservation is not configured to use persistent reservation.

## Example: Define a 3494 library

Define a library named `my3494` with a scratch category number of 550, a private category number of 600, and a WORM scratch category number of 400®

```
define library my3494 libtype=349x scratchcategory=550
privatecategory=600 wormscratchcategory=400
```

## DEFINE LIBRARY (Define an ACSLS library)

Use this syntax to define an ACSLS library.

### Privilege class

Windows To use ACSLS functions, the installation of StorageTek Library Attach software is required.

To issue this command, you must have system privilege or unrestricted storage privilege.

### Syntax

```
>>-DEFine LIBRARY--library_name--LIBType---ACSLs----->
.-SHARed---No-----.-RESETDrives---No-----.
```

```

>-----+-----+-----+-----+----->
'-SHAREd---+---Yes-+-' | (1) |
      '-No--'      '-RESETDrives---+---Yes-+-'
                        '-No--'

.-AUTOLabel---+---Yes-----
>-----+-----+-----+-----+-----><
'-AUTOLabel---+---No-----+-'
      +---Yes-----+
      '-OVERWRITE-'

```

Notes:

1. The default value of the RESETDRIVES parameter is conditional. If the SHARED parameter is set to NO, the value of the RESETDRIVES parameter is NO. If the SHARED parameter is set to YES, the value of the RESETDRIVES parameter is YES.

## Parameters

library\_name (Required)

Specifies the name of the library to be defined. The maximum length of this name is 30 characters.

LIBType=ACSL (Required)

Specifies that the library is a StorageTek library that is controlled by StorageTek Automated Cartridge System Library Software (ACSL).

SHARED

Specifies whether this library is shared with other servers in a storage area network (SAN). This parameter is required when you define a library to the library manager.

YES

Specifies that this library can be shared with other servers. When you specify YES, the library manager server mounts volumes as requested by other servers and tracks drive and volume allocation to other servers.

NO

Specifies that this library cannot be shared with other servers. SHARED=NO is required if the library is controlled by passing commands through a NAS file server.

RESETDrives

Specifies whether the server preempts a drive reservation with persistent reserve when the server is restarted or when a library client or storage agent reconnection is established. If, for example, a storage agent becomes unavailable but is still holding the path to a drive, persistent reserve allows the server to break the storage agent's reservation and access the drive.

**AIX** | **Windows** If persistent reserve is not supported, the server completes a reset of the path to the target device.

**Linux** If persistent reserve is not supported, the server is not able to reset the path to the target device.

Support for persistent reservation has the following limitations:

- If you are using the IBM Spectrum Protect™ device driver, persistent reserve is only supported on some tape drives. See Technote 1470319 for details.
- If you are using the IBM® device driver, persistent reserve must be enabled at the device driver level. See the *IBM Tape Device Drivers Installation and User's Guide* for information about driver configuration.
- If you are using a virtual tape library that is emulating a supported drive, it might not support persistent reserve.

The following table describes the three possible configurations for drives that are attached to NAS devices.

Table 1. Configurations for drives that are attached to NAS devices.

Library device configuration	The behavior for persistent reserve
The library device is attached to the IBM Spectrum Protect server, and the tape drives are shared by the server and the NAS device.	Drive reservation preemption is supported when the NAS device supports persistent reserve and it is enabled. For more information about setting persistent reserve, see the documentation for your NAS device.

Library device configuration	The behavior for persistent reserve
The library device is attached to the IBM Spectrum Protect server and the tape drives are accessed only from the NAS device.	Drive reservation preemption is not supported. If you enable persistent reserve on the NAS device for these drives and a reservation is set by the NAS device but never cleared, you must use another method to clear the reservation.

AIX Windows

Yes

Specifies that drive preemption through persistent reserve or target reset are used. YES is the default for a library that is defined with SHARED=YES.

No

Specifies that drive preemption through persistent reserve or target reset are not used. NO is the default for a library that is defined with SHARED=NO. The RESETDRIVES parameter must be set to YES in a clustered environment when SHARED=NO.

Linux

Yes

Specifies that drive preemption through persistent reserve is used. YES is the default for a library that is defined with SHARED=YES.

No

Specifies that drive preemption through persistent reserve is not used. NO is the default for a library that is defined with SHARED=NO.

Note: A library manager will not be able to break a drive reservation if the system that has the drive reservation is not configured to use persistent reservation.

AUTOLabel

Specifies whether the server attempts to automatically label tape volumes. This parameter is optional. The default is YES.

To use this option, you must check in the tapes with CHECKLABEL=BARCODE on the CHECKIN LIBVOLUME command.

Restriction: If you are defining a library that has drives that are attached to a network-attached storage (NAS) device, you must use the LABEL LIBVOLUME command to label the volumes for this library.

No

Specifies that the server does not attempt to label any volumes.

Yes

Specifies that the server labels only unlabeled volumes.

OVERWRITE

Specifies that the server attempts to overwrite an existing label. The server overwrites existing labels *only* if both the existing label and the bar code label are not already defined in any server storage pool or volume history list.

ACSID (Required)

Specifies the number of this StorageTek library that is assigned by the ACSSA (Automatic Cartridge System System Administrator). This number can be from 0 to 126. Issue QUERY ACS on your system to get the number for your library ID. This parameter is required.

For more information, see your StorageTek documentation.

## Example: Define a shared ACSLS library

Define a library named ACSLIB with the library type of ACSLS and an ACSID of 1.

```
define library acslib libtype=acsls acsid=1 shared=yes
```

## DEFINE LIBRARY (Define an External library)

Use this syntax to define an External library.

### Privilege class

To issue this command, you must have system privilege or unrestricted storage privilege.

## Syntax

---

```
>>-DEFine LIBRARY--library_name--LIBType-----EXternal----->
. -AUTOLabel-----Yes-----
>-----+-----+-----+----->>
'-AUTOLabel-----+No-----+-'
      +-Yes-----+
      '-OVERWRITE-'
```

## Parameters

---

### library\_name (Required)

Specifies the name of the library to be defined. The maximum length of this name is 30 characters.

### LIBType=EXternal (Required)

Specifies that the library is managed by an external media management system. This library type does not support drive definitions with the DEFINE DRIVE command. Rather, the external media management system identifies the appropriate drive for media access operations.

**AIX** | **Windows** In an IBM Spectrum Protect™ for Storage Area Networks environment, this parameter specifies that StorageTek Automated Cartridge System Library Software (ACSL) or Library Station software controls the library. Software, such as Gresham EDT-DistribuTAPE, allows multiple servers to share the library. The drives in this library are not defined to IBM Spectrum Protect. ACSL identifies the drive for media operations.

### AUTOLabel

Specifies whether the server attempts to automatically label tape volumes. This parameter is optional. The default is YES.

To use this option, you must check in the tapes with CHECKLABEL=BARCODE on the CHECKIN LIBVOLUME command.

#### No

Specifies that the server does not attempt to label any volumes.

#### Yes

Specifies that the server labels only unlabeled volumes.

### OVERWRITE

Specifies that the server attempts to overwrite an existing label. The server overwrites existing labels *only* if both the existing label and the bar code label are not already defined in any server storage pool or volume history list.

## Example: Define an external library for a SAN configuration

---

For an IBM Spectrum Protect for Storage Area Networks configuration, define a library named EXTLIB with the library type of EXTERNAL. If you are using Gresham Enterprise DistribuTAPE, the external library manager executable file is in the following directory:

- **AIX** /usr/lpp/dtelm/bin/elm
- **Linux** /opt/OMIdtelm/bin/elm
- **Windows** c:\program files\GES\EDT\bin\elm.exe

If you are using the IBM® Tape System Library Manager, the external library manager executable file can be found in the following directory:

- **AIX** | **Linux** /opt/IBM/TSLM/client/tsm/elm
- **Windows** ...\\IBM\mmm\client\tsm\elm.exe

For more information, see the *IBM Tape System Library Manager User's Guide* at <http://www.ibm.com/support/docview.wss?uid=ssg1S7004001>.

#### 1. Define the library:

```
define library extlib libtype=external
```

#### 2. Define the path:

**AIX**

```
define path server1 extlib srctype=server desttype=library
externalmanager="/usr/lpp/dtelm/bin/elm"
```

#### Linux

```
define path server1 extlib srctype=server desttype=library
externalmanager="/opt/OMIdtelm/bin/elm"
```

#### Windows

```
define path server1 extlib srctype=server desttype=library
externalmanager="c:\program files\GES\EDT\bin\elm.exe"
```

## DEFINE LIBRARY (Define a FILE library)

---

Use this syntax to define a FILE library.

### Privilege class

---

To issue this command, you must have system privilege or unrestricted storage privilege.

### Syntax

---

```
>>-DEFINE LIBRARY--library_name--LIBType-----FILE----->
.-SHARED-----No-----
>--+-----+----->>
'-SHARED-----+Yes-+-'
      '-No--'
```

### Parameters

---

library\_name (Required)

Specifies the name of the library to be defined. The maximum length of this name is 30 characters.

LIBType=FILE (Required)

Specifies that a pseudo-library is created for sequential file volumes. When you issue the DEFINE DEVCLASS command with DEVTYPE=FILE and SHARED=YES parameters, this occurs automatically. FILE libraries are necessary only when sharing sequential file volumes between the server and one or more storage agents. The use of FILE libraries requires library sharing. Shared FILE libraries are supported for use in LAN-free backup configurations only. You cannot use a shared FILE library in an environment in which a library manager is used to manage library clients.

SHARED

Specifies whether this library is shared with other IBM Spectrum Protect™ servers in a storage area network (SAN). This parameter is required when you define a library to the library manager.

YES

Specifies that this library can be shared with other servers. When you specify YES, the library manager server mounts volumes as requested by other servers and tracks drive and volume allocation to other servers.

NO

Specifies that this library cannot be shared with other servers. SHARED=NO is required if the library is controlled by passing commands through a NAS file server.

### Example: Define a shared FILE library

---

Define a file library with shared=yes.

```
define library file1 libtype=file shared=yes
```

## DEFINE LIBRARY (Define a manual library)

---

Use this syntax to define a manual library.

### Privilege class

---



To issue this command, you must have system privilege or unrestricted storage privilege.

## Syntax

```
>>-DEFine LIBRARY--library_name--LIBType---MANUAL----->
. -RESETDrives----Yes----.
>--+-----+----->
' -RESETDrives----+-Yes-+- '
      '-No-- '

. -AUTOLabel----Yes----- .
>--+-----+----->>
' -AUTOLabel----+-No-----+ '
      +-Yes-----+
      '-OVERWRITE-'
```

## Parameters

### library\_name (Required)

Specifies the name of the library to be defined. The maximum length of this name is 30 characters.

### LIBType=MANUAL (Required)

Specifies that the library is not automated. When volumes must be mounted on drives in this type of library, messages are sent to operators. This type of library is used with stand-alone drives.

### AUTOLabel

Specifies whether the server attempts to automatically label tape volumes. This parameter is optional. The default is YES.

To use this option, you need to check in the tapes with CHECKLABEL=BARCODE on the CHECKIN LIBVOLUME command.

### No

Specifies that the server does not attempt to label any volumes.

### Yes

Specifies that the server only labels unlabeled volumes.

### OVERWRITE

Specifies that the server attempts to overwrite an existing label. The server overwrites existing labels *only* if both the existing label and the bar code label are not already defined in any server storage pool or volume history list.

### RESETDrives

Specifies whether the server preempts a drive reservation with persistent reserve when the server is restarted or when a library client or storage agent reconnection is established. If, for example, a storage agent becomes unavailable but is still holding the path to a drive, persistent reserve allows the server to break the storage agent's reservation and access the drive.

**AIX** | **Windows** If persistent reserve is not supported, the server completes a reset of the path to the target device.

**Linux** If persistent reserve is not supported, the server is not able to reset the path to the target device.

Support for persistent reservation has the following limitations:

- If you are using the IBM Spectrum Protect™ device driver, persistent reserve is only supported on some tape drives. See Technote 1470319 for details.
- If you are using the IBM® device driver, persistent reserve must be enabled at the device driver level. See the *IBM Tape Device Drivers Installation and User's Guide* for information about driver configuration.
- If you are using a virtual tape library that is emulating a supported drive, it might not support persistent reserve.

**AIX** | **Windows**

### Yes

Specifies that drive preemption through persistent reserve or target reset are used. YES is the default for a library that is defined with SHARED=YES.

### No

Specifies that drive preemption through persistent reserve or target reset are not used. NO is the default for a library that is defined with SHARED=NO. The RESETDRIVES parameter must be set to YES in a clustered environment when SHARED=NO.

**Yes**

Specifies that drive preemption through persistent reserve is used. YES is the default for a library that is defined with SHARED=YES.

**No**

Specifies that drive preemption through persistent reserve is not used. NO is the default for a library that is defined with SHARED=NO.

Note: A library manager will not be able to break a drive reservation if the system that has the drive reservation is not configured to use persistent reservation.

## Example: Define a manual library

---

Define a library named `MANUALMOUNT` with the library type of `MANUAL`.

```
define library manualmount libtype=manual
```

## DEFINE LIBRARY (Define a SCSI library)

---

Use this syntax to define a SCSI library.

### Privilege class

---

To issue this command, you must have system privilege or unrestricted storage privilege.

### Syntax

---

```
>>-DEFINE LIBRARY--library_name--LIBType-----SCSI----->
. -SHARED-----No----- . -RESETDrives-----No-----
>+-----+-----+-----+-----+-----+-----+-----+----->
'-SHARED-----+Yes-+-' | (1) |
      '-No--'      '-RESETDrives-----+Yes-+-----'
                          '-No--'

. -AUTOLabel-----No----- .
>+-----+-----+-----+-----+-----+-----+-----+----->
'-AUTOLabel-----+No-----+-'
      +-Yes-----+
      '-OVERWRITE-'

. -RELABELSCRatch-----No----- .
>+-----+-----+-----+-----+-----+-----+-----+----->
'-RELABELSCRatch-----+No-+-'
      '-Yes-'

. -SERial-----AUTODetect----- .
>+-----+-----+-----+-----+-----+-----+-----+-----><
'-SERial-----+AUTODetect-----+-'
      '-serial_number-'
```

**Notes:**

1. The default value of the `RESETDRIVES` parameter is conditional. If the `SHARED` parameter is set to `NO`, the value of the `RESETDRIVES` parameter is `NO`. If the `SHARED` parameter is set to `YES`, the value of the `RESETDRIVES` parameter is `YES`.

### Parameters

---

`library_name` (Required)

Specifies the name of the library to be defined. The maximum length of this name is 30 characters.

`LIBType=SCSI` (Required)

Specifies that the library has a SCSI-controlled media changer device. To mount volumes on drives in this type of library, the server uses the media changer device.

## SHARED

Specifies whether this library is shared with other servers in a storage area network (SAN). This parameter is required when you define a library to the library manager.

### YES

Specifies that this library can be shared with other servers. When you specify YES, the library manager server mounts volumes as requested by other servers and tracks drive and volume allocation to other servers.

### NO

Specifies that this library cannot be shared with other servers. SHARED=NO is required if the library is controlled by passing commands through a NAS file server.

## AUTOLabel

Specifies whether the server attempts to automatically label tape volumes. This parameter is optional. The default is NO.

To use this option, you must check in the tapes with CHECKLABEL=BARCODE on the CHECKIN LIBVOLUME command.

Restriction: If you are defining a library that has drives that are attached to a network-attached storage (NAS) device, you must use the LABEL LIBVOLUME command to label the volumes for this library.

### No

Specifies that the server does not attempt to label any volumes.

### Yes

Specifies that the server labels only unlabeled volumes.

## OVERWRITE

Specifies that the server attempts to overwrite an existing label. The server overwrites existing labels *only* if both the existing label and the bar code label are not already defined in any server storage pool or volume history list.

## RELABELSCRatch

Specifies whether the server relabels volumes that were deleted and returned to scratch. When this parameter is set to YES, a LABEL LIBVOLUME operation is started and the existing volume label is overwritten. This parameter is optional and intended for use with a Virtual Tape Library (VTL).

If you have both virtual and real volumes in your VTL, both types are relabeled when this parameter is enabled. If the VTL includes real volumes, specifying this option might impact performance.

Restriction: If you are defining a library that has drives that are attached to a network-attached storage (NAS) device, you must use the LABEL LIBVOLUME command to label the volumes for this library.

### No

Specifies that the server does not relabel volumes that are deleted and returned to scratch.

### Yes

Specifies that the server relabels volumes that are deleted and returned to scratch.

## RESETDrives

Specifies whether the server preempts a drive reservation with persistent reserve when the server is restarted or when a library client or storage agent reconnection is established. If, for example, a storage agent becomes unavailable but is still holding the path to a drive, persistent reserve allows the server to break the storage agent's reservation and access the drive.

**AIX** | **Windows** If persistent reserve is not supported, the server completes a reset of the path to the target device.

**Linux** If persistent reserve is not supported, the server is not able to reset the path to the target device.

Support for persistent reservation has the following limitations:

- If you are using the IBM Spectrum Protect™ device driver, persistent reserve is only supported on some tape drives. See Technote 1470319 for details.
- If you are using the IBM® device driver, persistent reserve must be enabled at the device driver level. See the *IBM Tape Device Drivers Installation and User's Guide* for information about driver configuration.
- If you are using a virtual tape library that is emulating a supported drive, it might not support persistent reserve.

The following table describes the three possible configurations for drives that are attached to NAS devices.

Table 1. Configurations for drives that are attached to NAS devices

Library device configuration	The behavior for persistent reserve
------------------------------	-------------------------------------

Library device configuration	The behavior for persistent reserve
The library device is attached to the IBM Spectrum Protect server, and the tape drives are shared by the server and the NAS device.	Drive reservation preemption is supported when the NAS device supports persistent reserve and it is enabled. For more information about setting persistent reserve, see the documentation for your NAS device.
The library device is attached to the IBM Spectrum Protect server and the tape drives are accessed only from the NAS device.	Drive reservation preemption is not supported. If you enable persistent reserve on the NAS device for these drives and a reservation is set by the NAS device but never cleared, you must use another method to clear the reservation.
The library device is attached to the NAS device and accessed indirectly by NDMP (network data management protocol), and the tape drives are accessed only from the NAS device.	Drive reservation preemption is not supported. If you enable persistent reserve on the NAS device for these drives and a reservation is set by the NAS device but never cleared, you must use another method to clear the reservation.

AIX | Windows

Yes

Specifies that drive preemption through persistent reserve or target reset are used. YES is the default for a library that is defined with SHARED=YES.

No

Specifies that drive preemption through persistent reserve or target reset are not used. NO is the default for a library that is defined with SHARED=NO. The RESETDRIVES parameter must be set to YES in a clustered environment when SHARED=NO.

Linux

Yes

Specifies that drive preemption through persistent reserve is used. YES is the default for a library that is defined with SHARED=YES.

No

Specifies that drive preemption through persistent reserve is not used. NO is the default for a library that is defined with SHARED=NO.

Note: A library manager will not be able to break a drive reservation if the system that has the drive reservation is not configured to use persistent reservation.

SERIAL

Specifies the serial number for the library that is being defined. This parameter is optional. The default is AUTODETECT.

If SERIAL=AUTODETECT, then when you define the path to the library, the serial number reported by the library is used as the serial number.

If SERIAL=*serial\_number*, then the number you entered is compared to the number detected by the server.

Attention: Depending on the capabilities of the device, SERIAL=AUTODETECT might not be supported. In this case, the serial number is reported as blank.

## Example: Define a SCSI library

Define a library that is named SCILIB with a library type of SCSI.

```
define library scsilib libtype=scsi
```

The library requires a path. The device name for the library is:

- AIX /dev/lb0
- Linux /dev/tmscsi/lb0
- Windows lb3.0.0.0

Define the path:

AIX

```
define path server1 scsilib srctype=server desttype=library
device=/dev/lb0
```

#### Linux

```
define path server1 scsilib srctype=server desttype=library
    device=/dev/tsm SCSI/lb0
```

#### Windows

```
define path server1 scsilib srctype=server desttype=library
    device=lb3.0.0.0
```

## DEFINE LIBRARY (Define a shared library)

Use this syntax to define a shared library.

### Privilege class

To issue this command, you must have system privilege or unrestricted storage privilege.

### Syntax

```
>>-DEFine LIBRARY--library_name--LIBType-----SHARED----->
>--PRIMarylibmanager-----server_name-----<<
```

### Parameters

library\_name (Required)

Specifies the name of the library to be defined. The maximum length of this name is 30 characters.

LIBType=SHARED (Required)

Specifies that the library is shared with another IBM Spectrum Protect™ server over a storage area network (SAN) or a dual SCSI connection to library drives.

Important: Specify this library type when you define the library on a library client.

PRIMarylibmanager

Specifies the name of the IBM Spectrum Protect server that is responsible for controlling access to library resources. You must define this server with the DEFINE SERVER command before you can use it as a library manager. This parameter is required and valid only if LIBTYPE=SHARED.

### Example: Define a shared library

In a SAN, define a library named SHARED TSM to a library client server named LIBMGR1

```
define library sharedtsm libtype=shared primarylibmanager=libmgr1
```

## DEFINE LIBRARY (Define a VTL library)

Use this syntax to define a library that has a SCSI-controlled media changer device that is represented by a virtual tape library (VTL).

### Privilege class

To issue this command, you must have system privilege or unrestricted storage privilege.

### Syntax

```
>>-DEFine LIBRARY--library_name--LIBType-----VTL----->
.-SHARED-----No----- .-RESETDrives-----No-----
>--+-----+-----+-----+-----+-----+----->
' -SHARED-----+Yes--+ ' | (1) |
      '-No--'      '-RESETDrives-----+Yes+-----'
                          '-No--'
```

```

.-AUTOLabel-----No----- .
>-----+----->
'-AUTOLabel-----+No-----+'
          +-Yes-----+
          '-OVERWRITE-'

.-RELABELSCRatch-----Yes----- .
>-----+----->
'-RELABELSCRatch-----+No-----+'
          '-Yes-'

.-SERial-----AUTODetect----- .
>-----+----->>
'-SERial-----+AUTODetect-----+'
          '-serial_number-'

```

Notes:

1. The default value of the RESETDRIVES parameter is conditional. If the SHARED parameter is set to NO, the value of the RESETDRIVES parameter is NO. If the SHARED parameter is set to YES, the value of the RESETDRIVES parameter is YES.

## Parameters

library\_name (Required)

Specifies the name of the library to be defined. The maximum length of this name is 30 characters.

LIBType=VTL (Required)

Specifies that the library has a SCSI-controlled media changer device that is represented by a virtual tape library. To mount volumes in drives in this type of library, the server uses the media changer device.

If you are defining a VTL library, your environment must not include any mixed-media and paths must be defined between all drives in the library and all defined servers, including storage agents, that use the library. If either of these characteristics are not true, the overall performance can degrade to the same levels as the SCSI library type; especially during times of high stress.

SHARED

Specifies whether this library is shared with other servers in a storage area network (SAN). This parameter is required when you define a library to the library manager.

YES

Specifies that this library can be shared with other servers. When you specify YES, the library manager server mounts volumes as requested by other servers and tracks drive and volume allocation to other servers.

NO

Specifies that this library cannot be shared with other servers. SHARED=NO is required if the library is controlled by passing commands through a NAS file server.

RESETDrives

Specifies whether the server preempts a drive reservation with persistent reserve when the server is restarted or when a library client or storage agent reconnection is established. If, for example, a storage agent becomes unavailable but is still holding the path to a drive, persistent reserve allows the server to break the storage agent's reservation and access the drive.

AIX

Windows

If persistent reserve is not supported, the server completes a reset of the path to the target device.

Linux

If persistent reserve is not supported, the server is not able to reset the path to the target device.

Support for persistent reservation has the following limitations:

- If you are using the IBM Spectrum Protect™ device driver, persistent reserve is only supported on some tape drives. See Technote 1470319 for details.
- If you are using the IBM® device driver, persistent reserve must be enabled at the device driver level. See the *IBM Tape Device Drivers Installation and User's Guide* for information about driver configuration.
- If you are using a virtual tape library that is emulating a supported drive, it might not support persistent reserve.

AIX

Windows

Yes

Specifies that drive preemption through persistent reserve or target reset are used. YES is the default for a library that is defined with SHARED=YES.

No

Specifies that drive preemption through persistent reserve or target reset are not used. NO is the default for a library that is defined with SHARED=NO. The RESETDRIVES parameter must be set to YES in a clustered environment when SHARED=NO.

#### Linux

Yes

Specifies that drive preemption through persistent reserve is used. YES is the default for a library that is defined with SHARED=YES.

No

Specifies that drive preemption through persistent reserve is not used. NO is the default for a library that is defined with SHARED=NO.

Note: A library manager will not be able to break a drive reservation if the system that has the drive reservation is not configured to use persistent reservation.

#### AUTOLabel

Specifies whether the server attempts to automatically label tape volumes. This parameter is optional. The default is NO.

To use this option, you must check in the tapes with CHECKLABEL=BARCODE on the CHECKIN LIBVOLUME command.

Restriction: If you are defining a library that has drives that are attached to a network-attached storage (NAS) device, you must use the LABEL LIBVOLUME command to label the volumes for this library.

No

Specifies that the server does not attempt to label any volumes.

Yes

Specifies that the server labels only unlabeled volumes.

#### OVERWRITE

Specifies that the server attempts to overwrite an existing label. The server overwrites existing labels *only* if both the existing label and the bar code label are not already defined in any server storage pool or volume history list.

#### RELABELSCRatch

Specifies whether the server relabels volumes that were deleted and returned to scratch. When this parameter is set to YES, a LABEL LIBVOLUME operation is started and the existing volume label is overwritten.

If you have both virtual and real volumes in your VTL, both types are relabeled when this parameter is enabled. If the VTL includes real volumes, specifying this option might impact performance.

Restriction: If you are defining a library that has drives that are attached to a network-attached storage (NAS) device, you must use the LABEL LIBVOLUME command to label the volumes for this library.

Yes

Specifies that the server relabels volumes that are deleted and returned to scratch. YES is the default.

No

Specifies that the server does not relabel volumes that are deleted and returned to scratch.

#### SERial

Specifies the serial number for the library that is being defined. This parameter is optional. The default is AUTODETECT.

If SERIAL=AUTODETECT, then when you define the path to the library, the serial number reported by the library is used as the serial number.

If SERIAL=*serial\_number*, then the number you entered is compared to the number detected by the server.

Attention: Depending on the capabilities of the device, SERIAL=AUTODETECT might not be supported. In this case, the serial number is reported as blank.

## Example: Define a VTL library

---

Define a library named VTLlib with a library type of VTL.

```
define library vtllib libtype=vtl
```

The library requires a path. The device name for the library is:

- **AIX** /dev/lb0
- **Linux** /dev/tmsmcsi/lb0
- **Windows** lb3.0.0.0

Define the path:

**AIX**

```
define path server1 vtllib srctype=server desttype=library
device=/dev/lb0
```

**Linux**

```
define path server1 vtllib srctype=server desttype=library
device=/dev/tmsmcsi/lb0
```

**Windows**

```
define path server1 vtllib srctype=server desttype=library
device=lb3.0.0.0
```

**AIX**

**Linux**

## DEFINE LIBRARY (Define a ZOSMEDIA library type)

---

Use this syntax to define a library that represents a TAPE or FILE storage resource that is maintained by Tivoli® Storage Manager for z/OS® Media.

Define a library of type ZOSMEDIA when you want the library to be exclusively managed by Tivoli Storage Manager for z/OS Media. The library appears to the IBM Spectrum Protect™ server as a logical storage device that does not require DRIVE definitions. A PATH definition is required for the server and any storage agents that need access to the ZOSMEDIA library resource.

### Privilege class

---

To issue this command, you must have system privilege or unrestricted storage privilege.

### Syntax

---

```
>>-DEFine LIBRARY--library_name--LIBType-----ZOSMEDIA-----<<
```

### Parameters

---

library\_name (Required)

Specifies the name of the library to be defined.

LIBType=ZOSMEDIA (Required)

Specifies that the library type is the ZOSMEDIA which represents a TAPE or FILE storage resource that is maintained by Tivoli Storage Manager for z/OS Media.

### Example: Configure a ZOSMEDIA library

---

The following example shows the steps needed to define and configure a zosmedia library. The configuration includes these components:

- A server named sahara
- A library defined as type zosmedia named zebra
- A z/OS media server named oasis
- A storage agent named mirage

Define a library named ZEBRA with a library type of ZOSMEDIA:

```
define library zebra libtype=zosmedia
```

Define the z/OS media server:



```
define server oasis serverpassword=sanddune
hladdress=9.289.19.67 lladdress=1777
```

The server requires a path to the library resource managed by Tivoli Storage Manager for z/OS Media:

```
define path sahara zebra srctype=server
desttype=library zosmediaserver=oasis
```

The storage agent requires a path to the library resource managed by Tivoli Storage Manager for z/OS Media:

```
define path mirage zebra srctype=server
desttype=library zosmediaserver=oasis
```

## DEFINE MACHINE (Define machine information for disaster recovery)

---

Use this command to save disaster recovery information for a server or client node machine. This information will be included in the plan file to help you recover your machines.

### Privilege class

---

To issue this command, you must have system privilege.

### Syntax

---

```
>>-DEFine MACHine--machine_name----->
>--+-----+--+-----+----->
  '-DESCRiption---description-'  '-BUilding---building-'
>--+-----+--+-----+----->
  '-FLoor---floor-'  '-ROom---room-'
. -PRIority---50----- . -ADSMServer---No-----
>--+-----+--+-----+-----><
  '-PRIority---number---'  '-ADSMServer---+No---+'
                               '-Yes-'
```

### Parameters

---

**machine\_name** (Required)

Specifies the machine name. The name can be up to 64 characters.

**DESCRiption**

Specifies a machine description. This parameter is optional. The text can be up to 255 characters. Enclose the text in quotation marks if it contains any blank characters.

**BUilding**

Specifies the building that this machine is in. This parameter is optional. The text can be up to 16 characters. Enclose the text in quotation marks if it contains any blank characters.

**FLoor**

Specifies the floor that this machine is on. This parameter is optional. The text can be up to 16 characters. Enclose the text in quotation marks if it contains any blank characters.

**ROom**

Specifies the room that this machine is in. This parameter is optional. The text can be up to 16 characters. Enclose the text in quotation marks if it contains any blank characters.

**PRIority**

Specifies the restore priority for the machine an integer from 1 to 99. The highest priority is 1. This parameter is optional. The default is 50.

**ADSMServer**

Specifies whether the machine is an IBM Spectrum Protect™ server. Only one machine can be defined as an IBM Spectrum Protect server. This parameter is optional. The default is NO. Possible values are:

No

This machine is not an IBM Spectrum Protect server.

Yes

This machine is an IBM Spectrum Protect server.

## Example: Define a machine's disaster recovery information

Define a machine named DISTRICT5, and specify a location, a floor, and a room name. This machine contains critical data and has the highest priority.

```
define machine district5 building=101 floor=27
room=datafacilities priority=1
```

## Related commands

Table 1. Commands related to DEFINE MACHINE

Command	Description
DEFINE MACHNODEASSOCIATION	Associates an IBM Spectrum Protect node with a machine.
DEFINE RECMEDMACHASSOCIATION	Associates recovery media with a machine.
DELETE MACHINE	Deletes a machine.
INSERT MACHINE	Inserts machine characteristics or recovery instructions into the IBM Spectrum Protect database.
QUERY MACHINE	Displays information about machines.
UPDATE MACHINE	Changes the information for a machine.

## DEFINE MACHNODEASSOCIATION (Associate a node with a machine)

Use this command to associate client nodes with a machine. During disaster recovery, you can use this information to identify the client nodes that resided on destroyed machines.

The machine must be defined and the nodes registered to IBM Spectrum Protect™.

To retrieve the information, issue the QUERY MACHINE command. This information will be included in the plan file to help you recover the client machines.

A node remains associated with a machine unless the node, the machine, or the association itself is deleted.

## Privilege class

To issue this command, you must have system privilege.

## Syntax

```
          .-------.
          v             |
>>-DEFine MACHNODEAssociation--machine_name----node_name+-----><
```

## Parameters

machine\_name (Required)

Specifies the machine name.

node\_name (Required)

Specifies the node names. A node can only be associated with one machine. To specify multiple nodes, separate the names with commas and no intervening spaces. You can use wildcard characters to specify a name.

## Example: Associate a node with a machine

Associate the node named ACCOUNTSPAYABLE with the machine named DISTRICT5.

```
define machnodeassociation district5 accountspayable
```

## Related commands

Table 1. Commands related to DEFINE MACHNODEASSOCIATION

Command	Description
DEFINE MACHINE	Defines a machine for DRM.
DELETE MACHINE	Deletes a machine.
DELETE MACHNODEASSOCIATION	Deletes association between a machine and node.
QUERY MACHINE	Displays information about machines.
REGISTER NODE	Defines a client node to the server and sets options for that user.
REMOVE NODE	Removes a client from the list of registered nodes for a specific policy domain.

## DEFINE MGMTCLASS (Define a management class)

Use this command to define a new management class in a policy set. To allow clients to use the new management class, you must activate the policy set that contains the new class.

You can define one or more management classes for each policy set in a policy domain. A management class can contain a backup copy group, an archive copy group, or both. The user of a client node can select any management class in the active policy set or use the default management class.

Attention: The DEFINE MGMTCLASS command fails if a copy storage pool is specified as the destination for files that were migrated by an IBM Spectrum Protect™ for Space Management client.

### Privilege class

To issue this command, you must have system privilege, unrestricted policy privilege, or restricted policy privilege for the policy domain to which the management class belongs.

### Syntax

```
>>-DEfIne MGmtclass--domain_name--policy_set_name--class_name-->
  .-SPACEMGTEchnique----NONE-----
>--+-----+----->
  '-SPACEMGTEchnique----+-AUTOMatic+-'
                                +-SElective+
                                '-NONE-----'

  .-AUTOMIGNOnuse----0----.
>--+-----+----->
  '-AUTOMIGNOnuse----days-'

  .-MIGREQUIRESBkup----Yes-----
>--+-----+----->
  '-MIGREQUIRESBkup----+-Yes+-'
                                '-No--'

  .-MIGDESTination----SPACEMGPOOL-.
>--+-----+----->
  '-MIGDESTination----pool_name---'

>--+-----+-----><
  '-DESCRiption----description-'
```

### Parameters

domain\_name (Required)

Specifies the policy domain to which the management class belongs.

**policy\_set\_name** (Required)  
Specifies the policy set to which the management class belongs. You cannot define a management class to the ACTIVE policy set.

**class\_name** (Required)  
Specifies the name of the new management class. The maximum length of this name is 30 characters. You cannot use either *default* or *grace\_period* as a class name.

**SPACEMGTECHnique**  
Specifies whether a file that is using this management class is eligible for migration. This parameter is optional. The default is NONE. This parameter is effective only for IBM Spectrum Protect for Space Management clients, not for backup-archive clients or application clients. Possible values are:

**AUTOMatic**  
Specifies that the file is eligible for both automatic migration and selective migration.

**SElective**  
Specifies that the file is eligible for selective migration only.

**NONE**  
Specifies that the file is not eligible for migration.

**AUTOMIGNOnuse**  
Specifies the number of days that must elapse since a file was last accessed before it is eligible for automatic migration. This parameter is optional. The default value is 0. If SPACEMGTECHNIQUE is not AUTOMATIC, the server ignores this attribute. You can specify an integer in the range 0 - 9999.

This parameter is effective only for IBM Spectrum Protect for Space Management clients, not for backup-archive clients or application clients.

**MIGREQUIRESBkup**  
Specifies whether a backup version of a file must exist before a file can be migrated. This parameter is optional. The default is YES. This parameter is effective only for IBM Spectrum Protect for Space Management clients, not for backup-archive clients or application clients. Possible values are:

**Yes**  
Specifies that a backup version must exist.

**No**  
Specifies that a backup version is optional.

**MIGDESTination**  
Specifies the primary storage pool where the server initially stores files that are migrated by IBM Spectrum Protect for Space Management clients. This parameter is effective only for IBM Spectrum Protect for Space Management clients, and is not effective for backup-archive clients or application clients. The default is SPACEMGPOOL.  
Your choice for the destination might depend on factors such as the following:

- The number of client nodes that are migrated to the storage pool. When many user files are stored in the same storage pool, volume contention can occur as users try to migrate files to or recall files from the storage pool.
- How quickly the files must be recalled. If you need immediate access to migrated versions, you can specify a disk storage pool as the destination.

The command fails if you specify a copy storage pool or an active-data pool as the destination.

**DESCription**  
Specifies a description of the management class. This parameter is optional. The maximum length of the description is 255 characters. Enclose the description in quotation marks if it contains any blank characters.

## Example: Define a management class for a specific policy set and policy domain

Define a management class that is called MCLASS1 for policy set SUMMER in the PROG1 policy domain. For IBM Spectrum Protect for Space Management clients, allow both automatic and selective migration, and store migrated files in the SMPOOL storage pool. Add the description, "Technical Support Mgmt Class."

```
define mgmtclass prog1 summer mclass1
spacemgtechnique=automatic migdestination=smpool
description="technical support mgmt class"
```

## Related commands

Table 1. Commands related to DEFINE MGMTCLASS

Command	Description
ASSIGN DEFMGMTCLASS	Assigns a management class as the default for a specified policy set.
COPY MGMTCLASS	Creates a copy of a management class.
DEFINE COPYGROUP	Defines a copy group for backup or archive processing within a specified management class.
DEFINE POLICYSET	Defines a policy set within the specified policy domain.
DELETE MGMTCLASS	Deletes a management class and its copy groups from a policy domain and policy set.
QUERY COPYGROUP	Displays the attributes of a copy group.
QUERY MGMTCLASS	Displays information about management classes.
QUERY POLICYSET	Displays information about policy sets.
UPDATE COPYGROUP	Changes one or more attributes of a copy group.
UPDATE MGMTCLASS	Changes the attributes of a management class.

## DEFINE NODEGROUP (Define a node group)

Use this command to define a node group. A *node group* is a group of client nodes that are acted upon as if they were a single entity. A node can be a member of one or more node groups.

### Privilege class

To issue this command, you must have system or unrestricted policy privilege.

### Syntax

```
>>-DEFine NODEGroup--group_name----->
>--+-----+-----><
  '-DESCription----description-'
```

### Parameters

**group\_name**

Specifies the name of the node group that you want to create. The maximum length of the name is 64 characters. The specified name may not be the same as any existing client node name.

**DESCription**

Specifies a description of the node group. This parameter is optional. The maximum length of the description is 255 characters. Enclose the description in quotation marks if it contains any blank characters.

### Example: Define a node group

Define a node group named `group1`.

```
define nodegroup group1
```

### Related commands

Table 1. Commands related to DEFINE NODEGROUP

Command	Description
DEFINE BACKUPSET	Defines a previously generated backup set to a server.

Command	Description
DEFINE NODEGROUPMEMBER	Adds a client node to a node group.
DELETE BACKUPSET	Deletes a backup set.
DELETE NODEGROUP	Deletes a node group.
DELETE NODEGROUPMEMBER	Deletes a client node from a node group.
GENERATE BACKUPSET	Generates a backup set of a client's data.
QUERY BACKUPSET	Displays backup sets.
QUERY NODEGROUP	Displays information about node groups.
UPDATE BACKUPSET	Updates a retention value associated with a backup set.
UPDATE NODEGROUP	Updates the description of a node group.

## DEFINE NODEGROUPMEMBER (Define node group member)

Use this command to add a client node to a node group. A *node group* is a group of client nodes that are acted upon as if they were a single entity.

### Privilege class

To issue this command you must have system or unrestricted policy privilege.

### Syntax

```

      .-|-----|
      v          |
>>-DEFine NODEGROUPMember--group_name----node_name+-----><

```

### Parameters

**group\_name**

Specifies the name of the node group to which you want to add a client node.

**node\_name**

Specifies the name of the client node that you want to add to the node group. You can specify one or more names. Separate multiple names with commas; do not use intervening spaces. You can also use wildcard characters when specifying multiple names.

### Example: Define node group members

Define two members, *node1* and *node2*, to a node group, *group1*.

```
define nodegroupmember group1 node1,node2
```

### Related commands

Table 1. Commands related to DEFINE NODEGROUPMEMBER

Command	Description
DEFINE BACKUPSET	Defines a previously generated backup set to a server.
DEFINE NODEGROUP	Defines a group of nodes.
DELETE BACKUPSET	Deletes a backup set.
DELETE NODEGROUP	Deletes a node group.
DELETE NODEGROUPMEMBER	Deletes a client node from a node group.
GENERATE BACKUPSET	Generates a backup set of a client's data.

Command	Description
QUERY BACKUPSET	Displays backup sets.
QUERY NODEGROUP	Displays information about node groups.
UPDATE BACKUPSET	Updates a retention value associated with a backup set.
UPDATE NODEGROUP	Updates the description of a node group.



## DEFINE PATH (Define a path)

Use this command to define a path for a source to access a destination. Both the source and destination must be defined before you can define a path. For example, if a path is required between a server and a drive, you must first issue the DEFINE DRIVE command and then issue the DEFINE PATH command. A path must be defined after you issue the DEFINE DRIVE command in order to make the drive usable by the server.

Syntax and parameter descriptions are available for the following path types.

- DEFINE PATH (Define a path when the destination is a drive)
- DEFINE PATH (Define a path when the destination is a library)
-  DEFINE PATH (Define a path when the destination is a ZOSMEDIA library)

For detailed and current device support information, see the Supported Devices website for your operating system:

-  Supported devices for AIX and Windows
-  Supported devices for Linux

## Related commands

Table 1. Commands related to DEFINE PATH

Command	Description
DEFINE DATAMOVER	Defines a data mover to the IBM Spectrum Protect server.
DEFINE DRIVE	Assigns a drive to a library.
DEFINE LIBRARY	Defines an automated or manual library.
DELETE PATH	Deletes a path from a source to a destination.
PERFORM LIBACTION	Defines all drives and paths for a library.
QUERY PATH	Displays information about the path from a source to a destination.
UPDATE DATAMOVER	Changes the definition for a data mover.
UPDATE PATH	Changes the attributes associated with a path.

## DEFINE PATH (Define a path when the destination is a drive)

Use this syntax when you define a path to a drive.

### Privilege class

To issue this command, you must have system privilege or unrestricted storage privilege.

### Syntax

```
>>-DEFine PATH--source_name--destination_name----->
>>-SRCType-----+DATAMover-+-----+----->
                '-SERVer----'  '-AUTODetect-----+No--+-'
                                     '-Yes-'
```

```

>--DESTType-----Drive--LIBRARY-----library_name----->
>----DEVICE-----+device_name+----->
      '-FILE-----'
      .-GENERICTAPE-----No----- .-ONLine-----Yes-----
>--+-----+-----+-----+----->
      '-GENERICTAPE-----+Yes+-' '-ONLine-----+Yes+-'
      '-No--' '-No--'
      .-DIRectory-----current_directory_name-.
>--+-----+-----+----->>
      |-----|
      |-----|
      |-----|
      '-DIRectory-----directory_name+-----'

```

## Parameters

source\_name (Required)

Specifies the name of source for the path. This parameter is required.

destination\_name (Required)

Specifies the name of the destination. This parameter is required.

SRCType (Required)

Specifies the type of the source. This parameter is required. Possible values are:

DATAMover

Specifies that a data mover is the source.

SERVer

Specifies that a storage agent is the source.

AUTODetect

Specifies whether the serial number for a drive is automatically updated in the database at the time that the path is defined. This parameter is optional. This parameter is only valid for paths that are defined from the local server to a drive. Possible values are:

No

Specifies that the serial number is not automatically updated. The serial number is still compared with what is already in the database for the device. The server issues a message if there is a mismatch.

Yes

Specifies that the serial number is not automatically updated to reflect the same serial number that the drive reports to the server.

Important:

1. If you did not set the serial number when you defined the drive, the server always tries to detect the serial number, and AUTODETECT defaults to YES. If you previously entered a serial number, then AUTODETECT defaults to NO.
2. The use of AUTODETECT=YES in this command means that the serial number set in the drive definition is updated with the detected serial number.
3. If you set DESTTYPE=DRIVE and AUTODETECT=YES, then the drive element number in the database is automatically changed to reflect the same element number that corresponds to the serial number of that drive. This is true for drives in a SCSI library. For more information about the element number, see DEFINE DRIVE.
4. Depending on the capabilities of the device, the AUTODETECT parameter might not be supported.

DESTType=DRive (Required)

Specifies that a drive is the destination. When the destination is a drive, you must specify a library name.

LIBRARY

Specifies the name of the library to which the drive is assigned. The library and its drives must already be defined to the server. If the path is from a NAS data mover to a library, the library must have LIBTYPE of SCSI, 349X, or ACSLS.

DEVICE

Specifies the name of the device as known to the source, or FILE if the device is a logical drive in a FILE library.

**AIX** | **Windows** The source uses the device name to access the drive. See Table 1 for examples.

Table 1. Examples of device names

Source to destination	Example
-----------------------	---------



Source to destination	Example
Server to a drive (not a FILE drive)	<p><b>AIX</b></p> <p>/dev/mt3</p> <p><b>Windows</b></p> <p>mt3</p>
Storage agent (on a Windows system) to a drive (not a FILE drive)	mt3
Storage agent to a drive when the drive is a logical drive in a FILE library	FILE
NAS data mover to a drive	<p>NetApp NAS file server: rst01</p> <p>EMC Celerra NAS file server: c436t011</p> <p>IBM® System Storage® N Series: rst01</p>

**Linux** The source uses the device name to access the drive. See Table 2 for examples.

Table 2. Examples of device names

Source to destination	Example
Server to a drive (not a FILE drive)	/dev/tmscsi/mt3
Storage agent to a drive (not a FILE drive)	/dev/tmscsi/mt3
Storage agent to a drive when the drive is a logical drive in a FILE library	FILE
NAS data mover to a drive	<p>NetApp NAS file server: rst01</p> <p>EMC Celerra NAS file server: c436t011</p> <p>IBM System Storage N Series: rst01</p>

Important:

- AIX** | **Linux** For 349X libraries, the alias name is a symbolic name that is specified in the /etc/ibmatl.conf file. **Windows** For 349X libraries, the alias name is a symbolic name that is specified in the c:\winnt\ibmatl.conf file. For more information, see *IBM Tape Device Drivers Installation and User's Guide*, which can be downloaded from the IBM Systems support site at <http://www.ibm.com/support/docview.wss?uid=ssg1S7002972>.
- For information about how to obtain names for devices that are connected to a NAS file server, consult the product information for the file server. For example, for a NetApp file server, connect to the file server using Telnet and issue the SYSCONFIG command. Use this command to determine device names for drives:

```
sysconfig -t
```

**Windows** GENERICTAPE

**Windows** Specifies whether the tape drive to be used is a GENERICTAPE device class type. If the device is a tape drive and is not supported by IBM Spectrum Protect™ but is supported for the Windows operating system, you can use it with the generic tape format. To use the drive, specify GENERICTAPE=Yes when you define a path to the drive. The default is No. Possible values are:

Yes

Specifies that the tape drive to be used is a GENERICTAPE device class type.

No

Specifies that the tape drive to be used is not a GENERICTAPE device class type.

ONLine

Specifies whether the path is available for use. This parameter is optional. The default is YES. Possible values are:

Yes

Specifies that the path is available for use.

No

Specifies that the path is not available for use.

The source and the destination must both be available to use the path.

For example, if the path from a data mover to a drive is online, but either the data mover or the drive is offline, you cannot use the path.

## DIRECTORY

Specifies the directory location or locations where the storage agent reads and writes the files that represent storage volumes for the FILE device class that is associated with the FILE library. The DIRECTORY parameter is also used for devices of type REMOVABLEFILE. For REMOVABLEFILE devices, the DIRECTORY parameter provides information for the server (not a storage agent) along with the DRIVE parameter to describe access to the device. This parameter is optional. For a path from a storage agent to a FILE device, this parameter is only valid when *all* of the following conditions are true:

- The source type is SERVER (meaning a storage agent that has been defined as a server to this server).
- The source name is the name of a storage agent, *not* the server.
- The destination is a logical drive that is part of a FILE library that is created when the device class was defined.

If you specified multiple directories for the device class associated with the FILE library, you must specify the same number of directories for each path to the FILE library. Do not change or move existing directories on the server that the storage agent is using so that the device class and the path remain synchronized. Adding directories is permitted. Specifying a mismatched number of directories can cause a runtime failure.

The default value for DIRECTORY is the directory of the server at the time the command is issued. The Windows registry is used to locate the default value.

Use a naming convention that you can use to associate the directory with a particular physical drive. This can help ensure that your configuration is valid for sharing the FILE library between the server and storage agent. If the storage agent is on a Windows system, use a universal naming convention (UNC) name. When the storage agent lacks permission to access remote storage, it experiences mount failures.

**Windows** The account that is associated with the storage agent service must either be an account within the local administrator's group or an account within the domain administrator's group. If the account is in the local administrator's group, the user ID and password must match that of an account with permissions to access storage as provided by the system that administers the remote share. For example, if a SAMBA server is providing access to remote storage, the user ID and password in the SAMBA configuration must match that of the local administrator user ID and password associated with the storage agent service.

```
define devclass file devtype=file shared=yes mountlimit=1
directory=d:\filedir\dir1
define path stal file1 srctype=server desttype=drive
library=file1 device=file
directory=\\192.168.1.10\filedir\dir1
```

In the previous example, the DEFINE DEVCLASS command establishes the shared file system in the directory that is accessed by the server as D:\FILEDIR\DIR1. The storage agent, however, is using UNC name \\192.168.1.10\FILEDIR\DIR1. This means that the system with TCP/IP address 192.168.1.10 is sharing the same directory using FILEDIR as the shared name. Also, the storage agent service has an account that can access this storage. It can access it either because it is associated with a local account with the same user ID and password as 192.168.1.10 or it is associated with a domain account that is available on both the storage agent and on 192.168.1.10. If appropriate to the installation, you can replace the 192.168.1.10 with a symbolic name such as:

```
example.yourcompany.com
```

Attention:

1. Storage agents access FILE volumes by replacing a directory name in a volume name with a directory name from a directory in the list provided with the DEFINE PATH command. Directories that are specified with this parameter are not validated on the server.
2. IBM Spectrum Protect does not create shares or permissions, or mount the target file system. You must complete these actions before you start the storage agent.

## Example: Define a path from a server to a drive

---

Define a path from a server to a drive. In this case, the server name is *NET1*, the drive name is *TAPEDRV6*, the library is *NETLIB*, and the device name is *mt4*. Set AUTODETECT to NO.

```
define path net1 tapedrv6 srctype=server autodetect=no desttype=drive
library=netlib device=mt4
```

## Example: Define a path from a data mover server to a drive for backup and restore

---

Define a path from the data mover that is a NAS file server to the drive that the NAS file server will use for backup and restore operations. In this example, the NAS data mover is *NAS1*, the drive name is *TAPEDRV3*, the library is *NASLIB*, and the device name for the drive is *rst01*.

```
define path nas1 tapedrv3 srctype=datamover desttype=drive library=naslib
device=rst01
```

Linux

## Example: Define a path from a storage agent to a drive for backup and restore

Define a path from storage agent *SA1* to the drive that the storage agent uses for backup and restore operations. In this example, the library is *TSMLIB*, the drive is *TAPEDRV4*, and the device name for the drive is */dev/tmsmcsi/mt3*.

```
define path sa1 tapedrv4 srctype=server desttype=drive library=tsmlib
device=/dev/tmsmcsi/mt3
```

AIX

Windows

## Example: Define a path from a storage agent to a drive for backup and restore

Define a path from storage agent *SA1* to the drive that the storage agent uses for backup and restore operations. In this example, the library is *TSMLIB*, the drive is *TAPEDRV4*, and the device name for the drive is */dev/mt3*.

```
define path sa1 tapedrv4 srctype=server desttype=drive library=tsmlib
device=/dev/mt3
```

AIX

Windows

## Example: Define a path to give a storage agent access to shared disk storage

Define a path that gives the storage agent access to files on disk storage that is shared with the server. Drive *FILE9* is defined to library *FILE1* on the server. The storage agent *SA1* accesses *FILE9*. On the storage agent, this data is on directory *\\192.168.1.10\filedata*.

AIX

The data for *FILE9* resides on the server at */tsmdata/filedata*.

Windows

The data for *FILE9* resides on the server at *d:\tsmdata\filedata*.

```
define path sa1 file9 srctype=server desttype=drive library=file1 device=file
directory="\\192.168.1.10\filedata"
```

## Example: Configure a storage agent to use a FILE library

The following example illustrates the importance of matching device classes and paths to ensure that storage agents can access newly created FILE volumes.

Suppose you want to use these three directories for a FILE library: **Windows**

- c:\server
- d:\server
- e:\server

AIX

Linux

- /opt/tivoli1
- /opt/tivoli2
- /opt/tivoli3

1. Use the following command to set up a FILE library named *CLASSA* with one drive named *CLASSA1* on *SERVER1*: **Windows**

```
define devclass classa devtype=file
directory="c:\server,d:\server,e:\server"
shared=yes mountlimit=1
```

AIX

Linux

```
define devclass classa devtype=file
directory="/opt/tivoli1,/opt/tivoli2,/opt/tivoli3"
```

```
shared=yes mountlimit=1
```

2. You want the storage agent STA1 to be able to use the FILE library, so you define the following path for storage agent STA1:

**Windows**

```
define path stal class1 srctype=server desttype=drive device=file
directory="\\192.168.1.10\c\server,\\192.168.1.10\d\server,
\\192.168.1.10\e\server" library=classa
```

**AIX** | **Linux**

```
define path stal class1 srctype=server desttype=drive device=file
directory="/opt/ibm1,/opt/ibm2,/opt/ibm3" library=classa
```

**Windows**

In this scenario, the storage agent, STA1, replaces the directory name c:\server with the directory name \\192.168.1.10\c\server to access FILE volumes that are in the c:\server directory on the server.

**AIX** | **Linux**

In this scenario, the storage agent, STA1, replaces the directory name /opt/tivoli1 with the directory name /opt/ibm1/ to access FILE volumes that are in the /opt/tivoli1 directory on the server.

3. **Windows** File volume c:\server\file1.dsm is created by SERVER1. If you later change the first directory for the device class with the following command:

```
update devclass classa directory="c:\otherdir,d:\server,e:\server"
```

SERVER1 is still able to access file volume c:\server\file1.dsm, but the storage agent STA1 is not able to access it because a matching directory name in the PATH directory list no longer exists. If a directory name is not available in the directory list that is associated with the device class, the storage agent can lose access to a FILE volume in that directory. Although the volume is still accessible from the server for reading, failure of the storage agent to access the FILE volume can cause operations to be retried on a LAN-only path or to fail.

4. If file volume /opt/tivoli1/file1.dsm is created on SERVER1, and if the following command is issued,

```
update devclass classa directory="/opt/otherdir,/opt/tivoli2,
/opt/tivoli3"
```

SERVER1 is still able to access file volume /opt/tivoli1/file1.dsm, but the storage agent STA1 is not able to access it because a matching directory name in the PATH directory list no longer exists. If a directory name is not available in the directory list that is associated with the device class, the storage agent can lose access to a FILE volume in that directory. Although the volume is still accessible from the server for reading, failure of the storage agent to access the FILE volume can cause operations to be retried on a LAN-only path or to fail.

## DEFINE PATH (Define a path when the destination is a library)

Use this syntax when defining a path to a library.

### Privilege class

To issue this command you must have system privilege or unrestricted storage privilege.

### Syntax

```
>>-DEFine PATH--source_name--destination_name----->
                                     (1)
>>-SRCType-----+DATAMover-----+----->
                '-SERVer-----'   '-AUTODetect-----+No---+'
                                     '-Yes-'
>>-DESTType-----LIBRARY--+-DEVIce-----device_name-----+----->
                '-EXTERNALManager---path_name-'
                .-ONLine-----Yes-----
>--+-----+-----><
    '-ONLine-----+Yes-+-'
                '-No--'
```

Notes:

1. DATAMOVER only applies to NAS devices.

## Parameters

source\_name (Required)

Specifies the name of source for the path. This parameter is required.

destination\_name (Required)

Specifies the name of the destination. This parameter is required.

Attention: To define a path from a NAS data mover to a library, the library must have LIBTYPE of SCSI, 349x, or ACSLS.

SRCType (Required)

Specifies the type of the source. This parameter is required. Possible values are:

DATAMover

Specifies that a data mover is the source.

SERVer

Specifies that a storage agent is the source.

AUTODetect

Specifies whether the serial number for a drive or library will be automatically updated in the database at the time that the path is defined. This parameter is optional. This parameter is only valid for paths defined from the local server to a drive or a library. Possible values are:

No

Specifies that the serial number will not be automatically updated. The serial number is still compared with what is already in the database for the device. The server issues a message if there is a mismatch.

Yes

Specifies that the serial number will be automatically updated to reflect the same serial number that the drive reports to IBM Spectrum Protect™.

Important:

1. If you did not set the serial number when you defined the drive or the library, the server always tries to detect the serial number, and AUTODETECT defaults to YES. If you have previously entered a serial number, then AUTODETECT defaults to NO.
2. The use of AUTODETECT=YES in this command means that the serial number set in the drive or library definition is updated with the detected serial number.
3. Depending on the capabilities of the device, the AUTODETECT parameter may not be supported.

DESTType=LIBRARY (Required)

Specifies that a library is the destination. This parameter is required.

DEVICE

Specifies the name of the device as known to the source, or FILE if the device is a logical drive in a FILE library.

**AIX** | **Windows** The source uses the device name to access the library. See Table 1 for examples.

Table 1. Examples of device names

Source to destination	Example
Server to a library	<p><b>AIX</b></p> <p>/dev/lb4</p> <p><b>Linux</b></p> <p>/dev/tmsmcsi/lb4</p> <p><b>Windows</b></p> <p>lb4.1</p>
Storage agent to a drive when the drive is a logical drive in a FILE library	FILE
NAS data mover to a library	mc0

**Linux** The source uses the device name to access the library. See Table 2 for examples.

Table 2. Examples of device names

Source to destination	Example
Server to a library	/dev/tmsmcsi/lb4
NAS data mover to a library	mc0

Important:

- **AIX** | **Linux** For 349X libraries, the alias name is a symbolic name that is specified in the /etc/ibmatl.conf file. **Windows** For 349X libraries, the alias name is a symbolic name that is specified in the c:\winnt\ibmatl.conf file. For more information, see *IBM Tape Device Drivers Installation and User's Guide*, which can be downloaded from the IBM® Systems support site at <http://www.ibm.com/support/docview.wss?uid=ssg1S7002972>.
- For information about how to obtain names for devices that are connected to a NAS file server, consult the product information for the file server. For example, for a NetApp file server, connect to the file server using Telnet and issue the SYSCONFIG command. Use this command to determine device names for drives:

```
sysconfig -t
```

Use this command to determine the device name for a library:

```
sysconfig -m
```

#### EXTERNALManager

Specifies the location of the external library manager where IBM Spectrum Protect can send media access requests. Use single quotation marks around the value of this parameter. For example, enter: **AIX**

```
/usr/lpp/GESedt-acsls/bin/elmdt
```

**Linux**

```
/opt/GESedt-acsls/bin/elmdt
```

**Windows**

```
C:\Program Files\GES\EDT-ACSLs\bin\elmdt.exe
```

This parameter is required when the library name is an external library.

#### ONLine

Specifies whether the path is available for use. This parameter is optional. The default is YES. Possible values are:

Yes

Specifies that the path is available for use.

No

Specifies that the path is not available for use.

The source and the destination must both be available to use the path.

Attention: If the path to a library is offline, the server will not be able to access the library. If the server is halted and restarted while the path to the library is offline, the library will not be initialized.

## Example: Define a path from a server to a library

Define a path from the server SATURN to the SCSI type library SCsilIB: **AIX**

```
define path saturn scsilib srctype=server  
desttype=library device=/dev/lb3
```

**Linux**

```
define path saturn scsilib srctype=server  
desttype=library device=/dev/tmscsi/lb3
```

**Windows**

```
define path saturn scsilib srctype=server  
desttype=library device=lb3.0.0.0
```

**AIX** | **Linux**

## DEFINE PATH (Define a path when the destination is a ZOSMEDIA library)

Use this syntax when defining a path to a ZOSMEDIA library. You must first define the z/OS® media server in your configuration with the DEFINE SERVER command.

## Privilege class

---

To issue this command you must have system privilege or unrestricted storage privilege.

## Syntax

---

```
>>-DEFine PATH--source_name--destination_name----->
>--SRCType-----SERVer--DESTType-----LIBRary----->
                                     .-ONLine-----Yes-----.
>--ZOSMEDIASERVER-----server_name--+-----+-----><
                                     '-ONLine-----+Yes+-'
                                     '-No--'
```

## Parameters

---

source\_name (Required)

Specifies the name of source for the path.

destination\_name (Required)

Specifies the name of the ZOSMEDIA library.

SRCType=SERVer (Required)

Specifies that a storage agent or server is the source.

DESTType=LIBRary (Required)

Specifies that a library is the destination.

ZOSMEDIAServer (Required)

Specifies the name of the server that represents a Tivoli® Storage Manager for z/OS Media server.

ONLine

Specifies whether the path is available for use. This parameter is optional. The default is YES. Possible values are:

Yes

Specifies that the path is available for use.

No

Specifies that the path is not available for use.

The source and the destination must both be available to use the path.

Attention: If the path to a library is offline, the server will not be able to access the library. If the server is halted and restarted while the path to the library is offline, the library will not be initialized.

If the z/OS media server cannot be accessed during initialization of the IBM Spectrum Protect™ server, the library path will be set offline. Use the UPDATE PATH command and specify ONLINE=YES to vary the ZOSMEDIA library back online.

## DEFINE POLICYSET (Define a policy set)

---

Use this command to define a policy set in a policy domain. A policy set contains management classes, which contain copy groups. You can define one or more policy sets for each policy domain.

To put a policy set into effect, you must activate the policy set by using the ACTIVATE POLICYSET command. Only one policy set can be active in a policy domain. The copy groups and management classes within the active policy set determine the rules by which client nodes perform backup, archive, and space management operations, and how the client files stored are managed.

Use the VALIDATE POLICYSET command to verify that a policy set is complete and valid before activating it with the ACTIVATE POLICYSET command.

## Privilege class

---

To issue this command you must have system privilege, unrestricted policy privilege, or restricted policy privilege for the policy domain to which the policy set belongs.

## Syntax

---

```
>>-DEFine Policyset--domain_name--policy_set_name----->
>--+-----+-----><
  '-DESCRiption----description-'
```

## Parameters

domain\_name (Required)

Specifies the name of the policy domain to which the policy set belongs.

policy\_set\_name (Required)

Specifies the name of the policy set. The maximum length of this name is 30 characters. You cannot define a policy set named ACTIVE.

DESCRiption

Specifies a description for the new policy set. This parameter is optional. The maximum length of the description is 255 characters. Enclose the description in quotation marks if it contains any blank characters.

## Example: Define a policy set

Define a policy set called `SUMMER` for the `PROG1` policy domain and include the description, "Programming Group Policies."

```
define policyset prog1 summer
description="Programming Group Policies"
```

## Related commands

Table 1. Commands related to DEFINE POLICYSET

Command	Description
ACTIVATE POLICYSET	Validates and activates a policy set.
COPY MGMTCLASS	Creates a copy of a management class.
COPY POLICYSET	Creates a copy of a policy set.
DEFINE DOMAIN	Defines a policy domain that clients can be assigned to.
DEFINE MGMTCLASS	Defines a management class.
DELETE POLICYSET	Deletes a policy set, including its management classes and copy groups, from a policy domain.
QUERY POLICYSET	Displays information about policy sets.
UPDATE POLICYSET	Changes the description of a policy set.
VALIDATE POLICYSET	Verifies and reports on conditions the administrator must consider before activating the policy set.

## DEFINE PROFASSOCIATION (Define a profile association)

Use this command on a configuration manager to associate one or more objects with a configuration profile for distribution to subscribing managed servers. After a managed server subscribes to a profile, the configuration manager sends object definitions associated with the profile to the managed server where they are stored in the database. Objects created this way in the database of a managed server become managed objects. An object can be associated with more than one profile.

You can use this command to define an initial set of profile associations and to add to existing associations.

You can associate the following types of objects with a profile:

- Administrator registrations and authorities
- Policy domains, which include the domains' policy sets, management classes, copy groups, and client schedules
- Administrative schedules
- Server command scripts
- Client option sets
- Server definitions



- Server group definitions

Tip: The configuration manager does not distribute status information for an object to managed servers. For example, information such as the number of days since an administrator last accessed the server is not distributed to managed servers. This type of information is maintained in the databases of the individual managed servers.

## Privilege class

To issue this command, you must have system privilege.

## Syntax

```
>>-DEFINE PROFASSOCIation--profile_name----->
>--+-----+-----+-----+----->
  '-ADMinS---+*-----+-----+'
      | .-,------. |
      | V             | |
      '---admin_name-+-'

>--+-----+-----+-----+----->
  '-DObains---+*-----+-----+'
      | .-,------. |
      | V             | |
      '---domain_name-+-'

>--+-----+-----+-----+----->
  '-ADScheds---+*-----+-----+'
      | .-,------. |
      | V             | |
      '---schedule_name-+-'

>--+-----+-----+-----+----->
  '-SCRipts---+*-----+-----+'
      | .-,------. |
      | V             | |
      '---script_name-+-'

>--+-----+-----+-----+----->
  '-CLOptsets---+*-----+-----+'
      | .-,------. |
      | V             | |
      '---option_set_name-+-'

>--+-----+-----+-----+----->
  '-SERVers---+*-----+-----+'
      | .-,------. |
      | V             | |
      '---server_name-+-'

>--+-----+-----+-----+----->>
  '-SERVERGroups---+*-----+-----+'
      | .-,------. |
      | V             | |
      '---group_name-+-'
```

## Parameters

profile\_name (Required)

Specifies the name of the configuration profile.

ADMinS

Specifies administrators to associate with the profile. You can use wildcard characters in the names. You can specify more than one name by separating the names with commas and no intervening spaces. Use the match-all definition, an asterisk (\*) by itself, to specify all administrators that are registered with the configuration manager. If you specify the match-all definition and later add more administrators, they are automatically distributed through the profile.

The configuration manager distributes the administrator name, password, contact information, and authorities of administrators associated with the profile. The configuration manager does not distribute the following:

- The administrator named SERVER\_CONSOLE, even if you use a match-all definition
- The locked or unlocked status of an administrator

When the profile already has administrators associated with it, the following apply:

- If you specify a list of administrators and a list already exists, IBM Spectrum Protect™ combines the new list with the existing list.
- If you specify a match-all definition and a list of administrators already exists, IBM Spectrum Protect replaces the list with the match-all definition.
- If you specify a list of administrators, and a match-all definition had previously been specified, IBM Spectrum Protect ignores the list. To remove the match-all definition, issue the DELETE PROFASSOCIATION command with the ADMINS=\* parameter.

#### DOmains

Specifies policy domains to associate with the profile. You can use wildcard characters in the names. You can specify more than one name by separating the names with commas and no intervening spaces. Use the match-all definition, an asterisk (\*) by itself, to specify all domains that are defined on the configuration manager. If you specify the match-all definition and later add more domains, they are automatically distributed through the profile.

The configuration manager distributes domain information that includes definitions of policy domains, policy sets, management classes, copy groups, and client schedules. The configuration manager does not distribute the ACTIVE policy set. Administrators on a managed server can activate any policy set within a managed domain on a managed server.

When the profile already has domains associated with it, the following apply:

- If you specify a list of domains and a list already exists, IBM Spectrum Protect combines the new list with the existing list.
- If you use a match-all definition and a list of domains already exists, IBM Spectrum Protect replaces the list with the match-all definition.
- If you specify a list of domains, and a match-all definition had previously been specified, IBM Spectrum Protect ignores the list. To remove the match-all definition, issue the DELETE PROFASSOCIATION command with the DOMAINS=\* parameter.

Important: Client operations such as backup and archive fail if destination pools do not exist. Therefore, managed servers that subscribe to this profile must have definitions for any storage pools specified as destinations in the associated domains. Use the RENAME STGPOOL command to rename existing storage pools to match the destination names distributed.

#### ADSCHeds

Specifies administrative schedules to associate with the profile. You can use wildcard characters in the names. You can specify more than one name by separating the names with commas and no intervening spaces. Use the match-all definition, an asterisk (\*) by itself, to specify all administrative schedules that are defined on the configuration manager. If you specify the match-all definition and later add more administrative schedules, they are automatically distributed through the profile.

Tip: Administrative schedules are not active when they are distributed by a configuration manager. An administrator on a managed server must activate any schedule to have it run on that server.

When the profile already has administrative schedules associated with it, the following apply:

- If you specify a list of administrative schedules and a list already exists, IBM Spectrum Protect combines the new list with the existing list.
- If you use a match-all definition and a list of administrative schedules already exists, IBM Spectrum Protect replaces the list with the match-all definition.
- If you specify a list of administrative schedules, and a match-all definition had previously been specified, IBM Spectrum Protect ignores the list. To remove the match-all definition, issue the DELETE PROFASSOCIATION command with the ADSCHEDS=\* parameter.

#### SCRipts

Specifies server command scripts to associate with the profile. You can use wildcard characters in the names. You can specify more than one name by separating the names with commas and no intervening spaces. Use the match-all definition, an asterisk (\*) by itself, to specify all scripts that are defined on the configuration manager. If you specify the match-all definition and later add more scripts, they are automatically distributed through the profile.

When the profile already has scripts associated with it, the following apply:

- If you specify a list of scripts and a list already exists, IBM Spectrum Protect combines the new list with the existing list.

- If you use a match-all definition and a list of scripts already exists, IBM Spectrum Protect replaces the list with the match-all definition.
- If you specify a list of scripts, and a match-all definition had previously been specified, IBM Spectrum Protect ignores the list. To remove the match-all definition, issue the DELETE PROFASSOCIATION command with the SCRIPTS=\* parameter.

### CLOptsets

Specifies client option sets to associate with the profile. You can use wildcard characters in the names. You can specify more than one name by separating the names with commas and no intervening spaces. Use the match-all definition, an asterisk (\*) by itself, to specify all client option sets that are defined on the configuration manager. If you specify the match-all definition and later add more client option sets, they are automatically distributed through the profile.

When the profile already has client option sets associated with it, the following apply:

- If you specify a list of client option sets and a list already exists, IBM Spectrum Protect combines the new list with the existing list.
- If you use a match-all definition and a list of client option sets already exists, IBM Spectrum Protect replaces the list with the match-all definition.
- If you specify a list of client option sets, and a match-all definition had previously been specified, IBM Spectrum Protect ignores the list. To remove the match-all definition, issue the DELETE PROFASSOCIATION command with the CLOPSETS=\* parameter.

### SERVers

Specifies server definitions to associate with the profile. The definitions are distributed to managed servers that subscribe to this profile. You can use wildcard characters in the names. You can specify more than one name by separating the names with commas and no intervening spaces. Use the match-all definition, an asterisk (\*) by itself, to specify all servers that are defined on the configuration manager. If you specify the match-all definition and later add more servers, they are automatically distributed through the profile.

The configuration manager distributes the following server attributes: communication method, IP address, port address, server password, URL, and the description. Distributed server definitions always have the ALLOWREPLACE attribute set to YES on the managed server, regardless of this parameter's value on the configuration manager. On the managed server, you can use the UPDATE SERVER command to set all other attributes.

When the profile already has servers associated with it, the following apply:

- If you specify a list of servers and a list already exists, IBM Spectrum Protect combines the new list with the existing list.
- If you use a match-all definition and a list of servers already exists, IBM Spectrum Protect replaces the list with the match-all definition.
- If you specify a list of servers, and a match-all definition had previously been specified, IBM Spectrum Protect ignores the list. To remove the match-all definition, issue the DELETE PROFASSOCIATION command with the SERVERS=\* parameter.

### Important:

1. A server definition on a managed server is not replaced by a definition from the configuration manager unless you have allowed replacement of the definition on the managed server. To allow replacement, on the managed server update the server definition by using the UPDATE SERVER command with ALLOWREPLACE=YES.
2. If a configuration manager distributes a server definition to a managed server, and a server group of the same name exists on the managed server, the distributed server definition replaces the server group definition.

### SERVERGroups

Specifies server groups to associate with the profile. You can use wildcard characters in the names. You can specify more than one name by separating the names with commas and no intervening spaces. Use the match-all definition, an asterisk (\*) by itself, to specify all server groups that are defined on the configuration manager. If you specify the match-all definition and later add more server groups, they are automatically distributed through the profile.

Tip: A configuration manager does not distribute a server group definition to a managed server if the managed server has a server defined with the same name as that of the server group.

When the profile already has server groups associated with it, the following apply:

- If you specify a list of server groups and a list already exists, IBM Spectrum Protect combines the new list with the existing list.
- If you use a match-all definition and a list of server groups already exists, IBM Spectrum Protect replaces the list with the match-all definition.

- If you specify a list of server groups, and a match-all definition had previously been specified, IBM Spectrum Protect ignores the list. To remove the match-all definition, issue the DELETE PROFASSOCIATION command with the SERVERGROUPS=\* parameter.

## Example: Associate a specific domain with a specific profile

Associate a domain named MARKETING with a profile named DELTA.

```
define profassociation delta domains=marketing
```

## Example: Associate all domains with a specific profile

You have already associated a list of domains with a profile named GAMMA. Now associate all domains defined on the configuration manager with the profile.

```
define profassociation gamma domains=*
```

## Related commands

Table 1. Commands related to DEFINE PROFASSOCIATION

Command	Description
COPY PROFILE	Creates a copy of a profile.
DEFINE PROFILE	Defines a profile for distributing information to managed servers.
DELETE PROFASSOCIATION	Deletes the association of an object with a profile.
DELETE PROFILE	Deletes a profile from a configuration manager.
LOCK PROFILE	Prevents distribution of a configuration profile.
NOTIFY SUBSCRIBERS	Notifies servers to refresh their configuration information.
QUERY PROFILE	Displays information about configuration profiles.
SET CONFIGMANAGER	Specifies whether a server is a configuration manager.
UNLOCK PROFILE	Enables a locked profile to be distributed to managed servers.
UPDATE PROFILE	Changes the description of a profile.

## DEFINE PROFILE (Define a profile)

Use this command on a configuration manager to define a profile (a set of configuration information) that can be distributed to managed servers.

After defining a profile, you can use the DEFINE PROFASSOCIATION command to specify objects to be distributed to managed servers subscribing to the profile.

### Privilege class

To issue this command, you must have system privilege.

### Syntax

```
>>-DEFine PROFILE--profile_name----->
>--+-----+-----><
  '-DESCRiption----description-'
```

### Parameters

*profile\_name* (Required)

Specifies the name of the profile. The maximum length of the name is 30 characters.

DESCRIption  
Specifies a description of the profile. The maximum length of the description is 255 characters. Enclose the description in quotation marks if it contains any blank characters. This parameter is optional.

## Example: Define a new profile

Define a profile named ALPHA with a description of "Programming Center."

```
define profile alpha
description="Programming Center"
```

## Related commands

Table 1. Commands related to DEFINE PROFILE

Command	Description
COPY PROFILE	Creates a copy of a profile.
DEFINE PROFASSOCIATION	Associates objects with a profile.
DEFINE SUBSCRIPTION	Subscribes a managed server to a profile.
DELETE PROFASSOCIATION	Deletes the association of an object with a profile.
DELETE PROFILE	Deletes a profile from a configuration manager.
LOCK PROFILE	Prevents distribution of a configuration profile.
QUERY PROFILE	Displays information about configuration profiles.
SET CONFIGMANAGER	Specifies whether a server is a configuration manager.
UNLOCK PROFILE	Enables a locked profile to be distributed to managed servers.
UPDATE PROFILE	Changes the description of a profile.

## DEFINE RECMEDMACHASSOCIATION (Associate recovery media with a machine)

Use this command to associate recovery media with one or more machines. A machine is associated with recovery media so that the location of the boot media and its list of volume names are available to recover the machine. To retrieve the information, issue the QUERY MACHINE command. This information will be included in the plan file to help you recover the client machines.

To associate a machine with recovery media, both the machine and media must be defined to IBM Spectrum Protect™. A machine remains associated with the media until the association, the media, or the machine is deleted.

### Privilege class

To issue this command, you must have system privilege.

### Syntax

```
>>>DEFINE RECMEDMACHAssociation--media_name---machine_name+---<<
      .------ .
      v         |
```

### Parameters

media\_name (Required)

Specifies the name of the recovery media with which one or more machines will be associated.

machine\_name (Required)

Specifies the name of the machines to be associated with the recovery media. A machine can be associated with multiple recovery media. To specify a list of machines, separate the names with commas and no intervening spaces. You can use

wildcard characters to specify a name.

## Example: Associate machines to recovery media

Associate machines DISTRICT1 and DISTRICT5 to the DIST5RM recovery media.

```
define recmedmachassociation dist5rm
district1,district5
```

## Related commands

Table 1. Commands related to DEFINE RECMEDMACHASSOCIATION

Command	Description
DEFINE MACHINE	Defines a machine for DRM.
DEFINE RECOVERYMEDIA	Defines the media required to recover a machine.
DELETE MACHINE	Deletes a machine.
DELETE RECMEDMACHASSOCIATION	Deletes association between recovery media and a machine.
DELETE RECOVERYMEDIA	Deletes recovery media.
QUERY MACHINE	Displays information about machines.
QUERY RECOVERYMEDIA	Displays media available for machine recovery.

## DEFINE RECOVERYMEDIA (Define recovery media)

Use this command to define the media needed to recover a machine. The same media can be associated with multiple machines. To display the information, use the QUERY MACHINE command. This information will be included in the plan file to help you to recover the client machines.

## Privilege class

To issue this command, you must have system privilege.

## Syntax

```
>>-DEfIne RECOVERYMedia--media_name----->
>+-----+-----+-----+-----+----->
|          .-,-----.|
|          v          ||
|'-VOLumenames-----volume_name-+-'|
>+-----+-----+-----+-----+----->
|'-DEScRiption-----description-'  '-LOcation-----location-'
|
|.-Type-----Other-----|
>+-----+-----+-----+-----+----->
|'-Type-----+Other-+-'  '-PRoDuct-----product_name-'
|          '-BoOt--'|
>+-----+-----+-----+-----+-----><
|'-PRoDuctInfo-----product_information-'
```

## Parameters

media\_name (Required)

Specifies the name of the recovery media to be defined. The name can be up to 30 characters.

VOLumenames

Specifies the names of volumes that contain the recoverable data (for example, operating system image copies). This parameter is required if you specify a media type of BOOT. Specify boot media volume names in the order in which they are

to be inserted into the machine at recovery time. The maximum length of the volume names list is 255 characters. Enclose the list in quotation marks if it contains any blank characters.

**DESCRiption**

Specifies the description of the recovery media. This parameter is optional. The maximum length is 255 characters. Enclose the text in quotation marks if it contains any blank characters.

**LOcation**

Specifies the location of the recovery media. This parameter is optional. The maximum length is 255 characters. Enclose the text in quotation marks if it contains any blank characters.

**Type**

Specifies the type of recovery media. This parameter is optional. The default is OTHER.

**BOot**

Specifies that this is boot media. You must specify volume names if the type is BOOT.

**OTHer**

Specifies that this is not boot media. For example, a CD that contains operating system manuals.

**PROduct**

Specifies the name of the product that wrote to this media. This parameter is optional. The maximum length is 16 characters. Enclose the text in quotation marks if it contains any blank characters.

**PRoDUCTInfo**

Specifies information about the product that wrote to the media. This would be information that you may need to restore the machine. This parameter is optional. The maximum length is 255 characters. Enclose the text in quotation marks if it contains any blank characters.

## Example: Define the media needed to recover a machine

---

Define the recovery media named DIST5RM. Include a description and the location.

```
define recoverymedia dist5rm
description="district 5 base system image"
location="district 1 vault"
```

## Related commands

---

Table 1. Commands related to DEFINE RECOVERYMEDIA

Command	Description
DEFINE RECMEDMACHASSOCIATION	Associates recovery media with a machine.
DELETE RECOVERYMEDIA	Deletes recovery media.
QUERY RECOVERYMEDIA	Displays media available for machine recovery.
UPDATE RECOVERYMEDIA	Changes the attributes of recovery media.

## DEFINE SCHEDULE (Define a client or an administrative command schedule)

---

Use this command to create a client or administrative command schedule.

The DEFINE SCHEDULE command takes two forms: one if the schedule applies to client operations, one if the schedule applies to administrative commands. Within these two forms, you can select either classic or enhanced style schedules. The syntax and parameters for each form are defined separately.

For each schedule, a startup window is specified. The startup window is the time period during which the schedule must be initiated. The schedule will not necessarily complete processing within this window. If the server is not running when this window starts, but is started before the end of the defined window is reached, the schedule will run when the server is restarted. Options associated with each schedule style (classic and enhanced) determine when the startup windows should begin.

Table 1. Commands related to DEFINE SCHEDULE

Command	Description
---------	-------------

Command	Description
COPY SCHEDULE	Creates a copy of a schedule.
DEFINE ASSOCIATION	Associates clients with a schedule.
DELETE SCHEDULE	Deletes a schedule from the database.
QUERY EVENT	Displays information about scheduled and completed events for selected clients.
QUERY SCHEDULE	Displays information about schedules.
SET MAXCMDRETRIES	Specifies the maximum number of retries after a failed attempt to execute a scheduled command.
SET MAXSCHEDESSESSIONS	Specifies the maximum number of client/server sessions available for processing scheduled work.
SET RETRYPERIOD	Specifies the time between retry attempts by the client scheduler.
UPDATE SCHEDULE	Changes the attributes of a schedule.

- **DEFINE SCHEDULE (Define a client schedule)**  
Use the DEFINE SCHEDULE command to define a client schedule. IBM Spectrum Protect uses this schedule to automatically perform a variety of client operations for your client workstation at specified intervals or days. After you define a schedule, use the DEFINE ASSOCIATION command to associate the client with the schedule.
- **DEFINE SCHEDULE (Define a schedule for an administrative command)**  
Use the DEFINE SCHEDULE command to create a new schedule for processing an administrative command.

## DEFINE SCHEDULE (Define a client schedule)

Use the DEFINE SCHEDULE command to define a client schedule. IBM Spectrum Protect™ uses this schedule to automatically perform a variety of client operations for your client workstation at specified intervals or days. After you define a schedule, use the DEFINE ASSOCIATION command to associate the client with the schedule.

You must start the client scheduler on the client workstation for IBM Spectrum Protect to process the schedule.

Not all clients can run all scheduled operations, even though you can define the schedule on the server and associate it with the client. For example, a Macintosh client cannot run a schedule when the action is to restore or retrieve files, or run an executable script. An executable script is also known as a command file, a batch file, or a script on different client operating systems.

IBM Spectrum Protect cannot run multiple schedules concurrently for the same client node.

### Privilege class

To define a client schedule, you must have system privilege, unrestricted policy privilege, or restricted policy privilege for the policy domain to which the schedule belongs.

### Syntax

```
Classic client schedule
>>-DEfIne SChedule--domain_name--schedule_name----->
>--+-----+--+-----+----->
  '-Type----Client-' '-DEsCRIPTION----description-'
.
.-ACTIon----Incremental-----
>--+-----+-----+----->
  '-ACTIon----++Incremental-----+'
      +-Selective-----+
      +-Archive--+-----+
      |           |         |
      |           '-SUBACTIon--++-----+' |
      |           |         |
      |           '-FASTBack-' |
      +-Backup--+-----+-----+
```









## Command

Specifies that the schedule processes a client operating system command or script that is specified with the OBJECTS parameter.

## Macro

Specifies that a client processes a macro whose file name is specified with the OBJECTS parameter.

## SUBACTiOn

You can specify one of the following values:

""

When a null string (two double quotes) is specified with ACTION=BACKUP the backup is an incremental.

## FASTBACk

Specifies that a FastBack client operation that is identified by the ACTION parameter is to be scheduled for processing. The ACTION parameter must be either ARCHIVE or BACKUP.

## SYSTEMStAte

Specifies that a client Systemstate backup is scheduled.

## VApp

Specifies that a client vApp backup is scheduled. A vApp is a collection of pre-deployed virtual machines.

## VM

Specifies that a client VMware backup operation is scheduled.

## Deploy

Specifies whether to update client workstations with deployment packages that are specified with the OBJECTS parameter. The OBJECTS parameter must contain two specifications, the package files to retrieve and the location from which to retrieve them. Ensure that the objects are in the order *files location*. For example:

```
define schedule standard deploy_1 action=DEPLOY objects=  
"\\IBM_ANR_WIN\c$\tsm\maintenance\client\v6r2\Windows\X32\v620\v620\  
..\IBM_ANR_WIN\"
```

Values for the following options are restricted when you specify ACTION=DEPLOY:

## PERUNITS

Specify PERUNITS=ONETIME. If you specify PERUNITS=PERIOD, the parameter is ignored.

## DURUNITS

Specify MINUTES, HOURS, or DAYS for the DURUNITS parameter. Do not specify INDEFINITE.

## SCHEDSTYLE

Specify the default style, CLASSIC.

The SCHEDULE command fails if the parameters do not conform to the required parameter values, such as the V.R.M.F.

## OPTiOns

Specifies the client options that you specify to the scheduled command at the time the schedule is processed. This parameter is optional.

Only those options that are valid on the scheduled command can be specified for this parameter. Refer to the appropriate client manual for information about options that are valid from the command line. All options described there as valid only on the initial command line result in an error or are ignored when running the schedule from the server. For example, do not include the following options because they have no effect when the client processes the scheduled command:

- MAXCMDRETRIES
- OPTFILE
- QUERYSCHEDPERIOD
- RETRYPERIOD
- SCHEDLOGNAME
- SCHEDMODE
- SERVERNAME
- TCPCLIENTADDRESS
- TCPCLIENTPORT

**Windows** When you define a scheduler service by using the DSMCUTIL command or the backup-archive client GUI wizard, you specify an options file. You cannot override the options in that options file by issuing the scheduled command. You must modify the options in your scheduler service.

If the option string contains multiple options or options with embedded spaces, surround the entire option string with one pair of apostrophes. Enclose individual options that contain spaces in quotation marks. A leading minus sign is required in

front of the option. Errors can occur if the option string contains spaces that are not quoted correctly.

The following examples show how to specify some client options:

- To specify `subdir=yes` and `domain all-local -systemobject`, enter:
  - `options='-subdir=yes -domain="all-local -c: -systemobject"'`
- To specify `domain all-local -c: -d:`, enter:
  - `options='-domain="all-local -c: -d:"'`

**Windows** Tip:

For Windows clients running in batch mode, if the use of quotation marks is necessary, use interactive mode or operating system escape characters. For additional information, see the following topics:

- Processing a series of commands from the administrative client
- Processing individual commands from the administrative client

## OBJECTS

Specifies the objects for which the specified action is performed. Use a single space between each object. This parameter is required except when `ACTION=INCREMENTAL`. If the action is a backup, archive, retrieve, or restore operation, the objects are file spaces, directories, or logical volumes. If the action is to run a command or macro, the object is the name of the command or macro to run.

When you specify `ACTION=INCREMENTAL` without specifying a value for this parameter, the scheduled command is invoked without specified objects and attempts to process the objects as defined in the client option file. To select all file spaces or directories for an action, explicitly list them in the object string. Entering only an asterisk in the object string causes the backup to occur only for the directory where the scheduler was started.

Important:

- If you specify a second file specification, and it is not a valid destination, you receive this error:

```
ANS1082E Invalid destination file specification <filespec> entered.
```

- If you specify more than two file specifications, you receive this error:

```
ANS1102E Excessive number of command line arguments passed to the program!
```

When you specify `ACTION=ARCHIVE`, `INCREMENTAL`, or `SELECTIVE` for this parameter, you can list a maximum of twenty (20) file specifications.

Enclose the object string in double quotes if it contains blank characters (spaces), and then surround the double quotes with single quotes. If the object string contains multiple file names, enclose each file name with its own pair of double quotes, then surround the entire string with one pair of single quotes. Errors can occur if file names contain a space that is not quoted correctly.

**Windows** If you are using characters that have a special meaning for Windows users, such as commas, surround the entire argument in two pairs of double quotes, then surround the entire string with single quotes. The following examples show you how to specify some file names:

- To specify `C:\FILE 2`, `D:\GIF FILES`, and `E:\MY TEST FILE`, enter:
  - `OBJECTS='"C:\FILE 2" "D:\GIF FILES" "E:\MY TEST FILE"'`
- To specify `D:\TEST FILE`, enter:
  - `OBJECTS='"D:\TEST FILE"'`
- To specify `D:TEST,FILE`:
  - `OBJECTS='""D:\TEST,FILE""'`

**AIX** | **Linux** The following examples show how to specify some file names:

- To specify `/home/file 2`, `/home/gif files`, and `/home/my test file`, enter:
  - `OBJECTS='"/home/file 2" "/home/gif files" "/home/my test file"'`
- To specify `/home/test file`, enter:
  - `OBJECTS='"/home/test file"'`

**Windows** Tip:

For Windows clients running in batch mode, if the use of double quotes is necessary, use interactive mode or operating system escape characters. For additional information, see the following topics:

- Processing a series of commands from the administrative client
- Processing individual commands from the administrative client

#### PRIority

Specifies the priority value for a schedule. This parameter is optional. You can specify an integer from 1 to 10, with 1 being the highest priority and 10 being the lowest. The default is 5.

If two or more schedules have the same window start time, the value you specify determines when IBM Spectrum Protect processes the schedule. The schedule with the highest priority starts first. For example, a schedule with PRIORITY=3 starts before a schedule with PRIORITY=5.

#### STARTDate

Specifies the date for the beginning of the window in which the schedule is first processed. This parameter is optional. The default is the current date. Use this parameter with the STARTTIME parameter to specify when the initial startup window of the schedule starts.

You can specify the date using one of the values below:

Value	Description	Example
MM/DD/YYYY	A specific date	09/15/1998
TODAY	The current date	TODAY
TODAY+days <b>or</b> +days	The current date plus days specified. The maximum number of days you can specify is 9999.	TODAY +3 <b>or</b> +3.
EOLM (End Of Last Month)	The last day of the previous month.	EOLM
EOLM-days	The last day of the previous month minus days specified.	EOLM-1  To include files that were active a day before the last day of the previous month.
BOTM (Beginning Of This Month)	The first day of the current month.	BOTM
BOTM+days	The first day of the current month, plus days specified.	BOTM+9  To include files that were active on the 10th day of the current month.

#### STARTTime

Specifies the time for the beginning of the window in which the schedule is first processed. This parameter is optional. The default is the current time. This parameter is used in conjunction with the STARTDATE parameter to specify when the initial startup window begins.

You can specify the time using one of the values below:

Value	Description	Example
HH:MM:SS	A specific time	10:30:08
NOW	The current time	NOW
NOW+HH:MM <b>or</b> +HH:MM	The current time plus hours and minutes specified	NOW+02:00 <b>or</b> +02:00.  If you issue this command at 5:00 with STARTTIME=NOW+02:00 or STARTTIME=+02:00, the beginning of the startup window is at 7:00.
NOW-HH:MM <b>or</b> - HH:MM	The current time minus hours and minutes specified	NOW-02:00 <b>or</b> -02:00.  If you issue this command at 5:00 with STARTTIME=NOW-02:00 or STARTTIME=-02:00, the beginning of the startup window is at 3:00.

#### DURation

Specifies the number of units that define the length of the startup window of the scheduled operation. This parameter is optional. This value must be from 1 to 999. The default is 1.

Use this parameter with the DURUNITS parameter to specify the length of the startup window. For example, if you specify DURATION=20 and DURUNITS=MINUTES, the schedule must be started within 20 minutes of the start date and start time. The default length of the startup window is 1 hour. The duration of the window must be shorter than the period between windows.

This value is ignored if you specify DURUNITS=INDEFINITE.

Tip: Define schedules with durations longer than 10 minutes. Doing this will give the IBM Spectrum Protect scheduler enough time to process the schedule and prompt the client.

#### DURUnits

Specifies the time units used to determine the duration of the window in which the schedule can start. This parameter is optional. The default is HOURS.

Use this parameter with the DURATION parameter to specify how long the startup window remains open to process the schedule. For example, if DURATION=20 and DURUNITS=MINUTES, the schedule must be started within 20 minutes of the start date and start time. The schedule may not necessarily complete processing within this window. If the schedule needs to be retried for any reason, the retry attempts must begin before the startup window elapses, or the operation does not restart.

The default value for the length of the startup window is 1 hour. You can specify one of the following values:

#### Minutes

Specifies that the duration of the window is defined in minutes.

#### Hours

Specifies that the duration of the window is defined in hours.

#### Days

Specifies that the duration of the window is defined in days.

#### INDefinite

Specifies that the startup window of the scheduled operation has an indefinite duration. The schedule can run any time after the scheduled start time, until the schedule expires. You cannot specify DURUNITS=INDEFINITE, unless you specify PERUNITS=ONETIME. The INDEFINITE value is not allowed with enhanced schedules.

#### MAXRUNtime

Specifies the maximum run time, which is the number of minutes during which all client sessions that are started by the scheduled operation should be completed. If sessions are still running after the maximum run time, the server issues a warning message, but the sessions continue to run.

Tip: The maximum run time is calculated from the beginning of the startup window and not from the time that sessions start within the startup window.

Restrictions:

- The value of the parameter is not distributed to servers that are managed by an enterprise configuration manager.
- The value of the parameter is not exported by the EXPORT command.

The parameter is optional. You can specify a number in the range 0-1440. The default value is 0. A value of 0 means that the maximum run time is indefinite, and no warning message is issued. The maximum run time must be greater than the startup window duration, which is defined by the DURATION and DURUNITS parameters.

For example, if the start time of a scheduled operation is 9:00 PM, and the duration of the startup window is 2 hours, the startup window is 9:00 PM - 11:00 PM. If the maximum run time is 240 minutes, that is, 4 hours, all client sessions for this operation should be completed by 1:00 AM. If one or more sessions are still running after 1:00 AM, the server issues a warning message.

Tip: Alternatively, you can specify a *Run time alert* value of 1:00 AM in the IBM Spectrum Protect Operations Center.

#### SCHEDStyle

This parameter is optional. SCHEDSTYLE defines either the interval between times when a schedule can run, or the days on which it runs. The default is the classic syntax.

Possible values are:

#### Classic

The parameters for the Classic syntax are: PERIOD, PERUNITS, and DAYOFWEEK. You cannot use these parameters: MONTH, DAYOFMONTH, and WEEKOFMONTH.

#### Enhanced

The parameters for the Enhanced syntax are: MONTH, DAYOFMONTH, WEEKOFMONTH, and DAYOFWEEK. You cannot use these parameters: PERIOD and PERUNITS.

#### PERiod

Specifies the length of time between startup windows for this schedule. This parameter is optional. This parameter is used only with classic schedules. You can specify an integer from 1 to 999. The default is 1.

Use this parameter with the PERUNITS parameter to specify the period between startup windows. For example, if you specify PERIOD=5 and PERUNITS=DAYS (assuming that DAYOFWEEK=ANY), the operation is scheduled every five days after the initial start date and start time. The period between startup windows must exceed the duration of each window. The default is 1 day.

This value is ignored if you specify PERUNITS=ONETIME.

#### PERUnits

Specifies the time units used to determine the period between startup windows for this schedule. This parameter is optional. This parameter is used only with classic schedules. The default is DAYS.

Use this parameter with the PERIOD parameter to specify the period between startup windows. For example, if you specify PERIOD=5 and PERUNITS=DAYS (assuming that DAYOFWEEK=ANY), the operation is scheduled every 5 days after the initial start date and start time. The default is 1 day. You can specify one of the following values:

##### Hours

Specifies that the time between startup windows is in hours.

##### Days

Specifies that the time between startup windows is in days.

##### Weeks

Specifies that the time between startup windows is in weeks.

##### Months

Specifies that the time between startup windows is in months.

When you specify PERUNITS=MONTHS, the scheduled operation will be processed each month on the same date. For example, if the start date for the scheduled operation is 02/04/1998, the schedule will process on the 4th of every month thereafter. However, if the date is not valid for the next month, then the scheduled operation will be processed on the last valid date in the month. Thereafter, subsequent operations are based on this new date. For example, if the start date is 03/31/1998, the next month's operation will be scheduled for 04/30/1998. Thereafter, all subsequent operations will be on the 30th of the month until February. Because February has only 28 days, the operation will be scheduled for 02/28/1999. Subsequent operations will be processed on the 28th of the month.

##### Years

Specifies that the time between startup windows for the schedule is in years.

When you specify PERUNITS=YEARS, the scheduled operation will be processed on the same month and date of each year. For example, if the start date for the scheduled operation is 02/29/2004, the next year's scheduled operation will be 02/28/2005 because February only has 28 days. Thereafter, subsequent operations will be scheduled for February 28th.

##### Onetime

Specifies that the schedule processes once. This value overrides the value you specified for the PERIOD parameter.

#### DAYofweek

Specifies the day of the week on which the startup window for the schedule begins. This parameter is optional. You can specify different options for the DAYofweek parameter, depending on whether the schedule style was defined as Classic or Enhanced:

##### Classic Schedule

Specifies the day of the week on which the startup window for the schedule begins. This parameter is optional. You can either specify one day of the week, or WEEKDAY, WEEKEND, or ANY. If the start date and start time fall on a day that does not correspond to a day you specify, the start date and start time will be shifted forward in 24-hour increments until the DAYOFWEEK parameter is satisfied.

If you select a value for DAYOFWEEK other than ANY, and depending on the values for PERIOD and PERUNITS, schedules may not be processed when you would expect. The default is ANY.

##### Enhanced Schedule



Specifies the days of the week on which to run the schedule. You can either specify multiple days separated by commas and no intervening blanks, or WEEKDAY, WEEKEND, or ANY. If you specify multiple days, the schedule will run on each of the specified days. If you specify WEEKDAY or WEEKEND, you must also specify either WEEKOFMONTH=FIRST or WEEKOFMONTH=LAST, and the schedule will run just once per month.

The default value is ANY, meaning the schedule will run every day of the week or on the day or days determined by other enhanced schedule parameters. DAYOFWEEK must have a value of ANY (either by default or specified with the command) when used with the DAYOFMONTH parameter.

Possible values for the DAYofweek parameter are:

ANY

Specifies that the startup window can begin on any day of the week.

WEEKDay

Specifies that the startup window can begin on Monday, Tuesday, Wednesday, Thursday, or Friday.

WEEKEnd

Specifies that the startup window can begin on Saturday or Sunday.

SUNday

Specifies that the startup window begins on Sunday.

Monday

Specifies that the startup window begins on Monday.

TUesday

Specifies that the startup window begins on Tuesday.

Wednesday

Specifies that the startup window begins on Wednesday.

THursday

Specifies that the startup window begins on Thursday.

Friday

Specifies that the startup window begins on Friday.

SAturday

Specifies that the startup window begins on Saturday.

MONth

Specifies the months of the year during which to run the schedule. This parameter is used only with enhanced schedules. Specify multiple values by using commas and no intervening blanks. The default value is ANY, which means that the schedule runs during every month of the year.

DAYOFMonth

Specifies the day of the month to run the schedule. This parameter is used only with enhanced schedules. You can either specify ANY or a number from -31 through 31, excluding zero. Negative values are a day from the end of the month, counting backwards. For example, the last day of the month is -1, the next-to-the-last day of the month is -2, and so on. You can specify multiple values separated by commas and no intervening blanks. If you specify multiple values, the schedule runs on each of the specified days of the month. If multiple values resolve to the same day, the schedule runs only once that day.

The default value is ANY. ANY means that the schedule runs on every day of the month or on the days determined by other enhanced schedule parameters. DAYOFMONTH must have a value of ANY (either by default or specified with the command) when used with the DAYOFWEEK or WEEKOFMONTH parameters.

WEEKofmonth

Specifies the week of the month in which to run the schedule. This parameter is used only with enhanced schedules. A week is considered any seven-day period which does not start on a particular day of the week. You can specify FIRST, SECOND, THIRD, FOURTH, LAST, or ANY. You can specify multiple values separated by commas and no intervening blanks. If you specify multiple values, the schedule runs during each of the specified weeks of the month. If multiple values resolve to the same week, the schedule runs only once during that week.

The default value is ANY. ANY means that the schedule runs during every week of the month or on the day or days determined by other enhanced schedule parameters. WEEKOFMONTH must have a value of ANY (either by default or specified with the command) when used with the DAYOFMONTH parameter.

EXPIration

Specifies the date after which this schedule is no longer used. This parameter is optional. The default is NEVER. You can specify one of the following values:

Never

Specifies that the schedule never expires.  
expiration\_date

Specifies the date on which this schedule expires, in MM/DD/YYYY format. If you specify an expiration date, the schedule expires at 23:59:59 on the date you specify.

## Example: Define a schedule for a monthly incremental backup

---

Define a schedule named MONTHLY\_BACKUP that initiates an incremental backup of all associated nodes. Specify the start date as Tuesday, May 1, 2001. This date does not match the specified day of the week (Sunday), so the initial startup window begins on the first Sunday after May 1, 2001 (05/01/2001). The startup windows for this schedule extend from 01:00 through 03:00. This monthly schedule initiates backup of c: and d: file spaces for all associated nodes.

```
define schedule standard monthly_backup
description="Monthly Backup of c: and d: drives"
objects="c:\* d:\*"
startdate=05/01/2001 starttime=01:00
duration=2 durunits=hours period=1
perunits=months dayofweek=sunday
```

## Example: Define a schedule for a weekly incremental backup

---

Define a schedule named WEEKLY\_BACKUP that initiates an incremental backup of all associated nodes. The initial startup window for this schedule extends from 23:00 on Saturday, June 7, 1997 (06/07/1997), to 03:00 on Sunday, June 8, 1997 (06/08/1997). Subsequent windows begin at 23:00, every Saturday. No messages are returned to the client node when this schedule is run.

```
define schedule employee_records weekly_backup
startdate=06/07/1997 starttime=23:00 duration=4
durunits=hours perunits=weeks
dayofweek=saturday options=-quiet
```

## Example: Define a schedule that archives a specific directory every quarter

---

Define a schedule that archives specific files quarterly on the last Friday of the month.

```
define schedule employee_records quarterly_archive
starttime=20:00 action=archive
object=/home/employee/records/*
duration=1 durunits=hour schedstyle=enhanced
month=mar,jun,sep,dec weekofmonth=last dayofweek=fri
```

## DEFINE SCHEDULE (Define a schedule for an administrative command)

---

Use the DEFINE SCHEDULE command to create a new schedule for processing an administrative command.

You can include scripts in an administrative command schedule so the commands are processed automatically.

Note:

1. You cannot schedule the MACRO command or the QUERY ACTLOG command.
2. If you are scheduling a command that specifies the WAIT parameter, the parameter must be set to YES in order for the process to provide a return code to the session that started it. For more information about the WAIT parameter, see Server command processing.

## Privilege class

---

To define an administrative command schedule, you must have system privilege.

## Syntax

---

```
Classic administrative schedule
>>-DEFine SChedule--schedule_name----->
>--+-----+---CMD---command----->
```

```

'-Type-----Administrative-'

.-ACTIVE-----No--.
>+-----+-----+-----+-----+-----+-----+-----+-----+-----+----->
'-ACTIVE-----Yes-' '-DESCRIPTION-----description-'

.-PRIority-----5----- .-STARTDate-----current_date-.
>+-----+-----+-----+-----+-----+-----+-----+-----+-----+----->
'-PRIority-----number-' '-STARTDate-----date-----'

.-STARTTime-----current_time-. .-DURation-----1-----.
>+-----+-----+-----+-----+-----+-----+-----+-----+-----+----->
'-STARTTime-----time-----' '-DURation-----number-'

.-DURUnits-----Hours----- .-MAXRUNTime-----0-----.
>+-----+-----+-----+-----+-----+-----+-----+-----+-----+----->
'-DURUnits-----+Minutes-----+' '-MAXRUNTime-----number-'
      +-Hours-----+
      +-Days-----+
      '-INDefinite-'

.-SCHEdStyle-----Classic-. .-PERiod-----1-----.
>+-----+-----+-----+-----+-----+-----+-----+-----+-----+----->
'-SCHEdStyle-----Classic-' '-PERiod-----number-'

.-PERUnits-----Days----- .
>+-----+-----+-----+-----+-----+-----+-----+-----+-----+----->
'-PERUnits-----+Hours-----+'
      +-Days-----+
      +-Weeks-----+
      +-Months-----+
      +-Years-----+
      '-Onetime-'

.-DAYofweek-----ANY----- .
>+-----+-----+-----+-----+-----+-----+-----+-----+-----+----->
'-DAYofweek-----+ANY-----+'
      +-WEEKDay-----+
      +-WEEKEnd-----+
      +-SUnDay-----+
      +-MonDay-----+
      +-TUESday-----+
      +-WednesDay-----+
      +-THURsday-----+
      +-FRIday-----+
      '-SATurday--'

.-EXPIration-----Never----- .
>+-----+-----+-----+-----+-----+-----+-----+-----+-----+-----><
'-EXPIration-----+Never-----+'
      '-date--'

```

## Syntax

---

```

Enhanced administrative schedule

>>-DEFine SCHeDule--schedule_name----->
>+-----+-----+-----+-----+-----+-----+-----+-----+-----+----->
'-Type-----Administrative-'

.-ACTIVE-----NO--.
>+-----+-----+-----+-----+-----+-----+-----+-----+-----+----->
'-ACTIVE-----YES-' '-DESCRIPTION-----description-'

.-PRIority-----5----- .-STARTDate-----current_date-.
>+-----+-----+-----+-----+-----+-----+-----+-----+-----+----->
'-PRIority-----number-' '-STARTDate-----date-----'

.-STARTTime-----current_time-. .-DURation-----1-----.
>+-----+-----+-----+-----+-----+-----+-----+-----+-----+----->

```

```

'-STARTTime-----time-----' '-DURation-----number-'

.-DURUnits-----Hours----- .-MAXRUNtime-----0-----.
>-----+-----+-----+-----+-----+-----+----->
'-DURUnits-----+Minutes-+-' '-MAXRUNtime-----number-'
      +-Hours---+
      '-Days----'

.-MONTH-----ANY-----.
>--SCHEDStyle--Enhanced-+-----+-----+-----+----->
      '-MONTH-----+ANY-----+'
              +-January---+
              +-February--+
              +-MARCh-----+
              +-APril-----+
              +-May-----+
              +-JUNE-----+
              +-JULy-----+
              +-AUGust----+
              +-September-+
              +-October---+
              +-November--+
              '-December--'

.-DAYOFMonth-----ANY----- .-WEEKofmonth-----ANY-----.
>-----+-----+-----+-----+-----+-----+----->
'-DAYOFMonth-----+ANY-+-' '-WEEKofmonth-----+ANY-----+'
      '-Day-'              +-First--+
                          +-Second-+
                          +-Third--+
                          +-FOurth-+
                          '-Last---'

.-DAYofweek-----ANY-----.
>-----+-----+-----+-----+-----+-----+----->
'-DAYofweek-----+ANY-----+'
      +-WEEKDay---+
      +-WEEKEnd---+
      +-Sunday----+
      +-Monday----+
      +-TUesday---+
      +-Wednesday-+
      +-THursday--+
      +-Friday----+
      '-SATurday--'

.-EXPIration-----Never-----.
>-----+-----+-----+-----+-----+-----+-----><
'-EXPIration-----+Never-+-'
      '-date--'

```

## Parameters

### schedule\_name (Required)

Specifies the name of the schedule to be defined. You can specify up to 30 characters for the name.

### Type=Administrative

Specifies that a schedule for an administrative command is defined. This parameter is optional. An administrative command is assumed if the CMD parameter is specified.

### CMD (Required)

Specifies the administrative command to schedule for processing. The maximum length of the command is 512 characters. Enclose the administrative command in quotation marks if it contains any blank characters.

Restriction: You cannot specify redirection characters with this parameter.

### ACTIVE

Specifies whether IBM Spectrum Protect processes an administrative command schedule when the startup window occurs. This parameter is optional. The default is NO. The administrative command schedule must be set to the active state with the UPDATE SCHEDULE command so that IBM Spectrum Protect can process the schedule. Possible values are:

YES

Specifies that IBM Spectrum Protect processes an administrative command schedule when the startup window begins.

NO

Specifies that IBM Spectrum Protect does not process an administrative command schedule when the startup window begins.

#### DEScRiption

Specifies a description of the schedule. This parameter is optional. You can specify up to 255 characters for the description. Enclose the description in quotation marks if it contains any blank characters.

#### PRIOrity

Specifies the priority value for a schedule. This parameter is optional. You can specify an integer from 1 to 10, with 1 being the highest priority and 10 being the lowest. The default is 5.

If two or more schedules have the same window start time, the value you specify determines when IBM Spectrum Protect processes the schedule. The schedule with the highest priority starts first. For example, a schedule with PRIORITY=3 starts before a schedule with PRIORITY=5.

#### STARTDate

Specifies the date for the beginning of the window in which the schedule is first processed. This parameter is optional. The default is the current date. Use this parameter with the STARTTIME parameter to specify when the initial startup window of the schedule starts.

You can specify the date using one of the values below:

Value	Description	Example
MM/DD/YYYY	A specific date	09/15/1998
TODAY	The current date	TODAY
TODAY+days <b>or</b> +days	The current date plus days specified. The maximum number of days you can specify is 9999.	TODAY +3 <b>or</b> +3.
EOLM (End Of Last Month)	The last day of the previous month.	EOLM
EOLM-days	The last day of the previous month minus days specified.	EOLM-1  To include files that were active a day before the last day of the previous month.
BOTM (Beginning Of This Month)	The first day of the current month.	BOTM
BOTM+days	The first day of the current month, plus days specified.	BOTM+9  To include files that were active on the 10th day of the current month.

#### STARTTime

Specifies the time for the beginning of the window in which the schedule is first processed. This parameter is optional. The default is the current time. This parameter is used in conjunction with the STARTDATE parameter to specify when the initial startup window begins.

You can specify the time using one of the values below:

Value	Description	Example
HH:MM:SS	A specific time	10:30:08
NOW	The current time	NOW
NOW+HH:MM <b>or</b> +HH:MM	The current time plus hours and minutes specified	NOW+02:00 <b>or</b> +02:00.  If you issue this command at 5:00 with STARTTIME=NOW+02:00 or STARTTIME=+02:00, the beginning of the startup window is at 7:00.

Value	Description	Example
NOW-HH:MM or -HH:MM	The current time minus hours and minutes specified	NOW-02:00 or -02:00.  If you issue this command at 5:00 with STARTTIME=NOW-02:00 or STARTTIME=-02:00, the beginning of the startup window is at 3:00.

#### DURation

Specifies the number of units that define the length of the startup window of the scheduled operation. This parameter is optional. This value must be from 1 to 999. The default is 1.

Use this parameter with the DURUNITS parameter to specify the length of the startup window. For example, if you specify DURATION=20 and DURUNITS=MINUTES, the schedule must be started within 20 minutes of the start date and start time. The default length of the startup window is 1 hour. The duration of the window must be shorter than the period between windows.

This value is ignored if you specify DURUNITS=INDEFINITE.

#### DURUnits

Specifies the time units used to determine the duration of the window in which the schedule can start. This parameter is optional. The default is HOURS.

Use this parameter with the DURATION parameter to specify how long the startup window remains open to process the schedule. For example, if DURATION=20 and DURUNITS=MINUTES, the schedule must be started within 20 minutes of the start date and start time. The schedule may not necessarily complete processing within this window. If the schedule needs to be retried for any reason, the retry attempts must begin before the startup window elapses, or the operation does not restart.

The default value for the length of the startup window is 1 hour. You can specify one of the following values:

##### Minutes

Specifies that the duration of the window is defined in minutes.

##### Hours

Specifies that the duration of the window is defined in hours.

##### Days

Specifies that the duration of the window is defined in days.

##### INDefinite

Specifies that the startup window of the scheduled operation has an indefinite duration. The schedule can run any time after the scheduled start time, until the schedule expires. You cannot specify DURUNITS=INDEFINITE, unless you specify PERUNITS=ONETIME. The INDEFINITE value is not allowed with enhanced schedules.

#### MAXRUNtime

Specifies the maximum run time, which is the number of minutes during which server processes that are started by the scheduled commands must be completed. If processes are still running after the maximum run time, the central scheduler cancels the processes.

##### Tips:

- The processes might not end immediately when the central scheduler cancels them; they end when they register the cancellation notification from the central scheduler.
- The maximum run time is calculated beginning from when the server process starts. If the schedule command starts more than one process, each process maximum run time is calculated from when the process starts.
- This parameter does not apply to some processes, such as duplicate-identification processes, which can continue to run after the maximum run time.
- This parameter does not apply if the scheduled command does not start a server process.
- Another cancel time might be associated with some commands. For example, the MIGRATE STGPOOL command can include a parameter that specifies the length of time that the storage pool migration runs before the migration is automatically canceled. If you schedule a command for which a cancel time is defined, and you also define a maximum run time for the schedule, the processes are canceled at whichever cancel time is reached first.

##### Restrictions:

- The value of the parameter is not distributed to servers that are managed by an enterprise configuration manager.
- The value of the parameter is not exported by the EXPORT command.

The parameter is optional. You can specify a number in the range 0-1440. The default value is 0. A value of 0 means that the maximum run time is indefinite, and the central scheduler does not cancel processes. The maximum run time must be greater than the startup window duration, which is defined by the DURATION and DURUNITS parameters.

For example, if the start time of a scheduled command is 9:00 PM, and the duration of the startup window is 2 hours, the startup window is 9:00 PM - 11:00 PM. If the maximum run time is 240 minutes, that is, 4 hours, all applicable server processes that are started by the command must be completed by 1:00 AM. If one or more applicable processes are still running after 1:00 AM, the central scheduler cancels the processes.

Tip: Alternatively, you can specify an *end time* of 1:00 AM in the IBM Spectrum Protect Operations Center.

#### SCHEDStyle

This parameter is optional. SCHEDSTYLE defines either the interval between times when a schedule should run, or the days on which it should run. The style can be either classic or enhanced. The default is the classic syntax.

For classic schedules, these parameters are allowed: PERIOD, PERUNITS, and DAYOFWEEK. Not allowed for classic schedules are: MONTH, DAYOFMONTH, and WEEKOFMONTH.

For enhanced schedules, these parameters are allowed: MONTH, DAYOFMONTH, WEEKOFMONTH, and DAYOFWEEK. These parameters are not allowed: PERIOD and PERUNITS.

#### PERiod

Specifies the length of time between startup windows for this schedule. This parameter is optional. This parameter is used only with classic schedules. You can specify an integer from 1 to 999. The default is 1.

Use this parameter with the PERUNITS parameter to specify the period between startup windows. For example, if you specify PERIOD=5 and PERUNITS=DAYS (assuming that DAYOFWEEK=ANY), the operation is scheduled every five days after the initial start date and start time. The period between startup windows must exceed the duration of each window. The default is 1 day.

This value is ignored if you specify PERUNITS=ONETIME.

#### PERUnits

Specifies the time units used to determine the period between startup windows for this schedule. This parameter is optional. This parameter is used only with classic schedules. The default is DAYS.

Use this parameter with the PERIOD parameter to specify the period between startup windows. For example, if you specify PERIOD=5 and PERUNITS=DAYS (assuming that DAYOFWEEK=ANY), the operation is scheduled every 5 days after the initial start date and start time. The default is 1 day. You can specify one of the following values:

##### Hours

Specifies that the time between startup windows is in hours.

##### Days

Specifies that the time between startup windows is in days.

##### Weeks

Specifies that the time between startup windows is in weeks.

##### Months

Specifies that the time between startup windows is in months.

When you specify PERUNITS=MONTHS, the scheduled operation will be processed each month on the same date. For example, if the start date for the scheduled operation is 02/04/1998, the schedule will process on the 4th of every month thereafter. However, if the date is not valid for the next month, then the scheduled operation will be processed on the last valid date in the month. Thereafter, subsequent operations are based on this new date. For example, if the start date is 03/31/1998, the next month's operation will be scheduled for 04/30/1998. Thereafter, all subsequent operations will be on the 30th of the month until February. Because February has only 28 days, the operation will be scheduled for 02/28/1999. Subsequent operations will be processed on the 28th of the month.

##### Years

Specifies that the time between startup windows for the schedule is in years.

When you specify PERUNITS=YEARS, the scheduled operation will be processed on the same month and date of each year. For example, if the start date for the scheduled operation is 02/29/2004, the next year's scheduled operation will be 02/28/2005 because February only has 28 days. Thereafter, subsequent operations will be scheduled for February 28th.

##### Onetime

Specifies that the schedule processes once. This value overrides the value you specified for the PERIOD parameter.

## DAYofweek

Specifies the day of the week on which the startup window for the schedule begins. This parameter is optional. You can specify different options for the DAYofweek parameter, depending on whether the schedule style was defined as Classic or Enhanced:

### Classic Schedule

Specifies the day of the week on which the startup window for the schedule begins. This parameter is optional. You can either specify one day of the week, or WEEKDAY, WEEKEND, or ANY. If the start date and start time fall on a day that does not correspond to a day you specify, the start date and start time will be shifted forward in 24-hour increments until the DAYOFWEEK parameter is satisfied.

If you select a value for DAYOFWEEK other than ANY, and depending on the values for PERIOD and PERUNITS, schedules may not be processed when you would expect. The default is ANY.

### Enhanced Schedule

Specifies the days of the week on which to run the schedule. You can either specify multiple days separated by commas and no intervening blanks, or WEEKDAY, WEEKEND, or ANY. If you specify multiple days, the schedule will run on each of the specified days. If you specify WEEKDAY or WEEKEND, you must also specify either WEEKOFMONTH=FIRST or WEEKOFMONTH=LAST, and the schedule will run just once per month.

The default value is ANY, meaning the schedule will run every day of the week or on the day or days determined by other enhanced schedule parameters. DAYOFWEEK must have a value of ANY (either by default or specified with the command) when used with the DAYOFMONTH parameter.

Possible values for the DAYofweek parameter are:

#### ANY

Specifies that the startup window can begin on any day of the week.

#### WEEKDay

Specifies that the startup window can begin on Monday, Tuesday, Wednesday, Thursday, or Friday.

#### WEEKEnd

Specifies that the startup window can begin on Saturday or Sunday.

#### Sunday

Specifies that the startup window begins on Sunday.

#### Monday

Specifies that the startup window begins on Monday.

#### Tuesday

Specifies that the startup window begins on Tuesday.

#### Wednesday

Specifies that the startup window begins on Wednesday.

#### Thursday

Specifies that the startup window begins on Thursday.

#### Friday

Specifies that the startup window begins on Friday.

#### SAaturday

Specifies that the startup window begins on Saturday.

## MONTH

Specifies the months of the year during which to run the schedule. This parameter is used only with enhanced schedules. Specify multiple values by using commas and no intervening blanks. The default value is ANY. This means the schedule will run during every month of the year.

## DAYOFMonth

Specifies the day of the month to run the schedule. This parameter is used only with enhanced schedules. You can either specify ANY or a number from -31 through 31, excluding zero. Negative values are a day from the end of the month, counting backwards. For example, the last day of the month is -1, the next-to-the-last day of the month is -2, etc. You can specify multiple values separated by commas and no intervening blanks. If you specify multiple values, the schedule will run on each of the specified days of the month. If multiple values resolve to the same day, the schedule will run only once that day.

The default value is ANY. This means the schedule will run on every day of the month or on the days determined by other enhanced schedule parameters. DAYOFMONTH must have a value of ANY (either by default or specified with the command) when used with the DAYOFWEEK or WEEKOFMONTH parameters.

## WEEKofmonth



Specifies the week of the month in which to run the schedule. This parameter is used only with enhanced schedules. A week is considered any seven-day period which does not start on a particular day of the week. You can specify FIRST, SECOND, THIRD, FOURTH, LAST, or ANY. You can specify multiple values separated by commas and no intervening blanks. If you specify multiple values, the schedule will run during each of the specified weeks of the month. If multiple values resolve to the same week, the schedule will run only once during that week.

The default value is ANY, meaning the schedule will run during every week of the month or on the day or days determined by other enhanced schedule parameters. WEEKOFMONTH must have a value of ANY (either by default or specified with the command) when used with the DAYOFMONTH parameter.

#### EXPIRATION

Specifies the date after which this schedule is no longer used. This parameter is optional. The default is NEVER. You can specify one of the following values:

##### Never

Specifies that the schedule never expires.

##### expiration\_date

Specifies the date on which this schedule expires, in MM/DD/YYYY format. If you specify an expiration date, the schedule expires at 23:59:59 on the date you specify.

## Example: Define a schedule to back up the primary storage pool every two days

---

Define a schedule named BACKUP\_ARCHIVEPOOL that backs up the primary storage pool ARCHIVEPOOL to the copy storage pool RECOVERYPOOL. The backup runs at 8 p.m. every two days.

```
define schedule backup_archivepool type=administrative
cmd="backup stgpool archivepool recoverypool"
active=yes starttime=20:00 period=2
```

## Example: Define a schedule to back up the primary storage pool twice a month

---

Define a schedule named BACKUP\_ARCHIVEPOOL that backs up the primary storage pool ARCHIVEPOOL to the copy storage pool RECOVERYPOOL. Select an enhanced schedule and run on the first and fifteenth day of the month.

```
define schedule backup_archivepool type=administrative
cmd="backup stgpool archivepool recoverypool"
schedstyle=enhanced dayofmonth=1,15
```

## DEFINE SCRATCHPADENTRY (Define a scratch pad entry)

---

Use this command to enter data on a new line in the scratch pad. The scratch pad is a database table that the server hosts. You can use the scratch pad to store diverse information in table format.

### Privilege class

---

To issue this command, you must have system privilege.

### Syntax

---

```
>>-DEFine SCRATCHPadentry--major_category--minor_category----->
>--subject--Line-----number--Data---data-----><
```

### Parameters

---

#### major\_category (Required)

Specifies the major category in which data is to be stored. Enter a text string of up to 100 alphanumeric characters. This parameter is case sensitive.

#### minor\_category (Required)

Specifies the minor category in which data is to be stored. Minor categories are sections within major categories. Enter a text string of up to 100 alphanumeric characters. This parameter is case sensitive.

#### subject (Required)

Specifies the subject under which data is to be stored. Subjects are sections within minor categories. Enter a text string of up to 100 alphanumeric characters. This parameter is case sensitive.

Line (Required)

Specifies the number of the line on which data is to be stored. Lines are sections within subjects. Specify an integer in the range 1 - 1000.

Data (Required)

Specifies the data to be stored on the line. You can enter up to 1000 characters. Enclose the data in quotation marks if the data contains one or more blanks. The data is case sensitive.

## Example: Define a scratch pad entry

Enter the vacation dates of an administrator, Jane, in a table that stores information about the location of all administrators.

```
define scratchpadentry admin_info location jane line=2 data=
"Out of the office from 1-15 Nov."
```

## Related commands

Table 1. Commands related to DEFINE SCRATCHPADENTRY

Command	Description
DELETE SCRATCHPADENTRY	Deletes a line of data from the scratch pad.
QUERY SCRATCHPADENTRY	Displays information that is contained in the scratch pad.
SET SCRATCHPADRETENTION	Specifies the amount of time for which scratch pad entries are retained.
UPDATE SCRATCHPADENTRY	Updates data on a line in the scratch pad.

## DEFINE SCRIPT (Define an IBM Spectrum Protect script)

Use this command to define an IBM Spectrum Protect™ script or to create a new IBM Spectrum Protect script by using the contents from another script.

The first line for the script can be defined with this command. To add subsequent lines to the script, use the UPDATE SCRIPT command.

Tips:

- When routing commands inside scripts, enclose the server or server group in parentheses and omit the colon. Otherwise, if the syntax includes a colon, the command is not routed when the RUN command is issued. Instead, the command runs only on the server from which the RUN command is issued.
- You cannot redirect the output of a command within an IBM Spectrum Protect script. Instead, run the script and then specify command redirection. For example, to direct the output of script1 to the c:\temp\test.out directory, run the script and specify command redirection as in the following example:

```
run script1 > c:\temp\test.out
```

## Privilege class

To issue this command, you must have operator, policy, storage, or system privilege.

## Syntax

```
>>-DEFine SCRIPT--script_name----->
                                     .-Line---001----.
>--+command_line--+-----+----->
|         '-Line -#---number-' |
'-File-----file_name-----'

>--+-----+-----<<
'-DESCRiption---description-'
```

## Parameters

---

### script\_name (Required)

Specifies the name of the script to be defined. You can specify up to 30 characters for the name.

### command\_line

Specifies the first command to be processed in a script. You must specify either this parameter (and optionally, the LINE parameter) or the FILE parameter.

The command that you specify can include substitution variables and can be continued across multiple lines if you specify a continuation character (-) as the last character in the command. Substitution variables are specified with a '\$' character, followed by a number that indicates the value of the parameter when the script is processed. You can specify up to 1200 characters for the command line. Enclose the command in quotation marks if it contains blanks.

You can run commands serially, in parallel, or serially and in parallel by specifying the SERIAL or PARALLEL script commands for the COMMAND\_LINE parameter. You can run multiple commands in parallel and wait for them to complete before you proceed to the next command. Commands run serially until the parallel command is encountered.

Conditional logic flow statements can be used. These statements include IF, EXIT, and GOTO.

### Line

Specifies the line number for the command line. Because commands are specified in multiple lines, line numbers are used to determine the order for processing when the script is run. The first line, or line 001 is the default. This parameter is optional.

### File

Specifies the name of the file whose contents are read into the script to be defined. The file must reside on the server where this command is running. If you specify the FILE parameter, you cannot specify a command line or line number.

You can create a script by querying another script and specifying the FORMAT=RAW and OUTPUTFILE parameters. The output from querying the script is directed to a file you specify with the OUTPUTFILE parameter. To create the new script, the contents of the script to be defined are read in from the file you specified with the OUTPUTFILE parameter.

### DEScription

Specifies a description for the script. You can specify up to 255 characters for the description. Enclose the description in quotation marks if it contains blank characters. This parameter is optional.

## Example: Write a script to display AIX clients

---

Define a script that displays all AIX® clients.

```
define script qaixc "select node_name from nodes where platform_name='AIX'"  
  desc='Display aix clients'
```

## Example: Write and run a script to route a command to a server group

---

Define and run a script that routes the QUERY STGPOOL command to a server group named DEV\_GROUP.

```
define script qu_stg "(dev_group) query stgpool"  
  
run qu_stg
```

## Example: Create a script from an existing script

---

Define a script whose command lines are read in from a file that is named MY.SCRIPT and name the new script AGADM. The file must be on the server, and be read by the server.

```
define script agadm file=my.script
```

## Related commands

---

Table 1. Commands related to DEFINE SCRIPT

Command	Description
COPY SCRIPT	Creates a copy of a script.

Command	Description
DELETE SCRIPT	Deletes the script or individual lines from the script.
QUERY SCRIPT	Displays information about scripts.
RENAME SCRIPT	Renames a script to a new name.
RUN	Runs a script.
UPDATE SCRIPT	Changes or adds lines to a script.

**Related concepts:**

Using logic flow statements in a script

**Related tasks:**

Defining a server script

Running commands in parallel or serially

Performing tasks concurrently on multiple servers

**Related reference:**

Return codes for use in IBM Spectrum Protect scripts

## DEFINE SERVER (Define a server for server-to-server communications)

Use this command to define a server to use functions such as virtual volumes, node replication, command routing, and LAN-free data movement, among others.

Use this command to define a server for the following functions:

- Enterprise configuration
- Enterprise event logging
- Command routing
- Virtual volumes
- LAN-free data movement
- Node replication
-  Data movement by using z/OS® media server
- Status monitoring of remote servers
- Alert monitoring of remote servers
- Server-to-server export

If you use an LDAP directory server to authenticate passwords, any target servers must be configured for LDAP-authenticated passwords. Data that is replicated from a node that authenticates with an LDAP directory server is inaccessible if the target replication server is not properly configured. If your target replication server is not configured, replicated data from an LDAP node can make it to the target server. But the target replication server must be configured to use LDAP if you want to access the data.

The use of virtual volumes is not supported when the source server and the target server are on the same IBM Spectrum Protect™ server.

This command also is used to define an IBM Spectrum Protect storage agent as if it were a server.

### Privilege class

To issue this command, you must have system privilege.

### Syntax

For:

- Command routing
- Status monitoring of remote servers
- Alert monitoring of remote servers
- Server-to-server export

Tip: Command routing uses the ID and the password of the administrator who is issuing the command.

```
>>-DEFine--SERver--server_name--HLAddress-----ip_address----->
```

```

>--LLAddress---tcp_port----->
      '-COMMmethod---TCPIP-'

>--+-----+----->
      '-URL---url-' '-DESCRIPTION---description-'

      .-SSL---No-----
>--+-----+----->
      '-SSL---+No--+-'
          '-Yes-'

      .-SESSIONSECurity---TRANSitional----
>--+-----+----->
      '-SESSIONSECurity---+STRict-----+'
          '-TRANSitional-'

```

## Syntax

For:

- Enterprise configuration
- Enterprise event logging
- Storage agent
- Node replication source and target servers
-  z/OS media server

```

>>-DEFine--SERver--server_name--SERVERPAssword---password----->

>--HLAddress---ip_address--LLAddress---tcp_port----->

>--+-----+----->
      '-COMMmethod---TCPIP-' '-URL---url-'

>--+-----+----->
      '-DESCRIPTION---description-'

      (1)
      .-CROSSDEFine---No----- (2)
>--+-----+----->
      '-CROSSDEFine---+No--+-'
          '-Yes-'

      .-VALIDateprotocol---No----- .-SSL---No-----
>--+-----+----->
      '-VALIDateprotocol---+No--+-' '-SSL---+No--+-'
          '-All-' '-Yes-'

      .-SESSIONSECurity---TRANSitional----
>--+-----+----->
      '-SESSIONSECurity---+STRict-----+'
          '-TRANSitional-'

      .-TRANSFERMethod---Tcpi-----
>--+-----+----->
      '-TRANSFERMethod---+Tcpi-----+'
          | (3) |
          '-Fasp-----'

```

Notes:

1. The CROSSDEFINE parameter does not apply to storage agent definitions.
2. The VALIDATEPROTOCOL parameter is deprecated and applies only to storage agent definitions.
3.  The TRANSFERMETHOD parameter is available only on Linux x86\_64 operating systems.

## Syntax for virtual volumes

```

>>-DEFine--SERver--server_name--PAssword---password----->
>--HLAddress---ip_address--LLAddress---tcp_port----->
>--+-----+-----+-----+----->
  '-COMMmethod---TCPIP-' '-URL---url-'
>--+-----+-----+-----+----->
  '-DELgraceperiod---days-' '-NODEName---node_name-'
                                     .-SSL---No-----
>--+-----+-----+-----+----->
  '-DESCription---description-' '-SSL---+No---+'
                                     '-Yes-'
                                     .-SESSIONSECurity---TRANSitional-----
>--+-----+-----+-----+-----><
  '-SESSIONSECurity---+STRict-----+'
                                     '-TRANSitional-'

```

## Parameters

### server\_name (Required)

Specifies the name of the server. This name must be unique on the server. The maximum length of this name is 64 characters.

For server-to-server event logging, library sharing, and node replication, you must specify a server name that matches the name that was set by issuing the SET SERVERNAME command at the target server.

### PAssword

Specifies the password that is used to sign on to the target server for virtual volumes. If you specify the NODENAME parameter, you must specify the PASSWORD parameter. If you specify the PASSWORD parameter but not the NODENAME parameter, the node name defaults to the server name that is specified with the SET SERVERNAME command.

### SERVERPAssword

Specifies the password of the server you are defining. This password must match the password that is set by the SET SERVERPASSWORD command. This parameter is required for enterprise configuration and server-to-server event logging functions.

### HLAddress (Required)

Specifies the IP address (in dotted decimal format) of the server.

Do not use the loopback address as the value of this parameter. Virtual volumes are not supported when the source server and the target server are the same IBM Spectrum Protect server.

### LLAddress (Required)

Specifies the low-level address of the server. This address is usually the same as the address in the TCPPOrt server option of the target server. When SSL=YES, the port must already be designated for SSL communications on the target server.

### COMMmethod

Specifies the communication method that is used to connect to the server. This parameter is optional.

### URL

Specifies the URL address of this server. The parameter is optional.

### DELgraceperiod

Specifies a number of days that an object remains on the target server after it was marked for deletion. You can specify a value 0 - 9999. The default is 5. This parameter is optional.

### NODEName

Specifies a node name to be used by the server to connect to the target server. This parameter is optional. If you specify the NODENAME parameter, you must also specify the PASSWORD parameter. If you specify the PASSWORD parameter but not the NODENAME parameter, the node name defaults to the server name specified with the SET SERVERNAME command.

### DESCription

Specifies a description of the server. The parameter is optional. The description can be up to 255 characters. Enclose the description in quotation marks if it contains blank characters.

### CROSSDEFine

Specifies whether the server that is running this command defines itself to the server that is being specified by this command. This parameter is optional.

**AIX** **Linux** **Windows** Important: This parameter does not apply to storage agent definitions.

If this parameter is included, you must also issue the SET SERVERNAME, SET SERVERPASSWORD, SET SERVERHLADDRESS, SET CROSSDEFINE, and SET SERVERLLADDRESS commands. The default is NO.

Remember:

- For replication operations, the names of the source and target replication servers must match the names that you specify in this command.
- CROSSDEFINE can be used with SSL=YES if all of the conditions that are specified for the SSL=YES parameter are in place on the source and target server.

You can specify one of the following values:

No

Cross definition is not completed.

Yes

Cross definition is completed.

#### VALIDATEPROTOCOL (deprecated)

Specifies whether a cyclic redundancy check validates the data that is sent between the storage agent and IBM Spectrum Protect server. The parameter is optional. The default is NO.

Important: Beginning with IBM Spectrum Protect Version 8.1.2, validation that was enabled by this parameter is replaced by the TLS 1.2 protocol, which is enforced by the SESSIONSECURITY parameter. The VALIDATEPROTOCOL parameter is ignored. Update your configuration to use the SESSIONSECURITY parameter.

#### SSL

Specifies the communication mode of the server. The default is NO.

Important: Beginning in V8.1.2, the SSL parameter uses SSL to encrypt some communication with the specified server even if SSL=NO.

The following conditions and considerations apply when you specify the SSL parameter:

- Before you start the servers, self-signed certificates of the partner servers must be in the key database file (cert.kdb) of each of the servers.
- You can define multiple server names with different parameters for the same target server.
- Storage agents can issue the DSMSTA SETSTORAGESERVER command and include the SSL parameter to create the key database.

You can specify one of the following values:

No

Specifies an SSL session for all communication with the specified server, except when the server is sending or receiving object data. Object data is sent and received by using TCP/IP. By choosing not to encrypt the object data, server performance is similar to communication over a TCP/IP session and the session is secure.

Yes

Specifies an SSL session for all communication with the specified server, even when the server is sending and receiving object data.

#### SESSIONSECURITY

Specifies whether the server that you are defining must use the most secure settings to communicate with an IBM Spectrum Protect server. This parameter is optional.

You can specify one of the following values:

#### STRICT

Specifies that the strictest security settings are enforced for the server that you are defining. The STRICT value uses the most secure communication protocol available, which is currently TLS 1.2. The TLS 1.2 protocol is used for SSL sessions between the specified server and an IBM Spectrum Protect server.

To use the STRICT value, the following requirements must be met to ensure that the specified server can authenticate with the IBM Spectrum Protect server:

- Both the server that you are defining and the IBM Spectrum Protect server must be using IBM Spectrum Protect software that supports the SESSIONSECURITY parameter.
- The server that you are defining must be configured to use the TLS 1.2 protocol for SSL sessions between itself and the IBM Spectrum Protect server.

Servers set to STRICT that do not meet these requirements are unable to authenticate with the IBM Spectrum Protect server.

#### TRANSitional

Specifies that the existing security settings are enforced for the server. This is the default value. This value is intended to be used temporarily while you update your security settings to meet the requirements for the STRICT value.

If SESSIONSECURITY=TRANSITIONAL and the server has never met the requirements for the STRICT value, the server will continue to authenticate by using the TRANSITIONAL value. However, after a server meets the requirements for the STRICT value, the SESSIONSECURITY parameter value automatically updates from TRANSITIONAL to STRICT. Then, the server can no longer authenticate by using a version of the client or an SSL/TLS protocol that does not meet the requirements for STRICT. In addition, after a server successfully authenticates by using a more secure communication protocol, the server can no longer authenticate by using a less secure protocol. For example, if a server that is not using SSL is updated and successfully authenticates by using TLS 1.2, the server can no longer authenticate by using no SSL protocol or TLS 1.1. This restriction also applies when you use functions such as virtual volumes, command routing, or server-to-server export, when a node or administrator authenticates to the IBM Spectrum Protect server as a node or administrator from another server.

#### Linux TRANSFERMethod

Specifies the method that is used for server-to-server data transfer. This parameter is optional. You can specify one of the following values:

##### Tcpip

Specifies that TCP/IP is used to transfer data. This is the default.

##### Fasp

Specifies that Aspera® Fast Adaptive Secure Protocol (FASP®) technology is used to transfer data. Aspera FASP technology can help you optimize data transfer in a wide area network (WAN).

Restrictions:

- Before you enable Aspera FASP technology, determine whether the technology is appropriate for your system environment and install the appropriate licenses. For instructions, see Determining whether Aspera FASP technology can optimize data transfer in your system environment. If the licenses are missing or expired, data transfer operations fail.
- If WAN performance meets your business needs, do not enable Aspera FASP technology.
- If you specify TRANSFERMETHOD=FASP on the PROTECT STGPOOL or REPLICATE NODE command, that value overrides the TRANSFERMETHOD parameter on the DEFINE SERVER and UPDATE SERVER commands.

## Example: Set up two servers to use SSL to communicate (manual configuration)

Tip: If both servers are using V8.1.2 or later software, SSL is automatically configured between the servers and manual configuration is not required.

If both servers are not using V8.1.2 software, you must manually configure the two servers to use SSL to communicate.

The server addresses are as follows:

- ServerA is at `bfa.tucson.ibm.com`
- ServerB is at `bfb.tucson.ibm.com`

Complete the following steps to set up the two servers for SSL:

1. Specify option TCPPOINT 1500 for both servers in the `dsmserv.opt` option file.
2. Start both servers.
3. Shut down both servers to import the `cert256` partner certificate. For ServerA, the certificate is in the `/tsma` instance directory. For ServerB, the certificate is in the `/tsmb` instance directory.
4. Start both servers. The `/tsma/cert256.arm` file is copied to `/tsmb/cert256.bfa.arm` on the `bfb.tucson.ibm.com` address. The `/tsmb/cert256.arm` file is copied to `/tsmb/cert256.bfb.arm` on the `bfa.tucson.ibm.com` address.
5. Issue the following command:

- From ServerA:

```
gsk8capicmd_64 -cert -add -db cert.kdb -stashed -format ascii  
-label "bfb" -file /tsma/cert256.bfb.arm
```

- From ServerB:

```
gsk8capicmd_64 -cert -add -db cert.kdb -stashed -format ascii  
-label "bfa" -file /tsmb/cert256.bfa.arm
```



From each server, you can view the certificates in the key database by issuing the following command:

```
gsk8capicmd_64 -cert -list -db cert.kdb -stashed
```

6. Restart the servers.

7. Issue the appropriate DEFINE SERVER command. For ServerA, issue the following example command:

```
DEFINE SERVER BFB hla=bfh.tucson.ibm.com lla=1542
serverpa=passwordforbfb SSL=YES
```

For ServerB, issue the following example command:

```
DEFINE SERVER BFA hla=bfa.tucson.ibm.com lla=1542
serverpa=passwordforbfa SSL=YES
```

If you do not use SSL, issue the following example DEFINE SERVER command on ServerA:

```
DEFINE SERVER BFBTCP hla=bfh.tucson.ibm.com lla=1500
serverpa=passwordforbfb SSL=NO
```

If you do not use SSL, issue the following example DEFINE SERVER command on ServerB:

```
DEFINE SERVER BFATCP hla=bfa.tucson.ibm.com lla=1500
serverpa=passwordforbfa SSL=NO
```

## Example: Define a server to communicate with another server by using strict session security

---

Define a server name of SERVER1 to use the strictest security settings to authenticate with the IBM Spectrum Protect server.

```
define server server1 sessionsecurity=strict
```

## Example: Define a target server

---

A target server has a high-level address of 9.116.2.67 and a low-level address of 1570. Define that target server to the source server, name it SERVER2, and set the password to SECRET. Specify that objects remain on the target server for seven days after they are marked for deletion.

```
define server server2 password=secret
hladdress=9.115.3.45 lladdress=1570 delgraceperiod=7
```

## Example: Define a server to receive commands from other servers

---

Define a server that can receive commands that are routed from other servers. Name the server WEST\_COMPLEX. Set the high-level address to 9.172.12.35, the low-level address to 1500, and the URL address to http://west\_complex:1580/.

```
define server west_complex
hladdress=9.172.12.35 lladdress=1500
url=http://west_complex:1580/
```

## Example: Cross-define two servers

---

Use cross definition to define SERVER\_A and SERVER\_B.

1. On SERVER\_B, specify the server name, password, and high- and low-level addresses of SERVER\_B. Specify that cross defining is allowed.

```
set servername server_b
set serverpassword mylife
set serverhladdress 9.115.20.80
set serverlladdress 1860
set crossdefine on
```

2. On SERVER\_A, specify the server name, password, and high- and low-level addresses of SERVER\_A.

```
set servername server_a
set serverpassword yourlife
set serverhladdress 9.115.20.97
set serverlladdress 1500
```

3. On SERVER\_A, define SERVER\_B:

```
define server server_b hladdress=9.115.20.80 lladdress=1860
serverpassword=mylife crossdefine=yes
```

## Related commands

Table 1. Commands related to DEFINE SERVER

Command	Description
DEFINE DEVCLASS	Defines a device class.
<b>AIX</b>   <b>Linux</b> DEFINE PATH	<b>AIX</b>   <b>Linux</b> Define a path when the destination is a z/OS media server.
DELETE DEVCLASS	Deletes a device class.
DELETE FILESPACE	Deletes data associated with client file spaces. If a file space is part of a collocation group and you remove the file space from a node, the file space is removed from the collocation group.
DELETE SERVER	Deletes the definition of a server.
QUERY NODE	Displays partial or complete information about one or more clients.
QUERY SERVER	Displays information about servers.
RECONCILE VOLUMES	Reconciles source server virtual volume definitions and target server archive objects.
REGISTER NODE	Defines a client node to the server and sets options for that user.
REMOVE NODE	Removes a client from the list of registered nodes for a specific policy domain.
SET CROSSDEFINE	Specifies whether to cross define servers.
SET SERVERNAME	Specifies the name by which the server is identified.
SET SERVERHLADDRESS	Specifies the high-level address of a server.
SET SERVERLLADDRESS	Specifies the low-level address of a server.
SET SERVERPASSWORD	Specifies the server password.
SET REPLSERVER	Specifies a target replication server.
UPDATE DEVCLASS	Changes the attributes of a device class.
UPDATE NODE	Changes the attributes that are associated with a client node.
<b>AIX</b>   <b>Linux</b> UPDATE PATH	<b>AIX</b>   <b>Linux</b> Define a path when the destination is a z/OS media server.
UPDATE SERVER	Updates information about a server.

## DEFINE SERVERGROUP (Define a server group)

Use this command to define a server group. With a server group, you can route commands to multiple servers by specifying only the group name. After you define the server group, add servers to the group by using the DEFINE GRPMEMBER command.

### Privilege class

To issue this command, you must have system privilege.

### Syntax

```
>>--DEfIne SERVERGRoup--group_name----->
>--+-----+-----><
```

'-DEscription-----description-'

## Parameters

---

group\_name (Required)

Specifies the name of the server group. The maximum length of the name is 64 characters.

DEscription

Specifies a description of the server group. This parameter is optional. The maximum length of the description is 255 characters. Enclose the description in quotation marks if it contains any blank characters.

## Example: Define a server group

---

Define a server group named WEST\_COMPLEX.

```
define servergroup west_complex
```

## Related commands

---

Table 1. Commands related to DEFINE SERVERGROUP

Command	Description
COPY SERVERGROUP	Creates a copy of a server group.
DEFINE GRPMEMBER	Defines a server as a member of a server group.
DELETE GRPMEMBER	Deletes a server from a server group.
DELETE SERVERGROUP	Deletes a server group.
MOVE GRPMEMBER	Moves a server group member.
QUERY SERVERGROUP	Displays information about server groups.
RENAME SERVERGROUP	Renames a server group.
UPDATE SERVERGROUP	Updates a server group.

## DEFINE SPACETRIGGER (Define the space trigger)

---

Use this command to define settings for triggers that determine when and how the server prepares extra space when predetermined thresholds are exceeded in storage pools that use FILE and DISK device classes. Space triggers are not enabled for storage pools with a parameter RECLAMATIONTYPE=SNAPLOCK.

The IBM Spectrum Protect™ server allocates more space when space utilization reaches a specified value. After allocating more space, the server either adds the space to the specified pool (random-access or sequential-access disk).

**Important:** Space trigger functions and storage pool space calculations take into account the space remaining in each directory. An inaccurate calculation can result in a failure to expand the space available in a storage pool. Failure to expand space in a storage pool is one of the conditions that can cause a trigger to become disabled.

For example, if you specify multiple directories for a device class and the directories reside in the same file system, the server calculates space by adding values representing the space remaining in each directory. These space calculations are inaccurate. Rather than choosing a storage pool with sufficient space for an operation, the server might choose the directory that is specified for the device class and run out of space prematurely.

To prevent possible problems and ensure an accurate calculation, you associate each directory with a separate file system. If a trigger becomes disabled because the space in a storage pool could not be expanded, you can re-enable the trigger by specifying the following command: `update spacetrigger stg`. No further changes are required to the space trigger.

## Privilege class

---

To issue this command, you must have system privilege or unrestricted storage privilege.

## Syntax

---

```

>>-DEFine SPACETrigger---STG-----+-----+----->
      .-Fullpct---80-----
      '-Fullpct---percent-'

      .-SPACExpansion---20-----
>--+-----+-----+----->
      '-SPACExpansion---percent-'

>--+-----+-----+----->
      '-EXPansionprefix---prefix-'

>--+-----+-----+-----<
      '-STGPOOL---storage_pool_name-'

```

## Parameters

### STG

Specifies a storage pool space trigger.

### Fullpct

This parameter specifies the utilization percentage of the storage pool. This parameter is optional. Specify an integer value 0 - 99. The default is 80. A value of zero (0) disables the space trigger. When this value is exceeded, the space trigger creates new volumes. Exceeding the threshold might not cause new volumes to be created until the next space request is made.

You can determine storage pool utilization by issuing the QUERY STGPOOL command with FORMAT=DETAILED. The percentage of storage pool utilization is displayed in the field "Space Trigger Util." The calculation for this percentage does not include potential scratch volumes. The calculation for the percentage utilization that is used for migration and reclamation, however, does include potential scratch volumes.

### SPACExpansion

For sequential-access FILE-type storage pools, this parameter is used in determining the number of additional volumes that are created in the storage pool. This parameter is optional. The default is 20. Volumes are created using the MAXCAPACITY value from the storage pool's device class. For random-access DISK storage pools, the space trigger creates a single volume using the EXPANSIONPREFIX.

### EXPansionprefix

For random-access DISK storage-pools, this parameter specifies the prefix that the server uses to create new storage pool files. This parameter is optional and applies only to random-access DISK device classes. The default prefix is the server installation path.

The prefix can include one or more directory separator characters, for example:

**AIX** | **Linux**

```
/opt/tivoli/tsm/server/bin/
```

**Windows**

```
c:\program files\tivoli\tsm\
```

**AIX** | **Linux**

You can specify up to 250 characters. If you specify an invalid prefix, automatic expansion can fail.

**Windows**

You can specify up to 200 characters. If you specify an invalid prefix, automatic expansion can fail. If the server is running as a Windows service, the default prefix is the c:\wnnt\system32 directory.

This parameter is not valid for space triggers for sequential-access FILE storage pools. Prefixes are obtained from the directories that are specified with the associated device class.

### STGPOOL

Specifies the storage pool that is associated with this space trigger. This parameter is optional for storage pool space triggers. If you specify the STG parameter but not the STGPOOL parameter, one space trigger is created that applies to all random-access DISK and sequential-access FILE storage pools that do not have a specific space trigger.

This parameter does not apply to storage pools with the parameter RECLAMATIONTYPE=SNAPLOCK.

## Example: Define a space trigger to increase storage pool space 25 percent

Set up a storage pool space trigger for increasing the amount of space in a storage pool by 25 percent when it is filled to 80 percent utilization of existing volumes. Space is created in the directories associated with the device class.

```
define spacetrigger stg spaceexpansion=25 stgpool=file
```

## Example: Define a space trigger to increase storage pool space 40 percent

Set up a space trigger for the WINPOOL1 storage pool to increase the amount of space in the storage pool by 40 percent when it is filled to 80 percent utilization of existing volumes.

```
define spacetrigger stg spaceexpansion=40 stgpool=winpool1
```

## Related commands

Table 1. Commands related to DEFINE SPACETRIGGER

Command	Description
DEFINE VOLUME	Assigns a volume to be used for storage within a specified storage pool.
DELETE SPACETRIGGER	Deletes the storage pool space trigger.
QUERY SPACETRIGGER	Displays information about a storage pool space trigger.
UPDATE SPACETRIGGER	Changes attributes of storage pool space trigger.

## DEFINE STATUSTHRESHOLD (Define a status monitoring threshold)

Use this command to define a new status monitoring threshold.

Status monitoring thresholds compare the defined conditions to the status monitoring server queries and inserts the results in the status monitoring table.

Multiple thresholds can be defined for an activity. For example, you can create a threshold that provides a warning status if storage pool capacity utilization is greater than 80%. You can then create another threshold that provides error status if storage pool capacity utilization is greater than 90%.

Note: If a threshold is already defined for an EXISTS condition, you cannot define another threshold with one of the other condition types.

## Privilege class

To issue this command, you must have system privilege.

## Syntax

```
>>-DEFine STAtusthreshold--threshold_name--activity----->
  .-Condition---EXists----.
>--+-----+-----+-----+-----+----->
  '-Condition---EXists--' '-Value---value-'
      +-GT-----+
      +-GE-----+
      +-LT-----+
      +-LE-----+
      '-Equal--'

  .-Status---Normal-----.
>--+-----+-----+-----+-----+-----><
  '-Status---Normal---'
      +-Warning+
      '-Error--'
```

## Parameters

threshold\_name (Required)

Specifies the threshold name. The name cannot exceed 48 characters in length.

activity (Required)

Specifies the activity for which you want to create status indicators. Specify one of the following values:

PROCESSSUMMARY

Specifies the number of processes that are currently active.

SESSIONSUMMARY

Specifies the number of sessions that are currently active.

CLIENTSESSIONSUMMARY

Specifies the number of client sessions that are currently active.

SCHEDCLIENTSESSIONSUMMARY

Specifies the number of scheduled client sessions.

DBUTIL

Specifies the database utilization percentage. The default warning threshold value is 80%, and the default error threshold value is 90%.

DBFREESPACE

Specifies the free space available in the database in gigabytes.

DBUSEDSPACE

Specifies the amount of database space that is used, in gigabytes.

ARCHIVELOGFREESPACE

Specifies the free space that is available in the archive log, in gigabytes.

STGPOOLUTIL

Specifies the storage pool utilization percentage. The default warning threshold value is 80%, and the default error threshold value is 90%.

STGPOOLCAPACITY

Specifies the storage pool capacity in gigabytes.

AVGSTGPOOLUTIL

Specifies the average storage pool utilization percentage across all storage pools. The default warning threshold value is 80%, and the default error threshold value is 90%.

TOTSTGPOOLCAPACITY

Specifies the total storage pool capacity in gigabytes for all available storage pools.

TOTSTGPOOLS

Specifies the number of defined storage pools.

TOTRWSTGPOOLS

Specifies the number of defined storage pools that are readable or writeable.

TOTNOTRWSTGPOOLS

Specifies the number of defined storage pools that are not readable or writeable.

STGPOOLINUSEANDDEFINED

Specifies the total number of defined volumes that are in use.

ACTIVELOGUTIL

Specifies the current percent utilization of the active log. The default warning threshold value is 80%, and the default error threshold value is 90%.

ARCHLOGUTIL

Specifies the current utilization of the archive log. The default warning threshold value is 80%, and the default error threshold value is 90%.

CPYSTGPOOLUTIL

Specifies the percent utilization for a copy storage pool. The default warning threshold value is 80%, and the default error threshold value is 90%.

PMRYSTGPOOLUTIL

Specifies the percent utilization for a primary storage pool. The default warning threshold value is 80%, and the default error threshold value is 90%.

DEVCLASSPCTDRVOFFLINE

Specifies the percent utilization of drives that are offline, by device class. The default warning threshold value is 25%, and the default error threshold value is 50%.

DEVCLASSPCTDRVPOLLING

Specifies the drives polling, by device class. The default warning threshold value is 25%, and the default error threshold value is 50%.

DEVCLASSPCTLIBPATHSOFFLINE

Specifies the library paths that are offline, by device class. The default warning threshold value is 25%, and the default error threshold value is 50%.

DEVCLASSPCTPATHSOFFLINE

Specifies the percentage of device class paths that are offline, by device class. The default warning threshold value is 25%, and the default error threshold value is 50%.

**DEVCLASSPCTDISKSNOTRW**

Specifies the percentage of disks that are not writable for the disk device class. The default warning threshold value is 25%, and the default error threshold value is 50%.

**DEVCLASSPCTDISKSUNAVAILABLE**

Specifies the percentage of the disk volumes that are unavailable, by device class. The default warning threshold value is 25%, and the default error threshold value is 50%.

**FILEDEVCLASSPCTSCRUNALLOCATABLE**

Specifies the percentage of scratch volumes that the server cannot allocate for a given non-shared file device class. The default warning threshold value is 25%, and the default error threshold value is 50%.

**Condition**

Specifies the condition that is used to compare the activity output to the specified value. The default value is EXISTS. Specify one of the following values:

**EXists**

Creates a status monitoring indicator if the activity exists.

**GT**

Creates a status monitoring indicator if the activity outcome is greater than the specified value.

**GE**

Creates a status monitoring indicator if the activity outcome is greater than or equal to the specified value.

**LT**

Creates a status monitoring indicator if the activity outcome is less than the specified value.

**LE**

Creates a status monitoring indicator if the activity outcome is less than or equal to the specified value.

**EQual**

Creates a status monitoring indicator if the activity outcome is equal to the specified value.

**Value (Required)**

Specifies the value that is compared with the activity output for the specified condition. You must specify this parameter, unless CONDITION is set to EXISTS. You can specify an integer in the range 0 - 999999999999999.

**Status**

Specifies that the status indicator created in status monitoring if the condition that is being evaluated passes. This optional parameter has a default value of NORMAL. Specify one of the following values:

**Normal**

Specifies that the status indicator has a normal status value.

**Warning**

Specifies that the status indicator has a warning status value.

**Error**

Specifies that the status indicator has an error status value.

## Define status threshold

Define a status threshold for average storage pool utilization percentage by issuing the following command:

```
define statusthreshold avgstgpl "AVGSTGPOOLUTIL" value=85  
condition=gt status=warning
```

## Related commands

Table 1. Commands related to DEFINE STATUSTHRESHOLD

Command	Description
DELETE STATUSTHRESHOLD (Delete a status monitoring threshold)	Deletes a status monitoring threshold.
QUERY MONITORSTATUS (Query the monitoring status)	Displays information about monitoring alerts and server status settings.
QUERY MONITORSETTINGS (Query the configuration settings for monitoring alerts and server status)	Displays information about monitoring alerts and server status settings.

Command	Description
QUERY STATUSTHRESHOLD (Query status monitoring thresholds)	Displays information about a status monitoring thresholds.
SET STATUSMONITOR (Specifies whether to enable status monitoring)	Specifies whether to enable status monitoring.
SET STATUSATRISKINTERVAL (Specifies whether to enable client at-risk activity interval evaluation)	Specifies whether to enable client at-risk activity interval evaluation
SET STATUSREFRESHINTERVAL (Set refresh interval for status monitoring)	Specifies the refresh interval for status monitoring.
SET STATUSSKIPASFAILURE (Specifies whether to use client at-risk skipped files as failure evaluation)	Specifies whether to use client at-risk skipped files as failure evaluation
UPDATE STATUSTHRESHOLD (Update a status monitoring threshold)	Changes the attributes of an existing status monitoring threshold.

## DEFINE STGPOOL (Define a storage pool)

Use this command to define a primary storage pool, copy storage pool, an active-data pool, a directory container storage pool, a container-copy storage pool, or a container storage pool in a cloud environment.

A primary storage pool provides a destination for backup files, archive files, or files that are migrated from client nodes. A copy storage pool provides a destination for copies of files that are in primary storage pools. An active-data pool provides a destination for active versions of backup data that are in primary storage pools. A container storage pool provides a destination for deduplicated files. A cloud storage pool provides storage in a cloud environment. A container-copy storage pool provides a tape copy of a directory-container storage pool. The maximum number of storage pools that you can define for a server is 999.

All volumes in a storage pool belong to the same device class. Random access storage pools use the DISK device type. After you define a random access storage pool, you must define volumes for the pool to create storage space.

Sequential access storage pools use device classes that you define for tape devices, files on disk (FILE device type), and storage on another server (SERVER device type). To create storage space in a sequential access storage pool, you must allow scratch volumes for the pool when you define or update it, or define volumes for the pool after you define the pool. You can also do both.

Restriction: If a client is using the simultaneous-write function and data deduplication, the data deduplication feature is disabled during backups to a storage pool.

The DEFINE STGPOOL command takes seven forms. The syntax and parameters for each form are defined separately.

Table 1. Commands related to DEFINE STGPOOL

Command	Description
BACKUP DB	Backs up the IBM Spectrum Protect database to sequential access volumes.
BACKUP STGPOOL	Backs up a primary storage pool to a copy storage pool.
COPY ACTIVE DATA	Copies active backup data.
DEFINE COLLOGROUP	Defines a collocation group.
DEFINE COLLOCMEMBER	Adds a client node or file space to a collocation group.
DEFINE DEVCLASS	Defines a device class.
DEFINE STGPOOLDIRECTORY	Defines a storage pool directory to a directory-container or cloud-container storage pool.
DEFINE VOLUME	Assigns a volume to be used for storage within a specified storage pool.
DELETE COLLOGROUP	Deletes a collocation group.
DELETE COLLOCMEMBER	Deletes a client node or file space from a collocation group.
DELETE STGPOOL	Deletes a storage pool from server storage.



Command	Description
MOVE DATA	Moves data from a specified storage pool volume to another storage pool volume.
MOVE MEDIA	Moves storage pool volumes that are managed by an automated library.
QUERY COLLOGGROUP	Displays information about collocation groups.
QUERY DEVCLASS	Displays information about device classes.
QUERY NODEDATA	Displays information about the location and size of data for a client node.
QUERY SHREDSTATUS	Displays information about data waiting to be shredded.
QUERY STGPOOL	Displays information about storage pools.
RENAME STGPOOL	Renames a storage pool.
REPAIR STGPOOL	Repairs a directory-container storage pool.
PROTECT STGPOOL	Protects a directory-container storage pool.
RESTORE STGPOOL	Restores files to a primary storage pool from copy storage pools.
RESTORE VOLUME	Restores files stored on specified volumes in a primary storage pool from copy storage pools.
SET DRMPRIMSTGPOOL	Specifies that primary storage pools are managed by DRM.
SHRED DATA	Manually starts the process of shredding deleted data.
UPDATE COLLOGGROUP	Updates the description of a collocation group.
UPDATE STGPOOL	Changes the attributes of a storage pool.

- **DEFINE STGPOOL (Define a cloud-container storage pool)**  
Use this command to define a container storage pool in a cloud environment. This type of storage pool is used for data deduplication. Cloud-container storage pools are not supported on Linux on System z®.
- **DEFINE STGPOOL (Define a directory-container storage pool)**  
Use this command to define a directory-container storage pool that is used for data deduplication.
- **DEFINE STGPOOL (Define a container-copy storage pool)**  
Use this command to define a container-copy storage pool to hold a copy of data from a directory-container storage pool.
- **DEFINE STGPOOL (Define a primary storage pool assigned to random access devices)**  
Use this command to define a primary storage pool that is assigned to random access devices.
- **DEFINE STGPOOL (Define a primary storage pool assigned to sequential access devices)**  
Use this command to define a primary storage pool that is assigned to sequential access devices.
- **DEFINE STGPOOL (Define a copy storage pool assigned to sequential access devices)**  
Use this command to define a copy storage pool that is assigned to sequential access devices.
- **DEFINE STGPOOL (Define an active-data pool assigned to sequential-access devices)**  
Use this command to define an active-data pool assigned to sequential-access devices.

## DEFINE STGPOOL (Define a cloud-container storage pool)

Use this command to define a container storage pool in a cloud environment. This type of storage pool is used for data deduplication. Cloud-container storage pools are not supported on Linux on System z®.

Tip: To optimize backup and archive performance, set up one or more local storage directories to temporarily hold data that IBM Spectrum Protect™ is transferring to the cloud. After you use the DEFINE STGPOOL command to define a cloud-container storage pool, use the DEFINE STGPOOLDIRECTORY command to assign local storage directories to the cloud-container storage pool. For more information, see Optimizing performance for cloud object storage.

### Privilege class

To issue this command, you must have system privilege.

## Syntax

```
>>-DEFine STGpool--pool_name--STGType---Cloud----->

.-Pooltype---Primary-.
>-----+-----+-----+-----+----->
'-Pooltype---Primary-' '-DEscription---description-'

.-CLOUDType---Swift-----
>-----+-----+-----+-----+----->
'-CLOUDType---+Azure-----+'
                +-S3-----+
                +-Softlayer+
                +-Swift-----+
                '-V1Swift---'

(1)
>--IDentity---cloud_identity-----PAssword---password----->

.-CLOUDLocation---Offpremise-----
>-----+-----+-----+-----+----->
'-CLOUDLocation---+Offpremise+-'
                '-ONpremise--'

>-----+-----+-----+-----+----->
|                                     (2) |
'-BUCKETName---bucket_name-----'

.-ACCess---READWrite-----
>-----+-----+-----+-----+----->
'-ACCess---+READWrite----+'
                +-READOnly----+
                '-UNAVailable-'

.-MAXWriters---NOLimit-----
>-----+-----+-----+-----+----->
'-MAXWriters---+NOLimit-----+'
                '-maximum_writers-'

.-REUsedelay---1----. .-ENCRypt---Yes-----
>-----+-----+-----+-----+----->
'-REUsedelay---days-' |                                     (3) |
                        '-ENCRypt---+Yes+-----'
                        '-No--'

.-COMPReSSion---Yes-----
>-----+-----+-----+-----+----->>
'-COMPReSSion---+Yes+-'
                '-No--'
```

### Notes:

1. If you specified CLOUDTYPE=AZURE, do not specify the IDENTITY parameter.
2. This parameter is valid only if you specify CLOUDTYPE=S3.
3. The default value of the ENCRYPT parameter is conditional. The server encrypts data by default if the CLOUDLOCATION parameter is set to OFFPREMISE. If the CLOUDLOCATION parameter is set to ONPREMISE, the default is No.

## Parameters

### pool\_name (Required)

Specifies the cloud storage pool to define. This parameter is required. The maximum length of the name is 30 characters.

### STGType=Cloud (Required)

Specifies the type of storage that you want to define for a cloud storage pool. To ensure that the storage pool can be used in a cloud environment, you must specify STGTYPE=CLOUD.

Tip: To optimize performance, set up one or more local storage directories to temporarily hold data that is moving to the cloud. After you define a cloud-container storage pool, use the DEFINE STGPOOLDIRECTORY command to assign local directories to the cloud-container storage pool.

### Pooltype=Primary

Specifies that you want to define a primary storage pool. This parameter is optional.

#### DESCRIPTION

Specifies a description of the cloud storage pool. This parameter is optional. The maximum length of the description is 255 characters. Enclose the description in quotation marks if it contains blank characters.

#### CLOUDTYPE

Specifies the type of cloud environment where you are configuring the storage pool.

You can specify one of the following values:

##### Azure

Specifies that the storage pool uses a Microsoft Azure cloud computing system.

##### S3

Specifies that the storage pool uses a cloud computing system with the Simple Storage Service (S3) protocol, such as IBM® Cloud Object Storage or Amazon Web Services (AWS) S3. If you define a storage pool as using S3 with this parameter, you cannot later change the storage pool type by using the UPDATE STGPOOL command.

##### Softlayer

Specifies that the storage pool uses an IBM SoftLayer® (IBM Bluemix) cloud computing system with an OpenStack Swift cloud computing system.

##### Swift

Specifies that the storage pool uses an OpenStack Swift cloud computing system. This value also specifies that the storage pool uses Version 2 of the protocol for authentication to the cloud. The URL of the cloud usually contains the version number of the protocol it is using.

##### V1Swift

Specifies that the storage pool uses an OpenStack Swift cloud computing system. This value also specifies that the storage pool uses Version 1 of the protocol for authentication to the cloud. The URL of the cloud usually contains the version number of the protocol it is using.

This parameter is optional. If you do not specify the parameter, the default value, SWIFT, is used.

#### CLOUDURL

Specifies the URL of the cloud environment where you are configuring the storage pool. Based on your cloud provider, you can use a blob service endpoint, region endpoint URL, an accesser IP address, a public authentication endpoint, or a similar value for this parameter. Be sure to include the protocol, such as `https://` or `http://`, at the beginning of the URL. The maximum length of the web address is 870 characters. The CLOUDURL parameter is not validated until the first backup begins.

For more information about how to locate these values, select your cloud service provider from the list on the Configuring a cloud-container storage pool for data storage page.

Tip: To use more than one IBM Cloud Object Storage accesser, list the accesser IP addresses separated by a vertical bar (|), with no spaces, such as in the following example:

```
CLOUDURL=<accesser_URL1>|<accesser_URL2>|<accesser_URL3>
```

If you are using the Operations Center, type an accesser IP address in the URL field of the Add Storage pool wizard, and then press Enter to add additional IP addresses. Use multiple accessers to improve performance.

This parameter is required if you specify the CLOUDTYPE parameter.

- Azure
- S3 (Simple Storage Service)
- Softlayer
- Swift
- V1Swift

#### IDENTITY

Specifies the user ID for the cloud that is specified in the STGTYPE=CLOUD parameter. This parameter is required for all supported cloud computing systems except Azure. If you specified CLOUDTYPE=AZURE, do not specify the IDENTITY parameter. Based on your cloud provider, you can use an access key ID, a user name, a tenant name and user name, or a similar value for this parameter. The maximum length of the user ID is 255 characters.

#### PASSWORD (Required)

Specifies the password for the cloud that is specified in the STGTYPE=CLOUD parameter. Based on your cloud provider, you can use a shared access signature (SAS) token, secret access key, an API key, a password, or a similar value for this parameter. This parameter is required. The maximum length of the password is 255 characters. The IDENTITY and PASSWORD parameters are not validated until the first backup begins.

#### CLOUDLOCATION

Specifies the physical location of the cloud that is specified in the CLOUD parameter. This parameter is optional. The default value is OFFPREMISE. You can specify one of the following values:

- Offpremise
- ONpremise

#### BUCKETName

Specifies the name for an AWS S3 bucket or a IBM Cloud Object Storage vault to use with this storage pool, instead of using the default bucket name or vault name. This parameter is optional, and is valid only if you specify CLOUDTYPE=S3. If the name that you specify does not exist, the server creates a bucket or vault with the specified name before using the bucket or vault. Follow the naming restrictions for your cloud provider when specifying this parameter. Review the permissions for the bucket or vault and make sure that the credentials for this storage pool have permission to read, write, list, and delete objects in this bucket or vault. If you do not have the ability to change or view the permissions, and you have not already written data to this storage pool, use the UPDATE STGPOOL command with the BUCKETNAME parameter to use a different bucket or vault.

#### ACCess

Specifies how client nodes and server processes access the cloud storage pool. This parameter is optional. The default value is READWRITE. You can specify one of the following values:

##### READWrite

Specifies that client nodes and server processes can read and write to the cloud storage pool. This value is the default.

##### READOnly

Specifies that client nodes and server processes can read only from the cloud storage pool.

##### UNAVailable

Specifies that client nodes and server processes cannot access the cloud storage pool.

#### MAXWriters

Specifies the maximum number of writing sessions that can run concurrently on the cloud storage pool. Specify a maximum number of writing sessions to control the performance of the cloud storage pool from negatively impacting other system resources. This parameter is optional. The default value is NOLIMIT. You can specify one of the following values:

##### NOLimit

Specifies that no maximum size limit exists for the number of writers that you can use. This value is the default.

##### maximum\_writers

Limits the maximum number of writers that you can use. Specify an integer in the range 1 - 99999.

#### REUsedelay

Specifies the number of days that must elapse after all deduplicated extents are removed from a cloud storage pool. This parameter controls the duration that deduplicated extents are associated with a cloud storage pool. When the value that is specified for the parameter expires, the deduplicated extents are deleted from the cloud storage pool. The default is 1. You can specify one of the following values:

##### 1

Specifies that deduplicated extents are deleted from a cloud storage pool after one day. This value is the default.

##### days

You can specify an integer in the range 0 - 9999.

Tip: Set this parameter to a value that is greater than the number specified for the SET DRMDBBACKUPEXPIREDAYS command. If you set this parameter to a higher value, you can ensure that when you restore the database to an earlier level, the references to files in the cloud storage pool are still valid.

#### ENCRypt

Specifies whether the server encrypts client data before it writes it to the storage pool. You can specify the following values:

##### Yes

Specifies that client data is encrypted by the server.

##### No

Specifies that client data is not encrypted by the server.

This parameter is optional. The default depends on the physical location of the cloud, which is specified by the CLOUDLOCATION parameter. If the cloud is off premise, the server encrypts data by default. If the cloud is on premises, the server does not encrypt data by default.

#### COMPRession

Specifies whether data is compressed in the storage pool. This parameter is optional. You can specify one of the following values:

- No  
Specifies that data is not compressed in the storage pool.
- Yes  
Specifies that data is compressed in the storage pool. This is the default.

## Example 1: Define an OpenStack Swift cloud-container storage pool

---

Define an OpenStack Swift cloud-container storage pool that is named STGPOOL1.

```
define stgpool stgpool1 stgtype=cloud
cloudtype=swift cloudurl=http://123.234.123.234:5000/v2.0
identity=admin:admin password=password description="OpenStack Swift cloud"
```

## Example 2: Define a cloud-container primary storage pool

---

Define a cloud-container primary storage pool that is named STGPOOL1.

```
define stgpool stgpool1 stgtype=cloud
cloudtype=swift cloudurl=http://123.234.123.234:5000/v2.0
identity=admin:admin password=protect8991 pooltype=primary
```

## Example 3: Define a cloud-container storage pool with read only access

---

Define a cloud-container storage pool that is named STGPOOL1 with read only access.

```
define stgpool stgpool1 stgtype=cloud
cloudtype=swift cloudurl=http://123.234.123.234:5000/v2.0
identity=admin:admin password=protect8991 access=readonly
```

## Example 4: Define a cloud-container storage pool with 99 writing sessions

---

Define a cloud-container storage pool that is named STGPOOL1 with 99 writing sessions.

```
define stgpool stgpool1 stgtype=cloud
cloudtype=swift cloudurl=http://123.234.123.234:5000/v2.0
identity=admin:admin password=protect8991 maxwr=99
```

## Example 5: Define a cloud-container storage pool in which deduplicated extents are deleted after two days

---

Define a cloud-container storage pool that is named STGPOOL1 and deduplicated extents are deleted after two days.

```
define stgpool stgpool1 stgtype=cloud
cloudtype=swift cloudurl=http://123.234.123.234:5000/v2.0
identity=admin:admin password=protect8991 reusedelay=2
```

### Related tasks:

Configuring a cloud-container storage pool for data storage

### Related information:

Optimizing performance for cloud object storage

AIX

Linux

Windows

## DEFINE STGPOOL (Define a directory-container storage pool)

---

Use this command to define a directory-container storage pool that is used for data deduplication.

### Privilege class

---

To issue this command, you must have system privilege.

### Syntax

---

```
>>-DEfine STGpool--pool_name--STGType----DIrectory----->
```

```

.-Pooltype----Primary-.
>-----+-----+-----+-----+----->
'-Pooltype----Primary-' '-Description----description-'

.-Access----ReadWrite------.
>-----+-----+-----+-----+----->
'-Access----+ReadWrite----+'
          +-ReadOnly----+
          '-UNAvailable-'

.-MAXSize----NOLimit------.
>-----+-----+-----+-----+----->
'-MAXSize----+NOLimit-----+'
          '-maximum_file_size-'

.-MAXWriters----NOLimit------.
>-----+-----+-----+-----+----->
'-MAXWriters----+NOLimit-----+'
          '-maximum_writers-'

>-----+-----+-----+-----+----->
'-NEXTstgpool----pool_name-'

>-----+-----+-----+-----+----->
'-PROTECTstgpool----target_stgpool-'

>-----+-----+-----+-----+----->
|                                     .-,------. |
|                                     V               | |
'-PROTECTLOCALstgpools----local_target_stgpool+-'

.-REUsedelay----1----. .-ENCRypt----Yes------.
>-----+-----+-----+-----+----->
'-REUsedelay----days-' '-ENCRypt----+Yes+-'
                          '-No--'

.-COMPRession----Yes------.
>-----+-----+-----+-----+-----><
'-COMPRession----+Yes+-'
                          '-No--'

```

## Parameters

### pool\_name (Required)

Specifies the storage pool to define. This parameter is required. The maximum length of the name is 30 characters.

### STGType=Directory (Required)

Specifies the type of storage that you want to define for a storage pool. This parameter specifies that a directory-container type of storage pool is assigned to the storage pool. You must define a storage pool directory for this type of storage pool by using the DEFINE STGPOOLDIRECTORY command.

Requirements:

- Ensure that enough space is available on the file system for the directory-container storage pool.
- You must store the directory-container storage pool and the DB2® database on separate mount points on the file system. The directory-container storage pool might grow to occupy all the space on the directory it is stored on.
- You must use a file system other than the file system where the IBM Spectrum Protect™ server is located.

### Pooltype=Primary

Specifies that you want the storage pool to be used as a primary storage pool. This parameter is optional.

### Description

Specifies a description of the storage pool. This parameter is optional. The maximum length of the description is 255 characters. Enclose the description in quotation marks if it contains blank characters.

### Access

Specifies how client nodes and server processes can access the storage pool. This parameter is optional. You can specify one of the following values:

#### ReadWrite

Specifies that client nodes and server processes can read and write to the storage pool.

#### ReadOnly

Specifies that client nodes and server processes can read only from the storage pool.  
UNAVailable

Specifies that client nodes and server processes cannot access the storage pool.

#### MAXSize

Specifies the maximum size for a physical file that the server can store in the storage pool. This parameter is optional. The default value is NOLIMIT. You can specify one of the following values:

#### NOLimit

Specifies that there is no maximum size limit for physical files that are stored in the storage pool.

#### maximum\_file\_size

Limits the maximum physical file size. Specify an integer in the range 1 - 999999, followed by a scale factor. For example, MAXSIZE=5G specifies that the maximum file size for this storage pool is 5 GB. You can use one of the following scale factors:

Table 1. Scale factor  
for the maximum file  
size

Scale factor	Meaning
K	kilobyte
M	megabyte
G	gigabyte
T	terabyte

Tip: If you do not specify a unit of measurement for the maximum file size, the value is specified in bytes.

When the physical size of the storage pool exceeds the MAXSIZE parameter, the following table shows where files are typically stored.

Table 2. The location of a file according to the file size and the pool that is specified

Pool that is specified	Result
No pool is specified as the next storage pool in the hierarchy.	The server does not store the file.
A pool is specified as the next storage pool in the hierarchy.	The server stores the file in the storage pool that you specified.

Tip: If you also specify the NEXTstgpool parameter, define one storage pool in your hierarchy to have no limit on the maximum file size by specifying the MAXSize=NOLimit parameter. When you have at least one pool with no size limit, you ensure that no matter what its size, the server can store the file.

For multiple files that are sent during data deduplication processing, the server considers the size of the data deduplication process to be the file size. If the total size of all files in the process is larger than the maximum size limit, the server does not store the files in the storage pool.

#### MAXWriters

Specifies the maximum number of I/O threads for the following processes:

- The number of I/O threads that can run concurrently on the directory-container storage pool.
- The number of I/O threads that are written simultaneously to the directory-container storage pool.

This parameter is optional. As a best practice, use the default value of NOLIMIT. You can specify the following values:

#### NOLimit

Specifies that no maximum number of I/O threads are written to the storage pool.

#### maximum\_writers

Limits the maximum number of I/O threads that you can use. Specify an integer in the range 1 - 99999.

Tip: The IBM Spectrum Protect server manages the number of I/O threads automatically based on the resources that are available and the server load.

#### NEXTstgpool

Specifies the name of a random-access or primary sequential storage pool to which files are stored when the directory-container storage pool is full. This parameter is optional.

Restrictions:

- To ensure that you do not create a chain of storage pools that leads to an endless loop, specify at least one storage pool in the hierarchy with no value.
- If you specify a sequential-access pool as the next storage pool, the pool must be in either NATIVE or NONBLOCK data format.
- Do not specify a directory-container or cloud-container storage pool.
- Do not use this parameter to specify a storage pool for data migration.

#### PROTECTstgpool

Specifies the name of the directory-container storage pool on the target replication server where the data is backed up when you use the PROTECT STGPOOL command for this storage pool. This parameter is optional.

#### PROTECTLOCALstgpools

Specifies the name of the container-copy storage pool on a local device where the data is backed up. This container-copy storage pool will be a local target storage pool when you use the PROTECT STGPOOL command. You can specify a maximum of two container-copy storage pool names. Separate multiple names with commas and no intervening spaces. The maximum length of each name is 30 characters. This parameter is optional.

#### REUsedelay

Specifies the number of days that must elapse before all deduplicated extents are removed from a directory-container storage pool. This parameter controls the duration that deduplicated extents are associated with a directory-container storage pool after they are no longer referenced. When the value that is specified for the parameter expires, the deduplicated extents are deleted from the directory-container storage pool. Specify an integer in the range 0 - 9999. The default value for directory-container storage pools is 1, which means that deduplicated extents that are no longer referenced are deleted from a directory-container storage pool after 1 day.

Set this parameter to a value greater than the number that is specified as your database backup period to ensure that data extents are still valid when you restore the database to another level.

#### ENCRypt

Specifies whether the server encrypts client data before the server writes the data to the storage pool. You can specify the following values:

Yes

Specifies that client data is encrypted by the server.

No

Specifies that client data is not encrypted by the server.

#### COMPRession

Specifies whether data is compressed in the storage pool. This parameter is optional. You can specify one of the following values:

No

Specifies that data is not compressed in the storage pool.

Yes

Specifies that data is compressed in the storage pool. This is the default.

### Example: Define a directory-container storage pool that is configured for overflow storage when the storage pool is full

---

Define a directory-container storage pool that is named STGPOOL1. The storage pool is configured for overflow storage to a tape storage pool when the storage pool is full.

```
define stgpool stgpool1 stgtype=directory nextstgpool=overflow_tape_pool
```

### Example: Define a directory-container storage pool that specifies the maximum file size

---

Define a directory-container storage pool that is named STGPOOL2. The storage pool specifies the maximum file size that the server can store in the storage pool as 100 megabytes.

```
define stgpool stgpool2 stgtype=directory maxsize=100M
```

### Example: Define a directory-container storage pool on the source replication server with a directory-container storage pool on the target replication server to back up data

---



Define a directory-container storage pool that is named STGPOOL3. The data for storage pool STGPOOL3 is backed up to a directory-container storage pool, TARGET\_STGPOOL3 on the target replication server.

```
define stgpool stgpool3 stgtype=directory protectstgpool=target_stgpool3
```

## Example: Define a directory-container storage pool on the source replication server with a container-copy storage pool to back up data locally

Define a directory-container storage pool that is named STGPOOL3. The data for storage pool STGPOOL3 is backed up to a local container-copy storage pool, TARGET\_LOCALSTGPOOL.

```
define stgpool stgpool3 stgtype=directory protectlocalstgpools=target_localstgpool
```

## Example: Define a directory-container storage pool and disable compression

Define a directory-container storage pool that is named STGPOOL1 and disable compression.

```
define stgpool stgpool1 stgtype=directory compression=no
```

Table 3. Commands related to DEFINE STGPOOL (Define a directory-container storage pool)

Command	Description
DEFINE STGPOOLDIRECTORY	Defines a storage pool directory to a directory-container or cloud-container storage pool.
PROTECT STGPOOL	Protects a directory-container storage pool.
QUERY CONTAINER	Displays information about a container.
QUERY STGPOOL	Displays information about storage pools.
REPAIR STGPOOL	Repairs a directory-container storage pool.
UPDATE STGPOOL (directory-container)	Update a directory-container storage pool.

## DEFINE STGPOOL (Define a container-copy storage pool)

Use this command to define a container-copy storage pool to hold a copy of data from a directory-container storage pool.

### Privilege class

To issue this command, you must have system privilege.

### Syntax

```
>>-DEFine STGpool--pool_name--device_class_name----->
>--POoltype-----COPYContainer--MAXSCRatch-----number----->
>--+-----+----->
  '-DESCRiption-----description-'
  .-ACCess-----READWrite-----
>--+-----+----->
  '-ACCess-----+READWrite-----+'
                    +-READOnly-----+
                    '-UNAVailable-'

  .-PROTECTPRocess-----2----- .-REClaim-----100-----
>--+-----+-----+----->
  '-PROTECTPRocess-----number-' '-REClaim-----percent-'

  .-RECLAIMLIMit-----NOLimit-----
>--+-----+----->
  '-RECLAIMLIMit-----+NOLimit-----+'
                    '-vol_limit-'
```

```

.-REUsedelay-----0-----
>-----+----->>
'-REUsedelay-----days-'

```

## Parameters

---

### pool\_name (Required)

Specifies the name of the container-copy storage pool. The name must be unique, and the maximum length is 30 characters.

### device\_class\_name (Required)

Specifies the name of the sequential access device class to which this storage pool is assigned.

Restriction: You cannot specify the following device class types:

- DISK
- FILE
- CENTERA
- NAS
- REMOVABLEFILE
- SERVER

Restriction: Virtual tape libraries are not supported, regardless of which library type is defined. Only physical tape is supported.

### POOLtype=COPYCONTAINER (Required)

Specifies that you want to define a container-copy storage pool. A container-copy storage pool is used only to store a copy of data from a directory-container storage pool.

### MAXSCRATCH (Required)

Specifies the maximum number of scratch volumes that the server can request for this storage pool. You can specify an integer in the range 0 - 100000000. If the server can request scratch volumes as needed, you do not have to define each volume to be used.

The value of this parameter is used to estimate the total number of volumes that are available in the storage pool and the corresponding estimated capacity for the storage pool.

Scratch volumes are automatically deleted from the storage pool when they become empty. However, if the access mode for a scratch volume is OFFSITE, the volume is not deleted from the storage pool until the access mode is changed. An administrator can then query the server for empty, offsite scratch volumes and return them to the onsite location.

### DESCRIPTION

Specifies a description of the storage pool. This parameter is optional. The maximum length of the description is 255 characters. Enclose the description in quotation marks if it contains any blank characters.

### ACCESS

Specifies how server processes such as storage-pool protection and repair can access data in the storage pool. This parameter is optional. The default value is READWRITE. You can specify one of the following values:

#### READWRITE

Specifies that the server can read and write to volumes in the storage pool.

#### READONLY

Specifies that the server can only read volumes in the storage pool. The server can use data in the storage pool to restore extents to directory-container storage pools. No operations that write to the container-copy storage pool are allowed.

#### UNAVAILABLE

Specifies that the server cannot access data that is stored on volumes in the storage pool.

### PROTECTPROCESS

Specifies the maximum number of parallel processes that are used when you issue the PROTECT STGPOOL command to copy data to this pool from a directory-container storage pool. This parameter is optional. Enter a value in the range 1 - 20. The default value is 2.

The time that is required to complete the copy operation might be decreased by using multiple, parallel processes. However, in some cases when multiple processes are running, one or more of the processes must wait to use a volume that is already in use by a different process.

When you specify this value, consider the number of logical and physical drives that can be dedicated to the copy operation. To access a tape volume, the server uses a mount point and a drive. The number of available mount points and

drives depends on the mount limit of the device class for the storage pool, and on other server and system activity.

This parameter is ignored if you use the PREVIEW=YES option on the PROTECT STGPOOL command. In that case, only one process is used and no mount points or drives are needed.

#### REClaim

Specifies when a volume becomes eligible for reclamation and reuse. Specify eligibility as the percentage of a volume's space that is occupied by extents that are no longer stored in the associated directory-container storage pool. Reclamation moves any extents that are still stored in the associated directory-container storage pool from eligible volumes to other volumes. Reclamation occurs only when a PROTECT STGPOOL command stores data into this storage pool.

This parameter is optional. You can specify an integer in the range 1 - 100. The default value is 100, which means that volumes in this storage pool are not reclaimed.

The server determines that the volume is a candidate for reclamation if the percentage of reclaimable space on a volume is greater than the reclamation threshold of the storage pool.

By setting the reclaim value to 50 percent or greater, data that is moved from two reclaimed volumes uses no more than the equivalent of one new volume.

Use caution when you use reclamation with container-copy storage pools that have offsite volumes. When an offsite volume becomes eligible for reclamation, in effect the server moves the extents on the volume back to the onsite location. If a disaster occurs onsite, the server can obtain extents from the offsite volume if the restored database refers to extents on the offsite volume. Therefore, for disaster recovery purposes, ensure that you schedule database backups to run after storage pool protection schedules and DRM move schedules have run, and ensure that all database backup volumes are taken offsite along with the DRM volumes.

Tip: Set different reclamation values for offsite container-copy storage pools and onsite container-copy storage pools. Because container-copy storage pools store deduplicated data, the data extents are spread across multiple tape volumes. When you choose a reclamation threshold for an offsite copy, carefully consider the number of available mount points and the number of tape volumes that you must retrieve if a disaster occurs. Setting a higher threshold means that you must retrieve more volumes than you would if your reclamation value was lower. Using a lower threshold reduces the number of mount points that are required in a disaster. The preferred method is to set the reclamation value for offsite copies to 60, and for onsite copies, in the range 90 - 100.

#### RECLAIMLIMit

Specifies the maximum number of volumes that the server reclaims when you issue the PROTECT STGPOOL command and specify the RECLAIM=YESLIMITED or RECLAIM=ONLYLIMITED option. This parameter is valid only for container-copy storage pools. This parameter is optional. The default value is NOLIMIT. You can specify one of the following values:

##### NOLimit

Specifies that all volumes in the container-copy storage pool are processed for reclamation.

##### vol\_limit

Specifies the maximum number of volumes in the container-copy storage pool that are reclaimed. The value that you specify determines how many new scratch tapes are available after reclamation processing completes. You can specify a number in the range 1 - 100000.

#### REUsedelay

Specifies the number of days that must elapse after all extents are deleted from a volume before the volume can be rewritten or returned to scratch status. This parameter is optional. You can specify an integer in the range 0 - 9999. The default value is 0, which means that a volume can be rewritten or returned to scratch status as soon as all the extents are deleted from the volume.

Tip: Use this parameter to ensure that when you restore the database to an earlier level, database references to extents in the storage pool are still valid. You must set this parameter to a value greater than the number of days you plan to retain the oldest database backup. If you use disaster recovery manager, the number of days that are specified for this parameter must be the same as the number specified for the SET DRMDBBACKUPEXPIREDDAYS command.

## Example: Define a container-copy storage pool with an LTO7A device class

---

Define a container-copy storage pool, CONTAINER1\_COPY2, to the LTO7A device class. Allow up to 50 scratch volumes for this pool. Delay the reuse of volumes for 45 days.

```
define stgpool container1_copy2 lto7a pooltype=copycontainer
maxscratch=50 reusedelay=45
```

Table 1. Commands related to DEFINE STGPOOL (Define a container-copy storage pool)





## MAXSize

Specifies the maximum size for a physical file that the server can store in the storage pool. This parameter is optional. The default value is NOLIMIT. You can specify the following values:

### NOLimit

Specifies that there is no maximum size limit for physical files that are stored in the storage pool.

### maximum\_file\_size

Limits the maximum physical file size. Specify an integer 1 - 999999 terabytes, followed by a scale factor. For example, MAXSIZE=5G specifies that the maximum file size for this storage pool is 5 GB. You can use one of the following scale factors:

Scale factor	Meaning
K	kilobyte
M	megabyte
G	gigabyte
T	terabyte

The client estimates the size of files that are sent to the server. The client estimate is used rather than the actual amount of data that is sent to the server. Client options, such as deduplication, compression, and encryption, can cause the actual amount of data that is sent to the server to be larger or smaller than the size estimate. For example, the compression of a file might be smaller in size than the estimate, thus sending less data than the estimate. Furthermore, a binary file might be larger in size after the compression processing, thus sending more data than the estimate.

When the physical size of the storage pool exceeds the MAXSIZE parameter, the following table shows where files are typically stored.

Table 1. The location of a file according to the file size and the pool that is specified

File size	Pool specified	Result
Exceeds the maximum size	No pool is specified as the next storage pool in the hierarchy	The server does not store the file
	A pool is specified as the next storage pool in the hierarchy	The server stores the file in the next storage pool that can accept the file size

Tip: If you also specify the NEXTstgpool parameter, define one storage pool in your hierarchy to have no limit on the maximum file size by specifying the MAXSize=NOLimit parameter. When you have at least one pool with no size limit, you ensure that no matter what its size, the server can store the file.

For multiple files that are sent in a single transaction, the server considers the size of the transaction to be the file size. If the total size of all files in the transaction is larger than the maximum size limit, the server does not store the files in the storage pool.

## CRCDATA

Specifies whether a cyclic redundancy check (CRC) validates storage pool data when audit volume processing occurs on the server. This parameter is optional. The default value is NO. By setting CRCDATA to YES and scheduling an AUDIT VOLUME command, you can continually ensure the integrity of data that is stored in your storage hierarchy. You can specify the following values:

### Yes

Specifies that data is stored containing CRC information, allowing for audit volume processing to validate storage pool data. This mode impacts performance because more expenditure is required to calculate and compare CRC values between the storage pool and the server.

### No

Specifies that data is stored without CRC information.

## NEXTstgpool

Specifies a primary storage pool to which files are migrated. This parameter is optional.

If you do not specify a next storage pool, the following actions occur:

- The server cannot migrate files from this storage pool
- The server cannot store files that exceed the maximum size for this storage pool in another storage pool

Restrictions:

- To ensure that you do not create a chain of storage pools that leads to an endless loop, specify at least one storage pool in the hierarchy with no value.
- If you specify a sequential-access pool as the next storage pool, the pool must be in either NATIVE or NONBLOCK data format.
- Do not specify a directory-container or cloud-container storage pool.
- Do not use this parameter to specify a storage pool for data migration.

#### HIghmig

Specifies that the server starts migration for this storage pool when the amount of data in the pool reaches this percentage of the pool's estimated capacity. This parameter is optional. You can specify an integer 0 - 100. The default value is 90.

When the storage pool exceeds the high migration threshold, the server can start migration of files by node, to the next storage pool. The NEXTSTGPOOL parameter defines this setting. You can specify HIGHMIG=100 to prevent migration for this storage pool.

#### LOwmig

Specifies that the server stops migration for this storage pool when the amount of data in the pool reaches this percentage of the pool's estimated capacity. This parameter is optional. You can specify an integer 0 - 99. The default value is 70.

When migration is by node or file space, depending upon collocation, the level of the storage pool can fall below the value that you specified for this parameter. To empty the storage pool, set LOWMIG=0.

#### CAChe

Specifies whether the migration process leaves a cached copy of a file in this storage pool after you migrate the file to the next storage pool. This parameter is optional. The default value is NO. You can specify the following values:

Yes

Specifies that caching is enabled.

No

Specifies that caching is disabled.

Using cache might improve the ability to retrieve files, but might affect the performance of other processes.

#### MIGPRocess

Specifies the number of processes that the server uses for migrating files from this storage pool. This parameter is optional. You can specify an integer 1 - 999. The default value is 1.

During migration, these processes are run in parallel to provide the potential for improved migration rates.

Tips:

- The number of migration processes is dependent upon the following settings:
  - The MIGPROCESS parameter
  - The collocation setting of the next pool
  - The number of nodes or the number of collocation groups with data in the storage pool that is being migrated

For example, suppose that `MIGPROCESS = 6`, the next pool `COLLOCATE` parameter is set to `NODE`, but there are only two nodes with data on the storage pool. Migration processing consists of only two processes, not six. If the `COLLOCATE` parameter is set to `GROUP` and both nodes are in the same group, migration processing consists of only one process. If the `COLLOCATE` parameter is set to `NO` or `FILESPACE`, and each node has two file spaces with backup data, then migration processing consists of four processes.
- When you specify this parameter, consider whether the simultaneous-write function is enabled for server data migration. Each migration process requires a mount point and a drive for each copy storage pool and active-data pool that is defined to the target storage pool.

#### MIGDelay

Specifies the minimum number of days a file must remain in a storage pool before it becomes eligible for migration. To calculate a value to compare to the specified MIGDELAY value, the server counts the following items:

- The number of days that the file was in the storage pool
- The number of days, if any, since the file was retrieved by a client

The lesser of the two values are compared to the specified MIGDELAY value. For example, if all the following conditions are true, a file is not migrated:

- A file was in a storage pool for five days.
- The file was accessed by a client within the past three days.

- The value that is specified for the MIGDELAY parameter is four days.

This parameter is optional. You can specify an integer 0 - 9999. The default is 0, which means that you do not want to delay migration.

If you want the server to count the number of days that are based on when a file was stored and not when it was retrieved, use the NORETRIEVEDATE server option.

#### MIGContinue

Specifies whether you allow the server to migrate files that do not satisfy the migration delay time. This parameter is optional. The default is YES.

Because you can require that files remain in the storage pool for a minimum number of days, the server may migrate all eligible files to the next storage pool yet not meet the low migration threshold. This parameter allows you to specify whether the server is allowed to continue the migration process by migrating files that do not satisfy the migration delay time.

You can specify one of the following values:

#### Yes

Specifies that, when necessary to meet the low migration threshold, the server continues to migrate files that do not satisfy the migration delay time.

If you allow more than one migration process for the storage pool, some files that do not satisfy the migration delay time may be migrated unnecessarily. As one process migrates files that satisfy the migration delay time, a second process could begin migrating files that do not satisfy the migration delay time to meet the low migration threshold. The first process that is still migrating files that satisfy the migration delay time might have, by itself, caused the low migration threshold to be met.

#### No

Specifies that the server stops migration when no eligible files remain to be migrated, even before reaching the low migration threshold. The server does not migrate files unless the files satisfy the migration delay time.

#### AUTOCopy

Specifies when IBM Spectrum Protect™ runs simultaneous-write operations. The default value is CLIENT. This parameter is optional and affects the following operations:

- Client store sessions
- Server import processes
- Server data-migration processes

If an error occurs while data is being simultaneously written to a copy storage pool or active-data pool during a migration process, the server stops writing to the failing storage pools for the remainder of the process. However, the server continues to store files into the primary storage pool and any remaining copy storage pools or active-data pools. These pools remain active for the duration of the migration process. Copy storage pools are specified using the COPYSTGPOOLS parameter. Active-data pools are specified using the ACTIVEDATAPOOLS parameter.

You can specify one of the following values:

#### None

Specifies that the simultaneous-write function is disabled.

#### CLient

Specifies that data is written simultaneously to copy storage pools and active-data pools during client store sessions or server import processes. During server import processes, data is written simultaneously to only copy storage pools. Data is not written to active-data pools during server import processes.

#### MIGRation

Specifies that data is written simultaneously to copy storage pools and active-data pools only during migration to this storage pool. During server data-migration processes, data is written simultaneously to copy storage pools and active-data pools only if the data does not exist in those pools. Nodes whose data is being migrated must be in a domain associated with an active-data pool. If the nodes are not in a domain associated with an active pool, the data cannot be written to the pool.

#### All

Specifies that data is written simultaneously to copy storage pools and active-data pools during client store sessions, server import processes, or server data-migration processes. Specifying this value ensures that data is written simultaneously whenever this pool is a target for any of the eligible operations.



## COPYSTGPools

Specifies the names of copy storage pools where the server simultaneously writes data. The COPYSTGPOLLS parameter is optional. You can specify a maximum of three copy pool names that are separated by commas. Spaces between the names of the copy pools are not allowed. When you specify a value for the COPYSTGPOLLS parameter, you can also specify a value for the COPYCONTINUE parameter.

The combined total number of storage pools that are specified in the COPYSTGPOLLS and ACTIVEPOOLLS parameters cannot exceed three.

When a data storage operation switches from a primary storage pool to a next storage pool, the next storage pool inherits the list of copy storage pools and the COPYCONTINUE value from the primary storage pool. The primary storage pool is specified by the copy group of the management class that is bound to the data.

The server can write data simultaneously to copy storage pools during the following operations:

- Back up and archive operations by IBM Spectrum Protect backup-archive clients or application clients that are using the IBM Spectrum Protect API
- Migration operations by IBM Spectrum Protect for Space Management clients
- Import operations that involve copying exported file data from external media to a primary storage pool associated with a copy storage pool list

Restriction: The simultaneous-write function is not supported for the following store operations:

- When the operation is using LAN-free data movement. Simultaneous-write operations take precedence over LAN-free data movement, causing the operations to go over the LAN. However, the simultaneous-write configuration is followed.
- NAS backup operations. If the primary storage pool specified in the DESTINATION or TOCDESTINATION in the copy group of the management class has copy storage pools that are defined:
  - The copy storage pools are ignored
  - The data is stored into the primary storage pool only

Attention: The function that is provided by the COPYSTGPOLLS parameter is not intended to replace the BACKUP STGPOLLS command. If you use the COPYSTGPOLLS parameter, continue to use the BACKUP STGPOLLS command to ensure that the copy storage pools are complete copies of the primary storage pool. There are cases when a copy might not be created. For more information, see the COPYCONTINUE parameter description.

## COPYContinue

Specifies how the server usually reacts to a copy storage pool write failure for any of the copy storage pools that are listed in the COPYSTGPOLLS parameter. This parameter is optional. The default value is YES. When you specify the COPYCONTINUE parameter, you must also specify the COPYSTGPOLLS parameter.

You can specify the following values:

### Yes

If the COPYCONTINUE parameter is set to YES, the server will stop writing to the failing copy pools for the remainder of the session, but continue storing files into the primary pool and any remaining copy pools. The copy storage pool list is active only for the life of the client session and applies to all the primary storage pools in a particular storage pool hierarchy.

### No

If the COPYCONTINUE parameter is set to NO, the server will fail the current transaction and discontinue the store operation.

Restrictions:

- The setting of the COPYCONTINUE parameter does not affect active-data pools. If a write failure occurs for any of the active-data pools, the server stops writing to the failing active-data pool for the remainder of the session, but continues storing files into the primary pool and any remaining active-data pools and copy storage pools. The active-data pool list is active only for the life of the session and applies to all the primary storage pools in a particular storage pool hierarchy.
- The setting of the COPYCONTINUE parameter does not affect the simultaneous-write function during server import. If data is being written simultaneously and a write failure occurs to the primary storage pool or any copy storage pool, the server import process fails.
- The setting of the COPYCONTINUE parameter does not affect the simultaneous-write function during server data migration. If data is being written simultaneously and a write failure occurs to any copy storage pool or active-data pool, the failing storage pool is removed and the data migration process continues. Write failures to the primary storage pool cause the migration process to fail.

## ACTIVEDATAPOOLS

Specifies the names of active-data pools where the server simultaneously writes data during a client backup operation. The `ACTIVEDATAPOOLS` parameter is optional. Spaces between the names of the active-data pools are not allowed.

The combined total number of storage pools that are specified in the `COPYSTGPOLS` and `ACTIVEDATAPOOLS` parameters cannot exceed three.

When a data storage operation switches from a primary storage pool to a next storage pool, the next storage pool inherits the list of active-data pools from the destination storage pool that is specified in the copy group. The primary storage pool is specified by the copy group of the management class that is bound to the data.

The server can write data simultaneously to active-data pools only during backup operations by IBM Spectrum Protect backup-archive clients or application clients that use the IBM Spectrum Protect API.

Restrictions:

1. This parameter is available only to primary storage pools that use "NATIVE" or "NONBLOCK" data format. This parameter is not available for storage pools that use the following data formats:
  - o NETAPPDUMP
  - o CELERRADUMP
  - o NDMPDUMP
2. Writing data simultaneously to active-data pools is not supported when you use LAN-free data movement. Simultaneous-write operations take precedence over LAN-free data movement, causing the operations to go over the LAN. However, the simultaneous-write configuration is followed.
3. The simultaneous-write function is not supported when a NAS backup operation is writing a TOC file. If the primary storage pool specified in the `TOCDESTINATION` in the copy group of the management class has active-data pools that are defined:
  - o The active-data pools are ignored
  - o The data is stored into the primary storage pool only
4. You cannot use the simultaneous-write function with CENTERA storage devices.
5. Data that is being imported is not stored in active-data pools. After an import operation, use the `COPY ACTIVEDATA` command to store the imported data in an active-data pool.

Attention: The function that is provided by the `ACTIVEDATAPOOLS` parameter is not intended to replace the `COPY ACTIVEDATA` command. If you use the `ACTIVEDATAPOOLS` parameter, use the `COPY ACTIVEDATA` command to ensure that the active-data pools contain all active data of the primary storage pool.

## SHRED

Specifies whether data is physically overwritten when it is deleted. This parameter is optional. You can specify an integer 0 - 10. The default value is 0.

If you specify a value of zero, the server deletes the data from the database. However, the storage that is used to contain the data is not overwritten, and the data exists in storage until that storage is reused for other data. It might be possible to discover and reconstruct the data after it is deleted.

If you specify a value greater than zero, the server deletes the data both logically and physically. The server overwrites the storage that is used to contain the data the specified number of times. This overwriting increases the difficulty of discovering and reconstructing the data after it is deleted.

To ensure that all copies of the data are shredded, specify a `SHRED` value greater than zero for the storage pool that is specified in the `NEXTSTGPOL` parameter. Do not specify either the `COPYSTGPOLS` or `ACTIVEDATAPOOLS`. Specifying relatively high values for the overwrite count generally improves the level of security, but might affect performance adversely.

Overwriting of deleted data is done asynchronously after the delete operation is complete. Therefore, the space that is occupied by the deleted data remains occupied for some time. The space is not available as free space for new data.

A `SHRED` value greater than zero cannot be used if the value of the `CACHE` parameter is `YES`.

Important: After an export operation finishes and identifies files for export, any change to the storage pool `SHRED` value is ignored. An export operation that is suspended retains the original `SHRED` value throughout the operation. You might want to consider canceling your export operation if changes to the storage pool `SHRED` value jeopardize the operation. You can reissue the export command after any needed cleanup.

## Example: Define a primary storage pool for a DISK device class

---

Define a primary storage pool, POOL1, to use the DISK device class, with caching enabled. Limit the maximum file size to 5 MB. Store any files larger than 5 MB in subordinate storage pools that begin with the PROG2 storage pool. Set the high migration threshold to 70 percent, and the low migration threshold to 30 percent.

```
define stgpool pool1 disk
description="main disk storage pool" maxsize=5m
highmig=70 lowmig=30 cache=yes
nextstgpool=prog2
```

## DEFINE STGPOOL (Define a primary storage pool assigned to sequential access devices)

Use this command to define a primary storage pool that is assigned to sequential access devices.

### Privilege class

To issue this command, you must have system privilege.

### Syntax

```
>>-DEFine STGpool--pool_name--device_class_name----->
. -Pooltype---PRimary-. . -STGType---Devclass-.
>+-----+-----+-----+----->
' -Pooltype---PRimary-' ' -STGType---Devclass-'

>+-----+-----+-----+----->
' -DESCRiption---description-'

. -ACCess---READWrite-----
>+-----+-----+-----+----->
' -ACCess---+READWrite---+
      +-READOnly---+
      ' -UNAVailable-'

. -MAXSize---NOLimit-----
>+-----+-----+-----+----->
|                                     (1) (2) |
' -MAXSize---maximum_file_size-----'

. -CRCData---No-----
>+-----+-----+-----+----->
' -CRCData---+Yes---+
      |   (1) |
      ' -No-----'

>+-----+-----+-----+----->
|                                     (1) (2) |
' -NEXTstgpool---pool_name-----'

. -HIghmig---90-----
>+-----+-----+-----+----->
|                                     (1) (2) |
' -HIghmig---percent-----'

. -LOWmig---70-----
>+-----+-----+-----+----->
|                                     (1) (2) |
' -LOWmig---percent-----'

. -REClaim---60-----
>+-----+-----+-----+----->
|                                     (1) (2) |
' -REClaim---percent-----'

. -RECLAIMProcess---1-----
>+-----+-----+-----+----->
|                                     (1) (2) |
```



```

|          V          | |
'-ACTIVEDATApools-----active-data_pool_name-+-'
. -DEDuplicate-----No----->
>-----+-----+-----+-----+-----+----->
'-DEDuplicate-----+No-----+'
|          (5) |
'-Yes-----'

. -IDENTIFYPRocess-----1----->
>-----+-----+-----+-----+-----+-----><
|          (6) |
'-IDENTIFYPRocess-----number-----'

```

#### Notes:

1. This parameter is not available for storage pools that use the data formats NETAPPDUMP, CELERRADUMP, or NDMPDUMP.
2. This parameter is not available or is ignored for CENTERA storage pools.
3. The RECLAMATIONTYPE=SNAPLOCK setting is valid only for storage pools that are defined to servers that are enabled for IBM Spectrum Protect™ for Data Retention. The storage pool must be assigned to a FILE device class, and the directories that are specified in the device class must be NetApp SnapLock volumes.
4. The values NETAPPDUMP, CELERRADUMP, and NDMPDUMP are not valid for storage pools that are defined with a FILE-type device class.
5. This parameter is valid only for storage pools that are defined with a FILE-type device class.
6. This parameter is available only when the value of the DEDUPLICATE parameter is YES.

## Parameters

---

#### pool\_name (Required)

Specifies the name of the storage pool to be defined. The name must be unique, and the maximum length is 30 characters.

#### device\_class\_name (Required)

Specifies the name of the device class to which this storage pool is assigned. You can specify any device class except for the DISK device class.

#### POoltype=PRimary

Specifies that you want to define a primary storage pool. This parameter is optional. The default value is PRIMARY.

#### STGType

Specifies the type of storage that you want to define for a storage pool. This parameter is optional. The default value is DEVCLASS.

#### Devclass

Specifies that a device class type of storage pool is assigned to the storage pool.

#### DEScRiption

Specifies a description of the storage pool. This parameter is optional. The maximum length of the description is 255 characters. Enclose the description in quotation marks if it contains any blank characters.

#### ACCess

Specifies how client nodes and server processes (such as migration and reclamation) can access files in the storage pool. This parameter is optional. The default value is READWRITE. You can specify the following values:

#### READWrite

Specifies that client nodes and server processes can read and write to files stored on volumes in the storage pool.

#### READOnly

Specifies that client nodes can only read files from the volumes in the storage pool.

Server processes can move files within the volumes in the storage pool. However, no new writes are permitted to volumes in the storage pool from volumes outside the storage pool.

If this storage pool was specified as a subordinate storage pool (with the NEXTSTGPOOL parameter) and is defined as *readonly*, the storage pool is skipped when server processes attempt to write files to the storage pool.

#### UNAVailable

Specifies that client nodes cannot access files stored on volumes in the storage pool.

Server processes can move files within the volumes in the storage pool and can also move or copy files from this storage pool to another storage pool. However, no new writes are permitted to volumes in the storage pool from

volumes outside the storage pool.

If this storage pool was specified as a subordinate storage pool (with the NEXTSTGPOOL parameter) and is defined as *unavailable*, the storage pool is skipped when server processes attempt to write files to the storage pool.

#### MAXSize

Specifies the maximum size for a physical file that the server can store in the storage pool. This parameter is optional. The default value is NOLIMIT. You can specify one of the following values:

##### NOLimit

Specifies that there is no maximum size limit for physical files stored in the storage pool.

##### maximum\_file\_size

Limits the maximum physical file size. Specify an integer from 1 to 999999 terabytes, followed by a scale factor. For example, MAXSIZE=5G specifies that the maximum file size for this storage pool is 5 gigabytes. Scale factors are:

Scale factor	Meaning
K	kilobyte
M	megabyte
G	gigabyte
T	terabyte

The client estimates the size of files that are sent to the server. The client estimate is used rather than the actual amount of data that is sent to the server. Client options, such as deduplication, compression, and encryption, can cause the actual amount of data that is sent to the server to be larger or smaller than the size estimate. For example, the compression of a file might be smaller in size than the estimate, thus sending less data than the estimate. Furthermore, a binary file might be larger in size after the compression processing, thus sending more data than the estimate.

When the physical size of the storage pool exceeds the MAXSIZE parameter, the following table shows where files are typically stored.

Table 1. The location of a file according to the file size and the pool that is specified

File size	Pool specified	Result
Exceeds the maximum size	No pool is specified as the next storage pool in the hierarchy	The server does not store the file
	A pool is specified as the next storage pool in the hierarchy	The server stores the file in the next storage pool that can accept the file size

Tip: If you also specify the NEXTstgpool parameter, define one storage pool in your hierarchy to have no limit on the maximum file size by specifying the MAXSize=NOLimit parameter. When you have at least one pool with no size limit, you ensure that no matter what its size, the server can store the file.

For multiple files that are sent in a single transaction, the server considers the size of the transaction to be the file size. If the total size of all files in the transaction is larger than the maximum size limit, the server does not store the files in the storage pool.

Restriction:

This parameter is not available for storage pools that use the following data formats:

- NETAPPDUMP
- CELERRADUMP
- NDMPDUMP

#### CRCDATA

Specifies whether a cyclic redundancy check (CRC) validates storage pool data when audit volume processing occurs on the server. This parameter is only valid for NATIVE data format storage pools. This parameter is optional. The default value is NO. By setting CRCDATA to YES and scheduling an AUDIT VOLUME command, you can continually ensure the integrity of data that is stored in your storage hierarchy. You can specify the following values:

##### Yes

Specifies that data is stored containing CRC information, allowing for audit volume processing to validate storage pool data. This mode impacts performance because more processing is required to calculate and compare CRC values between the storage pool and the server.

No

Specifies that data is stored without CRC information.

Restriction: This parameter is not available for storage pools that use the following data formats:

- NETAPPDUMP
- CELERRADUMP
- NDMPDUMP

Tip:

For storage pools that are associated with the 3592, LTO, or ECARTRIDGE device type, logical block protection provides better protection against data corruption than CRC validation for a storage pool. If you specify CRC validation for a storage pool, data is validated only during volume auditing operations. Errors are identified after data is written to tape.

To enable logical block protection, specify a value of READWRITE for the LBPROTECT parameter on the DEFINE DEVCLASS and UPDATE DEVCLASS commands for the 3592, LTO, or ECARTRIDGE device types. Logical block protection is supported only on the following types of drives and media:

- IBM® LTO5 and later.
- IBM 3592 Generation 3 drives and later with 3592 Generation 2 media and later.
- Oracle StorageTek T10000C and T10000D drives.

### NEXTstgpool

Specifies a primary storage pool to which files are migrated. You cannot migrate data from a sequential access storage pool to a random access storage pool. This parameter is optional.

If this storage pool does not have a next storage pool, the server cannot migrate files from this storage pool and cannot store files that exceed the maximum size for this storage pool in another storage pool.

When there is insufficient space available in the current storage pool, the NEXTSTGPOOL parameter for sequential access storage pools does not allow data to be stored into the next pool. In this case, the server issues a message and the transaction fails.

For next storage pools with a device type of FILE, the server completes a preliminary check to determine whether sufficient space is available. If space is not available, the server skips to the next storage pool in the hierarchy. If space is available, the server attempts to store data in that pool. However, it is possible that the storage operation might fail because, at the time the actual storage operation is attempted, the space is no longer available.

Restrictions:

- To ensure that you do not create a chain of storage pools that leads to an endless loop, specify at least one storage pool in the hierarchy with no value.
- If you specify a sequential-access pool as the next storage pool, the pool must be in either NATIVE or NONBLOCK data format.
- Do not specify a directory-container or cloud-container storage pool.
- Do not use this parameter to specify a storage pool for data migration.
- This parameter is not available for storage pools that use the following data formats:
  - NETAPPDUMP
  - CELERRADUMP
  - NDMPDUMP

### HIghmig

Specifies that the server starts migration when storage pool utilization reaches this percentage. For sequential-access disk (FILE) storage pools, utilization is the ratio of data in a storage pool to the pool's total estimated data capacity, including the capacity of all scratch volumes specified for the pool. For storage pools that use tape media, utilization is the ratio of volumes that contain data to the total number of volumes in the storage pool. The total number of volumes includes the maximum number of scratch volumes. This parameter is optional. You can specify an integer 0 - 100. The default value is 90.

When the storage pool exceeds the high migration threshold, the server can start migration of files by volume to the next storage pool defined for the pool. You can set the high migration threshold to 100 to prevent migration for the storage pool.

Restriction: This parameter is not available for storage pools that use the following data formats:

- NETAPPDUMP

- CELERRADUMP
- NDMPDUMP

#### LOWmig

Specifies that the server stops migration when storage pool utilization is at or below this percentage. For sequential-access disk (FILE) storage pools, utilization is the ratio of data in a storage pool to the pool's total estimated data capacity, including the capacity of all scratch volumes specified for the pool. For storage pools that use tape media, utilization is the ratio of volumes that contain data to the total number of volumes in the storage pool. The total number of volumes includes the maximum number of scratch volumes. This parameter is optional. You can specify an integer 0 - 99. The default value is 70.

When the storage pool reaches the low migration threshold, the server does not start migration of files from another volume. You can set the low migration threshold to 0 to allow migration to empty the storage pool.

Restriction: This parameter is not available for storage pools that use the following data formats:

- NETAPPDUMP
- CELERRADUMP
- NDMPDUMP

#### REClaim

Specifies when the server reclaims a volume, which is based on the percentage of reclaimable space on a volume. Reclaimable space is the amount of space that is occupied by files that are expired or deleted from the database.

Reclamation makes the fragmented space on volumes usable again by moving any remaining unexpired files from one volume to another volume, thus making the original volume available for reuse. This parameter is optional. You can specify an integer 1 - 100. The default value is 60, except for storage pools that use WORM devices.

**AIX** | **Windows** For storage pools that use a WORM device class, you can lower the value from the default of 100. Lowering the value allows the server to consolidate data onto fewer volumes when needed. Volumes that are emptied by reclamation can be checked out of the library, freeing slots for new volumes. Because the volumes are write-once, the volumes cannot be reused.

The server determines that the volume is a candidate for reclamation if the percentage of reclaimable space on a volume is greater than the reclamation threshold of the storage pool.

Specify a value of 50 percent or greater for this parameter so that files stored on two volumes can be combined onto a single output volume.

Restriction: This parameter is not available for storage pools that use the following data formats:

- NETAPPDUMP
- CELERRADUMP
- NDMPDUMP

#### RECLAIMProcess

Specifies the number of parallel processes to use for reclaiming the volumes in this storage pool. This parameter is optional. Enter a value 1 - 999. The default value is 1. You can specify one or more reclamation processes for each primary sequential-access storage pool.

When you calculate the value for this parameter, consider the following resources that are required for reclamation processing:

- The number of sequential storage pools.
- The number of logical and physical drives that can be dedicated to the operation.

To access sequential volumes, IBM Spectrum Protect uses a mount point and, if the device type is not FILE, a physical drive.

For example, suppose that you want to reclaim the volumes from two sequential storage pools simultaneously and that you want to specify four processes for each of the storage pools. The storage pools have the same device class. Assuming that the RECLAIMSTGPOOL parameter is not specified or that the reclaim storage pool has the same device class as the storage pool that is being reclaimed, each process requires two mount points and, if the device type is not FILE, two drives. (One of the drives is for the input volume, and the other drive is for the output volume.) To run eight reclamation processes simultaneously, you need a total of at least 16 mount points and 16 drives. The device class for the storage pools must have a mount limit of at least 16.



Restriction: This parameter is not available for storage pools that use the following data formats:

- NETAPPDUMP
- CELERRADUMP
- NDMPDUMP

#### RECLAIMSTGpool

Specifies another primary storage pool as a target for reclaimed data from this storage pool. This parameter is optional. When the server reclaims volumes for the storage pool, the server moves unexpired data from the volumes that are being reclaimed to the storage pool named with this parameter.

A reclaim storage pool is most useful for a storage pool that has only one drive in its library. When you specify this parameter, the server moves all data from reclaimed volumes to the reclaim storage pool regardless of the number of drives in the library.

To move data from the reclaim storage pool back to the original storage pool, use the storage pool hierarchy. Specify the original storage pool as the next storage pool for the reclaim storage pool.

Restriction:

- This parameter is not available for storage pools that use the following data formats:
- NETAPPDUMP
- CELERRADUMP
- NDMPDUMP

#### RECLAMATIONType

Specifies the method by which volumes are reclaimed and managed. This parameter is optional. The default value is THRESHOLD. The following are possible values:

##### THRESHold

Specifies that volumes that belong to this storage pool are reclaimed based on the threshold value in the RECLAIM attribute for this storage pool.

##### SNAPlock

Specifies that FILE volumes that belong to this storage pool are managed for retention using NetApp Data ONTAP software and NetApp SnapLock volumes. This parameter is only valid for storage pools that are defined to a server that has data retention protection enabled and that is assigned to a FILE device class. Volumes in this storage pool are not reclaimed based on threshold; the RECLAIM value for the storage pool is ignored.

All volumes in this storage pool are created as FILE volumes. A retention date, which is derived from the retention attributes in the archive copy group for the storage pool, is set in the metadata for the FILE volume by using the SnapLock feature of the NetApp Data ONTAP operating system. Until the retention date expires, the FILE volume and any data on it cannot be deleted from the physical SnapLock volume on which it is stored.

The RECLAMATIONTYPE parameter for all storage pools that are being defined must be the same when defined to the same device class name. The DEFINE command can fail if the RECLAMATIONTYPE parameter specified is different from what is defined for storage pools that are already defined to the device class name.

Restriction: This parameter is not available for storage pools that use the following data formats:

- NETAPPDUMP
- CELERRADUMP
- NDMPDUMP

#### COLlocate

Specifies whether the server attempts to keep data, which is stored on as few volumes as possible, that belong to one of the following candidates:

- A single client node
- A group of file spaces
- A group of client nodes
- A client file space

This parameter is optional. The default value is GROUP.

Collocation reduces the number of sequential access media mounts for restore, retrieve, and recall operations. However, collocation increases both the amount of server time that is needed to collocate files for storing and the number of volumes

required. Collocation can also impact the number of processes migrating disks to sequential pool.

You can specify one of the following options:

No

Specifies that collocation is disabled. During migration from disk, processes are created at a file space level.

GRoup

Specifies that collocation is enabled at the group level for client nodes or file spaces. For collocation groups, the server attempts to put data for nodes or file spaces that belong to the same collocation group on as few volumes as possible.

If you specify COLLOCATE=GROUP but do not define any collocation groups, or if you do not add nodes or file spaces to a collocation group, data is collocated by node. Consider tape usage when you organize client nodes or file spaces into collocation groups.

For example, if a tape-based storage pool consists of data from nodes and you specify COLLOCATE=GROUP, the server completes the following actions:

- Collocates the data by group for grouped nodes. Whenever possible, the server collocates data that belongs to a group of nodes on a single tape or on as few tapes as possible. Data for a single node can also be spread across several tapes that are associated with a group.
- Collocates the data by node for ungrouped nodes. Whenever possible, the server stores the data for a single node on a single tape. All available tapes that already have data for the node are used before available space on any other tape is used.
- During migration from disk, the server creates migration processes at the collocation group level for grouped nodes, and at the node level for ungrouped nodes.

If a tape-based storage pool consists of data from grouped file spaces and you specify COLLOCATE=GROUP, the server completes the following actions:

- Collocates by group, the data for grouped file spaces only. Whenever possible, the server collocates data that belongs to a group of file spaces on a single tape or on as few tapes as possible. Data for a single file space can also be spread across several tapes that are associated with a group.
- Collocates the data by node (for file spaces that are not explicitly defined to a file space collocation group). For example, node1 has file spaces that are named A, B, C, D, and E. File spaces A and B belong to a file space collocation group but C, D, and E do not. File spaces A and B are collocated by file space collocation group, while C, D, and E are collocated by node.
- During migration from disk, the server creates migration processes at the collocation group level for grouped file spaces.

Data is collocated on the least number of sequential access volumes.

NODe

Specifies that collocation is enabled at the client node level. For collocation groups, the server attempts to put data for one node on as few volumes as possible. If the node has multiple file spaces, the server does not try to collocate those file spaces. For compatibility with an earlier version, COLLOCATE=YES is still accepted by the server to specify collocation at the client node level.

If a storage pool contains data for a node that is a member of a collocation group and you specify COLLOCATE=NODE, the data is collocated by node.

For COLLOCATE=NODE, the server creates processes at the node level when you migrate data from disk.

FIlespace

Specifies that collocation is enabled at the file space level for client nodes. The server attempts to place data for one node and file space on as few volumes as possible. If a node has multiple file spaces, the server attempts to place data for different file spaces on different volumes.

For COLLOCATE=FILESPACE, the server creates processes at the file space level when you migrate data from disk.

MAXSCRatch (Required)

Specifies the maximum number of scratch volumes that the server can request for this storage pool. You can specify an integer 0 - 100000000. By allowing the server to request scratch volumes, you avoid having to define each volume to be used.

The value that is specified for this parameter is used to estimate the total number of volumes available in the storage pool and the corresponding estimated capacity for the storage pool.

Scratch volumes are automatically deleted from the storage pool when they become empty. When scratch volumes with the device type of FILE are deleted, the space that the volumes occupied is freed by the server and returned to the file system.

Tip: For server-to-server operations that use virtual volumes and that store a small amount of data, consider specifying a value for the MAXSCRATCH parameter that is higher than the value you typically specify for write operations to other types of volumes. After a write operation to a virtual volume, IBM Spectrum Protect marks the volume as FULL, even if the value of the MAXCAPACITY parameter on the device-class definition is not reached. The server does not keep virtual volumes in FILLING status and does not append to them. If the value of the MAXSCRATCH parameter is too low, server-to-server operations can fail.

#### REUsedelay

Specifies the number of days that must elapse after all files are deleted from a volume before the volume can be rewritten or returned to the scratch pool. This parameter is optional. You can specify an integer 0 - 9999. The default value is 0, which means that a volume can be rewritten or returned to the scratch pool as soon as all the files are deleted from the volume.

Tip: Use this parameter to ensure that when you restore the database to an earlier level, database references to files in the storage pool are still valid. You must set this parameter to a value greater than the number of days you plan to retain the oldest database backup. The number of days that are specified for this parameter must be the same as the number specified for the SET DRMDBBACKUPEXPIREDAYS command.

#### OVFLocation

Specifies the overflow location for the storage pool. The server assigns this location name to a volume that is ejected from the library by the command. This parameter is optional. The location name can be a maximum length of 255 characters. Enclose the location name in quotation marks if the location name contains any blank characters.

Restriction: This parameter is not available for storage pools that use the following data formats:

- NETAPPDUMP
- CELERRADUMP
- NDMPDUMP

#### MIGDelay

Specifies the minimum number of days a file must remain in a storage pool before it becomes eligible for migration. All files on a volume must be eligible for migration before the server selects the volume for migration. To calculate a value to compare to the specified MIGDELAY, the server counts the number of days that the file has been in the storage pool.

This parameter is optional. You can specify an integer 0 - 9999. The default is 0, which means that you do not want to delay migration. If you want the server to count the number of days that are based only on when a file was stored and not when it was retrieved, use the NORETRIEVEDATE server option.

Restriction: This parameter is not available for storage pools that use the following data formats:

- NETAPPDUMP
- CELERRADUMP
- NDMPDUMP

#### MIGContinue

Specifies whether you allow the server to migrate files that do not satisfy the migration delay time. This parameter is optional. The default is YES.

Because you can require that files remain in the storage pool for a minimum number of days, the server may migrate all eligible files to the next storage pool yet not meet the low migration threshold. This parameter allows you to specify whether the server is allowed to continue the migration process by migrating files that do not satisfy the migration delay time.

You can specify one of the following values:

#### Yes

Specifies that, when necessary to meet the low migration threshold, the server continues to migrate files that do not satisfy the migration delay time.

If you allow more than one migration process for the storage pool, some files that do not satisfy the migration delay time may be migrated unnecessarily. As one process migrates files that satisfy the migration delay time, a second process could begin migrating files that do not satisfy the migration delay time to meet the low migration threshold.

The first process that is still migrating files that satisfy the migration delay time might have, by itself, caused the low migration threshold to be met.

No

Specifies that the server stops migration when no eligible files remain to be migrated, even before reaching the low migration threshold. The server does not migrate files unless the files satisfy the migration delay time.

#### MIGPProcess

Specifies the number of parallel processes to use for migrating the files from the volumes in this storage pool. This parameter is optional. Enter a value 1 - 999. The default value is 1.

When calculating the value for this parameter, consider the number of sequential storage pools that will be involved with the migration, and the number of logical and physical drives that can be dedicated to the operation. To access a sequential-access volume, IBM Spectrum Protect uses a mount point and, if the device type is not FILE, a physical drive. The number of available mount points and drives depends on other IBM Spectrum Protect and system activity and on the mount limits of the device classes for the sequential access storage pools that are involved in the migration.

For example, suppose you want to simultaneously migrate the files from volumes in two primary sequential storage pools and that you want to specify three processes for each of the storage pools. The storage pools have the same device class. Assuming that the storage pool to which files are being migrated has the same device class as the storage pool from which files are being migrated, each process requires two mount points and, if the device type is not FILE, two drives. (One drive is for the input volume, and the other drive is for the output volume.) To run six migration processes simultaneously, you need a total of at least 12 mount points and 12 drives. The device class for the storage pools must have a mount limit of at least 12.

If the number of migration processes you specify is more than the number of available mount points or drives, the processes that do not obtain mount points or drives will wait for mount points or drives to become available. If mount points or drives do not become available within the MOUNTWAIT time, the migration processes will end. For information about specifying the MOUNTWAIT time, see DEFINE DEVCLASS (Define a device class).

The IBM Spectrum Protect server will start the specified number of migration processes regardless of the number of volumes that are eligible for migration. For example, if you specify ten migration processes and only six volumes are eligible for migration, the server will start ten processes and four of them will complete without processing a volume.

Tip: When you specify this parameter, consider whether the simultaneous-write function is enabled for server data migration. Each migration process requires a mount point and a drive for each copy storage pool and active-data pool that is defined to the target storage pool.

Restriction: This parameter is not available for storage pools that use the following data formats:

- NETAPPDUMP
- CELERRADUMP
- NDMPDUMP

#### DATAFormat

Specifies the data format to use to back up files to this storage pool and restore files from this storage pool. The default format is the NATIVE server format. You can specify the following values:

##### NATive

Specifies the data format is the native IBM Spectrum Protect server format and includes block headers.

##### NONblock

Specifies the data format is the native IBM Spectrum Protect server format and does not include block headers. The default minimum block size on a volume that is associated with a FILE device class is 256 KB, regardless how much data is written to the volume. For certain tasks, you can minimize wasted space on storage volumes by specifying the NONBLOCK data format. For example, you can specify the NONBLOCK data format for the following tasks:

- Using content-management products
- Using the DIRMC client option to store directory information
- Migrating very small files by using IBM Spectrum Protect for Space Management or IBM Spectrum Protect HSM for Windows

In most situations, however, the NATIVE format is preferred.

##### NETAPPDump

Specifies the data is in a NetApp dump format. This data format must be specified for file system images that are in a dump format and that were backed up from a NetApp or an IBM System Storage® N Series file server that uses

NDMP. The server does not complete migration, reclamation, or AUDIT VOLUME for a storage pool with DATAFORMAT=NETAPPDUMP. You can use the MOVE DATA command to move data from one primary storage pool to another, or out of a volume if the volume must be reused.

#### CELERRADump

Specifies that the data is in an EMC Celerra dump format. This data format must be specified for file system images that are in a dump format and that were backed up from an EMC Celerra file server that uses NDMP. The server does not complete migration, reclamation, or AUDIT VOLUME for a storage pool with DATAFORMAT=CELERRADUMP. You can use the MOVE DATA command to move data from one primary storage pool to another, or out of a volume if the volume must be reused.

#### NDMPDump

Specifies that the data is in NAS vendor-specific backup format. Use this data format for file system images that were backed up from a NAS file server other than a NetApp or EMC Celerra file server. The server does not complete migration, reclamation, or AUDIT VOLUME for a storage pool with DATAFORMAT=NDMPDUMP. You can use the MOVE DATA command to move data from one primary storage pool to another, or out of a volume if the volume must be reused.

#### AUTOCopy

Specifies when IBM Spectrum Protect completes simultaneous-write operations. The default value is CLIENT. This parameter is optional and affects the following operations:

- Client store sessions
- Server import processes
- Server data-migration processes

If the AUTOCOPY option is set to ALL or CLIENT, and there is at least one storage pool that is listed in the COPYSTGPOOLS or ACTIVEDATAPOOLS options, any client-side deduplication is disabled.

If an error occurs while data is being simultaneously written to a copy storage pool or active-data pool during a migration process, the server stops writing to the failing storage pools for the remainder of the process. However, the server continues to store files into the primary storage pool and any remaining copy storage pools or active-data pools. These pools remain active for the duration of the migration process. Copy storage pools are specified using the COPYSTGPOOLS parameter. Active-data pools are specified using the ACTIVEDATAPOOLS parameter.

You can specify one of the following values:

#### None

Specifies that the simultaneous-write function is disabled.

#### CLient

Specifies that data is written simultaneously to copy storage pools and active-data pools during client store sessions or server import processes. During server import processes, data is written simultaneously to only copy storage pools. Data is not written to active-data pools during server import processes.

#### MIGRation

Specifies that data is written simultaneously to copy storage pools and active-data pools only during migration to this storage pool. During server data-migration processes, data is written simultaneously to copy storage pools and active-data pools only if the data does not exist in those pools. Nodes whose data is being migrated must be in a domain associated with an active-data pool. If the nodes are not in a domain associated with an active pool, the data cannot be written to the pool.

#### All

Specifies that data is written simultaneously to copy storage pools and active-data pools during client store sessions, server import processes, or server data-migration processes. Specifying this value ensures that data is written simultaneously whenever this pool is a target for any of the eligible operations.

#### COPYSTGpools

Specifies the names of copy storage pools where the server simultaneously writes data. The COPYSTGPOOLS parameter is optional. You can specify a maximum of three copy pool names that are separated by commas. Spaces between the names of the copy pools are not allowed. When you specify a value for the COPYSTGPOOLS parameter, you can also specify a value for the COPYCONTINUE parameter.

The combined total number of storage pools that are specified in the COPYSTGPOOLS and ACTIVEDATAPOOLS parameters cannot exceed three.

When a data storage operation switches from a primary storage pool to a next storage pool, the next storage pool inherits the list of copy storage pools and the COPYCONTINUE value from the primary storage pool. The primary storage pool is specified by the copy group of the management class that is bound to the data.

The server can write data simultaneously to copy storage pools during the following operations:

- Back up and archive operations by IBM Spectrum Protect backup-archive clients or application clients that use the IBM Spectrum Protect API
- Migration operations by IBM Spectrum Protect for Space Management clients
- Import operations that involve copying exported file data from external media to a storage pool defined with a copy storage pool list

Restrictions:

1. This parameter is available only to primary storage pools that use NATIVE or NONBLOCK data format. This parameter is not available for storage pools that use the following data formats:
  - NETAPPDUMP
  - CELERRADUMP
  - NDMPDUMP
2. Writing data simultaneously to copy storage pools is not supported when LAN-free data movement is used. Simultaneous-write operations take precedence over LAN-free data movement, causing the operations to go over the LAN. However, the simultaneous-write configuration is accepted.
3. The simultaneous-write function is not supported for NAS backup operations. If the primary storage pool specified in the DESTINATION or TOCDESTINATION in the copy group of the management class has copy storage pools defined, the copy storage pools are ignored and the data is stored into the primary storage pool only.
4. You cannot use the simultaneous-write function with CENTERA storage devices.

Attention: The function that is provided by the COPYSTGPOOLS parameter is not intended to replace the BACKUP STGPOOL command. If you use the COPYSTGPOOLS parameter, continue to use the BACKUP STGPOOL command to ensure that the copy storage pools are complete copies of the primary storage pool. There are cases when a copy might not be created. For more information, see the COPYCONTINUE parameter description.

#### COPYContinue

Specifies how the server reacts to a copy storage pool write failure for any of the copy storage pools that are listed in the COPYSTGPOOLS parameter. This parameter is optional. The default value is YES. When you specify the COPYCONTINUE parameter, you must also specify the COPYSTGPOOLS parameter.

The COPYCONTINUE parameter has no effect on the simultaneous-write function during migration.

You can specify the following values:

Yes

If the COPYCONTINUE parameter is set to YES, the server will stop writing to the failing copy pools for the remainder of the session, but continue storing files into the primary pool and any remaining copy pools. The copy storage pool list is active only for the life of the client session and applies to all the primary storage pools in a particular storage pool hierarchy.

No

If the COPYCONTINUE parameter is set to NO, the server will fail the current transaction and discontinue the store operation.

Restrictions:

- The setting of the COPYCONTINUE parameter does not affect active-data pools. If a write failure occurs for any of the active-data pools, the server stops writing to the failing active-data pool for the remainder of the session, but continues storing files into the primary pool and any remaining active-data pools and copy storage pools. The active-data pool list is active only for the life of the session and applies to all the primary storage pools in a particular storage pool hierarchy.
- The setting of the COPYCONTINUE parameter does not affect the simultaneous-write function during server import. If data is being written simultaneously and a write failure occurs to the primary storage pool or any copy storage pool, the server import process fails.
- The setting of the COPYCONTINUE parameter does not affect the simultaneous-write function during server data migration. If data is being written simultaneously and a write failure occurs to any copy storage pool or active-data pool, the failing storage pool is removed and the data migration process continues. Write failures to the primary storage pool cause the migration process to fail.

Restriction: This parameter is not available for storage pools that use the following data formats:

- NETAPPDUMP
- CELERRADUMP
- NDMPDUMP

## ACTIVEDATApools

Specifies the names of active-data pools where the server simultaneously writes data during a client backup operation. The `ACTIVEDATAPOOLS` parameter is optional. Spaces between the names of the active-data pools are not allowed.

The combined total number of storage pools that are specified in the `COPYSGTPOOLS` and `ACTIVEDATAPOOLS` parameters cannot exceed three.

When a data storage operation switches from a primary storage pool to a next storage pool, the next storage pool inherits the list of active-data pools from the destination storage pool specified in the copy group. The primary storage pool is specified by the copy group of the management class that is bound to the data.

The server can write data simultaneously to active-data pools only during backup operations by IBM Spectrum Protect backup-archive clients or application clients that use the IBM Spectrum Protect API.

Restrictions:

1. This parameter is available only to primary storage pools that use `NATIVE` or `NONBLOCK` data format. This parameter is not available for storage pools that use the following data formats:
  - o `NETAPPDUMP`
  - o `CELERRADUMP`
  - o `NDMPDUMP`
2. Write data simultaneously to active-data pools is not supported when LAN-free data movement is used. Simultaneous-write operations take precedence over LAN-free data movement, causing the operations to go over the LAN. However, the simultaneous-write configuration is accepted.
3. The simultaneous-write function is not supported when a NAS backup operation is writing a TOC file. If the primary storage pool specified in the `TOCDESTINATION` in the copy group of the management class has active-data pools defined, the active-data pools are ignored, and the data is stored into the primary storage pool only.
4. You cannot use the simultaneous-write function with `CENTERA` storage devices.
5. Data being imported is not stored in active-data pools. After an import operation, use the `COPY ACTIVEDATA` command to store the imported data in an active-data pool.

Attention: The function that is provided by the `ACTIVEDATAPOOLS` parameter is not intended to replace the `COPY ACTIVEDATA` command. If you use the `ACTIVEDATAPOOLS` parameter, use the `COPY ACTIVEDATA` command to ensure that the active-data pools contain all active data of the primary storage pool.

## DEDuplicate

Specifies whether the data that is stored in this storage pool is deduplicated. This parameter is optional and is valid only for storage pools that are defined with a `FILE`-type device class. The default value is `NO`.

## IDENTIFYProcess

Specifies the number of parallel processes to use for server-side data deduplication. This parameter is optional and is valid only for storage pools that are defined with a `FILE` device class. Enter a value 0 - 50. The default value is 1. If the value of the `DEDUPLICATE` parameter is `NO`, the default setting for `IDENTIFYPROCESS` has no effect.

Remember: Data deduplication processes can be either active or idle. Processes that are working on files are active.

Processes that are waiting for files to work on are idle. Processes remain idle until volumes with data to be deduplicated become available. The output of the `QUERY PROCESS` command for data deduplication includes the total number of bytes and files that have been processed since the process first started. For example, if a data deduplication process processes four files, becomes idle, and then processes five more files, then the total number of files processed is nine. Processes end only when canceled or when the number of data-deduplication processes for the storage pool is changed to a value less than the number currently specified.

## Example: Define a primary storage pool with an 8MMTAPE device class

Define a primary storage pool that is named `8MMPool` to the `8MMTAPE` device class (with a device type of `8MM`) with a maximum file size of 5 MB. Store any files larger than 5 MB in subordinate pools, beginning with `POOL1`. Enable collocation of files for client nodes. Allow as many as 5 scratch volumes for this storage pool.

```
define stgpool 8mmpool 8mmtape maxsize=5m
  nextstgpool=pool1 collocate=node
  maxscratch=5
```

### Related reference:

`SET DRMDBBACKUPEXPIREDAYS` (Specify DB backup series expiration)

# DEFINE STGPOOL (Define a copy storage pool assigned to sequential access devices)

Use this command to define a copy storage pool that is assigned to sequential access devices.

## Privilege class

To issue this command, you must have system privilege.

## Syntax

```
>>-DEfIne STGpool--pool_name--device_class_name----->
>--POoltype---Copy--+-----+----->
      '-DEScRiption---description-'
      .-ACCess---READWrite-----
>+-----+----->
      '-ACCess---+READWrite---+'
              +-READOnly---+
              '-UNAVailable-'
      .-COLlocate---No----- .-REClaim---100-----
>+-----+-----+----->
      '-COLlocate---+No-----+' '-REClaim---percent-'
              +-GRoup-----+
              +-NODe-----+
              '-Filespace-'
      .-RECLAIMPRocess---1-----
>+-----+----->
      '-RECLAIMPRocess---number-'
      .-RECLAMATIOnType---THRESHold-----
>+-----+----->
      |                                     (1) |
      '-RECLAMATIOnType---+THRESHold+-----'
              '-SNAPlock--'
      .-OFFSITERECLAIMLimit---NOLimit-.
>+-----+-----+-----MAXSCRatch---number--->
      '-OFFSITERECLAIMLimit---number--'
      .-REUsedelay---0-----
>+-----+-----+----->
      '-REUsedelay---days-' '-OVFLocation---location-'
      .-DATAFormat---NATive-----
>+-----+-----+----->
      |                                     (2) |
      '-DATAFormat---+NATive-----+'
              +-NONblock---+
              +-NETAPPDump--+
              +-CELERRADump-+
              '-NDMPDump----'
      .-CRCDATA---No----- .-DEDUPlicate---No-----
>+-----+-----+----->
      '-CRCDATA---+Yes-+' '-DEDUPlicate---+No-----+'
              '-No--' | (3) |
                      '-Yes-----'
      .-IDENTIFYPRocess---0-----
>+-----+-----+-----><
      |                                     (4) |
      '-IDENTIFYPRocess---number-----'
```

Notes:



1. The RECLAMATIONTYPE=SNAPLOCK setting is valid only for storage pools that are defined to servers that are enabled for IBM Spectrum Protect™ for Data Retention. The storage pool must be assigned to a FILE device class, and the directories that are specified in the device class must be NetApp SnapLock volumes.
2. The values NETAPPDUMP, CELERRADUMP, and NDMPDUMP are not valid for storage pools that are defined with a FILE device class.
3. This parameter is valid only for storage pools that are defined with a FILE device class.
4. This parameter is available only when the value of the DEDUPLICATE parameter is YES.

## Parameters

---

### pool\_name (Required)

Specifies the name of the storage pool to be defined. The name must be unique, and the maximum length is 30 characters.

### device\_class\_name (Required)

Specifies the name of the sequential access device class to which this copy storage pool is assigned. You can specify any device class except DISK.

### POOLtype=COPY (Required)

Specifies that you want to define a copy storage pool.

### DESCRIPTION

Specifies a description of the copy storage pool. This parameter is optional. The maximum length of the description is 255 characters. Enclose the description in quotation marks if it contains any blank characters.

### ACCESS

Specifies how client nodes and server processes (such as reclamation) can access files in the copy storage pool. This parameter is optional. The default value is READWRITE. You can specify the following values:

#### READWRITE

Specifies that files can be read from and written to the volumes in the copy storage pool.

#### READONLY

Specifies that client nodes can read files that are stored only on the volumes in the copy storage pool.

Server processes can move files within the volumes in the storage pool. The server can use files in the copy storage pool to restore files to primary storage pools. However, no new writes are allowed to volumes in the copy storage pool from volumes outside the storage pool. A storage pool cannot be backed up to the copy storage pool.

#### UNAVAILABLE

Specifies that client nodes cannot access files that are stored on volumes in the copy storage pool.

Server processes can move files within the volumes in the storage pool. The server can use files in the copy storage pool to restore files to primary storage pools. However, no new writes are allowed to volumes in the copy storage pool from volumes outside the storage pool. A storage pool cannot be backed up to the copy storage pool.

### COLLOCATE

Specifies whether the server attempts to keep data, which is stored on as few volumes as possible, that belong to one of the following candidates:

- A single client node
- A group of file spaces
- A group of client nodes
- A client file space

This parameter is optional. The default value is NO.

Collocation reduces the number of sequential access media mounts for restore, retrieve, and recall operations. However, collocation increases both the amount of server time that is needed to collocate files for storing and the number of volumes required.

You can specify one of the following options:

#### No

Specifies that collocation is disabled.

#### GROUP

Specifies that collocation is enabled at the group level for client nodes or file spaces. For collocation groups, the server attempts to put data for nodes or file spaces that belong to the same collocation group on as few volumes as possible.

If you specify COLLOCATE=GROUP but do not define any collocation groups, or if you do not add nodes or file spaces to a collocation group, data is collocated by node. Consider tape usage when you organize client nodes or file spaces into collocation groups.

For example, if a tape-based storage pool consists of data from nodes and you specify COLLOCATE=GROUP, the server completes the following actions:

- Collocates the data by group for grouped nodes. Whenever possible, the server collocates data that belongs to a group of nodes on a single tape or on as few tapes as possible. Data for a single node can also be spread across several tapes that are associated with a group.
- Collocates the data by node for ungrouped nodes. Whenever possible, the server stores the data for a single node on a single tape. All available tapes that already have data for the node are used before available space on any other tape is used.

If a tape-based storage pool consists of data from grouped file spaces and you specify COLLOCATE=GROUP, the server completes the following actions:

- Collocates by group, the data for grouped file spaces only. Whenever possible, the server collocates data that belongs to a group of file spaces on a single tape or on as few tapes as possible. Data for a single file space can also be spread across several tapes that are associated with a group.
- Collocates the data by node (for file spaces that are not explicitly defined to a file space collocation group). For example, node1 has file spaces named A, B, C, D, and E. File spaces A and B belong to a file space collocation group but C, D, and E do not. File spaces A and B are collocated by file space collocation group, while C, D, and E are collocated by node.

Data is collocated on the least amount of sequential access volumes.

#### NODE

Specifies that collocation is enabled at the client node level. For collocation groups, the server attempts to put data for one node on as few volumes as possible. If the node has multiple file spaces, the server does not try to collocate those file spaces. For compatibility with an earlier version, COLLOCATE=YES is still accepted by the server to specify collocation at the client node level.

If a storage pool contains data for a node that is a member of a collocation group and you specify COLLOCATE=NODE, the data is collocated by node.

#### FILESPACE

Specifies that collocation is enabled at the file space level for client nodes. The server attempts to place data for one node and file space on as few volumes as possible. If a node has multiple file spaces, the server attempts to place data for different file spaces on different volumes.

#### RECLAIM

Specifies when the server reclaims a volume, which is based on the percentage of reclaimable space on a volume. Reclaimable space is the amount of space that is occupied by files that are expired or deleted from the IBM Spectrum Protect database.

Reclamation makes the fragmented space on volumes usable again by moving any remaining unexpired files from one volume to another volume, thus making the original volume available for reuse. This parameter is optional. You can specify an integer 1 - 100. The default value is 100, which means that reclamation is not completed.

The server determines that the volume is a candidate for reclamation if the percentage of reclaimable space on a volume is greater than the reclamation threshold of the storage pool.

If you change the value from the default, specify a value of 50 percent or greater so that files stored on two volumes can be combined onto a single output volume.

When a copy pool volume that is offsite becomes eligible for reclamation, the reclamation process attempts to obtain the unexpired files on the reclaimable volume from a primary or copy storage pool that is onsite. The process then writes these files to an available volume in the original copy storage pool. Effectively, these files are moved back to the onsite location. However, the files can be obtained from the offsite volume after a disaster if a database backup is used that references the files on the offsite volume. Because of the way reclamation works with offsite volumes, use it carefully with copy storage pools.

#### RECLAIMPROCESS

Specifies the number of parallel processes to use for reclaiming the volumes in this storage pool. This parameter is optional. Enter a value 1 - 999. The default value is 1.

When you calculate the value for this parameter, consider the following resources that are required for reclamation processing:

- The number of sequential storage pools.
- The number of logical and physical drives that can be dedicated to the operation.

To access sequential volumes, IBM Spectrum Protect uses a mount point and, if the device type is not FILE, a physical drive.

For example, suppose that you want to reclaim the volumes from two sequential storage pools simultaneously and that you want to specify four processes for each of the storage pools. The storage pools have the same device class. Each process requires two mount points and, if the device type is not FILE, two drives. (One of the drives is for the input volume, and the other drive is for the output volume.) To run eight reclamation processes simultaneously, you need a total of at least 16 mount points and 16 drives. The device class for the storage pools must have a mount limit of at least 16.

You can specify one or more reclamation processes for each copy storage pool. You can specify multiple concurrent reclamation processes for a single copy storage pool, which makes better use of your available tape drives or FILE volumes. If multiple concurrent processing is not necessary, specify a value of 1 for the RECLAIMPROCESS parameter.

#### RECLAMATIONType

Specifies the method by which volumes are reclaimed and managed. This parameter is optional. The default value is THRESHOLD. The following are possible values:

##### THRESHold

Specifies that volumes that belong to this storage pool are reclaimed based on the threshold value in the RECLAIM attribute for this storage pool.

##### SNAPlock

Specifies that FILE volumes that belong to this storage pool are managed for retention by using NetApp Data ONTAP software and NetApp SnapLock volumes. This parameter is only valid for storage pools that being defined to a server that has data retention protection that is enabled and that is assigned to a FILE device class. Volumes in this storage pool are not reclaimed based on threshold; the RECLAIM value for the storage pool is ignored.

All volumes in this storage pool are created as FILE volumes. A retention date, which is derived from the retention attributes in the archive copy group for the storage pool, is set in the metadata for the FILE volume by using the SnapLock feature of the NetApp Data ONTAP operating system. Until the retention date expires, the FILE volume and any data on it cannot be deleted from the physical SnapLock volume on which it is stored.

The RECLAMATIONTYPE parameter for all storage pools that are being defined must be the same when defined to the same device class name. The DEFINE command fails if the RECLAMATIONTYPE parameter specified is different from what is defined for storage pools that are already defined to the device class name.

#### OFFSITERECLAIMLimit

Specifies the number of offsite volumes that space is reclaimed from during reclamation for this storage pool. This parameter is optional. The default value is NOLIMIT. You can specify the following values:

##### NOLimit

Specifies that you want to reclaim the space in all of your offsite volumes.

##### number

Specifies the number of offsite volumes to reclaim space from. You can specify an integer 0 - 99999. A value of zero means that none of the offsite volumes are reclaimed.

Tip:

To determine the value for the OFFSITERECLAIMLIMIT, use the statistical information in the message that is issued at the end of the offsite volume reclamation operation. The statistical information includes the following items:

- The number of offsite volumes that were processed
- The number of parallel processes that were used
- The total amount of time required for the processing

The order in which offsite volumes are reclaimed is based on the amount of unused space in a volume. (Unused space includes both space that has never been used on the volume and space that has become empty because of file deletion.) Volumes with the largest amount of unused space are reclaimed first.

For example, suppose a copy storage pool contains three volumes: VOL1, VOL2, and VOL3. VOL1 has the largest amount of unused space, and VOL3 has the least amount of unused space. Suppose further that the percentage of unused space in each of the three volumes is greater than the value of the RECLAIM parameter. If you do not specify a value for the OFFSITERECLAIMLIMIT parameter, all three volumes will be reclaimed when the reclamation runs. If you specify a value of 2, only VOL1 and VOL2 will be reclaimed when the reclamation runs. If you specify a value of 1, only VOL1 will be reclaimed.

#### MAXSCRatch (Required)

Specifies the maximum number of scratch volumes that the server can request for this storage pool. You can specify an integer 0 - 100000000. By allowing the server to request scratch volumes as needed, you avoid having to define each volume to be used.

The value that is specified for this parameter is used to estimate the total number of volumes available in the copy storage pool and the corresponding estimated capacity for the copy storage pool.

Scratch volumes are automatically deleted from the storage pool when they become empty. However, if the access mode for a scratch volume is OFFSITE, the volume is not deleted from the copy storage pool until the access mode is changed. An administrator can then query the server for empty, offsite scratch volumes and return them to the onsite location.

When scratch volumes with the device type of FILE become empty and are deleted, the space that the volumes occupied is freed by the server and returned to the file system.

Tip: For server-to-server operations that use virtual volumes and that store a small amount of data, consider specifying a value for the MAXSCRATCH parameter that is higher than the value you typically specify for write operations to other types of volumes. After a write operation to a virtual volume, IBM Spectrum Protect marks the volume as FULL, even if the value of the MAXCAPACITY parameter on the device-class definition is not reached. The server does not keep virtual volumes in FILLING status and does not append to them. If the value of the MAXSCRATCH parameter is too low, server-to-server operations can fail.

#### REUsedelay

Specifies the number of days that must elapse after all files are deleted from a volume before the volume can be rewritten or returned to the scratch pool. This parameter is optional. You can specify an integer 0 - 9999. The default value is 0, which means that a volume can be rewritten or returned to the scratch pool as soon as all the files are deleted from the volume.

Tip: Use this parameter to ensure that when you restore the database to an earlier level, database references to files in the copy storage pool are still valid. You must set this parameter to a value greater than the number of days you plan to retain the oldest database backup. The number of days that are specified for this parameter must be the same as the number specified for the SET DRMDBBACKUPEXPIREDAYS command.

#### OVFLocation

Specifies the overflow location for the storage pool. The server assigns this location name to a volume that is ejected from the library by the command. This parameter is optional. The location name can be a maximum length of 255 characters. Enclose the location name in quotation marks if the location name contains any blank characters.

#### DATAFormat

Specifies the data format to use to back up files to this storage pool and restore files from this storage pool. The default format is the NATIVE server format. You can specify the following values:

##### NATive

Specifies the data format is the native IBM Spectrum Protect server format and includes block headers.

##### NONblock

Specifies the data format is the native IBM Spectrum Protect server format and does not include block headers. The default minimum block size on a volume that is associated with a FILE device class is 256 KB, regardless how much data is written to the volume. For certain tasks, you can minimize wasted space on storage volumes by specifying the NONBLOCK data format. For example, you can specify the NONBLOCK data format for the following tasks:

- Using content-management products
- Using the DIRMC client option to store directory information
- Migrating very small files by using IBM Spectrum Protect for Space Management or IBM Spectrum Protect HSM for Windows

In most situations, however, the NATIVE format is preferred.

##### NETAPPDump

Specifies that the data is in a NetApp dump format. Do not specify this data format for file system images that are in a dump format and that were backed up from a NetApp file server by using NDMP. The server does not complete

storage pool reclamation or AUDIT VOLUME for a storage pool with DATAFORMAT=NETAPPDUMP. You can use the MOVE DATA command to move NDMP-generated data out of a volume if the volume must be reused.

#### CELERRADump

Specifies that the data is in an EMC Celerra dump format. Do not specify this data format for file system images that are in a dump format and that were backed up from an EMC Celerra file server by using NDMP. The server does not complete storage pool reclamation or AUDIT VOLUME for a storage pool with DATAFORMAT=CELERRADUMP. You can use the MOVE DATA command to move NDMP-generated data out of a volume if the volume must be reused.

#### NDMPDump

Specifies that the data is in a NAS vendor-specific backup format. Do not specify this data format for file system images that are in a backup format and that were backed up from a NAS file server other than a NetApp or EMC Celerra file server. The server does not complete storage pool reclamation or AUDIT VOLUME for a storage pool with DATAFORMAT=NDMPDUMP. You can use the MOVE DATA command to move NDMP-generated data out of a volume if the volume must be reused.

#### CRCDATA

Specifies whether a cyclic redundancy check (CRC) validates storage pool data when audit volume processing occurs on the server. This parameter is only valid for NATIVE data format storage pools. This parameter is optional. The default value is NO. By setting CRCDATA to YES and scheduling an AUDIT VOLUME command, you can continually ensure the integrity of data that is stored in your storage hierarchy. You can specify the following values:

##### Yes

Specifies that data is stored containing CRC information, allowing for audit volume processing to validate storage pool data. This mode impacts performance because more processing is required to calculate and compare CRC values between the storage pool and the server.

##### No

Specifies that data is stored without CRC information.

##### Tip:

For storage pools that are associated with the 3592, LTO, or ECARTRIDGE device type, logical block protection provides better protection against data corruption than CRC validation for a storage pool. If you specify CRC validation for a storage pool, data is validated only during volume auditing operations. Errors are identified after data is written to tape.

To enable logical block protection, specify a value of READWRITE for the LBPROTECT parameter on the DEFINE DEVCLASS and UPDATE DEVCLASS commands for the 3592, LTO, or ECARTRIDGE device types. Logical block protection is supported only on the following types of drives and media:

- IBM® LTO5 and later.
- IBM 3592 Generation 3 drives and later with 3592 Generation 2 media and later.
- Oracle StorageTek T10000C and T10000D drives.

#### DEDuplicate

Specifies whether the data that is stored in this storage pool is deduplicated. This parameter is optional and is valid only for storage pools that are defined with a FILE-type device class. The default value is NO.

#### IDENTIFYProcess

Specifies the number of parallel processes to use for server-side data deduplication. This parameter is optional and is valid only for storage pools that are defined with a FILE device class. Enter a value 0 - 50.

The default value for this parameter is 0. Data-deduplication processes for a copy storage pool are not necessary if you specify data-deduplication processes for the primary storage pool. When IBM Spectrum Protect analyzes a file in a storage pool, IBM Spectrum Protect also analyzes the file in all other storage pools.

Remember: Data deduplication processes can be either active or idle. Processes that are working on files are active. Processes that are waiting for files to work on are idle. Processes remain idle until volumes with data to be deduplicated become available. The output of the QUERY PROCESS command for data deduplication includes the total number of bytes and files that have been processed since the process first started. For example, if a data deduplication process processes four files, becomes idle, and then processes five more files, then the total number of files processed is nine. Processes end only when canceled or when the number of data-deduplication processes for the storage pool is changed to a value less than the number currently specified.

### Example: Define a copy storage pool with a DC480 device class.

---

Define a copy storage pool, TAPEPOOL2, to the DC480 device class. Allow up to 50 scratch volumes for this pool. Delay the reuse of volumes for 45 days.

```
define stgpool tapepool2 dc480 pooltype=copy
maxscratch=50 reusedelay=45
```

**Related reference:**

SET DRMDBBACKUPEXPIREDAYS (Specify DB backup series expiration)

## DEFINE STGPOOL (Define an active-data pool assigned to sequential-access devices)

Use this command to define an active-data pool assigned to sequential-access devices.

### Privilege class

To issue this command, you must have system privilege.

### Syntax

```
>>-DEfIne STGpool--pool_name--device_class_name----->
>--POoltype---ACTIVEdata--+-+-----+----->
      '-DEScRiption---description-'
      .-ACCess---READWrite-----
>+-----+----->
      '-ACCess---+READWrite---+'
          +-READOnly---+
          '-UNAVailable-'
      .-COLlocate---No----- .-REClaim---60-----
>+-----+-----+----->
      '-COLlocate---+No-----+' '-REClaim---percent-'
          +-GRoup-----+
          +-NODe-----+
          '-Filespace-'
      .-RECLAIMPRocess---1-----
>+-----+----->
      '-RECLAIMPRocess---number-'
      .-RECLAMATIOnType---THRESHold-----
>+-----+----->
      |                                     (1) |
      '-RECLAMATIOnType---+THRESHold+-----+'
          '-SNAPlock--'
      .-OFFSITERECLAIMLimit---NOLimit-.
>+-----+-----+-----+----->
      '-OFFSITERECLAIMLimit---number--'
      .-REUsedelay---0-----
>+-----+-----+----->
      '-REUsedelay---days-' '-OVFLocation---location-'
      .-DATAFormat---NATive----- .-CRCDATA---No-----
>+-----+-----+-----+----->
      '-DATAFormat---+NATive---+' '-CRCDATA---+Yes+-'
          '-NONblock-'          '-No--'
      .-DEDUPlicate---No-----
>+-----+-----+----->
      '-DEDUPlicate---+No-----+'
          | (2) |
          '-Yes-----'
      .-IDENTIFYPRocess---0-----
>+-----+-----+----->>
      |                                     (3) |
```

'-IDENTIFYProcess-----number-----'

Notes:

1. The RECLAMATIONTYPE=SNAPLOCK setting is valid only for storage pools that are defined to servers that are enabled for IBM Spectrum Protect™ for Data Retention. The storage pool must be assigned to a FILE device class, and the directories that are specified in the device class must be NetApp SnapLock volumes.
2. This parameter is valid only for storage pools that are defined with a FILE device class.
3. This parameter is available only when the value of the DEDUPLICATE parameter is YES.

## Parameters

---

**pool\_name** (Required)

Specifies the name of the storage pool to be defined. The name must be unique, and the maximum length is 30 characters.

**device\_class\_name** (Required)

Specifies the name of the sequential access device class to which this active-data pool is assigned. You can specify any device class except DISK.

**POOLtype=ACTIVEdata** (Required)

Specifies that you want to define an active-data pool.

**DESCRIPTION**

Specifies a description of the active-data pool. This parameter is optional. The maximum length of the description is 255 characters. Enclose the description in quotation marks if it contains any blank characters.

**ACCESS**

Specifies how client nodes and server processes (such as reclamation) can access files in the active-data pool. This parameter is optional. The default value is READWRITE. You can specify the following values:

**READWRITE**

Specifies that files can be read from and written to the volumes in the active-data pool.

**READONLY**

Specifies that client nodes can read only files that are stored on the volumes in the active-data pool.

Server processes can move files within the volumes in the storage pool. The server can use files in the active-data pool to restore files to primary storage pools. However, no new writes are allowed to volumes in the active-data pool from volumes outside the storage pool. A storage pool cannot be copied to the active-data pool.

**UNAVAILABLE**

Specifies that client nodes cannot access files that are stored on volumes in the active-data pool.

Server processes can move files within the volumes in the storage pool. The server can use files in the active-data pool to restore files to primary storage pools. However, no new writes are allowed to volumes in the active-data pool from volumes outside the storage pool. A storage pool cannot be copied to the active-data pool.

**COLLOCATE**

Specifies whether the server attempts to keep data, which is stored on as few volumes as possible, that belong to one of the following candidates:

- A single client node
- A group of file spaces
- A group of client nodes
- A client file space

This parameter is optional. The default value is NO.

Collocation reduces the number of sequential access media mounts for restore, retrieve, and recall operations. However, collocation increases both the amount of server time that is needed to collocate files for storing and the number of volumes required.

You can specify one of the following options:

**No**

Specifies that collocation is disabled.

**GROUP**

Specifies that collocation is enabled at the group level for client nodes or file spaces. For collocation groups, the server attempts to put data for nodes or file spaces that belong to the same collocation group on as few volumes as

possible.

If you specify COLLOCATE=GROUP but do not define any collocation groups, or if you do not add nodes or file spaces to a collocation group, data is collocated by node. Consider tape usage when you organize client nodes or file spaces into collocation groups.

For example, if a tape-based storage pool consists of data from nodes and you specify COLLOCATE=GROUP, the server completes the following actions:

- Collocates the data by group for grouped nodes. Whenever possible, the server collocates data that belongs to a group of nodes on a single tape or on as few tapes as possible. Data for a single node can also be spread across several tapes that are associated with a group.
- Collocates the data by node for ungrouped nodes. Whenever possible, the server stores the data for a single node on a single tape. All available tapes that already have data for the node are used before available space on any other tape is used.

If a tape-based storage pool consists of data from grouped file spaces and you specify COLLOCATE=GROUP, the server completes the following actions:

- Collocates by group, the data for grouped file spaces only. Whenever possible, the server collocates data that belongs to a group of file spaces on a single tape or on as few tapes as possible. Data for a single file space can also be spread across several tapes that are associated with a group.
- Collocates the data by node (for file spaces that are not explicitly defined to a file space collocation group). For example, node1 has file spaces named A, B, C, D, and E. File spaces A and B belong to a file space collocation group but C, D, and E do not. File spaces A and B are collocated by file space collocation group, while C, D, and E are collocated by node.

Data is collocated on the least amount of sequential access volumes.

#### NODE

Specifies that collocation is enabled at the client node level. For collocation groups, the server attempts to put data for one node on as few volumes as possible. If the node has multiple file spaces, the server does not try to collocate those file spaces. For compatibility with an earlier version, COLLOCATE=YES is still accepted by the server to specify collocation at the client node level.

If a storage pool contains data for a node that is a member of a collocation group and you specify COLLOCATE=NODE, the data is collocated by node.

#### Filespace

Specifies that collocation is enabled at the file space level for client nodes. The server attempts to place data for one node and file space on as few volumes as possible. If a node has multiple file spaces, the server attempts to place data for different file spaces on different volumes.

#### RECLAIM

Specifies when the server reclaims a volume, which is based on the percentage of reclaimable space on a volume.

Reclaimable space is the amount of space that is occupied by files that are expired or deleted from the IBM Spectrum Protect database.

Reclamation makes the fragmented space and space occupied by inactive backup files on volumes usable again by moving any remaining unexpired files and active backup files from one volume to another volume. This action makes the original volume available for reuse. This parameter is optional. You can specify an integer 1 - 100. The default value is 60.

The server determines that the volume is a candidate for reclamation if the percentage of reclaimable space on a volume is greater than the reclamation threshold of the storage pool.

If you change the value from the default, specify a value of 50 percent or greater so that files stored on two volumes can be combined onto a single output volume.

When an active-data pool volume that is offsite becomes eligible for reclamation, the reclamation process attempts to obtain the unexpired files on the reclaimable volume from a primary or active-data pool that is onsite. The process then writes these files to an available volume in the original active-data pool. Effectively, these files are moved back to the onsite location. However, the files can be obtained from the offsite volume after a disaster if a database backup is used that references the files on the offsite volume. Because of the way reclamation works with offsite volumes, use it carefully with active-data pools.

#### RECLAIMPROCESS



Specifies the number of parallel processes to use for reclaiming the volumes in this storage pool. This parameter is optional. Enter a value 1 - 999. The default value is 1.

When you calculate the value for this parameter, consider the following resources that are required for reclamation processing:

- The number of sequential storage pools.
- The number of logical and physical drives that can be dedicated to the operation.

To access sequential volumes, IBM Spectrum Protect uses a mount point and, if the device type is not FILE, a physical drive.

For example, suppose that you want to reclaim the volumes from two sequential storage pools simultaneously and that you want to specify four processes for each of the storage pools. The storage pools have the same device class. Each process requires two mount points and, if the device type is not FILE, two drives. (One of the drives is for the input volume, and the other drive is for the output volume.) To run eight reclamation processes simultaneously, you need a total of at least 16 mount points and 16 drives. The device class for the storage pools must have a mount limit of at least 16.

You can specify one or more reclamation processes for each active-data pool. You can specify multiple concurrent reclamation processes for a single active-data pool, which makes better use of your available tape drives or FILE volumes. If multiple concurrent processing is not necessary, specify a value of 1 for the RECLAIMPROCESS parameter.

#### RECLAMATIONType

Specifies the method by which volumes are reclaimed and managed. This parameter is optional. The default value is THRESHOLD. The following are possible values:

##### THRESHold

Specifies that volumes that belong to this storage pool are reclaimed based on the threshold value in the RECLAIM attribute for this storage pool.

##### SNAPlock

Specifies that FILE volumes that belong to this storage pool are managed for retention by using NetApp Data ONTAP software and NetApp SnapLock volumes. This parameter is only valid for storage pools that are being defined to a server that has data retention protection that is enabled and that is assigned to a FILE device class. Volumes in this storage pool are not reclaimed based on threshold; the RECLAIM value for the storage pool is ignored.

All volumes in this storage pool are created as FILE volumes. A retention date, which is derived from the retention attributes in the archive copy group for the storage pool, is set in the metadata for the FILE volume by using the SnapLock feature of the NetApp Data ONTAP operating system. Until the retention date expires, the FILE volume and any data on it cannot be deleted from the physical SnapLock volume on which it is stored.

The RECLAMATIONTYPE parameter for all storage pools that are being defined must be the same when defined to the same device class name. The DEFINE command fails if the RECLAMATIONTYPE parameter specified is different from what is defined for storage pools that are already defined to the device class name.

#### OFFSITERECLAIMLimit

Specifies the number of offsite volumes that space is reclaimed from during reclamation for this storage pool. This parameter is optional. The default value is NOLIMIT. You can specify the following values:

##### NOLimit

Specifies that you want to reclaim the space in all of your offsite volumes.

##### number

Specifies the number of offsite volumes to reclaim space from. You can specify an integer 0 - 99999. A value of zero means that none of the offsite volumes are reclaimed.

Tip:

To determine the value for the OFFSITERECLAIMLIMIT, use the statistical information in the message that is issued at the end of the offsite volume reclamation operation. The statistical information includes the following items:

- The number of offsite volumes that were processed
- The number of parallel processes that were used
- The total amount of time required for the processing

The order in which offsite volumes are reclaimed is based on the amount of unused space in a volume. (Unused space includes both space that has never been used on the volume and space that has become empty because of file deletion.) Volumes with the largest amount of unused space are reclaimed first.

For example, suppose an active-data pool contains three volumes: VOL1, VOL2, and VOL3. VOL1 has the largest amount of unused space, and VOL3 has the least amount of unused space. Suppose further that the percentage of unused space in each of the three volumes is greater than the value of the RECLAIM parameter. If you do not specify a value for the OFFSITERECLAIMLIMIT parameter, all three volumes are reclaimed when the reclamation runs. If you specify a value of 2, only VOL1 and VOL2 are reclaimed when the reclamation runs. If you specify a value of 1, only VOL1 is reclaimed.

#### MAXSCRatch (Required)

Specifies the maximum number of scratch volumes that the server can request for this storage pool. You can specify an integer 0 - 100000000. By allowing the server to request scratch volumes as needed, you avoid having to define each volume to be used.

The value that is specified for this parameter is used to estimate the total number of volumes available in the active-data pool and the corresponding estimated capacity for the active-data pool.

Scratch volumes are automatically deleted from the storage pool when they become empty. However, if the access mode for a scratch volume is OFFSITE, the volume is not deleted from the active-data pool until the access mode is changed. An administrator can then query the server for empty, offsite scratch volumes and return them to the onsite location.

When scratch volumes with the device type of FILE become empty and are deleted, the space that the volumes occupied is freed by the server and returned to the file system.

Tip: For server-to-server operations that use virtual volumes and that store a small amount of data, consider specifying a value for the MAXSCRATCH parameter that is higher than the value you typically specify for write operations to other types of volumes. After a write operation to a virtual volume, IBM Spectrum Protect marks the volume as FULL, even if the value of the MAXCAPACITY parameter on the device-class definition is not reached. The server does not keep virtual volumes in FILLING status and does not append to them. If the value of the MAXSCRATCH parameter is too low, server-to-server operations can fail.

#### REUsedelay

Specifies the number of days that must elapse after all files are deleted from a volume before the volume can be rewritten or returned to the scratch pool. This parameter is optional. You can specify an integer 0 - 9999. The default value is 0, which means that a volume can be rewritten or returned to the scratch pool as soon as all the files are deleted from the volume.

Tip: Use this parameter to ensure that when you restore the database to an earlier level, database references to files in the active-data pool are still valid. You must set this parameter to a value greater than the number of days you plan to retain the oldest database backup. The number of days that are specified for this parameter must be the same as the number specified for the SET DRMDBBACKUPEXPIREDAYS command.

#### OVFLocation

Specifies the overflow location for the storage pool. The server assigns this location name to a volume that is ejected from the library by the command. This parameter is optional. The location name can be a maximum length of 255 characters. Enclose the location name in quotation marks if the location name contains any blank characters.

#### DATAFormat

Specifies the data format to use to copy files to this storage pool and restore files from this storage pool. The default format is the NATIVE server format. You can specify the following values:

##### NATive

Specifies the data format is the native IBM Spectrum Protect server format and includes block headers.

##### NONblock

Specifies the data format is the native IBM Spectrum Protect server format and does not include block headers. The default minimum block size on a volume that is associated with a FILE device class is 256 KB, regardless how much data is written to the volume. For certain tasks, you can minimize wasted space on storage volumes by specifying the NONBLOCK data format. For example, you can specify the NONBLOCK data format for the following tasks:

- Using content-management products
- Using the DIRMC client option to store directory information
- Migrating very small files by using IBM Spectrum Protect for Space Management or IBM Spectrum Protect HSM for Windows

In most situations, however, the NATIVE format is preferred.

#### CRCDData

Specifies whether a cyclic redundancy check (CRC) validates storage pool data when audit volume processing occurs on the server. This parameter is only valid for NATIVE data format storage pools. This parameter is optional. The default value is

NO. By setting CRCDATA to YES and scheduling an AUDIT VOLUME command, you can continually ensure the integrity of data that is stored in your storage hierarchy. You can specify the following values:

Yes

Specifies that data is stored containing CRC information, allowing for audit volume processing to validate storage pool data. This mode impacts performance because more processing is required to calculate and compare CRC values between the storage pool and the server.

No

Specifies that data is stored without CRC information.

Tip:

For storage pools that are associated with the 3592, LTO, or ECARTRIDGE device type, logical block protection provides better protection against data corruption than CRC validation for a storage pool. If you specify CRC validation for a storage pool, data is validated only during volume auditing operations. Errors are identified after data is written to tape.

To enable logical block protection, specify a value of READWRITE for the LBPROTECT parameter on the DEFINE DEVCLASS and UPDATE DEVCLASS commands for the 3592, LTO, or ECARTRIDGE device types. Logical block protection is supported only on the following types of drives and media:

- IBM® LTO5 and later.
- IBM 3592 Generation 3 drives and later with 3592 Generation 2 media and later.
- Oracle StorageTek T10000C and T10000D drives.

DEDuplicate

Specifies whether the data that is stored in this storage pool is deduplicated. This parameter is optional and is valid only for storage pools that are defined with a FILE device class. The default value is NO.

IDENTIFYProcess

Specifies the number of parallel processes to use for server-side data deduplication. This parameter is optional and is valid only for storage pools that are defined with a FILE device class. Enter a value 0 - 50.

The default value for this parameter is 0. Data-deduplication processes for a copy storage pool are not necessary if you specify data-deduplication processes for the primary storage pool. When IBM Spectrum Protect analyzes a file in a storage pool, IBM Spectrum Protect also analyzes the file in all other storage pools.

Remember: Data deduplication processes can be either active or idle. Processes that are working on files are active. Processes that are waiting for files to work on are idle. Processes remain idle until volumes with data to be deduplicated become available. The output of the QUERY PROCESS command for data deduplication includes the total number of bytes and files that have been processed since the process first started. For example, if a data deduplication process processes four files, becomes idle, and then processes five more files, then the total number of files processed is nine. Processes end only when canceled or when the number of data-deduplication processes for the storage pool is changed to a value less than the number currently specified.

## Example: Define an active-data pool with a DC500 device class

---

Define an active-data pool, TAPEPOOL2, to the DC500 device class. Allow up to 50 scratch volumes for this pool. Delay the reuse of volumes for 45 days.

```
define stgpool tapepool3 dc500 pooltype=activedata
maxscratch=50 reusedelay=45
```

**Related reference:**

SET DRMDBBACKUPEXPIREDDAYS (Specify DB backup series expiration)

## DEFINE STGPOOLDIRECTORY (Define a storage pool directory)

---

Use this command to define one or more directories in a directory-container or cloud-container storage pool.

Tip: After you define a cloud-container storage pool, create one or more directories that are used for local storage. You can temporarily store data in local storage during the data ingestion, before the data is moved to the cloud. In this way, you can improve backup and archive performance. For more information, see Optimizing performance for cloud object storage.

## Privilege class

---

To issue this command, you must have system privilege.

## Syntax

```
      .-.-.-.-.-.
      |
      v
>>-DEFINE STGPOOLDirectory--pool_name-----directory_name+----->>
```

## Parameters

pool\_name (Required)

Specifies the name of a directory-container or cloud-container storage pool. This parameter is required.

directory\_name (Required)

Specifies the directory to be defined in the storage pool. This parameter is required. You can specify more than one directory name by separating each name with a comma, with no intervening spaces.

If you use the administrative client and the directory name contains a comma or a backslash ("\"), enclose the name in quotation marks.

## Example: Define a storage pool directory

Define a storage pool directory that is named DIR1 by using a directory-container storage pool that is named POOL1.

AIX Linux

```
define stgpooldirectory pool1 /storage/dir1
```

Windows

```
define stgpooldirectory pool1 c:\storage\dir1
```

## Example: Define multiple storage pool directories

Define storage pool directories that are named DIR1 and DIR2 by using a directory-container storage pool that is named POOL1.

AIX Linux

```
define stgpooldirectory pool1 /storage/dir1,/storage/dir2
```

Windows

```
define stgpooldirectory pool1 e:\storage\dir1,f:\storage\dir2
```

## Example: Define local storage for a cloud-container storage pool

Create a storage pool directory that is named DIR3 in a cloud-container storage pool that is named CLOUDLOCALDISK1.

AIX Linux

```
define stgpooldirectory cloudlocaldisk1 /storage/dir3
```

Windows

```
define stgpooldirectory cloudlocaldisk1 c:\storage\dir3
```

Table 1. Commands related to DEFINE STGPOOLDIRECTORY

Command	Description
DEFINE STGPOOL	Defines a storage pool as a named collection of server storage media.
DELETE STGPOOLDIRECTORY	Deletes a storage pool directory from a directory-container or cloud-container storage pool.
QUERY STGPOOLDIRECTORY	Displays information about storage pool directories.
UPDATE STGPOOLDIRECTORY	Changes the attributes of a storage pool directory.

## DEFINE SUBSCRIPTION (Define a profile subscription)

Use this command on a managed server to subscribe that managed server to a profile.

When a server subscribes to its first profile, a subscription is also created to the default profile (if one exists) of the configuration manager. The server then contacts the configuration manager periodically for configuration updates.

Restrictions:

1. A server cannot subscribe to profiles from more than one configuration manager.
2. If a server subscribes to a profile with an associated object that is already defined on the server, the local definition is replaced by the definition from the configuration manager. For example, if a server has an administrative schedule named WEEKLY\_BACKUP, then subscribes to a profile that also has an administrative schedule named WEEKLY\_BACKUP, the local definition is replaced.

## Privilege class

---

To issue this command, you must have system privilege.

## Syntax

---

```
>>--DEFine SUBSCRIPtion--profile_name----->
>--+-----+-----><
  '-SERVer---server_name-'
```

## Parameters

---

profile\_name (Required)

Specifies the name of the profile to which the server subscribes.

SERVer

Specifies the name of the configuration manager from which the configuration information is obtained. This parameter is required, if the managed server does not have at least one subscription. If the managed server has a subscription, you can omit this parameter and it defaults to the configuration manager for that subscription.

## Example: Define a profile subscription

---

Subscribe a profile named BETA that resides on a configuration manager named TOM.

```
define subscription beta server=tom
```

## Related commands

---

Table 1. Commands related to DEFINE SUBSCRIPTION

Command	Description
COPY PROFILE	Creates a copy of a profile.
DEFINE PROFILE	Defines a profile for distributing information to managed servers.
DELETE PROFILE	Deletes a profile from a configuration manager.
DELETE SUBSCRIBER	Deletes obsolete managed server subscriptions.
DELETE SUBSCRIPTION	Deletes a specified profile subscription.
LOCK PROFILE	Prevents distribution of a configuration profile.
NOTIFY SUBSCRIBERS	Notifies servers to refresh their configuration information.
QUERY PROFILE	Displays information about configuration profiles.
QUERY SUBSCRIBER	Displays information about subscribers and their subscriptions to profiles.
QUERY SUBSCRIPTION	Displays information about profile subscriptions.

Command	Description
SET CONFIGREFRESH	Specifies a time interval for managed servers to contact configuration managers.
UNLOCK PROFILE	Enables a locked profile to be distributed to managed servers.
UPDATE PROFILE	Changes the description of a profile.

## DEFINE VIRTUALFSMAPPING (Define a virtual file space mapping)

Use this command to define a virtual file space mapping.

Virtual file space names can be used in the NAS data operations BACKUP NODE and RESTORE NODE similar to a file system name. Refer to the documentation about your NAS device for guidance on specifying the parameters for this command.

Note: The NAS node must have an associated data mover definition because when the IBM Spectrum Protect™ server updates a virtual file space mapping, the server attempts to contact the NAS device to validate the virtual file system and file system name.

### Privilege class

To issue this command, you must have one of the following privilege classes:

- System privilege
- Unrestricted policy privilege
- Restricted policy privilege for the domain to which the NAS node is assigned.

### Syntax

```
>>-DEFine VIRTUALFSmapping  -node_name----->
>--virtual_filespace_name--file_system_name--path----->
      .-NAMEType---SERVER-----
>--+-----+-----+----->>
      '-NAMEType---+SERVER-----+'
                          '-HEXadecimal-'
```

### Parameters

node\_name (Required)

Specifies the NAS node on which the file system and path reside. You cannot use wildcard characters or specify a list of names.

virtual\_filespace\_name (Required)

Specifies the name which refers to this virtual file space definition. The virtual file space name is case sensitive and the first character must be a forward slash /. The length of the name cannot be more than 64 characters, including the required forward slash. Virtual file space names are restricted to the same character set as all other objects in the server except that the forward slash / character is also allowed.

The virtual file space name cannot be identical to any file system on the NAS node. When selecting a virtual file space name, consider the following restrictions:

- If a file system is created on the NAS device with the same name as a virtual file system, a name conflict will occur on the server when the new file space is backed up. Use a string for the virtual file space name that is unlikely to be used as a real file system name on your NAS device in the future.

For example: A user follows a naming convention for creating file spaces on a NAS device with names of the form /vol1, /vol2, /vol3. The user defines a virtual file space to the server with the name /vol9. If the user continues to use the same naming convention, the virtual file space name is likely to conflict with a real file space name at some point in the future.

- During backup and restore operations, the server verifies that a name conflict does not occur prior to starting the operation.
- The virtual file space name appears as a file space in the output of the QUERY FILESPACE command, and also in the backup and restore panels of the IBM Spectrum Protect web client. Therefore, consider selecting a name that unambiguously identifies this object as a directory path on the NAS device.

file\_system\_name (Required)

Specifies the name of the file system in which the path is located. The file system name must exist on the specified NAS node. The file system name cannot contain wildcard characters.

path (Required)

Specifies the path from the root of the file system to the directory. The path can only reference a directory. The maximum length of the path is 1024 characters. The path name is case sensitive.

NAMETYPE

Specifies how the server should interpret the path name specified. This parameter is useful when a path contains characters that are not part of the code page in which the server is running. The default value is SERVER.

Possible values are:

SERVER

The server uses the server code page to interpret the path name.

HEXadecimal

The server interprets the path that you enter as the hexadecimal representation of the path. This option should be used when a path contains characters that cannot be entered. This could occur if the NAS file system is set to a language different from the one in which the server is running.

## Example: Define a virtual file space mapping

Define the virtual file space mapping name /mikeshomedir for the path /home/mike on the file system /vol/vol1 on the NAS node named NAS1.

```
define virtualfsmapping nas1 /mikeshomedir /vol/vol1 /home/mike
```

## Related commands

Table 1. Commands related to DEFINE VIRTUALFSMAPPING

Command	Description
DELETE VIRTUALFSMAPPING	Delete a virtual file space mapping.
QUERY VIRTUALFSMAPPING	Query a virtual file space mapping.
UPDATE VIRTUALFSMAPPING	Update a virtual file space mapping.

## DEFINE VOLUME (Define a volume in a storage pool)

Use this command to assign a random or sequential access volume to a storage pool.

When you define a random-access (DISK) storage-pool volume or a sequential access storage pool volume that is associated with a FILE device class, you can have the server create the volume before it is assigned. Alternatively, you can use space triggers to create preassigned volumes when predetermined space-utilization thresholds are exceeded. For details about space triggers, see DEFINE SPACETRIGGER (Define the space trigger). For volumes associated with device classes other than DISK or device types other than FILE, you can use the DEFINE VOLUME command to assign an already-created volume to a storage pool.

**AIX** | **Linux** When you use a FILE device class for storage that is managed by a z/OS® media server, it is not necessary to format or define volumes. If you define a volume for such a FILE device class by using the DEFINE VOLUME command, the z/OS media server does not allocate space for the volume until the volume is opened for its first use.

**Attention:** Volumes for the z/OS media server that are created using the DEFINE VOLUME command remain physically full or allocated after the server empties the volume, for example, after expiration or reclamation. For FILE volumes, the DASD space is not relinquished to the system when the volume is emptied. If a storage pool requires an empty or filling volume, the FILE volume can be used. In contrast, tape volumes that are logically empty are the same as physically empty. FILE and tape volumes remain

defined in the server. In contrast, SCRATCH volumes, including the physical storage that is allocated for SCRATCH FILE volumes, are returned to the system when emptied.

To create space in sequential access storage pools, you can define volumes or allow the server to request scratch volumes as needed, as specified by the MAXSCRATCH parameter for the storage pool. For storage pools associated with the FILE device class, the server can create private volumes as needed using storage-pool space triggers. For DISK storage pools, the scratch mechanism is not available. However, you can create space by creating volumes and then defining them to the server. Alternatively, you can have the server create volumes that use storage-pool space triggers.

The server does not validate the existence of a volume name when defining a volume in a storage pool that is associated with a library. The defined volume has "0" EST capacity until data is written to the volume.

Attention: The size of a storage pool volume cannot be changed after it is defined to the server.

**AIX** If you change the size of IBM Spectrum Protect™ volumes by extending raw logical volumes through SMIT or otherwise altering the file sizes of the volumes with operating system commands or utilities, the server might not initialize correctly and data can be lost.

**Windows** If you change the size of volumes by altering the file sizes of the volumes with operating system commands or utilities, the server might not initialize correctly and data can be lost.

Restrictions:

- You cannot use this command to define volumes in storage pools with the parameter setting RECLAMATIONTYPE=SNAPLOCK. Volumes in this type of storage pool are allocated by using the MAXSCRATCH parameter on the storage pool definition.
- You cannot define volumes in a storage pool that is defined with the CENTERA device class.
- **Linux** You cannot use raw logical volumes for storage pool volumes.

Physical files that are allocated with DEFINE VOLUME command are not removed from a file space if you issue the DELETE VOLUME command.

## Privilege class

To issue this command, you must have system privilege, unrestricted storage privilege, or restricted storage privilege for the storage pool to which the volume is assigned.

## Syntax

```
>>-DEFine Volume--pool_name--volume_name----->
    .-ACcEss---READWrite-----
>--+-----+----->
    '-ACcEss---+READWrite---+'
        +-READOnly---+
        +-UNAVailable-+
        |           (1) |
        '-OfFsite-----'

>--+-----+----->
    |                                     .-Wait---No----- |
    '-FormAtsize---megabytes-+-----+-'
                                   '-Wait---+No---+'
                                       '-Yes-'

    .-Numberofvolumes---1-----
>--+-----+----->
    |           (2) |
    '-Numberofvolumes-----number-'

>--+-----+-----><
    |           (3) |
    '-LLocation-----location-'
```

Notes:



1. This value is valid only for volumes that are assigned to copy storage pools.
2. This parameter is valid only for DISK or FILE volumes.
3. This parameter is valid only for sequential access volumes.

## Parameters

pool\_name (Required)

Specifies the name of the storage pool to which the volume is assigned.

volume\_name (Required)

Specifies the name of the storage pool volume to be defined. If you specify a number greater than 1 for the NUMBEROFVOLUMES parameter, the volume name is used as a prefix to generate multiple volume names. The volume name that you specify depends on the type of device that the storage pool uses.

Each volume that is used by a server for any purpose must have a unique name. This requirement applies to all volumes, whether the volumes are used for storage pools, or used for operations such as database backup or export. The requirement also applies to volumes that reside in different libraries but that are used by the same server.

**AIX** **Linux** Remember: Volume names cannot contain embedded blanks or equal signs.

**Windows** Remember: Volume names cannot contain embedded blanks or equal signs, except for DISK or FILE volumes.

See the following tables for volume name requirements:

- Table 1: DISK
- Table 2: FILE
- **AIX** **Linux** Table 3: FILE for the z/OS media server
- Table 4: Tape
- **AIX** **Linux** Table 5: Tape for z/OS media server
- Table 6: REMOVABLEFILE

Table 1. Volume name requirements for DISK

Volume Name Requirements	Example
<p>The name of the file to contain the volume data, with either the fully qualified path name or a path name relative to the current working directory.</p> <p><b>Windows</b> If a name contains embedded blanks, equal signs, or other special characters, enclose the list in quotation marks.</p>	<p><b>AIX</b> <b>Linux</b></p> <pre>/usr/storage/sbkup01.dsm</pre> <p><b>AIX</b> If you are using an AIX® logical volume, enter the path name as:</p> <pre>/dev/rxxx</pre> <p>where xxx is the logical volume name.</p> <p><b>Windows</b></p> <pre>"c:\program files\tivoli\tsm\server\data3.dsm"</pre>

Table 2. Volume name requirements for FILE

Volume Name Requirements	Example
<p>The name of the file to contain the volume data, with either the fully qualified path name or the path name relative to a directory identified in the DIRECTORY parameter for the device class.</p> <p><b>Windows</b> If a name contains embedded blanks, equal signs, or other special characters, enclose the list in quotation marks.</p> <p>Place FILE volumes in one of the directories that are specified with the DIRECTORY parameter of the DEFINE DEVCLASS command. Otherwise, storage agents might not have access to the volumes. For details, see DEFINE PATH (Define a path).</p>	<p><b>AIX</b> <b>Linux</b></p> <pre>/data/fpool01.dsm</pre> <p><b>Windows</b></p> <pre>"f:\data storage\fpool01.dsm"</pre>

**AIX** **Linux**

Table 3. z/OS media server: Volume name requirements for FILE

Volume Name Requirements	Example
--------------------------	---------

Volume Name Requirements	Example
<p>For FILE volumes used with the z/OS media server server, specify a data set name. The data set name can consist of one or more qualifiers that are delimited by a period. The qualifiers can contain up to 8 characters. The maximum length of the data set name is 44 characters. The first letter of each qualifier must be alphabetic or national (@#\$), followed by alphabetic, national, hyphen, or numeric characters.</p> <p>To allocate the associated VSAM Linear Dataset when the volume is tendered on the z/OS system, the High Level Qualifier (HLQ) is typically filtered by specific ACS routines within the SMS policy constraints on the system where the z/OS media server is running.</p> <p>The behavior of the HLQ is similar to the behavior of the PREFIX name on a scratch request. The HLQ is typically used by DFSMS to affect allocation attributes, such as Extended Addressability for data sets that are expected to extend when space that is already allocated to the file volume is used up.</p> <p>If the data set does not exist, the server creates it when the volume is used for a specific IBM Spectrum Protect storage operation. The data set is not created when the volume is defined. Data loss can result when defining volumes because the z/OS media server reuses the volume or VSAM LDS if it exists at the time of allocation time.</p> <p>Important: To allow the server to generate volume names, consider using SCRATCH volumes.</p>	<div style="background-color: #e91e63; color: white; padding: 2px; display: flex; justify-content: space-between; font-size: 0.8em;"> <span>AIX</span> <span>Linux</span> </div> <p>SERVER1.BFS.POOL3.VOLA</p>

Table 4. Volume name requirements for tape

Volume Name Requirements	Example
<p>Use 1 - 32 alphanumeric characters.</p> <p>The volume name cannot contain any embedded blanks or equal signs.</p>	<p>DSMT01</p>

AIX
Linux

Table 5. z/OS media server: Volume name requirements for tape

Volume Name Requirements	Example
<p>For tape cartridges, specify a tape volume name with 1 - 6 alphanumeric characters. The server converts tape volume names to uppercase.</p> <p>The volume name cannot contain any embedded blanks or equal signs.</p> <p>Each volume that is used by a server for any purpose must have a unique name. This requirement applies to all volumes, whether the volumes are used for storage pools, or used for operations such as database backup or export. The requirement also applies to volumes that reside in different z/OS media libraries but that are used by the same server.</p>	<p>DSMT01</p>

Table 6. Volume name requirements for REMOVABLEFILE

Volume Name Requirements	Example
--------------------------	---------

Volume Name Requirements	Example
1–6 alphanumeric characters	DSM01
The server converts volume names to uppercase.	

#### ACcESS

Specifies how client nodes and server processes (such as migration) can access files in the storage pool volume. This parameter is optional. The default value is READWRITE. Possible values are:

##### READWrite

Specifies that client nodes and server processes can read from and write to files stored on the volume.

##### READOnly

Specifies that client nodes and server processes can only read files that are stored on the volume.

##### UNAVailable

Specifies that client nodes or server processes cannot access files that are stored on the volume.

If you define a random access volume as UNAVAILABLE, you cannot vary the volume online.

If you define a sequential access volume as UNAVAILABLE, the server does not attempt to access the volume.

#### OFFsite

Specifies that the volume is at an offsite location from which it cannot be mounted. You can specify this value only for volumes in copy or active-data storage pools.

Use this value to help you track volumes at offsite locations. The server treats volumes that are designated as offsite differently:

- The server does not generate mount requests for volumes designated offsite.
- The server reclaims or moves data from offsite volumes by retrieving files from other storage pools.
- The server does not automatically delete empty, offsite scratch volumes from a copy or active-data storage pool.

#### LOcation

Specifies the location of the volume. This parameter is optional. It can be specified only for volumes in sequential access storage pools. The location information can be a maximum length of 255 characters. Enclose the location in quotation marks if it contains any blank characters.

#### FormAtsize

Specifies the size of the random access volume or FILE volume that is created and formatted in one step. The value is specified in megabytes. The maximum size is 8 000 000 MB (8 terabytes). This parameter is required if any of the following conditions are true:

- A single FILE or DISK volume is specified, which is to be created and formatted in one step.
- The value for the NUMBEROFVOLUMES parameter is greater than 1, and DISK volumes are being created.
- The value of the NUMBEROFVOLUMES parameter is greater than 1, and the value of the FORMATSIZE parameter is less than or equal to the MAXCAPACITY parameter of the DEFINE DEVCLASS command.

If you are allocating volumes on a z/OS media server, this parameter is not valid.

For a FILE volume, you must specify a value less than or equal to the value of the MAXCAPACITY parameter of the device class associated with the storage pool.

You cannot use this parameter for multiple, predefined volumes. Unless you specify `WAIT=YES` is specified, the operation is completed as a background process.

#### Numberofvolumes

Specifies the number of volumes that are created and formatted in one step. This parameter applies only to storage pools with DISK or FILE device classes. This parameter is optional. The default is 1. If you specify a value greater than 1, you must also specify a value for the FORMATSIZE parameter. Specify a number from 1 to 256.

If you are allocating volumes on a z/OS media server, the only value that this parameter supports is the default value of 1.

If the value for the NUMBEROFVOLUMES parameter is greater than 1, the volume name you specified will have a numeric suffix appended to create each name, for example, `tivolivol001` and `tivolivol002`. Be sure to choose a volume name so that a valid file name for the target file system is created when the suffix is appended.

Important: You must ensure that storage agents can access newly created FILE volumes. For more information, see `DEFINE PATH` (Define a path).

Wait

Specifies whether volume creation and formatting operation is completed in the foreground or background. This parameter is optional. It is ignored unless you also specify the FORMATSIZE parameter.

No

Specifies that a volume creation and formatting operation is completed in the background. The NO value is the default when you also specify a format size.

Yes

Specifies that a volume creation and formatting operation is completed in the foreground.  
Remember: You cannot specify `WAIT=YES` from the server console.

## Example: Use a background process to define a new 100 MB volume for a disk storage pool

Create a volume of 100 MB in the disk storage pool named BACKUPPOOL. AIX Linux The volume name is `/var/storage/bf.dsm`. Windows The volume name is `j:\storage\bf.dsm`. Let the volume be created as a background process.

AIX Linux

```
define volume backuppool  
/var/storage/bf.dsm formatsize=100
```

Windows

```
define volume backuppool j:\storage\bf.dsm formatsize=100
```

## Example: Define a volume to a disk storage pool with read and write access

A storage pool named POOL1 is assigned to a tape device class. Define a volume named TAPE01 to this storage pool, with READWRITE access.

```
define volume pool1 tape01 access=readwrite
```

## Example: Define a volume to a file storage pool

A storage pool that is named FILEPOOL is assigned to a device class with a device type of FILE. AIX Linux Define a volume that is named `filepool_vol01` to this storage pool. Windows Define a volume that is named `fp_vol01.dsm` to this storage pool. AIX Linux

```
define volume filepool /usr/storage/filepool_vol01
```

Windows

```
define volume filepool j:\storage\fp_vol01.dsm
```

## Example: Example: Use a background process to define 10 volumes for a file storage pool with a device class 5 GB maximum capacity

Define 10 volumes in a sequential storage pool that uses a FILE device class. The storage pool is named FILEPOOL. The value of the MAXCAPACITY parameter for the device class that is associated with this storage pool is 5 GB. Creation must occur in the background.

```
define volume filepool filevol numberofvolumes=10 formatsize=5000
```

The server creates volume names `filevol001` through `filevol010`.

Volumes are created in the directory or directories that are specified with the DIRECTORY parameter of the device class that is associated with storage pool `filepool`. If you specified multiple directories for the device class, individual volumes can be created in any of the directories in the list.

## Related commands

Table 7. Commands related to DEFINE VOLUME

Command	Description
DEFINE STGPOOL	Defines a storage pool as a named collection of server storage media.

Command	Description
QUERY VOLUME	Displays information about storage pool volumes.
UPDATE DEVCLASS	Changes the attributes of a device class.
UPDATE LIBVOLUME	Changes the status of a storage volume.
UPDATE VOLUME	Updates the attributes of storage pool volumes.

## DELETE commands

---

Use the DELETE commands to delete or remove an IBM Spectrum Protect™ object.

- DELETE ASSOCIATION (Delete the node association to a schedule)
- DELETE ALERTTRIGGER (Remove a message from an alert trigger)
- DELETE BACKUPSET (Delete a backup set)
- DELETE CLIENTOPT (Delete an option in an option set)
- DELETE CLOPTSET (Delete a client option set)
- DELETE COLLOGROUP (Delete a collocation group)
- DELETE COLLOCMEMBER (Delete collocation group member)
- DELETE COPYGROUP (Delete a backup or archive copy group)
- DELETE DATAMOVER (Delete a data mover)
- DELETE DEDUPSTATS (Delete data deduplication statistics)
- DELETE DEVCLASS (Delete a device class)
- DELETE DOMAIN (Delete a policy domain)
- DELETE DRIVE (Delete a drive from a library)
- DELETE EVENT (Delete event records)
- DELETE EVENTSERVER (Delete the definition of the event server)
- DELETE FILESPACE (Delete client node data from the server)
- DELETE GRPMEMBER (Delete a server from a server group)
- DELETE LIBRARY (Delete a library)
- DELETE MACHINE (Delete machine information)
- DELETE MACHNODEASSOCIATION (Delete association between a machine and a node)
- DELETE MGMTCLASS (Delete a management class)
- DELETE NODEGROUP (Delete a node group)
- DELETE NODEGROUPMEMBER (Delete node group member)
- DELETE PATH (Delete a path)
- DELETE POLICYSET (Delete a policy set)
- DELETE PROFASSOCIATION (Delete a profile association)
- DELETE PROFILE (Delete a profile)
- DELETE RECMEDMACHASSOCIATION (Delete recovery media and machine association)
- DELETE RECOVERYMEDIA (Delete recovery media)
- DELETE SCHEDULE (Delete a client or an administrative command schedule)
- DELETE SCRIPT (Delete command lines from a script or delete the entire script)
- DELETE SERVER (Delete a server definition)
- DELETE SERVERGROUP (Delete a server group)
- DELETE SPACETRIGGER (Delete the storage pool space triggers)
- DELETE STATUSTHRESHOLD (Delete a status monitoring threshold)
- DELETE STGPOOL (Delete a storage pool)
- DELETE STGPOOLDIRECTORY (Deleting a storage pool directory)
- DELETE SUBSCRIBER (Delete subscriptions from a configuration manager database)
- DELETE SUBSCRIPTION (Delete a profile subscription)
- DELETE VIRTUALFSMAPPING (Delete a virtual file space mapping)
- DELETE VOLHISTORY (Delete sequential volume history information)
- DELETE VOLUME (Delete a storage pool volume)

## DELETE ALERTTRIGGER (Remove a message from an alert trigger)

---

Use this command to remove a message from the list of alert triggers.

### Privilege class

---

To issue this command, you must have system privilege.

## Syntax

```
      .-'.-----'.  
      v          |  
>>-DELeTe ALERtTrigger-----message_number-----><
```

## Parameters

message\_number (Required)

Specifies the message number that you want to remove from the list of alert triggers. Specify multiple message numbers, which are separated by commas, and no intervening spaces. Message numbers are a maximum of eight characters in length. Wildcard characters can be used to specify message numbers.

## Delete alert trigger

Delete two message numbers that are designated as alerts, by issuing the following command:

```
delete alerttrigger ANR1067E,ANR1073E
```

## Related commands

Table 1. Commands related to DELETE ALERTTRIGGER

Command	Description
DEFINE ALERTTRIGGER (Define an alert trigger)	Associates specified messages to an alert trigger.
QUERY ALERTSTATUS (Query the status of an alert)	Displays information about alerts that have been issued on the server.
QUERY ALERTTRIGGER (Query the list of defined alert triggers)	Displays message numbers that trigger an alert.
QUERY MONITORSETTINGS (Query the configuration settings for monitoring alerts and server status)	Displays information about monitoring alerts and server status settings.
UPDATE ALERTTRIGGER (Update a defined alert trigger)	Updates the attributes of one or more alert triggers.
UPDATE ALERTSTATUS (Update the status of an alert)	Updates the status of a reported alert.

## DELETE ASSOCIATION (Delete the node association to a schedule)

Use this command to delete the association of a client node to a client schedule. IBM Spectrum Protect™ no longer runs the schedule on the client node.

If you try to disassociate a client from a schedule to which it is not associated, this command has no effect for that client.

## Privilege class

To issue this command, you must have one of the following privilege classes:

- System privilege
- Unrestricted policy privilege
- Restricted policy privilege for the domain to which the schedule belongs

## Syntax

```
>>-DELeTe ASSOCIation--domain_name--schedule_name----->  
  
      .-'.-----'.  
      v          |  
>-----node_name-----><
```

## Parameters

domain\_name (Required)

Specifies the name of the policy domain to which the schedule belongs.

schedule\_name (Required)

Specifies the name of the schedule from which clients are to be disassociated.

node\_name (Required)

Specifies the name of the client node that is no longer associated with the client schedule. You can specify a list of clients which are to be no longer associated with the specified schedule. Commas, with no intervening spaces, separate the items in the list. You can also use a wildcard character to specify a name. All matching clients are disassociated from the specified schedule.

## Example: Delete a node association to a schedule

To delete the association of the node JEFF, assigned to the DOMAIN1 policy domain, to the WEEKLY\_BACKUP schedule issue the following command:

```
delete association domain1 weekly_backup jeff
```

## Example: Delete a node association to a schedule using a wildcard for node selection

Delete the association of selected clients, assigned to the DOMAIN1 policy domain, to the WEEKLY\_BACKUP schedule so that this schedule is no longer run by these clients. The nodes that are disassociated from the schedule contain ABC or XYZ in the node name. Issue the command:

```
delete association domain1 weekly_backup *abc*,*xyz*
```

## Related commands

Table 1. Commands related to DELETE ASSOCIATION

Command	Description
DEFINE ASSOCIATION	Associates clients with a schedule.
QUERY ASSOCIATION	Displays the clients associated with one or more schedules.

## DELETE BACKUPSET (Delete a backup set)

Use this command to manually delete a backup set before its retention period expires.

When the server creates a backup set, the retention period assigned to the backup set determines how long the backup set remains in the database. When that date passes, the server automatically deletes the backup set when expiration processing runs. However, you can also manually delete the client's backup set from the server before it is scheduled to expire by using the DELETE BACKUPSET command.

Attention: If the volumes contain multiple backup sets, they are not returned to scratch status until all the backup sets are expired or are deleted.

## Privilege class

If the REQSYSAUTHOUTFILE server option is set to YES (the default), the administrator must have system privilege. If the REQSYSAUTHOUTFILE server option is set to NO, the administrator must have system privilege or policy privilege for the domain to which the client node is assigned.

## Syntax

```
      .-,-----  
      v |  
>>-DElete BACKUPSET-----+node_name-----+----->  
                          '-node_group_name-'  
      .-,-----
```

```

V
>-----backup_set_name+----->
                        '-BEGINDate-----date-'

>----->
                        '-BEGINTime-----time-'  '-ENDDate-----date-'

                        .-WHEREDATAType-----ALL-----
>----->
                        '-ENDTime-----time-' |           .- ,----- . |
                        |                       V               | |
                        '-WHEREDATAType-----+FILE--+--+-'
                        '-IMAGE-'

>----->
                        '-WHERERetention-----+days-----+-'
                        '-NOLimit-'

>----->
                        '-WHEREDESCRIPTION-----description-'

.-Preview ---No-----
>----->
                        '-Preview-----+No--+-'
                        '-Yes-'

```

## Parameters

node\_name or node\_group\_name (Required)

Specifies the name of the client nodes or node groups whose data is contained in the specified backup set volumes. To specify multiple node and node group names, separate the names with commas and no intervening spaces. Any node name you specify may contain wildcard characters, but node group names cannot contain wildcard characters. If backup set volumes contain backup sets from multiple nodes then every backup set whose node name matches one of the specified node names will be deleted.

backup\_set\_name (Required)

Specifies the name of the backup set to delete. The backup set name you specify can contain wildcard characters. You can specify more than one backup set name by separating the names with commas and no intervening spaces.

BEGINDate

Specifies the beginning date in which the backup set to delete was created. This parameter is optional. You can use this parameter with the BEGINTIME parameter to specify a range for the date and time. If you specify a begin date without a begin time, the time will be at 12:00 a.m. (midnight) on the date you specify.

You can specify the date by using one of the following values:

Value	Description	Example
MM/DD/YYYY	A specific date	09/15/1999
TODAY	The current date	TODAY
TODAY+days or +days	The current date plus days specified.	TODAY +3 or +3.
TODAY-days or -days	The current date minus days specified.	TODAY -3 or -3.
EOLM (End Of Last Month)	The last day of the previous month.	EOLM
EOLM-days	The last day of the previous month minus days specified.	EOLM-1  To include files that were active a day before the last day of the previous month.
BOTM (Beginning Of This Month)	The first day of the current month.	BOTM
BOTM+days	The first day of the current month, plus days specified.	BOTM+9  To include files that were active on the 10th day of the current month.

BEGINTime



Specifies the beginning time in which the backup set to delete was created. This parameter is optional. You can use this parameter in conjunction with the BEGINDATE parameter to specify a range for the date and time. If you specify a begin time without a begin date, the date will be the current date at the time you specify.

You can specify the time by using one of the following values:

Value	Description	Example
HH:MM:SS	A specific time	10:30:08
NOW	The current time	NOW
NOW+HH:MM <i>or</i> +HH:MM	The current time plus hours and minutes specified	NOW+02:00 <i>or</i> +02:00.
NOW-HH:MM <i>or</i> -HH:MM	The current time minus hours and minutes specified	NOW-02:00 <i>or</i> -02:00.

#### ENDDate

Specifies the ending date in which the backup set to delete was created. This parameter is optional. You can use this parameter in conjunction with the ENDTIME parameter to specify a range for the date and time. If you specify an end date without an end time, the time will be at 11:59:59 p.m. on the specified end date.

You can specify the date by using one of the following values:

Value	Description	Example
MM/DD/YYYY	A specific date	09/15/1999
TODAY	The current date	TODAY
TODAY+days <i>or</i> +days	The current date plus days specified.	TODAY +3 <i>or</i> +3.
TODAY-days <i>or</i> -days	The current date minus days specified.	TODAY -3 <i>or</i> -3.
EOLM (End Of Last Month)	The last day of the previous month.	EOLM
EOLM-days	The last day of the previous month minus days specified.	EOLM-1  To include files that were active a day before the last day of the previous month.
BOTM (Beginning Of This Month)	The first day of the current month.	BOTM
BOTM+days	The first day of the current month, plus days specified.	BOTM+9  To include files that were active on the 10th day of the current month.

#### ENDTime

Specifies the ending time of the range in which the backup set to delete was created. This parameter is optional. You can use this parameter in conjunction with the ENDDATE parameter to specify a range for the date and time. If you specify an end time without an end date, the date will be the current date at the time you specify.

You can specify the time by using one of the following values:

Value	Description	Example
HH:MM:SS	A specific time	10:30:08
NOW	The current time	NOW
NOW+HH:MM <i>or</i> +HH:MM	The current time plus hours and minutes on the specified end date	NOW+02:00 <i>or</i> +02:00.
NOW-HH:MM <i>or</i> -HH:MM	The current time minus hours and minutes on the specified end date	NOW-02:00 <i>or</i> -02:00.

#### WHEREDataType

Specifies the backup sets containing the specified types of data are to be deleted. This parameter is optional. The default is that backup sets for all types of data (file level, image, and application) are to be deleted. To specify multiple data types, separate the data types with commas and no intervening spaces. Possible values are:

#### ALL

Specifies that backup sets for all types of data (file level, image, and application) are to be deleted. This is the default.

**FILE**

Specifies that a file level backup set is to be deleted. File level backup sets contain files and directories backup up by the backup-archive client.

**IMAGE**

Specifies that an image backup set is to be deleted. Image backup sets contain images created by the backup-archive client BACKUP IMAGE command.

**WHERERetention**

Specifies the retention value, specified in days, that is associated with the backup sets to delete. You can specify an integer from 0 to 30000. The values are:

**days**

Specifies that backup sets that are retained this number of days are deleted.

**NOLimit**

Specifies that the backup sets that are retained indefinitely are deleted.

**WHEREDESCRIPTION**

Specifies the description that is associated with the backup set to delete. The description you specify can contain a wildcard character. This parameter is optional. Enclose the description in quotation marks if it contains any blank characters.

**Preview**

Specifies whether to preview the list of backup sets to delete, without actually deleting the backup sets. This parameter is optional. The default value is NO. The values are:

**No**

Specifies that the backup sets are deleted.

**Yes**

Specifies that the server displays the list of backup sets to delete, without actually deleting the backup sets.

## Example: Delete a backup set

---

Delete backup set named PERS\_DATA.3099 that belongs to client node JANE. The backup set was generated on 11/19/1998 at 10:30:05 and the description is "Documentation Shop".

```
delete backupset pers_data.3099
begindate=11/19/1998 begintime=10:30:05
wheredescription="documentation shop"
```

## Related commands

---

Table 1. Commands related to DELETE BACKUPSET

Command	Description
DEFINE BACKUPSET	Defines a previously generated backup set to a server.
DEFINE NODEGROUP	Defines a group of nodes.
DEFINE NODEGROUPMEMBER	Adds a client node to a node group.
DELETE NODEGROUP	Deletes a node group.
DELETE NODEGROUPMEMBER	Deletes a client node from a node group.
GENERATE BACKUPSET	Generates a backup set of a client's data.
GENERATE BACKUPSETTOC	Generates a table of contents for a backup set.
QUERY BACKUPSET	Displays backup sets.
QUERY NODEGROUP	Displays information about node groups.
QUERY BACKUPSETCONTENTS	Displays contents contained in backup sets.
UPDATE BACKUPSET	Updates a retention value associated with a backup set.
UPDATE NODEGROUP	Updates the description of a node group.

## DELETE CLIENTOPT (Delete an option in an option set)

---

Use this command to delete a client option in an option set.

## Privilege class

---

To issue this command, you must have system privilege, unrestricted policy privilege, or restricted policy privilege.

## Syntax

---

```
>>-DELEte CLIENTOpt--option_set_name--option_name----->
>--+-----+----->>
  '-SEQnumber-----number-+-'
      '-ALL-----'
```

## Parameters

---

- option\_set\_name (Required)  
Specifies the name of the client option set.
- option\_name (Required)  
Specifies a valid client option.
- SEQnumber  
Specifies a sequence number when an option name is specified more than once. This parameter is optional. Valid values are:
  - n  
Specifies an integer of 0 or greater.
  - ALL  
Specifies all sequence numbers.

## Example: Delete the date format option

---

Delete the date format option in an option set named *ENG*.

```
delete clientopt eng dateformat
```

## Related commands

---

Table 1. Commands related to DELETE CLIENTOPT

Command	Description
COPY CLOPTSET	Copies a client option set.
DEFINE CLIENTOPT	Adds a client option to a client option set.
DEFINE CLOPTSET	Defines a client option set.
DELETE CLOPTSET	Deletes a client option set.
QUERY CLOPTSET	Displays information about a client option set.
UPDATE CLIENTOPT	Updates the sequence number of a client option in a client option set.
UPDATE CLOPTSET	Updates the description of a client option set.

## DELETE CLOPTSET (Delete a client option set)

---

Use this command to delete a client option set.

## Privilege class

---

To issue this command, you must have system privilege, unrestricted policy privilege, or restricted policy privilege.

## Syntax

---

```
>>-DELEte CLOptset--option_set_name-----<<
```

## Parameters

---

`option_set_name` (Required)  
Specifies the name of the client option set to delete.

## Example: Delete a client option set

---

Delete the client option set named ENG.

```
delete cloptset eng
```

## Related commands

---

Table 1. Commands related to DELETE CLOPTSET

Command	Description
COPY CLOPTSET	Copies a client option set.
DEFINE CLIENTOPT	Adds a client option to a client option set.
DEFINE CLOPTSET	Defines a client option set.
DELETE CLIENTOPT	Deletes a client option from a client option set.
QUERY CLOPTSET	Displays information about a client option set.
UPDATE CLIENTOPT	Updates the sequence number of a client option in a client option set.
UPDATE CLOPTSET	Updates the description of a client option set.

## DELETE COLLOGROUP (Delete a collocation group)

---

Use this command to delete a collocation group. You cannot delete a collocation group if it has any members in it.

You can remove all the members in the collocation group by issuing the DELETE COLLOCMEMBER command with a wildcard in the `node_name` parameter.

## Privilege class

---

To issue this command, you must have system or unrestricted storage privilege.

## Syntax

---

```
>>-DELEte COLLOGGroup--group_name-----<<
```

## Parameters

---

`group_name`  
Specifies the name of the collocation group that you want to delete.

## Example: Delete a collocation group

---

Delete a collocation group named `group1`.

```
delete collocgroup group1
```

## Related commands

Table 1. Commands related to DELETE COLLOGROUP

Command	Description
DEFINE COLLOGROUP	Defines a collocation group.
DEFINE COLLOCMEMBER	Adds a client node or file space to a collocation group.
DEFINE STGPOOL	Defines a storage pool as a named collection of server storage media.
DELETE COLLOCMEMBER	Deletes a client node or file space from a collocation group.
MOVE NODEDATA	Moves data for one or more nodes, or a single node with selected file spaces.
QUERY COLLOGROUP	Displays information about collocation groups.
QUERY NODE	Displays partial or complete information about one or more clients.
QUERY NODEDATA	Displays information about the location and size of data for a client node.
QUERY STGPOOL	Displays information about storage pools.
REMOVE NODE	Removes a client from the list of registered nodes for a specific policy domain.
UPDATE COLLOGROUP	Updates the description of a collocation group.
UPDATE STGPOOL	Changes the attributes of a storage pool.

## DELETE COLLOCMEMBER (Delete collocation group member)

Use this command to delete a client node or file space from a collocation group.

### Privilege class

To issue this command, you must have system or unrestricted storage privilege.

### Syntax

Delete a node from a collocation group

```
                .-,-----  
                v          |  
>>-DELEte COLLOCMember--group_name----node_name-+-----<<
```

### Parameters

**group\_name**

Specifies the name of the collocation group from which you want to delete a client node.

**node\_name**

Specifies the name of the client node that you want to delete from the collocation group. You can specify one or more names. When you specify multiple names, separate the names with commas; do not use intervening spaces. You can also use wildcard characters to specify multiple nodes.

Delete a file space from a file space collocation group

```
>>-DELEte COLLOCMember--group_name--node_name----->
```

```
                .-,-----  
                v          |  
>--Filespace-----file_space_name-+----->
```

```

.-NAMEType-----SERVER----- .
>---+-----+-----+-----+----->
' -NAMEType-----+ -SERVER--+- '
      +-UNICODE-+
      '-FSID----- '

.-CODEType-----BOTH----- .
>---+-----+-----+-----+-----><
' -CODEType-----+ -BOTH-----+- '
      +-UNICODE-----+
      '-NONUNICODE- '

```

## Parameters

---

### group\_name

Specifies the name of the collocation group from which you want to delete a file space.

### node\_name

Specifies the client node where the file space is located.

### FILESpace

Specifies the *file\_space\_name* on the client node that you want to delete from the collocation group. You can specify one or more file space names that are on a specific client node. If you specify multiple file space names, separate the names with commas, and do not use intervening spaces. You can also use wildcard characters when you specify multiple file space names.

### NAMEType

Specify how you want the server to interpret the file space names that you enter. This parameter is useful when the server has clients with Unicode support. A backup-archive client with Unicode support is available only for Windows, Macintosh OS 9, Macintosh OS X, and NetWare. Use this parameter when you specify a file space name that is not a single wildcard. You can specify a fully qualified file space name, which does not have a wildcard. Or you can specify a partly qualified file space name, which can have a wildcard but must contain other characters. The default value is SERVER. Possible values are

#### SERVER

The server uses the server code page to interpret the file space names.

#### UNICODE

The server converts the file space names from the server code page to the UTF-8 code page. The success of the conversion depends on the actual characters in the names and the server code page. Conversion might fail if the string includes characters that are not available in the server code page, or if the server cannot access system conversion routines.

#### FSID

The server interprets the file space names by their file space IDs (FSIDs).

### CODEType

Specify how you want the server to interpret the file space names that you enter. Use this parameter only when you use a single wildcard character for the file space name. The default is BOTH, so the file spaces are included, regardless of code page type. The following values are available:

#### BOTH

Include the file spaces, regardless of code page type.

#### UNICODE

Include file spaces that are in Unicode only.

#### NONUNICODE

Include file spaces that are not in Unicode.

## Delete collocation group members

---

Delete two nodes, NODE1 and NODE2, from a collocation group, GROUP1.

```
delete collocmember group1 node1,node2
```

## Delete a file space from a file space collocation group

---

Issue the following command to delete file space *cap\_27400* from collocation group *collgrp\_2* on node *hp\_4483*:

```
delete collocmember collgrp_2 hp_4483 filespace=cap_27400
```

## Delete a file space collocation group member from a node that uses Unicode

If the file space is on a node that uses Unicode, you can specify that in the command. Issue the following command to delete file space *cap\_257* from collocation group *collgrp\_3* from the *win\_4687* node:

```
delete collocmember collgrp_3 win_4687 filespace=cap_257 codetype=unicode
```

## Delete a file space with a partial name designated

If the file space has a partial name, you can use a wildcard to delete it. Issue the following command to delete file space *cap\_* from collocation group *collgrp\_4* from *win\_4687* node:

```
delete collocmember collgrp_4 win_4687 filespace=cap_* codetype=unicode
```

If there is more than one file space whose name begins with *cap\_*, those file spaces are also deleted.

## Related commands

Table 1. Commands related to DELETE COLLOCMEMBER

Command	Description
DEFINE COLLOGROUP	Defines a collocation group.
DEFINE COLLOCMEMBER	Adds a client node or file space to a collocation group.
DEFINE STGPOOL	Defines a storage pool as a named collection of server storage media.
DELETE COLLOGROUP	Deletes a collocation group.
DELETE FILESPACE	Deletes data associated with client file spaces. If a file space is part of a collocation group and you remove the file space from a node, the file space is removed from the collocation group.
MOVE NODEDATA	Moves data for one or more nodes, or a single node with selected file spaces.
QUERY COLLOGROUP	Displays information about collocation groups.
QUERY NODE	Displays partial or complete information about one or more clients.
QUERY NODEDATA	Displays information about the location and size of data for a client node.
QUERY STGPOOL	Displays information about storage pools.
REMOVE NODE	Removes a client from the list of registered nodes for a specific policy domain.
UPDATE COLLOGROUP	Updates the description of a collocation group.
UPDATE STGPOOL	Changes the attributes of a storage pool.

## DELETE COPYGROUP (Delete a backup or archive copy group)

Use this command to delete a backup or archive copy group from a management class. You cannot delete a copy group in the ACTIVE policy set.

When you activate the changed policy set, any files that are bound to a deleted copy group are managed by the default management class.

You can delete the predefined STANDARD copy group in the STANDARD policy domain (STANDARD policy set, STANDARD management class). However, if you later reinstall the IBM Spectrum Protect™ server, the process restores all STANDARD policy objects.

## Privilege class

To issue this command, you must have system privilege, unrestricted policy privilege, or restricted policy privilege for the policy domain to which the copy group belongs.

## Syntax

```
>>-DELEte COpYgroup--domain_name--policy_set_name--class_name--->
      .-STANDARD-.  .-Type-----Backup-----.
>-----+-----+-----+-----+-----+-----+----->>
      '-STANDARD-'  '-Type-----+Backup--+-'
                          '-Archive-'
```

## Parameters

domain\_name (Required)

Specifies the policy domain to which the copy group belongs.

policy\_set\_name (Required)

Specifies the policy set to which the copy group belongs.

class\_name (Required)

Specifies the management class to which the copy group belongs.

STANDARD

Specifies the copy group, which is always STANDARD. This parameter is optional. The default value is STANDARD.

Type

Specifies the type of copy group to delete. This parameter is optional. The default value is BACKUP. Possible values are:

Backup

Specifies that the backup copy group is deleted.

Archive

Specifies that the archive copy group is deleted.

## Example: Delete a backup copy group

Delete the backup copy group from the ACTIVEFILES management class that is in the VACATION policy set of the EMPLOYEE\_RECORDS policy domain.

```
delete copygroup employee_records
vacation activefiles
```

## Example: Delete an archive copy group

Delete the archive copy group from the MCLASS1 management class that is in the SUMMER policy set of the PROG1 policy domain.

```
delete copygroup progl summer mclass1 type=archive
```

## Related commands

Table 1. Commands related to DELETE COPYGROUP

Command	Description
DEFINE COPYGROUP	Defines a copy group for backup or archive processing within a specified management class.
QUERY COPYGROUP	Displays the attributes of a copy group.
UPDATE COPYGROUP	Changes one or more attributes of a copy group.

## DELETE DATAMOVER (Delete a data mover)

Use this command to delete a data mover. You cannot delete the data mover if any paths are defined for this data mover.



## Privilege class

To issue this command, you must have system privilege or unrestricted storage privilege.

## Syntax

```
>>-DELEte DATAMover--data_mover_name-----><
```

## Parameters

data\_mover\_name (Required)

Specifies the name of the data mover.

Note: This command deletes the data mover even if there is data for the corresponding NAS node.

## Example: Delete a data mover

Delete the data mover for the node named NAS1.

```
delete datamover nas1
```

## Related commands

Table 1. Commands related to DELETE DATAMOVER

Command	Description
DEFINE DATAMOVER	Defines a data mover to the IBM Spectrum Protect server.
DEFINE PATH	Defines a path from a source to a destination.
DELETE PATH	Deletes a path from a source to a destination.
QUERY DATAMOVER	Displays data mover definitions.
QUERY PATH	Displays information about the path from a source to a destination.
UPDATE DATAMOVER	Changes the definition for a data mover.

AIX Linux Windows

## DELETE DEDUPSTATS (Delete data deduplication statistics)

Use this command to delete data deduplication statistics for a directory-container storage pool or a cloud storage pool. You cannot delete the most recent data deduplication statistics for a client node and a file space.

## Privilege class

To issue this command, you must have system privilege, unrestricted storage privilege, or restricted storage privilege for the storage pool.

## Syntax

```
>>-DELEte DEDUPStats--pool_name--+-----+----->
                                     '-node_name-'

.-*------. .-CODEType---BOTH-----
>--+-----+-----+----->
| .-,------. | '-CODEType---+UNICODE---+'
| V             | |               +-NONUNICODE+
+---file_space_name---+               '-BOTH-----'
| .-,------. |
| V             | |
|-----FSID---+-----|
```

```

.-NAMEType---SERVER-----
>-----+-----+-----+-----+-----+-----+----->
'-NAMEType---SERVER--+' '-TODate----date-'
      +-UNICODE-+
      '-FSID----'

>-----+-----+-----+-----+-----+-----+----->>
'-TOTime----time-'

```

## Parameters

---

### pool\_name (Required)

Specifies the name of the directory-container storage pool that is reported in the data deduplication statistics. You can specify up to 30 characters for the storage pool name. If you specify more than 30 characters the command fails.

Restriction: You can only specify directory-container storage pools or cloud storage pools.

### node\_name

Specifies the name of the client node that is reported in the data deduplication statistics. This parameter is optional. If you do not specify a value for this parameter, all nodes are displayed. You can specify up to 64 characters for the node name. If you specify more than 64 characters the command fails.

### filesystem\_name or FSID

Specifies the name or file space ID (FSID) of one or more file spaces that is reported in the data deduplication statistics. This parameter is optional. You can use wildcard characters to specify this name. An asterisk is the default. Specify one of the following values:

\*

Specify an asterisk (\*) to show all file spaces or IDs.

### filesystem\_name

Specifies the name of the file space. Specify more than one file space by separating the names with commas and no intervening spaces. FSID Specifies the file space identifier. This parameter is valid for clients with file spaces that are in Unicode format. Specify more than one file space by separating the names with commas and no intervening spaces.

For clients with file spaces that are in Unicode format, you can enter either a file space name or a FSID. If you enter a file space name, the server might have to convert the file space name that you enter. For example, the server might have to convert the name that you enter from the server's code page to Unicode.

Restrictions: The following restrictions apply to file space names and file space identifiers (FSID):

- You must specify a node name if you specify a file space name.
- Do not specify both file space names and FSIDs on the same command.

### CODEType

Specifies what type of file spaces to include in the report. The default value is BOTH, which specifies that file spaces are included regardless of code page type. Use this parameter only when you enter an asterisk to display information about all file spaces. This parameter is optional. Specify one of the following values:

#### UNICODE

Include file spaces that are in Unicode format.

#### NONUNICODE

Include file spaces that are not in Unicode format.

#### BOTH

Include file spaces regardless of code page type. This is the default.

### NAMEType

Specifies how you want the server to interpret the file space names that you enter. Use this parameter when IBM Spectrum Protect™ clients have file spaces that are in Unicode format, and are on Windows, NetWare, or Macintosh OS X operating systems. This parameter is optional.

This parameter is required if you specify a node name and a file space name or FSID.

Restriction: When you specify this parameter, the file space name cannot contain an asterisk.

Specify one of the following values:

#### SERVER

The server uses the server's code page to interpret the file space names. This is the default.

#### UNICODE

The server converts the file space name that is entered from the server code page to the UTF-8 code page. The success of the conversion depends on the actual characters in the name and the server's code page. Conversion can fail if the string includes characters that are not available in the server code page, or if the server cannot access system conversion routines.

#### FSID

The server interprets the file space names as their file space IDs (FSIDs).

#### TODate

Specifies the latest date for statistics to be deleted. IBM Spectrum Protect deletes only those statistics with a date on or before the date you specify. This parameter is optional.

Specify one of the following values:

Value	Description	Example
MM/DD/YYYY	A specific date.	10/15/2015  If you specify a date, all candidate records that are written on that day (ending at 11:59:59 pm) will be evaluated.
TODAY	The current date.	TODAY
TODAY-days or -days	The current date minus days specified. The maximum number of days you can specify is 9999.	TODAY-1 or -1.  To display information that is created until yesterday, you can specify TODATE=TODAY-1 or TODATE= -1.
EOLM (End Of Last Month)	The last day of the previous month.	EOLM
EOLM-days	The last day of the previous month minus days specified.	EOLM-1  To include records that were active a day before the last day of the previous month.
BOTM (Beginning Of This Month)	The first day of the current month.	BOTM
BOTM+days	The first day of the current month, plus days specified.	BOTM+9  To include records that were active on the 10th day of the current month.

#### TOTime

Specifies that you want to delete data deduplication statistics that are created on or before this time on the specified date. This parameter is optional. The default is the end of the day (23:59:59). Specify one of the following values:

Value	Description	Example
HH:MM:SS	A specific time on the specified date.	12:30:22
NOW	The current time on the specified date.	NOW
NOW+HH:MM or +HH:MM	The current time plus hours and minutes on the specified date.	NOW+03:00 or +03:00.  If you issue the DELETE DEDUPSTATS command at 9:00 with TOTIME=NOW+03:00 or TOTIME=+03:00, IBM Spectrum Protect deletes records with a time of 12:00 or earlier on the specified date.
NOW-HH:MM or -HH:MM	The current time minus hours and minutes on the specified date.	NOW-03:30 or -03:30.  If you issue the DELETE DEDUPSTATS command at 9:00 with TOTIME=NOW-3:30 or TOTIME=-3:30, IBM Spectrum Protect deletes records with a time of 5:30 or earlier on the specified date.

### Example: Delete data deduplication statistics for a file space

Delete data deduplication statistics of a file space that is called /srvr that belongs to a directory-container storage pool, POOL1, that is stored on client node NODE1.

```
delete dedupstats pool1 node1 /srvr
```

## Related commands

Table 1. Commands related to DELETE DEDUPSTATS

Command	Description
GENERATE DEDUPSTATS	Generates data deduplication statistics.
<b>AIX</b>   <b>Linux</b>   <b>Windows</b> QUERY DEDUPSTATS	Displays data deduplication statistics.

## DELETE DEVCLASS (Delete a device class)

Use this command to delete a device class.

To use this command, you must first delete all storage pools that are assigned to the device class and, if necessary, cancel any database export or import processes that are using the device class.

You cannot delete the device class DISK, which is predefined at installation, but you can delete any device classes defined by the IBM Spectrum Protect™ administrator.

## Privilege class

To issue this command, you must have system privilege or unrestricted storage privilege.

## Syntax

```
>>--DELEte DEVclass--device_class_name-----<<
```

## Parameters

`device_class_name` (Required)  
Specifies the name of the device class to be deleted.

## Example: Delete a device class

Delete the device class named MYTAPE. There are no storage pools assigned to the device class.

```
delete devclass mytape
```

## Related commands

Table 1. Commands related to DELETE DEVCLASS

Command	Description
DEFINE DEVCLASS	Defines a device class.
<b>AIX</b>   <b>Linux</b> DEFINE DEVCLASS (z/OS® media server)	<b>AIX</b>   <b>Linux</b> Defines a device class to use storage managed by a z/OS media server.
QUERY DEVCLASS	Displays information about device classes.
QUERY DIRSPACE	Displays information about FILE directories.
UPDATE DEVCLASS	Changes the attributes of a device class.
<b>AIX</b>   <b>Linux</b> UPDATE DEVCLASS (z/OS media server)	<b>AIX</b>   <b>Linux</b> Changes the attributes of a device class for storage managed by a z/OS media server.

## DELETE DOMAIN (Delete a policy domain)

---

Use this command to delete a policy domain. All associated policy sets, including the ACTIVE policy set, management classes, and copy groups are deleted along with the policy domain.

You cannot delete a policy domain to which client nodes are registered. To determine if any client nodes are registered to a policy domain, issue the QUERY DOMAIN or the QUERY NODE command. Move any client nodes to another policy domain, or delete the nodes.

You can delete the predefined STANDARD policy domain. However, if you later reinstall the IBM Spectrum Protect™ server, the process restores all STANDARD policy objects.

### Privilege class

---

To issue this command, you must have system privilege.

### Syntax

---

```
>>-DELEte Domain--domain_name-----><
```

### Parameters

---

domain\_name (Required)  
Specifies the policy domain to delete.

### Examples: Delete a policy domain

---

Delete the EMPLOYEE\_RECORDS policy domain.

```
delete domain employee_records
```

### Related commands

---

Table 1. Commands related to DELETE DOMAIN

Command	Description
COPY DOMAIN	Creates a copy of a policy domain.
DEFINE DOMAIN	Defines a policy domain that clients can be assigned to.
QUERY DOMAIN	Displays information about policy domains.
UPDATE DOMAIN	Changes the attributes of a policy domain.

## DELETE DRIVE (Delete a drive from a library)

---

Use this command to delete a drive from a library. A drive that is in use cannot be deleted.

All paths related to a drive must be deleted before the drive itself can be deleted.

### Privilege class

---

To issue this command, you must have system privilege or unrestricted storage privilege.

### Syntax

---

```
>>-DELEte DRive--library_name--drive_name-----><
```

### Parameters

---

library\_name (Required)  
 Specifies the name of the library where the drive is located.

drive\_name (Required)  
 Specifies the name of the drive to be deleted.

## Example: Delete a drive from a library

Delete DRIVE3 from the library named AUTO.

```
delete drive auto drive3
```

## Related commands

Table 1. Commands related to DELETE DRIVE

Command	Description
DEFINE DRIVE	Assigns a drive to a library.
DEFINE LIBRARY	Defines an automated or manual library.
DELETE LIBRARY	Deletes a library.
DELETE PATH	Deletes a path from a source to a destination.
PERFORM LIBACTION	Defines all drives and paths for a library.
QUERY DRIVE	Displays information about drives.
QUERY LIBRARY	Displays information about one or more libraries.
UPDATE DRIVE	Changes the attributes of a drive.

## DELETE EVENT (Delete event records)

Use this command to delete event records from the database. An event record is created whenever processing of a scheduled command is started or missed.

This command only deletes the event records that exist at the time the command is processed. An event record will not be found:

- If the event record has never been created (the event is scheduled for the future)
- If the event has passed and the event record has already been deleted.

## Privilege class

To issue this command, you must have system privilege or unrestricted policy privilege.

## Syntax

```

      .-00:00-.
>>-DELeTe EVenT--date--+-----+----->
      '-time--'

.-TYPE----Client-----
>--+-----+-----><
  '-TYPE-----+Client-----+'
      +-Administrative+
      '-All-----'
```

## Parameters

date (Required)  
 Specifies the date used to determine which event records to delete. The maximum number of days you can specify is 9999.

Use this parameter in conjunction with the TIME parameter to specify a date and time for deleting event records. Any record whose scheduled start occurs before the specified date and time is deleted. However, records are not deleted for

events whose startup window has not yet passed.

You can specify the date by using one of the following values:

Value	Description	Example
MM/DD/YYYY	A specific date	09/15/1998
TODAY	The current date	TODAY
TODAY-days <i>or</i> -days	The current date minus days specified	TODAY-3 <i>or</i> -3.
EOLM (End Of Last Month)	The last day of the previous month.	EOLM
EOLM-days	The last day of the previous month minus days specified.	EOLM-1  To include files that were active a day before the last day of the previous month.
BOTM (Beginning Of This Month)	The first day of the current month.	BOTM
BOTM+days	The first day of the current month, plus days specified.	BOTM+9  To include files that were active on the 10th day of the current month.

time

Specifies the time used to determine which event records to delete. Use this parameter in conjunction with the DATE parameter to specify a date and time for deleting event records. Any record whose scheduled start occurs before the specified date and time is deleted. However, records are not deleted for events whose startup window has not yet passed. The default is 00:00.

You can specify the time by using one of the following values:

Value	Description	Example
HH:MM:SS	A specific time	10:30:08
NOW	The current time	NOW
NOW+HH:MM <i>or</i> +HH:MM	The current time plus hours and minutes specified	NOW+03:00 <i>or</i> +03:00 Attention: If you issue this command at 9:00 using NOW+03:00 <i>or</i> +03:00, IBM Spectrum Protect™ deletes records with a time of 12:00 or later on the date you specify.
NOW-HH:MM <i>or</i> -HH:MM	The current time minus hours and minutes specified	NOW-03:00 <i>or</i> -03:00

TYPE

Specifies the type of events to be deleted. This parameter is optional. The default is CLIENT. Possible values are:

Client

Specifies to delete event records for client schedules.

Administrative

Specifies to delete event records for administrative command schedules.

ALL

Specifies to delete event records for both client and administrative command schedules.

## Example: Delete event records

Delete records for events with scheduled start times prior to 08:00 on May 26, 1998 (05/26/1998), and whose startup window has passed. Records for these events are deleted regardless of whether the retention period for event records, as specified with the SET EVENTRETENTION command, has passed.

```
delete event 05/26/1998 08:00
```

## Related commands

Table 1. Commands related to DELETE EVENT

Command	Description
QUERY EVENT	Displays information about scheduled and completed events for selected clients.
SET EVENTRETENTION	Specifies the number of days to retain records for scheduled operations.

## DELETE EVENTSERVER (Delete the definition of the event server)

Use this command to delete the definition of the event server. You must issue this command before you issue the DELETE SERVER command. If you specify the server defined as the event server on the DELETE SERVER command, you will receive an error message.

### Privilege class

To issue this command, you must have system privilege.

### Syntax

```
>>-DELEte EVENTSEr-----><
```

### Example: Delete an event server definition

Delete the definition for the event server ASTRO.

```
delete eventserver
```

### Related commands

Table 1. Commands related to DELETE EVENTSERVER

Command	Description
DEFINE EVENTSERVER	Defines a server as an event server.
QUERY EVENTSERVER	Displays the name of the event server.

## DELETE FILESPACE (Delete client node data from the server)

Use this command to delete file spaces from the server. Files that belong to the file space are deleted from primary, active-data, and copy storage pools, and any file space collocation groups.

IBM Spectrum Protect™ deletes one or more file spaces as a series of batch database transactions, thus preventing a rollback or commit for an entire file space as a single action. If the process is canceled or if a system failure occurs, a partial deletion can occur. A subsequent DELETE FILESPACE command for the same node or owner can delete the remaining data.

If this command is applied to a WORM (write once, read many) volume, the volume is returned to scratch if it has space on which data can be written. (Data on WORM volumes, including deleted and expired data, cannot be overwritten. Therefore, data can be written only in space that does not contain current, deleted, or expired data.) If a WORM volume does not have any space available on which data can be written, it remains private. To remove the volume from the library, you must use the CHECKOUT LIBVOLUME command.

Tips:

- If archive retention protection is enabled, the server deletes archive files with expired retention periods. For more information, see the SET ARCHIVERETENTIONPROTECTION command.
- The server does not delete archive files that are on deletion hold until the hold is released.
- Reclamation does not start while the DELETE FILESPACE command is running.
- If a file space is part of a collocation group and you remove the file space from a node, the file space is removed from the collocation group.



- If you delete a file space in a deduplicated storage pool, the file space name DELETED is displayed in the output of the QUERY OCCUPANCY command until all deduplication dependencies are removed.
- When replication is configured for a file space, the DELETE FILESPACE command deletes only the file space on the server where you issued the command. If you issue the REPLICATE NODE command, the file space is not deleted on the other replication server.

## Privilege class

To issue this command, you must have system privilege, unrestricted policy privilege, or restricted policy privilege for the policy domain to which the client node is assigned.

## Syntax

```
>>-DELEte Filespace--node_name--file_space_name----->
. -Type-----ANY----- . -Data-----ANY-----
>--+-----+-----+-----+-----+-----+----->
' -Type-----+ANY-----+ ' -Data-----+ANY-----+ '
      +-Backup-----+          +-Files-----+
      +-ARchive-----+          |          (1) |
      +-SPacemanaged--+          '-IMages-----'
      '-SERver-----'

. -Wait-----No----- .
>--+-----+-----+-----+-----+-----+----->
' -Wait-----+No--+-' ' -OWNer-----owner_name-'
      '-Yes-'

. -NAMEType-----SERVER----- .
>--+-----+-----+-----+-----+-----+----->
' -NAMEType-----+SERVER--+ '
      +-UNICode-+
      '-FSID----'

. -CODEType-----BOTH----- .
>--+-----+-----+-----+-----+-----+-----><
' -CODEType-----+UNICode-----+ '
      +-NONUNICode-+
      '-BOTH-----'

```

Notes:

1. This parameter can be used only when TYPE=ANY or TYPE=BACKUP is specified.

## Parameters

node\_name (Required)

Specifies the name of the client node to which the file space belongs.

file\_space\_name (Required)

Specifies the name of the file space to be deleted. This name is case-sensitive and must be entered exactly as it is known to the server. To determine how to enter the name, use the QUERY FILESPACE command. You can use wildcard characters to specify this name.

For a server that has clients with support for Unicode, you might have the server convert the file space name that you enter. For example, you might want to have the server convert the name that you entered from the server's code page, to Unicode. See the NAMETYPE parameter for details. If you do not specify a file space name, or specify only a single wildcard character for the name, you can use the CODETYPE parameter to limit the operation to Unicode file spaces or to non-Unicode file spaces.

Type

Specifies the type of data to be deleted. This parameter is optional. The default value is ANY. You can use the following values:

ANY

Delete only backed-up versions of files and archived copies of files.

If you specify `delete filespace node_name * type=any`, all backed-up data and archived data in all file spaces for that node are deleted. File spaces are deleted only if they do not contain files that are moved from an IBM Spectrum Protect for Space Management client.

#### Backup

Delete backup data for the file space.

#### ARchive

Delete all archived data on the server for the file space.

#### SPacemanaged

Delete files that are migrated from a user's local file system by an IBM Spectrum Protect for Space Management client. The OWNER parameter is ignored when you specify TYPE=SPACEMANAGED.

#### SERver

Delete all archived files in all file spaces for a node that is registered as TYPE=SERVER.

#### DAta

Specifies objects to delete. This parameter is optional. The default value is ANY. You can specify one of the following values:

##### ANY

Delete files, directories, and images.

##### FIles

Delete files and directories.

##### IMages

Delete image objects. You can use this parameter only if you specified TYPE=ANY or TYPE=BACKUP.

#### Wait

Specifies whether to wait for the server to complete processing this command in the foreground. This parameter is optional. The default value is No. You can specify one of the following values:

##### No

Specifies that the server processes this command in the background. You can continue with other tasks while the command is being processed.

Messages that are created from the background process are displayed either in the activity log or the server console, depending on where messages are logged.

##### Yes

Specifies that the server processes this command in the foreground. Wait for the command to complete before you continue with other tasks. The server displays the output messages to the administrative client when the command completes.

Restriction: You cannot specify WAIT=YES from the server console.

#### OWNer

Restricts the data that is deleted to files that belong to the owner. This parameter is optional; it is ignored when TYPE=SPACEMANAGED. This parameter applies to only multiuser client systems such as AIX®, Linux, and Solaris OS.

#### NAMEType

Specify how you want the server to interpret the file space names that you enter. This parameter is useful when the server has clients with support for Unicode. A backup-archive client with support for Unicode is available only for the following operating systems: Windows, Macintosh OS X, and NetWare operating systems.

Use this parameter only when you enter a partly or fully qualified file space name. The default value is SERVER. You can specify one of the following values:

##### SERVER

The server uses the server's code page to interpret the file space names.

##### UNIcode

The server converts the file space names from the server code page to the UTF-8 code page. The success of the conversion depends on the actual characters in the name and the server's code page. Conversion can fail if the string includes characters that are not available in the server code page or if the server cannot access system conversion routines.

##### FSID

The server interprets the file space names as their file space IDs (FSIDs).

#### CODEType

Specify what type of file spaces are to be included in the operation. The default is BOTH, meaning that file spaces are included regardless of code page type. Use this parameter only when you enter a single wildcard character for the file space name. You can specify one of the following values:

- UNICODE  
Include file spaces that are in Unicode.
- NONUNICODE  
Include file spaces that are not in Unicode.
- BOTH  
Include file spaces regardless of code page type.

## Delete a file space

---

Delete the C\_Drive file space that belongs to the client node HTANG.

```
delete filesystem htang C_Drive
```

## Delete all space-managed files for a client node

---

Delete all files that are migrated from client node APOLLO (that is, all space-managed files).

```
delete filesystem apollo * type=spacemanaged
```

## Related commands

---

Table 1. Commands related to DELETE FILESPACE

Command	Description
CANCEL PROCESS	Cancel a background server process.
QUERY ACTLOG	Displays messages from the server activity log.
QUERY FILESPACE	Displays information about data in file spaces that belong to a client.
QUERY OCCUPANCY	Displays file space information by storage pool.
QUERY PROCESS	Displays information about background processes.
REMOVE NODE	Removes a client from the list of registered nodes for a specific policy domain.
RENAME FILESPACE	Renames a client filesystem on the server.

## DELETE GRPMEMBER (Delete a server from a server group)

---

Use this command to delete a server or server group from a server group.

### Privilege class

---

To issue this command, you must have system privilege.

### Syntax

---

```
>>-DELEte GRPMEMber--group_name---member_name+-----><
```

### Parameters

---

- group\_name (Required)  
Specifies the group.
- member\_name (Required)

Specifies the server or group to delete from the group. To specify multiple names, separate the names with commas and no intervening spaces.

## Example: Delete a server from a server group

---

Delete member PHOENIX from group WEST\_COMPLEX.

```
delete grpmember west_complex phoenix
```

## Related commands

---

Table 1. Commands related to DELETE GRPMEMBER

Command	Description
DEFINE GRPMEMBER	Defines a server as a member of a server group.
DEFINE SERVERGROUP	Defines a new server group.
DELETE SERVER	Deletes the definition of a server.
DELETE SERVERGROUP	Deletes a server group.
MOVE GRPMEMBER	Moves a server group member.
QUERY SERVER	Displays information about servers.
QUERY SERVERGROUP	Displays information about server groups.
RENAME SERVERGROUP	Renames a server group.
UPDATE SERVERGROUP	Updates a server group.

## DELETE LIBRARY (Delete a library)

---

Use this command to delete a library. Before you delete a library, you must delete other associated objects, such as the path.

Use this command to delete a library. Before you delete a library, delete the path and all associated drives.

## Privilege class

---

To issue this command, you must have system privilege or unrestricted storage privilege.

## Syntax

---

```
>>-DELeTe LIBRary--library_name-----<<
```

## Parameters

---

library\_name (Required)

Specifies the name of the library to be deleted.

## Example: Delete a manual library

---

Delete the manual library named LIBR1.

```
delete library libr1
```

## Related commands

---

Table 1. Commands related to DELETE LIBRARY

Command	Description
DEFINE DRIVE	Assigns a drive to a library.

Command	Description
DEFINE LIBRARY	Defines an automated or manual library.
DEFINE PATH	Defines a path from a source to a destination.
DELETE DRIVE	Deletes a drive from a library.
DELETE PATH	Deletes a path from a source to a destination.
PERFORM LIBACTION	Defines all drives and paths for a library.
QUERY DRIVE	Displays information about drives.
QUERY LIBRARY	Displays information about one or more libraries.
QUERY PATH	Displays information about the path from a source to a destination.
UPDATE DRIVE	Changes the attributes of a drive.
UPDATE LIBRARY	Changes the attributes of a library.
UPDATE PATH	Changes the attributes associated with a path.

## DELETE MACHINE (Delete machine information)

Use this command to delete machine description information. To replace existing information, issue this command and then issue an INSERT MACHINE command.

### Privilege class

To issue this command, you must have system privilege.

### Syntax

```
>>-DELEte MACHine--machine_name----->
. -Type----All-----
>--+-----+----->>
' -Type----++All-----+'
      +-RECOVERYInstructions+
      '-Characteristics-----'
```

### Parameters

machine\_name (Required)

Specifies the name of the machine whose information is to be deleted.

Type

Specifies the type of machine information. This parameter is optional. The default is ALL. Possible values are:

All

Specifies all information.

RECOVERYInstructions

Specifies the recovery instructions.

Characteristics

Specifies the machine characteristics.

### Example: Delete a specific machine's information

Delete the machine characteristics associated with the DISTRICT5 machine.

```
delete machine district5 type=characteristics
```

### Related commands

Table 1. Commands related to DELETE MACHINE

Command	Description
DEFINE MACHINE	Defines a machine for DRM.
INSERT MACHINE	Inserts machine characteristics or recovery instructions into the IBM Spectrum Protect™ database.
QUERY MACHINE	Displays information about machines.
QUERY RECOVERYMEDIA	Displays media available for machine recovery.
UPDATE MACHINE	Changes the information for a machine.

## DELETE MACHNODEASSOCIATION (Delete association between a machine and a node)

Use this command to delete the association between a machine and one or more nodes. This command does not delete the node from IBM Spectrum Protect™.

### Privilege class

To issue this command, you must have system privilege.

### Syntax

```

      .-------.
      v           |
>>-DELeTe MACHNODEAssociation--machine_name----node_name+-----><

```

### Parameters

machine\_name (Required)

Specifies the name of a machine that is associated with one or more nodes.

node\_name (Required)

Specifies the name of a node associated with a machine. If you specify a list of node names, separate the names with commas and no intervening spaces. You can use wildcard characters to specify a name. If a node is not associated with the machine, that node is ignored.

### Example: Delete an association between a node and a machine

Delete the association between the DISTRICT5 machine and the ACCOUNTSPAYABLE node.

```
delete machnodeassociation district5 accountspayable
```

### Related commands

Table 1. Commands related to DELETE MACHNODEASSOCIATION

Command	Description
DEFINE MACHNODEASSOCIATION	Associates an IBM Spectrum Protect node with a machine.
QUERY MACHINE	Displays information about machines.

## DELETE MGMTCLASS (Delete a management class)

Use this command to delete a management class. You cannot delete a management class in the ACTIVE policy set. All copy groups in the management class are deleted along with the management class.

You can delete the management class assigned as the default for a policy set, but a policy set cannot be activated unless it has a default management class.

You can delete the predefined STANDARD management class in the STANDARD policy domain. However, if you later reinstall the IBM Spectrum Protect™ server, the process restores all STANDARD policy objects.

## Privilege class

---

To issue this command, you must have system privilege, unrestricted policy privilege, or restricted policy privilege for the policy domain to which the management class belongs.

## Syntax

---

```
>>-DELEte MGmtclass--domain_name--policy_set_name--class_name--<<
```

## Parameters

---

- domain\_name (Required)  
Specifies the policy domain to which the management class belongs.
- policy\_set\_name (Required)  
Specifies the policy set to which the management class belongs.
- class\_name (Required)  
Specifies the management class to delete.

## Example: Delete a management class

---

Delete the ACTIVEFILES management class from the VACATION policy set of the EMPLOYEE\_RECORDS policy domain.

```
delete mgmtclass employee_records  
vacation activefiles
```

## Related commands

---

Table 1. Commands related to DELETE MGMTCLASS

Command	Description
ASSIGN DEFMGMTCLASS	Assigns a management class as the default for a specified policy set.
COPY MGMTCLASS	Creates a copy of a management class.
DEFINE MGMTCLASS	Defines a management class.
QUERY MGMTCLASS	Displays information about management classes.
UPDATE MGMTCLASS	Changes the attributes of a management class.

## DELETE NODEGROUP (Delete a node group)

---

Use this command to delete a node group. You cannot delete a node group if it has any members in it.

Attention: You can remove all the members in the node group by issuing the DELETE NODEGROUPMEMBER command with a wildcard in the node\_name parameter.

## Privilege class

---

To issue this command, you must have system or unrestricted policy privilege.

## Syntax

---

```
>>-DELEte NODEGroup--group_name-----<<
```

## Parameters

---

`group_name`  
Specifies the name of the node group that you want to delete.

## Example: Delete a node group

---

Delete a node group named `group1`.

```
delete nodegroup group1
```

## Related commands

---

Table 1. Commands related to DELETE NODEGROUP

Command	Description
DEFINE BACKUPSET	Defines a previously generated backup set to a server.
DEFINE NODEGROUP	Defines a group of nodes.
DEFINE NODEGROUPMEMBER	Adds a client node to a node group.
DELETE BACKUPSET	Deletes a backup set.
DELETE NODEGROUPMEMBER	Deletes a client node from a node group.
GENERATE BACKUPSET	Generates a backup set of a client's data.
QUERY BACKUPSET	Displays backup sets.
QUERY NODEGROUP	Displays information about node groups.
UPDATE BACKUPSET	Updates a retention value associated with a backup set.
UPDATE NODEGROUP	Updates the description of a node group.

## DELETE NODEGROUPMEMBER (Delete node group member)

---

Use this command to delete a client node from a node group.

### Privilege class

---

To issue this command, you must have system or unrestricted policy privilege.

### Syntax

---

```
      .-|-----|.
      v          |
>>-DElete NODEGROUPMember--group_name----node_name+-----><
```

### Parameters

---

`group_name`  
Specifies the name of the node group from which you want to delete a client node.

`node_name`  
Specifies the name of the client node that you want to delete from the node group. You can specify one or more names. When specifying multiple names, separate the names with commas; do not use intervening spaces. You can also use wildcard characters to specify multiple nodes.

## Example: Delete node group members

---

Delete two nodes, `node1` and `node2`, from a node group, `group1`.

```
delete nodegroupmember group1 node1,node2
```

## Related commands

---



Table 1. Commands related to DELETE NODEGROUPMEMBER

Command	Description
DEFINE BACKUPSET	Defines a previously generated backup set to a server.
DEFINE NODEGROUP	Defines a group of nodes.
DEFINE NODEGROUPMEMBER	Adds a client node to a node group.
DELETE BACKUPSET	Deletes a backup set.
DELETE NODEGROUP	Deletes a node group.
GENERATE BACKUPSET	Generates a backup set of a client's data.
QUERY BACKUPSET	Displays backup sets.
QUERY NODEGROUP	Displays information about node groups.
UPDATE BACKUPSET	Updates a retention value associated with a backup set.
UPDATE NODEGROUP	Updates the description of a node group.

## DELETE PATH (Delete a path)

Use this command to delete a path definition

### Privilege class

To issue this command you must have system privilege or unrestricted storage privilege.

### Syntax

```
>>-DELeTe PATH--source_name--destination_name----->
                                     (1)
>--SRCType-----+--DATAMover-----+----->
                   '-SERVer-----'

                                     (2)
>--DESTType-----+--DRive-----LIBRary---library_name+-----<
                   '-LIBRary-----'
```

#### Notes:

1. This parameter is only available on AIX, HP-UX, Linux, Solaris, Windows operating systems.
2. This parameter is only available on AIX, HP-UX, Linux, Solaris, Windows operating systems.

### Parameters

#### source\_name (Required)

Specifies the name of the source of the path to be deleted. This parameter is required.

The name specified must be that of a server or data mover that is already defined to the server.

#### destination\_name (Required)

Specifies the name of the destination of the path to be deleted. This parameter is required.

#### SRCType (Required)

Specifies the source type of the path to be deleted. This parameter is required. Possible values are:

##### DATAMover

Specifies that a data mover is the source.

##### SERVer

Specifies that a storage agent is the source.

#### DESTType (Required)

Specifies the type of the destination. Possible values are:

DRive LIBRARY=library\_name

Specifies that a drive is the destination. The DRIVE and LIBRARY parameters are both required when the destination type is drive.

LIBRARY

Specifies that a library is the destination.

Attention: If the path from a data mover to a library is deleted, or the path from the server to a library is deleted, the server will not be able to access the library. If the server is halted and restarted while in this state, the library will not be initialized.

## Example: Delete a NAS data mover path

---

Delete a path from a NAS data mover NAS1 to the library NASLIB.

```
delete path nas1 naslib srctype=datamover desttype=library
```

## Related commands

---

Table 1. Commands related to DELETE PATH

Command	Description
DEFINE DATAMOVER	Defines a data mover to the IBM Spectrum Protect server.
DEFINE PATH	Defines a path from a source to a destination.
PERFORM LIBACTION	Defines all drives and paths for a library.
QUERY PATH	Displays information about the path from a source to a destination.
UPDATE PATH	Changes the attributes associated with a path.

## DELETE POLICYSET (Delete a policy set)

---

Use this command to delete a policy set. When you delete a policy set, all management classes and copy groups that belong to the policy set are also deleted.

The ACTIVE policy set in a policy domain cannot be deleted. You can replace the contents of the ACTIVE policy set by activating a different policy set. Otherwise, the only way to remove the ACTIVE policy set is to delete the policy domain that contains the policy set.

You can delete the predefined STANDARD policy set. However, if you later reinstall the IBM Spectrum Protect™ server, the process restores all STANDARD policy objects.

## Privilege class

---

To issue this command, you must have system privilege, unrestricted policy privilege, or restricted policy privilege for the policy domain to which the policy set belongs.

## Syntax

---

```
>>-DELeTe Policyset--domain_name--policy_set_name-----<<
```

## Parameters

---

domain\_name (Required)

Specifies the policy domain to which the policy set belongs.

policy\_set\_name (Required)

Specifies the policy set to delete.

## Example: Delete a policy set

---

Delete the VACATION policy set from the EMPLOYEE\_RECORDS policy domain by issuing the following command:

```
delete policyset employee_records vacation
```

## Related commands

Table 1. Commands related to DELETE POLICYSET

Command	Description
ACTIVATE POLICYSET	Validates and activates a policy set.
COPY POLICYSET	Creates a copy of a policy set.
DEFINE POLICYSET	Defines a policy set within the specified policy domain.
QUERY POLICYSET	Displays information about policy sets.
UPDATE POLICYSET	Changes the description of a policy set.
VALIDATE POLICYSET	Verifies and reports on conditions the administrator must consider before activating the policy set.

## DELETE PROFASSOCIATION (Delete a profile association)

Use this command on a configuration manager to delete the association of one or more objects from a profile. If associations are deleted, the objects are no longer distributed to subscribing managed servers. When managed servers request updated configuration information, the configuration manager notifies them of the object deletions.

A managed server deletes the objects that were deleted from the profile, unless the objects are associated with another profile to which that server subscribes.

## Privilege class

To issue this command, you must have system privilege.

## Syntax

```
>>-DELEte PROFASSOCIation--profile_name----->
>--+-----+-----+-----+----->
  '-ADMinS---+*-----+-'
      | .-,----- . |
      | V             | |
      '---admin_name+--'

>--+-----+-----+-----+----->
  '-DOMains---+*-----+-'
      | .-,----- . |
      | V             | |
      '---domain_name+--'

>--+-----+-----+-----+----->
  '-ADSCHeds---+*-----+-'
      | .-,----- . |
      | V             | |
      '---schedule_name+--'

>--+-----+-----+-----+----->
  '-SCRipts---+*-----+-'
      | .-,----- . |
      | V             | |
      '---script_name+--'

>--+-----+-----+-----+----->
  '-CLOptsets---+*-----+-'
      | .-,----- . |
      | V             | |
      '---option_set_name+--'
```

```

>----->
'-SERVers-----*-----'
  | .,-----. |
  | V           | |
  '---server_name-+-'

>-----<
'-SERVERGroups-----*-----'
  | .,-----. |
  | V           | |
  '---group_name-+-'

```

## Parameters

---

### profile\_name (Required)

Specifies the profile from which to delete associations.

### ADMins

Specifies the administrators whose association with the profile is deleted. You can specify more than one name by separating the names with commas and no intervening spaces. Use the match-all character (\*) to delete all administrators from the profile. If you specify a list of administrators and a match-all definition exists for the profile, the command fails. Administrator definitions are not changed on the configuration manager. However, they are automatically deleted from all subscribing managed servers at the next configuration refresh, with the following exceptions:

- An administrator is not deleted if that administrator has an open session on the server.
- An administrator is not deleted if, as a result, the managed server would have no administrators with system privilege class.

### DOmains

Specifies the domains whose association with the profile is deleted. You can specify more than one name by separating the names with commas and no intervening spaces. Use the match-all character (\*) to delete all domains from the profile. If you specify a list of domains and a match-all domain definition exists for the profile, the command fails.

The domain information is automatically deleted from all subscribing managed servers. However, a policy domain that has client nodes assigned will not be deleted. To delete the domain at the managed server, assign those client nodes to another policy domain.

### ADScheds

Specifies a list of administrative schedules whose association with the profile is deleted. You can specify more than one name by separating the names with commas and no intervening spaces. If you specify a list of administrative schedules and a match-all administrative schedule definition exists for the profile, the command fails. Use the match-all character (\*) to delete all administrative schedules from the profile.

The administrative schedules are automatically deleted from all subscribing managed servers. However, an administrative schedule is not deleted if the schedule is active on the managed server. To delete an active schedule, make the schedule inactive.

### SCRipts

Specifies the server command scripts whose association with the profile is deleted. You can specify more than one name by separating the names with commas and no intervening spaces. Use the match-all character (\*) to delete all scripts from the profile. If you specify a list of scripts and a match-all script definition exists for the profile, the command fails. The server command scripts are automatically deleted from all subscribing managed servers.

### CLOptsets

Specifies the client option sets whose association with the profile is deleted. You can specify more than one name by separating the names with commas and no intervening spaces. Use the match-all character (\*) to delete all client option sets from the profile. If you specify a list of client option sets and a match-all client option set definition exists for the profile, the command fails. The client option sets are automatically deleted from all subscribing managed servers.

### SERVers

Specifies the servers whose association with the profile is deleted. You can specify more than one name by separating the names with commas and no intervening spaces. You can use the match-all character (\*) to delete all servers from the profile. If you specify a list of servers and a match-all server definition exists for the profile, the command fails. The server definitions are automatically deleted from all subscribing managed servers with the following exceptions:

- A server definition is not deleted if the managed server has an open connection to another server.

- A server definition is not deleted if the managed server has a device class of the device type SERVER that refers to the other server.
- A server definition is not deleted if the server is the event server for the managed server.

#### SERVERGroups

Specifies the server groups whose association with the profile is deleted. You can specify more than one name by separating the names with commas and no intervening spaces. You can use the match-all character (\*) to delete all server groups from the profile. If you specify a list of server groups and a match-all group definition exists for the profile, the command fails. The server group definitions are automatically deleted from all subscribing managed servers.

### Example: Delete the domain associations for a specific profile

Delete all domain associations from a profile named MIKE.

```
delete profassociation mike domains=*
```

### Related commands

Table 1. Commands related to DELETE PROFASSOCIATION

Command	Description
COPY PROFILE	Creates a copy of a profile.
DEFINE PROFASSOCIATION	Associates objects with a profile.
DEFINE PROFILE	Defines a profile for distributing information to managed servers.
DELETE PROFILE	Deletes a profile from a configuration manager.
LOCK PROFILE	Prevents distribution of a configuration profile.
NOTIFY SUBSCRIBERS	Notifies servers to refresh their configuration information.
QUERY PROFILE	Displays information about configuration profiles.
SET CONFIGMANAGER	Specifies whether a server is a configuration manager.
UNLOCK PROFILE	Enables a locked profile to be distributed to managed servers.
UPDATE PROFILE	Changes the description of a profile.

## DELETE PROFILE (Delete a profile)

Use this command on a configuration manager to delete a profile and stop its distribution to managed servers.

You cannot delete a locked profile. You must first unlock the profile with the UNLOCK PROFILE command.

Deleting a profile from a configuration manager does not delete objects associated with that profile from the managed servers. You can use the DELETE SUBSCRIPTION command with the DISCARDOBJECTS=YES parameter on each subscribing managed server to delete subscriptions to the profile and associated objects. This also prevents the managed servers from requesting further updates to the profile.

### Privilege class

To issue this command, you must have system privilege.

### Syntax

```
>>-DELeTe PROFIle--profile_name--+-Force-----No-----+-----><
                                     '-Force-----+No--+-'
                                     '-Yes-'
```

### Parameters

profile\_name (Required)

Specifies the profile to delete.

Force

Specifies whether the profile is deleted if one or more managed servers have subscriptions to that profile. The default is NO. Possible values are:

No

Specifies that the profile is not deleted if one or more managed servers have subscriptions to that profile. You can delete the subscriptions on each managed server using the DELETE SUBSCRIPTION command.

Yes

Specifies that the profile is deleted even if one or more managed servers have subscriptions to that profile. Each subscribing server continues to request updates for the deleted profile until the subscription is deleted.

## Examples: Delete a profile

Delete a profile named BETA, even if one or more managed servers subscribe to it.

```
delete profile beta force=yes
```

## Related commands

Table 1. Commands related to DELETE PROFILE

Command	Description
COPY PROFILE	Creates a copy of a profile.
DEFINE PROFASSOCIATION	Associates objects with a profile.
DEFINE PROFILE	Defines a profile for distributing information to managed servers.
DEFINE SUBSCRIPTION	Subscribes a managed server to a profile.
DELETE PROFASSOCIATION	Deletes the association of an object with a profile.
DELETE SUBSCRIPTION	Deletes a specified profile subscription.
LOCK PROFILE	Prevents distribution of a configuration profile.
QUERY PROFILE	Displays information about configuration profiles.
QUERY SUBSCRIPTION	Displays information about profile subscriptions.
SET CONFIGMANAGER	Specifies whether a server is a configuration manager.
UNLOCK PROFILE	Enables a locked profile to be distributed to managed servers.
UPDATE PROFILE	Changes the description of a profile.

## DELETE RECMEDMACHASSOCIATION (Delete recovery media and machine association)

Use this command to remove the association of one or more machines with a recovery media. This command does not delete the machine from IBM Spectrum Protect™.

### Privilege class

To issue this command, you must have system privilege.

### Syntax

```
>>>-DElete RECMEDMACHAssociation--media_name----machine_name-+-->>>
```

## Parameters

---

media\_name (Required)

Specifies the name of the recovery media that is associated with one or more machines.

machine\_name (Required)

Specifies the name of the machine associated with the recovery media. To specify a list of machine names, separate the names with commas and no intervening spaces. You can use wildcard characters to specify a name. If a machine is not associated with the recovery media, the machine is ignored.

## Example: Delete a machine's association with recovery media

---

Delete the association between the DIST5RM recovery media and the DISTRICT1 and DISTRICT5 machines.

```
delete recmedmachassociation
dist5rm district1,district5
```

## Related commands

---

Table 1. Commands related to DELETE RECMEDMACHASSOCIATION

Command	Description
DEFINE RECMEDMACHASSOCIATION	Associates recovery media with a machine.
QUERY MACHINE	Displays information about machines.
QUERY RECOVERYMEDIA	Displays media available for machine recovery.

## DELETE RECOVERYMEDIA (Delete recovery media)

---

Use this command to delete a recovery media definition from IBM Spectrum Protect™.

## Privilege class

---

To issue this command, you must have system privilege.

## Syntax

---

```
>>-DELeTe RECOVERYMedia--media_name-----><
```

## Parameters

---

media\_name (Required)

Specifies the name of the recovery media.

## Example: Delete a recovery media definition

---

Delete the DIST5RM recovery media.

```
delete recoverymedia dist5rm
```

## Related commands

---

Table 1. Commands related to DELETE RECOVERYMEDIA

Command	Description
DEFINE RECOVERYMEDIA	Defines the media required to recover a machine.
QUERY RECOVERYMEDIA	Displays media available for machine recovery.
UPDATE RECOVERYMEDIA	Changes the attributes of recovery media.

## DELETE SCHEDULE (Delete a client or an administrative command schedule)

---

Use this command to delete schedules from the database.

The DELETE SCHEDULE command takes two forms: one if the schedule applies to client operations, one if the schedule applies to administrative commands. The syntax and parameters for each form are defined separately.

Table 1. Commands related to DELETE SCHEDULE

Command	Description
COPY SCHEDULE	Creates a copy of a schedule.
DEFINE SCHEDULE	Defines a schedule for a client operation or an administrative command.
QUERY SCHEDULE	Displays information about schedules.
UPDATE SCHEDULE	Changes the attributes of a schedule.

- DELETE SCHEDULE (Delete a client schedule)  
Use the DELETE SCHEDULE command to delete one or more client schedules from the database. Any client associations to a schedule are removed when the schedule is deleted.
- DELETE SCHEDULE (Delete an administrative schedule)  
Use this command to delete one or more administrative command schedules from the database.

## DELETE SCHEDULE (Delete a client schedule)

---

Use the DELETE SCHEDULE command to delete one or more client schedules from the database. Any client associations to a schedule are removed when the schedule is deleted.

### Privilege class

---

To delete a client schedule, you must have system privilege, unrestricted policy privilege, or restricted policy privilege for the specified policy domain.

### Syntax

---

```
>>-DELEte SChedule--domain_name--schedule_name----->
    .-Type-----Client-.
>--+-----+----->>
```

### Parameters

---

domain\_name (Required)

Specifies the name of the policy domain to which the schedule belongs.

schedule\_name (Required)

Specifies the name of the schedule to delete. You can use a wildcard character to specify this name.

Type=Client

Specifies to delete a client schedule. This parameter is optional. The default is CLIENT.

### Example: Delete a specific schedule from a specific policy domain

---

Delete the WEEKLY\_BACKUP schedule, which belongs to the EMPLOYEE\_RECORDS policy domain.

```
delete schedule employee_records weekly_backup
```

## DELETE SCHEDULE (Delete an administrative schedule)

---



Use this command to delete one or more administrative command schedules from the database.

## Privilege class

---

To delete an administrative command schedule, you must have system authority.

## Syntax

---

```
>>-DELEte SCHedule--schedule_name--Type--==--Administrative-----><
```

## Parameters

---

*schedule\_name* (Required)

Specifies the name of the schedule to delete. You can use a wildcard character to specify this name.

Type=Administrative (Required)

Specifies to delete an administrative command schedule.

## Example: Delete an administrative command schedule

---

Delete the administrative command scheduled named DATA\_ENG.

```
delete schedule data_eng type=administrative
```

## DELETE SCRATCHPADENTRY (Delete a scratch pad entry)

---

Use this command to delete one or more lines of data from a scratch pad.

## Privilege class

---

To issue this command, you must have system privilege.

## Syntax

---

```
>>-DELEte SCRATCHPadentry--major_category--minor_category----->  
  
      .-Line---*-----.  
>--subject---+-----+-----><  
      '-Line---number-'
```

## Parameters

---

*major\_category* (Required)

Specifies the major category from which one or more lines of data are to be deleted. This parameter is case sensitive.

*minor\_category* (Required)

Specifies the minor category from which one or more lines of data are to be deleted. This parameter is case sensitive.

*subject* (Required)

Specifies the subject from which one or more lines of data are to be deleted. This parameter is case sensitive.

Line

Specifies a line of data that is to be deleted. For number, enter the number of the line that is to be deleted. All data on the line is deleted. The numbering of other lines in the subject section is not affected. You can delete all lines of data from a subject section by omitting the Line parameter in this command.

## Example: Delete all lines of data from a subject in a scratch pad

---

Delete all lines of data about the location of an administrator, Jane, from a database that stores information about administrators:

```
delete scratchpadentry admin_info location jane
```

## Related commands

Table 1. Commands related to DELETE SCRATCHPADENTRY

Command	Description
DEFINE SCRATCHPADENTRY	Creates a line of data in the scratch pad.
QUERY SCRATCHPADENTRY	Displays information that is contained in the scratch pad.
SET SCRATCHPADRETENTION	Specifies the amount of time for which scratch pad entries are retained.
UPDATE SCRATCHPADENTRY	Updates data on a line in the scratch pad.

## DELETE SCRIPT (Delete command lines from a script or delete the entire script)

Use this command to delete a single line from an IBM Spectrum Protect™ script or to delete the entire IBM Spectrum Protect script.

### Privilege class

To issue this command, the administrator must have previously defined the script or must have system privilege.

### Syntax

```
>>-DELeTe SCRipt--script_name--+-----+-----><  
                                '-Line---number-'
```

### Parameters

script\_name (Required)

Specifies the name of the script to delete. The script is deleted unless you specify a line number.

Line

Specifies the line number to delete from the script. If you do not specify a line number, the entire script is deleted.

### Example: Delete a specific line from a script

Using the following script named QSAMPLE and issue a command to delete line 005 from it.

```
001 /* This is a sample script */  
005 QUERY STATUS  
010 QUERY PROCESS  
  
delete script qsample line=5
```

## Related commands

Table 1. Commands related to DELETE SCRIPT

Command	Description
COPY SCRIPT	Creates a copy of a script.
DEFINE SCRIPT	Defines a script to the IBM Spectrum Protect server.
QUERY SCRIPT	Displays information about scripts.
RENAME SCRIPT	Renames a script to a new name.
RUN	Runs a script.
UPDATE SCRIPT	Changes or adds lines to a script.

## DELETE SERVER (Delete a server definition)

---

Use this command to delete a server definition.

This command fails if the server:

- Is defined as the event server.
- Is named in a device class definition whose device type is SERVER.
- Has an open connection to or from another server.
- Is a target server for virtual volumes.

### Privilege class

---

To issue this command, you must have system privilege.

### Syntax

---

```
>>-DELEte--SERver--server_name-----><
```

### Parameters

---

server\_name (Required)  
Specifies a server name.

### Example: Delete a server's definition

---

Delete the definition for a server named SERVER2.

```
delete server server2
```

### Related commands

---

Table 1. Commands related to DELETE SERVER

Command	Description
DEFINE SERVER	Defines a server for server-to-server communications.
QUERY EVENTSERVER	Displays the name of the event server.
QUERY SERVER	Displays information about servers.
RECONCILE VOLUMES	Reconciles source server virtual volume definitions and target server archive objects.
UPDATE SERVER	Updates information about a server.

## DELETE SERVERGROUP (Delete a server group)

---

Use this command to delete a server group. If the group you delete is a member of other server groups, IBM Spectrum Protect™ also removes the group from the other groups.

### Privilege class

---

To issue this command, you must have system privilege.

### Syntax

---

```
>>-DELEte SERVERGroup--group_name-----><
```

## Parameters

---

group\_name (Required)  
Specifies the server group to delete.

## Example: Delete a server group

---

Delete a server group named WEST\_COMPLEX.

```
delete servergroup west_complex
```

## Related commands

---

Table 1. Commands related to DELETE SERVERGROUP

Command	Description
COPY SERVERGROUP	Creates a copy of a server group.
DEFINE GRPMEMBER	Defines a server as a member of a server group.
DEFINE SERVERGROUP	Defines a new server group.
DELETE GRPMEMBER	Deletes a server from a server group.
MOVE GRPMEMBER	Moves a server group member.
QUERY SERVERGROUP	Displays information about server groups.
RENAME SERVERGROUP	Renames a server group.
UPDATE SERVERGROUP	Updates a server group.

## DELETE SPACETRIGGER (Delete the storage pool space triggers)

---

Use this command to delete the definition of the storage pool space trigger.

## Privilege class

---

To issue this command, you must have system privilege or unrestricted storage privilege.

## Syntax

---

```
>>-DELEte SPACETriGger--STG----->>  
>--+-----+----->>  
  '-STGPOOL-----storage_pool_name-'
```

## Parameters

---

STG

Specifies a storage pool space trigger.

STGPOOL

Specifies the storage pool trigger to be deleted. If STG is specified without specifying STGPOOL, the default storage pool space trigger is the deletion target.

## Example: Delete a space trigger definition

---

Delete the space trigger definition for the WINPOOL1 storage pool.

```
delete spacetrigger stg stgpool=winpool1
```

## Related commands

---

Table 1. Commands related to DELETE SPACETRIGGER

Command	Description
DEFINE SPACETRIGGER	Defines a space trigger to expand the space for a storage pool.
QUERY SPACETRIGGER	Displays information about a storage pool space trigger.
UPDATE SPACETRIGGER	Changes attributes of storage pool space trigger.

## DELETE STATUSTHRESHOLD (Delete a status monitoring threshold)

Use this command to delete an existing status monitoring threshold.

Status monitoring thresholds compare the defined conditions to the status monitoring server queries and inserts the results in the status monitoring table.

Multiple thresholds can be defined for an activity. For example, you can create a threshold that provides a warning status if storage pool capacity utilization is greater than 80%. You can then create another threshold that provides error status if storage pool capacity utilization is greater than 90%.

Note: If a threshold is already defined for an EXISTS condition, you cannot define another threshold with one of the other condition types.

### Privilege class

To issue this command, you must have system privilege.

### Syntax

```
>>-DELeTe STAtusthreshold--threshold_name-----<<
```

### Parameters

threshold\_name (Required)  
Specifies the threshold name that you want to delete.

### Delete an existing status threshold

Delete an existing status threshold by issuing the following command:

```
delete statusthreshold avgstgpl
```

### Related commands

Table 1. Commands related to DELETE STATUSTHRESHOLD

Command	Description
DEFINE STATUSTHRESHOLD (Define a status monitoring threshold)	Defines a status monitoring threshold.
QUERY MONITORSTATUS (Query the monitoring status)	Displays information about monitoring alerts and server status settings.
QUERY MONITORSETTINGS (Query the configuration settings for monitoring alerts and server status)	Displays information about monitoring alerts and server status settings.
QUERY STATUSTHRESHOLD (Query status monitoring thresholds)	Displays information about a status monitoring thresholds.
SET STATUSMONITOR (Specifies whether to enable status monitoring)	Specifies whether to enable status monitoring.

Command	Description
SET STATUSREFRESHINTERVAL (Set refresh interval for status monitoring)	Specifies the refresh interval for status monitoring.
UPDATE STATUSTHRESHOLD (Update a status monitoring threshold)	Changes the attributes of an existing status monitoring threshold.

## DELETE STGPOOL (Delete a storage pool)

Use this command to delete a storage pool. To delete a storage pool, you must first delete all volumes that are assigned to the storage pool.

You cannot delete a storage pool that is identified as the next storage pool for another storage pool. For more information about storage pool hierarchy, see the NEXTSTGPOOL parameter in the DEFINE STGPOOL command.

Restrictions:

- For container storage pools, delete all storage pool directories before you delete the storage pool.
- Do not delete a storage pool that is specified as a destination for a management class or copy group in the ACTIVE policy set. Client operations might fail as a result.
- When you delete a copy storage pool that was previously included in a primary storage-pool definition (specifically in the COPYSTGPOOLS list), you must remove the copy storage pool from the list before deletion. Otherwise, the DELETE STGPOOL command fails until all references to that copy pool are removed. For each primary storage pool with a reference to the copy storage pool to be deleted, remove the reference by entering the UPDATE STGPOOL command with the COPYSTGPOOLS parameter with all previous copy storage pools except the copy storage pool to be deleted.

### Privilege class

To issue this command, you must have system privilege.

### Syntax

```
>>-DELEte STGpool--pool_name----->>
```

### Parameters

pool\_name (Required)  
Specifies the storage pool to delete.

### Example: Delete a storage pool

Delete the storage pool named POOLA.

```
delete stgpool poola
```

### Related commands

Table 1. Commands related to DELETE STGPOOL

Command	Description
BACKUP STGPOOL	Backs up a primary storage pool to a copy storage pool.
DEFINE STGPOOL	Defines a storage pool as a named collection of server storage media.
DEFINE STGPOOLDIRECTORY	Defines a storage pool directory to a directory-container or cloud-container storage pool.
DELETE STGPOOLDIRECTORY	Deletes a storage pool directory from a directory-container or cloud-container storage pool.

Command	Description
QUERY STGPOOL	Displays information about storage pools.
QUERY STGPOOLDIRECTORY	Displays information about storage pool directories.
<b>AIX</b>   <b>Windows</b> SET DRMCOPYSTGPOOL	<b>AIX</b>   <b>Windows</b> Specifies that copy storage pools are managed by DRM.
UPDATE STGPOOL	Changes the attributes of a storage pool.
UPDATE STGPOOLDIRECTORY	Changes the attributes of a storage pool directory.

## DELETE STGPOOLDIRECTORY (Deleting a storage pool directory)

Use this command to delete a definition for a storage pool directory.

You might want to delete a storage pool directory for the following reasons:

- To decommission old storage.
- To discontinue using the local disk before moving data to the cloud.
- To no longer maintain the data in the storage pool directory because there is no requirement to do so.

Restrictions:

- You can issue this command only when no containers are assigned to the storage pool directory. Issue the QUERY CONTAINER command to determine whether any containers are assigned to the storage pool directory.
- To remove containers from a storage pool directory, you must issue the UPDATE STGPOOLDIRECTORY command and specify the ACCESS=DESTROYED parameter. Then, issue the AUDIT CONTAINER command and specify the ACTION=REMOVEDAMAGED parameter. Verify that the containers are removed. The ACTION=REMOVEDAMAGED parameter removes the inventory information of the objects that were backed up or archived. You should only remove the inventory information if you do not need the backups.

If you experience a hardware failure or a loss of your directory, see the relevant AUDIT and REPAIR commands. You should make any repairs to the IBM Spectrum Protect™ environment before you delete the storage pool directory.

### Privilege class

To issue this command, you must have system privilege.

### Syntax

```
>>-DELeTe STGPOOLDIRectory--pool_name--directory-----<<
```

### Parameters

pool\_name (Required)

Specifies the storage pool that contains the directory to delete. This parameter is required.

directory (Required)

Specifies the file system directory of the storage pool to delete. This parameter is required.

### Example: Update a storage pool directory to prepare for deletion

Update the storage pool directory that is named DIR1 in storage pool POOLA to mark as destroyed. When a storage pool is marked as destroyed, you can delete it.

**AIX** | **Linux**

```
update stgpooldirectory poola /storage/dir1 access=destroyed
```

**Windows**

```
update stgpooldirectory poola e:\storage\dir1 access=destroyed
```

## Example: Delete a storage pool directory

Delete the storage pool directory that is named DIR1 in storage pool POOLA.

AIX Linux

```
delete stgpooldirectory poola /storage/dir1
```

Windows

```
delete stgpooldirectory poola e:\storage\dir1
```

Table 1. Commands related to DELETE STGPOOLDIRECTORY

Command	Description
DEFINE STGPOOL	Defines a storage pool as a named collection of server storage media.
DEFINE STGPOOLDIRECTORY	Defines a storage pool directory to a directory-container or cloud-container storage pool.
QUERY STGPOOLDIRECTORY	Displays information about storage pool directories.
UPDATE STGPOOLDIRECTORY	Changes the attributes of a storage pool directory.
QUERY EXTENTUPDATES	Displays information about updates to data extents in directory-container storage pools.

## DELETE SUBSCRIBER (Delete subscriptions from a configuration manager database)

Use this command on a configuration manager to delete managed server subscriptions from the configuration manager database. Use this command when a managed server no longer exists or cannot notify the configuration manager after deleting a subscription.

Attention: Use this command only in rare situations in which the configuration manager's database contains an entry for a subscription, but the managed server does not have such a subscription. For example, use this command if a managed server no longer exists or cannot notify the configuration manager after deleting a subscription.

Under normal circumstances, use the DELETE SUBSCRIPTION command to delete a subscription from the managed server. The managed server notifies the configuration manager, which then deletes the subscription from its database.

### Privilege class

To issue this command, you must have system privilege.

### Syntax

```
>>-DELEte SUBSCRIBer--server_name-----><
```

### Parameters

server\_name (Required)  
Specifies the name of the managed server with subscription entries to be deleted.

## Example: Delete subscription entries for a specific managed server

Delete all subscription entries for a managed server named DAN.

```
delete subscriber dan
```

### Related commands



Table 1. Commands related to DELETE SUBSCRIBER

Command	Description
DEFINE SUBSCRIPTION	Subscribes a managed server to a profile.
DELETE SUBSCRIPTION	Deletes a specified profile subscription.
NOTIFY SUBSCRIBERS	Notifies servers to refresh their configuration information.
QUERY SUBSCRIBER	Displays information about subscribers and their subscriptions to profiles.
QUERY SUBSCRIPTION	Displays information about profile subscriptions.

## DELETE SUBSCRIPTION (Delete a profile subscription)

Use this command on a managed server to delete a profile subscription. You can also delete from the managed server all objects associated with the profile.

### Privilege class

To issue this command, you must have system privilege.

### Syntax

```
>>-DELeTe SUBSCRIPtion--profile_name----->
      .-DISCARDobjects----No-----
>--+-----+-----><
      '-DISCARDobjects--++-No--+-'
          '-Yes-'
```

### Parameters

profile\_name (Required)

Specifies the name of the profile for which the subscription is to be deleted.

DISCARDobjects

Specifies whether objects associated with the profile are to be deleted on the managed server. This parameter is optional. The default is NO.

No

Specifies that the objects are not to be deleted.

Yes

Specifies that the objects are to be deleted, unless they are associated with another profile for which a subscription is defined.

### Example: Delete a profile subscription

Delete a subscription to a profile named ALPHA and its associated objects from a managed server.

```
delete subscription alpha discardobjects=yes
```

### Related commands

Table 1. Commands related to DELETE SUBSCRIPTION

Command	Description
DEFINE SUBSCRIPTION	Subscribes a managed server to a profile.
DELETE SUBSCRIBER	Deletes obsolete managed server subscriptions.
NOTIFY SUBSCRIBERS	Notifies servers to refresh their configuration information.

Command	Description
QUERY SUBSCRIBER	Displays information about subscribers and their subscriptions to profiles.
QUERY SUBSCRIPTION	Displays information about profile subscriptions.

## DELETE VIRTUALFSMAPPING (Delete a virtual file space mapping)

Use this command to delete a virtual file space mapping definition. Virtual file spaces containing data cannot be deleted unless you use the DELETE FILESPACE command first.

### Privilege class

To issue this command, you must have one of the following privilege classes:

- System privilege
- Unrestricted policy privilege
- Restricted policy privilege for the domain to which the NAS node is assigned

### Syntax

```
>>--DELeTe VIRTUALFSmapping -node_name----->
>--virtual_filespace_name-----<<
```

### Parameters

node\_name (Required)

Specifies the NAS node on which the file system and path reside. You cannot use wildcard characters or specify a list of names.

virtual\_filespace\_name (Required)

Specifies the name of the virtual file space mapping definition to be deleted. Wildcard characters are allowed.

### Example: Delete a virtual file space mapping

Delete the virtual file space mapping definition /mikeshomedir for the NAS node named NAS1.

```
delete virtualfsmapping nas1 /mikeshomedir
```

### Related commands

Table 1. Commands related to DELETE VIRTUALFSMAPPING

Command	Description
DEFINE VIRTUALFSMAPPING	Define a virtual file space mapping.
QUERY VIRTUALFSMAPPING	Query a virtual file space mapping.
UPDATE VIRTUALFSMAPPING	Update a virtual file space mapping.

## DELETE VOLHISTORY (Delete sequential volume history information)

Use this command to delete volume history file records that are no longer needed (for example, records for obsolete database backup volumes).

When you delete records for volumes that are not in storage pools (for example, database backup or export volumes), the volumes return to scratch status even if IBM Spectrum Protect™ acquired them as private volumes. Scratch volumes of device type FILE are deleted. When you delete the records for storage pool volumes, the volumes remain in the IBM Spectrum Protect database. When you delete records for recovery plan file objects from a source server, the objects on the target server are marked for deletion.

Restriction: Do not use the DELETE VOLHISTORY command to delete information about backup set volumes from the volume history file. Instead, use the DELETE BACKUPSET command for this purpose.

For users of DRM, the database backup expiration should be controlled with the SET DRMDBBACKUPEXPIREDAYS command instead of this DELETE VOLHISTORY command. Use the DELETE VOLHISTORY command to remove a record of the volume. This can cause volumes to be lost that were managed by the MOVE DRMEDIA command. Use the SET DRMDBBACKUPEXPIREDAYS command to manage the automatic expiration of DRM database backup volumes.

Tips:

- Volumes for the most recent database backup series are not deleted.
- Existing volume history files are not automatically updated with this command.
- You can use the DEFINE SCHEDULE command to periodically delete volume history records.

## Privilege class

To issue this command, you must have system privilege.

## Syntax

```
>>-DELEte VOLHistry--TODate-----date----->>
. -TOTime-----23:59:59-.
>--+-----+----->
' -TOTime-----time-----'

>>-Type-----+All----->>
+DBBackup--+-----+-----+
|          '-DEVclass-----class_name-' |
+DBSnapshot--+-----+-----+
|          '-DEVclass-----class_name-' |
+DBRpf-----+-----+-----+
+EXPort-----+-----+-----+
|          .-DELETEDatest-----No----- |
+RPFfile--+-----+-----+-----+
|          '-DELETEDatest-----+No--+-' |
|                      '-Yes-' |
|          .-DELETEDatest-----No----- |
+RPFsSnapshot--+-----+-----+-----+
|          '-DELETEDatest-----+No--+-' |
|                      '-Yes-' |
+STGNew-----+-----+-----+
+STGReuse-----+-----+-----+
'-STGDelete-----+-----+-----'
```

## Parameters

TODate (Required)

Specifies the date to use to select sequential volume history information to be deleted. You can delete only those records with a date on or before the date that you specify. You can specify the date by using one of the following values:

Value	Description	Example
MM/DD/YYYY	A specific date	01/23/1999
TODAY	The current date	TODAY
TODAY-days or -days	The current date minus days specified. The maximum number of days you can specify is 9999.	TODAY-30 or -30. To delete records that are 30 or more days old, you can specify TODAY-30 or simply -30.
EOLM (End Of Last Month)	The last day of the previous month.	EOLM
EOLM-days	The last day of the previous month minus days specified.	EOLM-1 To include files that were active a day before the last day of the previous month.

Value	Description	Example
BOTM (Beginning Of This Month)	The first day of the current month.	BOTM
BOTM+days	The first day of the current month, plus days specified.	BOTM+9 To include files that were active on the 10th day of the current month.

#### TOTime

Specifies that you want to delete records that are created on or before this time on the specified date. This parameter is optional. The default is the end of the day (23:59:59). You can specify the time by using one of the following values:

Value	Description	Example
HH:MM:SS	A specific time on the specified date	12:30:22
NOW	The current time on the specified date	NOW
NOW+HH:MM or +HH:MM	The current time plus hours and minutes on the specified date	NOW+03:00 or +03:00. If you issue the DELETE VOLHISTORY command at 9:00 with TOTIME=NOW+03:00 or TOTIME=+03:00, IBM Spectrum Protect deletes records with a time of 12:00 or earlier on the specified date.
NOW-HH:MM or -HH:MM	The current time minus hours and minutes on the specified date	NOW-03:30 or -03:30. If you issue the DELETE VOLHISTORY command at 9:00 with TOTIME=NOW-3:30 or TOTIME=-3:30, IBM Spectrum Protect deletes records with a time of 5:30 or earlier on the specified date.

#### Type (Required)

Specifies the type of records, which also meet the date and time criteria, to delete from the volume history file. Possible values are:

##### All

Specifies to delete all records.

Restriction: The DELETE VOLHISTORY command does not delete records of remote volumes.

##### DBBackup

Specifies to delete only records that contain information about volumes that are used for database full and incremental backups, that is, with volume types of BACKUPFULL and BACKUPINCR, and that meet the specified date and time criteria. The records from the latest full and incremental database backup series will not be deleted.

##### DEVclass=class\_name

Specifies the device class name that was used to create the database backups. This optional parameter can be used to delete database backups that are created by using a server-to-server virtual volume device class. The type of the device class must be SERVER. This parameter can be used only to delete volume history entries of type BACKUPFULL, BACKUPINCR, or DBSNAPSHOT.

A full or incremental database backup volume is eligible to be deleted if all of the following conditions are met:

- The device class that was used to create the database backup volume matches the specified device class.
- The volume was created on or before the specified date and time.
- The volume is not part of the latest full plus incremental database backup series.
- The volume is not part of a full plus incremental backup series with an incremental database backup that was created after the specified date and time.

##### DBSnapshot

Specifies to delete only records that contain information about volumes that are used for snapshot database backups, and that meet the specified date and time criteria. Records that are related to the latest snapshot database backup will not be deleted.

DEVclass=classname

Specifies the device class name that was used to create the database backups. This optional parameter can be used to delete database backups that are created by using a server-to-server virtual volume device class. The type of the device class must be SERVER. This parameter can only be used to delete volume history entries of type BACKUPFULL, BACKUPINCR, or DBSNAPSHOT.

A snapshot database backup volume is eligible to be deleted if all of the following conditions are met:

- The device class that is used to create the database backup volume matches the specified device class
- The volume was created on or before the specified date and time
- The volume is not part of the latest snapshot database backup series

#### DBRpf

Specifies to delete only records that contain information about full and incremental database backup volumes and recovery plan file volumes.

#### EXPort

Specifies to delete only records that contain information about export volumes.

#### RPFfile

Specifies to delete only records that contain information about recovery plan file objects that are stored on a target server and that meet the specified date and time criteria.

#### DELETEDatest

Specifies whether the latest recovery plan file is eligible for deletion. This optional parameter can be used to delete the latest recovery plan files that are created by using a server-to-server virtual volume device class.

This parameter can be used only to delete volume history entries of type RPFfile (for instance, those recovery plan files that were created by using the DEVCLASS parameter with the PREPARE command). If this parameter is not specified, the latest RPFfile entries are not deleted.

No

Specifies the latest RPFfile file is not deleted.

Yes

Specifies the latest RPFfile file is deleted if it meets the specified date and time criteria.

#### RPFSnapshot

Specifies to delete only records that contain information about recovery plan file objects that were created for snapshot database backups, that are stored on a target server and that meet the specified date and time criteria. The latest RPFsnapshot file will not be deleted unless it meets the specified date and time criteria, and the DELETE parameter is set to Yes.

#### DELETEDatest

Specifies whether the latest recovery plan file is eligible for deletion. This optional parameter can be used to delete the latest recovery plan files that are created by using a server-to-server virtual volume device class.

This parameter can only be used to delete volume history entries of type RPFsnapshot (for instance, those recovery plan files that were created by using the DEVCLASS parameter with the PREPARE command). If this parameter is not specified, the latest RPFsnapshot entries are not deleted.

No

Specifies the latest RPFsnapshot file is not deleted.

Yes

Specifies the latest RPFsnapshot file is deleted if it meets the specified date and time criteria.

#### STGNew

Specifies to delete only records that contain information about new sequential access storage volumes.

#### STGReuse

Specifies to delete only records that contain information about reused sequential storage pool volumes.

#### STGDelete

Specifies to delete only records that contain information about deleted sequential storage pool volumes.

## Example: Delete recovery plan file information

---

Delete all recovery plan file information that is created on or before 03/28/2016.

```
delete volhistory type=rpf file todate=03/28/2016
```

Table 1. Commands related to DELETE VOLHISTORY

Command	Description
BACKUP VOLHISTORY	Records volume history information in external files.
DEFINE SCHEDULE	Defines a schedule for a client operation or an administrative command.
DELETE VOLUME	Deletes a volume from a storage pool.
EXPIRE INVENTORY	Manually starts inventory expiration processing.
MOVE DRMEDIA	Moves DRM media onsite and offsite.
PREPARE	Creates a recovery plan file.
QUERY RPFIL	Displays information about recovery plan files.
QUERY VOLHISTORY	Displays sequential volume history information that has been collected by the server.
SET DRMRPFEXPIREDDAYS	Set criteria for recovery plan file expiration.
SET DRMDBBACKUPEXPIREDDAYS	Specifies criteria for database backup series expiration.

## DELETE VOLUME (Delete a storage pool volume)

Use this command to delete a storage pool volume and, optionally, the files stored in the volume.

If the volume has data, to delete the volume you must do one of the following:

- Before deleting the volume, use the MOVE DATA command to move all files to another volume.
- Explicitly request to discard all files in the volume when the volume is deleted (by specifying DISCARDATA=YES).

If you are deleting several volumes, delete the volumes one at a time. Deleting more than one volume at a time can adversely affect server performance.

Storage pool volumes cannot be deleted if they are in use. For example, a volume cannot be deleted if a user is restoring or retrieving a file residing in the volume, if the server is writing information to the volume, or if a reclamation process is using the volume.

If you issue the DELETE VOLUME command, volume information is deleted from the IBM Spectrum Protect™ database. However, the physical files that are allocated with DEFINE VOLUME command are not removed from the file space.

If this command is applied to a WORM (write once, read many) volume, the volume returns to scratch if it has space remaining in which data can be written. Data on WORM volumes, including deleted and expired data, cannot be overwritten. Therefore, data can only be written in space that does not contain current, deleted, or expired data. If a WORM volume does not have any space available in which data can be written, it remains private. To remove the volume from the library, you must use the CHECKOUT LIBVOLUME command.

The DELETE VOLUME command automatically updates the server library inventory for sequential volumes if the volume is returned to scratch status when the volume becomes empty. To determine whether a volume will be returned to scratch status, issue the QUERY VOLUME command and look at the output. If the value for the attribute "Scratch Volume?" is "Yes," then the server library inventory is automatically updated.

If the value is "No," you can issue the UPDATE LIBVOLUME command to specify the status as scratch. It is recommended that you issue the UPDATE LIBVOLUME command after issuing the DELETE VOLUME command.

Attempting to use the DELETE VOLUME command to delete WORM FILE volumes in a storage pool with RECLAMATIONTYPE=SNAPLOCK fails with an error message. Deletion of empty WORM FILE volumes is performed only by the reclamation process.

If you issue the DELETE VOLUME command for a volume in a storage pool that has a SHRED parameter value greater than 0, the volume is placed in the pending state until shredding is run. Shredding is necessary to complete the deletion, even if the volume is empty.

If you issue the DELETE VOLUME command for a volume in a storage pool that is set up for data deduplication, the server destroys any object that is referencing data on that volume.

## Privilege class

---

To issue this command, you must have system privilege, unrestricted storage privilege, or restricted storage privilege for the storage pool to which the volume is defined.

## Syntax

---

```
>>-DELEte Volume--volume_name--+-DISCARDdata-----No----->
                                     '-DISCARDdata-----+No--+-'
                                     '-Yes-'

.-Wait-----No-----
>--+-Wait-----+No--+--><
    '-Wait-----+No--+-'
    '-Yes-'
```

## Parameters

---

### volume\_name (Required)

Specifies the name of the volume to delete.

### DISCARDdata

Specifies whether files stored in the volume are deleted. This parameter is optional. The default value is NO. Possible values are:

#### No

Specifies that files stored in the volume are not deleted. If the volume contains any files, the volume is not deleted.

#### Yes

Specifies that all files stored in the volume are deleted. The server does not need to mount the volume for this type of deletion.

Remember:

1. The server does not delete archive files that are on deletion hold.
2. If archive retention protection is enabled, the server deletes only archive files whose retention period has expired.

If the volume being deleted is a primary storage pool volume, the server checks whether any copy storage pool has copies of files that are being deleted. When files stored in a primary storage pool volume are deleted, any copies of these files in copy storage pools are also deleted.

When you delete a disk volume in a primary storage pool, the command also deletes any files that are cached copies (copies of files that have been migrated to the next storage pool). Deleting cached copies of files does not delete the files that have already been migrated or backed up to copy storage pools. Only the cached copies of the files are affected.

If the volume being deleted is a copy storage pool volume, only files on the copy pool volume are deleted. The primary storage pool files are not affected.

Do not use the DELETE VOLUME command with DISCARDATA=YES if a restore process (RESTORE STGPOOL or RESTORE VOLUME) is running. The DELETE VOLUME command could cause the restore to be incomplete.

If you cancel the DELETE VOLUME operation during processing or if a system failure occurs, some files might remain on the volume. You can delete the same volume again to have the server delete the remaining files and then the volume.

### Wait

Specifies whether to wait for the server to complete processing this command in the foreground. This parameter affects processing only when you have also requested that any data on the volume be discarded. This parameter is optional. The default value is No. Possible values are:

#### No

Specifies that the server processes this command in the background. You can continue with other tasks while the command is being processed.

The server displays messages that are created from the background process either in the activity log or the server console, depending on where messages are logged.

Yes

Specifies that the server processes this command in the foreground. You wait for the command to complete before continuing with other tasks. The server then displays the output messages to the administrative client when the command completes.

Remember: You cannot specify WAIT=YES from the server console.

## Example: Delete a storage pool volume

Delete storage pool volume stgvol.1 from the storage pool FILEPOOL.

```
delete volume stgvol.1
```

## Related commands

Table 1. Commands related to DELETE VOLUME

Command	Description
CANCEL PROCESS	Cancels a background server process.
DEFINE VOLUME	Assigns a volume to be used for storage within a specified storage pool.
MOVE DATA	Moves data from a specified storage pool volume to another storage pool volume.
MOVE DRMEDIA	Moves DRM media onsite and offsite.
QUERY CONTENT	Displays information about files in a storage pool volume.
QUERY DRMEDIA	Displays information about disaster recovery volumes.
QUERY PROCESS	Displays information about background processes.
QUERY VOLUME	Displays information about storage pool volumes.
UPDATE VOLUME	Updates the attributes of storage pool volumes.

## DISABLE commands

Use DISABLE commands to prevent some types of operations by the server.

- DISABLE EVENTS (Disable events for event logging)
- DISABLE REPLICATION (Prevent outbound replication processing on a server)
- DISABLE SESSIONS (Prevent new sessions from accessing IBM Spectrum Protect)

## DISABLE EVENTS (Disable events for event logging)

Use this command to disable the processing of one or more events. If you specify a receiver that is not supported on any platform, or if you specify an invalid event or name, IBM Spectrum Protect™ issues an error message. However, any valid receivers, events, or names that you specified are still enabled.

Tip: Messages in the SEVERE category and message ANR9999D can provide valuable diagnostic information if there are serious server problems. For this reason, you should not disable these messages.

Restriction:

- Certain messages are displayed on the console even if they are disabled. These include some messages issued during server startup and shutdown and responses to administrative commands.
- Server messages from the server on which this command is issued cannot be disabled for the activity log.



ANR1822I indicates that event logging is being ended for the specified receiver. When the DISABLE EVENTS command is issued, this message is logged to the receiver even if it is one of the events that has been disabled. This is done to confirm that event logging has ended to that receiver, but subsequent ANR1822I messages are not logged to that receiver.

## Privilege class

To issue this command, you must have system privilege.

## Syntax

```

      .-,------.      .-,------.
      v              |      v              |
>>-DISAbLe EVents---+-----+-----+-----+-----+-----+-----+----->
                        +-ALL-----+      +-ALL-----+
                        +-CONSOLE-----+      +-INFO-----+
                        +-ACTLOG-----+      +-WARNING-----+
                        +-EVENTSERVER-----+      +-ERROR-----+
                        +-FILE-----+      '-SEVERE-----'
                        +-FILETEXT-----+
                        |                (1) |
                        +-NTEVENTLOG-----+
                        |                (2) |
                        +-SYSLOG-----+
                        +-TIVOLI-----+
                        '-USEREXIT-----'

>-----><
|                .-,------.      |
|                v              |
+-NODEname-----+-----+-----+-----+-----+-----+-----+-----+
|                .-,------.      |
|                v              |
'-SERVername-----+-----+-----+-----+-----+-----+-----+-----'

```

### Notes:

1. NTEVENTLOG is available only on Windows.
2. SYSLOG is available only on Linux.

## Parameters

### receivers (Required)

Specifies the name of the receivers for which to disable events. Specify multiple receivers by separating them with commas and no intervening spaces. Possible values are:

#### ALL

All receivers, except for server events on the activity log receiver (ACTLOG). Only client events can be disabled for the activity log receiver.

#### CONSOLE

The standard server console as a receiver.

#### ACTLOG

The activity log as a receiver. You can disable only client events, not server events, for the activity log.

#### EVENTSERVER

The event server as a receiver.

#### FILE

A user file as a receiver. Each logged event is a record in the file. The records are not easily readable by people.

#### FILETEXT

A user file as a receiver. Each logged event is a fixed-size, readable line.

#### NTEVENTLOG

The Windows application log as a receiver.

#### **Linux** SYSLOG

**Linux** Writes messages directly to the system log on Linux.

#### TIVOLI

The Tivoli Enterprise Console® (TEC) as a receiver.

## USEREXIT

A user-written program as a receiver. The server writes information to the program.

## events (Required)

Specifies the events to be disabled. You can specify multiple events by separating them with commas and no intervening spaces. Possible values are:

### ALL

All events.

### event\_name

A four-digit message number preceded by **ANR** for a server event or **ANE** for a client event. Valid ranges are from ANR0001 to ANR9999 and from ANE4000 to ANE4999. Specify the **NODENAMES** parameter if client events are to be disabled for matching nodes. Specify the **SERVERNAME** parameter if server events are to be disabled for matching servers.

For the TIVOLI event receiver only, you can specify the following events names for the IBM Spectrum Protect application clients:

IBM Spectrum Protect application client	Prefix	Range
Data Protection for Microsoft Exchange Server	ACN	3500–3649
Data Protection for Lotus® Domino®	ACD	5200–5299
Data Protection for Oracle	ANS	500–599
Data Protection for Informix®	ANS	600–699
Data Protection for Microsoft SQL Server	ACO	3000–3999

Remember: Specifying **ALL** disables these messages. However, the **INFO**, **WARNING**, **ERROR**, and **SEVERE** options have no effect on the messages.

## severity categories

If the event list contains a severity category, all events of that severity are disabled for the specified nodes. The message types are:

### INFO

Information messages (type of I).

### WARNING

Warning messages (type of W).

### ERROR

Error messages (type of E).

### SEVERE

Severe error messages (type of S).

## NODENAME

Specifies the name of one or more node names for which events are to be disabled. You can use the wildcard character (\*) to specify all nodes. You can specify **NODENAME** or **SERVERNAME**. If neither parameter is specified, the events are disabled for the server running this command.

## SERVername

Specifies the name of one or more server names for which events are to be disabled. You can use the wildcard character (\*) to specify all servers other than the server running this command. You can specify **NODENAME** or **SERVERNAME**. If neither parameter is specified, the events are disabled for the server running this command.

## Example: Disable specific categories of events

Disable all client events in the **INFO** and **WARNING** categories for the activity log and console receivers for all nodes.

```
disable events actlog,console  
info,warning nodename=*
```

## Related commands

Table 1. Commands related to DISABLE EVENTS

Command	Description
BEGIN EVENTLOGGING	Starts event logging to a specified receiver.

Command	Description
ENABLE EVENTS	Enables specific events for receivers.
END EVENTLOGGING	Ends event logging to a specified receiver.
QUERY ENABLED	Displays enabled or disabled events for a specific receiver.
QUERY EVENTRULES	Displays information about rules for server and client events.
QUERY STATUS	Displays the settings of server parameters, such as those selected by the SET commands.

## DISABLE REPLICATION (Prevent outbound replication processing on a server)

Use this command to prevent a source replication server from starting new replication processes.

The use of this command does not stop running replication processes. Running replication processes continue until they complete or until they end without completing. Use this command and the ENABLE REPLICATION command to control replication processing.

Issue this command on the server that acts as a source for replicated data.

### Privilege class

To issue this command, you must have system privilege.

### Syntax

```
>>-DISAbLe REPLicAtion-----<<
```

### Parameters

None.

### Example: Disable replication processing

Disable replication processing on a source replication server.

```
disable replication
```

### Related commands

Table 1. Commands related to DISABLE REPLICATION

Command	Description
CANCEL REPLICATION	Cancels node replication processes.
DISABLE SESSIONS	Prevents new sessions from accessing IBM Spectrum Protect but permits existing sessions to continue.
ENABLE REPLICATION	Allows outbound replication processing on a server.
ENABLE SESSIONS	Resumes server activity following the DISABLE command or the ACCEPT DATE command.
QUERY STATUS	Displays the settings of server parameters, such as those selected by the SET commands.
REPLICATE NODE	Replicates data in file spaces that belong to a client node.

# DISABLE SESSIONS (Prevent new sessions from accessing IBM Spectrum Protect)

Use this command to prevent new sessions from accessing IBM Spectrum Protect™. Active sessions will complete. For a particular server, you can specify whether to disable inbound sessions, outbound sessions, or both.

Server processes, such as migration and reclamation, are not affected when you issue the DISABLE SESSIONS command.

## Privilege class

To issue this command, you must have system privilege or operator privilege.

## Syntax

```
>>-DISAbLe SESSions----->
. -CLient-----.
>--+-----+><
'|++-CLient-----+'
  +-ALL-----+
  +-ADMin-----+
  '-SERVer--+-----+'
      | .-DIRection---Both-----|
      '-server_name--+-----+'
          '++-DIRection---Both-----+'
          +-DIRection---INbound--+
          '-DIRection---OUTbound-'
```

## Parameters

Specifies the type of session to be disabled. This parameter is optional. The default value is CLIENT. You can specify one of the following values:

### CLient

Disables only backup and archive client sessions.

### ALL

Disables all session types.

### ADMin

Disables only administrative sessions.

### SERVer

Disables only server-to-server sessions. Only the following types of sessions are disabled:

- Server-to-server event logging
- Enterprise management
- Server registration
- LAN-free: storage agent - server
- Virtual volumes
- Node replication

You can also specify whether to disable inbound sessions, outbound sessions, or both for a particular server.

### server\_name

Specifies the name of a server whose sessions you want to disable. This parameter is optional. If you do not specify this parameter, new sessions with other servers do not start. Running sessions are not canceled.

### DIRection

Specifies whether to disable inbound sessions, outbound sessions, or both. This parameter is optional. The default is BOTH. The following values are possible:

#### Both

Specifies that inbound sessions from the specified server and outbound sessions to the specified server are disabled.

- INbound  
Specifies that only inbound sessions from the specified server are disabled.
- OUTbound  
Specifies that only outbound sessions to the specified server are disabled.

## Example: Prevent new client node backup and archive sessions on the server

---

Temporarily prevent new client node sessions from accessing the server.

```
disable sessions
```

## Example: Prevent all new sessions on the server

---

Temporarily prevent any new sessions from accessing the server.

```
disable sessions all
```

## Example: Disable outbound sessions to a server

---

Disable outbound sessions to a server named REPLSRV.

```
disable sessions server replsrv direction=outbound
```

## Related commands

---

Table 1. Commands related to DISABLE SESSIONS

Command	Description
CANCEL SESSION	Cancels active sessions with the server.
DISABLE REPLICATION	Prevents outbound replication processing on a server.
ENABLE SESSIONS	Resumes server activity following the DISABLE command or the ACCEPT DATE command.
QUERY SESSION	Displays information about all active administrator and client sessions with IBM Spectrum Protect.
QUERY STATUS	Displays the settings of server parameters, such as those selected by the SET commands.

## DISMOUNT command

---

Use the DISMOUNT command to dismount a volume by the real device address or by volume name.

- DISMOUNT VOLUME (Dismount a volume by volume name)

## DISPLAY OBJNAME (Display a full object name)

---

Use this command when you want IBM Spectrum Protect™ to display a full object name if the name displayed in a message or query output has been abbreviated due to length. Object names that are very long can be difficult to display and use through normal operating system facilities. The IBM Spectrum Protect server will abbreviate long names and assign them a token ID which might be used if the object path name exceeds 1024 bytes. The token ID is displayed in a string that includes identifiers for the node, file space, and object name. The format is: [TSMOBJ:nID.fsID.objID]. When specified with the DISPLAY OBJNAME command, the token ID can be used to show the full object name.

## Privilege class

---

Any administrator can issue this command

## Syntax

---

```
>>-DISplay OBJname--token_ID-----><
```

## Parameters

token\_ID (Required)

Specifies the ID reported in the [TSMOBJ:] tag, when an object name is too long to display.

## Example: Display the full object name of a token ID in a message

Assume the you receive the following message:

```
ANR9999D file.c(1999) Error handling file [TSMOBJ:1.1.649498] because  
of lack of server resources.
```

Display the full object name for the file referenced in the error message by specifying the token ID on the DISPLAY OBJNAME command.

```
display obj 1.1.649498
```

## Related commands

Table 1. Commands related to DISPLAY OBJNAME

Command	Description
QUERY CONTENT	Displays information about files in a storage pool volume.

## ENABLE commands

Use ENABLE commands to allow some types of operations by the server.

- ENABLE EVENTS (Enable server or client events for logging)
- ENABLE REPLICATION (Allow outbound replication processing on a server)
- ENABLE SESSIONS (Resume user activity on the server)

## ENABLE EVENTS (Enable server or client events for logging)

Use this command to enable the processing of one or more events. If you specify a receiver that is not supported on any platform, or if you specify an invalid event or name, IBM Spectrum Protect™ issues an error message. However, any valid receivers, events, or names that you specified are still enabled.

Restriction: Certain events, such as some messages issued during server start-up and shutdown, automatically go to the console. They do not go to other receivers even if they are enabled.

Administrative commands are returned to the command issuer and are only logged as numbered events. These numbered events are not logged to the system console, but are logged to other receivers, including administrative command-line sessions running in console mode.

## Privilege class

To issue this command, you must have system privilege.

## Syntax

```
      .,----- .,-----  
      v         | v         |  
>>-ENable--EEvents---+--ALL-----+---+--event_name---+--->  
      +-CONSOLE-----+      +-ALL-----+  
      +-ACTLOG-----+      +-INFO-----+  
      +-EVENTSERVER----+      +-WARNING----+  
      +-FILE-----+      +-ERROR-----+  
      +-FILETEXT-----+      '-SEVERE-----'
```

```

          (1) |
+--NTEVENTLOG-----+
          (2) |
+--SYSLOG-----+
+--TIVOLI-----+
'-USEREXIT-----'

```

```

>-----<
|          .-,----- . |
|          v |
+--NODEname-----node_name-+-----+
|          .-,----- . |
|          v |
'-SERVername-----server_name-+-'

```

Notes:

1. NTEVENTLOG is available only on Windows.
2. This parameter is only available for the Linux operating system.

## Parameters

receivers (Required)

Specifies one or more receivers for which to log enabled events. You can specify multiple receivers by separating them with commas and no intervening spaces. Valid values are:

ALL

All receivers.

CONSOLE

The standard server console as a receiver.

ACTLOG

The server activity log as a receiver.

EVENTSERVER

The event server as a receiver.

FILE

A user file as a receiver. Each logged event is a record in the file. The records are not easily readable by people.

FILETEXT

A user file as a receiver. Each logged event is a fixed-size, readable line.

**Windows** NTEVENTLOG

The Windows application log as a receiver.

**Linux** SYSLOG

Specifies the Linux system log as a receiver.

TIVOLI

The Tivoli Enterprise Console® (TEC) as a receiver.

USEREXIT

A user-written program as a receiver. The server writes information to the program.

events (Required)

Specifies the type of events to be enabled. You can specify multiple events by separating them with commas and no intervening spaces. Possible values are:

ALL

All events.

event\_name

A four-digit message number preceded by ANR for a server event or ANE for a client event. Valid ranges are from ANR0001 to ANR9999 and from ANE4000 to ANE4999. Specify the NODENAME parameter if client events are to be enabled for matching nodes. Specify the SERVERNAME parameter if server events are to be enabled for matching servers.

For the TIVOLI event receiver, you can specify the following additional ranges for the IBM Spectrum Protect application clients:

IBM Spectrum Protect application client	Prefix	Range
Data Protection for Microsoft Exchange Server	ACN	3500–3649
Data Protection for Lotus® Domino®	ACD	5200–5299

IBM Spectrum Protect application client	Prefix	Range
Data Protection for Oracle	ANS	500–599
Data Protection for Informix®	ANS	600–699
Data Protection for Microsoft SQL Server	ACO	3000–3999

Restriction: The application client must have enhanced Tivoli® Event Console support enabled in order to route these messages to the Tivoli Event Console.

Tip:

- Specifying the ALL option enables these messages. However, the INFO, WARNING, ERROR, and SEVERE options have no effect on the messages.
- Because of the number of messages, you should not enable all messages from a node to be logged to the Tivoli Event Console.

severity categories

If the event list contains a severity category, all events of that severity are enabled for the specified nodes. The message types are:

INFO

Information messages (type of I) are enabled.

WARNING

Warning messages (type of W) are enabled.

ERROR

Error messages (type of E) are enabled.

SEVERE

Severe error messages (type of S) are enabled.

NODENAME

Specifies one or more client nodes for which events are enabled. You can use a wildcard character to specify all client nodes. You can specify NODENAME or SERVERNAME. If neither parameter is specified, events are enabled for the server running this command.

SERVername

Specifies one or more servers for which events are to be enabled. You can use a wildcard character to specify all servers other than the server from which this command is issued. You can specify SERVERNAME or NODENAME. If neither parameter is specified, the events are enabled for the server running this command.

## Example: Enable specific categories of events

Enable all ERROR and SEVERE client events to the USEREXIT receiver for the node BONZO.

```
enable events userexit error,severe nodename=bonzo
```

## Related commands

Table 1. Commands related to ENABLE EVENTS

Command	Description
BEGIN EVENTLOGGING	Starts event logging to a specified receiver.
DISABLE EVENTS	Disables specific events for receivers.
END EVENTLOGGING	Ends event logging to a specified receiver.
QUERY ENABLED	Displays enabled or disabled events for a specific receiver.
QUERY EVENTRULES	Displays information about rules for server and client events.
QUERY STATUS	Displays the settings of server parameters, such as those selected by the SET commands.

## ENABLE REPLICATION (Allow outbound replication processing on a server)



Use this command to allow a source replication server to begin normal replication processing after a database restore. You can also use this command to resume replication processing after issuing the DISABLE REPLICATION command.

Attention: Before enabling replication after a database restore, determine whether copies of data that are on the target server are needed. If they are, you must synchronize client node data by replicating the data from the target replication server to the source replication server. The replication process replaces the data on the source server that was lost because of the database restore.

Issue this command on the server that acts as a source for replicated data.

## Privilege class

---

To issue this command, you must have system privilege.

## Syntax

---

```
>>-ENable REPLication-----<<
```

## Parameters

---

None.

## Example: Allow replication processing

---

Allow replication processing on a source replication server.

```
enable replication
```

## Related commands

---

Table 1. Commands related to ENABLE REPLICATION

Command	Description
DISABLE REPLICATION	Prevents outbound replication processing on a server.
DISABLE SESSIONS	Prevents new sessions from accessing IBM Spectrum Protect but permits existing sessions to continue.
ENABLE SESSIONS	Resumes server activity following the DISABLE command or the ACCEPT DATE command.
QUERY STATUS	Displays the settings of server parameters, such as those selected by the SET commands.
REPLICATE NODE	Replicates data in file spaces that belong to a client node.

## ENABLE SESSIONS (Resume user activity on the server)

---

Use this command after issuing the DISABLE SESSIONS command to start new sessions that can access a server. For a particular server, you can specify whether to enable inbound sessions, outbound sessions, or both.

The processing of this command does not affect system processes, such as migration and reclamation.

Use the QUERY STATUS command to display the availability of the server.

## Privilege class

---

To issue this command, you must have system privilege or operator privilege.

## Syntax

---

```
>>-ENable SESSions----->
```



Command	Description
ACCEPT DATE	Accepts the current date on the server.
CANCEL SESSION	Cancels active sessions with the server.
ENABLE REPLICATION	Allows outbound replication processing on a server.
DISABLE SESSIONS	Prevents new sessions from accessing IBM Spectrum Protect but permits existing sessions to continue.
QUERY SESSION	Displays information about all active administrator and client sessions with IBM Spectrum Protect.
QUERY STATUS	Displays the settings of server parameters, such as those selected by the SET commands.

## ENCRYPT STGPOOL (Encrypt data in a storage pool)

Use this command to encrypt data in a directory-container or cloud-container storage pool.

### Privilege class

Any administrator can issue this command.

### Syntax

```

>>-ENcrypt STGpool--pool_name--+-MAXPRocess---4-----+----->
                                     '-MAXPRocess---number-'

.-Preview---No----- .-Wait---No-----
>-----+-----+-----+-----+-----+-----><
'-Preview---+Yes-+-' '-Wait---+No-+-'
          '-No--'          '-Yes-'

```

### Parameters

**pool\_name** (Required)

Specifies the name of the storage pool that contains data that must be encrypted.

Restrictions:

- You can specify only directory-container storage pools or cloud-container storage pools.
- You can specify up to 30 characters for the storage pool name. If you specify more than 30 characters, the command fails.

**MAXPRocess**

Specifies the maximum number of parallel processes that can occur when the storage pool is encrypting data. This parameter is optional. Enter a value in the range 1 - 99. The default value is 4.

**Preview**

Specifies whether a preview is displayed of all the commands that are processed as part of the ENCRYPT STGPOOL command. This parameter is optional. The following values are possible:

No

Specifies that a preview of the commands is not displayed. This is the default value.

Yes

Specifies that a preview of the commands is displayed.

**Wait**

Specifies whether the storage pool encryption occurs in the foreground or background. This parameter is optional. You can specify one of the following values:

No

Specifies that the operation is completed in the background. You can continue with other tasks while the command is processing. Messages that are related to the background process are displayed in the activity log file or the server console, depending on where the messages are logged. This is the default value.

Yes

Specifies that the operation is completed in the foreground. It might take a long time to complete the operation. The operation must end before you can continue with other tasks. Messages are displayed in the activity log file or the server console, or both, depending on where the messages are logged.

Restriction: You cannot specify the WAIT=YES parameter from the server console.

## Example: Encrypt data in a storage pool

Encrypt data in a storage pool that is named POOL1 and specify a maximum number of 30 parallel processes.

```
encrypt stgpool pool1 maxprocess=30
```

## Related commands

Table 1. Commands related to ENCRYPT STGPOOL

Command	Description
DEFINE STGPOOL (directory-container)	Define a directory-container storage pool.

## END EVENTLOGGING (Stop logging events)

Use this command to stop logging events to an active receiver.

## Privilege class

To issue this command, you must have system privilege.

## Syntax

```
>>-END--EVentlogging-----.-ALL----->>
| .,-----|
| V          |
|-----|
|-----+-----+
|++-CONSOLE-----+
|++-ACTLOG-----+
|++-EVENTSERVER----+
|++-FILE-----+
|++-FILETEXT-----+
| | (1) |
|++-NTEVENTLOG-----+
| | (2) |
|++-SYSLOG-----+
|++-TIVOLI-----+
|'-USEREXIT-----'|
```

Notes:

1. This parameter is only available for Windows operating system.
2. This parameter is only available for the Linux operating system.

## Parameters

Specify a type of receiver. You can specify multiple receivers by separating them with commas and no intervening spaces. This is an optional parameter. The default is ALL. If you specify ALL or no receiver, logging ends for all receivers.

ALL

Specifies all receivers.

CONSOLE

Specifies the server console as a receiver.

## ACTLOG

Specifies the IBM Spectrum Protect™ activity log as a receiver. Logging can be stopped only for client events.

## EVENTSERVER

Specifies the event server as a receiver.

## FILE

Specifies a user file as a receiver. Each logged event is a record in the file and a person cannot read each logged event easily.

## FILETEXT

Specifies a user file as a receiver. Each logged event is a fixed-size, readable line.

## Windows NTEVENTLOG

Specifies the Windows application log as a receiver.

## Linux SYSLOG

Specifies the Linux system log as a receiver.

## TIVOLI

Specifies the Tivoli Management Environment (TME) as a receiver.

## USEREXIT

Specifies a user-written routine to which IBM Spectrum Protect writes information as a receiver.

## Example: Stop logging events

End logging of events to the user exit.

```
end eventlogging userexit
```

## Related commands

Table 1. Commands related to END EVENTLOGGING

Command	Description
BEGIN EVENTLOGGING	Starts event logging to a specified receiver.
DISABLE EVENTS	Disables specific events for receivers.
ENABLE EVENTS	Enables specific events for receivers.
QUERY ENABLED	Displays enabled or disabled events for a specific receiver.
QUERY EVENTRULES	Displays information about rules for server and client events.
QUERY STATUS	Displays the settings of server parameters, such as those selected by the SET commands.

## EXPIRE INVENTORY (Manually start inventory expiration processing)

Use this command to manually start inventory expiration processing. The inventory expiration process removes client backup and archive file copies from server storage. Removal is based on policy specifications in the backup and archive copy groups of the management classes to which the files are bound.

When you have the disaster recovery manager function for your IBM Spectrum Protect™ server, the inventory expiration process also removes eligible virtual volumes that are used by the following processes:

- Database backups of type BACKUPFULL, BACKUPINCR, and DBSNAPSHOT. The SET DRMDBBACKUPEXPIREDAYS command controls when these volumes are eligible for expiration.
- Recovery plan files of type RPFIL and RPFNSNAPSHOT. The SET DRMRPFEXPIREDAYS command controls when these volumes are eligible for expiration.

The inventory expiration process that runs during server initialization does not remove these virtual volumes.

Only one expiration process is allowed at any time, but this process can be distributed among a maximum of 40 threads. If an expiration process is running, you cannot start another process.

You can set up automatic expiration processing with the EXPINTERVAL server option. If you set the EXPINTERVAL option to 0, the server does not run expiration automatically, and you must issue the EXPIRE INVENTORY command to start expiration processing.

This command creates a background process that can be canceled with the CANCEL PROCESS command. To display information about background processes, use the QUERY PROCESS command.

If this command is applied to a WORM volume, the volume returns to being a scratch volume if it has remaining space in which data can be written. Data on WORM volumes, including deleted and expired data, cannot be overwritten. Therefore, data can be written only in space that does not contain current, deleted, or expired data. If a WORM volume does not have any space available in which data can be written, it remains private. To remove the volume from the library, you must use the CHECKOUT LIBVOLUME command.

Run the EXPIRE INVENTORY command to delete files from server storage if they were not deleted when you used client delete operations.

For more information about client delete operations, see Backup-archive client options and commands.

## Privilege class

---

To issue this command, you must have system privilege.

## Syntax

---

```

      .-Quiet-----No-----.
>>-EXPIre Inventory--+-+-----+----->
      '-Quiet-----+No--+-'
                          '-Yes-'

      .-Wait-----No-----.  .-Nodes-----*-----.
>--+-+-----+-----+----->
      '-Wait-----+No--+-'  '-Nodes-----+node_name-----+-'
                          '-node_group_name-'

>--+-+-----+-----+----->
      '-EXCLUDENodes-----excluded_node_name-'

      .-Type-----All-----.
>--+-+-----+-----+----->
      '-Dmain-----domain_name-'  '-Type-----+All-----+-'
                                      +-Archive-+
                                      +-Backup--+
                                      '-Other---'

      .-Resource-----4-----.  .-Skipdirs-----No-----.
>--+-+-----+-----+----->
      '-Resource-----number-'  '-Skipdirs-----+No--+-'
                                      '-Yes-'

>--+-+-----+-----+-----><
      '-Duration-----minutes-'

```

## Parameters

---

### Quiet

Specifies whether the server suppresses detailed messages about policy changes during the expiration processing. This parameter is optional. The default is NO. Possible values are:

#### No

Specifies that the server sends detailed informational messages.

#### Yes

Specifies that the server sends only summary messages. The server issues messages about policy changes only when files are deleted and either the default management class or retention grace period for the domain was used to expire the files.

You can also specify the EXPQUIET option in the server options file to automatically determine whether expiration processing is run with summary messages.

### Wait

Specifies whether to wait for the server to complete processing this command in the foreground. This parameter is optional. The default value is NO. Possible values are:

No

Specifies that the server processes this command in the background. You can continue with other tasks while the command is being processed.

The server displays messages that are created from the background process either in the activity log or the server console, depending on where messages are logged.

Yes

Specifies that the server processes this command in the foreground. You wait for the command to complete before you continue with other tasks. The server then displays the output messages to the administrative client when the command completes.

Restriction: You cannot specify WAIT=YES from the server console.

SKipdirs

Specifies whether the server skips directory type objects during the expiration processing. This parameter is optional. The default is NO. Possible values are:

No

Specifies that the server expires files and directories that are based on the appropriate policy criteria.

Yes

Specifies that the server skips directory type backup and archive objects during expiration processing, even if the directories are eligible for expiration. By specifying YES, you prevent deletion of directories, and expiration processing can occur more quickly.

Attention: Do not use this option all of the time. With IBM Spectrum Protect Version 6.0 and later, you can run multiple threads (resources) for an expiration process. Also, if you specify YES often, the database grows as the directory objects accumulate, and the time that is spent for expiration increases. Run SKIPDIRS=NO periodically to expire the directories and reduce the size of the database.

Nodes

Specifies the name of the client nodes or node groups whose data is to be processed. To specify multiple node and node group names, separate the names with commas and no intervening spaces. Node names can contain wildcard characters, but node group names cannot. This parameter is optional.

You can specify NODES, EXCLUDENODES, DOMAIN, or any combination. If you specify more than one of these parameters, only those nodes that match the criteria for both NODES and DOMAIN and does not match the criteria for EXCLUDENODES command options are processed. If you do not specify NODES, EXCLUDENODES, or DOMAIN with a value, data for all nodes is processed.

EXCLUDENodes

Specifies the name of the client nodes or node groups whose data is not to be processed. To specify multiple node and node group names, separate the names with commas and no intervening spaces. Node names can contain wildcard characters, but node group names cannot. This parameter is optional.

You can specify NODES, EXCLUDENODES, DOMAIN, or any combination. If you specify more than one of these parameters, only those nodes that match the criteria for both NODES and DOMAIN and does not match the criteria for EXCLUDENODES command options are processed. If you do not specify NODES, EXCLUDENODES, or DOMAIN with a value, data for all nodes is processed.

Domain

Specifies that only data for client nodes that are assigned to the specified domain is to be processed. This parameter is optional. You can specify NODES, EXCLUDENODES, DOMAIN, or any combination. If you specify more than one of these parameters, only those nodes that match the criteria for both NODES and DOMAIN and does not match the criteria for EXCLUDENODES command options are processed. If you do not specify NODES, EXCLUDENODES, or DOMAIN with a value, data for all nodes is processed.

Type

Specifies the type of data to be processed. This parameter is optional. The default value is ALL. Possible values are:

ALL

Process all types of data that is eligible for expiration

Archive

Process only client archive data

Backup

- Process only client backup data
- Other
  - Process only items for disaster recovery manager functions, such as recovery plan files and obsolete database backups

#### REsource

Specifies the number of threads that can run in parallel. Specify a value in the range 1 - 40. This parameter is optional. The default is four.

Expiration runs as a single process, although the resources represent parallel work by the server within the single expiration process. Archive data for a node runs only on a single resource, but backup data can be spread across resources on a file space level. For example, if you specify `NODE=X, Y, Z` each with three file spaces and `RESOURCE=5`, then expiration processing for the three X, Y, and Z client nodes runs in parallel. At least one resource processes each node, and at least one node uses multiple resources for processing backup data across the multiple file spaces.

#### DUration

Specifies the maximum number of minutes for the expiration process to run. The process stops when the specified number of minutes pass or when all eligible expired objects are deleted, whichever comes first. Specify a value in the range 1 - 2880. This parameter is optional. If this parameter is not specified, the duration of the expiration process is not limited by time.

### Example: Run inventory expiration processing for a specific time period

---

Run the expiration process for two hours.

```
expire inventory duration=120
```

### Example: Run inventory expiration processing for backup data for two client nodes

---

Run inventory expiration processing for the backup data for two client nodes, CHARLIE and ROBBIE. Allow the server to run expiration processing until completed.

```
expire inventory nodes=charlie,robbie resource=2 type=backup
```

### Example: Run inventory expiration processing for all client nodes except two nodes

---

Run inventory expiration processing for all client nodes except two nodes, CHARLIE and ROBBIE. Allow the server to run expiration processing until completed.

```
expire inventory excludenodes=charlie,robbie
```

### Example: Run inventory expiration processing for all client nodes in a domain except one node

---

Run inventory expiration processing for all client nodes in a domain except one node, ROBBIE. Allow the server to run expiration processing until completed.

```
expire inventory domain=standard excludenodes=robbie
```

### Related commands

---

Table 1. Commands related to EXPIRE INVENTORY

Command	Description
AUDIT LICENSES	Verifies compliance with defined licenses.
CANCEL EXPIRATION	Cancels inventory expiration processing.
CANCEL PROCESS	Cancels a background server process.
QUERY PROCESS	Displays information about background processes.

## EXPORT commands

---

Use the EXPORT commands to copy information from an IBM Spectrum Protect™ server to sequential removable media.



Important: For commands that export administrators or nodes, you must consider the method of authentication. The IBM Spectrum Protect server cannot export or import passwords for nodes or administrators that are authenticating with LDAP directory servers. If the current authentication method uses an LDAP directory server and the password is not already synchronized by that server, you must update the password. After issuing the EXPORT command, set the password by issuing the UPDATE ADMIN or UPDATE NODE command.

- EXPORT ADMIN (Export administrator information)
- EXPORT NODE (Export client node information)
- EXPORT POLICY (Export policy information)
- EXPORT SERVER (Export server information)

## EXPORT ADMIN (Export administrator information)

Use this command to export administrator and authority definitions from a server. You can export the information to sequential media for later importing to another server, or you can export the information directly to another server for immediate import.

Important: For commands that export administrators or nodes, you must consider the method of authentication. The IBM Spectrum Protect™ server cannot export or import passwords for nodes or administrators that are authenticating with LDAP directory servers. If the current authentication method uses an LDAP directory server and the password is not already synchronized by that server, you must update the password. After issuing the EXPORT command, set the password by issuing the UPDATE ADMIN or UPDATE NODE command.

IBM Spectrum Protect exports administrator information such as:

- Administrator name, password, and contact information
- Administrative privilege classes that are granted to the administrator
- Whether the administrator ID is locked from server access

You can use the QUERY ACTLOG command to view the status of the export operation. You can also view this information from the server console.

This command generates a background process that can be canceled with the CANCEL PROCESS command. If you export information to sequential media and the background process is canceled, the sequential media that is holding the exported data is incomplete, it must not be used for importing data. If a server-to-server export background process is canceled, a partial import might result. Evaluate any imported data on the target server to determine whether you want to keep or delete the imported data. Review the import messages for details. To display information about background processes, use the QUERY PROCESS command.

The following restrictions apply to the export function:

- Export operations from a later version and release to an earlier version and release is not supported.
- Export operations between servers that are at the same version and release but with different fix packs might fail. For example, you cannot export from a V7.1.3 server to a V7.1.1 or earlier server.
- Exported data from a server with retention protection enabled is not protected by retention when it is imported to another server.
- Export processing excludes nodes of type network-attached storage (NAS).
- Exporting data to a Centera device class or importing data from a Centera device class is not supported. However, files that are stored in Centera storage pools can be exported and files that must be imported can be stored on a Centera storage device.

Limitation: The IBM Spectrum Protect server does not convert code pages during export, import, and node replication operations. If servers are running in different locales, some information in databases or system output might become unreadable. Invalid characters might be displayed, for example, in the contact information for the administrator and client nodes, and in descriptions of policy domains. Any field that is stored in the server character set and that includes extended ASCII characters can be affected. To resolve the issue after the import or node replication operation, update the fields with the appropriate UPDATE commands. This server limitation does not affect client data. Any client data that was exported, imported, or replicated can be restored, retrieved, and recalled.

The EXPORT ADMIN command takes two forms: Export directly to another server on the network, or export to sequential media. The syntax and parameters for each form are defined separately.

Table 1. Commands related to EXPORT ADMIN

Command	Description
CANCEL PROCESS	Cancels a background server process.



Notes:

1. If PREVIEW=NO, a device class must be specified.
2. If PREVIEW=NO and SCRATCH=NO, one or more volumes must be specified.

## Parameters

### admin\_name

Specifies the administrators for which information is to be exported. This parameter is optional. The default is all administrators.

Separate the items in the list by commas, with no intervening spaces. You can use wildcard characters to specify names.

### Preview

Specifies whether to preview the results of the export operation, without exporting information. You can use this parameter to preview how many bytes of data are transferred, and determine how many volumes are required. The following parameter values are supported:

#### No

Specifies that the administrator information is to be exported. If you specify this value, you must specify a device class.

#### Yes

Specifies that the operation is previewed but not completed. Information is reported to the server console and the activity log. If you specify this value, you do not need to specify a device class.

This parameter is optional. The default value is NO.

### DEVclass

Specifies the device class to which export data is to be written. This parameter is required if you specify PREVIEW=NO.

You cannot specify the DISK, NAS, or CENTERA device classes.

If all drives for the device class are busy when the export runs, IBM Spectrum Protect™ cancels lower priority operations to make a drive available.

Tip: You can export data to a storage pool on another server by specifying a device class whose device type is SERVER.

### Scratch

Specifies whether scratch volumes can be used. The default value is YES. You can specify one of the following values:

#### Yes

Specifies that scratch volumes can be used for export. If you also specify a list of volumes, scratch volumes are used only if there is not enough space on the volumes specified.

#### No

Specifies that scratch volumes cannot be used for export. To determine how many volumes you might need, you can run the command specifying PREVIEW=YES.

### VOLumenames

Specifies the volumes to be used to contain exported data. This parameter is optional, unless you specify SCRATCH=NO and PREVIEW=NO. If you do not specify a volume name, scratch volumes are used.

You can specify one of the following values:

#### volume\_name

Specifies the volume name. To specify multiple volumes, separate the names with commas and no intervening spaces.

#### FILE:file\_name

Specifies the name of a file that contains a list of volumes. In the file, each volume name must be on a separate line. Blank and comment lines that begin with an asterisk are ignored.

Use these naming conventions when specifying volumes associated with the following device types:

For this device	Specify
Tape	1-6 alphanumeric characters.

For this device	Specify
FILE	Any fully qualified file name string. For example: <div style="display: flex; justify-content: space-around; margin-top: 5px;"> <span>AIX</span> <span>Linux</span> </div> /imdata/mt1. <div style="display: flex; justify-content: space-around; margin-top: 5px;"> <span>Windows</span> </div> d:\program files\tivoli\tsm\data1.dsm.
<div style="display: flex; justify-content: space-around; margin-bottom: 5px;"> <span>AIX</span> <span>Linux</span> <span>Windows</span> </div> REMOVABLEFILE	<div style="display: flex; justify-content: space-around; margin-bottom: 5px;"> <span>AIX</span> <span>Linux</span> <span>Windows</span> </div> 1-6 alphanumeric characters.
SERVER	1-250 alphanumeric characters.

#### USEDVolumelist

Specifies the file where a list of volumes used in the export operation are stored. This parameter is optional.

This file can be used in the import operation. This file contains comment lines with the date and time the export was done, and the command issued to create the export.

Attention: If you specify an existing file, the file is overwritten.

#### ENCrptionstrength

Indicates which algorithm to use to encrypt passwords when exporting administrative and node records. This parameter is optional. The default value is AES. If you are exporting to a server that does not support AES, specify DES. You can specify one of the following values:

AES

Specifies the Advanced Encryption Standard.

DES

Specifies the Data Encryption Standard.

## Example: Export administrator definitions to tape volumes

From the server, export the information for all defined administrators to tape volumes TAPE01, TAPE02, and TAPE03. Specify that these tape volumes be read by a device that is assigned to the MENU1 device class. The number and types of objects that are exported are reported to the system console and in the activity log. Issue the command:

```
export admin devclass=menu1
volumenames=tape01,tape02,tape03
```

## Example: Export administrator definitions to tape volumes listed in a file

From the server, export the information for all defined administrators to tape volumes that are listed in the following file:

- TAPEVOL
- TAPEVOL.DATA

This file contains the following lines:

```
TAPE01
TAPE02
TAPE03
```

Specify that these tape volumes be used by a device that is assigned to the MENU1 device class. Issue the command:

```

export admin devclass=menu1 volumenames=file:tapevol
```

```

export admin devclass=menu1 volumenames=file:tapevol.data
```

The number and types of objects that are exported are reported to the system console and in the activity log.

## EXPORT ADMIN (Export administrator information directly to another server)

Use this command to export administrator and authority definitions directly to another server on the network. This results in an immediate import on the target server.

You can issue a QUERY PROCESS command from the target server to monitor the progress of the import operation. See EXPORT ADMIN (Export administrator information) for a list of restrictions that apply to the export function.

## Privilege class

To issue this command, you must have system privilege.

## Syntax

```
.*-----
>>-EXPort Admin----->
    | .,----- |
    | V          |
    |---admin_name---|

.-PREVIEWImport----No-----
>----->
'-TOserver----servername-' '-PREVIEWImport----+No--+-'
                              '-Yes-'

.-Replacedefs----No-----
>----->
'-Replacedefs----+No--+-'
                              '-Yes-'

.-ENCryptionstrength----AES-----
>----->
'-ENCryptionstrength----+AES--+-'
                              '-DES-'
```

## Parameters

### admin\_name

Specifies the administrators for which information is to be exported. This parameter is optional. The default is all administrators.

Separate the items in the list by commas, with no intervening spaces. You can use wildcard characters to specify names.

### TOServer

Specifies the name of a server to which the export data is sent directly over the network for immediate import.

Important: The target server must be defined on the originating server with the DEFINE SERVER command. The administrator that issues the export command must be defined with the same administrator name and password and have system authority on the target server.

When you specify TOSERVER, you cannot specify the DEVCLASS, VOLUMENAMES, and SCRATCH, USEDVOLUMELIST, and PREVIEW parameters.

### PREVIEWImport

Specifies whether to view how much data is transferred, without actually moving any data. This information can be used to determine how much storage pool space is required on the target server. The default is NO.

Valid values are:

#### Yes

Specifies that you want to preview the results of the import operation on the target server, without importing the data. Information is reported to the server console and the activity log.

#### No

Specifies that you want the data to be imported on the target server without previewing the results.

### Replacedefs

Specifies whether to replace definitions (not file data) on the server. The default is NO.

Valid values are:

#### Yes

Specifies that definitions are replaced on the server if definitions having the same name as those being imported exist on the target server.

No

Specifies that imported definitions are skipped if their names conflict with definitions that are already defined on the target server.

#### ENCryptionstrength

Indicates which algorithm to use to encrypt passwords when exporting administrative and node records. This parameter is optional. The default value is AES. If you are exporting to a server that does not support AES, specify DES. You can specify one of the following values:

AES

Specifies the Advanced Encryption Standard.

DES

Specifies the Data Encryption Standard.

## Example: Export administrator definitions to a target server

---

Export all the administrator definitions to the target server defined as OTHERSERVER. Preview the import operations on the target server. Issue the command:

```
export admin * toserver=otherserver previewimport=yes
```

From the target server, OTHERSERVER, you can view the import operations by issuing the command:

```
query process
```

## EXPORT NODE (Export client node information)

---

Use this command to export client node definitions or file data to sequential media or directly to another server for immediate import.

**Important:** For commands that export administrators or nodes, you must consider the method of authentication. The IBM Spectrum Protect™ server cannot export or import passwords for nodes or administrators that are authenticating with LDAP directory servers. If the current authentication method uses an LDAP directory server and the password is not already synchronized by that server, you must update the password. After issuing the EXPORT command, set the password by issuing the UPDATE ADMIN or UPDATE NODE command.

The following information is included in each client node definition:

- User ID, password, and contact information.
- Name of the client's assigned policy domain.
- File compression status.
- Whether the user has the authority to delete backed-up or archived files from server storage.
- Whether the client node ID is locked from server access.

Optionally, you can also export the following items:

- File space definitions.
- Backed-up, archived, and files that were migrated by an IBM Spectrum Protect for Space Management client.
- Access authorization information that pertains to the file spaces exported.
- Archive data that is in deletion hold status (the hold status is preserved). When the archive data is imported, it remains in deletion hold.

If you use an LDAP directory server to authenticate passwords, any servers that you export to must be configured for LDAP passwords. Node data that is exported from a node that authenticates with an LDAP directory server is inaccessible if the target server is not properly configured. If your target server is not configured, exported data from an LDAP node can still be exported. But the target server must be configured to use LDAP, to access the data.

The following restrictions apply to the export function:

- Export operations from a later version and release to an earlier version and release is not supported.
- Export operations between servers that are at the same version and release but with different fix packs might fail. For example, you cannot export from a V7.1.3 server to a V7.1.1 or earlier server.

- Exported data from a server with retention protection enabled is not protected by retention when it is imported to another server.
- Export processing excludes nodes of type network-attached storage (NAS).
- Exporting data to a Centera device class or importing data from a Centera device class is not supported. However, files that are stored in Centera storage pools can be exported and files that must be imported can be stored on a Centera storage device.
- The EXPORT NODE and EXPORT SERVER commands do not export data from a shred pool unless you explicitly allow it by setting the ALLOWSHREDDABLE parameter to the YES value. If this value is specified, and the exported data includes data from shred pools, that data cannot be shredded. A warning is not issued if the export operation includes data from shred pools.
- Incrementally exporting or importing the following types of client data to another IBM Spectrum Protect server is not supported:
  - VMware backups where full plus incremental backups need to be periodically, incrementally transferred to another server
  - Backups groups where full plus differential backups must be periodically, incrementally transferred to another server
  - Windows System State data that is periodically, incrementally transferred to another server

Full export or import of this data to a new file system on the target is supported by exporting the entire file space that contains the data. The export must not use the FILEDATA=ALLACTIVE, FROMDATE, TODATE, or MERGEFILESPPACES parameters.

Using node replication to incrementally transfer this type of client data between two servers is optimal.

Limitation: The IBM Spectrum Protect server does not convert code pages during export, import, and node replication operations. If servers are running in different locales, some information in databases or system output might become unreadable. Invalid characters might be displayed, for example, in the contact information for the administrator and client nodes, and in descriptions of policy domains. Any field that is stored in the server character set and that includes extended ASCII characters can be affected. To resolve the issue after the import or node replication operation, update the fields with the appropriate UPDATE commands. This server limitation does not affect client data. Any client data that was exported, imported, or replicated can be restored, retrieved, and recalled.

The EXPORT NODE command generates a background process that can be canceled with the CANCEL PROCESS command. If you are exporting node information to sequential media and the background process is canceled, the sequential media that is holding the exported data is incomplete, it must not be used to import data. If a server-to-server export background process is canceled, a partial import might result. Evaluate any imported data on the target server to determine whether you want to keep or delete the imported data. Review the import messages for details. To display information about background processes, issue the QUERY PROCESS command.

To display information about any running and suspended server-to-server export operations, issue the QUERY EXPORT command. The QUERY EXPORT command displays information only for exports that are, or can be, suspended. Export operations that can be suspended, and then restarted, are those server-to-server exports whose FILEDATA has a value other than NONE. You can issue the QUERY ACTLOG command to view the status of the export operation.

Because of unpredictable results, do not run expiration, migration, backup, or archive when you are issuing the EXPORT NODE command.

For a server that has clients with support for Unicode, you can get the server to convert the file space name that you enter, or use one of the following parameters:

- FSID
- UNIFILESPACE

The EXPORT NODE command takes two forms: export directly to another server on the network, or export to sequential media. The syntax and parameters for each form are defined separately.

Table 1. Commands related to EXPORT NODE

Command	Description
CANCEL EXPORT	Deletes a suspended export operation.
CANCEL PROCESS	Cancels a background server process.
COPY ACTIVATEDATA	Copies active backup data.

Command	Description
EXPORT ADMIN	Copies administrative information to external media or directly to another server.
EXPORT POLICY	Copies policy information to external media or directly to another server.
EXPORT SERVER	Copies all or part of the server to external media or directly to another server.
IMPORT NODE	Restores client node information from external media.
QUERY ACTLOG	Displays messages from the server activity log.
QUERY EXPORT	Displays the export operations that are currently running or suspended.
QUERY PROCESS	Displays information about background processes.
RESTART EXPORT	Restarts a suspended export operation.
SUSPEND EXPORT	Suspends a running export operation.

- EXPORT NODE (Export node definitions to sequential media)  
You can export node definitions or file data from a server to sequential media for later importing to another server.
- EXPORT NODE (Export node definitions or file data directly to another server)  
Use this command to export client node definitions or file data directly to another server for immediate import.

## EXPORT NODE (Export node definitions to sequential media)

You can export node definitions or file data from a server to sequential media for later importing to another server.

### Privilege class

To issue this command, you must have system privilege.

### Syntax

```

>>-EXPort Node----->
      .-*,-----
      | .-,----- |
      | v          | |
      |---node_name-+-|

>+----->
      | .-*,----- |
      | v          | |
      |-FILESpace--==---file_space_name-+-|

>+----->
      | .-*,----- |
      | v          | |
      |-FSID--==---file_space_ID-+-|

>+----->
      | .-*,----- |
      | v          | |
      |-UNIFILESpace--==---file_space_name-+-|

>+----->
      | .-*,----- |
      | v          | |
      |-DObains--==---domain_name-+-|

      .-FILEData--==None-----
>+----->
      |-FILEData--==+All-----+
      +-None-----+

```





Specifies the file spaces by using their file space IDs (FSIDs). The server uses the FSIDs to find the file spaces to export. To find the FSID for a file space, use the QUERY FILESPACE command. Separate multiple file space IDs with commas and no intervening spaces. This parameter is optional.

#### UNIFILESpace

Specifies the file spaces that are known to the server as Unicode enabled. The server converts the names that you enter from the server code page to the UTF-8 code page to find the file spaces to export. The success of the conversion depends on the actual characters in the name and the server's code page. Separate multiple names with commas and no intervening spaces. A wildcard character can be used to specify a name. This parameter is optional.

#### DOmains

Specifies the policy domains from which nodes are to be exported. This parameter is optional. Separate multiple names with commas and no intervening spaces. If you specify domains, a node is exported only if it belongs to one of the specified domains. You can use wildcard characters to specify a name.

#### FILEData

Specifies the type of files that are to be exported for all nodes that are being exported to the server. This parameter is optional. The default value is NONE.

Note: If you are exporting a node that has group data, data that is not a part of the target objects might be exported. An example of group data is virtual machine data or system state backup data. For example, if FILEDATA=BACKUPACTIVE when the FROMDATE or TODATE parameters are specified, it is possible to include inactive backup data. The incremental backup processing for the data can cause extra files that do not meet the filtering criteria to be exported.

If you are exporting to sequential media: the device class that is used by the file data is determined by the device class for the storage pool. If it is the same device class that is specified in this command, two drives are needed to export node information. The mount limit for the device class must be at least 2.

Important: If client nodes registered as TYPE=SERVER are being exported, specify ALL, ARCHIVE, or ALLACTIVE.

The following descriptions mention *active* and *inactive* backup file versions. An active backup file version is the most recent backup version for a file that still exists on the client workstation. All other backup file versions are called inactive copies. This parameter supports the following values:

#### ALL

The server exports all backup versions of files, all archived files, and all files that were migrated by an IBM Spectrum Protect™ for Space Management client.

#### None

The server does not export files, only node definitions.

#### ARChive

The server exports only archived files.

#### Backup

The server exports only backup versions, whether active or inactive.

#### BACKUPActive

The server exports only active backup versions. These active backup versions are the active versions in the IBM Spectrum Protect database at the time that the EXPORT command is issued.

#### ALLActive

The server exports all active backup versions of files, all archived files, and all files that were migrated by an IBM Spectrum Protect for Space Management client. The active backup versions are the active versions in the IBM Spectrum Protect database at the time that the EXPORT command is issued.

#### SPacemanaged

The server exports only files that were migrated by an IBM Spectrum Protect for Space Management client.

#### Preview

Specifies whether to preview the results of the export operation, without exporting information. You can use this parameter to preview how many bytes of data would be transferred so that you can determine how many volumes are required. This parameter supports the following values:

#### No

Specifies that the node information is to be exported. If you specify this value, you must also specify a device class.

#### Yes

Specifies that the operation is previewed but not completed. Information is reported to the server console and the activity log. If you specify this value, you do not need to specify a device class.

This parameter is optional. The default value is NO.

#### DEVclass

Specifies the device class to which export data is to be written. This parameter is required if you specify PREVIEW=NO.

You cannot specify the DISK, NAS, or CENTERA device classes.

If all drives for the device class are busy when the export runs, IBM Spectrum Protect cancels lower priority operations to make a drive available.

Tip: You can export data to a storage pool on another server by specifying a device class whose device type is SERVER.

**Scratch**

Specifies whether scratch volumes can be used. The default value is YES. You can specify one of the following values:

**Yes**

Specifies that scratch volumes can be used for export. If you also specify a list of volumes, scratch volumes are used only if there is not enough space on the volumes specified.

**No**

Specifies that scratch volumes cannot be used for export. To determine how many volumes you might need, you can run the command specifying PREVIEW=YES.

**VOLumentnames**

Specifies the volumes to be used to contain exported data. This parameter is optional, unless you specify SCRATCH=NO and PREVIEW=NO. If you do not specify a volume name, scratch volumes are used.

You can specify one of the following values:

**volume\_name**

Specifies the volume name. To specify multiple volumes, separate the names with commas and no intervening spaces.

**FILE:file\_name**

Specifies the name of a file that contains a list of volumes. In the file, each volume name must be on a separate line. Blank and comment lines that begin with an asterisk are ignored.

Use these naming conventions when specifying volumes associated with the following device types:

For this device	Specify
Tape	1-6 alphanumeric characters.
FILE	Any fully qualified file name string. For example: <div style="background-color: #f0f0f0; padding: 2px; margin: 5px 0;"> <span style="background-color: #d3d3d3; padding: 2px;">AIX</span>   <span style="background-color: #d3d3d3; padding: 2px;">Linux</span> /imdata/mt1.  <span style="background-color: #d3d3d3; padding: 2px;">Windows</span> d:\program files\tivoli\tsm\data1.dsm. </div>
<div style="background-color: #f0f0f0; padding: 2px; margin: 5px 0;"> <span style="background-color: #d3d3d3; padding: 2px;">AIX</span>   <span style="background-color: #d3d3d3; padding: 2px;">Linux</span>   <span style="background-color: #d3d3d3; padding: 2px;">Windows</span> </div> REMOVABLEFILE	<div style="background-color: #f0f0f0; padding: 2px; margin: 5px 0;"> <span style="background-color: #d3d3d3; padding: 2px;">AIX</span>   <span style="background-color: #d3d3d3; padding: 2px;">Linux</span>   <span style="background-color: #d3d3d3; padding: 2px;">Windows</span> </div> 1-6 alphanumeric characters.
SERVER	1-250 alphanumeric characters.

**USEDVolumelist**

Specifies the file where a list of volumes used in the export operation are stored. This parameter is optional.

This file can be used in the import operation. This file contains comment lines with the date and time the export was done, and the command issued to create the export.

Attention: If you specify an existing file, the file is overwritten.

**FROMDate**

Specifies the earliest date for which files to be exported were stored on the server. Files that were stored on the server earlier than the specified date are not exported. This parameter only applies to client file data. This parameter does not affect other information that might be exported, for example, policy. IBM Spectrum Protect ignores the FROMDATE parameter when the FILEDATA parameter is set to NONE.

Directory processing: The FROMDATE parameter does not apply to directories. All directories in a file space are processed even if the directories were not backed up in the specified date range.

Important: If you have group data on the node that you are exporting, data that was backed up before the designated FROMDATE and FROMTIME can also be exported. Group data on the node is, for example, virtual machine data or system state backup data. This export is a result of incremental backup processing for the data. The incremental backup processing can cause extra files that do not meet the filtering criteria to be exported, so that there is a consistent image for the backup data.

Use one of the following values to specify the date:

Value	Description	Example
-------	-------------	---------

Value	Description	Example
MM/DD/YYYY	A specific date	09/15/1998
TODAY	The current date	TODAY
TODAY-days <b>or</b> -days	The current date minus days specified. The maximum number of days you can specify is 9999.	TODAY -3 <b>or</b> -3.
EOLM (End Of Last Month)	The last day of the previous month.	EOLM
EOLM-days	The last day of the previous month minus days specified.	EOLM-1 To include files that were active a day before the last day of the previous month.
BOTM (Beginning Of This Month)	The first day of the current month.	BOTM
BOTM+days	The first day of the current month, plus days specified.	BOTM+9 To include files that were active on the 10th day of the current month.

If this parameter is not specified, IBM Spectrum Protect exports all objects stored before the TODATE parameter and as qualified by the FILEDATA parameter. If no TODATE parameter is specified, then all data as qualified by the FILEDATA parameter is exported.

When a server-to-server export operation uses a relative FROMDATE, for example, TODAY-1, and the operation is restarted at a later date, the restarted process still uses the date that was used during the original operation. For example, if a server-to-server export operation is started on 07/04/2009 and the FROMDATE is specified as TODAY-1, the date that is used for selecting files is 07/03/2009. If this same export operation is suspended and restarted ten days later (07/14/2009), the date that is used for selecting files is still 07/03/2009. This behavior ensures that the entire export operation uses the same cutoff date for selecting files to export.

#### TODate

Specifies the latest date for files to be exported from the server. Files stored on the server on a date later than the TODATE value are not exported. TODATE only applies to client file data and does not affect other information that is being exported, such as policy.

- IBM Spectrum Protect ignores the TODATE parameter when the FILEDATA parameter is set to NONE.
- If a TODATE parameter is specified without a TOTIME parameter, the server exports all objects that are inserted on or before the day specified by the TODATE parameter.
- If you specified the FROMDATE parameter, the value of TODATE must be later than or equal to the FROMDATE value. If the TODATE and FROMDATE are equal, then the TOTIME parameter must be later than the FROMTIME parameter.
- The TODATE parameter does not apply to directories. All directories in a file space are processed even if the directories were not backed up in the specified date range.

Important: If you have group data on the node that you are exporting, data that was backed up after the TODATE or TOTIME parameters can be exported. An example of group data is virtual machine data or system state backup data. The incremental backup processing can cause extra files that do not meet the filtering criteria to be exported, so that there is a consistent image for the backup data.

Use one of the following values to specify the date:

Value	Description	Example
MM/DD/YYYY	A specific date	10/15/2006
TODAY	The current date	TODAY
TODAY-days <b>or</b> -days	The current date minus days specified. The maximum number of days you can specify is 9999.	TODAY -3 <b>or</b> -3.

Value	Description	Example
EOLM (End Of Last Month)	The last day of the previous month.	EOLM
EOLM-days	The last day of the previous month minus days specified.	EOLM-1 To include files that were active a day before the last day of the previous month.
BOTM (Beginning Of This Month)	The first day of the current month.	BOTM
BOTM+days	The first day of the current month, plus days specified.	BOTM+9 To include files that were active on the 10th day of the current month.

When a server-to-server export operation uses a relative TODATE, for example, TODAY-1, and the operation is restarted at a later date, the restarted process still uses the date that was used during the original operation. For example, if a server-to-server export operation is started on 07/04/2009 and the TODATE is specified as TODAY-1, the date that is used for selecting files is 07/03/2009. If this same export operation is suspended and restarted 10 days later (07/14/2009), the date that is used for selecting files is still 07/03/2009. This behavior ensures that the entire export operation uses the same cutoff date for selecting files to export.

#### FROMTime

Specifies the earliest time for which objects to be exported were stored on the server. When you specify FROMTIME, you must also use the FROMDATE parameter. This parameter only applies to client file data. This parameter does not affect other information that might be exported, for example, policy. Objects that were stored on the server before the specified time and date are not exported. IBM Spectrum Protect ignores the FROMTIME parameter when the FILEDATA parameter is set to NONE.

Important: If you have group data on the node that you are exporting, data that was backed up before the designated FROMDATE and FROMTIME can also be exported. An example of group data on the node is virtual machine data or system state backup data. This export is a result of incremental backup processing for the data. The incremental backup processing can cause extra files that do not meet the filtering criteria to be exported so that there is a consistent image for the backup data.

The default value for this parameter when used with the FROMDATE parameter is midnight (00:00:00).

Use one of the following values to specify the time:

Value	Description	Example
HH:MM:SS	A specific time	10:30:08
NOW	The current time	NOW
NOW+HH:MM or +HH:MM	The current time plus hours and minutes specified. The FROMTIME+ can only be used with a FROMDATE before today.	NOW+02:00 or +02:00. If you issue this command at 5:00 with FROMTIME=NOW+02:00 or FROMTIME+=02:00, the export operation only contains files that were put on the server after 7:00 on the FROMDATE that you specify.
NOW-HH:MM or -HH:MM	The current time minus hours and minutes specified	NOW -02:00 or -02:00. If you issue this command at 5:00 with FROMTIME=NOW-02:00 or FROMTIME=-2:00, the export includes files that were put on the server after 3:00.

#### TOTime

Specifies the latest time that objects to be exported were stored on the server. You must specify the TODATE parameter in order to use the TOTIME parameter. TOTIME only applies to client file data and does not affect other information that is being exported, such as policy. IBM Spectrum Protect ignores the TOTIME parameter if the FILEDATA parameter is set to NONE.

The default value for this parameter, when used with the TODATE parameter, is midnight minus one second (23:59:59).

Important: The value of the TOTIME and TODATE parameters must be later than the FROMDATE and the FROMTIME value. Use one of the following values to specify the time:

Value	Description	Example
HH:MM:SS	A specific time	10:30:08
NOW+HH:MM <b>or</b> +HH:MM	The current time plus hours and minutes specified.	NOW+02:00 <b>or</b> +02:00.  If you issue this command at 05:00 with FROMTIME=01:00 and TOTIME=NOW+02:00, the export includes files that were stored from 01:00 until 07:00.
NOW-HH:MM <b>or</b> -HH:MM	The current time minus hours and minutes specified.	NOW-02:00 <b>or</b> -02:00.  If you issue this command at 05:00 with FROMTIME=01:00 and TOTIME=NOW-02:00, the export includes files that were stored from 01:00 until 03:00.

#### ENCryptionstrength

Indicates which algorithm to use to encrypt passwords when exporting administrative and node records. This parameter is optional. The default value is AES. If you are exporting to a server that does not support AES, specify DES. You can specify one of the following values:

AES

Specifies the Advanced Encryption Standard.

DES

Specifies the Data Encryption Standard.

#### ALLOWSHREDdable

Specifies whether data from a storage pool that enforces shredding is exported. This parameter supports the following values:

No

Specifies that data is not exported from a storage pool that enforces shredding.

Yes

Specifies that data can be exported from a storage pool that enforces shredding. The data on the export media is not shredded.

This parameter is optional. The default value is NO.

## Example: Export client node information to specific tape volumes

From the server, export client node information to tape volumes TAPE01, TAPE02, and TAPE03. Specify that these tape volumes be used by a device that is assigned to the MENU1 device class.

```
export node devclass=menu1 volumenames=tape01,tape02,tape03
```

## Example: Export client node information by using the FSID

From the server, use the FSID to export active backup versions of file data for client node JOE to tape volume TAPE01. To determine the FSID, first issue a QUERY FILESPACE command.

1. To determine the FSID, issue a QUERY FILESPACE command.

```
query filespace joe
```

Node Name	Filespace Name	FSID	Platform	Filespace Type	Is Filespace Unicode?	Capacity (MB)	Pct Util
JOE	\\joe\c\$	1	WinNT	NTFS	Yes	2,502.3	75.2
JOE	\\joe\d\$	2	WinNT	NTFS	Yes	6,173.4	59.6

2. Export the active backup versions of file data and specify that the tape volume is used by a device that is assigned to the MENU1 device class.

```
export node joe fsid=1,2 filedata=backupactive devclass=menu1
volumenames=tape01
```

## Example: Export client node information to tape volumes listed in a file

---

From the server, export client node information to tape volumes that are listed in the following file:

- **AIX** | **Linux** TAPEVOL
- **Windows** TAPEVOL.DATA

The file contains the following lines:

```
TAPE01
TAPE02
TAPE03
```

Specify that the tape volumes be used by a device that is assigned to the MENU1 device class. Issue the following command:

```
AIX | Linux
export node devclass=menu1 volumenames=file:tapevol

Windows
export node devclass=menu1 volumenames=file:tapevol.data
```

## EXPORT NODE (Export node definitions or file data directly to another server)

---

Use this command to export client node definitions or file data directly to another server for immediate import.

Important: You cannot export nodes of type NAS. Export processing excludes these nodes.

You can suspend and restart a server-to-server export operation that has a FILEDATA value other than NONE. The server saves the state and status of the export operation so that it can be restarted from the point at which the operation failed or was suspended. The export operation can be restarted later by issuing the RESTART EXPORT command.

Important: An export operation is suspended when any of the following conditions are detected:

- A SUSPEND EXPORT command is issued for the running export operation
- Segment preemption - the file that is being read for export is deleted by some other process
- Communication errors on a server-to-server export
- No available mount points
- Necessary volumes are unavailable
- I/O errors encountered

Issue the QUERY EXPORT command to display information on any running and suspended export operations.

The export operation cannot be restarted if the export operation fails before transmitting the eligible node and file space definitions to the target server. You must reenter the command to begin a new export operation.

You can issue a QUERY PROCESS command from the target server to monitor the progress of the import operation. Issue the QUERY EXPORT command to list all restartable server-to-server export operations. See EXPORT ADMIN (Export administrator information) for a list of restrictions that apply to the export function.

## Privilege class

---

To issue this command, you must have system privilege.

## Syntax

---

```

      .-*-----
>>-EXPort Node--+-----+----->
                '-node_name-'
>--+-----+----->
```

```

'-FILESpace----file_space_name-'
>----->
'-FSID----file_space_ID-'
>----->
'-UNIFILESpace----file_space_name-'
>----->
'-DObains----domain_name-'

.-FILEData----None-----
>----->
'-FILEData----+All-----+'
      +-None-----+
      +-ARchive-----+
      +-Backup-----+
      +-BACKUPActive+
      +-ALLActive----+
      '-SPacemanaged-'

>----->
|               .-FROMTime----00:00:00-. |
'-FROMDate----date-----+'
      '-FROMTime----time-----'

>----->
|               .-TOTime----23:59:59-. |
'-TODate----date-----+'
      '-TOTime----time-----'

>----->
'-EXPORTIDentifier----export_identifier-'

               .-PREVIEWImport----No-----
>----->
'-TOServer----servername-' '-PREVIEWImport----+No--+-'
                               '-Yes-'

.-MERGEfilespace----No-----
>----->
'-MERGEfilespace----+No--+-'
      '-Yes-'

.-Replacedefs----No-----
>----->
'-Replacedefs----+No--+-'
      '-Yes-'

.-PROXynodeassoc----No-----
>----->
'-PROXynodeassoc----+No--+-'
      '-Yes-'

.-ENCryptionstrength----AES-----
>----->
'-ENCryptionstrength----+AES--+-'
      '-DES-'

.-ALLOWSHREDdable----No-----
>----->
'-ALLOWSHREDdable----+No--+-'
      '-Yes-'

```

## Parameters

---

### node\_name

Specifies the client node names for which information is to be exported. This parameter is optional. Separate multiple names with commas and no intervening spaces. You can use wildcard characters to specify names. For each node entered, all file spaces in the file space, FSID, and Unicode enabled lists are searched.



Restriction: If you specify a list of node names or node patterns, the server does not report the node names or node patterns that do not match any of the entries in the database. Check the summary statistics in the activity log to verify that the server exported all intended nodes.

#### FILESpace

Specifies the file spaces for which data is to be exported. This parameter is optional. Separate multiple names with commas and no intervening spaces. You can use wildcard characters to specify a name.

Restriction: If a file space is specified, no Unicode enabled file spaces are exported.

#### FSID

Specifies the file spaces by using their file space IDs (FSIDs). The server uses the FSIDs to find the file spaces to export. To find the FSID for a file space, use the QUERY FILESPACE command. Separate multiple file space IDs with commas and no intervening spaces. This parameter is optional.

#### UNIFILESpace

Specifies the file spaces that are known to the server to be Unicode enabled. The server converts the names that you enter from the server code page to the UTF-8 code page to find the file spaces to export. The success of the conversion depends on the actual characters in the name and the server's code page. Separate multiple names with commas and no intervening spaces. A wildcard character can be used to specify a name. This parameter is optional.

#### DOmains

Specifies the policy domains from which nodes are exported. This parameter is optional. Separate multiple names with commas and no intervening spaces. If you specify domains, IBM Spectrum Protect™ exports a node only if it belongs to one of the specified domains. You can use wildcard characters to specify a name.

#### FILEData

Specifies the type of files to export for all nodes. This parameter is optional. The default value is NONE.

Note: If you are exporting a node that has group data, data that is not a part of the target objects might be exported. An example of group data is virtual machine data or system state backup data. For example, if FILEDATA=BACKUPACTIVE when the FROMDATE or TODATE parameters are specified, it is possible to include inactive backup data. The incremental backup processing for the data can cause extra files that do not meet the filtering criteria to be exported.

If you are exporting to sequential media, the device class that is used by the file data is determined by the device class for the storage pool. If it is the same device class that is specified in this command, IBM Spectrum Protect requires two drives to export node information. The mount limit for the device class must be at least 2.

Important: If you export client nodes that are registered as TYPE=SERVER, specify ALL, ARCHIVE, or ALLACTIVE.

The following descriptions mention *active* and *inactive* backup file versions. An active backup file version is the most recent backup version for a file that still exists on the client workstation. All other backup file versions are called inactive copies.

The values are as follows:

#### ALL

The server exports all backup versions of files, all archived files, and all files that are migrated by an IBM Spectrum Protect for Space Management client.

#### None

The server does not export files, only node definitions.

#### ARchive

The server exports only archived files.

#### Backup

The server exports only backup versions, whether they are active or inactive.

#### BACKUPActive

The server exports only active backup versions. These active backup versions are the active versions in the IBM Spectrum Protect database at the time that the EXPORT command is issued.

#### ALLActive

The server exports all active backup versions of files, all archived files, and all files that were migrated by an IBM Spectrum Protect for Space Management client. The active backup versions are the active versions in the IBM Spectrum Protect database at the time that the EXPORT command is issued.

#### SPacemanaged

The server exports only files that were migrated by an IBM Spectrum Protect for Space Management client.

#### FROMDate

Specifies the earliest date for which files to be exported were stored on the server. Files that were stored on the server earlier than the specified date are not exported. This parameter only applies to client file data. This parameter does not affect other information that might be exported, for example, policy. IBM Spectrum Protect ignores the FROMDATE parameter when the FILEDATA parameter is set to NONE.

Directory processing: The FROMDATE parameter does not apply to directories. All directories in a file space are processed even if the directories were not backed up in the specified date range.

Important: If you have group data on the node that you are exporting, data that was backed up before the designated FROMDATE and FROMTIME can also be exported. Group data on the node is, for example, virtual machine data or system state backup data. This export is a result of incremental backup processing for the data. The incremental backup processing can cause extra files that do not meet the filtering criteria to be exported, so that there is a consistent image for the backup data.

Use one of the following values to specify the date:

Value	Description	Example
MM/DD/YYYY	A specific date	09/15/1998
TODAY	The current date	TODAY
TODAY-days <b>or</b> -days	The current date minus days specified. The maximum number of days you can specify is 9999.	TODAY -3 <b>or</b> -3.
EOLM (End Of Last Month)	The last day of the previous month.	EOLM
EOLM-days	The last day of the previous month minus days specified.	EOLM-1 To include files that were active a day before the last day of the previous month.
BOTM (Beginning Of This Month)	The first day of the current month.	BOTM
BOTM+days	The first day of the current month, plus days specified.	BOTM+9 To include files that were active on the 10th day of the current month.

If this parameter is not specified, IBM Spectrum Protect exports all objects stored before the TODATE parameter and as qualified by the FILEDATA parameter. If no TODATE parameter is specified, then all data as qualified by the FILEDATA parameter is exported.

When a server-to-server export operation uses a relative FROMDATE, for example, TODAY-1, and the operation is restarted at a later date, the restarted process still uses the date that was used during the original operation. For example, if a server-to-server export operation is started on 07/04/2009 and the FROMDATE is specified as TODAY-1, the date that is used for selecting files is 07/03/2009. If this same export operation is suspended and restarted ten days later (07/14/2009), the date that is used for selecting files is still 07/03/2009. This behavior ensures that the entire export operation uses the same cutoff date for selecting files to export.

#### TODate

Specifies the latest date for files to be exported from the server. Files that are stored on the server on a date later than the TODATE value are not exported. TODATE only applies to client file data and does not affect other information that is being exported, such as policy.

- IBM Spectrum Protect ignores the TODATE parameter when the FILEDATA parameter is set to NONE.
- If a TODATE parameter is specified without a TOTIME parameter, the server exports all objects that are inserted on or before the day specified by the TODATE parameter.
- If you specified the FROMDATE parameter, the value of TODATE must be later than or equal to the FROMDATE value. If the TODATE and FROMDATE are equal, then the TOTIME parameter must be later than the FROMTIME parameter.
- The TODATE parameter does not apply to directories. All directories in a file space are processed even if the directories were not backed up in the specified date range.

Important: If you have group data on the node that you are exporting, data that was backed up after the TODATE or TOTIME parameters can be exported. An example of group data is virtual machine data or system state backup data. The incremental backup processing can cause extra files that do not meet the filtering criteria to be exported, so that there is a consistent image for the backup data.

Use one of the following values to specify the date:

Value	Description	Example
MM/DD/YYYY	A specific date	10/15/2006
TODAY	The current date	TODAY

Value	Description	Example
TODAY-days <b>or</b> -days	The current date minus days specified. The maximum number of days you can specify is 9999.	TODAY -3 <b>or</b> -3.
EOLM (End Of Last Month)	The last day of the previous month.	EOLM
EOLM-days	The last day of the previous month minus days specified.	EOLM-1 To include files that were active a day before the last day of the previous month.
BOTM (Beginning Of This Month)	The first day of the current month.	BOTM
BOTM+days	The first day of the current month, plus days specified.	BOTM+9 To include files that were active on the 10th day of the current month.

When a server-to-server export operation uses a relative TODATE, for example, TODAY-1, and the operation is restarted at a later date, the restarted process still uses the date that was used during the original operation. For example, if a server-to-server export operation is started on 07/04/2009 and the TODATE is specified as TODAY-1, the date that is used for selecting files is 07/03/2009. If this same export operation is suspended and restarted 10 days later (07/14/2009), the date that is used for selecting files is still 07/03/2009. This behavior ensures that the entire export operation uses the same cutoff date for selecting files to export.

#### FROMTime

Specifies the earliest time for which objects to be exported were stored on the server. When you specify FROMTIME, you must also use the FROMDATE parameter. This parameter only applies to client file data. This parameter does not affect other information that might be exported, for example, policy. Objects that were stored on the server before the specified time and date are not exported. IBM Spectrum Protect ignores the FROMTIME parameter when the FILEDATA parameter is set to NONE.

Important: If you have group data on the node that you are exporting, data that was backed up before the designated FROMDATE and FROMTIME can also be exported. An example of group data on the node is virtual machine data or system state backup data. This export is a result of incremental backup processing for the data. The incremental backup processing can cause extra files that do not meet the filtering criteria to be exported so that there is a consistent image for the backup data.

The default value for this parameter when used with the FROMDATE parameter is midnight (00:00:00).

Use one of the following values to specify the time:

Value	Description	Example
HH:MM:SS	A specific time	10:30:08
NOW	The current time	NOW
NOW+HH:MM <b>or</b> +HH:MM	The current time plus hours and minutes specified. The FROMTIME+ can only be used with a FROMDATE before today.	NOW+02:00 <b>or</b> +02:00. If you issue this command at 5:00 with FROMTIME=NOW+02:00 or FROMTIME=+02:00, the export operation only contains files that were put on the server after 7:00 on the FROMDATE that you specify.
NOW-HH:MM <b>or</b> -HH:MM	The current time minus hours and minutes specified	NOW -02:00 <b>or</b> -02:00. If you issue this command at 5:00 with FROMTIME=NOW-02:00 or FROMTIME=-2:00, the export includes files that were put on the server after 3:00.

#### TOTime

Specifies the latest time that objects to be exported were stored on the server. You must specify the TODATE parameter in order to use the TOTIME parameter. TOTIME only applies to client file data and does not affect other information that is

being exported, such as policy. IBM Spectrum Protect ignores the TOTIME parameter if the FILEDATA parameter is set to NONE.

The default value for this parameter, when used with the TODATE parameter, is midnight minus one second (23:59:59).

Important: The value of the TOTIME and TODATE parameters must be later than the FROMDATE and the FROMTIME value. Use one of the following values to specify the time:

Value	Description	Example
HH:MM:SS	A specific time	10:30:08
NOW+HH:MM <b>or</b> +HH:MM	The current time plus hours and minutes specified.	NOW+02:00 <b>or</b> +02:00.  If you issue this command at 05:00 with FROMTIME=01:00 and TOTIME=NOW+02:00, the export includes files that were stored from 01:00 until 07:00.
NOW-HH:MM <b>or</b> -HH:MM	The current time minus hours and minutes specified.	NOW-02:00 <b>or</b> -02:00.  If you issue this command at 05:00 with FROMTIME=01:00 and TOTIME=NOW-02:00, the export includes files that were stored from 01:00 until 03:00.

#### TOServer

Specifies the name of a server to which the export data is sent directly over the network for immediate import.

Important: The target server must be defined on the originating server with the DEFINE SERVER command. The administrator that issues the export command must be defined with the same administrator name and password and have system authority on the target server.

When you specify TOSERVER, you cannot specify the DEVCLASS, VOLUMENAMES, and SCRATCH, USEDVOLUMELIST, and PREVIEW parameters.

#### PREVIEWImport

Specifies whether to view how much data is transferred, without actually moving any data. This information can be used to determine how much storage pool space is required on the target server. The default is NO.

Valid values are:

Yes

Specifies that you want to preview the results of the import operation on the target server, without importing the data. Information is reported to the server console and the activity log.

No

Specifies that you want the data to be imported on the target server without previewing the results.

#### MERGEfilespaces

Specifies whether IBM Spectrum Protect merges client files into existing file spaces on the target server (if they exist), or if IBM Spectrum Protect generates new file space names. The default is NO.

Valid values are:

Yes

Specifies that imported data on the target server is merged with the existing file space, if a file space with the same name exists on the target server.

No

Specifies that IBM Spectrum Protect generates a new file space name for imported data on the target server if file spaces with the same name exists.

#### Replacedefs

Specifies whether to replace definitions (not file data) on the server. The default is NO.

Valid values are:

Yes

Specifies that definitions are replaced on the server if definitions having the same name as those being imported exist on the target server.

No

Specifies that imported definitions are skipped if their names conflict with definitions that are already defined on the target server.

#### PROXynodeassoc

Specifies if proxy node associations are exported. This parameter is optional. The default value is NO.

#### ENCryptionstrength

Indicates which algorithm to use to encrypt passwords when exporting administrative and node records. This parameter is optional. The default value is AES. If you are exporting to a server that does not support AES, specify DES. You can specify one of the following values:

##### AES

Specifies the Advanced Encryption Standard.

##### DES

Specifies the Data Encryption Standard.

#### ALLOWSHREDdable

Specifies whether data from a storage pool that enforces shredding is exported. This parameter is optional. The default value is NO. Possible values are:

##### No

Specifies that the server does not export data from a storage pool that enforces shredding.

##### Yes

Specifies that the server does export from a storage pool that enforces shredding. The data on the export media is not shredded.

Restriction: After an export operation finishes identifying files for export, any changes to the storage pool ALLOWSHREDABLE value is ignored. An export operation that is suspended retains the original ALLOWSHREDABLE value throughout the operation. You might want to consider canceling your export operation if changes to the storage pool ALLOWSHREDABLE value jeopardize the operation. You can reissue the export command after any needed cleanup.

#### EXPORTIdentifier

This optional parameter specifies the name that you select to identify this export operation. If you do not specify an identifier name, the server generates one for you. The export identifier name cannot be more than 64 characters, cannot contain wildcard characters, and is not case-sensitive. You can use the identifier name to reference export operations in the QUERY EXPORT, SUSPEND EXPORT, RESTART EXPORT, or CANCEL EXPORT commands.

Restriction: You must specify the TOSERVER parameter if you are specifying the EXPORTIDENTIFIER parameter. EXPORTIDENTIFIER is ignored if FILEDATA=NONE.

### Example: Export client node information and all client files

---

To export client node information and all client files for NODE1 directly to SERVERB, issue the following command:

```
export node node1 filedata=all toserver=serverb
```

### Example: Export client node information and all client files for a specific date range

---

To export client node information and all client files for NODE1 directly to SERVERB between February 1, 2009 and today.

```
export node node1 filedata=all toserver=serverb  
fromdate=02/01/2009 todate=today
```

### Example: Export client node information and all client files for a specific date and time range

---

To export client node information and all client files for NODE1 directly to SERVERB from 8:00 AM on February 1, 2009 until today at 8:00 AM, issue the following command:

```
export node node1 filedata=all toserver=serverb  
fromdate=02/01/2009 fromtime=08:00:00  
todate=today totime=08:00:00
```

### Example: Export client node information and all client files for the past three days

---

To export client node information and all client files for NODE1 directly to SERVERB for the past three days, issue the following command:

```
export node node1 filedata=all toserver=serverb
fromdate=today -3
```

## EXPORT POLICY (Export policy information)

Use this command to export policy information from an IBM Spectrum Protect™ server to sequential media or directly to another server for immediate import. When a policy is exported by using the EXPORT POLICY command, the active data pool information in the domain is not exported.

The server exports policy information, such as:

- Policy domain definitions
- Policy set definitions, including the active policy set
- Management class definitions, including the default management class
- Backup copy group and archive copy group definitions
- Schedule definitions for each policy domain
- Client node associations, if the client node exists on the target server

You can use the QUERY ACTLOG command to view the status of the export operation. You can also view this information from the server console.

This command generates a background process that can be canceled with the CANCEL PROCESS command. If you export policy information to sequential media and the background process is canceled, the sequential media that is holding the exported data is incomplete and must not be used to import data. If a server-to-server export background process is canceled, a partial import might result. Evaluate any imported data on the target server to determine whether you want to keep or delete the imported data. Review the import messages for details. To display information about background processes, use the QUERY PROCESS command.

The following restrictions apply to the export function:

- Export operations from a later version and release to an earlier version and release is not supported.
- Export operations between servers that are at the same version and release but with different fix packs might fail. For example, you cannot export from a V7.1.3 server to a V7.1.1 or earlier server.
- Exported data from a server with retention protection enabled is not protected by retention when it is imported to another server.
- Export processing excludes nodes of type network-attached storage (NAS).
- Exporting data to a Centera device class or importing data from a Centera device class is not supported. However, files that are stored in Centera storage pools can be exported and files that must be imported can be stored on a Centera storage device.

Limitation: The IBM Spectrum Protect server does not convert code pages during export, import, and node replication operations. If servers are running in different locales, some information in databases or system output might become unreadable. Invalid characters might be displayed, for example, in the contact information for the administrator and client nodes, and in descriptions of policy domains. Any field that is stored in the server character set and that includes extended ASCII characters can be affected. To resolve the issue after the import or node replication operation, update the fields with the appropriate UPDATE commands. This server limitation does not affect client data. Any client data that was exported, imported, or replicated can be restored, retrieved, and recalled.

The EXPORT POLICY command takes two forms: Export directly to another server on the network, or export to sequential media. The syntax and parameters for each form are defined separately.

Table 1. Commands related to EXPORT POLICY

Command	Description
CANCEL PROCESS	Cancels a background server process.
EXPORT ADMIN	Copies administrative information to external media or directly to another server.
EXPORT NODE	Copies client node information to external media or directly to another server.
EXPORT SERVER	Copies all or part of the server to external media or directly to another server.
IMPORT POLICY	Restores policy information from external media.

Command	Description
QUERY ACTLOG	Displays messages from the server activity log.
QUERY PROCESS	Displays information about background processes.

- EXPORT POLICY (Export policy information to sequential media)  
Use this command to export policy information from an IBM Spectrum Protect server to sequential media for later import to another server.
- EXPORT POLICY (Export a policy directly to another server)  
Use this command to export policy information directly to another server on the network. This results in an immediate import on the target server.

## EXPORT POLICY (Export policy information to sequential media)

Use this command to export policy information from an IBM Spectrum Protect™ server to sequential media for later import to another server.

### Privilege class

To issue this command, you must have system privilege.

### Syntax

```

>>-EXPort Policy-----+-----+-----+----->
| .-*,-----, |
| V,-----, |
| '---domain_name---+'
|
| .-Preview----No-----+-----+-----+----->
| (1) (2) |
| '-Preview-----+---No---+'
| '---Yes-'
|
|-----+-----+-----+----->
| (1) |
| '-DEVclass-----device_class_name-'
|
| .-Scratch----Yes-----+-----+-----+----->
| (2) |
| '-Scratch-----+---Yes---+'
| '---No--'
|
|-----+-----+-----+----->
| (2) V,-----, |
| '-VOLumentnames-----+---volume_name---+'
| '---FILE:--file_name-'
|
|-----+-----+-----+-----><
| '-USEDVolumelist----file_name-'

```

Notes:

1. If PREVIEW=NO, a device class must be specified.
2. If PREVIEW=NO and SCRATCH=NO, one or more volumes must be specified.

### Parameters

domain\_name

Specifies the policy domains for which information is to be exported. This parameter is optional. The default is all policy domains. Separate multiple names with commas and no intervening spaces. You can use wildcard characters to specify

names.

#### Preview

Specifies whether to preview the results of the export operation, without exporting information. You can use this parameter to preview how many bytes of data are transferred so that you can determine how many volumes are required. This parameter supports the following values:

No

Specifies that the policy information is to be exported. If you specify this value, you must also specify a device class.

Yes

Specifies that the operation is previewed but not completed. Information is reported to the server console and the activity log. If you specify this value, you do not need to specify a device class.

This parameter is optional. The default value is NO.

#### DEVclass

Specifies the device class to which export data is to be written. This parameter is required if you specify PREVIEW=NO.

You cannot specify the DISK, NAS, or CENTERA device classes.

If all drives for the device class are busy when the export runs, IBM Spectrum Protect cancels lower priority operations to make a drive available.

Tip: You can export data to a storage pool on another server by specifying a device class whose device type is SERVER.

#### Scratch

Specifies whether scratch volumes can be used. The default value is YES. You can specify one of the following values:

Yes

Specifies that scratch volumes can be used for export. If you also specify a list of volumes, scratch volumes are used only if there is not enough space on the volumes specified.

No

Specifies that scratch volumes cannot be used for export. To determine how many volumes you might need, you can run the command specifying PREVIEW=YES.

#### VOLumenames

Specifies the volumes to be used to contain exported data. This parameter is optional, unless you specify SCRATCH=NO and PREVIEW=NO. If you do not specify a volume name, scratch volumes are used.

You can specify one of the following values:





volume\_name

Specifies the volume name. To specify multiple volumes, separate the names with commas and no intervening spaces.

FILE:file\_name

Specifies the name of a file that contains a list of volumes. In the file, each volume name must be on a separate line. Blank and comment lines that begin with an asterisk are ignored.

Use these naming conventions when specifying volumes associated with the following device types:

For this device	Specify
Tape	1-6 alphanumeric characters.
FILE	Any fully qualified file name string. For example:  /imdata/mt1.  d:\program files\tivoli\tsm\data1.dsm.
 REMOVABLEFILE	 1-6 alphanumeric characters.
SERVER	1-250 alphanumeric characters.

#### USEDVolumelist

Specifies the file where a list of volumes used in the export operation are stored. This parameter is optional.

This file can be used in the import operation. This file contains comment lines with the date and time the export was done, and the command issued to create the export.

Attention: If you specify an existing file, the file is overwritten.



## Example: Export policy information to specific tape volumes

---

From the server, export policy information to tape volumes TAPE01, TAPE02, and TAPE03. Specify that these tape volumes be read by a device that is assigned to the MENU1 device class.

```
export policy devclass=menu1
volumenames=tape01,tape02,tape03
```

## Example: Export policy information to tape volumes listed in a file

---

From the server, export policy information to tape volumes that are listed in the following file:

- **AIX** | **Linux** TAPEVOL
- **Windows** TAPEVOL.DATA

This file contains the following lines:

```
TAPE01
TAPE02
TAPE03
```

Specify that these tape volumes be used by a device that is assigned to the MENU1 device class. Issue the following command:

```
AIX | Linux
export policy devclass=menu1 volumenames=file:tapevol
```

```
Windows
export policy devclass=menu1 volumenames=file:tapevol.data
```

## EXPORT POLICY (Export a policy directly to another server)

---

Use this command to export policy information directly to another server on the network. This results in an immediate import on the target server.

To monitor the progress of the import operation, you can issue a QUERY PROCESS command from the target server. See EXPORT ADMIN (Export administrator information) for a list of restrictions that apply to the export function.

## Privilege class

---

To issue this command, you must have system privilege.

## Syntax

---

```

>>>-EXPoRT Policy-+-----+----->
| .-*,-----, |
| V             | |
|---domain_name-+-'

>--+-+-----+-----+-----+-----+-----+-----+----->
'-TOserver----servername-' '-PREVIEWImport-----+No----+'
                                     '-Yes-'

.-Replacedefs-----No-----
>--+-+-----+-----+-----+-----+-----+-----+-----><
'-Replacedefs-----+No--+-'
                                     '-Yes-'
```

## Parameters

---

domain\_name

Specifies the policy domains for which information is to be exported. This parameter is optional. The default is all policy domains. Separate multiple names with commas and no intervening spaces. You can use wildcard characters to specify

names.

#### TOServer

Specifies the name of a server to which the export data is sent directly over the network for immediate import.

Important: The target server must be defined on the originating server with the DEFINE SERVER command. The administrator that issues the export command must be defined with the same administrator name and password and have system authority on the target server.

When you specify TOSERVER, you cannot specify the DEVCLASS, VOLUMENAMES, and SCRATCH, USEDVOLUMELIST, and PREVIEW parameters.

#### PREVIEWImport

Specifies whether to view how much data is transferred, without actually moving any data. This information can be used to determine how much storage pool space is required on the target server. The default is NO.

Valid values are:

Yes

Specifies that you want to preview the results of the import operation on the target server, without importing the data. Information is reported to the server console and the activity log.

No

Specifies that you want the data to be imported on the target server without previewing the results.

#### Replacedefs

Specifies whether to replace definitions (not file data) on the server. The default is NO.

Valid values are:

Yes

Specifies that definitions are replaced on the server if definitions having the same name as those being imported exist on the target server.

No

Specifies that imported definitions are skipped if their names conflict with definitions that are already defined on the target server.

## Example: Export policy to another server

---

To export policy information directly to SERVERB, issue the following command:

```
export policy replacedefs=yes toserver=othersrv
```

## EXPORT SERVER (Export server information)

---

Use this command to export all or part of the server control information and client file data (if specified) from the server to sequential media.

When you export server information to sequential media, you can later use the media to import the information to another server with a compatible device type.

Important: For commands that import administrators or nodes, you must consider the method of authentication. The IBM Spectrum Protect™ server cannot export or import passwords for nodes or administrators that are authenticating with LDAP directory servers. If the current authentication method uses an LDAP directory server and the password is not already synchronized by that server, you must update the password. After issuing the IMPORT command, set the password by issuing the UPDATE ADMIN or UPDATE NODE command.

You also have the option of processing an export operation directly to another server on the network. This results in an immediate import process without the need for compatible sequential device types between the two servers.

You can export the following types of server information by issuing the EXPORT SERVER command:

- Policy domain definitions
- Policy set definitions
- Management class and copy group definitions
- Schedules defined for each policy domain
- Administrator definitions
- Client node definitions

You can optionally export the following types of data:

- File space definitions
- Access authorization information that pertains to the file spaces exported
- Backed-up, archived, and files that were migrated by an IBM Spectrum Protect for Space Management client

This command generates a background process that can be canceled by the CANCEL PROCESS command. If you export server information to sequential media, and the background process is canceled, the sequential media holding the exported data are incomplete and should not be used for importing data. If a server-to-server export background process is canceled, a partial import might result. Evaluate any imported data on the target server to determine whether you want to keep or delete the imported data. Review the import messages for details.

Issue the QUERY PROCESS command from the target server to monitor the progress of the import operation. Issue the QUERY EXPORT command to list all server-to-server export operations (that have a FILEDATA value other than NONE) that are running or suspended.

You can use the QUERY ACTLOG command to view the actual status information which indicates the size and the success or failure of the export operation.

The following restrictions apply to the export function:

- Export operations from a later version and release to an earlier version and release is not supported.
- Export operations between servers that are at the same version and release but with different fix packs might fail. For example, you cannot export from a V7.1.3 server to a V7.1.1 or earlier server.
- Exported data from a server with retention protection enabled is not protected by retention when it is imported to another server.
- Export processing excludes nodes of type network-attached storage (NAS).
- Exporting data to a Centera device class or importing data from a Centera device class is not supported. However, files that are stored in Centera storage pools can be exported and files that must be imported can be stored on a Centera storage device.
- The EXPORT NODE and EXPORT SERVER commands do not export data from a shred pool unless you explicitly allow it by setting the ALLOWSHREDDABLE parameter to the YES value. If this value is specified, and the exported data includes data from shred pools, that data cannot be shredded. A warning is not issued if the export operation includes data from shred pools.
- Incrementally exporting or importing the following types of client data to another IBM Spectrum Protect server is not supported:
  - VMware backups where full plus incremental backups need to be periodically, incrementally transferred to another server
  - Backups groups where full plus differential backups must be periodically, incrementally transferred to another server
  - Windows System State data that is periodically, incrementally transferred to another server

Full export or import of this data to a new file system on the target is supported by exporting the entire file space that contains the data. The export must not use the FILEDATA=ALLACTIVE, FROMDATE, TODATE, or MERGEFILESPPACES parameters.

Using node replication to incrementally transfer this type of client data between two servers is optimal.

Limitation: The IBM Spectrum Protect server does not convert code pages during export, import, and node replication operations. If servers are running in different locales, some information in databases or system output might become unreadable. Invalid characters might be displayed, for example, in the contact information for the administrator and client nodes, and in descriptions of policy domains. Any field that is stored in the server character set and that includes extended ASCII characters can be affected. To resolve the issue after the import or node replication operation, update the fields with the appropriate UPDATE commands. This server limitation does not affect client data. Any client data that was exported, imported, or replicated can be restored, retrieved, and recalled.

The EXPORT SERVER command takes two forms: Export directly to another server on the network, or export to sequential media. The syntax and parameters for each form are defined separately.

Table 1. Commands related to EXPORT SERVER

Command	Description
CANCEL EXPORT	Deletes a suspended export operation.

Command	Description
CANCEL PROCESS	Cancels a background server process.
COPY ACTIVATEDATA	Copies active backup data.
EXPORT ADMIN	Copies administrative information to external media or directly to another server.
EXPORT NODE	Copies client node information to external media or directly to another server.
EXPORT POLICY	Copies policy information to external media or directly to another server.
IMPORT SERVER	Restores all or part of the server from external media.
QUERY ACTLOG	Displays messages from the server activity log.
QUERY EXPORT	Displays the export operations that are currently running or suspended.
QUERY PROCESS	Displays information about background processes.
RESTART EXPORT	Restarts a suspended export operation.
SUSPEND EXPORT	Suspends a running export operation.

- EXPORT SERVER (Export a server to sequential media)  
You can export all or part of the server control information and client file data from a server to sequential media so that this information can be imported to another server.
- EXPORT SERVER (Export server control information and client file data to another server)  
Use this command to export all or part of the server control information and client file data directly to another server on the network. This results in an immediate import on the target server.

## EXPORT SERVER (Export a server to sequential media)

You can export all or part of the server control information and client file data from a server to sequential media so that this information can be imported to another server.

### Privilege class

To issue this command, you must have system privilege.

### Syntax

```

.-FILEData----None-----
>>-EXPort Server----->
      '-FILEData----+All-----+'
                        +-None-----+
                        +-ARchive-----+
                        +-Backup-----+
                        +-BACKUPActive--+
                        +-ALLActive----+
                        '-SPacemanaged-'

.-Preview----No-----
>----->
|          (1) (2)          |
'-Preview-----+No--+-'
                   '-Yes-'

>----->
|          (1)          |
'-DEVclass-----device_class_name-'

.-Scratch----Yes-----
>----->
|          (2)          |

```

```

'-Scratch-----+-Yes+-'
                '-No--'

>----->
|
|          (2)          .-,'-----'.
|          V            |
|'-VOLumentnames-----+---volume_name-+-+-'
|                        '-FILE:--file_name-'

>----->
'-USEDVolumelist----file_name-'

>----->
|
|          .-FROMTime----00:00:00-. |
|'-FROMDate----date-+-----+-'
|                        '-FROMTime----time-----'

>----->
|
|          .-TOTime----23:59:59-. |
|'-TODate----date-+-----+-'
|                        '-TOTime----time-----'

.-ENCryptionstrength----AES-----
>----->
'-ENCryptionstrength----+AES-+-'
                '-DES-'

.-ALLOWSHREDDable----No-----
>----->
'-ALLOWSHREDDable----+No-+-'
                '-Yes-'

```

#### Notes:

1. If PREVIEW=NO, a device class must be specified.
2. If PREVIEW=NO and SCRATCH=NO, one or more volumes must be specified.

## Parameters

### FILEData

Specifies the type of files that are exported for all nodes that are defined to the server. This parameter is optional. The default value is NONE.

If you are exporting to sequential media, the device class to access the file data is determined by the device class for the storage pool. If it is the same device class that is specified in this command, two drives are needed to export server information. The mount limit for the device class must be set to at least 2.

The following descriptions mention *active* and *inactive* backup file versions. An active backup file version is the most recent backup version for a file that still exists on the client workstation. All other backup file versions are called inactive copies. The following values are available:

#### ALL

IBM Spectrum Protect™ exports all backup versions of files, all archived files, and all files that were migrated by an IBM Spectrum Protect for Space Management client.

#### None

IBM Spectrum Protect does not export files, only definitions.

#### ARchive

IBM Spectrum Protect exports only archived files.

#### Backup

IBM Spectrum Protect exports only backup versions, whether the versions are active or inactive.

#### BACKUPActive

IBM Spectrum Protect exports only active backup versions.

#### ALLActive

IBM Spectrum Protect exports all active backup versions of files, all archived files, and all files that were migrated by an IBM Spectrum Protect for Space Management client.

#### SPacemanaged

IBM Spectrum Protect exports only files that were migrated by an IBM Spectrum Protect for Space Management client.

#### Preview

Specifies whether you want to preview the results of the export operation, without exporting information. You can use this parameter to preview how many bytes of data are transferred so that you can determine how many volumes are required. This parameter supports the following values:

#### No

Specifies that the server information is to be exported. If you specify this value, you must also specify a device class.

#### Yes

Specifies that the operation is previewed but not completed. Information is reported to the server console and the activity log. If you specify this value, you do not need to specify a device class.

This parameter is optional. The default value is NO.

#### DEVclass

Specifies the device class to which export data is to be written. This parameter is required if you specify PREVIEW=NO.

You cannot specify the DISK, NAS, or CENTERA device classes.

If all drives for the device class are busy when the export runs, IBM Spectrum Protect cancels lower priority operations to make a drive available.

Tip: You can export data to a storage pool on another server by specifying a device class whose device type is SERVER.

#### Scratch

Specifies whether scratch volumes can be used. The default value is YES. You can specify one of the following values:

#### Yes

Specifies that scratch volumes can be used for export. If you also specify a list of volumes, scratch volumes are used only if there is not enough space on the volumes specified.

#### No

Specifies that scratch volumes cannot be used for export. To determine how many volumes you might need, you can run the command specifying PREVIEW=YES.

#### VOLumenames

Specifies the volumes to be used to contain exported data. This parameter is optional, unless you specify SCRATCH=NO and PREVIEW=NO. If you do not specify a volume name, scratch volumes are used.

You can specify one of the following values:

#### volume\_name

Specifies the volume name. To specify multiple volumes, separate the names with commas and no intervening spaces.

#### FILE:file\_name

Specifies the name of a file that contains a list of volumes. In the file, each volume name must be on a separate line. Blank and comment lines that begin with an asterisk are ignored.

Use these naming conventions when specifying volumes associated with the following device types:

For this device	Specify
Tape	1-6 alphanumeric characters.
FILE	Any fully qualified file name string. For example: <div style="display: flex; justify-content: space-between; margin: 5px 0;"> <span>AIX</span> <span>Linux</span> <span>/imdata/mt1.</span> </div> <div style="display: flex; justify-content: space-between; margin: 5px 0;"> <span>Windows</span> <span>d:\program files\tivoli\tsm\data1.dsm.</span> </div>
<div style="display: flex; justify-content: space-between; margin: 5px 0;"> <span>AIX</span> <span>Linux</span> <span>Windows</span> </div> REMOVABLEFILE	<div style="display: flex; justify-content: space-between; margin: 5px 0;"> <span>AIX</span> <span>Linux</span> <span>Windows</span> </div> 1-6 alphanumeric characters.
SERVER	1-250 alphanumeric characters.

#### USEDVolumelist

Specifies the file where a list of volumes used in the export operation are stored. This parameter is optional.

This file can be used in the import operation. This file contains comment lines with the date and time the export was done, and the command issued to create the export.

Attention: If you specify an existing file, the file is overwritten.

#### FROMDate

Specifies the earliest date for which files to be exported were stored on the server. Files that were stored on the server earlier than the specified date are not exported. This parameter only applies to client file data. This parameter does not affect other information that might be exported, for example, policy. IBM Spectrum Protect ignores the FROMDATE parameter when the FILEDATA parameter is set to NONE.

Directory processing: The FROMDATE parameter does not apply to directories. All directories in a file space are processed even if the directories were not backed up in the specified date range.

Important: If you have group data on the node that you are exporting, data that was backed up before the designated FROMDATE and FROMTIME can also be exported. Group data on the node is, for example, virtual machine data or system state backup data. This export is a result of incremental backup processing for the data. The incremental backup processing can cause extra files that do not meet the filtering criteria to be exported, so that there is a consistent image for the backup data.

Use one of the following values to specify the date:

Value	Description	Example
MM/DD/YYYY	A specific date	09/15/1998
TODAY	The current date	TODAY
TODAY-days or -days	The current date minus days specified. The maximum number of days you can specify is 9999.	TODAY -3 or -3.
EOLM (End Of Last Month)	The last day of the previous month.	EOLM
EOLM-days	The last day of the previous month minus days specified.	EOLM-1  To include files that were active a day before the last day of the previous month.
BOTM (Beginning Of This Month)	The first day of the current month.	BOTM
BOTM+days	The first day of the current month, plus days specified.	BOTM+9  To include files that were active on the 10th day of the current month.

If this parameter is not specified, IBM Spectrum Protect exports all objects stored before the TODATE parameter and as qualified by the FILEDATA parameter. If no TODATE parameter is specified, then all data as qualified by the FILEDATA parameter is exported.

When a server-to-server export operation uses a relative FROMDATE, for example, TODAY-1, and the operation is restarted at a later date, the restarted process still uses the date that was used during the original operation. For example, if a server-to-server export operation is started on 07/04/2009 and the FROMDATE is specified as TODAY-1, the date that is used for selecting files is 07/03/2009. If this same export operation is suspended and restarted ten days later (07/14/2009), the date that is used for selecting files is still 07/03/2009. This behavior ensures that the entire export operation uses the same cutoff date for selecting files to export.

#### TODate

Specifies the latest date for files to be exported from the server. Files stored on the server on a date later than the TODATE value are not exported. TODATE only applies to client file data and does not affect other information that is being exported, such as policy.

- IBM Spectrum Protect ignores the TODATE parameter when the FILEDATA parameter is set to NONE.
- If a TODATE parameter is specified without a TOTIME parameter, the server exports all objects inserted on or before the day specified by the TODATE parameter.
- If you specified the FROMDATE parameter, the value of TODATE must be later than or equal to the FROMDATE value. If the TODATE and FROMDATE are equal, then the TOTIME parameter must be later than the FROMTIME parameter.
- The TODATE parameter does not apply to directories. All directories in a file space are processed even if the directories were not backed up in the specified date range.

Use one of the following values to specify the date:

Value	Description	Example
-------	-------------	---------

Value	Description	Example
MM/DD/YYYY	A specific date	10/15/2006
TODAY	The current date	TODAY
TODAY-days <b>or</b> -days	The current date minus days specified. The maximum number of days you can specify is 9999.	TODAY -3 <b>or</b> -3.
EOLM (End Of Last Month)	The last day of the previous month.	EOLM
EOLM-days	The last day of the previous month minus days specified.	EOLM-1 To include files that were active a day before the last day of the previous month.
BOTM (Beginning Of This Month)	The first day of the current month.	BOTM
BOTM+days	The first day of the current month, plus days specified.	BOTM+9 To include files that were active on the 10th day of the current month.

When a server-to-server export operation uses a relative TODATE, for example, TODAY-1, and the operation is restarted at a later date, the restarted process still uses the date that was used during the original operation. For example, if a server-to-server export operation is started on 07/04/2009 and the TODATE is specified as TODAY-1, the date that is used for selecting files is 07/03/2009. If this same export operation is suspended and restarted ten days later (07/14/2009), the date that is used for selecting files is still 07/03/2009. This behavior ensures that the entire export operation uses the same cutoff date for selecting files to export.

#### FROMTime

Specifies the earliest time for which objects to be exported were stored on the server. When you specify FROMTIME, you must also use the FROMDATE parameter. This parameter only applies to client file data. This parameter does not affect other information that might be exported, for example, policy. Objects that were stored on the server before the specified time and date are not exported. IBM Spectrum Protect ignores the FROMTIME parameter when the FILEDATA parameter is set to NONE.

Important: If you have group data on the node that you are exporting, data that was backed up before the designated FROMDATE and FROMTIME can also be exported. An example of group data on the node is virtual machine data or system state backup data. This export is a result of incremental backup processing for the data. The incremental backup processing can cause extra files that do not meet the filtering criteria to be exported so that there is a consistent image for the backup data.

The default value for this parameter when used with the FROMDATE parameter is midnight (00:00:00).

Use one of the following values to specify the time:

Value	Description	Example
HH:MM:SS	A specific time	10:30:08
NOW	The current time	NOW
NOW+HH:MM <b>or</b> +HH:MM	The current time plus hours and minutes specified. The FROMTIME+ can only be used with a FROMDATE before today.	NOW+02:00 <b>or</b> +02:00. If you issue this command at 5:00 with FROMTIME=NOW+02:00 or FROMTIME=+02:00, the export operation only contains files that were put on the server after 7:00 on the FROMDATE that you specify.
NOW-HH:MM <b>or</b> -HH:MM	The current time minus hours and minutes specified	NOW -02:00 <b>or</b> -02:00. If you issue this command at 5:00 with FROMTIME=NOW-02:00 or FROMTIME=-2:00, the export includes files that were put on the server after 3:00.



## TOTime

Specifies the latest time that objects to be exported were stored on the server. You must specify the TODATE parameter in order to use the TOTIME parameter. TOTIME only applies to client file data and does not affect other information that is being exported, such as policy. IBM Spectrum Protect ignores the TOTIME parameter if the FILEDATA parameter is set to NONE.

The default value for this parameter, when used with the TODATE parameter, is midnight minus one second (23:59:59).

Important: The value of the TOTIME and TODATE parameters must be later than the FROMDATE and the FROMTIME value. Use one of the following values to specify the time:

Value	Description	Example
HH:MM:SS	A specific time	10:30:08
NOW+HH:MM <b>or</b> +HH:MM	The current time plus hours and minutes specified.	NOW+02:00 <b>or</b> +02:00.  If you issue this command at 05:00 with FROMTIME=01:00 and TOTIME=NOW+02:00, the export includes files that were stored from 01:00 until 07:00.
NOW-HH:MM <b>or</b> -HH:MM	The current time minus hours and minutes specified.	NOW-02:00 <b>or</b> -02:00.  If you issue this command at 05:00 with FROMTIME=01:00 and TOTIME=NOW-02:00, the export includes files that were stored from 01:00 until 03:00.

## ENCryptionstrength

Indicates which algorithm to use to encrypt passwords when exporting administrative and node records. This parameter is optional. The default value is AES. If you are exporting to a server that does not support AES, specify DES. You can specify one of the following values:

AES

Specifies the Advanced Encryption Standard.

DES

Specifies the Data Encryption Standard.

## ALLOWSHREDdable

Specifies whether data from a storage pool that enforces shredding is exported. This parameter is optional. The default value is NO. Possible values are:

No

Specifies that data is not exported from a storage pool that enforces shredding.

Yes

Specifies that data can be exported from a storage pool that enforces shredding. The data on the export media is not shredded.

## Example: Export a server to specific tape volumes

From the server, export server information to tape volumes TAPE01, TAPE02, and TAPE03. Specify that these tape volumes be read by a device that is assigned to the MENU1 device class.

```
export server devclass=menu1
volumenames=tape01,tape02,tape03
```

## Example: Export a server to tape volumes listed in a file

From the server, export server information to tape volumes that are listed in the following file:

- **AIX** | **Linux** TAPEVOL
- **Windows** TAPEVOL.DATA

The file contains the following lines:

```
TAPE01
TAPE02
```

Specify that the tape volumes be used by a device that is assigned to the MENU1 device class. Issue the following command:

```
AIX Linux
export server devclass=menu1 volumenames=file:tapevol
```

```
Windows
export server devclass=menu1 volumenames=file:tapevol.data
```

## EXPORT SERVER (Export server control information and client file data to another server)

Use this command to export all or part of the server control information and client file data directly to another server on the network. This results in an immediate import on the target server.

Server-to-server export operations that have a FILEDATA value other than NONE can be restarted after the operation is suspended. The server saves the state and status of the export operation so that it may be restarted from the point at which the operation failed or was suspended. The export operation can be restarted at a later date by issuing the RESTART EXPORT command. These export operations can be manually suspended as well as restarted. Therefore, if an export fails, it is automatically suspended if it has completed the transmitting definitions phase.

An export operation is suspended when any of the following conditions is detected:

- A SUSPEND EXPORT command is issued for the running export operation
- Segment preemption - the file being read for export is deleted by some other process
- Communication errors on a server-to-server export
- No available mount points
- Necessary volumes are unavailable
- I/O errors encountered

The export operation cannot be restarted if the export operation fails prior to transmitting the eligible node and filespace definitions to the target server. You must reenter the command to begin a new export operation.

Issue the QUERY PROCESS command from the target server to monitor the progress of the import operation. Issue the QUERY EXPORT command to list all server-to-server export operations (that have a FILEDATA value other than NONE) that are running or suspended. See EXPORT ADMIN (Export administrator information) for a list of restrictions that apply to the export function.

### Privilege class

To issue this command, you must have system privilege.

### Syntax

```

                .-FILEData-----None----- .
>>-EXPort Server--+-----+----->
                '-FILEData-----+All-----+'
                    +-None-----+
                    +-ARchive-----+
                    +-Backup-----+
                    +-BACKUPActive--+
                    +-ALLActive-----+
                    '-SPacemanaged-'

>--+-----+----->
|               .-FROMTime-----00:00:00-. |
'-FROMDate-----date--+-----+-----+'
                '-FROMTime-----time-----'

>--+-----+----->
|               .-TOTime-----23:59:59-. |
'-TODate-----date--+-----+-----+'
                '-TOTime-----time-----'

>--+-----+----->

```

```

'-EXPORTIdentifier-----export_identifier-'
                                     .-PREVIEWImport-----No----- .
>---+-----+-----+-----+-----+-----+-----+-----+----->
'-TOserver-----servername-' '-PREVIEWImport-----+No--+-'
                                     '-Yes-'

.-MERGEfilespace-----No----- .
>---+-----+-----+-----+-----+-----+-----+-----+----->
'-MERGEfilespace-----+No--+-'
                                     '-Yes-'

.-Replacedefs-----No----- .
>---+-----+-----+-----+-----+-----+-----+-----+----->
'-Replacedefs-----+No--+-'
                                     '-Yes-'

.-PROXynodeassoc-----No----- .
>---+-----+-----+-----+-----+-----+-----+-----+----->
'-PROXynodeassoc-----+No--+-'
                                     '-Yes-'

.-ENCryptionstrength-----AES----- .
>---+-----+-----+-----+-----+-----+-----+-----+----->
'-ENCryptionstrength-----+AES--+-'
                                     '-DES-'

.-ALLOWSHREddable-----No----- .
>---+-----+-----+-----+-----+-----+-----+-----+-----><
'-ALLOWSHREddable-----+No--+-'
                                     '-Yes-'

```

## Parameters

---

### FILEData

Specifies the type of files to export for all nodes defined to the server. This parameter is optional. The default value is NONE.

If you are exporting to sequential media: The device class to access the file data is determined by the device class for the storage pool. If it is the same device class specified in this command, IBM Spectrum Protect™ requires two drives to export server information. You must set the mount limit for the device class to at least 2.

The following descriptions mention active and inactive backup file versions. An active backup file version is the most recent backup version for a file that still exists on the client workstation. All other backup file versions are called inactive copies. The values are:

#### ALL

IBM Spectrum Protect exports all backup versions of files, all archived files, and all files that were migrated by an IBM Spectrum Protect for Space Management client.

#### None

IBM Spectrum Protect does not export files, only definitions.

#### ARchive

IBM Spectrum Protect exports only archived files.

#### Backup

IBM Spectrum Protect exports only backup versions, whether they are active or inactive.

#### BACKUPActive

IBM Spectrum Protect exports only active backup versions.

#### ALLActive

IBM Spectrum Protect exports all active backup versions of files, all archived files, and all files that were migrated by an IBM Spectrum Protect for Space Management client.

#### SPacemanaged

IBM Spectrum Protect exports only files that were migrated by an IBM Spectrum Protect for Space Management client.

### FROMDate

Specifies the earliest date for which files to be exported were stored on the server. Files that were stored on the server earlier than the specified date are not exported. This parameter only applies to client file data. This parameter does not

affect other information that might be exported, for example, policy. IBM Spectrum Protect ignores the FROMDATE parameter when the FILEDATA parameter is set to NONE.

Directory processing: The FROMDATE parameter does not apply to directories. All directories in a file space are processed even if the directories were not backed up in the specified date range.

Important: If you have group data on the node that you are exporting, data that was backed up before the designated FROMDATE and FROMTIME can also be exported. Group data on the node is, for example, virtual machine data or system state backup data. This export is a result of incremental backup processing for the data. The incremental backup processing can cause extra files that do not meet the filtering criteria to be exported, so that there is a consistent image for the backup data.

Use one of the following values to specify the date:

Value	Description	Example
MM/DD/YYYY	A specific date	09/15/1998
TODAY	The current date	TODAY
TODAY-days or -days	The current date minus days specified. The maximum number of days you can specify is 9999.	TODAY -3 or -3.
EOLM (End Of Last Month)	The last day of the previous month.	EOLM
EOLM-days	The last day of the previous month minus days specified.	EOLM-1  To include files that were active a day before the last day of the previous month.
BOTM (Beginning Of This Month)	The first day of the current month.	BOTM
BOTM+days	The first day of the current month, plus days specified.	BOTM+9  To include files that were active on the 10th day of the current month.

If this parameter is not specified, IBM Spectrum Protect exports all objects stored before the TODATE parameter and as qualified by the FILEDATA parameter. If no TODATE parameter is specified, then all data as qualified by the FILEDATA parameter is exported.

When a server-to-server export operation uses a relative FROMDATE, for example, TODAY-1, and the operation is restarted at a later date, the restarted process still uses the date that was used during the original operation. For example, if a server-to-server export operation is started on 07/04/2009 and the FROMDATE is specified as TODAY-1, the date that is used for selecting files is 07/03/2009. If this same export operation is suspended and restarted ten days later (07/14/2009), the date that is used for selecting files is still 07/03/2009. This behavior ensures that the entire export operation uses the same cutoff date for selecting files to export.

#### TODate

Specifies the latest date for files to be exported from the server. Files stored on the server on a date later than the TODATE value are not exported. TODATE only applies to client file data and does not affect other information that is being exported, such as policy.

- IBM Spectrum Protect ignores the TODATE parameter when the FILEDATA parameter is set to NONE.
- If a TODATE parameter is specified without a TOTIME parameter, the server exports all objects inserted on or before the day specified by the TODATE parameter.
- If you specified the FROMDATE parameter, the value of TODATE must be later than or equal to the FROMDATE value. If the TODATE and FROMDATE are equal, then the TOTIME parameter must be later than the FROMTIME parameter.
- The TODATE parameter does not apply to directories. All directories in a file space are processed even if the directories were not backed up in the specified date range.

Use one of the following values to specify the date:

Value	Description	Example
MM/DD/YYYY	A specific date	10/15/2006
TODAY	The current date	TODAY

Value	Description	Example
TODAY-days or -days	The current date minus days specified. The maximum number of days you can specify is 9999.	TODAY -3 or -3.
EOLM (End Of Last Month)	The last day of the previous month.	EOLM
EOLM-days	The last day of the previous month minus days specified.	EOLM-1 To include files that were active a day before the last day of the previous month.
BOTM (Beginning Of This Month)	The first day of the current month.	BOTM
BOTM+days	The first day of the current month, plus days specified.	BOTM+9 To include files that were active on the 10th day of the current month.

When a server-to-server export operation uses a relative TODATE, for example, TODAY-1, and the operation is restarted at a later date, the restarted process still uses the date that was used during the original operation. For example, if a server-to-server export operation is started on 07/04/2009 and the TODATE is specified as TODAY-1, the date that is used for selecting files is 07/03/2009. If this same export operation is suspended and restarted ten days later (07/14/2009), the date that is used for selecting files is still 07/03/2009. This behavior ensures that the entire export operation uses the same cutoff date for selecting files to export.

#### FROMTime

Specifies the earliest time for which objects to be exported were stored on the server. When you specify FROMTIME, you must also use the FROMDATE parameter. This parameter only applies to client file data. This parameter does not affect other information that might be exported, for example, policy. Objects that were stored on the server before the specified time and date are not exported. IBM Spectrum Protect ignores the FROMTIME parameter when the FILEDATA parameter is set to NONE.

Important: If you have group data on the node that you are exporting, data that was backed up before the designated FROMDATE and FROMTIME can also be exported. An example of group data on the node is virtual machine data or system state backup data. This export is a result of incremental backup processing for the data. The incremental backup processing can cause extra files that do not meet the filtering criteria to be exported so that there is a consistent image for the backup data.

The default value for this parameter when used with the FROMDATE parameter is midnight (00:00:00).

Use one of the following values to specify the time:

Value	Description	Example
HH:MM:SS	A specific time	10:30:08
NOW	The current time	NOW
NOW+HH:MM or +HH:MM	The current time plus hours and minutes specified. The FROMTIME+ can only be used with a FROMDATE before today.	NOW+02:00 or +02:00. If you issue this command at 5:00 with FROMTIME=NOW+02:00 or FROMTIME=+02:00, the export operation only contains files that were put on the server after 7:00 on the FROMDATE that you specify.
NOW-HH:MM or -HH:MM	The current time minus hours and minutes specified	NOW -02:00 or -02:00. If you issue this command at 5:00 with FROMTIME=NOW-02:00 or FROMTIME=-2:00, the export includes files that were put on the server after 3:00.

#### TOTime

Specifies the latest time that objects to be exported were stored on the server. You must specify the TODATE parameter in order to use the TOTIME parameter. TOTIME only applies to client file data and does not affect other information that is

being exported, such as policy. IBM Spectrum Protect ignores the TOTIME parameter if the FILEDATA parameter is set to NONE.

The default value for this parameter, when used with the TODATE parameter, is midnight minus one second (23:59:59).

Important: The value of the TOTIME and TODATE parameters must be later than the FROMDATE and the FROMTIME value. Use one of the following values to specify the time:

Value	Description	Example
HH:MM:SS	A specific time	10:30:08
NOW+HH:MM <b>or</b> +HH:MM	The current time plus hours and minutes specified.	NOW+02:00 <b>or</b> +02:00.  If you issue this command at 05:00 with FROMTIME=01:00 and TOTIME=NOW+02:00, the export includes files that were stored from 01:00 until 07:00.
NOW-HH:MM <b>or</b> -HH:MM	The current time minus hours and minutes specified.	NOW-02:00 <b>or</b> -02:00.  If you issue this command at 05:00 with FROMTIME=01:00 and TOTIME=NOW-02:00, the export includes files that were stored from 01:00 until 03:00.

#### TOServer

Specifies the name of a server to which the export data is sent directly over the network for immediate import.

Important: The target server must be defined on the originating server with the DEFINE SERVER command. The administrator that issues the export command must be defined with the same administrator name and password and have system authority on the target server.

When you specify TOSERVER, you cannot specify the DEVCLASS, VOLUMENAMES, and SCRATCH, USEDVOLUMELIST, and PREVIEW parameters.

#### PREVIEWImport

Specifies whether to view how much data is transferred, without actually moving any data. This information can be used to determine how much storage pool space is required on the target server. The default is NO.

Valid values are:

Yes

Specifies that you want to preview the results of the import operation on the target server, without importing the data. Information is reported to the server console and the activity log.

No

Specifies that you want the data to be imported on the target server without previewing the results.

#### MERGEfilespaces

Specifies whether IBM Spectrum Protect merges client files into existing file spaces on the target server (if they exist), or if IBM Spectrum Protect generates new file space names. The default is NO.

Valid values are:

Yes

Specifies that imported data on the target server is merged with the existing file space, if a file space with the same name exists on the target server.

No

Specifies that IBM Spectrum Protect generates a new file space name for imported data on the target server if file spaces with the same name exists.

#### Replacedefs

Specifies whether to replace definitions (not file data) on the server. The default is NO.

Valid values are:

Yes

Specifies that definitions are replaced on the server if definitions having the same name as those being imported exist on the target server.

No

Specifies that imported definitions are skipped if their names conflict with definitions that are already defined on the target server.

#### PROXynodeassoc

Specifies if proxy node associations are exported. This parameter is optional. The default value is NO.

#### ENCryptionstrength

Indicates which algorithm to use to encrypt passwords when exporting administrative and node records. This parameter is optional. The default value is AES. If you are exporting to a server that does not support AES, specify DES. You can specify one of the following values:

##### AES

Specifies the Advanced Encryption Standard.

##### DES

Specifies the Data Encryption Standard.

#### ALLOWSHREDdable

Specifies whether data from a storage pool that enforces shredding is exported. This parameter is optional. The default value is NO. Possible values are:

##### No

Specifies that the server does not allow data to be exported from a storage pool that enforces shredding.

##### Yes

Specifies that the server allows data to be exported from a storage pool that enforces shredding. The data on the export media will not be shredded.

Important: After an export operation finishes identifying files for export, any changes to the storage pool ALLOWSHREDABLE value is ignored. An export operation that is suspended retains the original ALLOWSHREDABLE value throughout the operation. You might want to consider canceling your export operation if changes to the storage pool ALLOWSHREDABLE value jeopardize the operation. You can reissue the export command after any needed cleanup.

#### EXPORTIdentifier

This optional parameter specifies the name that you selected to identify this export operation. If you do not specify a command name, the server generates one for you. The export identifier name cannot be more than 64 characters, cannot contain wildcard characters, and is not case sensitive. You can use the identifier name to reference export operations in the QUERY EXPORT, SUSPEND EXPORT, RESTART EXPORT, or CANCEL EXPORT commands. EXPORTIDENTIFIER is ignored if FILEDATA=NONE or if PREVIEWIMPORT=YES.

If you are specifying the EXPORTIDENTIFIER parameter, you must specify the TOSERVER parameter.

### Example: Export server information directly to another server

---

To export server information directly to SERVERB, issue the following command.

```
export server filedata=all toserver=serverb
```

### Example: Export server information directly to another server using a date range

---

To export directly to SERVERB between February 1, 2009 and today, issue the following command.

```
export server filedata=all toserver=serverb  
fromdate=02/01/2009 todate=today
```

### Example: Export server information and client file data directly to another server using a date and time range

---

To export directly to SERVERB from 8:00 a.m. on February 1, 2009 until today at 8:00 a.m., issue the following command.

```
export server filedata=all toserver=serverb  
fromdate=02/01/2009 fromtime=08:00:00  
todate=today totime=08:00:00
```

## EXTEND DBSPACE (Increase space for the database)

---

Use this command to increase space for the database by adding directories for the database to use.

## Privilege class

To issue this command, you must have system privilege or unrestricted storage privilege.

When you issue the EXTEND DBSPACE command, directories are added to the database. With the default parameter settings, data is redistributed across all database directories, and storage space is reclaimed. This action improves parallel I/O performance and makes the new directory space available for immediate use.

If you do not want to redistribute data when you add new directories, you can specify `RECLAIMSTORAGE=NO`. If you specify `NO` for this parameter, all space in existing directories is filled before new directories are used. You can redistribute data and reclaim space later, but you must complete the manual procedure for this task by using DB2 commands.

**Restriction:** Redistribution of data and reclaiming of space as part of an operation to extend database space works only with DB2 Version 9.7 or later table spaces. The table spaces are created when you format a new IBM Spectrum Protect™ Version 6.2 or later server. If you upgraded or restored your IBM Spectrum Protect server from V6.1, you cannot redistribute data or reclaim space. You must issue the EXTEND DBSPACE command with `RECLAIMSTORAGE=NO`.

**Important:** The redistribution process uses considerable system resources, so ensure that you plan ahead when you want to add space to the database. Review the following guidelines:

- Complete the process when the server is not handling a heavy workload.
- The time that is required to redistribute data and reclaim space might vary. It is affected by factors such as the file system layout, the ratio of new paths to existing storage paths, server hardware, and concurrent operations. To get a rough estimate, you can try the operation with a small IBM Spectrum Protect database on a lab system. Use your results as a reference to estimate the time that is required for the procedure.
- Do not interrupt the redistribution process. If you try to stop it, for example, by halting the process that is completing the work, you must stop and restart the DB2® server. When the server is restarted, it will go into crash recovery mode, which takes several minutes, after which the redistribution process resumes.

After an operation to extend the database space is complete, halt and restart the server to fully use the new directories. If the existing database directories are nearly full when a new directory is added, the server might encounter an out of space condition (reported in the `db2diag.log`). You can fix the out of space condition by halting and restarting the server.

## Syntax

```
      .-',-----'.
      v            |
>>-EXTend DBSpace---db_directory----->

      .-REclaimstorage---Yes----- .-Wait---No-----
>>-----+-----+-----+-----<<
      '-REclaimstorage---No---' '-Wait---No---'
              '-Yes-'              '-Yes-'
```

## Parameters

### db\_directory (Required)

Specifies the directories for database storage. The directories must be empty and accessible by the user ID of the database manager. A directory name must be a fully qualified name and cannot exceed 175 characters in length. Enclose the name in quotation marks if it contains embedded blanks, an equal sign, or other special characters. If you are specifying a list of directories for database storage, the maximum length of the list can be 1400 characters.

**Windows** Restriction: You cannot specify Universal Naming Convention (UNC) paths.

**Tip:** Specify directories that are the same size as existing directories to ensure a consistent degree of parallelism for database operations. If one or more directories for the database are smaller than the others, they reduce the potential for optimized parallel prefetching and distribution of the database.

### REClaimstorage

Specifies whether data is redistributed across newly created database directories and space is reclaimed from the old storage paths. This parameter is optional. The default value is Yes.

Unless you specify `WAIT=YES`, the operation is completed as a background process.

### Yes

Specifies that data is redistributed so that new directories are available for immediate use.

**Important:** The redistribution process uses considerable system resources so ensure that you plan ahead.



After the process starts, messages are issued to inform you about the progress. You can use the QUERY PROCESS command to monitor the operation. To cancel the process, you can use the CANCEL PROCESS command, but if a data redistribution operation is in progress, it completes before the process is stopped.

No

Specifies that data is not redistributed across database directories and storage space is not reclaimed when space is added for the database.

Wait

Specifies whether this command is processed in the background or foreground.

No

Specifies background processing. The default is NO.

Yes

Specifies foreground processing.

**AIX** | **Linux** You cannot specify YES from the server console.

**AIX** | **Linux**

## Example: Add directories to the storage space for the database, redistribute data, and reclaim storage

Add two directories (/tsm\_db/stg1 and tsm\_db/stg2) under the /tsm\_db directory to the storage space for the database. Issue the command:

```
extend dbspace /tsm_db/stg1,/tsm_db/stg2
```

**Windows**

## Example: Add drives to the storage space for the database, redistribute data, and reclaim storage

Add drives D and E to the storage space for the database. Issue the command:

```
extend dbspace D:,E:
```

## Related commands

Table 1. Commands related to EXTEND DBSPACE

Command	Description
DSMSERV EXTEND DBSPACE	Adds directories to increase space for use by the database.
QUERY DB	Displays allocation information about the database.
QUERY DBSPACE	Displays information about the storage space defined for the database.

### Related tasks:

Managing inventory capacity

## GENERATE commands

Use the GENERATE commands for backup sets for a selected filesystem or client node.

- GENERATE BACKUPSET (Generate a backup set of Backup-Archive Client data)
- GENERATE BACKUPSETTOC (Generate a table of contents for a backup set)
- **AIX** | **Linux** | **Windows** GENERATE DEDUPSTATS (Generate data deduplication statistics)

## GENERATE BACKUPSET (Generate a backup set of Backup-Archive Client data)

Use this command to generate a backup set for a Backup-Archive Client node. A *backup set* is a collection of a Backup-Archive Client's active backed up data, which is stored and managed as a single object, on specific media, in server storage. Although you can create a backup set for any client node, a backup set can be used only by a Backup-Archive Client.

Restriction: A backup set in "deduplication format" has that designation as a result of a GENERATE BACKUPSET command with at least one of the following specifications:

- Includes a node at Backup-Archive Client Version 6.1.x (at least V6.1.0 but less than V6.2.0).
- Includes a node that has one or more nodes that are authorized to act as a proxy. At least one of those proxy nodes is at Backup-Archive Client V6.1.x.

Backup sets in the deduplication format can be restored only by the V6.1.2 or later Backup-Archive Client. Backup-Archive Clients before V6.1.2 cannot restore from a backup set that is in the deduplication format.

A backup set in the "distributed deduplication format" has that designation as a result of a GENERATE BACKUPSET command with at least one of the following specifications:

- Includes a node at Backup-Archive Client level V6.2.0 or later.
- Includes a node that has one or more nodes that are authorized to act as a proxy. At least one of those proxy nodes is at Backup-Archive Client V6.2.0.

Backup sets in the distributed deduplication format can be restored only by the V6.2.0 or later Backup-Archive Client.

Restriction: You cannot generate a backup set with files that were backed up to IBM Spectrum Protect™ using NDMP. However, you can create a backup set with files that were backed up using NetApp SnapShot Difference.

The server creates copies of active versions of a client's backed up objects that are within the one-or-more file spaces specified with this command. The server then consolidates them onto sequential media. Currently, the backup object types that are supported for backup sets include directories and files only.

The backup-archive client node can restore its backup set from the server and from the media to which the backup set was written.

This command generates a background process that can be canceled with the CANCEL PROCESS command. If the background process created by this command is canceled, the media might not contain a complete backup set. You can use the QUERY PROCESS command to show information about the background process that is created by this command.

Tip: When IBM Spectrum Protect generates a backup set, you can improve performance if the primary storage pools containing the client data are collocated. If a primary storage pool is collocated, client node data is likely to be on fewer tape volumes than it would be if the storage pool were not collocated. With collocation, less time is spent searching database entries, and fewer mount operations are required.

## Privilege class

To issue this command, you must have system privilege or policy privilege for the domain to which the client node is assigned.

## Syntax

```

      .-,-----
      | v                                     |
>>-GENerate BACKUPSET-----+----->
      | '-node_name-----+'
      | '-node_group_name-'
      |
      | .-*-----
>>-backup_set_name_prefix--+----->
      | | .-,----- |
      | | v           | |
      | | '-file_space_name-+'
      |
      | .-SCRatch---Yes-----
>>-DEVclass---device_class_name--+----->
      | '-SCRatch---Yes-+'
      | '-No--'
      |
>--+----->
      | | .-,----- |
      | | v           | |
      | | '-VOLumes-----volume_names-+'

```

```

.-RETention----365-----
>-----+-----+-----+-----+----->
'-RETention----+days----+'
          '-NOLimit-'

                              .-Wait----No-----
>-----+-----+-----+-----+----->
'-DESCription----description-' '-Wait----+No--+-'
                              '-Yes-'

.-NAMEType----SERVER-----
>-----+-----+-----+-----+----->
'-NAMEType----+SERVER--+-'
          +-UNICODE-+
          '-FSID----'

.-CODEType----BOTH-----
>-----+-----+-----+-----+----->
'-CODEType----+UNICODE----+'
          +-NONUNICODE-+
          '-BOTH-----'

.-PITDate----current_date-.  .-PITTime----current_time-.
>-----+-----+-----+-----+----->
'-PITDate----date-----' '-PITTime----time-----'

.-DATAType----FILE----- .-TOC----Preferred-----
>-----+-----+-----+-----+----->
|           .-,----- . | '-TOC----+No-----+'
|           V           | | +-Preferred-+
'-DATAType----+FILE--+-' '-Yes-----'
          +-IMAGE-+
          '-ALL----'

>-----+-----+-----+-----+----->
'-TOCMgmtclass----class_name-'

.-ALLOWSHREDDable----No-----
>-----+-----+-----+-----+-----><
'-ALLOWSHREDDable----+No--+-'
          '-Yes-'

```

## Parameters

**node\_name** or **node\_group\_name** (Required)

Specifies the name of the client node and node groups whose data is contained in the backup set. To specify multiple node names and node group names, separate the names with commas and no intervening spaces. You can use wildcard characters with node names but not with node group names. When multiple node names are specified, the server generates a backup set for each node and places all of the backup sets together on a single set of output volumes.

**backup\_set\_name\_prefix** (Required)

Specifies the name of the backup set for the client node. The maximum length of the name is 30 characters.

When you select a name, IBM Spectrum Protect adds a suffix to construct your backup set name. For example, if you name your backup set *mybackupset*, IBM Spectrum Protect adds a unique number such as 3099 to the name. The backup set name is then identified to IBM Spectrum Protect as *mybackupset.3099*. To later show information about this backup set, you can include a wildcard with the name, such as *mybackupset.\** or specify the fully qualified name, such as *mybackupset.3099*.

When multiple node names or node group names are specified, the server generates a backup set for each node or node group and places all the backup sets on a single set of output volumes. Each backup set is given the same fully qualified name consisting of the *backup\_set\_name\_prefix* and a suffix determined by the server.

**file\_space\_name**

Specifies the names of one or more file spaces that contain the data to be included in the backup set. This parameter is optional. The file space name that you specify can contain wildcard characters. You can specify more than one file space by separating the names with commas and no intervening spaces. If you do not specify a file space, data from all the client nodes backed-up and active file spaces is included in the backup set.

For a server that has clients with support for Unicode-enabled file spaces, you can enter either a file space name or a file space ID (FSID). If you enter a file space name, you might need to have the server convert the file space name that you enter. For example, you might need to have the server convert the name that you enter from the server's code page to Unicode. See the NAMETYPE parameter for details. If you do not specify a file space name, or specify only a single wildcard character for the name, you can use the CODETYPE parameter to limit the operation to Unicode file spaces or to non-Unicode file spaces.

#### DEVclass (Required)

Specifies the name of the device class for the volumes to which the backup set is written. The maximum length of the name is 30 characters.

Restriction: You cannot specify a device class with a device type of NAS or CENTERA.

#### SCRatch

Specifies whether to use scratch volumes for the backup set. If you include a list of volumes using the VOLUMES parameter, the server uses scratch volumes only if the data cannot be contained in the volumes you specify. The default is SCRATCH=YES. The values are:

YES

Specifies to use scratch volumes for the backup set.

NO

Specifies not to use scratch volumes for the backup set.

#### VOLUMes

Specifies the names of one or more volumes that will contain the backup set. This parameter is optional. You can specify more than one volume by separating each volume with a comma, with no intervening spaces.

If you do not specify this parameter, scratch volumes are used for the backup set.

#### RETention

Specifies the number of days to retain the backup set on the server. You can specify an integer from 0 to 30000. The default is 365 days. The values are:

days

Specifies the number of days to retain the backup set on the server.

NOLimit

Specifies that the backup set should be retained on the server indefinitely.

If you specify NOLIMIT, the server retains the volumes containing the backup set forever, unless a user or administrator deletes the volumes from server storage.

#### DESCription

Specifies the description to associate with the backup set. This parameter is optional. The maximum length of the description is 255 characters. Enclose the description in quotation marks if it contains any blank characters.

#### Wait

Specifies whether to wait for the server to complete processing this command in the foreground. This parameter is optional. The default is NO. The values are:

Yes

Specifies the command processes in the foreground. Messages that are created are not displayed until the command completes processing. You cannot specify WAIT=YES from the server console.

No

Specifies that the command processes in the background. Use the QUERY PROCESS command to monitor the background processing of this command.

#### NAMEType

Specify how you want the server to interpret the file space names that you enter. This parameter is useful when the server has clients with support for Unicode-enabled file spaces. You can use this parameter for IBM Spectrum Protect clients using Windows, NetWare, or Macintosh OS X operating systems.

Use this parameter only when you enter a partly or fully qualified file space name. The default value is SERVER. Possible values are:

SERVER

The server uses the server's code page to interpret the file space names.

UNICODE

The server converts the file space name that is entered from the server code page to the UTF-8 code page. The success of the conversion depends on the actual characters in the name and the server's code page. Conversion can fail if the string includes characters that are not available in the server code page, or if the server has a problem accessing system conversion routines.

#### FSID

The server interprets the file space names as their file space IDs (FSIDs).

Important: Use care when specifying this parameter if multiple node names are also specified. Different nodes might use the same file space ID for different file spaces, or different file space IDs for the same file space name.

Therefore, specifying a file space ID as the file space names can result in the wrong data being written to the backup set for some nodes.

#### CODEType

Specify what type of file spaces are to be included in the operation. The default is BOTH, meaning that file spaces are included regardless of code page type. Use this parameter only when you enter a single wildcard character for the file space name or when you do not specify any file space names. Possible values are:

##### UNICODE

Include only file spaces that are in Unicode.

##### NONUNICODE

Include only file spaces that are not in Unicode.

##### BOTH

Include file spaces regardless of code page type.

#### PITDate

Specifies that files that were active on the specified date and that are still stored on the IBM Spectrum Protect server are to be included in the backup set, even if they are inactive at the time you issue the command. This parameter is optional. The default is the date on which the GENERATE BACKUPSET command is run. You can specify the date using one of the following values:

Value	Description	Example
MM/DD/YYYY	A specific date	09/15/1998
TODAY	The current date	TODAY
TODAY-days or -days	The current date minus days specified	TODAY-7 or -7.  To include files that were active a week ago, specify PITDATE=TODAY-7 or PITDATE=-7
EOLM (End Of Last Month)	The last day of the previous month.	EOLM
EOLM-days	The last day of the previous month minus days specified.	EOLM-1  To include files that were active a day before the last day of the previous month.
BOTM (Beginning Of This Month)	The first day of the current month.	BOTM
BOTM+days	The first day of the current month, plus days specified.	BOTM+9  To include files that were active on the 10th day of the current month.

#### PITTime

Specifies that files that were active on the specified time and that are still stored on the IBM Spectrum Protect server are to be included in the backup set, even if they are inactive at the time you issue the command. This parameter is optional. If a PITDate was specified, the default is midnight (00:00:00); otherwise the default is the time at which the GENERATE BACKUPSET command is started. You can specify the time using one of the following values:

Value	Description	Example
HH:MM:SS	A specific time on the specified PIT date	12:33:28
NOW	The current date on the specified PIT date	NOW

Value	Description	Example
NOW+HH:MM or +HH:MM	The current time plus hours and minutes on the specified PIT date	NOW+03:00 or +03:00  If you issue this command at 9:00 with PITTIME=NOW+03:00 or PITTIME=+03:00, IBM Spectrum Protect includes files that were active at 12:00 on the PIT date.

#### DATATYPE

Specifies that backup sets containing the specified types of data that are to be generated. This parameter is optional. The default is that file level backup sets are to be generated. To specify multiple data types, separate data types with commas and no intervening spaces.

The server generates a backup set for each data type and places all the backup sets on a single set of output volumes. Each backup set is given the same fully qualified name consisting of the *backup\_set\_name\_prefix* and a suffix determined by the server. However, each backup set has a different data type, as shown by the QUERY BACKUPSET command. Possible values are:

#### ALL

Specifies that backup sets for all types of data (file level, image, and application) that have been backed up on the server are to be generated.

#### FILE

Specifies that a file level backup set is to be generated. File level backup sets contain files and directories that are backed up by the backup client. If no files or directories have been backed up by the backup client, a file level backup set is not generated. This is the default.

#### IMAGE

Specifies that an image backup set is to be generated. Image backup sets contain images that are created by the backup client BACKUP IMAGE command. Image backup sets are generated only if an image has been backed up by the backup client.

#### TOC

Specifies whether a table of contents (TOC) is saved for each file level backup set. Tables of contents are always saved for backup sets containing image or application data. The TOC parameter is ignored when generating image and application backup sets. A table of contents will always be generated for image and application backup sets.

Consider the following in determining whether you want to save a table of contents:

- If a table of contents is saved for a backup set, you can use the IBM Spectrum Protect web backup-archive client to examine the entire file system tree and choose files and directories to restore. To create a table of contents, you must define the TOCDESTINATION attribute in the backup copy group for the management class that is specified by the TOCMGMTCLASS parameter. Creating a table of contents requires additional processing, storage pool space, and possibly a mount point during the backup set operation.
- If a table of contents is not saved for a backup set, you can still restore individual files or directory trees using the backup-archive client RESTORE BACKUPSET command, if you know the fully qualified name of each file or directory to be restored.

To display the contents of backup sets, you can also use the QUERY BACKUPSETCONTENTS command.

This parameter is optional. Possible values are:

#### No

Specifies that table of contents information is not saved for file level backup sets.

#### Preferred

Specifies that table of contents information should be saved for file level backup sets. This is the default. However, a backup set does not fail just because an error occurs during creation of the table of contents.

#### Yes

Specifies that table of contents information must be saved for each file level backup set. A backup set fails if an error occurs during creation of the table of contents.

#### TOCMgmtclass

Specifies the name of the management class to which the table of contents should be bound. If you do not specify a management class, the table of contents is bound to the default management class for the policy domain to which the node

is assigned. In this case, creation of a table of contents requires that you define the TOCDESTINATION attribute in the backup copy group for the specified management class.

**ALLOWSHREDDable**

Specifies whether data from a storage pool that enforces shredding is included in the backup set. This parameter is optional. Possible values are:

No

Specifies that data from a storage pool that enforces shredding is not included in the backup set. This is the default.

Yes

Specifies that data from a storage pool that enforces shredding can be included in the backup set. The data on the backup set media will not be shredded.

## Example: Generate a backup set for a file space

Generate a backup set of a file space that is called /srvr that belongs to client node JANE. Name the backup set PERS\_DATA and retain it for 75 days. Specify that volumes VOL1 and VOL2 contain the data for the backup set. The volumes are to be read by a device that is assigned to the AGADM device class. Include a description.

```
generate backupset jane pers_data /srvr devclass=agadm
retention=75 volumes=vol1,vol2
description="area 51 base image"
```

## Example: Generate a backup set of a Unicode-enabled file space

Generate a backup set of the Unicode-enabled file space, \\joe\c\$, that belongs to client node JOE. Name the backup set JOES\_DATA. Specify that volume VOL1 contain the data for the backup set. The volume is to be read by a device that is assigned to the AGADM device class. Have the server convert the \\joe\c\$ file space name from the server code page to the UTF-8 code page.

```
generate backupset joe joes_data \\joe\c$ devclass=agadm
volumes=vol1 nametype=unicode
```

## Related commands

Table 1. Commands related to GENERATE BACKUPSET

Command	Description
CANCEL PROCESS	Cancels a background server process.
COPY ACTIVATEDATA	Copies active backup data.
DEFINE COPYGROUP	Defines a copy group for backup or archive processing within a specified management class.
DEFINE NODEGROUP	Defines a group of nodes.
DEFINE NODEGROUPMEMBER	Adds a client node to a node group.
DEFINE BACKUPSET	Defines a previously generated backup set to a server.
DELETE BACKUPSET	Deletes a backup set.
DELETE NODEGROUP	Deletes a node group.
DELETE NODEGROUPMEMBER	Deletes a client node from a node group.
QUERY BACKUPSET	Displays backup sets.
GENERATE BACKUPSETTOC	Generates a table of contents for a backup set.
QUERY NODEGROUP	Displays information about node groups.
QUERY BACKUPSETCONTENTS	Displays contents contained in backup sets.
UPDATE BACKUPSET	Updates a retention value associated with a backup set.
UPDATE COPYGROUP	Changes one or more attributes of a copy group.
UPDATE NODEGROUP	Updates the description of a node group.





## Related commands

Table 1. Commands related to GENERATE BACKUPSETTOC

Command	Description
COPY ACTIVE DATA	Copies active backup data.
DEFINE COPYGROUP	Defines a copy group for backup or archive processing within a specified management class.
DEFINE NODEGROUP	Defines a group of nodes.
DEFINE NODEGROUPMEMBER	Adds a client node to a node group.
DEFINE BACKUPSET	Defines a previously generated backup set to a server.
DELETE BACKUPSET	Deletes a backup set.
DELETE NODEGROUP	Deletes a node group.
DELETE NODEGROUPMEMBER	Deletes a client node from a node group.
GENERATE BACKUPSET	Generates a backup set of a client's data.
QUERY BACKUPSET	Displays backup sets.
QUERY NODEGROUP	Displays information about node groups.
QUERY BACKUPSETCONTENTS	Displays contents contained in backup sets.
UPDATE BACKUPSET	Updates a retention value associated with a backup set.
UPDATE COPYGROUP	Changes one or more attributes of a copy group.
UPDATE NODEGROUP	Updates the description of a node group.

AIX Linux Windows

## GENERATE DEDUPSTATS (Generate data deduplication statistics)

Use this command to generate data deduplication statistics for a directory-container storage pool or a cloud-container storage pool to determine data deduplication performance.

### Privilege class

To issue this command, you must have system privilege, unrestricted storage privilege, or restricted storage privilege for the storage pool.

### Syntax

```
>>-Generate DEDUPStats--pool_name----->
. .,-----
V | .-*-----
>-----+--node_name-----+----->
    '-node_group_name-' | .,----- |
                        | V | |
                        +---fileSPACE_name---+
                        | .,----- |
                        | V | |
                        '-----FSID-----'

.-CODEType----BOTH----- .-MAXProcess----4-----
>-----+-----+----->
    '-CODEType----+UNICODE----+' '-MAXProcess----number-'
        +-NONUNICODE+
        '-BOTH-----'

.-NAMEType----SERVER----- .-Wait----No-----
```

```

>-----+-----+-----<
'-NAMEType--+-SERVER--+' '-Wait--+-No--+'
  +-UNICODE-+           '-Yes-'
  '-FSID----'

```

## Parameters

### pool\_name (Required)

Specifies the name of the storage pool that is reported in the data deduplication statistics. You can specify up to 30 characters for the storage pool name. If you specify more than 30 characters, the command fails.

Restriction: You can specify only directory-container storage pools or cloud storage pools.

### node\_name or node\_group\_name (Required)

Specifies the name of the client node or defined group of client nodes that is reported in the data deduplication statistics. You can also specify a combination of client node names and client-node group names. To specify multiple client node names or client-node group names, separate the names with commas with no intervening spaces. You can use wildcard characters with client node names but not with client-node group names.

### filesystem\_name or FSID

Specifies the names of one or more file spaces in the data deduplication statistics. This parameter is optional. You can use wildcard characters to specify this name. An asterisk is the default. Specify one of the following values:

\*

Specify an asterisk (\*) to show all file spaces or IDs.

### filesystem\_name

Specifies the name of the file space. Specify more than one file space by separating the names with commas and no intervening spaces. FSID specifies a file space identifier. This parameter is valid for clients with file spaces that are in Unicode format. Specify more than one file space by separating the names with commas and no intervening spaces.

For clients with file spaces that are in Unicode format, you can enter either a file space name or an FSID. If you enter a file space name, the server might have to convert the file space name that you enter. For example, the server might have to convert the name that you enter from the server's code page to Unicode.

Restrictions: The following restrictions apply to file space names and FSIDs:

- You must specify a node name if you specify a file space name.
- Do not specify both file space names and FSIDs on the same command.

### CODEType

Specifies what type of file spaces to include in the record. The default value is BOTH, which specifies that file spaces are included regardless of code page type. Use this parameter only when you enter an asterisk to display information about all file spaces. This parameter is optional. Specify one of the following values:

#### UNICODE

Include file spaces that are in Unicode format.

#### NONUNICODE

Include file spaces that are not in Unicode format.

#### BOTH

Include file spaces regardless of code page type. This is the default.

### MAXProcess

Specifies the maximum number of parallel processes to generate statistics for a container in a directory-container or cloud-container storage pool. This parameter is optional. Enter a value in the range 1 - 99. The default value is 4.

### NAMEType

Specifies how you want the server to interpret the file space names that you enter. Use this parameter when IBM Spectrum Protect™ clients have file spaces that are in Unicode format, and are on Windows, NetWare, or Macintosh OS X operating systems. This parameter is optional.

This parameter is required if you specify a node name and a file space name or FSID.

Restriction: When you specify this parameter, the file space name cannot contain an asterisk.

Specify one of the following values:

#### SERVER

The server uses the server's code page to interpret the file space names. This is the default.

#### UNICODE

The server converts the file space name that is entered from the server code page to the UTF-8 code page. The success of the conversion depends on the characters in the name and the server's code page.

Tip: Conversion can fail if the string includes characters that are not available in the server code page, or if the server cannot access system conversion routines.

#### FSID

The server interprets the file space names as their FSIDs.

#### Wait

Specifies whether the data deduplication statistics are generated in the foreground or background. This parameter is optional. You can specify one of the following values:

#### No

Specifies that the operation is completed in the background. You can continue with other tasks while the command is processing. Messages that are related to the background process are displayed in the activity log file or the server console, depending on where the messages are logged. This is the default value.

#### Yes

Specifies that the operation is completed in the foreground. It might take a long time to complete the operation. The operation must end before you can continue with other tasks. Messages are displayed in the activity log file or the server console, or both, depending on where the messages are logged.

Restriction: You cannot specify the WAIT=YES parameter from the server console.

## Example: Generate data deduplication statistics for a file space

Generate data deduplication statistics for a file space that is called /srvr that belongs to a directory-container storage pool, POOL1, that is stored on client node NODE1.

```
generate dedupstats pool1 node1 /srvr
```

## Example: Generate data deduplication statistics for a Unicode-enabled file space

Generate data deduplication statistics for a Unicode-enabled file space that is called \\abc\c\$ that belongs to client node NODE2. Convert the \\abc\c\$ file space name from the server code page to the UTF-8 code page.

```
generate dedupstats node2 \\abc\c$ nametype=unicode
```

## Related commands

Table 1. Commands related to GENERATE DEDUPSTATS

Command	Description
<b>AIX</b>   <b>Linux</b>   <b>Windows</b> DELETE DEDUPSTATS	Deletes data deduplication statistics.
<b>AIX</b>   <b>Linux</b>   <b>Windows</b> QUERY DEDUPSTATS	Displays data deduplication statistics.

## GRANT commands

Use the GRANT command to grant appropriate privileges or access.

- GRANT AUTHORITY (Add administrator authority)
- GRANT PROXYNODE (Grant proxy authority to a client node)

## GRANT AUTHORITY (Add administrator authority)

Use this command to grant an administrator one or more administrative privilege classes, and authority to access client nodes.

You cannot grant restricted privilege to an unrestricted policy or unrestricted storage administrator. You must use the REVOKE AUTHORITY command to remove the administrator's unrestricted privilege, then use this command to grant restricted privilege to the administrator.

## Privilege class

To issue this command, you must have system privilege.

## Syntax

```

>>-GRant AUTHority--admin_name----->
      .-,-----
      V          |
>--Classes-----+System-----+----->
      +-Policy-----+
      +-Storage-----+
      +-Operator-----+
      '-Node--| A |-'

>+-----+----->
|          .-,-----|
|          V          ||
|'-Dmains-----domain_name-+-'

>+-----+----->>
|          .-,-----|
|          V          ||
|'-STGpools-----pool_name-+-'

A

.-AUTHority-----Access-----
|-----+-----+-----+-----|
|'-AUTHority-----+Access-+-'   '-Node-----node_name-----'
|          '-Owner--'

```

Notes:

1. You must specify one or more of these parameters.

## Parameters

---

**admin\_name (Required)**

Specifies the name of the administrator being granted an administrative privilege class.

**Classes**

Specifies one or more privilege classes to grant to an administrator. This parameter is required, except when you specify the STGPOOLS parameter. You can specify more than one privilege class by separating each with a comma. Possible classes are:

**SYstem**

Specifies that you want to grant system privilege to an administrator. A system administrator has the highest level of authority in IBM Spectrum Protect™. A system administrator can issue any administrative command and has authority to manage all policy domains and all storage pools. Do not specify additional privilege classes or the DOMAINS or STGPOOLS parameters when granting system privilege to an administrator. Only a system administrator can grant authority to other administrators.

**Policy**

Specifies that you want to grant policy privilege to an administrator. If you do not specify the DOMAINS parameter, unrestricted policy privilege is granted. An unrestricted policy administrator can issue commands that affect all existing policy domains as well as any policy domains that are defined in the future. An unrestricted policy administrator cannot define, delete, or copy policy domains. Use the GRANT AUTHORITY command with CLASSES=POLICY and no DOMAINS parameter to upgrade a restricted policy administrator to an unrestricted policy administrator.

**STorage**

Specifies that you want to grant storage privilege to an administrator. If the STGPOOLS parameter is not specified, unrestricted storage privilege is granted. An unrestricted storage administrator can issue all commands that allocate and control storage resources for the server. An unrestricted storage administrator can issue commands that affect all existing storage pools as well as any storage pools that are defined in the future. An unrestricted storage administrator cannot define or delete storage pools. Using the GRANT AUTHORITY command with CLASSES=STORAGE and no STGPOOLS parameter upgrades a restricted storage administrator to an unrestricted storage administrator.

**Operator**

Specifies that you want to grant operator privilege to an administrator. An administrator with operator privilege can issue commands that control the immediate operation of the server and the availability of storage media.

**Node**

Specifies that you want to grant a node privilege to a user. A user with client node privilege can remotely access a web backup-archive client with an administrative user ID and password if they have been given owner authority or access authority. Access authority is the default for a node privilege class.

Attention: When you specify the node privilege class, you must also specify either the DOMAIN parameter or the NODE parameter, but not both.

#### AUTHority

Specifies the authority level of a user with node privilege. This parameter is optional.

If an administrator already has system or policy privilege to the policy domain to which the node belongs, this command will not change the administrator's privilege.

Possible authority levels are:

#### Access

Specifies that you want to grant client access authority to a user with the node privilege class. This is the default when CLASSES=NODE is specified. A user with client access authority can access a web backup-archive client and perform backup and restore actions on that client.

Attention: A user with client access authority cannot access that client from another system by using the -NODENAME or -VIRTUALNODENAME parameter.

A client node can set the REVOKEREMOTEACCESS option to restrict a user that has node privilege with client access authority from accessing a client workstation that is running a web client. This option does not apply to administrators with client owner authority, system privilege, or policy privilege to the policy domain to which the node belongs.

#### Owner

Specifies that you want to grant client owner authority to a user with the node privilege class. A user with client owner authority can access a web backup-archive client through the web client interface and also access their data from another client using the -NODENAME or -VIRTUALNODENAME parameter.

#### DOmains

Specifies that you want to grant to the administrator client access or client owner authority to all clients in the specified policy domain. You cannot use this parameter together with the NODE parameter.

#### NOde

Specifies that you want to grant the administrator client access or client owner authority to the node. You cannot use this parameter together with the DOMAIN parameter.

#### DOmains

When used with CLASSES=POLICY, specifies that you want to grant restricted policy privilege to an administrator.

Restricted policy privilege permits an administrator to issue a subset of the policy commands for the domains to which the administrator is authorized. You can use this parameter to grant additional policy domain authority to a restricted policy administrator. This parameter is optional. You can specify more than one policy domain by delimiting each policy domain name with a comma.

You can use wildcard characters to specify a name. Authority for all matching policy domains is granted.

#### STGpools

Specifies that you want to grant restricted storage privilege to an administrator. If the STGPOOLS parameter is specified, then CLASSES=STORAGE is optional.

Restricted storage privilege permits you to issue a subset of the storage commands for the storage pools to which the administrator is authorized. You can use this parameter to grant additional storage pool authority to a restricted storage administrator. This parameter is optional. You can specify more than one storage pool by delimiting each storage pool name with a comma.

You can use wildcard characters to specify a name. Authority for all matching storage pools is granted.

## Example: Grant system privilege to an administrator

---

Grant system privilege to administrator Larry.

```
grant authority larry classes=system
```

## Example: Grant access to additional policy domains

---

Specify additional policy domains that the restricted policy administrator CLAUDIA can manage.

```
grant authority claudia domains=employee_records,progl
```

## Example: Provide an administrator with unrestricted storage privilege and restricted policy privilege

---

Provide administrator TOM with unrestricted storage privilege and restricted policy privilege for the domains whose names start with EMP.

```
grant authority tom classes=storage domains=emp*
```

## Example: Grant an administrator authority restricted to a specific node

---

Grant node privilege to user HELP so that help desk personnel can assist the client node LABCLIENT in backing up or restoring data without having other higher-level IBM Spectrum Protect privileges.

```
grant authority help classes=node node=labclient
```

## Related commands

---

Table 1. Commands related to GRANT AUTHORITY

Command	Description
QUERY ADMIN	Displays information about one or more IBM Spectrum Protect administrators.
REVOKE AUTHORITY	Revokes one or more privilege classes or restricts access to policy domains and storage pools.

## GRANT PROXYNODE (Grant proxy authority to a client node)

---

Use this command to grant proxy authority to a client node on the IBM Spectrum Protect™ server.

Target client nodes own the data and agent nodes act on behalf of the target nodes. When granted proxy authority to a target client node, an agent node can perform backup and restore operations for the target node. Data that the agent node stores on behalf of the target node is stored under the target node's name in server storage.

## Privilege class

---

To issue this command, you must have one of the following privilege classes:

- System privilege
- Unrestricted policy privilege

## Syntax

---

```
>>-GRant PROXynode TArget--==--target_node_name----->  
>--AGent--==--agent_node_name-----<
```

## Parameters

---

TArget (Required)

Specifies the name of the node that owns the data. Wildcard names cannot be used to specify the target node name.

AGent (Required)

Specifies the name of the node performing operations for the target node. The agent node does not have to be in the same domain as the target node. Wildcard characters and comma-separated lists of node names are allowed.

## Example: Grant proxy authority to a client node

---

Assume that MOE and JOE are agent nodes in a NAS cluster and are used to backup and restore shared NAS data. To create a proxy authority relationship for target node NASCLUSTER, issue the following command:

```
grant proxynode target=nascluster agent=moe,joe
```

Issue the following command on agent node MOE to back up NAS cluster data stored on the E: drive. The name of the target node is NASCLUSTER.

```
dsmc -asnode=nascluster incremental e:
```

## Related commands

---

Table 1. Commands related to GRANT PROXYNODE

Command	Description
QUERY PROXYNODE	Display nodes with authority to act as proxy nodes.
REVOKE PROXYNODE	Revoke proxy authority from an agent node.

## HALT (Shut down the server)

---

Use this command to shut down the server. The HALT command forces an abrupt shutdown, which cancels all the administrative and client node sessions even if they are not completed.

Any transactions in progress interrupted by the HALT command are rolled back when you restart the server. Use the HALT command only after the administrative and client node sessions are completed or canceled. To shut down the server without severely impacting administrative and client node sessions, perform the following steps:

1. Use the DISABLE SESSIONS command to prevent starting new client node sessions.
2. Use the QUERY SESSIONS command to identify any existing administrative and client node sessions.
3. Notify any existing administrative and client node sessions that you plan to shut down the server (you must do this outside of IBM Spectrum Protect™).
4. Use the CANCEL SESSIONS command to cancel any existing administrative or client node sessions.
5. Issue the HALT command to shut down the server and stop any administrative and client node sessions.

Tip:

The HALT command can be replicated using the ALIASHALT server option. Use the server option to define a term other than HALT that performs the same function. The HALT command retains its normal function however, the server option provides an additional method for issuing the HALT command. See ALIASHALT for additional information.

## Privilege class

---

To issue this command, you must have system or operator privilege.

## Syntax

---

```
>>-HALT-----<<
```

## Parameters

---

None.

## Example: Shut down the server

---

Shut down the server, either from the server console or from an administrative client. All user activity stops immediately and no new activity can start.

```
halt
```

## Related commands

Table 1. Commands related to HALT

Command	Description
CANCEL PROCESS	Cancels a background server process.
CANCEL SESSION	Cancels active sessions with the server.
DISABLE SESSIONS	Prevents new sessions from accessing IBM Spectrum Protect but permits existing sessions to continue.
ENABLE SESSIONS	Resumes server activity following the DISABLE command or the ACCEPT DATE command.
QUERY PROCESS	Displays information about background processes.
QUERY SESSION	Displays information about all active administrator and client sessions with IBM Spectrum Protect.

## HELP (Get help on commands and error messages)

Use this command to display administrative commands and error messages. You can issue the command from an administrative command line client.

### Privilege class

Any administrator can issue this command.

### Syntax

```
>>-Help--+-+-----+----->>
      +-help_topic_number-----+
      |           .-,-----+
      |           v           | |
      +-command_name-----+--+
      |           '-subcommand_name-' |
      +-message_number-----+
      +-server_option_name-----+
      '-utility_name-----'
```

### Parameters

#### help\_topic\_number

Specifies the number of your selection from the help topics. This parameter is optional.

Topic numbers are displayed in the table of contents, for example:

```
3.0 Administrative commands
```

```
...
```

```
3.13.10 DEFINE DEVCLASS (Define a device class)
```

```
3.13.10.1 DEFINE DEVCLASS (Define a 3590 device class)
```

```
3.13.10.2 DEFINE DEVCLASS (Define a 3592 device class)
```

```
...
```

The topic number for the command DEFINE DEVCLASS for a 3592 device class is 3.13.10.2.

#### command\_name

Specifies the name of the administrative command you want to display. This parameter is optional.

#### subcommand\_name

Specifies up to two of the subcommand names that are associated with the name of the administrative command that you want to display. This parameter is optional.

#### message\_number

Specifies the number of the message for which you want to display information. This parameter is optional. You can get help information about server messages (prefixed by ANR) and client messages (prefixed by ANE or ANS). Do not include



the prefix and severity code when specifying an error message number.

`server_option_name`  
Specifies the name of the server option for which you want to display information. This parameter is optional.

`utility_name`  
Specifies the name of the server utility for which you want to display information. This parameter is optional.

## Example: Display the help topics

---

Display the help topics for the command-line interface.

```
help
```

Partial output:

```
1.0 Administering the server from the command line
  1.1 Issuing commands from the administrative client
    1.1.1 Starting and stopping the administrative client
    1.1.2 Monitoring server activities from the administrative client
```

## Example: Display a help topic by using the help topic number

---

Display help information by using the help topic number. The topic number for the command `DEFINE DEVCLASS` for a 3592 device class is 3.13.10.2.

```
help 3.13.10.2
```

## Example: Display help for one command

---

Display help information about the `REMOVE` commands.

```
help remove
```

```
3.44 REMOVE commands
Use the REMOVE commands to remove an object.
The following is a list of REMOVE commands:
* 3.44.1, "REMOVE ADMIN (Delete an administrator)"
* 3.44.2, "REMOVE NODE (Delete a node or an associated machine node)"
```

## Example: Display help for a specific error message

---

Display help information about the error message `ANR2535E`.

```
help 2535
```

```
ANR2535E Command: The node node name cannot be removed or renamed
because it has an associated data mover.
Explanation: You attempted to remove or rename a node that has an
associated data mover.
System action: The server does not remove or rename the node.
User response: To remove or rename the node, delete the associated data
mover and reissue the command.
```

## Example: Display help for a specific option

---

Display the description, syntax, and an example for the `COMMMETHOD` server option.

```
help commmethod
```

## Example: Display help for a specific utility

---

Display the description, syntax, and an example for the `DSMSERV` utility.

```
help dsmserv
```

# IDENTIFY DUPLICATES (Identify duplicate data in a storage pool)

---

Use this command to start or stop processes that identify duplicate data in a storage pool. You can specify the number of duplicate-identification processes and their duration.

When you create a new storage pool for data deduplication, you can specify 0 - 50 duplicate-identification processes. IBM Spectrum Protect™ starts the specified number of duplicate-identification processes automatically when the server is started. If you do not stop them, they run indefinitely.

This command affects only server-side deduplication processing. In client-side data deduplication processing, duplicates are identified on the backup-archive client.

With the IDENTIFY DUPLICATES command, you can start more processes, stop some or all of the processes, and specify an amount of time that the change remains in effect. If you increased or decreased the number of duplicate-identification processes, you can use the IDENTIFY DUPLICATES command to reset the number of processes to the number that is specified in the storage pool definition.

If you did not specify any duplicate-identification processes in the storage pool definition, you can use the IDENTIFY DUPLICATES command to start and stop all processes manually.

This command starts or stops a background process or processes that you can cancel with the CANCEL PROCESS command. To display information about background processes, use the QUERY PROCESS command.

Important:

- You can also change the number of duplicate-identification processes by updating the storage pool definition by using the UPDATE STGPOOL command. However, when you update a storage pool definition, you cannot specify a duration. The processes that you specify in the storage pool definition run indefinitely, or until you issue the IDENTIFY DUPLICATES command, update the storage pool definition again, or cancel a process.

Issuing the IDENTIFY DUPLICATES does not change the setting for the number of duplicate-identification processes in the storage pool definition.

- Duplicate-identification processes can be either active or idle. Processes that are deduplicating files are active. Processes that are waiting for files to deduplicate are idle. Processes remain idle until volumes with data to be deduplicated become available. Processes stop only when canceled or when you change the number of duplicate-identification processes for the storage pool to a value less than what is specified. Before a duplicate-identification process stops, it must finish the file that it is deduplicating.

The output of the QUERY PROCESS command for a duplicate-identification process includes the total number of bytes and files that have been processed since the process first started. For example, if a duplicate-identification process processes four files, becomes idle, and then processes five more files, then the total number of files that are processed is nine.

---

## Privilege class

To issue this command, you must have system privilege.

---

## Syntax

```
>>-IDentify DUPLICates--stgpool_name----->
>--+-----+--+-----+-----><
  '-NUMPRocess----number-' '-DURation----minutes-'
```

---

## Parameters

stgpool\_name (Required)

Specifies the storage pool name in which duplicate data is to be identified. You can use wildcards.

NUMPRocess

Specifies the number of duplicate-identification processes to run after the command completes. You can specify 0 - 50 processes. The value that you specify for this parameter overrides the value that you specified in the storage pool definition or the most recent value that was specified when you last issued this command. If you specify zero, all duplicate-identification processes stop.

This parameter is optional. If you do not specify a value, the server starts or stops duplicate-identification processes so that the number of processes is the same as the number that is specified in the storage pool definition.

For example, suppose that you define a new storage pool and specify two duplicate-identification processes. Later, you issue the IDENTIFY DUPLICATES command to increase the number of processes to four. When you issue the IDENTIFY DUPLICATES command again without specifying a value for the NUMPROCESS parameter, the server stops two duplicate-identification processes.

If you specified 0 processes when you defined the storage pool definition and you issue IDENTIFY DUPLICATES without specifying a value for NUMPROCESS, any running duplicate-identification processes stop, and the server does not start any new processes.

Remember: When you issue IDENTIFY DUPLICATES without specifying a value for NUMPROCESS, the DURATION parameter is not available. Duplicate-identification processes specified in the storage pool definition run indefinitely, or until you reissue the IDENTIFY DUPLICATES command, update the storage pool definition, or cancel a process.

When the server stops a duplicate-identification process, the process completes the current physical file and then stops. As a result, it might take several minutes to reach the number of duplicate-identification processes that you specified as a value for this parameter.

#### DURation

Specifies the maximum number of minutes (1 - 9999) that this command remains in effect. At the end of the specified time, the server starts or stops duplicate-identification processes so that the number of processes is the same as the number that is specified in the storage pool definition.

This parameter is optional. If you do not specify a value, the processes that are running after the command is issued run indefinitely. They end only if you reissue the IDENTIFY DUPLICATES command, update the storage pool definition, or cancel a process.

For example, if you define a storage pool with two duplicate-identification processes and you issue the IDENTIFY DUPLICATES command with DURATION=60 and NUMPROCESS=4, the server starts two more duplicate-identification processes that run for 60 minutes. At the end of that time, two processes finish the files that they are working on and stop. The two processes that stop might not be the same two processes that started as a result of issuing this command.

The server stops idle processes first. If after stopping all idle processes, more processes need to be stopped, the server notifies active processes to stop.

When the server stops a duplicate-identification process, the process completes the current physical file and then stops. As a result, it might take several minutes to reach the amount of time that you specified as a value for this parameter.

### Example: Controlling the number and duration of duplicate-identification processes

In this example, you specified three duplicate-identification processes in the storage pool definition. You use the IDENTIFY DUPLICATES command to change the number of processes and to specify the amount of time the change is to remain in effect.

Table 1. Controlling duplicate-identification processes manually

The storage pool definition specifies three duplicate-identification processes. Using the IDENTIFY DUPLICATES command, you specify...	...and a duration of...	The result is...
2 duplicate-identification processes	None specified	One duplicate-identification process finishes the file that it is working on, if any, and then stops. Two processes run indefinitely, or until you reissue the IDENTIFY DUPLICATES command, update the storage pool definition, or cancel a process.
	60 minutes	One duplicate-identification process finishes the file that it is working on, if any, and then stops. After 60 minutes, the server starts one process so that three are running.

The storage pool definition specifies three duplicate-identification processes. Using the IDENTIFY DUPLICATES command, you specify...	...and a duration of...	The result is...
4 duplicate-identification processes	None specified	The server starts one duplicate-identification process. Four processes run indefinitely, or until you reissue the IDENTIFY DUPLICATES command, update the storage pool definition, or cancel a process.
	60 minutes	The server starts one duplicate-identification process. At the end of 60 minutes, one process finishes the file that it is working on, if any, and then stops. The additional process started by this command might not be the one that stops when the duration has expired.
0 duplicate-identification processes	None specified	All duplicate-identification processes finish the files that they are working on, if any, and stop. This change lasts indefinitely, or until you reissue the IDENTIFY DUPLICATES command, update the storage pool definition, or cancel a process.
	60 minutes	All duplicate-identification processes finish the files that they are working on, if any, and stop. At the end of 60 minutes, the server starts three processes.
None specified	Not available	The number of duplicate-identification processes resets to the number of processes that are specified in the storage pool definition. This change lasts indefinitely, or until you reissue the IDENTIFY DUPLICATES command, update the storage pool definition, or cancel a process.

## Example: Identify duplicates in a storage pool

Identify duplicates in a storage pool, STGPOOLA, using three duplicate-identification processes. Specify that this change is to remain in effect for 60 minutes.

```
identify duplicates stgpoola duration=60 numprocess=3
```

## Related commands

Table 2. Commands related to IDENTIFY DUPLICATES

Command	Description
CANCEL PROCESS	Cancels a background server process.
DEFINE STGPOOL	Defines a storage pool as a named collection of server storage media.
QUERY CONTENT	Displays information about files in a storage pool volume.
QUERY PROCESS	Displays information about background processes.
QUERY STGPOOL	Displays information about storage pools.
UPDATE STGPOOL	Changes the attributes of a storage pool.

## IMPORT commands

Use the IMPORT commands to import information from export media to an IBM Spectrum Protect™ server.

Important: For commands that import administrators or nodes, you must consider the method of authentication. The IBM Spectrum Protect server cannot export or import passwords for nodes or administrators that are authenticating with LDAP directory servers. If the current authentication method uses an LDAP directory server and the password is not already

synchronized by that server, you must update the password. After issuing the IMPORT command, set the password by issuing the UPDATE ADMIN or UPDATE NODE command.

- IMPORT ADMIN (Import administrator information)
- IMPORT NODE (Import client node information)
- IMPORT POLICY (Import policy information)
- IMPORT SERVER (Import server information)

## IMPORT ADMIN (Import administrator information)

Use this command to import administrator and authority definitions for one or more administrators from export media to the IBM Spectrum Protect™ server.

**Important:** For commands that import administrators or nodes, you must consider the method of authentication. The IBM Spectrum Protect server cannot export or import passwords for nodes or administrators that are authenticating with LDAP directory servers. If the current authentication method uses an LDAP directory server and the password is not already synchronized by that server, you must update the password. After issuing the IMPORT command, set the password by issuing the UPDATE ADMIN or UPDATE NODE command.

You can use the QUERY ACTLOG command to view the status of the import operation.

You can also view this information from the server console.

**Limitation:** The IBM Spectrum Protect server does not convert code pages during export, import, and node replication operations. If servers are running in different locales, some information in databases or system output might become unreadable. Invalid characters might be displayed, for example, in the contact information for the administrator and client nodes, and in descriptions of policy domains. Any field that is stored in the server character set and that includes extended ASCII characters can be affected. To resolve the issue after the import or node replication operation, update the fields with the appropriate UPDATE commands. This server limitation does not affect client data. Any client data that was exported, imported, or replicated can be restored, retrieved, and recalled.

This command generates a background process that can be canceled with the CANCEL PROCESS command. If an IMPORT ADMIN background process is canceled, some of the data is already imported. To display information about background processes, use the QUERY PROCESS command.

Restriction:

- If target and source server levels are not compatible, the operation might not work.
- If the administrator definition that is being imported includes analyst authority, the administrator definition is imported but not the analyst authority. Analyst authority is not valid for servers at V6.1 or later.
- Importing data from a CENTERA device class is not supported. However, files that are being imported can be stored on a CENTERA storage device.

## Privilege class

To issue this command, you must have system privilege.

## Syntax

```

>>-IMport Admin-----.*-----.-Preview-----No-----.
| .,-----.| '-Preview-----+No--+-'
| V          | | '-Yes-'
'---admin_name+--'

>--DEVclass-----device_class_name----->
          .-,-----
          V          |

>>-VOLumentname-----+---volume_name+--->
          '-FILE:--file_name-'

.-Replacedefs-----No-----
>--+----->>
'-Replacedefs-----+No--+-'

```

## Parameters

### admin\_name

Specifies the administrators for which you want to import information. This parameter is optional. Separate multiple names with commas and no intervening spaces. You can use wildcard characters to specify names.

### Preview

Specifies whether you want to preview the results of the import operation, without importing administrator information. This parameter is optional. The following parameter values are supported:

#### No

Specifies that the information is to be imported.

#### Yes

Specifies that the operation is previewed but not completed. Information about the number and types of objects that are imported, together with the number of bytes transferred, are reported to the server console and the activity log.

The default value is NO. If you specify YES for the value, you must mount the export volumes.

### DEVclass (Required)

Specifies the device class from which import data is to be read.

You cannot specify the DISK, NAS, or CENTERA device classes.

If all drives for the device class are busy when the import runs, IBM Spectrum Protect cancels lower priority operations, such as reclamation, to make a drive available.

### VOLumentname (Required)

Specifies the volumes to be used for the import operation. Volumes must be imported in the same order as they were exported. The following parameter values are supported:

#### volume\_name

Specifies the volume name. To specify multiple volumes, separate names with commas and no intervening spaces.

#### FILE:file\_name

Specifies the name of a file that contains a list of volumes that are used for the imported data. In the file, each volume name must be on a separate line. Blank and comment lines that begin with an asterisk are ignored.

Use these naming conventions when you specify volumes that are associated with the following device types:

For this device	Specify
Tape	1 - 6 alphanumeric characters.
FILE	Any fully qualified file name string. For example: <div style="display: flex; justify-content: space-between; margin-top: 5px;"> <span>AIX</span> <span>Linux</span> <span>/imdata/mt1.</span> </div> <div style="display: flex; justify-content: space-between; margin-top: 5px;"> <span>Windows</span> <span>d:\program files\tivoli\tsm\data1.dsm.</span> </div>
<div style="display: flex; justify-content: space-between; margin-bottom: 5px;"> <span>AIX</span> <span>Linux</span> <span>Windows</span> </div> REMOVABLEFILE	<div style="display: flex; justify-content: space-between; margin-bottom: 5px;"> <span>AIX</span> <span>Linux</span> <span>Windows</span> </div> 1 - 6 alphanumeric characters.
SERVER	1 - 250 alphanumeric characters.

### Replacedefs

Specifies whether to replace administrator definitions on the target server. The following parameter values are supported:

#### No

Specifies that definitions are not to be replaced.

#### Yes

Specifies that definitions are to be replaced.

The default value is NO.

## Example: Import administrator information from specific tape volumes

From the server, import the information for all defined administrators from tape volumes TAPE01, TAPE02, and TAPE03. Specify that these tape volumes be read by a device that is assigned to the MENU1 device class. Issue the command:

```
import admin devclass=menu1
volumenames=tape01,tape02,tape03
```

## Example: Import administrator information from tape volumes listed in a file

From the server, import the information for all defined administrators from tape volumes that are listed in the following file:

- **AIX** | **Linux** TAPEVOL
- **Windows** TAPEVOL.DATA

This file contains these lines:

```
TAPE01
TAPE02
TAPE03
```

Specify that these tape volumes be read by a device that is assigned to the MENU1 device class. Issue the command:

```
AIX | Linux
import admin devclass=menu1 volumenames=file:tapevol

Windows
import admin devclass=menu1 volumenames=file:tapevol.data
```

## Related commands

Table 1. Commands related to IMPORT ADMIN

Command	Description
CANCEL PROCESS	Cancels a background server process.
EXPORT ADMIN	Copies administrative information to external media or directly to another server.
IMPORT NODE	Restores client node information from external media.
IMPORT POLICY	Restores policy information from external media.
IMPORT SERVER	Restores all or part of the server from external media.
QUERY ACTLOG	Displays messages from the server activity log.
QUERY PROCESS	Displays information about background processes.

## IMPORT NODE (Import client node information)

Use this command to import client node definitions from a server or sequential media to a target IBM Spectrum Protect™ server.

**Important:** For commands that import administrators or nodes, you must consider the method of authentication. The IBM Spectrum Protect server cannot export or import passwords for nodes or administrators that are authenticating with LDAP directory servers. If the current authentication method uses an LDAP directory server and the password is not already synchronized by that server, you must update the password. After issuing the IMPORT command, set the password by issuing the UPDATE ADMIN or UPDATE NODE command.

If you specify a domain on the source server and if that policy domain also exists on the target server, the imported nodes get associated with that same policy domain on the target server. Otherwise, imported nodes are associated with the STANDARD policy domain on the target server.

IBM Spectrum Protect servers with retention protection enabled do not allow import operations.

Restrictions:

1. If target and source server levels are not compatible, the operation might not work.
2. Importing data from a CENTERA device class is not supported. However, files that are being imported can be stored on a CENTERA storage device.
3. If you use an LDAP directory server to authenticate passwords, any target servers must be configured for LDAP passwords. Data that is imported from a node that authenticates with an LDAP directory server is inaccessible if the target server is not

properly configured. If your target server is not configured, imported data from an LDAP node can still go there. But the target server must be configured to use LDAP in order for you to access the imported data.

4. If target and source server levels are not compatible, the operation might not work.
5. You cannot use a CENTERA device class as the target medium for an export command, or as the source medium for an import command.
6. Incrementally exporting/importing the following types of client data to another IBM Spectrum Protect server is not supported:
  - o VMWare backups where full plus incremental backups need to be periodically, incrementally transferred to another server.
  - o Backups groups where full plus differential backups need to be periodically, incrementally transferred to another server.
  - o **Windows** Windows System State data that is periodically, incrementally transferred to another server.

Full export/import of this data to a new file system on the target is supported by exporting the entire filespace that contains the data. In other words, the export must not use the *FILEDATA=ALLACTIVE, FROMDATE, TODATE, or MERGEFILESACES* options.

The best practice for incrementally transferring this type of data between two servers is to use Node Replication.

You can use the QUERY ACTLOG command to view the status of the import operation. You can also view this information from the server console.

This command generates a background process that can be canceled with the CANCEL PROCESS command. If an IMPORT NODE background process is canceled, some of the data might already be imported. To display information about background processes, use the QUERY PROCESS command.

For a server that has clients with support for Unicode, you can get the server to convert the file space name that you enter, or use the following parameters:

- HEXFILESPACE
- UNIFILESSPACE

Limitation: The IBM Spectrum Protect server does not convert code pages during export, import, and node replication operations. If servers are running in different locales, some information in databases or system output might become unreadable. Invalid characters might be displayed, for example, in the contact information for the administrator and client nodes, and in descriptions of policy domains. Any field that is stored in the server character set and that includes extended ASCII characters can be affected. To resolve the issue after the import or node replication operation, update the fields with the appropriate UPDATE commands. This server limitation does not affect client data. Any client data that was exported, imported, or replicated can be restored, retrieved, and recalled.

## Privilege class

---

To issue this command, you must have system privilege.

## Syntax

---

```

      .-*-----
>>-Import Node----->
      | .-,-----|
      | v          | |
      |'---node_name-+-'
>----->
      | .-,-----|
      | v          | |
      |'-FILESpace-----file_space_name-+-'
>----->
      | .-,-----|
      | v          | |
      |'-HEXFILESpace-----file_space_name-+-'
>----->
      | .-,-----|
      | v          | |
      |'-UNIFILESpace-----file_space_name-+-'

```



```

>----->
|          .-,------. |
|          V              |
|'-D0mains-----domain_name-+-'
|
|.-FILEData-----None-----|. -Preview-----No-----|.
>----->
|'-FILEData-----+All-----+-'| '-Preview-----+No-----+'
|          +None-----+|          '-Yes- '|
|          +ARchive-----+
|          +Backup-----+
|          +BACKUPActive-+-
|          +ALLActive-----+
|          '-SPacemanaged-'
|
|.-Dates-----Absolute-----|.
>--DEVclass-----device_class_name----->
|          '-Dates-----+Absolute-+-'|
|          '-Relative- '|
|
|          .-,------. |
|          V              |
>--VOLumenames-----+---volume_name-+----->
|          '-FILE:--file_name-'
|
|.-Replacedefs-----No-----|.
>----->
|'-Replacedefs-----+No-----+'
|          '-Yes- '|
|
|.-MERGEfilespace-----No-----|.
>----->
|'-MERGEfilespace-----+No-----+'
|          '-Yes- '|
|
|.-PROXynodeassoc-----No-----|.
>-----<
|'-PROXynodeassoc-----+No-----+'
|          '-Yes- '|

```

## Parameters

---

### node\_name

Specifies the client nodes for which you want to import information. This parameter is optional.

Separate multiple names with commas and no intervening spaces. You can use wildcard characters to specify names. All matching nodes are included in the list.

### FILESpace

Specifies file space names for which you want to import information. This parameter is optional. The default is all file spaces.

Separate multiple names with commas and no intervening spaces. You can use wildcard characters to specify names.

#### Important:

1. Existing file spaces are not replaced. New file spaces are created when identical names are encountered. However, this new name might match an existing name on the client node, which can have file spaces that are not yet backed up to the server.
2. This parameter is only specified for non-Unicode file spaces. To import all file spaces that are both Unicode and non-Unicode, use the FILEDATA=ALL parameter without the FILESPACE and UNIFILESPACE parameters.

### DOmains

Specifies the policy domains from which to import node information. These domains must be included in the data that was exported. This parameter is optional. The default is all domains that were exported.

Separate multiple names with commas and no intervening spaces. You can use wildcard characters to specify a name.

### FILEData

Specifies the type of files that can be imported for all nodes that are specified and found on the export media. This parameter is optional. The default value is NONE.

If you are importing from sequential media, the device class that is used by the file data is determined by the device class for the storage pool. If it is the same device class that is specified in this command, two drives are needed to import the node information. The mount limit for the device class must be at least 2.

The following descriptions mention *active* and *inactive* backup file copies. An active backup file copy is the most recent backup copy for a file that still exists on the client workstation. All other backup file copies are called inactive copies. The parameter supports the following values:

ALL

The server imports all backup versions of files, all archived files, and all files that were migrated by an IBM Spectrum Protect for Space Management client. The file spaces that are included are both Unicode and non-Unicode.

None

Only node definitions are imported. The server does not import any files.

ARchive

The server imports only archived files.

Backup

The server imports only backup versions, whether active or inactive.

BACKUPActive

The server imports only active backup versions. These active backup versions are the active versions in the IBM Spectrum Protect database at the time that the IMPORT command is issued.

ALLActive

The server imports all active backup versions of files, all archived files, and all files that were migrated by an IBM Spectrum Protect for Space Management client. The active backup versions are the active versions in the IBM Spectrum Protect database at the time that the IMPORT command is issued.

SPacemanaged

The server imports only files that were migrated by an IBM Spectrum Protect for Space Management client.

Preview

Specifies whether to preview the results of the import operation, without importing information. The PREVIEW=YES option requires that you mount the export volumes. The following values are supported:

No

Specifies that the node information is to be imported.

Yes

Specifies that you want to preview the results of the import operation, without importing files. Information is reported to the server console and the activity log.

This parameter is optional. The default value is NO.

DEVclass (Required)

Specifies the device class from which import data is to be read. You cannot specify the DISK, NAS, or CENTERA device classes.

If all drives for the device class are busy when the import runs, the server cancels lower priority operations, such as identify duplicates, to make a drive available.

Dates

Specifies whether the dates for the file copies are set as the same date when the files were exported, or is adjusted to the import date.

This parameter supports the following values:

Absolute

The dates for file copies are set to the values specified when the files were exported.

Relative

The dates for file copies are adjusted to the import date.

The default value is ABSOLUTE.

If the export media is idle for some time after export, for example; if it is sitting on a shelf for six months, the original backup, or archive dates might be old enough to trigger the file copies to expire immediately when the data is imported into a server. The RELATIVE specification for this value adjusts for time that is elapsed since export so that the file copies are not immediately expired.

For example, assume that an export tape contains an archive file copy that was archived five days before the export operation. If the media is saved for six months and then imported, the archive file look like it is inserted six months and five days ago by default, the (DATES=ABSOLUTE) and might expire immediately depending on the retention value that is specified in the file's management class. Specifying DATES=RELATIVE results in resetting the archive date for the file to five days ago during import. The DATES=RELATIVE parameter thus adjusts file backup and archive dates for the time that elapsed since the export operation occurred.

#### VOLumentnames (Required)

Specifies the volumes to be used for the import operation. Volumes must be imported in the same order as they were exported. The parameter supports the following values:

##### volume\_name

Specifies the volume name. To specify multiple volumes, separate the names with commas and no intervening spaces.

##### FILE:file\_name

Specifies the name of a file that contains a list of volumes that are used for the imported data. In the file, each volume name must be on a separate line. Blank and comment lines that begin with an asterisk are ignored.

Use these naming conventions when you specify volumes that are associated with the following device types:

For this device	Specify						
Tape	1 - 6 alphanumeric characters.						
FILE	<table border="0"> <tr> <td><b>AIX</b></td> <td><b>Linux</b></td> <td>Any fully qualified file name string. An example is /imdata/mt1.</td> </tr> <tr> <td><b>Windows</b></td> <td></td> <td>Any fully qualified file name string. For example, d:\program files\tivoli\tsm\data1.dsm.</td> </tr> </table>	<b>AIX</b>	<b>Linux</b>	Any fully qualified file name string. An example is /imdata/mt1.	<b>Windows</b>		Any fully qualified file name string. For example, d:\program files\tivoli\tsm\data1.dsm.
<b>AIX</b>	<b>Linux</b>	Any fully qualified file name string. An example is /imdata/mt1.					
<b>Windows</b>		Any fully qualified file name string. For example, d:\program files\tivoli\tsm\data1.dsm.					
<b>AIX</b>   <b>Linux</b>   <b>Windows</b> REMOVABLEFILE	<b>AIX</b>   <b>Linux</b>   <b>Windows</b> 1 - 6 alphanumeric characters.						
SERVER	1 - 250 alphanumeric characters.						

#### Replacedefs

Specifies whether to replace definitions on the target server. The default value is NO. The parameter supports the following values:

##### No

Objects are not to be replaced.

##### Yes

Objects are to be replaced.

#### HEXFILESpace

Specifies the hexadecimal representation of the file space names in UTF-8 format. Separate multiple names with commas and no intervening spaces. This parameter is optional.

To view the hexadecimal representation of a file space name, you can use the QUERY FILESPACE command with FORMAT=DETAILED.

#### UNIFILESpace

Specifies that the file spaces that are known to the server are Unicode enabled. The server converts the names that you enter from the server code page to the UTF-8 code page to find the file spaces to import. The success of the conversion depends on the actual characters in the name and the server's code page. Separate multiple names with commas and no intervening spaces. A wildcard character can be used to specify a name. This parameter is optional.

#### MERGEfilespace

Specifies whether IBM Spectrum Protect merges client files into existing file spaces on the target server (if they exist), or if IBM Spectrum Protect generates new file space names. The default is NO.

Valid values are:

##### Yes

Specifies that imported data on the target server is merged with the existing file space, if a file space with the same name exists on the target server.

##### No

Specifies that IBM Spectrum Protect generates a new file space name for imported data on the target server if file spaces with the same name exists.

PROXynodeassoc

Specifies whether proxy node associations are imported. This parameter is optional. The default value is NO.

## Example: Import client node information from tapes

From the server, import client node information from tape volumes TAPE01, TAPE02, and TAPE03. Specify that these tape volumes be read by a device that is assigned to the MENU1 device class.

```
import node devclass=menu1 volumenames=tape01,tape02,tape03
```

## Example: Import client node information from tapes listed in a file

**AIX** | **Linux** From the server, import client node information from tape volumes that are listed in a file named TAPEVOL.

**Windows** From the server, import client node information from tape volumes that are listed in a file named TAPEVOL.DATA.

This file contains these lines:

```
TAPE01  
TAPE02  
TAPE03
```

Specify that these tape volumes be read by a device that is assigned to the MENU1 device class.

**AIX** | **Linux**

```
import node devclass=menu1 volumenames=file:tapevol
```

**Windows**

```
import node devclass=menu1 volumenames=file:tapevol.data
```

## Example: Import the active backup for a client node

From the server, import the active backup versions of file data for client node JOE from tape volume TAPE01. The file space is Unicode.

```
import node joe unfilepace=\\joe\c$ filedata=backupactive devclass=menu1  
volumenames=tape01
```

## Related commands

Table 1. Commands related to IMPORT NODE

Command	Description
CANCEL PROCESS	Cancels a background server process.
COPY ACTIVATEDATA	Copies active backup data.
EXPORT NODE	Copies client node information to external media or directly to another server.
IMPORT ADMIN	Restores administrative information from external media.
IMPORT POLICY	Restores policy information from external media.
IMPORT SERVER	Restores all or part of the server from external media.
QUERY ACTLOG	Displays messages from the server activity log.
QUERY PROCESS	Displays information about background processes.

## IMPORT POLICY (Import policy information)

Use this command to import policy domain information from sequential export media to the IBM Spectrum Protect™ server. IBM Spectrum Protect servers with retention protection enabled do not allow import operations.

IBM Spectrum Protect client data can be moved between servers with export and import processing, if the same removable media type is supported on both platforms.

Restriction:

1. If target and source server levels are not compatible, the import operation might not work.
2. Importing data from a CENTERA device class is not supported. However, files that are imported can be stored on a CENTERA storage device.

You can use the QUERY ACTLOG command to view the status of the import operation. You can also view this information from the server console.

This command generates a background process that can be canceled with the CANCEL PROCESS command. If an IMPORT POLICY background process is canceled, some of the data is already imported. To display information about background processes, use the QUERY PROCESS command.

Limitation: The IBM Spectrum Protect server does not convert code pages during export, import, and node replication operations. If servers are running in different locales, some information in databases or system output might become unreadable. Invalid characters might be displayed, for example, in the contact information for the administrator and client nodes, and in descriptions of policy domains. Any field that is stored in the server character set and that includes extended ASCII characters can be affected. To resolve the issue after the import or node replication operation, update the fields with the appropriate UPDATE commands. This server limitation does not affect client data. Any client data that was exported, imported, or replicated can be restored, retrieved, and recalled.

## Privilege class

---

To issue this command, you must have system privilege.

## Syntax

---

```
.-*-----
>>-IMport Policy--+----->
| .-,-----|
| V          | |
'---domain_name---+'

.-Preview----No-----
>--+-----+---DEVclass----device_class_name----->
'-Preview----+No---+'
'-Yes-'

.-,-----
V          |
>>-VOLumenames----+---volume_name-+----->
'-FILE:--file_name-'

.-Replacedefs----No-----
>--+-----+----->>
'-Replacedefs----+No---+'
'-Yes-'
```

## Parameters

---

**domain\_name**

Specifies the policy domains for which information is to be imported. Separate multiple names with commas and no intervening spaces. You can use wildcard characters to specify names. The default (\*) is all policy.

**Preview**

Specifies whether you want to preview the results of the import operation without importing information. This parameter supports the following values:

**No**

Specifies that the information is to be imported.

**Yes**

Specifies that the operation is previewed but not completed. Information is reported to the server console and the activity log.

The PREVIEW=YES option requires that you mount the export volumes. This parameter is optional. The default value is NO.  
DEVclass (Required)

Specifies the device class from which import data is to be read. You cannot specify the DISK, NAS, or CENTERA device classes.

If all drives for the device class are busy when the import runs, IBM Spectrum Protect cancels lower priority operations, such as reclamation, to make a drive available.

**VOLumentnames (Required)**

Specifies the volumes to be used for the import operation. Volumes must be imported in the same order as they were exported. This parameter supports the following values:

**volume\_name**

Specifies the volume name. To specify multiple volumes, separate the names with commas and no intervening spaces.

**FILE:file\_name**

Specifies the name of a file that contains a list of volumes. In the file, each volume name must be on a separate line. Blank and comment lines that begin with an asterisk are ignored.

Use these naming conventions when you specify volumes that are associated with the following device types:

For this device	Specify
Tape	1 - 6 alphanumeric characters.
FILE	Any fully qualified file name string. For example: <ul style="list-style-type: none"> <li><b>AIX</b>   <b>Linux</b> /imdata/mt1</li> <li><b>Windows</b> d:\program files\tivoli\tsm\data1.dsm.</li> </ul>
<b>AIX</b>   <b>Linux</b>   <b>Windows</b> REMOVABLEFILE	<b>AIX</b>   <b>Linux</b>   <b>Windows</b> 1 - 6 alphanumeric characters.
SERVER	1 - 250 alphanumeric characters.

**Replacedefs**

Specifies whether to replace policy definitions on the target server. This parameter supports the following values:

**Yes**

Specifies that objects are to be replaced by the imported objects.

**No**

Specifies that objects are not to be replaced by imported objects.

The default value is NO.

**Example: Import policy information from specific tape volumes**

From the server, import the information for all defined policies from tape volumes TAPE01, TAPE02, and TAPE03. Specify that these tape volumes be read by a device that is assigned to the MENU1 device class.

```
import policy devclass=menu1
volumenames=tape01,tape02,tape03
```

**Example: Import policy information from tape volumes listed in a file**

From the server, import the information for all defined policies from tape volumes that are listed in a file that is named thus:

- AIX** | **Linux** TAPEVOL
- TAPEVOL.DATA

Specify that these tape volumes be read by a device that is assigned to the MENU1 device class. The file contains the following lines:

```
TAPE01
TAPE02
TAPE03
```

```
AIX | Linux
import policy devclass=menu1 volumenames=file:tapevol
Windows
```

```
import policy devclass=menu1 volumenames=file:tapevol.data
```

## Related commands

Table 1. Commands related to IMPORT POLICY

Command	Description
CANCEL PROCESS	Cancels a background server process.
EXPORT POLICY	Copies policy information to external media or directly to another server.
IMPORT ADMIN	Restores administrative information from external media.
IMPORT NODE	Restores client node information from external media.
IMPORT SERVER	Restores all or part of the server from external media.
QUERY ACTLOG	Displays messages from the server activity log.
QUERY PROCESS	Displays information about background processes.

## IMPORT SERVER (Import server information)

Use this command to copy all or part of the server control information and specified client file data from export media to the IBM Spectrum Protect™ server.

**Important:** For commands that import administrators or nodes, you must consider the method of authentication. The IBM Spectrum Protect server cannot export or import passwords for nodes or administrators that are authenticating with LDAP directory servers. If the current authentication method uses an LDAP directory server and the password is not already synchronized by that server, you must update the password. After issuing the IMPORT command, set the password by issuing the UPDATE ADMIN or UPDATE NODE command.

IBM Spectrum Protect servers with retention protection enabled do not allow import operations.

Restrictions:

- If target and source server levels are not compatible, the operation might not work.
- Importing data from a CENTERA device class is not supported. However, files that are imported can be stored on a CENTERA storage device.
- If you use an LDAP directory server to authenticate passwords, any target servers must be configured for LDAP passwords. Server data that is exported from a node that authenticates with an LDAP directory server is inaccessible if the target server is not properly configured. If your target server is not configured, exported data from an LDAP node can still go there. But the target server must be configured to use LDAP in order for you to access the data.
- Incrementally exporting or importing the following types of client data to another IBM Spectrum Protect server is not supported:
  - VMware backups where full plus incremental backups need to be periodically, incrementally transferred to another server
  - Backups groups where full plus differential backups must be periodically, incrementally transferred to another server
  - Windows System State data that is periodically, incrementally transferred to another server

Full export or import of this data to a new file system on the target is supported by exporting the entire file space that contains the data. The export must not use the FILEDATA=ALLACTIVE, FROMDATE, TODATE, or MERGEFILESPPACES parameters.

Using node replication to incrementally transfer this type of client data between two servers is optimal.

You can also initiate an import of server information and client file data directly from the originating server. For more information, see the EXPORT commands.

This command generates a background process that can be canceled with the CANCEL PROCESS command. If an IMPORT SERVER background process is canceled, some of the data is already imported. To display information about background processes, use the QUERY PROCESS command.





ALL

IBM Spectrum Protect imports all backup versions of files, all archived files, and all files that were migrated by an IBM Spectrum Protect for Space Management client.

None

IBM Spectrum Protect does not import files, only node definitions.

ARchive

IBM Spectrum Protect imports only archived files.

Backup

IBM Spectrum Protect imports only backup versions, whether the versions are active or inactive.

BACKUPActive

IBM Spectrum Protect imports only active backup versions. These active backup versions are the active versions in the IBM Spectrum Protect database at the time that the IMPORT command is issued.

ALLActive

IBM Spectrum Protect imports all active backup versions of files, all archived files, and all files that were migrated by an IBM Spectrum Protect for Space Management client. The active backup versions are the active versions in the IBM Spectrum Protect database at the time that the IMPORT command is issued.

SPacemanaged

IBM Spectrum Protect imports only files that were migrated by an IBM Spectrum Protect for Space Management client.

Preview

Specifies whether to preview the results of the import operation, without importing information. This parameter supports the following values:

No

Specifies that the server information is to be imported.

Yes

Specifies that the operation is previewed but not completed. Information is transferred to the server console and the activity log.

This parameter is optional. The default value is NO. If the PREVIEW=YES option is specified, you must mount the export volumes.

DEVclass (Required)

Specifies the device class from which import data is to be read. You cannot specify the DISK, NAS, or CENTERA device classes.

If all drives for the device class are busy when the import runs, IBM Spectrum Protect cancels lower priority operations, such as reclamation, to make a drive available.

Dates

Specifies whether the dates for the file copies are set as the same date when the files were exported, or is adjusted to the import date.

If the import media is idle for some time after export, for example; if it is sitting on a shelf for six months, the original backup, or archive dates might be old enough to trigger the file copies to expire immediately when the data is imported into a server. The RELATIVE specification for this value adjusts for time that is elapsed since export so that the file copies are not immediately expired.

For example, assume that an import tape contains an archive file copy that was archived five days before the export operation. If the export media are saved for six months and then imported, the archive file looks like it is inserted six months and five days ago by default (DATES=ABSOLUTE) and might expire immediately depending upon the retention value that is specified in the file's management class. Specifying DATES=RELATIVE results in resetting the archive date for the file to five days ago during import. DATES=RELATIVE parameter thus adjusts file backup and archive dates for the time that elapsed since the export operation occurred.

This parameter supports the following values:

Absolute

The dates for file copies are set to the values specified when the files were exported.

Relative

The date for file copies are adjusted to the date of import.

The default value is ABSOLUTE.

VOLumentnames (Required)

Specifies the volumes to be used for the import operation. Volumes must be imported in the same order as they were exported. This parameter supports the following values:

volume\_name

Specifies the volume name. To specify multiple volumes, separate the names with commas and no intervening spaces.

FILE:file\_name

Specifies the name of a file that contains a list of volumes that are used for the imported data. In the file, each volume name must be on a separate line. Blank and comment lines that begin with an asterisk are ignored.

Use these naming conventions when you specify volumes that are associated with the following device types:

For this device	Specify
Tape	1 - 6 alphanumeric characters.
FILE	<p><b>AIX</b>   <b>Linux</b> Any fully qualified volume or file name string. An example is /imdata/mt1.</p> <p><b>Windows</b> Any fully qualified volume or file name string. For example, d:\program files\tivoli\tsm\data1.dsm.</p>
<b>AIX</b>   <b>Linux</b>   <b>Windows</b> REMOVABLEFILE	<b>AIX</b>   <b>Linux</b>   <b>Windows</b> 1 - 6 alphanumeric characters.
SERVER	1 - 250 alphanumeric characters.

Replacedefs

Specifies whether to replace objects on the server. Existing file spaces are not replaced. New file spaces are created when identical names are encountered. This parameter supports the following values:

No

Specifies that objects are not to be replaced by imported objects.

Yes

Specifies that objects are to be replaced by the imported objects.

The default value is NO.

MERGEfilespaces

Specifies whether IBM Spectrum Protect merges client files into existing file spaces on the target server (if they exist), or if IBM Spectrum Protect generates new file space names. You cannot merge non-Unicode and Unicode file spaces together.

This parameter supports the following values:

No

Specifies that IBM Spectrum Protect generates a new file space name for imported data on the target server if file spaces with the same name exist.

Yes

Specifies that imported data on the target server is merged with the existing file space, if a file space with the same name exists on the target server.

The default is NO.

PROXynodeassoc

Specifies whether proxy node associations are imported. This parameter is optional. The default value is NO.

## Example: Import the information for all defined servers from specific tapes

From the server, import the information for all defined servers from tape volumes TAPE01, TAPE02, and TAPE03. Specify that these tape volumes be read by a device that is assigned to the MENU1 device class.

```
import server devclass=menu1 volumenames=tape01,tape02,tape03
```

**AIX** | **Linux**

## Example: Import information for all defined servers from specific tapes and specify files are merged into existing file spaces

From the server, import the information for all defined servers from tape volumes TAPE01, TAPE02, and TAPE03. Specify that these tape volumes be read by a device that is assigned to the MENU1 device class and that client files be merged into file spaces on the target server if file spaces of the same names exist.

```
import server devclass=menu1 volumenames=tape01,tape02,tape03 mergefilespace=yes
```

## Example: Import information for all defined servers from tapes listed in a file

From the server, import the information for all defined servers from tape volumes that are listed in a file named TAPEVOL. Specify that the tape volumes are read by a device that is assigned to the MENU1 device class. The input file contains these lines:

```
TAPE01  
TAPE02  
TAPE03
```

```
import server devclass=menu1 volumenames=file:tapevol
```

Windows

## Example: Import information for all defined servers from tapes listed in a file

From the server, import the information for all defined servers from tape volumes that are listed in a file named TAPEVOL.DATA. Specify that the tape volumes are read by a device that is assigned to the MENU1 device class. The input file contains these lines:

```
TAPE01  
TAPE02  
TAPE03
```

```
import server devclass=menu1 volumenames=file:tapevol.data
```

## Related commands

Table 1. Commands related to IMPORT SERVER

Command	Description
CANCEL PROCESS	Cancels a background server process.
COPY ACTIVATEDATA	Copies active backup data.
EXPORT SERVER	Copies all or part of the server to external media or directly to another server.
IMPORT ADMIN	Restores administrative information from external media.
IMPORT NODE	Restores client node information from external media.
IMPORT POLICY	Restores policy information from external media.
QUERY ACTLOG	Displays messages from the server activity log.
QUERY PROCESS	Displays information about background processes.

## INSERT MACHINE (Insert machine characteristics information or recovery instructions)

Use this command to add client machine characteristics or recovery instructions to existing machine information in the database.

You can write a program to read files containing the information and generate the appropriate INSERT MACHINE commands.

You can use QUERY commands to retrieve the information if a disaster occurs.

## Privilege class

To issue this command, you must have system privilege.

## Syntax

```
>>-INsert MACHine--machine_name--sequence_number----->
```

```
>--+CCharacteristics--===text-----+-----><
```

```
'-RECOVERYInstructions---text-'
```

## Parameters

---

machine\_name (Required)

Specifies the name of the client machine.

sequence\_number (Required)

Specifies the sequence number for the line of text in the database.

Characteristics

Specifies machine characteristics information. You must specify the characteristics or recovery instructions, but not both.

Enclose the text in quotation marks if it contains blank characters. The text can be up to 1024 characters.

RECOVERYInstructions

Specifies recovery instructions. You must specify the characteristics or recovery instructions, but not both. Enclose the text in quotation marks if it contains blank characters. The text can be up to 1024 characters.

## Example: Update a machine's information

---

For the machine DISTRICT5, insert this characteristics text on line 1: "Machine owner is Mary Smith".

```
insert machine district5 1
characteristics="Machine owner is Mary Smith"
```

## Related commands

---

Table 1. Commands related to INSERT MACHINE

Command	Description
DEFINE MACHINE	Defines a machine for DRM.
DELETE MACHINE	Deletes a machine.
QUERY MACHINE	Displays information about machines.

### Related information:

[🔗 Specifying information about your server and client node machines](#)

## ISSUE MESSAGE (Issue a message from a server script)

---

Use this command with return code processing in a script to issue a message from a server script to determine where the problem is with a command in the script.

## Privilege class

---

Any administrator can issue this command.

## Syntax

---

```
>>-ISSUE MESSAGE--message_severity--message_text-----><
```

## Parameters

---

message\_severity (Required)

Specifies the severity of the message. The message severity indicators are:

- I Information. ANR1496I is displayed in the message text.
- W Warning. ANR1497W is displayed in the message text.
- E Error. ANR1498E is displayed in the message text.
- S

Severe. ANR1499S is displayed in the message text.

message\_text (Required)

Specifies the description of the message.

## Example: Issue a message from a server script

Assume you have a script called `backupscrip` that quiesces a client's database, takes a backup of that database, and then restarts the client's database. For illustration, your script results in a non-zero return code. Use the `ISSUE MESSAGE` command with the message severity and message text. The following is an example of a server script that calls `backupscrip` on the client machine and issues messages based on the return code from `backupscrip`.

```
issue message i "Starting backup"
define clientaction nodename action=command objects="c:\backupscrip" wait=yes
if (101) goto qfail
if (102) goto qwarn
if (103) goto backupf
if (104) goto restartf
issue message i "Backup of database complete"
exit
qfail: issue message e "Quiesce of database failed"
exit
qwarn: issue message w "Quiesce of database failed, taking fuzzy backup"

exit
backupf: issue message e "Backup of database failed"
exit
restartf: issue message s "Database restart failed"
exit
```

Command

```
issue message e "quiesce of database failed"
```

## Related commands

Table 1. Commands related to `ISSUE MESSAGE`



Command	Description
<code>COPY SCRIPT</code>	Creates a copy of a script.
<code>DEFINE SCRIPT</code>	Defines a script to the IBM Spectrum Protect server.
<code>DELETE SCRIPT</code>	Deletes the script or individual lines from the script.
<code>RENAME SCRIPT</code>	Renames a script to a new name.
<code>RUN</code>	Runs a script.
<code>UPDATE SCRIPT</code>	Changes or adds lines to a script.

## LABEL LIBVOLUME (Label a library volume)

Use this command to label tape volumes or, in an automated library, to label the volumes automatically as they are checked in. With this command, the server uses the full-length label with which the volumes are often pre-labeled.

Restriction: Use this command only for `MANUAL`, `SCSI`, `ACSLs`, and `349X` libraries. The command processing does not wait for a drive to become available, even if the drive is only in the `IDLE` state. If necessary, you can make a library drive available by issuing the `DISMOUNT VOLUME` command to dismount the volume in that particular drive. When the library drive becomes available, you can reissue the `LABEL LIBVOLUME` command.

For detailed and current drive and library support information, see the Supported Devices website for your operating system:

-  Supported devices for AIX and Windows
-  Supported devices for Linux



To use the `LABEL LIBVOLUME` command, at least one drive must exist that is not in use by another IBM Spectrum Protect™ process. This includes idle volumes that are mounted. If necessary, use the `DISMOUNT VOLUME` command to dismount the idle

volume to make that drive available.

By default, the LABEL LIBVOLUME command does not overwrite an existing label. However, if you want to overwrite an existing label, you can specify the `OVERWRITE=YES` option.

Attention:

- By overwriting a volume label, you destroy all data on the volume. Use caution when you overwrite volume labels to avoid deleting valid data.
- The labels on VolSafe volumes can be overwritten only once. Therefore, use the LABEL LIBVOLUME command only once for VolSafe volumes. You can guard against overwriting the label by using the `OVERWRITE=NO` option with the LABEL LIBVOLUME command.

When you use the LABEL LIBVOLUME command, you can identify the volumes to be labeled in one of the following ways:

- Explicitly name one volume.
- Enter a range of volumes by using the VOLRANGE parameter.
- Use the VOLLIST parameter to specify a file that contains a list of volume names or to explicitly name one or more volumes.

For automated libraries, you are prompted to insert the volume in the entry/exit slot of the library. If no I/O convenience station is available, insert the volume into an empty slot. For manual libraries, you are prompted to load the volume directly into a drive.

Tip: To automatically label tape volumes, you can use the AUTOLABEL parameter on the DEFINE LIBRARY and UPDATE LIBRARY commands. By using the AUTOLABEL parameter, you eliminate the need to pre-label a set of tapes. This method is more efficient than using the LABEL LIBVOLUME command, which requires you to mount volumes separately. If you use the AUTOLABEL parameter with a SCSI library, you must check in tapes by specifying `CHECKLABEL=BARCODE` on the CHECKIN LIBVOLUME command. The AUTOLABEL parameter defaults to YES for all non-SCSI libraries and to NO for SCSI libraries.

Windows

To label volumes with the LABEL LIBVOLUME command, specify the CHECKIN parameter.

To automatically label tape volumes in SCSI-type libraries, use the AUTOLABEL parameter on the DEFINE LIBRARY and UPDATE LIBRARY commands. By using this parameter, you eliminate the need to pre-label a set of tapes. This method is also more efficient than using the LABEL LIBVOLUME command, which requires you to mount volumes separately. If you use the AUTOLABEL parameter, you must check in tapes by specifying `CHECKLABEL=BARCODE` on the CHECKIN LIBVOLUME command.

A label cannot include embedded blanks or periods and must be valid when used as a file name on the media.

You must label CD-ROM, Zip, or Jaz volumes with the device utilities from the manufacturer or the Windows utilities. IBM Spectrum Protect does not provide utilities to format or label these media types. The operating system utilities include the Disk Administrator program (a graphical user interface) and the label command.

## Privilege class

---

To issue this command, you must have system privilege or unrestricted storage privilege.

## Syntax for a manual library

---

```
>>-LABEL LIBVolume--library_name-----volume_name----->
. -OVERWRITE-----No----- . -WAITTime-----60----.
>--+-----+-----+-----><
'-OVERWRITE-----+No--+-' '-WAITTime-----value-'
      '-Yes-'
```

## Syntax for a SCSI library

---

```
>>-LABEL LIBVolume--library_name----->
>-----+volume_name-----+----->
'-SEARCH-----+Yes--| A |---+LABELSource-----+Barcode-----+-'
      '-Bulk--| A |-'           +-Prompt-----+
      '-Vollist--| B |-'
```

```

                                .-OVERWRITE----No-----
>--+-----+-----+-----+-----+----->
  '-CHECKIN----+SCRatch+-'  '-OVERWRITE----+No--+-'
        '-PRivate-'                '-Yes-'

    .-WAITTime----60----.
>--+-----+-----+-----+-----+----->>
  '-WAITTime----value-'

A (SEARCH=Yes, SEARCH=Bulk)

|--+VOLRange----volume_name1,volume_name2--+-----|
|          .-,-----|.          |
|          V          |          |
  '-VOLList----+---volume_name+---+-----|
        '-FILE:--file_name-'

B (LABELSource=Vollist)

    .-,-----|.
    V          |
|--VOLList----+---volume_name+---+-----|
        '-FILE:--file_name-'

```

## Syntax for a 349X library

---

```

>>-LABEL LIBVolume--library_name----->
>----+volume_name-----+----->
  '-SEARCH----Yes----| A |---'

                                .-OVERWRITE----No-----
>--+-----+-----+-----+-----+----->
  '-CHECKIN----+SCRatch+-'  '-OVERWRITE----+No--+-'
        '-PRivate-'                '-Yes-'

    .-WAITTime----60----.
>--+-----+-----+-----+-----+----->>
  '-WAITTime----value-'

A (SEARCH=Yes)

|--+VOLRange----volume_name1,volume_name2--+-----|
|          .-,-----|.          |
|          V          |          |
  '-VOLList----+---volume_name+---+-----|
        '-FILE:--file_name-'

```

## Syntax for an ACSLS library

---

```

>>-LABEL LIBVolume--library_name----->
>----+volume_name-----+----->
  '-SEARCH----Yes----| A |---'

                                .-OVERWRITE----No-----
>--+-----+-----+-----+-----+----->
  '-CHECKIN----+SCRatch+-'  '-OVERWRITE----+No--+-'
        '-PRivate-'                '-Yes-'

    .-WAITTime----60----.
>--+-----+-----+-----+-----+----->>
  '-WAITTime----value-'

A (SEARCH=Yes)

|--+VOLRange----volume_name1,volume_name2--+-----|
|          .-,-----|.          |
|          V          |          |

```

```
'-VOLList---+---+---volume_name+---+-----'  
      '-FILE:--file_name-'
```

## Parameters

---

### library\_name (Required)

Specifies the name of the library that contains the storage volume.

### volume\_name

Specifies the name of the volume to be labeled.

- For SCSI libraries: The server requests that the volume is inserted into a slot in the library or, if available, into an entry/exit port. The server identifies a slot by the slot's element address. If you are labeling a volume in a SCSI library with multiple entry/exit ports, the volume in the lowest numbered slot is labeled.  
Warning: If you specify a volume name, the name you specify overrides the label that is printed on the cartridge.
- For MANUAL libraries: The server requests that the volume is inserted into a drive.
- For 349X libraries: The volume might already be in the library, or you might be prompted to put it into the I/O station.

Remember: If the specified volume name is already defined in a storage pool or in a volume history file, the volume is not labeled, and a message is displayed.

### CHECKIN

Specifies whether the server checks in the volume. This parameter is optional. The following are possible values:

#### SCRatch

Specifies that the server checks in the volumes and adds them to the library's scratch pool. If a volume has an entry in volume history, you cannot check it in as a scratch volume.

#### PRIVate

Specifies that the server checks in the volumes and designates them as private. Private volumes are available only when you request them by name.

If you do not specify a value for this parameter, the command labels the volume, but does not check it in. If you do not specify a value for this parameter and you want to check in the volume, you must issue the CHECKIN LIBVOLUME command.

### SEARCH

Specifies that the server searches the library for usable volumes to label. This parameter applies to SCSI, 349X, and ACSLS libraries.

The following values are valid:

#### Yes

Specifies that the server labels only volumes that are stored in the library, unless the volume is already labeled or its bar code cannot be read.

If you specify the LABELSOURCE=PROMPT option, the volume is moved into the drive from its location in the library or entry and exit ports. The server prompts you to issue the REPLY command that contains the label string, and that label is written to the tape.

#### Bulk

Specifies that the server searches the library entry/exit ports for usable volumes to label. This option is only valid for SCSI libraries.

If you specify LABELSOURCE=BARCODE, the volume bar code is read. Then, the tape is moved from its location in the library or in the entry/exit ports to a drive where the bar code label is written. After the tape is labeled, it is moved back to its location in the library, to the entry/exit ports, or to a storage slot if the CHECKIN option is specified. For bar code support to work correctly for libraries that are supported by IBM Spectrum Protect, the IBM Spectrum Protect server and the device driver must be at the same level. Bar code support is available for libraries that are supported by IBM Spectrum Protect and that use the IBM Spectrum Protect device driver or the IBM® Magstar® or LTO Ultrium device driver.

Tip: You can use the VOLRANGE or VOLLIST parameter to limit the search.

### VOLRange

Specifies a range of volume names that are separated by a comma. Use this parameter to limit the search for volumes to be labeled when you specify SEARCH=YES (349X, ACSLS, and SCSI libraries) or SEARCH=BULK (SCSI libraries only). If there are no volumes in the library that are within the specified range, the command completes without errors.



You can specify only volume names that can be numerically incremented. In addition to the incremental area, a volume name can include an alphanumeric prefix and an alphanumeric suffix, for example:

Parameter	Description
<code>volrange=bar110,bar130</code>	The 21 volumes are labeled: bar110, bar111, bar112,...bar129, bar130.
<code>volrange=bar11a,bar13a</code>	The 3 volumes are labeled: bar11a, bar12a, bar13a.
<code>volrange=123400,123410</code>	The 11 volumes are labeled: 123400, 123401, ...123409, 123410.

#### VOLLIST

Specifies a list of volumes. Use this parameter to limit the search for volumes to be labeled when you specify `SEARCH=YES` (349X, ACSLS, and SCSI libraries) or `SEARCH=BULK` (SCSI libraries only). If there are no volumes in the library that are in the list, the command completes without errors. The `VOLLIST` parameter can also be the source of names to be used to label volumes if the `LABELSOURCE` parameter is set to `VOLLIST`. If `LABELSOURCE=VOLLIST`, you must specify the `VOLLIST` parameter.

The following values are valid:

##### volume\_name

Specifies the names of one or more values that are used for the command. For example: `VOLLIST=TAPE01,TAPE02`.

##### FILE:file\_name

Specifies the name of a file that contains a list of volumes for the command. In the file, each volume name must be on a separate line. Blank lines and comment lines that begin with an asterisk are ignored. For example, to use volume `TAPE01`, `TAPE02` and `TAPE03`, create a file that is named `TAPEVOL` that contains these lines:

```
TAPE01
TAPE02
TAPE03
```

You can specify the volumes for the command as follows: `VOLLIST=FILE:TAPEVOL`.

Remember: The file name is case-sensitive.

#### LABELSOURCE

Specifies how or whether the server reads sequential media labels of volumes. This option is only valid for SCSI libraries. Specify this parameter only when `SEARCH=YES` or `SEARCH=BULK`.

You can specify the following values:

##### Prompt

The server prompts for volume names as necessary.

##### Barcode

The server attempts to read the bar code label. If the attempt fails, the server does not label the volume and displays a message.

Important: For bar code support to work properly, the appropriate device drivers must be installed for the libraries.

##### Vollist

This option applies only to SCSI libraries. The server attempts to read the specified file or list of files. If the attempt fails, the server does not label the volumes and displays a message.

#### OVERWRITE

Specifies whether the server attempts to overwrite existing labels. This parameter is optional. The default is `NO`. You can specify the following values:

##### No

Specifies that the server labels only unlabeled volumes. For StorageTek VolSafe volumes, the value must be `NO`.

##### Yes

Specifies that the server overwrites existing labels only if both the existing label and the prompted or bar code label are not already defined in either the server storage pool or volume history list.

#### WAITTime

Specifies the number of minutes that the server waits for you to reply or respond to a request. Specify a value in the range 0-9999. If you want to be prompted by the server, specify a wait time greater than zero. The default value is 60 minutes. For example, suppose that the server prompts you to insert a tape into the entry/exit port of a library. If you specified a wait time of 60 minutes, the server issues a request and wait 60 minutes for you to reply. Alternatively, suppose that you specify

a wait time of 0. If you inserted a tape, a wait time of zero causes the operation to continue without prompting. If you did not insert a tape, a wait time of zero causes the operation to fail.

## Example: Automatically label library volumes

Label tapes in a SCSI library named `AUTO` automatically as you are checking in the volumes.

```
label libvolume auto checkin=scratch search=yes labelsource=barcode
overwrite=yes
```

## Example: Label sequential library volumes

Label 3 volumes from `bar11a` to `bar13a` in a SCSI library named `ABC`. When you issue the following command, the three volumes are labeled: `bar11a`, `bar12a`, `bar13a`.

```
label libvolume abc checkin=scratch search=yes volrange=bar11a,bar13a
labelsource=barcode
```

## Related commands

Table 1. Commands related to LABEL LIBVOLUME

Command	Description
AUDIT LIBRARY	Ensures that an automated library is in a consistent state.
CANCEL PROCESS	Cancels a background server process.
CHECKIN LIBVOLUME	Checks a storage volume into an automated library.
CHECKOUT LIBVOLUME	Checks a storage volume out of an automated library.
DEFINE LIBRARY	Defines an automated or manual library.
DEFINE VOLUME	Assigns a volume to be used for storage within a specified storage pool.
QUERY LIBRARY	Displays information about one or more libraries.
QUERY LIBVOLUME	Displays information about a library volume.
QUERY PROCESS	Displays information about background processes.
REPLY	Allows a request to continue processing.
UPDATE LIBVOLUME	Changes the status of a storage volume.

## LOAD DEFALERTTRIGGERS (Load the default set of alert triggers)

Use this command to load the default set of alert triggers to the IBM Spectrum Protect™ server.

For a newly installed server, a default set of messages is defined to trigger alerts. You can modify or delete default alert triggers. Use this command to complete the following tasks:

- Load the default set of alert triggers, restoring any that were deleted.
- Replace all alert triggers with the original default set.

By default, this command does not delete other alert triggers that were created, and does not replace default alert triggers that were modified. To delete all alert triggers and restore the original set of default alert triggers, specify `RESET=yes`.

## Privilege class

To issue this command, you must have system privilege.

## Syntax

```
.-REset----No-----
>>-L0ad DEFALerttriggers--+-----+-----<<
```

```
'-REset-----No---'  
'-Yes-'
```

## Parameters

---

### REset

Specifies whether you want to replace all of your alert triggers with the default set of alert triggers. This parameter is optional. The default value is No. Possible values are:

### No

Specifies that the default alert triggers are added only. The original default alert triggers are added to the server. Existing triggers are not deleted. If a default trigger exists on the server, it is not replaced or modified.

### Yes

Specifies that the alert triggers are restored to the original defaults. All alert triggers are deleted and then the original set of default alert triggers are added.

## Example: Load the default alert triggers on the server

---

Load the default triggers to restore any that were deleted. Issue the command:

```
load defalertriggers
```

## Example: Replace all alert triggers on the server with the default alert triggers

---

Delete all alert triggers on the server and replace them with the original defaults. Issue the command:

```
load defalertriggers reset=yes
```

## Related commands

---

Table 1. Commands related to LOAD DEFALERTTRIGGERS

Command	Description
DEFINE ALERTTRIGGER (Define an alert trigger)	Associates specified messages to an alert trigger.
DELETE ALERTTRIGGER (Remove a message from an alert trigger)	Removes a message number that can trigger an alert.
QUERY ALERTTRIGGER (Query the list of defined alert triggers)	Displays message numbers that trigger an alert.
UPDATE ALERTTRIGGER (Update a defined alert trigger)	Updates the attributes of one or more alert triggers.

## LOCK commands

---

Use the LOCK command to prevent users from accessing the server.

- LOCK ADMIN (Lock out an administrator)
- LOCK NODE (Lock out a client node)
- LOCK PROFILE (Lock a profile)

## LOCK ADMIN (Lock out an administrator)

---

Use this command to prevent an administrator from accessing the server. The administrator is locked out until a system administrator uses the UNLOCK ADMIN command to reestablish access for the administrator.

You can use the authentication filter to lock all administrators, excluding console administrators. After configuring an LDAP directory server for password authentication, you can lock administrators to force them to create passwords that authenticate with an LDAP server.

## Privilege class

---

To issue this command, you must have system privilege.

## Syntax

---

```
>>-LOCK Admin--+-*-----+-----+-----+-----+><
                '-admin_name-' '-AUTHentication-----+LOcal-+-'
                                     '-LDap--'
```

## Parameters

---

### admin\_name (Required)

Specifies the name of the administrator to be locked out. You can use wildcard characters to specify the administrator name. You do not have to enter an administrator name if you want to lock all of the administrators according to their authentication method. Use the wildcard with an authentication method to lock multiple administrators.

### AUTHentication

Specifies the method of authentication that the administrator uses to log in.

### LOcal

Specifies to lock administrators who authenticate to the IBM Spectrum Protect™ server.

### LDap

Specifies to lock administrators who authenticate to the LDAP directory server.

## Example: Lock out an administrator

---

Lock out the administrator CLAUDIA. Issue the command:

```
lock admin claudia
```

## Example: Lock out all administrators who authenticate to the IBM Spectrum Protect server database

---

Use the wildcard character (\*) to lock all the administrators who authenticate their passwords locally. Console administrators are not affected by this command. Issue the following command:

```
lock admin * authentication=local
```

## Related commands

---

Table 1. Commands related to LOCK ADMIN

Command	Description
QUERY ADMIN	Displays information about one or more IBM Spectrum Protect administrators.
UNLOCK ADMIN	Enables a locked administrator to access IBM Spectrum Protect.

## LOCK NODE (Lock out a client node)

---

Use this command to prevent a client node from accessing the server. A locked client node cannot perform any IBM Spectrum Protect™ operations, even if the operations are scheduled.

After configuring an LDAP directory server for password authentication, you can lock nodes to force them to use passwords that authenticate with an LDAP server.

## Privilege class

---

To issue this command, you must have system privilege, unrestricted policy privilege, or restricted policy privilege for the policy domain to which the client node belongs.

## Syntax

---



## Parameters

profile\_name (Required)

Specifies the profile to lock. You can use wildcard characters to indicate multiple names.

minutes

Specifies the time, in minutes, before IBM Spectrum Protect™ unlocks the configuration profile. Specify an integer from 0 to 10000. The default is 60 minutes. If you specify 0, the configuration profile will not unlock automatically. Use the UNLOCK PROFILE command to unlock the profile before the time period elapses, or to unlock it if you have specified a value of 0.

This parameter is optional.

## Example: Lock a profile for a specific amount of time

Lock a profile named DELTA for 30 minutes.

```
lock profile delta 30
```

## Related commands

Table 1. Commands related to LOCK PROFILE

Command	Description
COPY PROFILE	Creates a copy of a profile.
DEFINE PROFASSOCIATION	Associates objects with a profile.
DEFINE PROFILE	Defines a profile for distributing information to managed servers.
DELETE PROFASSOCIATION	Deletes the association of an object with a profile.
DELETE PROFILE	Deletes a profile from a configuration manager.
QUERY PROFILE	Displays information about configuration profiles.
SET CONFIGMANAGER	Specifies whether a server is a configuration manager.
UNLOCK PROFILE	Enables a locked profile to be distributed to managed servers.
UPDATE PROFILE	Changes the description of a profile.

## MACRO (Invoke a macro)

Use this command to invoke a file from the administrative command line that contains one or more IBM Spectrum Protect™ administrative commands to be performed.

Restriction: Use this command with administrative command-line clients only.

A macro is a file that contains one or more IBM Spectrum Protect administrative commands. You can only issue a macro from the administrative client in batch or interactive mode. A macro is stored as a file on the administrative client machine (or system).

Macros are not distributed across servers and cannot be scheduled on the server.

Creating a macro to enter commands can be helpful when you want to issue commands that are used repeatedly, to issue commands that contain several parameters, or to process related commands in a specific order. After you create a macro, you can update the information it contains and use it again, or you can copy the macro file, make changes to the copy, and then run the copy.

## Privilege class

Any administrator can issue this command.

## Syntax

```
>>-MACRO--macro_name--+-----+-----<<
      | .----- . |
      | v           | |
```

'---substitution\_value---'

## Parameters

macro\_name (Required)

Specifies the name of the macro.

substitution\_value

Specifies the value for a substitution variable in a macro. When you use a substitution variable, you can reuse a macro whenever you need to perform the same task for different objects or with different parameter values. To specify a value that contains blanks, you must enclose the value in quotation marks. This parameter is optional.

## Example: Create a macro to register a new administrator

Create a macro file named REGNG. Use the macro to register and grant authority to a new administrator. Write the macro as follows:

```
/* Register and grant authority to a new administrator */
REGister Admin jones passwd -
CONtactinfo="x1235"
GRant AUTHority jones -
CLasses=Policy
```

Issue the following command to run the macro:

```
macro regng.mac
```

## Example: Write a macro using substitution variables

Create a macro file named AUTHRG, containing substitution variables, to register and grant authority to a new administrator. Write the macro as follows:

```
/* Register and grant authority to a new administrator */
REGister Admin %1 %2 - /* Enter userid and password */
CONtact=%3 /* Enter contact info (in quotes if nec.) */
GRant AUTHority %1 - /* Server uses variable already */
- /* defined by you */
CLasses=%4 /* Enter the privilege class */
```

Issue a command similar to the following, entering the values you want to pass to the server to process the command when you run the macro.

```
macro authrg.mac jones passwd x1235 Policy
```

## Related commands

Table 1. Commands related to MACRO

Command	Description
COMMIT	Makes changes to the database permanent.
ROLLBACK	Discards any uncommitted changes to the database since the last COMMIT was executed.

### Related concepts:

Administrative client macros

## MIGRATE STGPOOL (Migrate storage pool to next storage pool)

Use this command to migrate files from one storage pool to the next storage pool in the storage hierarchy.

This command can only be used with primary storage pools. The storage pool data format cannot be NETAPPDUMP, CELERRADUMP, or NDMPDUMP. Data cannot be migrated into or out of storage pools that are defined with a CENTERA device class.

Only one migration or reclamation process for a given storage pool is allowed at any given time. If a migration or reclamation process is already running for the storage pool, you cannot start another migration process for the storage pool.

You should only use this command if you are not going to use automatic migration for the storage pool. To prevent automatic migration from running, set the HIGHMIG attribute of the storage pool definition to 100.

If you use this command to start a migration process, but the storage pool does not have a next storage pool identified in the hierarchy, a reclamation process is triggered for the source storage pool. To prevent the reclamation process, define the next storage pool in the hierarchy. Then, start the migration process.

The MIGRATE STGPOOL command honors the values of the following parameters on the DEFINE STGPOOL and UPDATE STGPOOL commands:

- MIGPROCESS
- MIGDELAY
- MIGCONTINUE
- NEXTPOOL
- LOWMIG

Tip: You can override the value of the LOWMIG parameter on DEFINE STGPOOL and UPDATE STGPOOL by specifying a value for the LOWMIG parameter on the MIGRATE STGPOOL command.

The MIGRATE STGPOOL command ignores the value of the HIGHMIG parameter of the storage pool definition. Migration occurs regardless of the value of the HIGHMIG parameter.

This command creates one or more migration processes that can be canceled with the CANCEL PROCESS command. The number of processes is limited by the MIGPROCESS attribute of the storage pool definition. To display information about background processes, use the QUERY PROCESS command.

Remember: Migrating data from a primary storage pool that is set up for data deduplication to another primary storage pool that is also set up for data deduplication removes duplicate data.

## Privilege class

---

To issue this command, you must have system privilege, unrestricted storage privilege, or restricted storage privilege for both the storage pool from which the files are to be migrated and the next storage pool to which files are to be migrated.

## Syntax

---

```
>>-MIGrate STGpool--pool_name--+-----+----->
                                   '-LOwmig---number-'
                                   .-REclaim---No-----
>--+-----+-----+-----+----->
  '-DUration---minutes-'  '-REclaim---No---'
                                   '-Yes-'

  .-Wait---No-----
>--+-----+-----><
  '-Wait---No---'
                                   '-Yes-'
```

## Parameters

---

pool\_name (Required)

Specifies the primary storage pool from which files are to be migrated.

DUration

Specifies the maximum number of minutes the migration runs before being automatically canceled. When the specified number of minutes elapses, the server will automatically cancel all migration processes for this storage pool. As soon as the processes recognize the automatic cancellation, they end. As a result, the migration might run longer than the value you specified for this parameter. You can specify a number from 1 to 9999. This parameter is optional. If not specified, the server will stop only after the low migration threshold is reached.

LOwmig

For random-access and sequential-access disk storage pools, specifies that migration should stop when the amount of data in the pool is at or below this percentage of the pool's estimated capacity. This parameter is optional.



The calculation for sequential-access disk storage pools includes the capacity of all the scratch volumes that are specified for the pool. Because migration is by node or filespace, depending upon collocation, the occupancy of the storage pool can fall below the value that you specified for this parameter. To empty the storage pool, set LOWMIG=0. For other types of sequential-access storage pools, the server stops migration when the ratio of volumes containing data to the total number of volumes in the storage pool is at or below this percentage. The total number of volumes includes the maximum number of scratch volumes. You can specify a number from 0 to 99 for this optional parameter. The default value is the LOWMIG attribute of the storage pool definition.

#### RECLAIM

Specifies whether reclamation is attempted for the storage pool before completing the migration. This parameter can only be specified for a sequential-access storage pool. This parameter is optional. The default is No. Possible values are:

No

Specifies that the server will not attempt a reclamation before starting the migration.

Yes

Specifies that the server will attempt reclamation before starting the migration. Any volumes in the storage pool that meet the reclamation threshold as specified by the RECLAIM attribute of the storage pool definition will be reclaimed before completing the migration. If no volumes meet the reclamation threshold or if, after reclamation, the LOWMIG threshold has not been reached, the server will begin the migration. Before reclaiming space for storage pools defined with RECLAMATIONTYPE=SNAPLOCK, the server deletes all empty WORM FILE volumes during reclamation processing that have exceeded their reclaim period.

#### WAIT

Specifies whether to wait for the server to complete processing this command in the foreground. This parameter is optional. This default is No. Possible values are:

No

Specifies that the server processes this command in the background.

You can continue with other tasks while the command is being processed. Messages that are created from the background process are displayed either in the activity log or the server console, depending on where messages are logged.

To cancel a background process, use the CANCEL PROCESS command. If you cancel this process, some files may have already been migrated before the cancellation.

Yes

Specifies that the server processes this command in the foreground. The operation must complete before you can continue with other tasks. The server then displays the output messages to the administrative client when the operation completes. Messages are also displayed either in the activity log or the server console, or both, depending on where the messages are logged.

Note: You cannot specify WAIT=YES from the server console.

## Example: Migrate a storage pool to the next storage pool

Migrate data from the storage pool named BACKUPPOOL to the next storage pool. Specify that the server should end the migration as soon as possible after 90 minutes.

```
migrate stgpool backuppool duration=90
```

## Related commands

Table 1. Commands related to MIGRATE STGPOOL

Command	Description
CANCEL PROCESS	Cancels a background server process.
QUERY PROCESS	Displays information about background process.
QUERY STGPOOL	Displays information about storage pools.
RECLAIM STGPOOL	Performs reclamation for the storage pool.

#### Related information:

[Migrating files in a storage pool hierarchy](#)

## MOVE commands

---

Use the MOVE commands to either transfer backup or archive data between storage pools, or to move disaster recovery media on and off site.

- MOVE CONTAINER (Move a container)
- MOVE DATA (Move files on a storage pool volume)
- MOVE DRMEDIA (Move disaster recovery media offsite and back onsite)
- MOVE GRPMEMBER (Move a server group member)
- MOVE MEDIA (Move sequential-access storage pool media)
- MOVE NODEDATA (Move data by node in a sequential access storage pool)

AIX

Linux

Windows

## MOVE CONTAINER (Move a container)

---

Use this command to move the contents of a storage pool container to another container if a storage pool directory is removed or if a container is damaged.

You can also use this command to move the contents of a storage pool container under these conditions:

- When you upgrade hardware
- If I/O errors occur on a disk

## Privilege class

---

To issue this command, you must have restricted storage privilege.

## Syntax

---

```
>>-MOVE CONTainer--container_name----->
>--+-----+----->
  '-STGPOOLDIRectory--directory_name-'
  .-Wait----Yes----.
>--+-----+----->>
  '-Wait----+Yes+-'
      '-No--'
```

## Parameters

---

container\_name(Required)

Specifies the name of the container to move. You must specify the full path name of the container.

STGPOOLDIRectory

Specifies the name of the storage pool directory where the container is moved. This parameter is optional.

If you specify a storage pool directory, it must be in the same storage pool as the original container. The storage pool directory is used for the new container. If you don't specify a storage pool directory, the IBM Spectrum Protect™ server selects a storage pool directory from the same storage pool.

Wait

Specifies whether to wait for the IBM Spectrum Protect server to complete processing this command in the foreground. This parameter is optional. Specify the following values:

No

The server processes this command in the background and you can continue with other tasks while the command is processing. Messages that are related to the background process are shown either in the activity log file or the server console, depending on where the messages are logged. This is the default.

Yes

The server processes this command in the foreground. The operation must complete before you can continue with other tasks. Messages are shown either in the activity log file or the server console, or both, depending on where the

messages are logged.

Restriction: You cannot specify the WAIT=YES parameter from the server console.

## Example: Move a container

**AIX** | **Linux** Move a container, 0000000000000001.dcf, from the /data1/storage/dir1 storage pool directory to the /data/storage/dir2 storage pool directory.

```
move container /data1/storage/dir1/00/0000000000000001.dcf
stgpooldir=/data/storage/dir2
```

**Windows** Move a container, 0000000000000001.dcf, from the e:\data1\storage\dir1 storage pool directory to the e:\data\storage\dir2 storage pool directory.

```
move container e:\data1\storage\dir1\00\0000000000000001.dcf
stgpooldir=e:\data\storage\dir2
```

Table 1. Commands related to MOVE CONTAINER

Command	Description
AUDIT CONTAINER	Audit a directory-container storage pool.
QUERY CONTAINER	Displays information about a container.

## MOVE DATA (Move files on a storage pool volume)

Use this command to move files from one storage pool volume to other storage pool volumes.

Restriction: You cannot use this command for volumes that are assigned to copy-container storage pools.

You can move files from a primary storage pool volume only to volumes in the same or a different primary storage pool. You can move files from a copy storage pool volume only to volumes in the same copy storage pool. You can move files from an active-data pool volume only to volumes in the same active-data pool.

In addition to moving data from volumes in storage pools that have NATIVE or NONBLOCK data formats, you can use this command to move data from volumes in storage pools that have NDMP data formats (NETAPPDUMP, CELERRADUMP, or NDMPDUMP). The target storage pool must have the same data format as the source storage pool. If you are moving data out of a storage pool for the purpose of upgrading to new tape technology, the target primary storage pool must be associated with a library that has the new device for the tape drives. IBM Spectrum Protect™ supports backend data movement for NDMP images.

You cannot move data into or out of a storage pool that is defined with a CENTERA device class.

If you are moving files to volumes in the same storage pool, sufficient space must be available on the volumes. Otherwise, the operation fails.

When you move files from a sequential access volume, multiple sequential access volume mounts are required to move files that span volumes.

When you move files from a random access volume, the server erases any cached copies of files on the volume.

After a move data operation completes, a volume might not be empty if one or more files cannot be relocated to another volume because of input/output errors on the device or because errors were found in the file. If needed, you can delete the volume using the option to discard any data. The files with I/O or other errors are then deleted.

You can use this command to move files from an offsite volume in a copy storage pool or active-data pool. Because the offsite volume cannot be mounted, the server obtains the files that are on the offsite volume from either a primary storage pool or another copy storage pool. These files are then written to the destination volumes in the original copy storage pool or active-data pool.

During the data movement process, active-data pools cannot be used to obtain data.

If you run the MOVE DATA command on an offsite volume that contains collocated data, it might be necessary to issue the MOVE DATA command multiple times to move all of the data out of the volume. For example, if you are using filespace collocation groups with an offsite volume that contains filespace in a collocation group and filespace that are not in the group, you must issue two MOVE DATA commands. Each MOVE DATA command moves the data for a single collocated or non-collocated group of files.

Do not use the MOVE DATA command if a restore process (RESTORE STGPOOL or RESTORE VOLUME) is running. The MOVE DATA command might cause the restore to be incomplete. If you issue the MOVE DATA command during a restore operation and you receive an error message indicating that one or more files are locked and cannot be moved, you must reissue the MOVE DATA command after the restore operation completes in order to move any remaining files.

Remember:

Issuing this command removes duplicate data when:

- Moving data from a primary storage pool that is set up for data deduplication to another primary storage pool that is also set up for data deduplication.
- Moving data within a copy storage pool that is set up for data deduplication.
- Moving data within an active-data pool that is set up for data deduplication.

A volume in a deduplicated storage pool might contain files that are logically deleted but are still linked by files on other volumes. If you use the MOVE DATA command to move the contents of a deduplicated storage pool volume to a non-deduplicated storage pool, the logically deleted files are not written to the new volume since they do not exist logically. The deleted files are kept on the original volumes for other files to reference. The MOVE DATA process ends successfully but none of the deleted files are moved to the new target volume and the source volume is not deleted. You can issue the QUERY CONTENT command with the FOLLOWLINKS=YES or FOLLOWLINKS=JUSTLINKS parameter to verify whether the volume contains files that are linked by files on other volumes.

## Privilege class

To issue this command, you must have system privilege, unrestricted storage privilege, or restricted storage privilege for the storage pool to which the volume belongs and also for the new storage pool, if one is specified.

## Syntax

```
>>-MOVE Data--volume_name--+-----+----->
                               '-STGpool----pool_name-'

.-SHREDTONOshred----No-----
>--+-----+----->
'-SHREDTONOshred----+No--+-'
                               '-Yes-'

                               (1) (2)
.-RECONSTRUCT----No or Yes-----
>--+-----+----->
'-RECONSTRUCT----+No--+-----'
                               '-Yes-'

.-Wait----No-----
>--+-----+----->>
'-Wait----+No--+-'
                               '-Yes-'
```

Notes:

1. The default is NO if either the source or target storage pool is random access. The default is YES if both the source and target storage pools are sequential access.
2. This parameter is not available or is ignored if the data format is NETAPPDUMP, CELERRADUMP, or NDMPDUMP data.

## Parameters

volume\_name (Required)

Specifies the storage pool volume from which to move files.

STGpool

Specifies the primary storage pool to which you want to move files (the target storage pool). This parameter is optional and applies only to moving data from primary storage pool volumes. If you do not specify a value for this parameter, files are moved to other volumes within the same storage pool.

SHREDTONOshred

Specifies whether data is moved from a storage pool that enforces shredding to a storage pool that does not enforce shredding. This parameter is optional. The default value is NO. Possible values are:

No

Specifies that the server will not allow data to be moved from a storage pool that enforces shredding to a storage pool that does not enforce shredding. If the source storage pool enforces shredding and the target storage pool does not, the operation fails.

Yes

Specifies that the server allows data to be moved from a storage pool that enforces shredding to a storage pool that does not enforce shredding. The source data is shredded when the operation is complete. The target data will not be shredded when it is deleted.

#### RECONStruct

Specifies whether to reconstruct file aggregates during data movement. Reconstruction removes empty space that has accumulated during deletion of logical files from an aggregate. This parameter is optional. If both the source and target storage pools are sequential access, the default value is YES. If either the source or target storage pool is random access, the default is NO.

The parameter is not available or is ignored if any of the following conditions are true:

- The data format is NETAPPDUMP, CELERRADUMP, or NDMPDUMP.
- The data is in a storage pool that is configured for data deduplication.
- The target storage pool for the data movement is configured for data deduplication.

Attention: Reconstruction removes inactive backup files in active-data pools. If you specify RECONSTRUCT=NO when moving the data in an active-data pool that is not configured for data deduplication, inactive backup files remain in the storage pool.

Possible values are:

No

Specifies that reconstruction of file aggregates is not completed during data movement.

Yes

Specifies that reconstruction of file aggregates is completed during data movement. You can only specify this option when both the source and the target storage pools are sequential-access.

#### Wait

Specifies whether to wait for the server to complete processing this command in the foreground. This parameter is optional. The default value is No. Possible values are:

No

Specifies that the server processes this command in the background. You can continue with other tasks while the command is being processed.

The server displays messages that are created from the background process either in the activity log or the server console, depending on where messages are logged.

To cancel a background process, use the CANCEL PROCESS command. If a MOVE DATA background process is canceled, some files may have already moved before the cancellation.

Yes

Specifies that the server processes this command in the foreground. You wait for the command to complete before continuing with other tasks. The server then displays the output messages to the administrative client when the command completes.

Restriction: You cannot specify WAIT=YES from the server console.

## Example: Move files on a storage pool volume

Move files from storage pool volume STGVOL.1 to any available volumes assigned to the 8MMPool storage pool.

```
move data stgvol.1 stgpool=8mmpool
```

## Related commands

Table 1. Commands related to MOVE DATA

Command	Description
CANCEL PROCESS	Cancels a background server process.

Command	Description
DEFINE VOLUME	Assigns a volume to be used for storage within a specified storage pool.
DELETE VOLUME	Deletes a volume from a storage pool.
MOVE DRMEDIA	Moves DRM media onsite and offsite.
QUERY ACTLOG	Displays messages from the server activity log.
QUERY CONTENT	Displays information about files in a storage pool volume.
QUERY DRMEDIA	Displays information about disaster recovery volumes.
QUERY PROCESS	Displays information about background processes.
QUERY SHREDSTATUS	Displays information about data waiting to be shredded.
SHRED DATA	Manually starts the process of shredding deleted data.

## MOVE DRMEDIA (Move disaster recovery media offsite and back onsite)

Use this command to track volumes that are to be moved offsite and to identify the expired or empty volumes that are to be moved onsite. You can track database backup volumes, and volumes in copy storage pools, container-copy storage pools, and active-data storage pools.

The processing of volumes by this command depends on what the volumes are used for:

### Backups of the server database

To control whether the command processes database backup volumes, use the SOURCE parameter on this command. The command can process volumes that are used for full plus incremental or snapshot database backups. You cannot specify virtual volumes (backup objects that are stored on another server). You can change volumes through each state, or you can use the TOSTATE parameter and skip states to simplify the movements.

### Copy storage pools

The MOVE DRMEDIA command always processes copy storage-pool volumes.

### Container-copy storage pools

By default, volumes in container-copy storage pools are not eligible for processing by the MOVE DRMEDIA command. To process container-copy storage pool volumes, you must issue the SET DRMCOPYCONTAINERSTGPOOL command first, or specify the COPYCONTAINERSTGPOOL parameter on the MOVE DRMEDIA command.

### Active-data storage pools

By default, volumes in active-data storage pools are not eligible for processing by the MOVE DRMEDIA command. To process active-data pool volumes, you must issue the SET DRMACTIVEDATASTGPOOL command first, or specify the ACTIVEDATASTGPOOL parameter on the MOVE DRMEDIA command.

You can use the QUERY ACTLOG command to see whether the MOVE DRMEDIA command was successful. You can also view this information from the server console.

Restriction: Do not run the MOVE DRMEDIA and BACKUP STGPOOL commands concurrently. Ensure that the storage pool backup processes are complete before you issue the MOVE DRMEDIA command.

## Privilege class

To issue this command, you must have one of the following privilege classes:

- If the CMD parameter is specified and the REQSYSAUTHOUTFILE server option is set to NO: operator, unrestricted storage, or system privilege.
- If the CMD parameter is specified and the REQSYSAUTHOUTFILE server option is set to YES (the default): system privilege.

## Syntax

```
>>-MOVE DRMedia--volume_name----->
>--+-----+----->
  '-WHEREState-----+MOUNTable-----+'
                    +-NOTMOUNTable-----+
```

```

+-COUrier-----+
+-VAULTRetrieve---+
'-COURIERRetrieve-'

>--+-+-----+-----+-----+-----+----->
'-BEGINDate---date-' '-ENDDate---date-'

>--+-+-----+-----+-----+-----+----->
'-BEGINTime---time-' '-ENDTime---time-'

>--+-+-----+-----+-----+-----+----->
'-COPYContainerstgpool---pool_name-'

>--+-+-----+-----+-----+-----+----->
'-COPYstgpool---pool_name-'

>--+-+-----+-----+-----+-----+----->
'-ACTIVEDatastgpool---pool_name-'

.-Source---DBBackup-----
>--+-+-----+-----+-----+-----+----->
'-Source---DBBackup---+'
      +-DBSnapshot+
      '-DBNone-----'

.-REMove---Bulk-----
>--+-+-----+-----+-----+-----+----->
'-REMove---No-----+'
      +-Yes-----+
      +-Bulk-----+
      '-Untileefull-'

>--+-+-----+-----+-----+-----+----->
'-TOSTate---NOTMOUNTABLE---+'
      +-COUrier-----+
      +-VAULT-----+
      +-COURIERRetrieve+
      '-ONSITERetrieve--'

>--+-+-----+-----+-----+-----+----->
'-WHERELocation---location-'

>--+-+-----+-----+-----+-----+----->
'-TOLocation---location-' '-CMD---"command"-

      .-APPend---No-----
>--+-+-----+-----+-----+-----+----->
'-CMDFilename---file_name-' '-APPend---No---+'
      '-Yes-'

.-Wait---No-----
>--+-+-----+-----+-----+-----+----->
'-Wait---No---+' '-CAP---x,y,z-'
      '-Yes-'

```

## Parameters

### volume\_name (Required)

Specifies the name of the volume to be processed. You can use wildcard characters. If you use wildcard characters to specify this name, you must also specify the WHERESTATE parameter. The server looks for matching names among the following eligible volumes:

- Database backup volumes, as specified by the SOURCE parameter of this command.
- Copy storage pool volumes from the storage pools named in the COPYSTGPOOL parameter. If you do not use the COPYSTGPOOL parameter, the server processes volumes from copy storage pools that were previously specified in the SET DRMCOPYSTGPOOL command.
- Container-copy storage pool volumes from the storage pools named in the COPYCONTAINERSTGPOOL parameter. If you do not use the COPYCONTAINERSTGPOOL parameter, the server processes volumes from container-copy storage pools that were previously specified in the SET DRMCOPYCONTAINERSTGPOOL command.

- Active-data storage pool volumes from the storage pools named in the `ACTIVEDATASTGPOOL` parameter. If you do not use the `ACTIVEDATASTGPOOL` parameter, the server processes volumes from active-data storage pools that were previously specified in the `SET DRMACTIVEDATASTGPOOL` command.

Other parameters can also limit the results of the command.

#### WHEREState

Specifies the state of volumes to be processed. This parameter is required if the `TOSTATE` parameter is not specified or if you use a wildcard character in the volume name. For more information, see Table 2 and Table 3. Specify one of the following values:

#### MOUNTable

These volumes contain valid data and are available for onsite processing. The values change to `NOTMOUNTABLE` if the `TOSTATE` parameter is not specified.

Depending on the outcome of the `REMOVE` parameter, the server might eject volumes in an automated library before you change the destination state.

For external libraries, the server sends requests to the external library manager to eject the volumes. It depends on the external library manager whether the volumes are ejected from the library.

#### NOTMOUNTable

These volumes are onsite, contain valid data, and are not available for onsite processing. The values change to `COURIER` if the `TOSTATE` parameter is not specified.

#### COURier

These volumes are with the courier and being moved offsite. The values change only to `VAULT`.

#### VAULTRetrieve

These volumes are at the offsite vault and do not contain valid data. The values change to `COURIERRETRIEVE` if the `TOSTATE` parameter is not specified.

#### COURIERRetrieve

These volumes are with the courier and being moved onsite. The values change only to `ONSITERETRIEVE`. The server deletes the volume records of the database backup and scratch copy storage pool volumes from the database.

#### BEGINDate

Specifies the beginning date that is used to select volumes. This parameter is optional. Volumes are considered eligible if the `MOVE DRMEDIA` command changes the volume to its current state on or after the specified date. The default is the earliest date for which volume information exists.

You can specify the date by using one of the following values:

Value	Description	Example
MM/DD/YYYY	A specific date.	09/15/1998
TODAY	The current date.	TODAY
TODAY-days or -days	The current date minus days specified.	TODAY-7 or -7  To identify volumes that were changed to their current state a week ago, you can specify <code>TODAY-7</code> or <code>-7</code> .
EOLM (end of last month)	The last day of the previous month.	EOLM
EOLM-days	The last day of the previous month minus days specified.	EOLM-1  To include files that were active a day before the last day of the previous month.
BOTM (beginning of this month)	The first day of the current month.	BOTM
BOTM+days	The first day of the current month, plus days specified.	BOTM+9  To include files that were active on the 10th day of the current month.

#### ENDDate



Specifies the ending date that is used to select volumes. This parameter is optional. Volumes are considered eligible if the MOVE DRMEDIA command changes the volume to its current state on or before the specified date. The default is the current date.

You can specify the date by using one of the following values:

Value	Description	Example
MM/DD/YYYY	A specific date.	09/15/1998
TODAY	The current date.	TODAY  To identify volumes that were changed to their current state today, specify TODAY.
TODAY-days or -days	The current date minus days specified. The maximum number of days is 9999.	TODAY-1 or -1  To identify volumes that were changed to their current state a week ago, you can specify TODAY-1 or -1.
EOLM (end of last month)	The last day of the previous month.	EOLM
EOLM-days	The last day of the previous month minus days specified.	EOLM-1  To include files that were active a day before the last day of the previous month.
BOTM (beginning of this month)	The first day of the current month.	BOTM
BOTM+days	The first day of the current month, plus days specified.	BOTM+9  To include files that were active on the 10th day of the current month.

#### BEGINTime

Specifies the beginning time that is used to select volumes for processing. This parameter is optional. Volumes are considered eligible if the MOVE DRMEDIA command changes the volume to its current state on or after the specified time and date. The default is midnight (00:00:00) on the date that is specified with the BEGINDATE parameter.

You can specify the time by using one of the following values:

Value	Description	Example
HH:MM:SS	A specific time on the specified begin date.	12:33:28
NOW	The current time on the specified begin date.	NOW
NOW+HH:MM or +HH:MM	The current time plus hours and minutes on the specified begin date.	NOW+03:00 or +03:00
NOW-HH:MM or -HH:MM	The current time minus hours and minutes on the specified begin date.	NOW-03:30 or -03:30  If you issue the MOVE DRMEDIA command at 9:00 with BEGINTIME=NOW-03:30 or BEGINTIME=-03:30, the server identifies the volumes that were changed to their current state at 5:30 on the begin date that you specify.

#### ENDTime

Specifies the ending time that is used to select volumes for processing. This parameter is optional. Volumes are considered eligible if the MOVE DRMEDIA command changes the volume to its current state on or after the specified time and date. The default is 23:59:59.

You can specify the time by using one of the following values:

Value	Description	Example
HH:MM:SS	A specific time on the specified end date.	12:33:28
NOW	The current time on the specified end date.	NOW

Value	Description	Example
NOW+HH:MM or +HH:MM	The current time plus hours and minutes on the specified end date.	NOW+03:00 or +03:00  If you issue the MOVE DRMEDIA command at 9:00 with ENDTIME=NOW+03:30 or ENDTIME=+03:30, the server identifies the volumes that were changed to their current state at 12:30 on the end date you specify.
NOW-HH:MM or -HH:MM	The current time minus hours and minutes on the specified end date.	NOW-03:30 or -03:30

#### COPYCONTAINERSTGPPOOL

Specifies the name of the container-copy storage pool whose volumes are to be processed. This parameter is optional. You can use wildcard characters to specify this name. If you use wildcard characters to specify this name, you must also specify the WHERESTATE parameter.

The container-copy storage pools that are specified with this parameter override storage pools that are specified with the SET DRMCOPYCONTAINERSTGPPOOL command. If this parameter is not specified, the server selects the storage pools as follows:

- If the SET DRMCOPYCONTAINERSTGPPOOL command was previously issued with valid container-copy storage pool names, the server processes only those storage pools.
- If the SET DRMCOPYCONTAINERSTGPPOOL command was not issued, or if all of the container-copy storage pools were removed by using the SET DRMCOPYCONTAINERSTGPPOOL command, the server processes all container-copy storage pool volumes based on the setting of the WHERESTATE parameter. If the parameter is set to a value of NOTMOUNTABLE, COURIER, VAULTRETRIEVE, or COURIERRETRIEVE, the volumes are processed. If the value is MOUNTABLE, the volumes are not processed.

#### COPYSTGPPOOL

Specifies the name of the copy storage pool whose volumes are to be processed. This parameter is optional. You can use wildcard characters to specify this name. If you use wildcard characters to specify this name, you must also specify the WHERESTATE parameter.

The copy storage pools that are specified with this parameter override copy storage pools that are specified with the SET DRMCOPYSTGPPOOL command. If this parameter is not specified, the server selects the storage pools as follows:

- If the SET DRMCOPYSTGPPOOL command was previously issued with valid copy storage pool names, the server processes only those storage pools.
- If the SET DRMCOPYSTGPPOOL command was not issued, or if all of the copy storage pools are removed by using the SET DRMCOPYSTGPPOOL command, the server processes all copy storage pool volumes in the specified state. The states available are MOUNTABLE, NOTMOUNTABLE, COURIER, VAULTRETRIEVE, or COURIERRETRIEVE.

#### ACTIVEDATASTGPPOOL

Specifies the name of the active-data pool whose volumes are to be processed. This parameter is optional. You can use wildcard characters to specify this name. If you use wildcard characters to specify this name, you must also specify the WHERESTATE parameter.

The active-data pools that are specified with this parameter override active-data pools that are specified with the SET DRMACTIVEDATASTGPPOOL command. If this parameter is not specified, the server selects the storage pools in the following way:

- If the SET DRMACTIVEDATASTGPPOOL command was previously issued with valid active-data pool names, the server processes only those storage pools.
- If the SET DRMACTIVEDATASTGPPOOL command was not issued, or all of the active-data pools are removed by using the SET DRMACTIVEDATASTGPPOOL command, the server processes all active-data pool volumes in the specified state. The states available are NOTMOUNTABLE, COURIER, VAULTRETRIEVE, or COURIERRETRIEVE. Volumes in the MOUNTABLE state are not processed.

#### Source

Specifies whether to include database backup volumes for processing. This parameter is optional. The default is DBBACKUP. Specify one of the following values:

##### DBBackup

Specifies that the server includes full and incremental database backup volumes for processing.

DBSnapshot

Specifies that the server includes database snapshot backup volumes for processing.

DBNone

Specifies that the server does not include any database backup volumes for processing.

REMOve

Specifies that the server tries to move the volume out of the library and into the convenience I/O station or entry/exit ports. This parameter is optional. Possible values are YES, NO, BULK, and UNTILEEFULL. The default is BULK. The response of the server to each value and the default value depends on the type of library.

Restriction: You can use the REMOVE=UNTILEEFULL option only with the library type SCSI.

SCSI libraries

The response of the server to the command depends on whether the library has entry/exit ports, and if so, whether a port is available for use. See the following table.

Table 1. Server response for SCSI libraries

Library characteristic	Server response when you specify REMOVE=YES	Server response when you specify REMOVE=BULK	Server response when you specify REMOVE=NO	Server response when you specify REMOVE=UNTILEEFULL
Library has no entry/exit ports	The server leaves the cartridge in its current slot within the library and specifies the slot address in a message.  The server then prompts you to remove the cartridge from the slot and to issue a REPLY command.	The server leaves the cartridge in its current slot within the library and specifies the slot address in a message.  The server does not prompt you to remove the cartridge and does not require a REPLY command.	The server leaves the cartridge in its current slot within the library and specifies the slot address in a message.  The server does not prompt you to remove the cartridge and does not require a REPLY command.	The server leaves the cartridge in its current slot within the library and specifies the slot address in a message.  The server does not prompt you to remove the cartridge and does not require a REPLY command.
Library has entry/exit ports and an entry/exit port is available	The server moves the cartridge to the available entry/exit port and specifies the port address in a message.  The server then prompts you to remove the cartridge from the slot and to issue a REPLY command.	The server moves the cartridge to the available entry/exit port and specifies the port address in a message.  The server does not prompt you to remove the cartridge and does not request a REPLY command.	The server specifies the port address in a message.  The server does not prompt you to remove the cartridge and does not request a REPLY command.	The server moves the cartridge to the available entry/exit port and specifies the port address in a message.  The server does not prompt you to remove the cartridge and does not request a REPLY command.
Library has entry/exit ports, but no ports are available	The server leaves the cartridge in its current slot within the library and specifies the slot address in a message.  The server then prompts you to remove the cartridge from the slot and to issue a REPLY command.	The server waits for a port to be made available.	The server specifies the port address in a message.  The server does not prompt you to remove the cartridge and does not request a REPLY command.	The command fails and any remaining eligible volumes are not processed.  Make the port available and issue the command again.

349X libraries

REMOVE=YES

The 3494 Library Manager ejects the cartridge to the convenience I/O station.

REMOVE=BULK

The 3494 Library Manager ejects the cartridge to the high-capacity output facility.

REMOVE=NO

The 3494 Library Manager does not eject the volume. The server leaves the cartridge in the library in the INSERT category for use by other applications.

#### ACSLs libraries

REMOVE=YES or REMOVE=BULK

The server ejects the cartridge to the convenience I/O station.

The server then deletes the volume entry from the server library inventory.

When you move volumes from the MOUNTABLE state with REMOVE=YES specified, the MOVE MEDIA command uses more than one slot in the CAP for a StorageTek library with ACSLS.

REMOVE=NO

The server does not eject the cartridge.

The server deletes the volume entry from the server library inventory and leaves the volume in the library.

#### External libraries

You can specify REMOVE=YES, REMOVE=BULK, or REMOVE=NO. For any value, the server requests the external library manager to eject the volume from the library.

It depends on the external library manager whether the volume is ejected from the library. Refer to the external library documentation for information about the procedures to follow when you use the MOVE DRMEDIA command to track volumes.

#### TOSTate

Specifies the destination state of the volumes that are processed. This parameter is required if the WHERESTATE parameter is not specified. If you specify TOSTATE parameter but not WHERESTATE parameter, you must specify the volume name. Wildcard characters are not allowed. See Table 2 and Table 3.

Specify one of the following values:

##### NOTMOUNTABLE

Specifies that volumes are to change to the NOTMOUNTABLE state. This value is valid only if the volumes are in the MOUNTABLE state.

If volumes are in an automated library, the server might eject the volumes from the library before you change them to the NOTMOUNTABLE state, depending on the behavior of the REMOVE parameter.

For external libraries, the server sends requests to the external library manager to eject the volumes. Whether the volumes are ejected from the library depends on the external library manager. Refer to the external library documentation for information about the procedures to follow when you use the MOVE DRMEDIA command to track the volumes.

##### COURier

Specifies that volumes are to change to the COURIER state. This value is valid only if the volumes are in the MOUNTABLE or NOTMOUNTABLE state.

Depending on the behavior of the REMOVE parameter and whether volumes are in an automated library, the server might eject the volumes from the library before you change them to the COURIER state.

For external libraries, the server sends requests to the external library manager to eject the volumes. Whether the volumes are ejected from the library depends on the external library manager. Refer to the external library documentation for information about the procedures to follow when you use the MOVE DRMEDIA command to track the volumes.

##### VAult

Specifies that volumes are to change to the VAULT state. This value is valid only if the volumes are in the MOUNTABLE, NOTMOUNTABLE, or COURIER state.

Depending on the behavior of the REMOVE parameter and whether volumes are in an automated library, the server might eject the volumes from the library before you change them to the VAULT state.

For external libraries, the server sends requests to the external library manager to eject the volumes. Whether the volumes are ejected from the library depends on the external library manager. Refer to the external library documentation for information about the procedures to follow when you use the MOVE DRMEDIA command to track the volumes.

#### COURIERRetrieve

Specifies that volumes are to change to the COURIERRETRIEVE state. This value is valid only if the volumes are in the VAULTRETRIEVE state.

#### ONSITERetrieve

Specifies that volumes are to change to the ONSITERETRIEVE state. This value is valid only if the volumes are in the VAULTRETRIEVE or COURIERRETRIEVE state. For database backup and scratch copy storage pool volumes that are changing to the ONSITERETRIEVE state, the server deletes the volume records from the database.

#### WHERELocation

Specifies the current location of the volumes. This parameter is optional. The maximum length of the location is 255 characters. Enclose the text in quotation marks if it contains any blank characters.

#### TOLocation

Specifies the destination location of the volumes. This parameter is optional. The maximum length of the location that is specified is 255 characters. Enclose the text in quotation marks if it contains any blank characters. If you do not specify the destination location, the location that is defined by the SET DRMNOMOUNTABLE command is used.

#### CMD

Specifies a command to be issued for each volume that is processed by the MOVE DRMEDIA command. DRM writes the commands to a file that is specified by the CMDFILENAME parameter. After the MOVE DRMEDIA operation is completed, the commands in the file can be issued. The command can contain up to 255 characters. If the command contains more than 240 characters, it is split into multiple lines, and continuation characters (+) are added. You might need to alter the continuation character based on the operating system. This parameter is optional.

#### command

The command string that is enclosed in quotation marks. The string must not include embedded quotation marks. For example, the following CMD parameter is valid:

```
cmd="checkin libvol lib8mm &vol status=scratch"
```

The following example is not a valid way to specify the CMD parameter:

```
cmd=""checkin libvol lib8mm" &vol status=scratch""
```

The command can include substitution variables. The variables are not case-sensitive, and must not contain blank spaces after the ampersand (&). You can specify the following values:

#### &VOL

A volume name.

#### &LOC

A volume location.

#### &VOLDSN

The file name to be written into the sequential access media labels. For example, if the applicable device class sets BKP as the tape volume prefix, a copy storage pool tape volume file name might be BKP.BFS and a database backup tape volume file name might be BKP.DBB.

#### &NL

The new line character. When you use the new line character, the command is split at the &NL variable. If required, you must specify the appropriate continuation character before the &NL character. If the &NL character is not specified and the command line is greater than 240 characters, the line is split into multiple lines and continuation characters (+) are added.

#### AIX Linux CMDFilename

Specifies the fully qualified name of the file that contains the commands that are specified by CMD parameter. This parameter is optional.

If you do not specify a file name or if you specify a null string (""), DRM uses the file name that is specified by the SET DRMCMDFILENAME command. If you do not specify a file name with the SET DRMCMDFILENAME command, DRM generates a file name by appending `exec_cmds` to the directory path name of the current working directory of the server.

If the operation fails after the command file is created, the file is not deleted.

#### Windows CMDFilename

**Windows** Specifies the fully qualified name of the file that contains the commands that are specified by CMD parameter. This parameter is optional.

The maximum length of the file name is 259 characters. If you do not specify a file name or if you specify a null string (""), DRM uses the file name that is specified by the SET DRMCMDFILENAME command. If you do not specify a file name with the SET DRMCMDFILENAME command, DRM generates a file name by appending `exec.cmd` to the directory that represents this instance of the server (typically the directory from which the server was installed). The DRM allocates the file name that is specified or generated. If the file name exists, DRM tries to use it; any existing data is overwritten. If this happens and the executable commands in the file have not been run, issue QUERY DRMEDIA command to rebuild the executable commands for the desired date and volume transition.

If the MOVE DRMEDIA command fails and none of the command string that is specified with the CMD parameter is written for the volume that successfully moved, the allocated file name is deleted.

#### APPend

Specifies whether to overwrite any existing contents of the command file or append the commands to the file. This parameter is optional. The default is NO. Specify one of the following values:

No

DRM overwrites the contents of the file.

Yes

DRM appends the commands to the file.

#### Wait

Specifies whether to wait for the server to complete processing this command in the foreground. This parameter is optional. The default value is NO. Specify one of the following values:

No

Specifies that the server processes this command in the background.

Messages that are created from the background process are displayed either in the activity log or the server console, depending on where messages are logged.

To see whether the operation was successful, issue the QUERY ACTLOG command.

Yes

Specifies that the server processes this command in the foreground. Wait for the command to complete before you continue with other tasks. The server then displays the output messages to the administrative client.

Restriction: You cannot specify WAIT=YES from the server console.

#### CAP

Specifies which cartridge access port (CAP) to use for ejecting volumes if you specify REMOVE=YES. This parameter applies to volumes in ACSLS libraries only. If the CAP priority value is set to 0 in the library, this parameter is required. If a CAP priority value greater than 0 is set in the library, this parameter is optional. By default, all CAPs initially have a priority value of 0, which means that ACSLS does not automatically select the CAP.

To display valid CAP identifiers (x,y,z), issue the QUERY CAP command with ALL specified from the Automated Cartridge System System Administrator (ACSSA) console on the ACSLS server host. The identifiers are as follows:

x

The Automated Cartridge System (ACS) ID. This identifier can be a number in the range 0 - 126.

y

The Library Storage Module (LSM) ID. This identifier can be a number in the range 0 - 23.

z

The CAP ID. This identifier can be a number in the range 0 - 11.

For more information, see the StorageTek documentation.

## Rules for destination states and destination locations

---

The following table shows how DRM determines the destination state and location of a volume.

Destination state

- The value of the TOSTATE parameter that was specified
- The next state of the WHERESTATE parameter that was specified, if the TOSTATE parameter was not specified

Destination location

- The value of the TOLOCATION parameter that was specified
- The location of the TOSTATE parameter that was specified, if the TOLOCATION parameter was not specified
- The location of the next state of the WHERESTATE parameter that was specified, if the TOLOCATION and TOSTATE parameters are not specified

Table 2. Volume destination and location

Parameters specified	Destination state	Destination location
WHERESTATE	The next state of the WHERESTATE	Location of the next state
WHERESTATE, TOSTATE	TOSTATE	Location of the TOSTATE
WHERESTATE, TOLOCATION	The next state of the WHERESTATE	TOLOCATON
WHERESTATE, TOSTATE, TOLOCATION	TOSTATE	TOLOCATION
TOSTATE	TOSTATE	Location of the TOSTATE
TOSTATE, WHERELOCATION	TOSTATE	Location of the TOSTATE
TOSTATE, WHERELOCATION, TOLOCATION	TOSTATE	TOLOCATION

## Rules for state transitions

The following tables show the state transitions that volumes are eligible for, based on their current state.

Table 3. State transitions for volumes

The current state of the volume	Destination state		
	MOUNTABLE	NOTMOUNTABLE	COURIER
MOUNTABLE	N	Y	Y
NOTMOUNTABLE	N	N	Y
COURIER	N	N	N
VAULT	N	N	N
VAULTRETRIEVE	N	N	N
COURIERRETRIEVE	N	N	N
ONSITERETRIEVE	N	N	N

Table 4. State transitions for volumes

The current state of the volume	Destination state	
	VAULT	VAULTRETRIEVE
MOUNTABLE	Y	N
NOTMOUNTABLE	Y	N
COURIER	Y	N
VAULT	N	N
VAULTRETRIEVE	N	N
COURIERRETRIEVE	N	N
ONSITERETRIEVE	N	N

Table 5. State transitions for volumes

The current state of the volume	Destination state	
	COURIERRETRIEVE	ONSITERETRIEVE

The current state of the volume	Destination state	
	COURIERRETRIEVE	ONSITERETRIEVE
MOUNTABLE	N	N
NOTMOUNTABLE	N	N
COURIER	N	N
VAULT	N	N
VAULTRETRIEVE	Y	Y
COURIERRETRIEVE	N	Y
ONSITERETRIEVE	N	N

### Example: Move disaster recovery media from the NOTMOUNTABLE state

Move disaster recovery media that is in the NOTMOUNTABLE state to the COURIER state, and then query the results.

```
move drmedia * wherestate=notmountable
tostate=courier
```

```
query actlog search="MOVE DRMEDIA"
```

```
08/11/1999 11:12:24 ANR0984I Process 10 for MOVE DRMEDIA started
in the BACKGROUND at 11:12:24.
08/11/1999 11:12:24 ANR0610I MOVE DRMEDIA started by HSIAO as
process 10.
08/11/1999 11:12:25 ANR6683I MOVE DRMEDIA: Volume TAPE0P was moved
from NOTMOUNTABLE state to COURIER.
08/11/1999 11:12:25 ANR6683I MOVE DRMEDIA: Volume TAPE1P was moved
from NOTMOUNTABLE state to COURIER.
08/11/1999 11:12:25 ANR6683I MOVE DRMEDIA: Volume DBTP02 was moved
from NOTMOUNTABLE state to COURIER.
08/11/1999 11:12:25 ANR6683I MOVE DRMEDIA: Volume DBTP01 was moved
from NOTMOUNTABLE state to COURIER.
08/11/1999 11:12:25 ANR6682I MOVE DRMEDIA command ended: 4 volumes
processed.
08/11/1999 11:12:25 ANR0611I MOVE DRMEDIA started by HSIAO as
process 10 has ended.
08/11/1999 11:12:25 ANR0985I Process 10 for MOVE DRMEDIA running in
the BACKGROUND processed 4 items with a
completion state of SUCCESS at 11:12:25.
```

### Example: Move disaster recovery media from the MOUNTABLE state

Move disaster recovery media from the MOUNTABLE state to the COURIER state. If the media is in an automated library, MOVE DRMEDIA ejects the media before you change the state.

```
move drmedia * wherestate=mountable tostate=courier wait=yes
```

```
ANR0984I Process 12 for MOVE DRMEDIA started
in the FOREGROUND at 09:57:17.
ANR0609I MOVE DRMEDIA started as process 12.
ANR0610I MOVE DRMEDIA started by HSIAO as
process 12.
ANR6696I MOVE DRMEDIA: CHECKOUT LIBVOLUME for
volume TAPE01 in library LIB8MM starting.
ANR6697I MOVE DRMEDIA: CHECKOUT LIBVOLUME for
volume TAPE01 in library LIB8MM completed
successful.
ANR6683I MOVE DRMEDIA: Volume TAPE01 was moved
from MOUNTABLE state to COURIER.
ANR6696I MOVE DRMEDIA: CHECKOUT LIBVOLUME for
volume TAPE02 in library LIB8MM starting.
ANR6697I MOVE DRMEDIA: CHECKOUT LIBVOLUME for
volume TAPE02 in library LIB8MM completed
successful.
ANR6683I MOVE DRMEDIA: Volume TAPE02 was moved
from MOUNTABLE state to COURIER.
```



```

ANR6696I MOVE DRMEDIA: CHECKOUT LIBVOLUME for
volume DBTP05 in library LIB8MM starting.
ANR6697I MOVE DRMEDIA: CHECKOUT LIBVOLUME for
volume DBTP05 in library LIB8MM completed
successful.
ANR6683I MOVE DRMEDIA: Volume DBTP05 was moved
from MOUNTABLE state to COURIER.
ANR6696I MOVE DRMEDIA: CHECKOUT LIBVOLUME for
volume DBTP04 in library LIB8MM starting.
ANR6697I MOVE DRMEDIA: CHECKOUT LIBVOLUME for
volume DBTP04 in library LIB8MM completed
successful.
ANR6683I MOVE DRMEDIA: Volume DBTP04 was moved
from MOUNTABLE state to COURIER.
ANR6682I MOVE DRMEDIA command ended: 4 volumes
processed.
ANR0611I MOVE DRMEDIA started by HSIAO as
process 12 has ended.
ANR0985I Process 12 for MOVE DRMEDIA running
in the FOREGROUND processed 4 items with a
completion state of SUCCESS at 10:12:25.

```

## Example: Move disaster recovery media from the VAULTRETRIEVE state

Move disaster recovery media that is in the VAULTRETRIEVE state to the ONSITERETRIEVE state. Generate a CHECKIN LIBVOLUME command for each volume that is successfully processed and store the commands in a file:

**AIX** | **Linux**

```

move drmedia * wherestate=vaultretrieve tostate=onsiteretrieve
cmdfilename=/drm/move/exec.cmds
cmd="checkin libvol lib8mm &vol status=scratch"

```

**Windows**

```

move drmedia * wherestate=vaultretrieve tostate=onsiteretrieve
cmdfilename=c:\drm\move\exec.cmd
cmd="checkin libvol lib8mm &vol status=scratch"

```

Query the results:

```

query actlog search="MOVE DRMEDIA"

08/13/1999 09:12:24 ANR0984I Process 15 for MOVE DRMEDIA started in
the BACKGROUND at 09:12:24.
08/13/1999 09:12:24 ANR0610I MOVE DRMEDIA started by HSIAO as
process 15.
08/13/1999 09:12:24 ANR6684I MOVE DRMEDIA: Volume CSTP01 was deleted.
08/13/1999 09:12:24 ANR6684I MOVE DRMEDIA: Volume CSTP02 was deleted.
08/13/1999 09:12:24 ANR6684I MOVE DRMEDIA: Volume DBTP10 was deleted.
08/13/1999 09:12:24 ANR6684I MOVE DRMEDIA: Volume DBTP11 was deleted.
08/13/1999 09:12:27 ANR6682I MOVE DRMEDIA command ended: 4 volumes
processed.
08/13/1999 09:12:42 ANR0611I MOVE DRMEDIA started by HSIAO as process
15 has ended.
08/13/1997 09:12:42 ANR0985I Process 15 for MOVE DRMEDIA running in
the BACKGROUND processed 4 items with a
completion state of SUCCESS at 09:12:42.

```

The volume check-in commands were also created in the file that was specified with the CMDFILENAME parameter:

- **AIX** | **Linux** /drm/move/exec.cmds
- **Windows** c:\drm\move\exec.cmd

The file contains these lines:

```

checkin libvol lib8mm CSTP01 status=scratch
checkin libvol lib8mm CSTP02 status=scratch
checkin libvol lib8mm DBTP10 status=scratch
checkin libvol lib8mm DBTP11 status=scratch

```

Tip: To process the CHECKIN LIBVOLUME commands, issue the MACRO command with the file name as the macro name.

## Related commands

Table 6. Commands related to MOVE DRMEDIA

Command	Description						
BACKUP DB	Backs up the IBM Spectrum Protect database to sequential access volumes.						
BACKUP STGPOOL	Backs up a primary storage pool to a copy storage pool.						
CANCEL PROCESS	Cancels a background server process.						
CHECKOUT LIBVOLUME	Checks a storage volume out of an automated library.						
DISMOUNT VOLUME	Dismounts a sequential, removable volume by the volume name.						
PREPARE	Creates a recovery plan file.						
QUERY ACTLOG	Displays messages from the server activity log.						
QUERY DRMEDIA	Displays information about disaster recovery volumes.						
QUERY DRMSTATUS	Displays DRM system parameters.						
QUERY PROCESS	Displays information about background processes.						
SET DRMACTIVEDATASTGPOOL	Specifies that active-data storage pools are managed by DRM.						
<table border="1"><tr><td>AIX</td><td>Linux</td><td>Windows</td></tr></table> SET DRMCOPYCONTAINERSTGPOOL	AIX	Linux	Windows	<table border="1"><tr><td>AIX</td><td>Linux</td><td>Windows</td></tr></table> Specifies the container-copy storage pools that are used in DRM commands.	AIX	Linux	Windows
AIX	Linux	Windows					
AIX	Linux	Windows					
SET DRMCOPYSTGPOOL	Specifies that copy storage pools are managed by DRM.						
SET DRMCOURIERNAME	Specifies the name of the courier for the disaster recovery media.						
SET DRMDBBACKUPEXPIREDAYS	Specifies criteria for database backup series expiration.						
SET DRMVAULTNAME	Specifies the name of the vault where DRM media is stored.						
SET DRMCMDFILENAME	Specifies a file name for containing DRM executable commands.						
SET DRMFILEPROCESS	Specifies whether the MOVE DRMEDIA or QUERY DRMEDIA command processes files associated with a device type of file.						
SET DRMNOTMOUNTABLENAME	Specifies the location name of the DRM media to be sent offsite.						

## MOVE GRPMEMBER (Move a server group member)

Use this command to move a member from one server group to another server group. The command fails if the member you are moving has the same name as a current member of the group.

### Privilege class

To issue this command, you must have system privilege.

### Syntax

```
>>-MOVE GRPMEMber--member_name--from_group--to_group-----<<
```

### Parameters

member\_name (Required)  
Specifies the member (a server or a server group) to move.  
from\_group (Required)

Specifies the server group with which the member is currently associated.  
to\_group (Required)  
Specifies the new server group for the member.

## Example: Move a server to another server group

---

Move member PAYSON from REGION1 group to REGION2 group.

```
move grpmember payson region1 region2
```

## Related commands

---

Table 1. Commands related to MOVE GRPMEMBER

Command	Description
DEFINE GRPMEMBER	Defines a server as a member of a server group.
DEFINE SERVERGROUP	Defines a new server group.
DELETE GRPMEMBER	Deletes a server from a server group.
DELETE SERVERGROUP	Deletes a server group.
QUERY SERVER	Displays information about servers.
QUERY SERVERGROUP	Displays information about server groups.
RENAME SERVERGROUP	Renames a server group.
UPDATE SERVERGROUP	Updates a server group.

## MOVE MEDIA (Move sequential-access storage pool media)

---

Use this command to manage overflow storage pools. The database tracks media that is moved by using this command.

This command applies to sequential-access primary and copy storage pool volumes that are managed by an automated library (including an external library). The library does not have to be full. One or more sequential-access storage pool volumes can be processed at the same time.

Use the DAYS parameter to identify eligible volumes to be moved. Use the OVERFLOW LOCATION parameter to record the storage location for the moved media.

This command generates a background process that you can view by using the QUERY PROCESS command. To cancel, issue the CANCEL PROCESS command.

To determine whether the command was successful, issue the QUERY ACTLOG command or use the server console.

The volumes that are moved by the MOVE DRMEDIA command for offsite recovery are not processed by the MOVE MEDIA command.

The MOVE MEDIA command does not process copy storage pool volumes with a DRM STATUS value of NOTMOUNTABLE, COURIER, or VAULT.

## Privilege class

---

To issue this command, you must have one of the following privilege classes:

- If the CMD parameter is NOT specified: operator or system privilege.
- If the CMD parameter is specified and the REQSYSAUTHOUTFILE server option is set to NO: operator, unrestricted storage, or system privilege.
- If the CMD parameter is specified and the REQSYSAUTHOUTFILE server option is set to YES (the default): system privilege.

## Syntax

---

```
>>-MOVE MEDia--volume_name--STGpool-----pool_name----->
```

```

.-Days-----0-----
>-----+-----+-----+-----+-----+-----+----->
'-Days-----days-'

>-----+-----+-----+-----+-----+-----+----->
'-WHEREState-----+MOUNTABLEInlib-----+'
                '-MOUNTABLENotinlib-'

>-----+-----+-----+-----+-----+-----+----->
|           .-.,------. |
|           V               | |
'-WHERESTATUS-----+FULL-----+--+'
                +-FILLing-+
                '-EMPTy---'

>-----+-----+-----+-----+-----+-----+----->
'-ACCess-----+READWrite-+-' '-OVFLocation-----location-'
                '-READOnly--'

.-REMOve-----Bulk-----
>-----+-----+-----+-----+-----+-----+----->
'-REMOve-----+No-----+' '-CMd-----"command"-'
                +-Yes--+
                '-Bulk-'

                .-APPend-----No-----
>-----+-----+-----+-----+-----+-----+----->
'-CMDFilename-----file_name-' '-APPend-----+No-----+'
                                '-Yes-'

.-CHECKLabel-----Yes-----
>-----+-----+-----+-----+-----+-----+----->
'-CHECKLabel-----+Yes--+-' '-CAP-----x,y,z---'
                '-No--'

```

## Parameters

### volume\_name (Required)

Specifies the name of the sequential access primary or copy storage pool volume to be processed. You can use a wildcard character to specify the name. All matching volumes are considered for processing.

### STGpool (Required)

Specifies the name of the sequential access primary or copy storage pool that is used to select the volumes for processing. You can use a wildcard character to specify the name. All matching storage pools are processed. If the storage pool specified is not managed by an automated library, no volumes are processed.

### Days

Specifies the number of days that must elapse after the volume is written or read before the volume is eligible for processing by the command. This parameter is optional. You can specify a number from 0 to 9999. The default value is 0. The most recent of the volumes' last written date or last read date is used to calculate the number of days elapsed.

### WHEREState

Specifies the current state of the volumes to be processed. This parameter is used to restrict processing to the volumes that are in the specified state. This parameter is optional. The default value is MOUNTABLEINLIB.

Possible values are:

#### MOUNTABLEInlib

Specifies that storage pool volumes are to move from the MOUNTABLEINLIB state to the MOUNTABLENOTINLIB state. Volumes in the MOUNTABLEINLIB state contain valid data and are in the library.

#### MOUNTABLENotinlib

Specifies that storage pool volumes are to change from the MOUNTABLENOTINLIB state back to the MOUNTABLEINLIB state. Volumes in the MOUNTABLENOTINLIB state might contain valid data and are in the overflow location.

- For empty scratch volumes, the MOVE MEDIA command deletes the volume records so that they can be used again.
- For private volumes, the MOVE MEDIA command resets the volume location to blank, changes the volumes' state to CHECKIN, and changes the last update date to the current date.
- For scratch volumes with data, the MOVE MEDIA command resets the volume location to blank, changes the volumes' state to CHECKIN, and changes the last update date to the current date.

Attention: Volumes in the CHECKIN state might contain valid data and must be checked into the library.

#### WHERESTATUS

Specifies that the move process must be restricted by volume status. This parameter is optional. You can specify more than one status in a list by separating each status with a comma and no intervening spaces. If you do not specify this parameter, volumes moved from the MOUNTABLEINLIB state to the MOUNTABLENOTINLIB state are restricted to only full volumes, and volumes moved from the MOUNTABLENOTINLIB state to the MOUNTABLEINLIB state are restricted to only empty volumes.

Possible values are:

##### FULL

Moves volumes with a status of FULL.

##### FILLing

Moves volumes with a status of FILLING.

##### EMPTy

Moves volumes with a status of EMPTY.

#### ACCess

Specifies how users and system processes access files in the storage pool volume that is moved out from an automated library and stored in an overflow location by the MOVE MEDIA command. This parameter is optional. If you do not specify this parameter, moving volumes from the MOUNTABLEINLIB state to the MOUNTABLENOTINLIB process updates the volumes' access mode to READONLY, and moving volumes from the MOUNTABLENOTINLIB state to the MOUNTABLEINLIB process updates the volumes' access mode to READWRITE.

Possible values are:

##### READWrite

Specifies that users and system processes can read from and write to files stored on the volume that is in the overflow location. If this value is specified, IBM Spectrum Protect™ requests the volume to be checked into the library when the volume is needed for a read or write operation.

##### READOnly

Specifies that users and system processes can read but not write to files that are stored on the volume that is in the overflow location. The server requests the volume to be checked into the library only when the volume is needed for a read operation.

#### OVFLocation

Specifies the overflow location that is the destination of the volumes that are being processed. The maximum length of the location name is 255 characters. The location name information must be enclosed in quotation marks if it contains any blank characters. If you do not specify an overflow location and the storage pool also has no overflow location identified, the server changes the location of the ejected volume to a null string ("").

#### REMOve

Specifies that the server tries to move the volume out of the library and into the convenience I/O station or entry/exit ports. This parameter is optional. Possible values are YES, BULK, and NO. The default is BULK. The response of the server to each of those options and the default values are described in the following tables.

**349X libraries:** The following table shows how the server responds for 349X libraries.

Table 1. How the Server Responds for 349X Libraries

REMOVE=YES	REMOVE=BULK	REMOVE=NO
The 3494 Library Manager ejects the cartridge to the convenience I/O station.	The 3494 Library Manager ejects the cartridge to the high-capacity output facility.	The 3494 Library Manager does not eject the volume.  The server leaves the cartridge in the library in the INSERT category for use by other applications.

**SCSI libraries:** The following table shows how the server responds to YES, BULK, and NO for SCSI libraries.

Table 2. How the Server Responds for SCSI Libraries

If a library...	And REMOVE=YES...	And REMOVE=BULK...	And REMOVE=NO
-----------------	-------------------	--------------------	---------------

<b>If a library...</b>	<b>And REMOVE=YES...</b>	<b>And REMOVE=BULK...</b>	<b>And REMOVE=NO</b>
Does not have entry/exit ports	The server leaves the cartridge in its current slot within the library and specifies the slot address in a message.  The server then prompts you to remove the cartridge from the slot and issue a REPLY command.	The server leaves the cartridge in its current slot within the library and specifies the slot address in a message.  The server does not prompt you to remove the cartridge and does not require a REPLY command.	The server leaves the cartridge in its current slot within the library and specifies the slot address in a message.  The server does not prompt you to remove the cartridge and does not require a REPLY command.
Has entry/exit ports and an entry/exit port is available	The server moves the cartridge to the available entry/exit port and specifies the port address in a message.  The server then prompts you to remove the cartridge from the slot and issue a REPLY command.	The server moves the cartridge to the available entry/exit port and specifies the port address in a message.  The server does not prompt you to remove the cartridge and does not request a REPLY command.	The server leaves the cartridge in its current slot within the library and specifies the slot address in a message.  The server does not prompt you to remove the cartridge and does not require a REPLY command.
Has entry/exit ports, but no ports are available	The server leaves the cartridge in its current slot within the library and specifies the slot address in a message.  The server then prompts you to remove the cartridge from the slot and issue a REPLY command.	The server waits for an entry/exit port to be made available.	The server leaves the cartridge in its current slot within the library and specifies the slot address in a message.  The server does not prompt you to remove the cartridge and does not require a REPLY command.

**ACSLs libraries:** The following table shows how the server responds for ACSLS libraries.

Table 3. How the Server Responds for ACSLS Libraries

<b>REMOVE=YES or REMOVE=BULK</b>	<b>REMOVE=NO</b>
The server ejects the cartridge to the convenience I/O station.  The server then deletes the volume entry from the server library inventory.  While moving volumes from the MOUNTABLE state with REMOVE=YES specified, the MOVE MEDIA command uses more than one slot in the CAP for a StorageTek library with ACSLS.	The server does not eject the cartridge.  The server deletes the volume entry from the server library inventory and leaves the volume in the library.

**External libraries:** The following table shows how the server responds for external libraries.

Table 4. How the Server Responds for External Libraries

<b>REMOVE=YES or REMOVE=BULK</b>	<b>REMOVE=NO</b>
The server ejects the cartridge to the convenience I/O station. The server then deletes the volume entry from the server library inventory.	The server does not eject the cartridge.  The server deletes the volume entry from the server library inventory and leaves the volume in the library.

CMd

Specifies the creation of executable commands. This parameter is optional. You must enclose your command specification in quotation marks. The maximum length of the command specification is 255 characters. For each volume successfully processed by the MOVE MEDIA command, the server writes the associated commands to a file. Specify the file name with the CMDFILENAME parameter.

**AIX** | **Linux** If you do not specify the file name, the MOVE MEDIA command generates a default file name by appending the string `exec.cmds.media` to the IBM Spectrum Protect server directory.

**Windows** If you do not specify the file name, the MOVE MEDIA command generates a default file name by appending the string `exec.cmd.media` to the IBM Spectrum Protect server directory.

If the length of the command that is written to the file exceeds 255 characters, it is split into multiple lines and a continuation character, `+`, is added to all but the last line of the command. You must alter the continuation character according to the requirements of the product that runs the commands.

If you do not specify `CMD`, the MOVE MEDIA command might not generate any executable commands.

#### string

Specifies the string to build an executable command. You can specify any free form text for the string. Enclose the full string in quotation marks. For example, the following is a valid executable command specification:

```
CMD="UPDATE VOLUME &VOL"
```

The following is an invalid executable command specification:

```
CMD=""UPDATE VOLUME" &VOL"
```

#### substitution

Specifies a variable for which you want the command to substitute a value. The possible substitution variables are:

##### &VOL

Substitute the volume name for `&VOL`. You can specify lowercase characters, `&vol`. No spaces or blanks are allowed between ampersand, `&`, and `VOL`. If there are spaces or blanks between ampersand and `VOL`, the MOVE MEDIA command treats them as strings and no substitution is set. If `&VOL` is not specified, no volume name is set in the executable command.

##### &LOC

Substitute the volume location for `&LOC`. You can specify lowercase characters, `&loc`. No spaces or blanks are allowed between ampersand, `&`, and `LOC`. If there are spaces or blanks between ampersand and `LOC`, the MOVE MEDIA command treats them as strings and no substitution is set. If `&LOC` is not specified, no location name is set in the executable command.

##### &VOLDSN

Substitute the volume file name for `&VOLDSN`. An example of a storage pool tape volume file name that uses the default prefix `ADSM` is `ADSM.BFS`. If `&VOLDSN` is not specified, no volume file name is set in the executable command.

##### &NL

Substitute a new line character for `&NL`. When `&NL` is specified, the MOVE MEDIA command splits the command at the position where the `&NL` is and does not append any continuation character. The user is responsible for specifying the correct continuation character before the `&NL` if one is required. The user is also responsible for the length of the line written. If the `&NL` is not specified and the length of the command line exceeds 255, the command line is split into multiple lines and a continuation character, `+`, is added to all but the last line of the command.

#### CMDFilename

Specifies the full path name of a file that contains the commands that are specified with `CMD`. This parameter is optional. The maximum length of the file name is 1279 characters.

**AIX** | **Linux** If you do not specify a file name, the MOVE MEDIA command generates a default file name by appending the string `exec.cmds.media` to the IBM Spectrum Protect server directory. The server directory is the current working directory of the IBM Spectrum Protect server process.

**Windows** If you do not specify a file name, the MOVE MEDIA command generates a default file name by appending the string `exec.cmd.media` to the IBM Spectrum Protect server directory. The server directory is the current working directory of the IBM Spectrum Protect server process.

The MOVE MEDIA command automatically allocates the file name that is specified or generated. If the file name exists, you can use the `APPEND=YES` parameter to add to the file. Otherwise, the file is overwritten. If a file is accidentally overwritten and you must run the commands that were in the file, issue the `QUERY MEDIA` command to rebuild the executable commands for the desired volumes. If the MOVE MEDIA command fails after the command file is allocated, the file is not deleted.

#### APPend

Specifies to write at the beginning or ending of the command file data. The default is NO. Possible values are:

No

Specifies to write the data from the beginning of the command file. If the command file exists, its contents are overwritten.

Yes

Specifies to append the command file by writing at the end of the command file data.

#### CHECKLabel

Specifies whether the server reads volume labels for sequential media. For SCSI devices, you can suppress label checking by setting the CHECKLabel to NO. This parameter is not applicable to 349X libraries. This parameter is optional. The default is YES. Possible values are:

Yes

Specifies that the server attempts to read the media label. Reading the media label verifies that the correct volume is being checked out.

No

Specifies that the server does not attempt to read media label. This increases performance because the read process does not occur.

#### CAP

Specifies which cartridge access port (CAP) to use for ejecting volumes if you specify REMOVE=YES. This parameter applies to volumes in ACSLS libraries only. If the CAP priority value is set to 0 in the library, this parameter is required. If a CAP priority value greater than 0 is set in the library, this parameter is optional. By default, all CAPs initially have a priority value of 0, which means that ACSLS does not automatically select the CAP.

To display valid CAP identifiers (x,y,z), issue the QUERY CAP command with ALL specified from the Automated Cartridge System System Administrator (ACSSA) console on the ACSLS server host. The identifiers are as follows:

x

The Automated Cartridge System (ACS) ID. This identifier can be a number in the range 0 - 126.

y

The Library Storage Module (LSM) ID. This identifier can be a number in the range 0 - 23.

z

The CAP ID. This identifier can be a number in the range 0 - 11.

For more information, see the StorageTek documentation.

## Example: Move all full volumes out of the library

---

Move all full volumes that are in the ARCHIVE sequential primary storage pool out of the library.

```
move media * stgpool=archive
```

## Example: Generate the checkin commands

---

Generate the CHECKIN LIBVOLUME commands for full and partially full volumes that are in the ONSITE.ARCHIVE primary storage pool and stored in the overflow location, Room 2948/Bldg31.

**AIX** | **Linux** MOVE MEDIA creates the executable commands in /tsm/move/media/checkin.vols

**Windows** MOVE MEDIA creates the executable commands in c:\tsm\move\media\checkin.vols

```
move media * stgpool=onsite.archive
wherestate=mountablenotinlib wherestatus=full,filling
ovflocation=room2948/bldg31
cmd="checkin libvol lib3494 &vol status=private"
cmdfilename=/tsm/move/media/checkin.vols
```

```
checkin libvolume lib3494 TAPE04 status=private
checkin libvolume lib3494 TAPE13 status=private
checkin libvolume lib3494 TAPE14 status=private
```

Tip: Run the CHECKIN LIBVOLUME commands by issuing the MACRO command with the following as the macro name:

- **AIX** | **Linux** /tsm/move/media/checkin.vols
- **Windows** c:\tsm\move\media\checkin.vols



## Related commands

Table 5. Commands related to MOVE MEDIA

Command	Description
CANCEL PROCESS	Cancel a background server process.
QUERY MEDIA	Displays information about storage pool volumes moved by the MOVE MEDIA command.
QUERY PROCESS	Displays information about background processes.

## MOVE NODEDATA (Move data by node in a sequential access storage pool)

Use this command to move data that is in a sequential-access storage pool. You can move data for one or more nodes, a group of file spaces, or for a group of collocated nodes. You can also move selected file spaces for a single node. The data can be in a primary storage pool, a copy storage pool, or an active-data pool.

This command is helpful for reducing the number of volume mounts during client restore or retrieve operations by consolidating data for a specific node within a storage pool, or to move data to another storage pool. For example, you can use this command for moving data to a random-access storage pool in preparation for client restore processing.

Ensure that the access mode of the volumes from which you are moving the node data is read/write or read-only and that the access mode of the volumes to which you are moving the node data is set to read/write. This operation will not move data on volumes with access modes of offsite, unavailable, or destroyed.

The MOVE NODEDATA command takes two forms, depending on whether you are moving data only for selected filespace. The syntax and parameters for each form are defined separately.

Restriction: You cannot move node data into or out of a storage pool that is defined with a CENTERA device class.

Table 1. Commands related to MOVE NODEDATA

Command	Description
CANCEL PROCESS	Cancel a background server process.
COPY ACTIVATEDATA	Copies active backup data.
DEFINE COLLOGGROUP	Defines a collocation group.
DEFINE COLLOCMEMBER	Adds a client node or file space to a collocation group.
DELETE COLLOGGROUP	Deletes a collocation group.
DELETE COLLOCMEMBER	Deletes a client node or file space from a collocation group.
MOVE DATA	Moves data from a specified storage pool volume to another storage pool volume.
QUERY ACTLOG	Displays messages from the server activity log.
QUERY COLLOGGROUP	Displays information about collocation groups.
QUERY FILESPACE	Displays information about data in file spaces that belong to a client.
QUERY NODEDATA	Displays information about the location and size of data for a client node.
QUERY OCCUPANCY	Displays file space information by storage pool.
QUERY PROCESS	Displays information about background processes.
QUERY STGPOOL	Displays information about storage pools.
QUERY VOLUME	Displays information about storage pool volumes.
UPDATE COLLOGGROUP	Updates the description of a collocation group.

- MOVE NODEDATA (Move data in file spaces for one or more nodes or a collocation group)  
Use this command to move data in file spaces that belong to; one or more nodes, a node collocation group, or a file space collocation group.
- MOVE NODEDATA (Move data from selected file spaces of a single node)  
Use this command to move data for selected file spaces belonging to a single node.

## MOVE NODEDATA (Move data in file spaces for one or more nodes or a collocation group)

Use this command to move data in file spaces that belong to; one or more nodes, a node collocation group, or a file space collocation group.

### Privilege class

To issue this command, you must have system privilege, unrestricted storage privilege, or restricted storage privilege for the source storage pool. If your authorization is restricted storage privilege and you are moving data to another storage pool, you need the appropriate authority for the destination storage pool.

### Syntax

```

      .-,'-----'.
      v           |
>>-MOVE NODEdata-+---node_name+-----+----->
      '-COLLOCGroup-----group_name-'

>--FROMstgpool---source_pool_name----->

>--+-----+----->
  '-TOstgpool---destination_pool_name-'

  .-Type---ANY-----'.
>--+-----+----->
  '-Type---+ANY-----+'
      +-Backup-----+
      +-ARchive-----+
      '-SPacemanaged-'

  .-MAXProcess---1-----'.  .-Wait---No-----'.
>--+-----+-----+----->
  '-MAXProcess---num_processes-'  '-Wait---+No--+-'
                                      '-Yes-'

                                     (1)
  .-RECONstruct---No or Yes-----'.
>--+-----+-----+-----><
  '-RECONstruct---+No--+-----+'
      '-Yes-'

```

Notes:

1. The default is NO if either the source or target storage pool is random access. The default is YES if both the source and target storage pools are sequential access.

### Parameters

node\_name (Required unless the COLLOGROUP parameter is specified)

Specifies the node name that is related to the data that is moved with this command. Separate multiple names with commas and no intervening spaces. You can use wildcard characters to specify names.

COLLOCGroup (Required unless the node\_name parameter is specified)

Specifies the name of the collocation group whose data is to be moved. Data for all nodes and file spaces that belong to the collocation group are moved.

FROMstgpool (Required)

Specifies the name of a sequential-access storage pool that contains data to be moved. This storage pool must be in the NATIVE or NONBLOCK data format.

#### TOstgpool

Specifies the name of a storage pool to where the data is moved. This storage pool must be in the NATIVE or NONBLOCK data format. This parameter is optional and does not apply when the source storage pool is a copy storage pool or an active-data pool. That is, if the source storage pool is a copy storage pool the destination must be the same copy storage pool. Similarly, if the source storage pool is an active-data pool, the destination must be the same active-data pool. If a value is not specified, data is moved to other volumes within the source pool.

Important: If you are moving data within the same storage pool, there must be volumes available that do not contain the node data that you are moving. That is, the server cannot use volumes that contain the data to be moved as destination volumes.

#### Type

Specifies the type of files to be moved. This parameter is optional. The default value is ANY. If the source storage pool is an active-data pool, the only valid values are ANY and BACKUP. However, only the active versions of backup data are moved if TYPE=ANY. Specify one of the following values:

##### ANY

Specifies that all types of files are moved.

##### Backup

Specifies that backup files are moved.

##### ARChive

Specifies that archive files are moved. This value is not valid for active-data pools.

##### SPacemanaged

Specifies that space-managed files (files that were migrated by an IBM Spectrum Protect™ for Space Management client) are moved. This value is not valid for active-data pools.

#### MAXPRocess

Specifies the maximum number of parallel processes to use for moving data. This parameter is optional. You can specify a value from 1 to 999, inclusive. The default value is 1. Increasing the number of parallel processes usually improves throughput.

When you determine this value, consider the number of logical and physical drives that can be dedicated to this operation. To access a sequential access volume, IBM Spectrum Protect uses a mount point and, if the device type is not FILE, a physical drive. The number of available mount points and drives depends on other IBM Spectrum Protect system activity. The mount points and drives also depend on the mount limits of the device classes for the sequential access storage pools that are involved in the move. Each process needs a mount point for storage pool volumes, and, if the device type is not FILE, each process also needs a drive.

#### Wait

Specifies whether to wait for the server to complete processing this command in the foreground. This parameter is optional. The default value is No. Specify one of the following values:

##### No

Specifies that the server processes this command in the background. You can continue with other tasks while the command is being processed.

The server displays messages that are created from the background process either in the activity log or the server console, depending on where messages are logged.

To cancel a background process, use the CANCEL PROCESS command. If a background process is canceled, some files might move before the cancellation.

##### Yes

Specifies that the server processes this command in the foreground. You wait for the command to complete before you can continue with other tasks. The server then displays the output messages to the administrative client when the command completes.

Restriction: You cannot specify WAIT=YES from the server console.

#### RECONStruct

Specifies whether to reconstruct file aggregates during data movement. Reconstruction removes empty space that accumulated during deletion of logical files from an aggregate. This parameter is optional. If both the source and target storage pools are sequential access, the default value is YES. If either the source or target storage pool is random access, the default is NO.

The parameter is not available or is ignored if any of the following conditions are true:

- The data format is NETAPPDUMP, CELERRADUMP, or NDMPDUMP.
- The data is in a storage pool that is configured for data deduplication.
- The target storage pool for the data movement is configured for data deduplication.

Attention: Reconstruction removes inactive backup files in active-data pools. If you specify RECONSTRUCT=NO when you move the data in an active-data pool that is not configured for data deduplication, inactive backup files remain in the storage pool.

You can specify one of the following values:

No

Specifies that reconstruction of file aggregates are not run during the move.

Yes

Specifies that reconstruction of file aggregates are run during the move. You can specify only this option when both the source and the target storage pools are sequential-access.

## Move a specific node's data from a tape storage pool to a disk storage pool

Move all data that belongs to node MARY that is stored in storage pool TAPEPOOL. Data can be moved to disk storage pool BACKUPPOOL.

```
move nodedata mary
  fromstgpool=tapepool tostgpool=backuppool
```

## Move data for a node collocation group from one storage pool to another

Move all data for node collocation group NODEGROUP1 from storage pool SOURCEPOOL to storage pool TARGETPOOL.

```
move nodedata collogcgroup=nodegroup1 fromstgpool=sourcespool tostgpool=targetpool
```

## Move data for a file space collocation group from one storage pool to another

Move all data for file space collocation group FSGROUP1 from storage pool SOURCEPOOL2 to storage pool TARGETPOOL2.

```
move nodedata collogcgroup=fsgroup1 fromstgpool=sourcespool2 tostgpool=targetpool2
```

## MOVE NODEDATA (Move data from selected file spaces of a single node)

Use this command to move data for selected file spaces belonging to a single node.

### Privilege class

To issue this command, you must have system privilege, unrestricted storage privilege, or restricted storage privilege for the source storage pool. If your authorization is restricted storage privilege and you intend to move data to another storage pool, you must also have the appropriate authority for the destination storage pool.

### Syntax

```
>>-MOVE NODEdata--node_name--FROMstgpool---source_pool_name-->
>--+-----+----->
  '-Tostgpool---destination_pool_name-'
>--+-----+----->
  |           .-,------. |
  |           v              | |
  '-Filespace-----file_space_name--+'
>--+-----+----->
  |           .-,------. |
  |           v              | |
  '-UNIFILESpace-----unicode_filespace_name--+'
>--+-----+----->
  |           .-,------. |
  |           v              | |
```

```

'-FSID-----filesystem_identifier+-'

.-Type----ANY-----
>-----+----->
'-Type-----+ANY-----+
      +-Backup-----+
      +-ARchive-----+
      '-SPacemanaged-'

.-MAXPRocess-----1----- .-Wait---No-----
>-----+----->
'-MAXPRocess-----num_processes-' '-Wait---+No--+-'
                                     '-Yes-'

                                     (1)
.-RECONStruct-----No or Yes-----
>-----+----->>
'-RECONStruct-----+No--+-----'
                                     '-Yes-'

```

Notes:

1. The default is NO if either the source or target storage pool is random access. The default is YES if both the source and target storage pools are sequential access.

## Parameters

---

node\_name (Required)

Specifies the node name related to the data that is moved with this command. Separate multiple names with commas and no intervening spaces. You can use wildcard characters to specify names.

FROMstgpool (Required)

Specifies the name of a sequential-access storage pool that contains data to be moved. This storage pool must be in the NATIVE or NONBLOCK data format.

TOstgpool

Specifies the name of a storage pool to which data will be moved. This storage pool must be in the NATIVE or NONBLOCK data format. This parameter is optional and does not apply when the source storage pool is a copy storage pool or an active-data pool. That is, if the source storage pool is a copy storage pool the destination must be the same copy storage pool. Similarly, if the source storage pool is an active-data pool, the destination must be the same active-data pool. If a value is not specified, data is moved to other volumes within the source pool.

Important: If you are moving data within the same storage pool, there must be volumes available that do not contain the node data you are moving. That is, the server cannot use volumes that contain the data to be moved as destination volumes.

FILEspace

Specifies the name of the non-Unicode filesystem that contains data to be moved. Separate multiple names with commas and no intervening spaces. You can use wildcard characters to specify names. This parameter is optional. If you do not specify a value for this parameter and values for UNIFILESPACE or the FSID or both, non-Unicode file spaces are not moved.

UNIFILESpace

Specifies the name of the Unicode filesystem that contains data to be moved. Separate multiple names with commas and no intervening spaces. You can use wildcard characters to specify names. This parameter is optional. If you do not specify a value for this parameter and values for FILESPACE or the FSID or both, non-Unicode file spaces are not moved.

FSID

Specifies file space identifiers (FSIDs) for the file spaces to be moved. Separate multiple names with commas and no intervening spaces. This parameter is optional.

Type

Specifies the type of files to be moved. This parameter is optional. The default value is ANY. If the source storage pool is an active-data pool, the only valid values are ANY and BACKUP. However, only the active versions of backup data are moved if TYPE=ANY. Possible values are:

ANY

Specifies that all types of files are moved.

Backup

Specifies that backup files are moved.

ARchive

Specifies that archive files are moved. This value is not valid for active-data pools.

#### SPacemanaged

Specifies that space-managed files (files that were migrated by an IBM Spectrum Protect™ for Space Management client) are moved. This value is not valid for active-data pools.

#### MAXPRocess

Specifies the maximum number of parallel processes to use for moving data. This parameter is optional. You can specify a value from 1–999, inclusive. The default value is 1. Increasing the number of parallel processes should improve throughput.

When determining this value, consider the number of logical and physical drives that can be dedicated to this operation. To access a sequential access volume, IBM Spectrum Protect uses a mount point and, if the device type is not FILE, a physical drive. The number of available mount points and drives depends on other IBM Spectrum Protect system activity and on the mount limits of the device classes for the sequential access storage pools that are involved in the move. Each process needs a mount point for storage pool volumes, and, if the device type is not FILE, each process also needs a drive.

#### Wait

Specifies whether to wait for the server to complete processing this command in the foreground. This parameter is optional. The default value is No. Possible values are:

##### No

Specifies that the server processes this command in the background. You can continue with other tasks while the command is being processed.

The server displays messages that are created from the background process either in the activity log or the server console, depending on where messages are logged.

To cancel a background process, use the CANCEL PROCESS command. If a background process is canceled, some files may have already moved before the cancellation.

##### Yes

Specifies that the server processes this command in the foreground. You wait for the command to complete before continuing with other tasks. The server then displays the output messages to the administrative client when the command completes.

Restriction: You cannot specify WAIT=YES from the server console.

#### RECONStruct

Specifies whether to reconstruct file aggregates during data movement. Reconstruction removes empty space that has accumulated during deletion of logical files from an aggregate. This parameter is optional. If both the source and target storage pools are sequential access, the default value is YES. If either the source or target storage pool is random access, the default is NO.

The parameter is not available or is ignored if any of the following conditions are true:

- The data format is NETAPPDUMP, CELERRADUMP, or NDMPDUMP.
- The data is in a storage pool that is configured for data deduplication.
- The target storage pool for the data movement is configured for data deduplication.

Attention: Reconstruction removes inactive backup files in active-data pools. If you specify RECONSTRUCT=NO when moving the data in an active-data pool that is not configured for data deduplication, inactive backup files remain in the storage pool.

Possible values are:

##### No

Specifies that reconstruction of file aggregates will not be performed during the move.

##### Yes

Specifies that reconstruction of file aggregates will be performed during the move. You may only specify this option when both the source and the target storage pools are sequential-access.

## Example: Move a node's non-Unicode and Unicode data

---

Move data for node TOM in storage pool TAPEPOOL. Restrict movement of data to files in non-Unicode file spaces as well as Unicode file spaces, \\jane\d\$. Data should be moved to disk storage pool BACKUPPOOL.

```
move nodedata tom
  fromstgpool=tapepool tostgpool=backuppool
  filespace=* unifilespace=\\jane\d$
```

## Example: Move all node data from tape storage pools to a disk storage pool

---

Move all data for node SARAH, from all primary sequential-access storage pools (for this example, TAPEPOOL\*) to DISKPOOL. To obtain a list of storage pools that contain data for node SARAH, issue either of the following QUERY OCCUPANCY or SELECT commands:

```
query occupancy sarah

SELECT * from OCCUPANCY where node_name='sarah'
```

Attention: For this example assume that the results were TAPEPOOL1, TAPEPOOL4, and TAPEPOOL5.

```
move nodedata sarah
  fromstgpool=tapepool1 tostgpool=DISKPOOL

move nodedata sarah
  fromstgpool=tapepool4 tostgpool=DISKPOOL

move nodedata sarah
  fromstgpool=tapepool5 tostgpool=DISKPOOL
```

## Example: Move a node's non-Unicode and Unicode file spaces

---

The following is an example of moving non-Unicode and Unicode file spaces for a node. For node NOAH move non-Unicode filesystem \\servtuc\d\$ and Unicode file space \\tmserv1\e\$ that has a filesystem ID of 2 from sequential access storage pool TAPEPOOL to random access storage pool DISKPOOL.

```
move nodedata noah
  fromstgpool=tapepool tostgpool=diskpool
  filesystem=\\tmserv1\d$ fsid=2
```

## NOTIFY SUBSCRIBERS (Notify managed servers to update profiles)

---

Use this command on a configuration manager to notify one or more managed servers to request that their configuration information be immediately refreshed.

### Privilege class

---

To issue this command, you must have system privilege.

### Syntax

---

```
>>-NOTIFY SUBSCRIBERS-+-PROFILE-----*-----+-----><
|           .-./------. |
|           V               | |
|'-PROFILE-----profile_name-+-'
```

### Parameters

---

#### PROFILE (Required)

Specifies the name of the profile. Any managed servers that subscribe to the profile are notified. You can use wildcard characters to specify multiple profiles. To specify multiple profiles, separate the names with commas and no intervening spaces. The default is to notify all subscribers.

## Example: Notify managed servers to update profiles

---

Notify all managed servers that subscribe to a profile named DELTA to request updated configuration information.

```
notify subscribers profile=delta
```

### Related commands

---

Table 1. Commands related to NOTIFY SUBSCRIBERS

Command	Description
DEFINE SUBSCRIPTION	Subscribes a managed server to a profile.
DELETE SUBSCRIBER	Deletes obsolete managed server subscriptions.
DELETE SUBSCRIPTION	Deletes a specified profile subscription.
QUERY SUBSCRIBER	Displays information about subscribers and their subscriptions to profiles.
QUERY SUBSCRIPTION	Displays information about profile subscriptions.
SET CONFIGMANAGER	Specifies whether a server is a configuration manager.
SET CONFIGREFRESH	Specifies a time interval for managed servers to contact configuration managers.

## PERFORM LIBACTION (Define or delete all drives and paths for a library)

Use this command to define or delete all drives and their paths for a single library in one step.

This command can be used when you set up a library environment or modify an existing hardware setup that requires changes to many drive definitions. After you define a library, issue PERFORM LIBACTION to define drives and their paths for the library. You can also delete all drives and paths for a library by issuing the command with ACTION=DELETE.

This command is only valid for library types of SCSI and VTL. To use this command with ACTION=DEFINE, the SANDISCOVERY option must be supported and enabled.

For detailed and current library support information, see the Supported Devices website for your operating system:

- **AIX** | **Windows** Supported devices for AIX and Windows
- **Linux** Supported devices for Linux

### Privilege class

To issue this command, you must have system privilege or unrestricted storage privilege.

### Syntax

```
>>-PERForm LIBACTioN--library_name----->
>----ACTioN---+--DEFine--| A |+----->
          +-DELeTe-----+
          +-RESet--| B |--+
          '-QUIesce-----'

          .-PREView----No-----
>--+-----+-----+-----><
  '-SOURCe---source_name-' '-PREView---+--Yes+-'
                               '-No--'

A (DEFine)

|--+-----+----->
  '-DEVIce---library_device_name-'

  .-PREFix---library_name-----
>--+-----+-----|
  '-PREFix---drive_prefix_name-'

B (RESet)

          .-DRIVEsonly---No-----
|----ACTioN---RESet-----+-----|
          '-DRIVEsonly---+--Yes+-'
```



## Parameters

---

### library\_name (Required)

Specifies the name of the library to be defined or deleted. The maximum length of this name is 30 characters unless you are issuing PERFORM LIBACTION with ACTION=DEFINE and using the default PREFIX value. In that case, the maximum length of the name is 25 characters.

### ACTion

Specifies the action for the PERFORM LIBACTION command. Possible values are:

#### DEFine

Specifies that drives and their paths are defined for the specified library. SAN discovery must be enabled before you specify this parameter value.

#### DELete

Specifies that drives and their paths are deleted for the specified library.

#### RESet

Specifies that drives and their paths are updated online for the specified library.

#### DRIVEsonly

Specifies that only drives are updated online for the specified library.

Possible values are:

##### No

Specifies that drives and paths are updated online.

##### Yes

Specifies that only drives are updated online.

#### QUIesce

Specifies that drives are updated offline.

### DEVIce

Specifies the library device name that is used when you define paths if a path to the library is not already defined. If a path is already defined, the DEVICE parameter is ignored. The maximum length for this value is 64 characters. This parameter is optional.

### PREFix

Specifies the prefix that is used for all drive definitions. For example, a PREFIX value of *DR* creates drives *DR0*, *DR1*, *DR2*, for as many drives as are created. If a value is not specified for the PREFIX parameter, the library name is used as the prefix for drive definitions. The maximum length for this value is 25 characters.

### SOURCE

Specifies the source server name to be used when you define or delete drive path definitions on a library client or LAN-free client. Use this parameter only if the drives in the library are set up for the local server. If no value is specified for the SOURCE parameter, the local server name, which is the default, is used. The maximum length for the source name is 64 characters.

If you specify the SOURCE parameter, you can RESET only paths from specified SOURCE values. The SOURCE parameter is not compatible with the RESET DRIVESONLY=YES or QUIESCE options.

If a source name other than the local server name is specified with ACTION=DEFINE, drive path definitions are defined with the token value of UNDISCOVERED. The path definitions are then updated dynamically by library clients that support SAN Discovery the first time the drive is mounted.

### PREView

Specifies the output of all commands that are processed for PERFORM LIBACTION before the command is issued. The PREVIEW parameter is not compatible with the DEVICE parameter. If you are issuing the PERFORM LIBACTION command to define a library, you cannot specify both the PREVIEW and the DEVICE parameter.

Possible values are:

#### No

Specifies that a preview of the commands that are issued for PERFORM LIBACTION is not displayed.

#### Yes

Specifies that a preview of the commands that are issued for PERFORM LIBACTION is displayed.

## Example: Define a shared library

---

Assume that you are working in a SAN and that you configured a library manager named LIBMGR1. Now, define a library that is named SHAREDTSM to a library client server named LIBCL1.

Issue DEFINE LIBRARY from the library client server, LIBCL1:

```
define library sharedtsm libtype=shared primarylibmanager=libmgr1
```

Then, issue PERFORM LIBACTION from the library manager, LIBMGR1, to define the drive paths for the library client:

```
perform libaction sharedtsm action=define source=libcl1
```

Note: The SANDISCOVERY option must be supported and enabled on the library client server.

## Example: Define a library with four drives

---

Define a SCSI library named KONA:

```
define library kona libtype=scsi
```

Then issue the PERFORM LIBACTION command to define drives and paths for the library:

**AIX**

```
perform libaction kona action=define device=/dev/lb3  
prefix=dr
```

The server then runs the following commands:

```
define path server1 kona srct=server destt=library  
device=/dev/lb3  
define drive kona dr0  
define path server1 dr0 srct=server destt=drive library=kona  
device=/dev/mt1  
define drive kona dr1  
define path server1 dr1 srct=server destt=drive library=kona  
device=/dev/mt2  
define drive kona dr2  
define path server1 dr2 srct=server destt=drive library=kona  
device=/dev/mt3  
define drive kona dr3  
define path server1 dr3 srct=server destt=drive library=kona  
device=/dev/mt4
```

**Linux**

```
perform libaction kona action=define device=/dev/tmscsi/lb3  
prefix=dr
```

The server then runs the following commands:

```
define path server1 kona srct=server destt=library  
device=/dev/tmscsi/lb3  
define drive kona dr0  
define path server1 dr0 srct=server destt=drive library=kona  
device=/dev/tmscsi/mt1  
define drive kona dr1  
define path server1 dr1 srct=server destt=drive library=kona  
device=/dev/tmscsi/mt2  
define drive kona dr2  
define path server1 dr2 srct=server destt=drive library=kona  
device=/dev/tmscsi/mt3  
define drive kona dr3  
define path server1 dr3 srct=server destt=drive library=kona  
device=/dev/tmscsi/mt4
```

**Windows**

```
perform libaction kona action=define device=lb0.0.0.2  
prefix=dr
```

The server then runs the following commands:

```

define path server1 kona srct=server destt=library
device=lb0.0.0.2
define drive kona dr0
define path server1 dr0 srct=server destt=drive library=kona
device=mt0.1.0.2
define drive kona dr1
define path server1 dr1 srct=server destt=drive library=kona
device=mt0.2.0.2
define drive kona dr2
define path server1 dr2 srct=server destt=drive library=kona
device=mt0.3.0.2
define drive kona dr3
define path server1 dr3 srct=server destt=drive library=kona
device=mt0.4.0.2

```

## Related commands

Table 1. Commands related to PERFORM LIBACTION

Command	Description
AUDIT LIBRARY	Ensures that an automated library is in a consistent state.
DEFINE DRIVE	Assigns a drive to a library.
DEFINE LIBRARY	Defines an automated or manual library.
DEFINE PATH	Defines a path from a source to a destination.
DEFINE SERVER	Defines a server for server-to-server communications.
DELETE DRIVE	Deletes a drive from a library.
DELETE LIBRARY	Deletes a library.
DELETE PATH	Deletes a path from a source to a destination.
QUERY DRIVE	Displays information about drives.
QUERY LIBRARY	Displays information about one or more libraries.
QUERY PATH	Displays information about the path from a source to a destination.
UPDATE DRIVE	Changes the attributes of a drive.
UPDATE LIBRARY	Changes the attributes of a library.
UPDATE PATH	Changes the attributes associated with a path.

## PING SERVER (Test the connection between servers)

Use this command to test the connection between the local server and a remote server.

Important: The name and password of the administrator client issuing this command must also be defined on the remote server. If the remote server is at the current level, the server credentials are verified automatically when you run the PING SERVER command. If the remote server is not at the current level, the server credentials are not verified.

### Privilege class

To issue this command, you must have system privilege.

### Syntax

```
>>-PING SERVER--server_name-----<<
```

### Parameters

server\_name (Required)

Specifies the name of the remote server.

## Example: Ping a server

Test the connection to server FRED.

```
ping server fred
```

## Related commands

Table 1. Commands related to PING SERVER

Command	Description
DEFINE SERVER	Defines a server for server-to-server communications.
QUERY SERVER	Displays information about servers.

## PREPARE (Create a recovery plan file)

Use this command to create a recovery plan file, which contains the information that is needed to recover an IBM Spectrum Protect™ server. You can store a recovery plan file on a file system that is accessible to the source server or on a target server.

You can use the QUERY ACTLOG command to view whether the PREPARE command was successful.

You can also view this information from the server console or, if the WAIT parameter equals YES, an administrative client session.

## Privilege class

To issue this command, you must have system privilege.

## Syntax

```

      .-Source-----DBBackup-----.
>>-Prepare-----+-----+----->
      '-Source-----+DBBackup---+-'
              '-DBSnapshot-'

>--+-----+----->
      '-DEVclass-----device_class_name-'

>--+-----+-----+----->
      '-PLANPrefix-----prefix-' '-INSTRPrefix-----prefix-'

>--+-----+----->
      |               .-,------. |
      |               V           | |
      '-COPYstgpool-----pool_name+-'

>--+-----+-----+----->
      |               .-,------. |
      |               V           | |
      '-ACTIVEDatastgpool-----pool_name+-'

      .-Wait-----No-----.
>--+-----+-----+-----><
      |               .-,------. | '-Wait-----+No---+'
      |               V           | |           '-Yes-'
      '-PRIMstgpool-----pool_name+-'
```

## Parameters

Source

Specifies the type of database backup series that IBM Spectrum Protect assumes when generating the recovery plan file. This parameter is optional. The default is DBBACKUP. The choices are:

#### DBBackup

Specifies that IBM Spectrum Protect assumes the latest full database backup series.

#### DBSnapshot

Specifies that IBM Spectrum Protect assumes the latest database snapshot backup series.

#### DEVclass

Specifies the device class name that is used to create a recovery plan file object on a target server. The device class must have a device type of SERVER.

Important: The maximum capacity for the device class must be larger than the size of the recovery plan file. If the size of the recovery plan file exceeds the maximum capacity, the command fails.

The naming convention for the archive object that contains the recovery plan file on the target server is:

- **Filespace name:**
  - ADSM.SERVER
- **High-level qualifier:**
  - **AIX** | **Linux** devclassprefix/servername.yyyymmdd.hhmmss
  - **Windows** devclassprefix\servername.yyyymmdd.hhmmss
- **Low-level qualifier:**
  - RPF.OBJ.1

The recovery plan file virtual volume name as recorded in the volume history table on the source server is in the format `servername.yyyymmdd.hhmmss`.

If the DEVCLASS parameter is not specified, the recovery plan file is written to a file based on the plan prefix.

If SOURCE=DBBACKUP is specified or is defaulted to, the volume history entry for the recovery plan file object specifies a volume type of RPFIL. If SOURCE=DBSNAPSHOT is specified, the volume history entry specifies a volume type of RPFNSNAPSHOT.

#### PLANPrefix

Specifies the path name prefix that is used in the recovery plan file name. This parameter is optional.

- **AIX** | **Linux** The maximum length is 250 characters.
- **Windows** The maximum length is 200 characters.

**Windows** Specifies the path name prefix that is used in the recovery plan file name.

IBM Spectrum Protect appends to the prefix the sortable date and time format `yyymmdd.hhmmss`. For example: 20081115.051421.

**AIX** | **Linux** The prefix can be one of the following:

#### Directory path

End the prefix with the forward slash (/). For example:

```
PLANPREFIX=/admsrv/recplans/
```

The resulting file name would look like this:

```
/admsrv/recplans/20081115.051421
```

#### Directory path followed by a string

IBM Spectrum Protect treats the string as part of the file name. For example:

```
PLANPREFIX=/admsrv/recplans/accounting
```

The resulting file name looks like this:

```
/admsrv/recplans/accounting.20081115.051421
```

Note the period before the date and time.

#### String only

IBM Spectrum Protect specifies the directory path. IBM Spectrum Protect uses the name of the current working directory. For example, the current working directory is `/opt/tivoli/tsm/server/bin` and you specify the following parameter:

```
PLANPREFIX=shipping
```

The resulting file name looks like this:

```
/opt/tivoli/tsm/server/bin/shipping.20081115.051421
```

Note the period before the date and time.

**Windows** The prefix can be one of the following:

#### Directory path

End the prefix with the back slash (\). For example:

```
PLANPREFIX=c:\admsrv\recplans\
```

The resulting file name looks like this:

```
c:\admsrv\recplans\20081115.051421
```

Tip: If you issue the PREPARE command from the administrative command line client and the last character in the command line is a back slash, it is interpreted as a continuation character. To avoid this, place the prefix value in double quotation marks. For example:

```
PLANPREFIX="c:\admsrv\recplans\"
```

#### Directory path followed by a string

IBM Spectrum Protect treats the string as part of the file name. For example:

```
PLANPREFIX=c:\admsrv\recplans\accounting
```

The resulting file name looks like this:

```
c:\admsrv\recplans\accounting.20081115.051421
```

Note the period before the date and time.

#### String only

IBM Spectrum Protect appends the date and time in the *.yyyymmdd.hhmmss* format (note the period before the date and time) to the prefix. The directory path used by the PREPARE command is the directory representing this “instance” of the IBM Spectrum Protect server. Typically, this directory is the original IBM Spectrum Protect server installation directory. For example, the directory representing this instance of the server is *c:\Program Files\Tivoli\TSM;\server2*, and you issue a PREPARE command with the following parameter:

```
PLANPREFIX=shipping
```

The resulting recovery plan filename is:

```
c:\Program Files\Tivoli\TSM;\server2\shipping.20081115.051421
```

If the PLANPREFIX parameter is not specified, IBM Spectrum Protect selects the prefix in one of these ways:

- If the SET DRMPREFIX command has been issued, IBM Spectrum Protect uses the prefix specified in that command.
- **Windows** If the SET DRMPREFIX command is not defined, IBM Spectrum Protect uses as the path the directory representing this “instance” of the IBM Spectrum Protect server, which is typically the original IBM Spectrum Protect server installation directory. For example, the directory representing this instance of the server is the following:

```
c:\Program Files\Tivoli\TSM;\server2
```

The resulting recovery plan file name is the following:

```
c:\Program Files\Tivoli\TSM;\server2\20081115.051421
```

- **AIX Linux** If the SET DRMPREFIX command has not been issued, IBM Spectrum Protect uses the directory path name of the current working directory. For example, the current working directory is the following:

```
/opt/tivoli/tsm/server/bin
```

The resulting file name looks like this:

```
/opt/tivoli/tsm/server/bin/20081115.051421
```

INSTRPrefix

Specifies the prefix of the path name used by IBM Spectrum Protect to locate the files that contain the recovery instructions. The maximum length is **AIX** 250 **Linux** 250 **Windows** 200 characters.

**AIX** **Linux** The prefix can be one of the following:

#### Directory path

End the prefix with the forward slash (/). For example:

```
INSTRPREFIX=/admsrv/recinstr/  
  
/admsrv/recinstr/RECOVERY.INSTRUCTIONS.GENERAL
```

#### Directory path followed by a string

IBM Spectrum Protect treats the string as part of the file name. For example:

```
INSTRPREFIX=/admsrv/recinstr/accounts
```

IBM Spectrum Protect appends the appropriate recovery plan file stanza name. For the RECOVERY.INSTRUCTIONS.GENERAL file, the resulting file name is:

```
/admsrv/recinstr/accounts.RECOVERY.INSTRUCTIONS.GENERAL
```

#### String only

- IBM Spectrum Protect specifies the directory path and appends the appropriate recovery plan file stanza name. IBM Spectrum Protect uses the name of the current working directory. For example, the current working directory is /opt/tivoli/tsm/server/bin and you specify the following parameter:

```
INSTRPREFIX=shipping
```

For the RECOVERY.INSTRUCTIONS.GENERAL file, the resulting file name looks like this:

```
/opt/tivoli/tsm/server/bin/shipping.RECOVERY.INSTRUCTIONS.GENERAL
```

**Windows** The prefix can be one of the following:

#### Directory path

End the prefix with the back slash (\). For example:

```
INSTRPREFIX=c:\admsrv\recinstr\
```

IBM Spectrum Protect appends the appropriate recovery plan file stanza name. For the RECOVERY.INSTRUCTIONS.GENERAL file, the resulting file name is:

```
c:\admsrv\recinstr\RECOVERY.INSTRUCTIONS.GENERAL
```

Tip: If you issue the PREPARE command from the administrative command line client and the last character in the command line is a back slash, it is interpreted as a continuation character. To avoid this, place the prefix value in double quotation marks. For example:

```
INSTRPREFIX="c:\admserv\recinstr\"
```

#### Directory path followed by a string

IBM Spectrum Protect treats the string as part of the file name. For example:

```
INSTRPREFIX=c:\admsrv\recinstr\accounts
```

IBM Spectrum Protect appends the appropriate recovery plan file stanza name. For the RECOVERY.INSTRUCTIONS.GENERAL file, the resulting file name is:

```
c:\admsrv\recinstr\accounts.RECOVERY.INSTRUCTIONS.GENERAL
```

#### String only

IBM Spectrum Protect specifies the directory path and appends the appropriate recovery plan file stanza name. IBM Spectrum Protect appends the recovery plan file stanza name to the prefix. If the prefix is only a string, the directory path used by the PREPARE command is the directory representing this instance of the IBM Spectrum Protect server. This is typically the original IBM Spectrum Protect server installation directory. For example, the directory representing this instance of the server is c:\Program Files\Tivoli\TSM;\server2, and you issue a PREPARE command with the following parameter:

```
INSTRPREFIX=dock
```

The resulting recovery plan filename is:

```
c:\Program Files\Tivoli\TSM;\server2\shipping.20081115.051421
```

If you do not specify the INSTRPREFIX parameter, IBM Spectrum Protect selects the prefix in one of these ways:

- If the SET DRMINSTRPREFIX command has been issued, IBM Spectrum Protect uses the prefix specified in that command.
- **Windows** If the SET DRMINSTRPREFIX command has not been issued, IBM Spectrum Protect uses as the path the directory representing this “instance” of the IBM Spectrum Protect server, which is typically the original server installation directory. For example, the directory representing this instance of the server is the following:

```
c:\Program Files\Tivoli\TSM;\server2
```

The resulting recovery plan file name is the following:

```
c:\Program Files\Tivoli\TSM;\server2\RECOVERY.INSTRUCTIONS.GENERAL
```

- **AIX | Linux** If the SET DRMINSTRPREFIX command has not been issued, IBM Spectrum Protect uses the current working directory. For example, if the current working directory is /opt/tivoli/tsm/server/bin, for the RECOVERY.INSTRUCTIONS.GENERAL file, the resulting file name would be:

```
/opt/tivoli/tsm/server/bin/RECOVERY.INSTRUCTIONS.GENERAL
```

#### PRIMstgpool

Specifies the names of the primary storage pools that you want to restore. Separate the storage pool names with commas and no intervening spaces. You can use wildcard characters. If this parameter is not specified, IBM Spectrum Protect selects the storage pools as follows:

- If the SET DRMPRIMSTGPOOL command has been issued, IBM Spectrum Protect includes the primary storage pools named in that command.
- If the SET DRMPRIMSTGPOOL command has not been issued, IBM Spectrum Protect includes all the primary storage pools.

#### COPYstgpool

Specifies the names of the copy storage pools used to back up the primary storage pools that you want to restore (see the PRIMSTGPOOL parameter). Separate storage pool names with commas and no intervening spaces. You can use wildcard characters. If this parameter is not specified, IBM Spectrum Protect selects the storage pools as follows:

- If the SET DRMCOPYSTGPOOL command has been issued, IBM Spectrum Protect includes those copy storage pools.
- If the SET DRMCOPYSTGPOOL command has not been issued, IBM Spectrum Protect includes all copy storage pools.

#### ACTIVEDatastgpool

Specifies the names of the active-data storage pools that you want to have available for offsite access. Separate active-data storage-pool names with commas and no intervening spaces. You can use wildcard characters. If this parameter is not specified, IBM Spectrum Protect selects the storage pools as follows:

- If the SET ACTIVEDATASTGPOOL command has been previously issued with valid active-data storage pool names, IBM Spectrum Protect processes those storage pools.
- If the SET ACTIVEDATASTGPOOL command has not been issued, or all of the active-data storage pools have been removed using the SET ACTIVEDATASTGPOOL command, IBM Spectrum Protect processes only the active-data pool volumes that were marked on-site at the time the PREPARE command is run. IBM Spectrum Protect will mark these volumes as UNAVAILABLE.

#### Wait

Specifies whether this command is processed in the background or foreground.

No

Specifies background processing. This is the default.

Yes

Specifies foreground processing.

**AIX | Linux** You cannot specify YES from the server console.

## Example: Create a recovery plan file

---



Issue the PREPARE command and query the activity log to check the results.

```
prepare
query actlog search=prepare
```

**AIX** | **Linux**

```
05/03/2008 12:01:13 ANR0984I Process 3 for PREPARE started in the
BACKGROUND at 12:01:13.
05/03/2008 12:01:13 ANR6918W PREPARE: Recovery instructions file
/home/guest/drmtest/prepare/tserver/DSM1509/
RECOVERY.INSTRUCTIONS.DATABASE not found.
05/03/2008 12:01:13 ANR6918W PREPARE: Recovery instructions file
/home/guest/drmtest/prepare/tserver/DSM1509/
RECOVERY.INSTRUCTIONS.STGPOOL not found.
05/03/2008 12:01:13 ANR6913W PREPARE: No volumes with backup data
exist in copy storage pool CSTORAGEP.
05/03/2008 12:01:13 ANR6913W PREPARE: No volumes with backup data
exist in copy storage pool CSTORAGEPSM.
05/03/2008 12:01:14 ANR6920W PREPARE: Generated replacement volume
name BACK4X@ is not valid for device type
8MM. Original volume name: BACK4X. Stanza is
PRIMARY.VOLUMES.REPLACEMENT macro.
05/03/2008 12:01:14 ANR6900I PREPARE: The recovery plan file
/home/guest/drmtest/prepare/plandir/DSM1509/
r.p.20080503.120113 was created.
05/03/2008 12:01:14 ANR0985I Process 3 for PREPARE running in the
BACKGROUND completed with completion state
SUCCESS at 12:01:14.
```

**Windows**

```
05/03/2008 12:01:13 ANR0984I Process 3 for PREPARE started in the
BACKGROUND at 12:01:13.
05/03/2008 12:01:13 ANR6918W PREPARE: Recovery instructions file
c:\drmtest\prepare\RECOVERY.INSTRUCTIONS.DATABASE
not found.
05/03/2008 12:01:13 ANR6918W PREPARE: Recovery instructions file
c:\drmtest\prepare\RECOVERY.INSTRUCTIONS.STGPOOL
not found.
05/03/2008 12:01:13 ANR6913W PREPARE: No volumes with backup data
exist in copy storage pool CSTORAGEP.
05/03/2008 12:01:13 ANR6913W PREPARE: No volumes with backup data
exist in copy storage pool CSTORAGEPSM.
05/03/2008 12:01:14 ANR6920W PREPARE: Generated replacement volume
name BACK4X@ is not valid for device class 8MM.
Original volume name: BACK4X. Stanza is
PRIMARY.VOLUMES.REPLACEMENT macro.
05/03/2008 12:01:14 ANR6900I PREPARE: The recovery plan file
c:\drmtest\prepare\r.p.20080503.120113
was created.
05/03/2008 12:01:14 ANR0985I Process 3 for PREPARE running in the
BACKGROUND completed with completion state
SUCCESS at 12:01:14.
```

**Related commands**

Table 1. Commands related to PREPARE

Command	Description
CANCEL PROCESS	Cancels a background server process.
DELETE VOLHISTORY	Removes sequential volume history information from the volume history file.
QUERY DRMSTATUS	Displays DRM system parameters.
QUERY RPFCONTENT	Displays the contents of a recovery plan file.
QUERY RPFFILE	Displays information about recovery plan files.
QUERY SERVER	Displays information about servers.

Command	Description
QUERY VOLHISTORY	Displays sequential volume history information that has been collected by the server.
SET DRMACTIVEDATASTGPOOL	Specifies that active-data storage pools are managed by DRM.
SET DRMCOPYSTGPOOL	Specifies that copy storage pools are managed by DRM.
SET DRMINSTRPREFIX	Specifies the prefix portion of the path name for the recovery plan instructions.
SET DRMPLANVPOSTFIX	Specifies the replacement volume names in the recovery plan file.
SET DRMPLANPREFIX	Specifies the prefix portion of the path name for the recovery plan.
SET DRMPRIMSTGPOOL	Specifies that primary storage pools are managed by DRM.
SET DRMRPFEXPIREDDAYS	Set criteria for recovery plan file expiration.
UPDATE VOLHISTORY	Adds or changes location information for a volume in the volume history file.

AIX Linux Windows

## PROTECT STGPOOL (Protect data that belongs to a storage pool)

Use this command to protect data in a directory-container storage pool by storing a copy of the data in another storage pool on a replication target server or on the same server by protecting the data to tape. When you protect the directory-container storage pool, you can later try to repair damage in the storage pool by using the REPAIR STGPOOL command.

When you issue the PROTECT STGPOOL command for a directory-container storage pool, data that is stored in that storage pool is backed up to the target that you specify. The data can be backed up to the following target types:

- A directory-container storage pool on the target replication server.  
Prerequisite: For the storage pool that is being protected, you must specify the target pool by using the PROTECTSTGPOOL parameter on the DEFINE STGPOOL or UPDATE STGPOOL command.

When you regularly use the PROTECT STGPOOL command, you can typically reduce the processing time for the REPLICATE NODE command. The data extents that are already copied to the target replication server by storage pool protection operations are skipped when node replication is started.

As part of the PROTECT STGPOOL operation, processes might run to repair damaged extents in the target server's storage pool. The repair operation occurs under the following conditions:

- Both the source server and the target server must be at V7.1.5 or later.
- Extents that are already marked as damaged on the target server are repaired. The repair process does not run an audit process to identify damage.
- Only target extents that match source extents are repaired. Target extents that are damaged but have no match on the source server are not repaired.

Limitations: The repair operation that runs as part of the PROTECT STGPOOL operation has the following limitations:

- Extents that belong to objects that were encrypted are not repaired.
- The timing of the occurrence of damage on the target storage pool and the sequence of REPLICATE NODE and PROTECT STGPOOL commands can affect whether the repair process is successful. Some extents that were stored in the target storage pool by a REPLICATE NODE command might not be repaired.

- Container-copy storage pools on the same server, protected to tape.  
Prerequisite: For the storage pool that is being protected, you must specify the target storage pool by using the PROTECTLOCALSTGPOLLS parameter. For details about the parameter, see the commands for defining and updating directory-container storage pools (DEFINE STGPOOL and UPDATE STGPOOL commands).

As part of the PROTECT STGPOOL operation, volumes in the target pool might be reclaimed. The value of the RECLAIM parameter for the container-copy storage pool affects whether volumes are reclaimed. For details about the parameter, see the commands for defining and updating container-copy storage pools (DEFINE STGPOOL and UPDATE STGPOOL commands).

Restriction: You cannot schedule multiple PROTECT STGPOOL operations to run concurrently. Wait for one PROTECT STGPOOL operation to finish before you start another.

## Privilege class

To issue this command, you must have system privilege.

## Syntax when the target is the replication server

```
>>-PROTECT STGPool--source_stgpool--Type---Replserver-
                                     .-Type---Replserver-.
                                     +-----+-----+----->
                                     '-Type---Replserver-'

    .-FORCEReconcile---No-----
>+-----+-----+-----+-----+-----+----->
    '-FORCEReconcile---No---+'
                                     '-Yes-'

                                     (1)

    .-MAXSESSions---10-----
>+-----+-----+-----+-----+-----+----->
    '-MAXSESSions---number_sessions--'

    .-Preview---No----- .-PURGEdata---No-----
>+-----+-----+-----+-----+-----+----->
    '-Preview---No---+' '-PURGEdata---No---+'
                                     '+-All-----+'
                                     '-Deleted-'

    .-Wait---No----- .-TRANSFERMethod---Tcip-----
>+-----+-----+-----+-----+-----+----->>
    '-Wait---No---+' | '-TRANSFERMethod---Tcip---+' (2) |
                                     '-Fasp--'
                                     '+-Fasp--'
```

Notes:

1. **Linux** If the TRANSFERMETHOD parameter is set to the default value of TCPIP, the default value of the MAXSESSIONS parameter is 10. If the TRANSFERMETHOD parameter is set to FASP, the default value of the MAXSESSIONS parameter is 2.
2. **Linux** The TRANSFERMETHOD parameter is available only on Linux x86\_64 operating systems.

## Syntax when the target is a tape storage pool on the same server

```
>>-PROTECT STGPool--source_stgpool--Type---Local----->

    .-Preview---No----- .-RECLaim---Yes-----
>+-----+-----+-----+-----+-----+----->
    '-Preview---No---+' '-RECLaim---Yes-----+'
                                     '+-No-----+'
                                     '+-Only-----+'
                                     '+-YESLIMited---+'
                                     '-ONLYLIMited-'

    .-Wait---No-----
>+-----+-----+-----+-----+-----+----->>
    '-Wait---No---+'
                                     '-Yes-'
```

## Parameters

source\_stgpool (Required)

Specifies the name of the directory-container storage pool on the source server.

Type

Specifies the type of target for the protection operation. This parameter is optional. The default value is REPLSERVER. Specify one of the following values:

Replserver

Specifies that the target is the storage pool on the replication target server, as defined for the source storage pool with the PROTECTSTGPOOL parameter on the DEFINE STGPOOL or UPDATE STGPOOL command.

#### Local

Specifies that the target is on the same server as the source storage pool. The target is the container-copy storage pool that is defined for the source storage pool with the PROTECTLOCALSTGPOOLS parameter on the DEFINE STGPOOL or UPDATE STGPOOL command.

Tip: By default, the server uses a maximum of two parallel processes to copy data to a local target. You can change the maximum number of parallel processes by updating the container-copy storage pool that is the target. Use the UPDATE STGPOOL command with the PROTECTPROCESS parameter.

#### FORCEREconcile

Specifies whether to reconcile the differences between data extents in the directory-container storage pool on the source server and target server. This parameter is optional. The default value is NO. Specify one of the following values:

#### No

Specifies that data backup does not compare all data extents in the directory-container storage pool on the source server with data extents on the target server. Instead, data backup tracks changes to the data extents on the source server since the last backup and synchronizes these changes on the target server.

#### Yes

Specifies that data backup compares all data extents on the source server with data extents on the target server and synchronizes the data extents on the target server with the source server.

#### MAXSESSIONS

Specifies the maximum number of data sessions that can send data to a target server. This parameter is optional. The value that you specify can be in the range 1 - 100.

**AIX** | **Windows** The default value is 10.

**Linux** The default value varies:

- If TRANSFERMETHOD=TCPIP, the default value of the MAXSESSIONS parameter is 10.
- If TRANSFERMETHOD=FASP, the default value of the MAXSESSIONS parameter is 2.

If you increase the number of sessions, you can improve throughput for the storage pool.

When you set a value for the MAXSESSIONS parameter, ensure that the available bandwidth and the processor capacity of the source and target servers are sufficient.

#### Tips:

- If you issue a QUERY SESSION command, the total number of sessions might exceed the number of data sessions. The difference is because of short control sessions that are used to query and set up operations.
- The number of sessions that are used for protection depends on the amount of data that is backed up. If you are backing up only a small amount of data, increasing the number of sessions provides no benefit.

#### Preview

Specifies whether to preview data. This parameter is optional. The default value is NO. Specify one of the following values:

#### No

Specifies that the data is backed up to the target server but that the data is not previewed.

#### Yes

Specifies that data is previewed but not backed up.

#### PURGEdata

Specifies that data extents are deleted from the target server. This parameter is optional. The default value is NO. You can specify one of the following values:

#### No

Specifies that data extents are not deleted from the target server.

#### All

Specifies that all data extents are deleted from the target server. Data extents that are referenced by other data in the target storage pool are not deleted.

#### Deleted

Specifies that data extents that were deleted on the source server are deleted from the target server. New data extents are not protected.

## RECLaim

Specifies whether reclamation runs when the PROTECT STGPOOL command is processed. Reclamation runs on the local container-copy storage pool that is the target for the protection operation. This parameter is optional. The default value is YES. You can specify one of the following values:

### Yes

Specifies that reclamation runs when the command is issued, along with the storage pool protection operation. Reclamation runs to completion, with no limitation on the number of volumes in the storage pool that are processed for reclamation.

### No

Specifies that reclamation is not run when the command is issued. Only the storage pool protection operation runs.

### Only

Specifies that reclamation is the only operation that runs when the command is issued. The storage pool protection operation does not run, so data in the directory-container storage pool that was updated since the last protection operation is not protected. Reclamation runs to completion, with no limitation on the number of volumes in the storage pool that are processed for reclamation.

### YESLIMited

Specifies that reclamation runs when the command is issued, along with the storage pool protection operation. Reclamation runs until it reaches the reclaim limit that is defined for the container-copy storage pool. The reclaim limit is defined with the RECLAIMLIMIT parameter on the DEFINE STGPOOL or UPDATE STGPOOL command.

### ONLYLIMited

Specifies that reclamation is the only operation that runs when the command is issued. The storage pool protection operation does not run, so data in the directory-container storage pool that was updated since the last protection operation is not protected. Reclamation runs until it reaches the reclaim limit that is defined for the container-copy storage pool. The reclaim limit is defined with the RECLAIMLIMIT parameter on the DEFINE STGPOOL or UPDATE STGPOOL command.

## Wait

Specifies whether to wait for the server to process this command in the foreground. This parameter is optional. The default value is NO. You can specify one of the following values:

### No

Specifies that the command is processed in the background. To monitor the background processes of this command, issue the QUERY PROCESS command.

### Yes

Specifies that the command is processed in the foreground. Messages are not displayed until the command completes processing.

Restriction: You cannot specify `WAIT=YES` from the server console.

## Linux TRANSFERMethod

Specifies the method that is used for server-to-server data transfer. This parameter is optional. You can specify one of the following values:

### Tcpip

Specifies that TCP/IP is used to transfer data. This value is the default.

### Fasp

Specifies that Aspera® Fast Adaptive Secure Protocol (FASP®) technology is used to transfer data. Aspera FASP technology can help you optimize data transfer in a wide area network (WAN). If you specify `TRANSFERMETHOD=FASP`, you override any `TRANSFERMETHOD` parameters that you specified on the `DEFINE SERVER` or `UPDATE SERVER` commands.

Restrictions:

- Before you enable Aspera FASP technology, determine whether the technology is appropriate for your system environment and install the appropriate licenses. For instructions, see [Determining whether Aspera FASP technology can optimize data transfer in your system environment](#). If the licenses are missing or expired, operations to protect storage pools fail.
- If WAN performance meets your business needs, do not enable Aspera FASP technology.

## Example: Delete all data extents from the target server

---

Delete all data extents in a directory-container storage pool on the target server. The directory-container storage pool that is named POOL1 on the source server is no longer protected by the directory-container storage pool on the target server. You might delete all extents to clean the directory-container storage pool on the target server that no longer protects the source server.

```
protect stgpool pool1 purgedata=all
```

## Example: Protect a storage pool and specify a maximum number of data sessions

Protect a storage pool that is named SPOOL1 on the source server by backing up the data to a target replication server, TPOOL1. Specify a maximum of 20 data sessions.

```
update stgpool spool1 protectstgpool=tpool1
protect stgpool spool1 maxsessions=20
```

## Example: Copy the storage pool data to tape

Protect a directory-container storage pool by copying the data to a container-copy storage pool on the same server. In this example, the directory-container storage pool is named SPOOL1 and the container-copy storage pool, which uses tape for storage, is named TAPES1.

1. Update the directory-container storage pool to add TAPES1 as the local storage pool for protection. The TAPES1 storage pool must be a container-copy storage pool. Issue the following command:

```
update stgpool spool1 protectlocalstgpools=tapes1
```

2. Protect the data in the directory-container storage pool with a local copy by issuing the following command:

```
protect stgpool type=local spool1
```

The data is copied to the TAPES1 storage pool.

## Example: Reclaim space on tape volumes before you protect a storage pool

Reclaim space on the tape volumes that are used to protect a directory-container storage pool. Then, protect the data in the directory-container storage pool. In this example, the directory-container storage pool is named SPOOL1.

1. Reclaim space in the local container-copy storage pool that is defined as the target protection pool for SPOOL1.

```
protect stgpool spool1 type=local reclaim=only
```

2. Protect the data in the directory-container storage pool that is named SPOOL1 without running reclamation.

```
protect stgpool spool1 type=local reclaim=no
```

Table 1. Commands related to PROTECT STGPOOL

Command	Description
CANCEL PROCESS	Cancels a background server process.
DEFINE STGPOOL (container-copy)	Define a container-copy storage pool that stores copies of data from a directory-container storage pool.
DEFINE STGPOOL (directory-container)	Define a directory-container storage pool.
DEFINE STGPOOLDIRECTORY	Defines a storage pool directory to a directory-container or cloud-container storage pool.
REPAIR STGPOOL	Repairs a directory-container storage pool.
REPLICATE NODE	Replicates data in file spaces that belong to a client node.
SET REPLSERVER	Specifies a target replication server.
UPDATE STGPOOL (container-copy)	Update a container-copy storage pool that stores copies of data from a directory-container storage pool.

## QUERY commands

Use the QUERY commands to request or display information about IBM Spectrum Protect™ objects.

- QUERY ACTLOG (Query the activity log)
- QUERY ADMIN (Display administrator information)

- QUERY ALERTTRIGGER (Query the list of defined alert triggers)
- QUERY ALERTSTATUS (Query the status of an alert)
- QUERY ASSOCIATION (Query client node associations with a schedule)
- QUERY AUDITOCAPACITY (Query client node storage utilization)
- QUERY BACKUPSET (Query a backup set)
- QUERY BACKUPSETCONTENTS (Query contents of a backup set)
- |     |       |         |
|-----|-------|---------|
| AIX | Linux | Windows |
|-----|-------|---------|

 QUERY CLEANUP (Query the cleanup that is required in a source storage pool)
- QUERY CLOPTSET (Query a client option set)
- QUERY COLLOGGROUP (Query a collocation group)
- QUERY CONTENT (Query the contents of a storage pool volume)
- |     |       |         |
|-----|-------|---------|
| AIX | Linux | Windows |
|-----|-------|---------|

 QUERY CONTAINER (Query a container)
- |     |       |         |
|-----|-------|---------|
| AIX | Linux | Windows |
|-----|-------|---------|

 QUERY CONVERSION (Query conversion status of a storage pool)
- QUERY COPYGROUP (Query copy groups)
- QUERY DATAMOVER (Display data mover definitions)
- |     |       |         |
|-----|-------|---------|
| AIX | Linux | Windows |
|-----|-------|---------|

 QUERY DAMAGED (Query damaged data in a directory-container or cloud-container storage pool)
- QUERY DB (Display database information)
- QUERY DBSPACE (Display database storage space)
- |     |       |         |
|-----|-------|---------|
| AIX | Linux | Windows |
|-----|-------|---------|

 QUERY DEDUPSTATS (Query data deduplication statistics)
- QUERY DEVCLASS (Display information on one or more device classes)
- QUERY DIRSPACE (Query storage utilization of FILE directories)
- QUERY DOMAIN (Query a policy domain)
- QUERY DRIVE (Query information about a drive)
- QUERY DRMEDIA (Query disaster recovery media)
- QUERY DRMSTATUS (Query disaster recovery manager system parameters)
- QUERY ENABLED (Query enabled events)
- QUERY EVENT (Query scheduled and completed events)
- QUERY EVENTRULES (Query rules for server or client events)
- QUERY EVENTSERVER (Query the event server)
- QUERY EXPORT (Query for active or suspended export operations)
- |     |       |         |
|-----|-------|---------|
| AIX | Linux | Windows |
|-----|-------|---------|

 QUERY EXTENTUPDATES (Query updated data extents)
- QUERY FILESPACE (Query one or more file spaces)
- QUERY LIBRARY (Query a library)
- QUERY LIBVOLUME (Query a library volume)
- QUERY LICENSE (Display license information)
- QUERY LOG (Display information about the recovery log)
- QUERY MACHINE (Query machine information)
- QUERY MEDIA (Query sequential-access storage pool media)
- QUERY MGMTCLASS (Query a management class)
- QUERY MONITORSETTINGS (Query the configuration settings for monitoring alerts and server status)
- QUERY MONITORSTATUS (Query the monitoring status)
- QUERY MOUNT (Display information on mounted sequential access volumes)
- |     |       |         |
|-----|-------|---------|
| AIX | Linux | Windows |
|-----|-------|---------|

 QUERY NASBACKUP (Query NAS backup images)
- QUERY NODE (Query nodes)
- QUERY NODEDATA (Query client data in volumes)
- QUERY NODEGROUP (Query a node group)
- QUERY OCCUPANCY (Query client file spaces in storage pools)
- QUERY OPTION (Query server options)
- QUERY PATH (Display a path definition)
- QUERY POLICYSET (Query a policy set)
- QUERY PROCESS (Query one or more server processes)
- QUERY PROFILE (Query a profile)
- QUERY PROTECTSTATUS (Query the status of storage pool protection)
- QUERY PROXYNODE (Query proxy authority for a client node)
- QUERY PVUESTIMATE (Display processor value unit estimate)
- QUERY RECOVERYMEDIA (Query recovery media)
- QUERY REPLICATION (Query node replication processes)
- QUERY REPLNODE (Display information about replication status for a client node)
- QUERY REPLRULE (Query replication rules)
- QUERY REPLSERVER (Query a replication server)
- QUERY REQUEST (Query one or more pending mount requests)
- QUERY RESTORE (Query restartable restore sessions)

- QUERY RPFCONTENT (Query recovery plan file contents stored on a target server)
- QUERY RPFFILE (Query recovery plan file information stored on a target server)
- |     |       |         |
|-----|-------|---------|
| AIX | Linux | Windows |
|-----|-------|---------|

 QUERY SAN (Query the devices on the SAN)
- QUERY SCHEDULE (Query schedules)
- QUERY SCRIPT (Query IBM Spectrum Protect scripts)
- QUERY SERVER (Query a server)
- QUERY SERVERGROUP (Query a server group)
- QUERY SESSION (Query client sessions)
- QUERY SHREDSTATUS (Query shredding status)
- QUERY SPACETRIGGER (Query the space triggers)
- QUERY STATUS (Query system parameters)
- QUERY STATUSTHRESHOLD (Query status monitoring thresholds)
- QUERY STGPOOL (Query storage pools)
- |     |       |         |
|-----|-------|---------|
| AIX | Linux | Windows |
|-----|-------|---------|

 QUERY STGPOOLDIRECTORY (Query a storage pool directory)
- QUERY SUBSCRIBER (Display subscriber information)
- QUERY SUBSCRIPTION (Display subscription information)
- QUERY SYSTEM (Query the system configuration and capacity)
- |     |       |         |
|-----|-------|---------|
| AIX | Linux | Windows |
|-----|-------|---------|

 QUERY TAPEALERTMSG (Display status of SET TAPEALERTMSG command)
- |     |       |         |
|-----|-------|---------|
| AIX | Linux | Windows |
|-----|-------|---------|

 QUERY TOC (Display table of contents for a backup image)
- QUERY VIRTUALFSMAPPING (Query a virtual file space mapping)
- QUERY VOLHISTORY (Display sequential volume history information)
- QUERY VOLUME (Query storage pool volumes)

## QUERY ACTLOG (Query the activity log)

---

Use this command to display messages generated by the server and client. This command provides filtering options that can be used to limit the number of messages displayed and the time that it takes to process this query. If you do not specify any parameters with this command, all messages generated in the previous hour are displayed.

The activity log contains all messages that are sent to the server console under normal operation. The results of commands entered at the server console are not recorded in the activity log unless the command affects or starts a background process or client session. Error messages are displayed in the activity log.

Restriction: You cannot schedule the QUERY ACTLOG command by using the DEFINE SCHEDULE command.

### Privilege class

---

Any administrator can issue this command.

### Syntax

---

```

      .-BEGINDate-----current_date-.
>>-Query Actlog-+-----+----->
      '-BEGINDate-----date-----'

      .-BEGINTime-----currenttime_minus_1_hour-.
>--+-----+----->
      '-BEGINTime-----time-----'

      .-ENDDate-----current_date-.  .-ENDTime-----current_time-.
>--+-----+-----+----->
      '-ENDDate-----date-----'  '-ENDTime-----time-----'

>--+-----+-----+----->
      '-MSGNo-----message_number-'  '-Search-----string-'

>--+-----+----->
      '-NODEname-----node_name-'

      .-ORiginator-----ALL-----
>--+-----+-----><
      '-ORiginator-----+-----+-----'
          +-Server-----+
          '-CLient--| A |-'
```



A

```
|--+-----+----->
  '-OWNERname----owner_name-'
>--+-----+----->
  '-SCHedname----schedule_name-'
>--+-----+----->
  '-Dmainname----domain_name-'
>--+-----+-----|
  '-SESSnum----session_number-'
```

## Parameters

### BEGINDate

Specifies the beginning date of the range for messages to be displayed. All messages meeting the time range criteria that occurred after this date are displayed. The default is the current date. This parameter is optional.

You can specify the date using one of the following values:

Value	Description	Example
MM/DD/YYYY	A specific date	09/15/1998
TODAY	The current date	TODAY
TODAY-days <b>or</b> -days	The current date minus days specified. The maximum number of days you can specify is 9999.	TODAY -7 <i>or</i> -7.  To display information beginning with messages created a week ago, you can specify BEGINDATE=TODAY-7 or BEGINDATE= -7.
EOLM (End Of Last Month)	The last day of the previous month.	EOLM
EOLM-days	The last day of the previous month minus days specified.	EOLM-1  To include files that were active a day before the last day of the previous month.
BOTM (Beginning Of This Month)	The first day of the current month.	BOTM
BOTM+days	The first day of the current month, plus days specified.	BOTM+9  To include files that were active on the 10th day of the current month.

### BEGINTime

Specifies the beginning time of the range for messages to be displayed. All messages meeting the time range criteria that occurred after this time are displayed. If you do not specify time, all messages that occurred in the last hour are displayed.

You can specify the time using one of the following values:

Value	Description	Example
HH:MM:SS	A specific time on the specified begin date	10:30:08
NOW	The current time on the specified begin date	NOW
NOW+HH:MM <i>or</i> +HH:MM	The current time plus hours and minutes on the specified begin date	NOW+03:00 <i>or</i> +03:00.  If you issue this command at 9:00 with BEGINTIME=NOW+3 or BEGINTIME=+3, IBM Spectrum Protect™ displays messages with a time of 12:00 or later on the begin date.

Value	Description	Example
NOW-HH:MM <i>or</i> -HH:MM	The current time minus hours and minutes on the specified begin date	NOW-04:00 <i>or</i> -04:00.  If you issue the QUERY ACTLOG command at 9:00 with BEGINTime=NOW-3:30 or BEGINTime= -3:30, IBM Spectrum Protect displays messages with a time of 5:30 or later on the begin date.

#### ENDDate

Specifies the ending date of the range for messages to be displayed. All messages meeting the time range criteria that occurred before this date are displayed. If you do not specify a value, the current date is used. This parameter is optional. You can specify the date using one of the following values:

Value	Description	Example
MM/DD/YYYY	A specific date	09/15/1998
TODAY	The current date	TODAY
TODAY-days <b>or</b> -days	The current date minus days specified. The maximum number of days you can specify is 9999.	TODAY-1 <i>or</i> -1.  To display information created up to yesterday, you can specify ENDDATE=TODAY-1 or simply ENDDATE= -1.
EOLM (End Of Last Month)	The last day of the previous month.	EOLM
EOLM-days	The last day of the previous month minus days specified.	EOLM-1  To include files that were active a day before the last day of the previous month.
BOTM (Beginning Of This Month)	The first day of the current month.	BOTM
BOTM+days	The first day of the current month, plus days specified.	BOTM+9  To include files that were active on the 10th day of the current month.

#### ENDTime

Specifies the ending time of the range for messages to be displayed. All messages meeting this time range criteria that occurred before this time are displayed. If you do not specify a value, all messages are displayed up to the time when you issued this command. This parameter is optional. You can specify the time using one of the following values:

Value	Description	Example
HH:MM:SS	A specific time on the specified end date	10:30:08
NOW	The current time on the specified end date	NOW
NOW+HH:MM <i>or</i> +HH:MM	The current time plus hours and minutes on the specified end date	NOW+03:00 <i>or</i> +03:00.  If you issue this command at 9:00 with ENDTIME=NOW+3:00 or ENDTIME= +3:00, IBM Spectrum Protect displays messages with a time of 12:00 or earlier on the end date you specify.
NOW-HH:MM <i>or</i> -HH:MM	The current time minus hours and minutes on the specified end date	NOW-03:30 <i>or</i> -03:30.  If you issue this command at 9:00 with ENDTIME=NOW-3:30 or ENDTIME= -3:30, IBM Spectrum Protect displays messages with a time of 5:30 or earlier on the end date you specify.

#### MSGno

Specifies an integer that defines the number of the message to be displayed from the activity log. This integer is just the numeric part of the message. This parameter is optional.

## Search

Specifies a text string that you want to search for in the activity log. Enclose the string expression in quotation marks if it contains blanks. You can use text and a wildcard character to specify this string. This parameter is optional.

Note: Do not enter as a text string either the IBM Spectrum Protect server name or text and a wildcard character that would find the server name. If you do so, the output includes messages that do not include the search string.

## NODENAME

Specifies that the query displays messages logged for this node. If you do not specify a value for this parameter, messages for all nodes are displayed.

## ORIGINATOR

Specifies that the query displays messages logged by the server, client, or both. The default is ALL. Possible values are:

### ALL

Specifies that the query displays messages that originated from the client and the server.

### SERVER

Specifies that the query displays messages that originated from the server.

### CLIENT

Specifies that the query displays messages that originated from the client.

You can specify one of the following values to minimize processing time when querying the activity log for messages logged by the client:

### OWNERNAME

Specifies that the query displays messages logged for a particular owner. If you do not specify a value for this parameter, messages for all owners are displayed.

### SCHEDULENAME

Specifies that the query displays messages logged by a particular scheduled client activity. If you do not specify a value for this parameter, messages for all schedules are displayed.

### DOMAINNAME

Specifies that the query displays messages logged for a particular policy domain to which a named schedule belongs. This parameter is optional, unless you are specifying a schedule name.

### SESSIONNUM

Specifies that the query displays messages logged from a particular client session number. If you do not specify a value for this parameter, messages for all client sessions are displayed.

## Example: Search activity log for messages with specific text

---

Search the activity log for any message that contains the string "delete". The output includes only messages produced during the past hour. Issue the command:

```
query actlog search=delete
```

Date/Time	Message
08/27/1998 15:19:43	ANR0812I Inventory client file expiration complete: 0 files deleted.

## Example: Search activity log for messages within a specific time frame

---

Display messages that occurred yesterday between 9:30 and 12:30. Issue the command:

```
query actlog begindate=today-1  
begintime=09:30:00 endtime=12:30:00
```

Date/Time	Message
10/21/1998 10:52:36	ANR0407I Session 3921 started for administrator ADMIN (WebBrowser) (HTTP 9.115.20.100(2315)).
10/21/1998 11:06:08	ANR0405I Session 3922 ended for administrator ADMIN (WebBrowser).
10/21/1998 12:16:50	ANR0405I Session 3934 ended for administrator ADMIN (WebBrowser).

## Example: Search activity log for messages from a specific client node

---

Search the activity log for IBM Spectrum Protect messages from the client for node JEE. Issue the command:

```
query actlog originator=client node=jee
```

Date/Time	Message
06/10/1998 15:46:22	ANE4007E (Session No: 3 Node: JEE) Error processing '/jee/report.out': access to the object is denied
06/11/1998 15:56:56	ANE4009E (Session No: 4 Node: JEE) Error processing '/jee/work.lst': disk full condition

## Example: Search activity log for client and server messages from a specific client node and session

Search the activity log for IBM Spectrum Protect messages from the client and server for node A associated with Session 1. The output includes all messages with the defined text string, "SESSION: 1". Issue the command:

```
query actlog search="(SESSION:1)"
```

Date/Time	Message
02/13/2012 12:13:42	ANR0406I Session 1 started for node A (WinNT) (Tcp/Ip colind(2463)). (SESSION: 1)
02/13/2012 12:13:56	ANE4952I (ANE4985I Session: 1, ANE4986I Node: A) Total number of objects inspected: 34 (SESSION: 1)
02/13/2012 12:13:56	ANE4954I (ANE4985I Session: 1, ANE4986I Node: A) Total number of objects backed up: 34 (SESSION: 1)
02/13/2012 12:13:56	ANE4958I (ANE4985I Session: 1, ANE4986I Node: A) Total number of objects updated: 0 (SESSION: 1)
02/13/2012 12:13:56	ANE4964I (ANE4985I Session: 1, ANE4986I Node: A) Elapsed processing time: 00:00:02 (SESSION: 1)
02/13/2012 12:13:59	ANR0403I Session 1 ended for node A (WinNT). (SESSION: 1)

## Example: Search activity log for client-generated messages from a client session

Search the activity log for IBM Spectrum Protect messages from a specific client session. The output includes only messages generated by the client. Issue the command:

```
query actlog sessnum=1
```

Date/Time	Message
02/13/2012 12:13:56	ANE4952I (ANE4985I Session: 1, ANE4986I Node: A) Total number of objects inspected: 34 (SESSION: 1)
02/13/2012 12:13:56	ANE4954I (ANE4985I Session: 1, ANE4986I Node: A) Total number of objects backed up: 34 (SESSION: 1)
02/13/2012 12:13:56	ANE4958I (ANE4985I Session: 1, ANE4986I Node: A) Total number of objects updated: 0 (SESSION: 1)
02/13/2012 12:13:56	ANE4964I (ANE4985I Session: 1, ANE4986I Node: A) Elapsed processing time: 00:00:02 (SESSION: 1)

## Field descriptions

### Date/Time

Specifies the date and time when the message was generated by the server or client.

### Message

Specifies the message that was generated by the server or client.

## Related commands

Table 1. Command related to QUERY ACTLOG

Command	Description

Command	Description
SET ACTLOGRETENTION	Specifies the number of days to retain log records in the activity log.

## QUERY ADMIN (Display administrator information)

Use this command to display information about one or more administrators.

### Privilege class

Any administrator can issue this command.

### Syntax

```

>>-Query Admin--+-*-----+----->
                    '-admin_name-'
>----->
|               .-,-----|
|               v          |
| '-Classes-----+SYstem--+ |
|               +-Policy---+
|               +-Storage--+
|               +-Operator+
|               '-Node-----'
|
| '-Format-----Standard-----'
>----->
| '-Format-----+Standard+-'
|               '-Detailed-'
>-----><
| '-AUTHentication-----+LOCAL+-'   '-Alerts-----+Yes+-'
|               '-LDap--'           '-No--'

```

### Parameters

#### admin\_name

Specifies the name of the administrator for which you want to display information. This parameter is optional. You can use wildcard characters to specify this name. If you do not specify a value for this parameter, all administrators are displayed.

#### Classes

Specifies that you want to restrict output to those administrators that have privilege classes that you specify. This parameter is optional. You can specify multiple privilege classes in a list by separating the names with commas and no intervening spaces. If you do not specify a value for this parameter, information about all administrators is displayed, regardless of privilege class. Possible values are:

#### SYstem

Display information on administrators with system privilege.

#### Policy

Display information on administrators with policy privilege.

#### STorage

Display information on administrators with storage privilege.

#### Operator

Display information on administrators with operator privilege.

#### Node

Display information on users with client node privilege.

#### Format

Specifies how the information is displayed. This parameter is optional. The default value is STANDARD. Possible values are:

#### Standard

Specifies that partial information is displayed for the specified administrators.  
**Detailed**  
 Specifies that complete information is displayed for the specified administrators.

**Authentication**

Specifies the password authentication method for the administrator.

**Local**

Display those administrators authenticating to the IBM Spectrum Protect™ server.

**LDap**

Display those administrators authenticating to an LDAP directory server. The administrator password is case-sensitive.

**ALert**

Specifies whether alerts are sent to an administrators email address.

**Yes**

Specifies that alerts are sent to the specified administrators email address.

**No**

Specifies that alerts are not sent to the specified administrators email address. This is the default value.

Tip: Alert monitoring must be enabled, and email settings must be correctly defined to successfully receive alerts by email. To view the current settings, issue the QUERY MONITORSETTINGS command.

**Example: Display information about all administrators**

---

Display partial information on all administrators. Issue the command:

```
query admin
```

Administrator Name	Days Since Last Access	Days Since Password Set	Locked?	Privilege Classes
ADMIN	<1	<1	No	System
SERVER_CONSOLE			No	System

See Field descriptions for field descriptions.

**Example: Display complete information about one administrator**

---

From a managed server, display complete information for the administrator named ADMIN. Issue the command:

```
query admin admin format=detailed
```

```
Administrator Name: ADMIN
Last Access Date/Time: 1998.06.04 17.10.52
Days Since Last Access: <1
Password Set Date/Time: 1998.06.04 17.10.52
Days Since Password Set: 26
Invalid Sign-on Count: 0
Locked?: No
Contact:
System Privilege: Yes
Policy Privilege: **Included with system privilege**
Storage Privilege: **Included with system privilege**
Operator Privilege: **Included with system privilege**
Client Access Privilege: **Included with system privilege**
Client Owner Privilege: **Included with system privilege**
Registration Date/Time: 05/09/1998 23:54:20
Registering Administrator: SERVER_CONSOLE
Managing profile:
Password Expiration Period: 90 Day (s)
Email Address:
Email Aerts: Yes
Authentication: Local
SSL Required: No
Session Security: Strict
Transport Method: TLS 1.2
```

See Field descriptions for field descriptions.

## Field descriptions

---

### Administrator Name

Specifies the name of the administrator.

### Last Access Date/Time

Specifies the date and time that the administrator last accessed the server.

### Days Since Last Access

Specifies the number of days since the administrator last accessed the server.

### Password Set Date/Time

Specifies the date and time that the administrator's password was defined or most recently updated.

### Days Since Password Set

Specifies the number of days since the administrator's password was defined or most recently updated.

### Invalid Sign-on Count

Specifies the number of invalid sign-on attempts that have been made since the last successful sign-on. This count can only be non-zero when an invalid password limit (SET INVALIDPWLIMIT) is greater than zero. When the number of invalid attempts equals the limit set by the SET INVALIDPWLIMIT command, the administrator is locked out of the system.

### Locked?

Specifies whether the administrator is locked out of the system.

### Contact

Specifies any contact information for the administrator.

### System Privilege

Specifies whether the administrator has been granted system privilege.

### Policy Privilege

Specifies whether the administrator has been granted unrestricted policy privilege or the names of any policy domains that the restricted policy administrator can manage.

### Storage Privilege

Specifies whether the administrator has been granted unrestricted storage privilege or the names of any storage pools that the restricted storage administrator can manage.

### Operator Privilege

Specifies whether the administrator has been granted operator privilege.

### Client Access Privilege

Specifies that client access authority has been granted to a user with node privilege.

### Client Owner Privilege

Specifies that client owner authority has been granted to a user with node privilege.

### Registration Date/Time

Specifies the date and time that the administrator was registered.

### Registering Administrator

Specifies the name of the administrator who registered the administrator. If this field contains \$\$CONFIG\_MANAGER\$\$, the administrator is associated with a profile that is managed by the configuration manager.

### Managing Profile

Specifies the profiles to which the managed server subscribed to get the definition of this administrator.

### Password Expiration Period

Specifies the administrator's password expiration period.

### Email Address

Specifies the email address for the administrator.

### Email Alerts

Specifies whether alerts are sent to the specified administrator by email.

### Authentication

Specifies the password authentication method: LOCAL, LDAP, or LDAP (pending).

Authentication Target	Authentication Method
IBM Spectrum Protect server	LOCAL
LDAP directory server	LDAP
This administrator is configured to authenticate with an LDAP directory server, but the administrator did not yet authenticate through a client node.	LDAP (pending)

SSL Required (deprecated)

Specifies whether the security setting for the administrator user ID requires the Secure Sockets Layer (SSL) protocol. Values can be YES, NO, or Default. You must have system level authority to update the administrator SSLREQUIRED setting. This parameter is deprecated.

**Session Security**

Specifies the level of session security that is enforced for the administrator ID. Values can be STRICT or TRANSITIONAL.

**Transport Method**

Specifies the transport method that was last used for the specified administrator. Values can be TLS 1.2, TLS 1.1, or NONE. A question mark (?) is displayed until a successful authentication is completed.

## Related commands

Table 1. Commands related to QUERY ADMIN

Command	Description
GRANT AUTHORITY	Assigns privilege classes to an administrator.
QUERY NODE	Displays partial or complete information about one or more clients.
QUERY STATUS	Displays the settings of server parameters, such as those selected by the SET commands.
REGISTER ADMIN	Defines a new administrator without granting administrative authority.
REMOVE ADMIN	Removes an administrator from the list of registered administrators.
RENAME ADMIN	Changes an IBM Spectrum Protect administrator's name.
RESET PASSEXP	Resets the password expiration for nodes or administrators.
REVOKE AUTHORITY	Revokes one or more privilege classes or restricts access to policy domains and storage pools.
SET INVALIDPWLIMIT	Sets the number of invalid logon attempts before a node is locked.
SET MINPWLENGTH	Sets the minimum length for client passwords.
SET PASSEXP	Specifies the number of days after which a password is expired and must be changed.

## QUERY ALERTTRIGGER (Query the list of defined alert triggers)

Use this command to display which server messages are defined as alerts.

### Privilege class

Any administrator can issue this command.

### Syntax

```
>>-Query ALERTTrigger-+-----*----->>
                        |-----message_number-----|
```

### Parameters

**message\_number**

Specifies the message number that you want to query. Specify multiple message numbers, which are separated by commas, and no intervening spaces. Message numbers are a maximum of eight characters in length. Wildcard characters can be used to specify message numbers. If you do not specify a message number, all alert triggers are displayed.



## Query alert triggers to display which messages are designated as alerts

Display all messages that are designated as alerts by issuing the following command:

```
query alertrigger
```

Example output:

```
Alert Trigger      Category      Administrator
-----
ANR1067E          SERVER        HARRYH
ANR1073E          SERVER        CSDADMIN, DJADMIN, HARRYH
ANR1074E          STORAGE       CSDADMIN, DJADMIN, HARRYH
ANR1096E          STORAGE       CSDADMIN, DJADMIN, HARRYH, MHAYE
```

## Query alert triggers for a specific message number

Display all alert triggers that have message number ANR1067E designated to them by issuing the following command:

```
query alertrigger ANR1067E
```

Example output:

```
Alert Trigger      Category      Administrator
-----
ANR1067E          SERVER        HARRYH
```

## Field descriptions

Alert Trigger

The message number for the alert trigger.

Category

The category of the alert trigger.

Administrator

The name of the administrator who receives alerts from this alert trigger.

## Related commands

Table 1. Commands related to QUERY ALERTTRIGGER

Command	Description
DEFINE ALERTTRIGGER (Define an alert trigger)	Associates specified messages to an alert trigger.
DELETE ALERTTRIGGER (Remove a message from an alert trigger)	Removes a message number that can trigger an alert.
QUERY ALERTSTATUS (Query the status of an alert)	Displays information about alerts that have been issued on the server.
UPDATE ALERTTRIGGER (Update a defined alert trigger)	Updates the attributes of one or more alert triggers.
UPDATE ALERTSTATUS (Update the status of an alert)	Updates the status of a reported alert.

## QUERY ALERTSTATUS (Query the status of an alert)

Use this command to display information about alerts that are reported on the IBM Spectrum Protect™ server.

### Privilege class

Any administrator can issue this command.

### Syntax

```
>>-Query ALERTSStatus--+-STATUS-----ANY-----+----->
```

```

|          .-,------. |
|          v            | |
'-Status-----+Active-----+'
          +-Inactive-+
          +-Closed---+
          '-ANy-----'

>-----+-----+-----+-----+-----+-----+-----+----->
|          .-,------. | '-CATegory-----+APplication-+-'
|          v            | |          +-INventory---+
'-MSGnum-----message_num-+-'          +-Client-----+
          +-Device-----+
          +-Server-----+
          +-Storage-----+
          +-System-----+
          '-VMclient----'

>-----+-----+-----+-----+-----+-----+-----+----->
'-SOURCEType-----+Local---+-----+-----+'
          +-Client-+ '-SOURCEName-----source_name-'
          '-REmote-'

>-----+-----+-----+-----+-----+-----+-----+----->
|          .-,------. | '-ASSigned-----text-'
|          v            | |
'-ID-----alert_id-+-'

>-----+-----+-----+-----+-----+-----+-----+-----><
'-RESolvedby-----text-'

```

## Parameters

### Status

Specifies the status type that you want to display. If you do not specify a status, all alerts are queried and displayed. Specify one of the following values:

#### Active

Displays alerts that are specified in the IBM Spectrum Protect server database as active.

#### INActive

Displays alerts that are in the inactive state.

#### Closed

Displays alerts that are in the closed state.

#### ANy

Displays all alerts, without regard to state.

### MSGnum

Specifies the message number that you want to display. Specify the numerical portion of an IBM Spectrum Protect server message. Values are in the range 0 - 9999. For example, the message number in message ANR2044E is 2044. Specify multiple message numbers by separating them with commas and no intervening spaces.

### CATegory

Specifies the category type for the alert, which is determined by the message types. Specify one of the following values:

#### APplication

Alert is classified as application category. For example, you can specify this category for messages that are associated with application (TDP) clients.

#### INventory

Alert is classified as inventory category. For example, you can specify this category for messages that are associated with the database, active log file, or archive log file.

**Note:** The category of `CATalog` is used instead of `INventory` in alerts from servers that were not upgraded to IBM Spectrum Protect 7.1.0 or later.

#### CLient

Alert is classified as client category. For example, you can specify this category for messages that are associated with general client activities.

#### DEvice

Alert is classified as device category. For example, you can specify this category for messages that are associated with device classes, libraries, drives, or paths.

#### SERver

Alert is classified as general server category. For example, you can specify this category for messages that are associated with general server activities or events.

#### STorage

Alert is classified as storage category. For example, you can specify this category for messages that are associated with storage pools.

#### SYstems

Alert is classified under system clients category. For example, you can specify this category for messages that are associated with system backup and archive or hierarchical storage management (HSM) backup-archive clients.

#### VMclient

Alert is classified under VMclient category. For example, you can specify this category for messages that are associated with virtual machine clients.

#### SOURCEType

Specifies the source type that is being queried. Specify one of the following values:

##### LOcal

Displays alerts that originated from the local IBM Spectrum Protect server.

##### CLient

Displays alerts that originated from the IBM Spectrum Protect client.

##### REmote

Displays alerts that originated from another IBM Spectrum Protect server.

#### SOURCENAME

Specifies the name of the source where the alert originated. SOURCENAME can be the name of a local or remote IBM Spectrum Protect server, or an IBM Spectrum Protect client.

#### ID

This optional parameter specifies the unique ID of the alert that you want to display. Specify a value from 1 to 9223372036854775807.

#### ASSigned

Specifies the administrator name that is assigned the alert that you want to query.

#### RESolvedby

Specifies the administrator name that resolved the alert that you want to query.

## Query active alerts

---

Display only alerts that are active in the server database by issuing the following command:

```
query alertstatus status=active
```

## Query active alerts for two messages issued by the local server

---

Issue the following command to display only active alerts for message numbers ANE4958I and ANR4952E that were issued by the local server:

```
query alertstatus msgnum=4958,4952 status=active sourcetype=local
```

## Query active alerts for messages ANR4958I and ANR4952E issued by a client

---

Issue the following command to display only active alerts for message numbers ANE4958I and ANE4952I that were issued by a client:

```
query alertstatus msgnum=4958,4952 status=active sourcetype=client
```

## Query all alerts on a server

---

Issue the following command to display all alerts that are on the server:

```
query alertstatus
```

Example output: Display all the alerts that are on the server:

```
Alert Identifier: 83
Alert Message Number: 293
Source Name: SEDONA
```

Source Type: LOCAL  
First Occurrence: 03/07/2013 17:08:35  
Most Recent Occurrence: 03/07/2013 17:08:35  
Count: 1  
Status: ACTIVE  
Last Status Change: 12/31/1969 17:00:00  
Category: INVENTORY  
Message: ANR0293I Reorganization for table AF\_BITFILES started.  
Assigned:  
Resolved By:  
Remark:

Alert Identifier: 85  
Alert Message Number: 293  
Source Name: SEDONA  
Source Type: LOCAL  
First Occurrence: 03/08/2013 05:45:00  
Most Recent Occurrence: 03/08/2013 05:45:00  
Count: 1  
Status: ACTIVE  
Last Status Change: 12/31/1969 17:00:00  
Category: INVENTORY  
Message: ANR0293I Reorganization for table BF\_AGGREGATED\_BITFILES started.  
Assigned:  
Resolved By:  
Remark:

Alert Identifier: 1282  
Alert Message Number: 293  
Source Name: ALPINE  
Source Type: LOCAL  
First Occurrence: 02/13/2013 15:47:50  
Most Recent Occurrence: 02/13/2013 15:47:50  
Count: 1  
Status: CLOSED  
Last Status Change: 02/26/2013 09:46:39  
Category: INVENTORY  
Message: ANR0293I Reorganization for table TSMMON\_ALERT started.  
Assigned:  
Resolved By:  
Remark:

Alert Identifier: 1792  
Alert Message Number: 293  
Source Name: ALPINE  
Source Type: LOCAL  
First Occurrence: 02/19/2013 08:58:14  
Most Recent Occurrence: 02/19/2013 08:58:14  
Count: 1  
Status: CLOSED  
Last Status Change: 03/01/2013 12:39:21  
Category: INVENTORY  
Message: ANR0293I Reorganization for table ACTIVITY\_LOG started.  
Assigned:  
Resolved By:  
Remark:

## Field descriptions

---

### Alert Identifier

The unique identifier for the alert.

### Alert Message Number

The message number for the alert.

### Source Name

The name of the source from where the alert originated.

### Source Type

The type of the originating source.



If you specify a domain name, you do not have to specify a schedule name.

`schedule_name`

Specifies the name of the schedule to display. You can use a wildcard character to specify this name. All matching schedule names are displayed. If you do not specify a value for this parameter, all existing schedules are queried. If you specify a schedule name, you must also specify a policy domain name.

## Example: Display client nodes that are associated with a schedule

Display all the client nodes that are associated with each schedule that belongs to the EMPLOYEE\_RECORDS policy domain. Issue the command:

```
query association employee_records *  
  
Policy Domain Name: EMPLOYEE_RECORDS  
Schedule Name: WEEKLY_BACKUP  
Associated Nodes: JOE JOHNSON LARRY SMITH SMITHERS TOM
```

See Field descriptions for field descriptions.

## Field descriptions

Policy Domain Name

Specifies the name of the policy domain to which the schedule belongs.

Schedule Name

Specifies the name of the schedule.

Associated Nodes

Specifies the names of the client nodes that are associated with the specified schedule.

## Related commands

Table 1. Commands related to QUERY ASSOCIATION

Command	Description
DEFINE ASSOCIATION	Associates clients with a schedule.
DELETE ASSOCIATION	Deletes the association between clients and a schedule.

## QUERY AUDITOCUPANCY (Query client node storage utilization)

Use this command to display information about client node server storage utilization. To display current license audit information from the server, use the AUDIT LICENSE command before you issue the QUERY AUDITOCUPANCY command.

As part of a license audit operation, the server calculates, by node, the amount of backup, archive, and space management storage in use. For servers that manage large amounts of data, this calculation can take a great deal of processor time and can stall other server activity. You can use the AUDITSTORAGE server option to specify that storage is not to be calculated as part of a license audit.

You can use the information from this query to determine if and where client node storage utilization must be balanced. This information can also assist you with billing clients for storage usage.

## Privilege class

Any administrator can issue this command.

## Syntax

```
>>-Query AUDITOccupancy-+-----+----->  
| .-,------. |  
| V | | |  
|---node_name+--'|  
  
>+-----+----->  
| .-,------. |
```



## Related commands

Table 1. Commands related to QUERY AUDITOCUPANCY

Command	Description
AUDIT LICENSES	Verifies compliance with defined licenses.
QUERY LICENSE	Displays information about licenses and audits.
QUERY STATUS	Displays the settings of server parameters, such as those selected by the SET commands.
REGISTER LICENSE	Registers a license with the IBM Spectrum Protect server.
SET LICENSEAUDITPERIOD	Specifies the number of days between automatic license audits.

## QUERY BACKUPSET (Query a backup set)

Use this command to display information about one or more backup sets.

### Privilege class

Any administrator can issue this command.

### Syntax

```

>>-Query BACKUPSET .-*-----
| .-,-----|
| V          |
|'---+node_name-----++-'
|   '-node_group_name-'
|
| .-*-----
| .-,-----| '-BEGINDate----date-'
| V          |
|'---backup_set_name+-'
|
|'---BEGINTime----time-' '-ENDDate----date-'
|
|'---ENDTime----time-' '-WHERERetention----+days----+'
|                                     '-NOLimit-'
|
|'---WHEREDEscription----description-'
|
|'---WHEREDEVclass----device_class_name-'
|
|'---WHERETOCexists----+Yes+-'
|                               '-No--'
|
| .-,-----|
| V          |
|'---WHEREDATAType----+FILE--+-'
|                               '-IMAGE-'
|
| .-Format----Standard----.
|'---Format----+Standard+-'
|                               '-Detailed-'

```



## Parameters

### node\_name or node\_group\_name

Specifies the name of the client node and node groups whose data is contained in the backup set to be displayed. To specify multiple node names and node group names, separate the names with commas and no intervening spaces. You can use wildcard characters with node names but not with node group names.

### backup\_set\_name

Specifies the name of the backup set whose information is to be displayed. The backup set name you specify can contain wildcard characters. You can specify more than one backup set name by separating the names with commas and no intervening spaces.

### BEGINDate

Specifies the beginning date of the range in which the point-in-time date of the backup set to be displayed must fall. This parameter is optional. You can use this parameter with the BEGINTIME parameter to specify a range for the date and time. If you specify a begin date without a begin time, the time will be at 12:00 a.m. (midnight) on the date you specify. You can specify the date by using one of the following values:

Value	Description	Example
MM/DD/YYYY	A specific date	09/15/1999
TODAY	The current date	TODAY
TODAY+days or +days	The current date plus days specified.	TODAY +3 or +3.
TODAY-days or -days	The current date minus days specified.	TODAY -3 or -3.
EOLM (End Of Last Month)	The last day of the previous month.	EOLM
EOLM-days	The last day of the previous month minus days specified.	EOLM-1  To include files that were active a day before the last day of the previous month.
BOTM (Beginning Of This Month)	The first day of the current month.	BOTM
BOTM+days	The first day of the current month, plus days specified.	BOTM+9  To include files that were active on the 10th day of the current month.

### BEGINTime

Specifies the beginning time of the range in which the point-in-time date of the backup set to be displayed must fall. This parameter is optional. You can use this parameter with the BEGINDATE parameter to specify a range for the date and time. If you specify a begin time without a begin date, the date will be the current date at the time you specify. You can specify the time by using one of the following values:

Value	Description	Example
HH:MM:SS	A specific time	10:30:08
NOW	The current time	NOW
NOW+HH:MM or +HH:MM	The current time plus hours and minutes specified	NOW+02:00 or +02:00.
NOW-HH:MM or -HH:MM	The current time minus hours and minutes specified	NOW-02:00 or -02:00.

### ENDDate

Specifies the ending date of the range in which the point-in-time date of the backup set to be displayed must fall. This parameter is optional. You can use this parameter with the ENDTIME parameter to specify an ending date and time. If you specify an end date without an end time, the time will be at 11:59:59 p.m. on the specified end date. You can specify the date by using one of the following values:

Value	Description	Example
MM/DD/YYYY	A specific date	09/15/1999
TODAY	The current date	TODAY

Value	Description	Example
TODAY+days <i>or</i> +days	The current date plus days specified. The maximum number of days you can specify is 9999.	TODAY +3 <i>or</i> +3.
TODAY-days <i>or</i> -days	The current date minus days specified.	TODAY -3 <i>or</i> -3.
EOLM (End Of Last Month)	The last day of the previous month.	EOLM
EOLM-days	The last day of the previous month minus days specified.	EOLM-1  To include files that were active a day before the last day of the previous month.
BOTM (Beginning Of This Month)	The first day of the current month.	BOTM
BOTM+days	The first day of the current month, plus days specified.	BOTM+9  To include files that were active on the 10th day of the current month.

#### ENDTime

Specifies the ending time of the range in which the point-in-time date of the backup set to be displayed must fall. This parameter is optional. You can use this parameter with the ENDDATE parameter to specify a date and time. If you specify an end time without an end date, the date will be the current date at the time you specify.

You can specify the time by using one of the following values:

Value	Description	Example
HH:MM:SS	A specific time	10:30:08
NOW	The current time	NOW
NOW+HH:MM <i>or</i> +HH:MM	The current time plus hours and minutes specified	NOW+02:00 <i>or</i> +02:00.
NOW-HH:MM <i>or</i> -HH:MM	The current time minus hours and minutes specified	NOW-02:00 <i>or</i> -02:00.

#### WHERERetention

Specifies the retention value, specified in days, that must be associated with the backup sets to be displayed. You can specify an integer from 0 to 30000. The values are:

days

Specifies that backup sets that are retained this number of days are displayed.

NOLimit

Specifies that backup sets that are retained indefinitely are displayed.

#### WHEREDESCRIPTION

Specifies the description that must be associated with the backup set to be displayed. The description you specify can contain wildcard characters. This parameter is optional. Enclose the description in quotation marks if it contains any blank characters.

#### WHEREDEVclass

Specifies the name of the device class that must be associated with the backup set to be displayed. You can use wildcard characters to specify a device class name. This parameter is optional.

#### WHERETOexists

Specifies whether a backup set must have a table of contents in order to be displayed. This parameter is optional. The default is to display all backup sets whether or not they have a table of contents.

#### WHEREDATATYPE

Specifies the data type of a backup set to be displayed. This parameter is optional. The default is to display all types of backup sets. To specify multiple data types, separate data types with commas and no intervening spaces.

FILE

Specifies that a file level backup set is to be displayed. File level backup sets contain files and directories backed up by the backup-archive client.

IMAGE

Specifies that an image backup set is to be displayed. Image backup sets contain images created by the backup-archive client BACKUP IMAGE command.

#### Format

Specifies how the information is displayed. This parameter is optional. The default value is STANDARD. Possible values are:

#### Standard

Specifies that partial information is displayed for the specified backup sets.

#### Detailed

Specifies that complete information is displayed for the specified backup sets.

## Example: Query a backup set

---

Display information for backup sets whose names begin with PERS\_DATA. The backup sets belong to the node JANE and are assigned to the DVLMENT device class.

```
query backupset jane pers_data*

      Node Name: JANE
      Backup Set Name: PERS_DATA.3089
      Data Type: File
      Date/Time: 03/17/2007 16:17:47
      Retention Period: 60
      Device Class Name: DVLMENT
      Description: backupset created from /srvr
Has Table of Contents (TOC)?: Yes
```

## Field descriptions

---

#### Node Name

Specifies the name of the client node whose data is contained in the backup set.

#### Backup Set Name

Specifies the name of the backup set.

#### Data Type

Displays the data type of the backup sets. Possible types are file, image, and application.

#### Date/Time

Specifies the date and time (PITDate and PITTime) of the GENERATE BACKUPSET command. The PITDate and PITTime specify that files that were active on the specified date and time and that are still stored on the IBM Spectrum Protect™ server are to be included in the backup set, even if they are inactive at the time you issue the GENERATE BACKUPSET command. The default is the date on which the GENERATE BACKUPSET command is run.

#### Retention Period

Specifies the number of days that the backup set is retained on the server.

#### Device Class Name

Specifies the name of the device class for which the volumes containing the backup set is assigned.

#### Description

Specifies the description associated with the backup set.

#### Has Table of Contents (TOC)?

Specifies whether the backup set has a table of contents.

## Related commands

---

Table 1. Commands related to QUERY BACKUPSET

Command	Description
DEFINE BACKUPSET	Defines a previously generated backup set to a server.
DEFINE NODEGROUP	Defines a group of nodes.
DEFINE NODEGROUPMEMBER	Adds a client node to a node group.
GENERATE BACKUPSET	Generates a backup set of a client's data.
GENERATE BACKUPSETTOC	Generates a table of contents for a backup set.
DELETE BACKUPSET	Deletes a backup set.
DELETE NODEGROUP	Deletes a node group.

Command	Description
DELETE NODEGROUPMEMBER	Deletes a client node from a node group.
QUERY BACKUPSETCONTENTS	Displays contents contained in backup sets.
QUERY NODEGROUP	Displays information about node groups.
UPDATE BACKUPSET	Updates a retention value associated with a backup set.
UPDATE NODEGROUP	Updates the description of a node group.

## QUERY BACKUPSETCONTENTS (Query contents of a backup set)

Use this command to display information about the files and directories contained in a backup set for a client node.

Remember: Processing this command can use considerable network resources and mount points.

### Privilege class

To issue this command, you must have system privilege or policy privilege for the domain to which the client node is assigned.

### Syntax

```
>>-Query BACKUPSETCONTENTS--node_name--backup_set_name----->
      .-DATAType-----FILE----- .
>--+-----+-----><
      '-DATAType-----+FILE---+'
                          '-IMAGE-'
```

### Parameters

node\_name (Required)

Specifies the name of the client node whose data is contained in the backup set to display. The name you specify cannot contain wildcard characters nor can it be a list of node names separated by commas.

backup\_set\_name (Required)

Specifies the name of the backup set to display. The name that you specify cannot contain wildcard characters nor can it be a list of node names that are separated by commas.

DATAType

Specifies that the backup set containing the specified types of data is to be queried. This parameter is optional. The default is that a file level backup set is to be queried. Possible values are:

FILE

Specifies that a file level backup set is to be queried. File level backup sets contain files and directories backed up by the backup-archive client.

IMAGE

Specifies that an image backup set is to be queried. Image backup sets contain images created by the backup-archive client BACKUP IMAGE command.

### Example: Query contents of a backup set for a specific node

Display the contents from backup set named PERS\_DATA.3099 belonging to client node JANE. Issue the command:

```
query backupsetcontents jane pers_data.3099
```

Node Name	Filespace Name	Client's Name for File
JANE	/srvr	/deblock
JANE	/srvr	/deblock.c
JANE	/srvr	/dsmerror.log
JANE	/srvr	/dsmxxxxx.log
JANE	...	.....

## Field descriptions

### Node Name

Specifies the name of the client node whose data is contained in the backup set.

### Filespace Name

Specifies the name of the file space to which the specified file belongs.

File space names can be in a different code page or locale than the server. If they are, the names in the Operations Center and the administrative command-line interface might not be displayed correctly. Data is backed up and can be restored normally, but the file space name or file name might be displayed with a combination of invalid characters or blank spaces.

If the file space name is Unicode-enabled, the name is converted to the server code page for display. The success of the conversion depends on the operating system, the characters in the name, and the server code page. Conversion can be incomplete if the string includes characters that are not available in the server code page or if the server cannot access system conversion routines. If the conversion is incomplete, the name might contain question marks, blanks, unprintable characters, or ellipses (...).

### Client's Name for File

Specifies the name of the file.

File space names and file names that can be in a different code page or locale than the server do not display correctly in the Operations Center or the administrative command-line interface. The data itself is backed up and can be restored properly, but the file space or file name may display with a combination of invalid characters or blank spaces.

If the file space name is Unicode enabled, the name is converted to the server's code page for display. The results of the conversion for characters not supported by the current code page depends on the operating system. For names that IBM Spectrum Protect™ is able to partially convert, you may see question marks (??), blanks, unprintable characters, or "...". These characters indicate to the administrator that files do exist. If the conversion is not successful, the name is displayed as "...". Conversion can fail if the string includes characters that are not available in the server code page, or if the server has a problem accessing system conversion routines.

A file name that is displayed as "....." indicates that both the file path and file name were not successfully converted. An example of the path and name could be:

```
my\dir\...
```

## Related commands

Table 1. Commands related to QUERY BACKUPSETCONTENTS

Command	Description
DEFINE BACKUPSET	Defines a previously generated backup set to a server.
GENERATE BACKUPSET	Generates a backup set of a client's data.
GENERATE BACKUPSETTOC	Generates a table of contents for a backup set.
DELETE BACKUPSET	Deletes a backup set.
QUERY BACKUPSET	Displays backup sets.
UPDATE BACKUPSET	Updates a retention value associated with a backup set.

AIX

Linux

Windows

## QUERY CLEANUP (Query the cleanup that is required in a source storage pool)

Use this command to display information about damaged files that are identified during a storage pool conversion process.

When you issue the CONVERT STGPOOL command to convert a FILE device class, a tape device class, or a virtual tape library (VTL) to a directory-container storage pool, some files in the source storage pool might not convert because of damaged data. To display damaged data that is identified during the conversion process, issue the QUERY CLEANUP command on a source storage pool.

To recover an undamaged version of the data from a copy or active-data storage pool, issue the RESTORE STGPOOL command. To recover an undamaged version of the data from a target replication server issue the REPLICATE NODE command and specify the RECOVERDAMAGED=YES parameter.

## Privilege class

---

To issue this command, you must have restricted storage privilege.

## Syntax

---

```
>>-Query CCleanup--pool_name-----><
```

## Parameters

---

pool\_name(Required)  
Specifies the storage pool to query.

## Example: Display damaged files that are identified by a storage pool conversion process

---

Display damaged files in a storage pool that is named POOL1. See Field descriptions for field descriptions.

```
query cleanup pool1

      File Name: \RTC\BDAT\GIGFILES\BF1.GB
      State: Active
      Stored Size: 1 GB
      Filespace Name: \\ibm838-r90gf0gx\c$
      Type: Backup
      Client Name: CAKINProtection
      Protection Date: 03/25/2016 16:47:57
```

## Field descriptions

---

### File Name

The name of the damaged file.

### State

The state of the data in the inventory. The following states are possible:

#### Active

The version of the file in the inventory is active. You can have only one active version of the file in the inventory.

#### Inactive

The version of the file in the inventory is inactive. You can have multiple inactive versions of the file in the inventory.

### Stored Size

The size of the data, in megabytes (MB) or gigabytes (GB), that is stored in the storage pool.

### Filespace Name

The name of the file space where the file is assigned.

### Type

The type of operation that was used to store the file. The following types are possible:

#### Backup

Files that are backed up.

#### Archive

Files that are archived.

#### SpaceMg

Files that are migrated from an IBM Spectrum Protect™ for Space Management client.

### Client Name

The name of the client that owns the file.

### Protection Date

The time and date that the file was backed up, archived, or migrated by an IBM Spectrum Protect for Space Management client.

## Related commands

Table 1. Commands related to QUERY CLEANUP

Command	Description
CONVERT STGPOOL	Convert a storage pool to a directory-container storage pool.
PROTECT STGPOOL	Protects a directory-container storage pool.
QUERY CONVERSION	Query conversion status of a storage pool.
REMOVE DAMAGED	Removes damaged data from a source storage pool.
REPAIR STGPOOL	Repairs a directory-container storage pool.
REPLICATE NODE	Replicates data in file spaces that belong to a client node.
RESTORE STGPOOL	Restores files to a primary storage pool from copy storage pools.

## QUERY CLOPTSET (Query a client option set)

Use this command to query a client option set.

### Privilege class

Any administrator can issue this command.

### Syntax

```
..*-----  
>>-Query CLOptset--+----->  
                    '-option_set_name-'  
  
>--+-----<<  
    '-DEscription----description-'
```

### Parameters

**option\_set\_name**

Specifies the name of the client option set to be queried. You can use wildcard characters to specify this name. This parameter is optional. The default is option set names.

**DEscription**

Specifies the description used on the DEFINE or UPDATE CLOPTSET commands to be used as a filter. If the description contains spaces, enclose it in quotation marks. This parameter is optional.

### Example: Query a client option set

From a managed server, query a client option set named ENG. Issue the following command:

```
query cloptset eng
```

```
                Optionset:  ENG  
                Description:  
Last Update by (administrator): $$CONFIG_MANAGER$$  
                Managing profile:  
                Replica Option Set: Yes  
  
                Option: SCROLLINES  
                Sequence number: 0  
                Use Option Set Value (FORCE): No  
                Option Value: 40
```

```

Option: SCROLLPROMPT
Sequence number: 0
Use Option Set Value (FORCE): No
Option Value: yes

```

## Field descriptions

### Optionset

Specifies the name of the option set.

### Description

Specifies the description of the client option set.

### Last Update by (administrator)

Specifies the name of the administrator that most recently updated the option set. If this field contains \$\$CONFIG\_MANAGER\$\$, the client option set is associated with a profile that is managed by the configuration manager.

### Managing profile

Specifies the profile to which the managed server subscribed to get the definition of the client option set.

### Replica Option Set

Specifies the replica option set is replicated by the source replication server.

### Option

Specifies the name of the option.

### Sequence number

Specifies the sequence number of the option.

### Use Option Set Value (FORCE)

Specifies whether the server option setting overrides the option setting for the client. NO indicates that the server option setting does not override the client option. YES indicates that the server option setting overrides the client option setting. This option is set with the FORCE parameter on the DEFINE CLIENTOPT command.

### Option Value

Specifies the value of the option.

## Related commands

Table 1. Commands related to QUERY CLOPTSET

Command	Description
COPY CLOPTSET	Copies a client option set.
DEFINE CLIENTOPT	Adds a client option to a client option set.
DEFINE CLOPTSET	Defines a client option set.
DELETE CLIENTOPT	Deletes a client option from a client option set.
DELETE CLOPTSET	Deletes a client option set.
UPDATE CLIENTOPT	Updates the sequence number of a client option in a client option set.
UPDATE CLOPTSET	Updates the description of a client option set.
DEFINE PROFASSOCIATION	Associates objects with a profile.

## QUERY COLLOGROUP (Query a collocation group)

Use this command to display the collocation groups defined on the server.

### Privilege class

Any administrator can issue this command.

### Syntax

```

>>-Query COLLOGroup--*----->

```





See Field descriptions for field descriptions.

## Field descriptions

### Collocation Group Name

The name of the collocation group.

### Collocation Group Description

The description for the collocation group.

### Last Update by (administrator)

The name of the administrator that defined or most recently updated the collocation group.

### Last Update Date/Time

The date and time that an administrator defined or most recently updated the collocation group.

### Collocation Group Member(s)

The members of the collocation group.

### Filespace Member(s)

The file space or file spaces that are members of the collocation group. If there is more than one file space, each file space is displayed in a separate entry.

## Related commands

Table 1. Commands related to QUERY COLLOGROUP

Command	Description
DEFINE COLLOGROUP	Defines a collocation group.
DEFINE COLLOCMEMBER	Adds a client node or file space to a collocation group.
DEFINE STGPOOL	Defines a storage pool as a named collection of server storage media.
DELETE COLLOGROUP	Deletes a collocation group.
DELETE COLLOCMEMBER	Deletes a client node or file space from a collocation group.
MOVE NODEDATA	Moves data for one or more nodes, or a single node with selected file spaces.
QUERY NODE	Displays partial or complete information about one or more clients.
QUERY NODEDATA	Displays information about the location and size of data for a client node.
QUERY STGPOOL	Displays information about storage pools.
REMOVE NODE	Removes a client from the list of registered nodes for a specific policy domain.
UPDATE COLLOGROUP	Updates the description of a collocation group.
UPDATE STGPOOL	Changes the attributes of a storage pool.

AIX

Linux

Windows

## QUERY CONTAINER (Query a container)

Use this command to display information about one or more containers.

### Privilege class

Any administrator can issue this command.

### Syntax

```
>>-Query CONTAINER-+-----+----->
                    .-*-----
                    '-container_name-'
```



## Example: Display information about a container

See Field descriptions for field descriptions.

```
query container /Containers/09/0000000000000943.ncf
```

Container	Storage Pool Name	Container Type	State
/Containers/09/0000000000000943.ncf	STGPOOL1	Non Dedup	Available

Windows

## Example: Display information about a container

See Field descriptions for field descriptions.

```
query container C:\abc\00\0000000000000005.ncf
```

Container	Storage Pool Name	Container Type	State
C:\abc\00\0000000000000005.ncf	STGPOOL1	Non Dedup	Available

AIX | Linux

## Example: Display detailed information about a container

Display detailed information about containers that contain deduplicated data in storage pool STGPOOL1:

```
query container stgpool=STGPOOL1 type=dedup format=detail

          Container: /abc/00/0000000000000001.dcf
Storage Pool Name: STGPOOL1
  Container Type: Dedup
          State: Available
Maximum size (MB): 40,960
  Free Space (MB): 39,700
Approx. Date Last Written: 11/10/2014 15:17:09
  Approx. Date Last Audit:
          Cloud Type:
          Cloud URL:
Space Utilized (MB):
  Object Count:
```

Windows

## Example: Display detailed information about a container

Display detailed information about containers that contain deduplicated data in storage pool STGPOOL1:

```
query container stgpool=STGPOOL1 type=dedup format=detail

          Container: C:\abc\00\0000000000000001.dcf
Storage Pool Name: STGPOOL1
  Container Type: Dedup
          State: Available
Maximum size (MB): 40,960
  Free Space (MB): 39,700
Approx. Date Last Written: 11/10/2014 15:17:09
  Approx. Date Last Audit:
          Cloud Type:
          Cloud URL:
Space Utilized (MB):
  Object Count:
```

## Example: Display detailed information about containers that are stored in a cloud storage pool

Display detailed information about containers that are stored in the cloud storage pool CLOUDPOOL:

```
query container stgpool=CLOUDPOOL format=detail
```

```
Container: 7-64a1261000c811e58e8f005056c00008
Storage Pool Name: CLOUDPOOL
Container Type: Cloud
State:
Free Space (MB):
Maximum Size (MB):
Approx. Date Last Written: 05/22/2015 14:36:57
Approx. Date Last Audit:
Cloud Type: SWIFT
Cloud URL: http://cloudurl:5000/v2.0
Space Utilized (MB): 7104
Object Count: 2472
```

## Field descriptions

---

### Container

The name of the container.

### Storage Pool Name

The name of the storage pool.

### Container Type

The type of container.

### State

The state of the data in the container. The field can contain one of the following values:

#### Available

The container is available for use.

#### Unavailable

The container cannot be opened or validated.

Tip: Issue the AUDIT CONTAINER command to validate the contents of the container.

#### Read only

The container can be read but data cannot be written to the container.

#### Pending

The container is pending deletion. When the value that is specified for the REUSEDELAY parameter expires on the DEFINE STGPOOL or UPDATE STGPOOL command, the container is deleted.

This field does not apply to containers that are stored in cloud storage pools.

### Maximum Size (MB)

The maximum size of the container, in megabytes.

This field does not apply to containers that are stored in cloud storage pools.

### Free Space (MB)

The total amount of free space that is available in the container, in megabytes.

This field does not apply to containers that are stored in cloud storage pools.

### Approx. Date Last Written

The approximate date and time that data was written to the container.

### Approx. Date Last Audit

The approximate date and time that data was audited in the container.

### Cloud Type

If the container is stored in a cloud storage pool, the type of cloud platform.

### Cloud URL

If the container is stored in a cloud storage pool, the URL for accessing the on-premises private cloud or off-premises public cloud.

### Space Utilized (MB)

If the container is stored in a cloud storage pool, the amount of space that is used by the container in the on-premises private cloud or off-premises public cloud.

### Object Count

If the container is stored in a cloud storage pool, the number of objects that are managed by the on-premises private cloud or off-premises public cloud for the container.

Table 1. Commands related to QUERY CONTAINER

Command	Description
AUDIT CONTAINER	Audit a directory-container storage pool.
MOVE CONTAINER	Moves the contents of a storage pool container to another container.
QUERY DAMAGED	Displays information about damaged files.

## QUERY CONTENT (Query the contents of a storage pool volume)

Use this command to display information about files in a storage pool volume, and the names of client files that link to a deduplicated group of files.

You can use this command to identify files that the server found to be damaged and files that were backed up to a copy storage pool or copied to an active-data pool. This command is useful when a volume is damaged or before you:

- Request the server to fix inconsistencies between a volume and the database
- Move files from one volume to another volume
- Delete a volume from a storage pool

Because this command can take a long time to run and the results can be large, consider using the COUNT parameter to limit the number of files displayed.

Note: Files that are cached in a disk volume and that are marked as damaged are not included in the results.

### Privilege class

Any administrator can issue this command.

### Syntax

```
>>-Query CONtEnt--volume_name--+-----+----->
                                '-NODE---node_name-'

>--+-----+-----+----->
  '-Filespace---file_space_name-' '-COUnT---number-'

  .-Type---ANY----- .-Format---Standard-----
>--+-----+-----+----->
  '-Type---+ANY-----+' '-Format---+Standard-+-'
      +-Backup-----+          '-Detailed-'
      +-Archive-----+
      '-Spacemanaged-'

                                (1)

  .-DAMaged---ANY----- .-COPIed-----ANY-.
>--+-----+-----+----->
  '-DAMaged---+ANY-+-' '-COPIed---+ANY-+-'
      +-Yes-+          +-Yes-+
      '-No--'          '-No--'

  .-NAMEType---SERVER-----
>--+-----+-----+----->
  '-NAMEType---+SERVER-+-'
      +-UNICODE-+
      '-FSID----'

  .-CODEType---BOTH-----
>--+-----+-----+----->
  '-CODEType---+UNICODE-+-'
      +-NONUNICODE-+
      '-BOTH-----'

  .-FOLLOWLinks---No-----
>--+-----+-----+-----><
  '-FOLLOWLinks---+No-----+'
      +-Yes-----+
```

Notes:

1. Use this parameter only for volumes in primary storage pools.

## Parameters

---

volume\_name (Required)

Specifies the volume to be queried.

NODE

Specifies the backup-archive client or the IBM Spectrum Protect™ for Space Management associated with the file space to query. This parameter is optional. You can use wildcard characters to specify this name. If you do not specify a name, all backup-archive and IBM Spectrum Protect for Space Management clients are included.

FIlespace

Specifies the file space to query. This parameter is optional. You can use wildcard characters to specify this name. File space names are case-sensitive. If you do not specify a file space name, all file spaces are included.

For a server that has clients with Unicode support, you might need to have the server convert the file space name that you enter. For example, you might need to have the server convert the name that you enter from the server's code page to Unicode. See the NAMETYPE parameter for details. If you do not specify a file space name or specify only a single wildcard character for the name, you can use the CODETYPE parameter to limit the operation to Unicode file spaces or non-Unicode file spaces.

COUnt

Specifies the number of files to be displayed. This parameter is optional. You can specify either a positive integer or a negative integer. If you specify a positive integer, *n*, the first *n* files are displayed. If you specify a negative integer, *-n*, the last *n* files are displayed in *reverse* order. You cannot specify COUNT=0. If you do not specify a value for this parameter, all files are displayed.

Type

Specifies the types of files to query. This parameter is optional. The default value is ANY. If the volume that is being queried is assigned to an active-data pool, the only valid values are ANY and BACKUP. Possible values are:

ANY

Specifies that all types of files in the storage pool volume are queried; backup versions of files, archived copies of files, and files that are migrated by IBM Spectrum Protect for Space Management clients from client nodes.

Backup

Specifies that only backup files are queried.

Archive

Specifies that only archive files are queried. This value is not valid for active-data pools.

SPacemanaged

Specifies that only space-managed files (files that were migrated by an IBM Spectrum Protect for Space Management client) are queried. This value is not valid for active-data pools.

Format

Specifies how the information is displayed. This parameter is optional. The default value is STANDARD. Possible values are:

Standard

Specifies that partial information is displayed. Unicode names are converted to the server code page.

Detailed

Specifies that complete information is displayed. Unicode names are displayed in hexadecimal.

DAMaged

Specifies criteria to restrict the query output based on whether files are marked as damaged. For purposes of this criteria, the server examines only physical files (a file that might be a single logical file or an aggregate that consists of logical files). This parameter is optional. The default value is ANY. Possible values are:

ANY

Specifies that files are displayed regardless of whether the server found the files to be damaged.

Yes

Specifies that only files that are marked as damaged are displayed. These are files in which the server found errors when a user attempted to restore, retrieve, or recall the file, or when an AUDIT VOLUME command was run.

No

Specifies that only files not known to be damaged are displayed.

#### COPIED

Specifies criteria to restrict the query output based on whether files were backed up to a copy storage pool. Whether files are stored in an active-data pool does not affect the output. This parameter is optional. The default value is ANY. Possible values are:

##### ANY

Specifies that files are displayed regardless of whether the files are backed up to a copy storage pool. Primary and cached file copies are displayed.

##### Yes

Specifies that the files displayed are only those for which at least one usable backup copy exists in a copy storage pool. A file is not displayed if its copy in the copy storage pool is known to have errors. Cached file copies are not displayed because these files are never restored.

Use COPIED=YES to identify primary files that can be restored using the RESTORE VOLUME or RESTORE STGPOOL command.

##### No

Specifies that the files displayed are only those for which no usable backup copies exist in a copy storage pool. Cached file copies are not displayed because these files are never restored.

Use COPIED=NO to identify primary files that cannot be restored using the RESTORE VOLUME or RESTORE STGPOOL command.

#### NAMETYPE

Specify how you want the server to interpret the file space names that you enter. This parameter is useful when the server has clients with Unicode support. A backup-archive client with Unicode support is currently available only for Windows, Macintosh OS 9, Macintosh OS X, and NetWare. Use this parameter only when you specify a partly or fully qualified file space name.

The default value is SERVER. Possible values are:

##### SERVER

The server uses the server's code page to interpret the file space names.

##### UNICODE

The server converts the file space names from the server code page to the UTF-8 code page. The success of the conversion depends on the actual characters in the names and the server's code page. Conversion can fail if the string includes characters that are not available in the server code page, or if the server has a problem accessing system conversion routines.

##### FSID

The server interprets the file space names as their file space IDs (FSIDs).

#### CODETYPE

Specify how you want the server to interpret the file space names that you enter. Use this parameter only when you enter a single wildcard character for the file space name.

The default value is BOTH, which means that the file spaces are included regardless of code page type. Possible values are:

##### UNICODE

Include file spaces that are only in Unicode.

##### NONUNICODE

Include file spaces that are not only in Unicode.

##### BOTH

Include file spaces regardless of code page type.

#### FOLLOWLINKS

Specifies whether to display only the files that are stored on the volume or only files that are linked to the volume. You can also display both stored files and linked files. The default is NO. Possible values are:

##### No

Display only the files that are stored in the volume. Do not display files that have links to the volume.

##### Yes

Display all files, including files that are stored on the volume and any files that have links to the volume.

##### JUSTLINKS



Display only the files that have links to the volume. Do not display files that are stored on the volume.

## Example: Display the contents of a volume for a specific client node

Query the contents of a volume and limit the results to files backed up from the PEGASUS client node.

**AIX** | **Linux** For the volume /tsmstg/diskvol1.dsm, issue the command:

```
query content /tsmstg/diskvol1.dsm node=pegasus
type=backup
```

**Windows** For the volume f:\tsmstg\diskvol1.dsm, issue the command:

```
query content f:\tsmstg\diskvol1.dsm node=pegasus
type=backup
```

Results of the command include all logical files that make up any aggregate that is on the volume, even if the aggregate is stored on more than this volume. For aggregates, the query does not determine which logical files are actually stored on the volume for which the query is performed.

Node Name	Type	Filespace Name	FSID	Client's Name for File
PEGASUS	Bkup	\\pegasus\e\$	1	\UNI_TEST\ SM01.DAT
PEGASUS	Bkup	\\pegasus\e\$	1	\UNI_TEST\ SM02.DAT

See Field descriptions for field descriptions.

## Example: Display detailed information for a tape volume

Query the contents of the tape volume named WPD001. Display only files that are backed up by the node MARK, and files that are either stored on the volume or linked to the volume. Display only the first four files on the volume.

```
query content wpd001 node=mark count=4 type=backup followlinks=yes
format=detailed
```

```
Node Name: MARK
Type: Bkup
Filespace Name: \\mark\e$
Hexadecimal Filespace Name:
FSID: 1
Client's Name for File: \UNI_TEST\ SM01.DAT
Hexadecimal Client's Name for File:
Aggregated?: 1/3
Stored Size: 2,746
Segment Number:
Cached Copy?: No
Linked: No
Fragment Number:
```

```
Node Name: MARK
Type: Bkup
Filespace Name: \\mark\e$
Hexadecimal Filespace Name:
FSID: 1
Client's Name for File: \UNI_TEST\ SM02.DAT
Hexadecimal Client's Name for File:
Aggregated?: 2/3
Stored Size: 2,746
Segment Number:
Cached Copy?: No
Linked: No
Fragment Number: 2
```

```
Node Name: MARK
Type: Bkup
Filespace Name: \\mark\e$
Hexadecimal Filespace Name:
FSID: 1
Client's Name for File: \UNI_TEST\ SM03.DAT
Hexadecimal Client's Name for File:
Aggregated?: 3/3
```

Stored Size: 2,746  
Segment Number:  
Cached Copy?: No  
Linked: No  
Fragment Number: 3

See Field descriptions for field descriptions.

## Field descriptions

---

### Node Name

The node to which the file belongs.

### Type

The type of file: archive (Arch), backup (Bkup), or space-managed (SpMg) by an IBM Spectrum Protect for Space Management client.

### Filespace Name

The file space to which the file belongs.

File space names can be in a different code page or locale than the server. If they are, the names in the Operations Center and the administrative command-line interface might not be displayed correctly. Data is backed up and can be restored normally, but the file space name or file name might be displayed with a combination of invalid characters or blank spaces.

If the file space name is Unicode-enabled, the name is converted to the server code page for display. The success of the conversion depends on the operating system, the characters in the name, and the server code page. Conversion can be incomplete if the string includes characters that are not available in the server code page or if the server cannot access system conversion routines. If the conversion is incomplete, the name might contain question marks, blanks, unprintable characters, or ellipses (...).

### Hexadecimal Filespace Name

The file space to which the file belongs. If the file space name is in Unicode, the name is displayed in hexadecimal format.

### FSID

The file space ID (FSID) for the file space. The server assigns a unique FSID when a file space is first stored on the server.

### Client's Name for File

The client's name for the file.

File space names and file names that can be in a different code page or locale than the server do not display correctly in the Operations Center or the administrative command-line interface. The data itself is backed up and can be restored properly, but the file space or file name might display with a combination of invalid characters or blank spaces. The results of the conversion for characters that are not supported by the current code page depends on the operating system. For names that IBM Spectrum Protect is able to partially convert, you might see question marks (??), blanks, unprintable characters, or "...". These characters indicate to the administrator that files do exist.

### Hexadecimal Client's Name for File

The client's name for the file that is displayed in hexadecimal format.

### Aggregated?

Whether the file is a logical file that is stored as part of an aggregate. If the file is part of an aggregate, the sequence of this file within the aggregate and the total number of logical files in the aggregate are displayed. Results of the command include all logical files that make up any aggregate that is on the volume, even if the aggregate is stored on more than this volume. The query does not determine which logical files are actually stored on the volume for which the query is performed.

If the file is not part of an aggregate, the field displays "no".

### Stored Size

The size of the physical file, in bytes. If the file is a logical file that is stored as part of an aggregate, this value indicates the size of the entire aggregate.

### Segment Number

For volumes in sequential-access storage pools, specifies whether the physical file (either a single logical file or an aggregate of logical files) is stored across multiple volumes. For example, if the logical file is stored in an aggregate that spans two volumes, the segment number indicates 1/2 (the first part of the physical file is stored on the volume) or 2/2 (the second part of the physical file is stored on the volume). If the segment number is 1/1, the physical file is completely stored on the volume. For volumes in random-access storage pools, no value is displayed for this field.

### Cached Copy?

Whether the physical file is a cached copy of a file migrated to the next storage pool. If the file is part of an aggregate, this value pertains to the aggregate.

Linked

Indicates whether the file is stored on the volume or whether the file is linked to the volume.

Fragment Number

Specifies the fragment number. If the fragment number is blank, it is either the first fragment or not a fragment.

## Related commands

Table 1. Commands related to QUERY CONTENT

Command	Description
BACKUP STGPOOL	Backs up a primary storage pool to a copy storage pool.
COPY ACTIVATEDATA	Copies active backup data.
DEFINE VOLUME	Assigns a volume to be used for storage within a specified storage pool.
DELETE VOLUME	Deletes a volume from a storage pool.
RESTORE STGPOOL	Restores files to a primary storage pool from copy storage pools.
RESTORE VOLUME	Restores files stored on specified volumes in a primary storage pool from copy storage pools.
UPDATE VOLUME	Updates the attributes of storage pool volumes.

AIX Linux Windows

## QUERY CONVERSION (Query conversion status of a storage pool)

Use this command to display information about a conversion operation. You can convert a primary storage pool that uses a FILE type device class or a virtual tape library (VTL) to a directory-container storage pool.

### Privilege class

To issue this command, you must have restricted storage privilege.

### Syntax

```
>>-Query CONVERsion--+-+-----+----->
                        '-pool_name-'
.-Format---Standard----.
>--+-----+-----<<
  '-Format---+-Standard-+-'
                        '-Detailed-'
```

### Parameters

pool\_name

Specifies the source storage pool to query. This parameter is optional. If you do not specify a value for this parameter, information is displayed for all storage pools.

Format

Specifies how the information is displayed. This parameter is optional. The default value is STANDARD. Specify one of the following values:

Standard

Specifies that partial information is displayed.

Detailed

Specifies that complete information is displayed.

### Example: Display conversion information for all storage pools

Display conversion information for all storage pools. See Field descriptions for field descriptions.

```
query conversion
```

Source Storage Pool	Target Storage Pool	Starting Amount	Total Converted	Last Converted
FILEPOOL	CTR	3 GB	3 GB	3 GB
FPOOL	CTR	333 MB	333 MB	267 MB

## Example: Display detailed about storage pool conversion

Display detailed information about storage pool conversion. See Field descriptions for field descriptions.

```
query conversion format=detailed
```

```
Source Storage Pool: FILEPOOL
Target Storage Pool: CTR
Maximum Processes: 4
    Duration: 60 minutes
Starting Amount: 333 MB
Total Converted: 333 MB
Last Converted: 333 MB
Start Date/Time: 03/24/2016 13:22:32
```

## Field descriptions

### Source Storage Pool

The name of the storage pool that is being converted.

### Target Storage Pool

The name of the destination storage pool, where the converted data will be stored.

### Maximum Processes

Specifies the maximum number of conversion processes.

### Duration

Specifies the length of time, in minutes, for conversion.

### Starting Amount

The starting amount of data to convert, in megabytes (MB), gigabytes (GB), or terabytes (TB).

### Total Converted

The total amount of data that is converted, in megabytes (MB), gigabytes (GB), or terabytes (TB).

### Last Converted

The amount of data, in megabytes (MB), gigabytes (GB), or terabytes (TB), that is converted during this conversion process.

### Start Date/Time

The time and date that the CONVERT STGPOOL command was first issued for the storage pool.

## Related commands

Table 1. Commands related to QUERY CONVERSION

Command	Description
CONVERT STGPOOL	Convert a storage pool to a directory-container storage pool.
QUERY CLEANUP	Query the cleanup status of a source storage pool.

## QUERY COPYGROUP (Query copy groups)

Use this command to display information about one or more copy groups.

## Privilege class

Any administrator can issue this command.

## Syntax

```
>>-Query COpYgroup----->
```



ENGPOLDOM	STANDARD	MCENG	STANDARD	5	4	90	600
ENGPOLDOM	STANDARD	STANDARD	STANDARD	2	1	30	60
ENGPOLDOM	TEST	STANDARD	STANDARD	2	1	30	60

## Example: Display detailed information on one backup copy group

---

Display complete information on the backup copy group assigned to the ACTIVEFILES management class in the VACATION policy set of the EMPLOYEE\_RECORDS policy domain. Issue the command:

```
query copygroup employee_records vacation
activefiles format=detailed
```

## Example: Display information on the backup copy group in the STANDARD management class and policy set

---

From a managed server, display complete information on the backup copy group assigned to the STANDARD management class in the STANDARD policy set of the ADMIN\_RECORDS policy domain. Issue the command:

```
query copygroup admin_records
standard standard format=detailed

Policy Domain Name: ADMIN_RECORDS
Policy Set Name: STANDARD
Mgmt Class Name: STANDARD
Copy Group Name: STANDARD
Copy Group Type: Backup
Versions Data Exists: 2
Versions Data Deleted: 1
Retain Extra Versions: 30
Retain Only Version: 60
Copy Mode: Modified
Copy Serialization: Shared Static
Copy Frequency: 0
Copy Destination: BACKUPOOL
Table of Contents (TOC) Destination:
Last Update by (administrator): $$CONFIG_MANAGER$$
Last Update Date/Time: 2002.10.02 17.51.49
Managing profile: ADMIN_INFO
Changes Pending: Yes
```

## Example: Display information on an archive copy group

---

From a managed server, display complete information on the archive copy group STANDARD that is assigned to the MCLASS1 management class in the SUMMER policy set of the PROG1 policy domain. Issue the command:

```
query copygroup prog1 summer mclass1
type=archive format=detailed

Policy Domain Name: PROG1
Policy Set Name: SUMMER
Mgmt Class Name: MCLASS1
Copy Group Name: STANDARD
Copy Group Type: Archive
Retain Version: 730
Retention Initiation: Creation
Minimum Retention:
Copy Serialization: Shared Static
Copy Frequency: Cmd
Copy Mode: Absolute
Copy Destination: ARCHPOOL
Last Update by (administrator): $$CONFIG_MANAGER$$
Last Update Date/Time: 2002.10.02 17.42.49
Managing profile: ADMIN_INFO
```

## Example: Display information on the copy group for a NAS backup

---

Query the copy group for the NAS backup. Issue the command:

```
query copygroup nasdomain
type=backup
```

```
Policy Domain Name: NASDOMAIN
Policy Set Name: ACTIVE
Mgmt Class Name: STANDARD
Copy Group Name: STANDARD
Copy Group Type: Backup
Versions Data Exists: 2
Versions Data Deleted: 1
Retain Extra Versions: 30
Retain Only Version: 60
Copy Mode: Modified
Copy Serialization: Shared Static
Copy Frequency: 0
Copy Destination: NASPOOL
Table of Contents (TOC) Destination: BACKUPPOOL
Last Update by (administrator): SERVER_CONSOLE
Last Update Date/Time: 10/02/2002 12:16:52
Managing profile:
Changes Pending: Yes
```

## Field descriptions

---

### Policy Domain Name

The name of the policy domain.

### Policy Set Name

The name of the policy set.

### Mgmt Class Name

The name of the management class.

### Copy Group Name

The name of the copy group. This name is always STANDARD.

### Copy Group Type

The type of the copy group.

### Versions Data Exists

The maximum number of backup versions to retain for files that are currently on the client file system.

### Versions Data Deleted

The maximum number of backup versions to retain for files that have been deleted from the client file system after being backed up using IBM Spectrum Protect™.

### Retain Extra Versions

The number of days to retain a backup version after that version becomes inactive.

### Retain Only Version

The number of days to retain the last backup version of a file that has been deleted from the client file system.

### Copy Serialization

Whether a file can be in use during an archive operation.

### Copy Frequency

The copy frequency of the copy group. For archive copy groups, this value is always CMD.

### Copy Mode

Specifies that files in the copy group are archived regardless of whether they have been modified. For archive copy groups, this value is always ABSOLUTE.

### Copy Destination

The name of the storage pool where the server initially stores files associated with this archive copy group.

### Table of Contents (TOC) Destination

The name of the primary storage pool in which TOCs are initially stored for image backup operations in which TOC generation is requested.

### Last Update by (administrator)

The name of the administrator or server that most recently updated the copy group. If this field contains \$\$CONFIG\_MANAGER\$\$, the copy group is associated with a domain that is managed by the configuration manager.

### Last Update Date/Time

The date and time when the copy group was most recently defined or updated.

### Managing Profile

The profile or profiles to which the managed server subscribed to get the definition of this policy copy group.

### Changes Pending

Whether or not changes are being made but not activated. Once the changes are activated, the field resets to No.

## Related commands

---

Table 1. Commands related to QUERY COPYGROUP

Command	Description
DEFINE COPYGROUP	Defines a copy group for backup or archive processing within a specified management class.
DELETE COPYGROUP	Deletes a backup or archive copy group from a policy domain and policy set.
UPDATE COPYGROUP	Changes one or more attributes of a copy group.

AIX Linux Windows

## QUERY DAMAGED (Query damaged data in a directory-container or cloud-container storage pool)

Use this command to display information about damaged data extents in a directory-container or cloud-container storage pool. Use this command together with the AUDIT CONTAINER command to determine a recovery method for the damaged data.

### Privilege class

Any administrator can issue this command.

### Syntax

```
>>-Query DAMaged--pool_name----->>
. -Type-----Status-----
>--+-----+----->>
' -Type-----+INventory-----+'
    +-Node--| A |-----+
    '-CONTAINER--| A |-'
```

A (Additional filter by node name)

```
|--+-----+-----|
' -Nodename-----node_name-'
```

### Parameters

pool\_name (Required)

Specifies the name of the directory-container or cloud storage pool.

Type

Specifies the type of information to display. This parameter is optional. Specify one of the following values:

Status

Specifies that information is displayed about damaged data extents. For cloud storage pools, orphaned extents are also displayed. This is the default.

Node

Specifies that information about the number of damaged files per node is displayed.

INventory

Specifies that inventory information for each damaged file is displayed.

CONTAINER

Specifies that the containers that contain damaged data extents or cloud orphaned extents are displayed. For directory-container storage pools, storage pool directories are also displayed.

Nodename

Specifies that damaged file information for a single node is displayed.

Restriction: You cannot specify this parameter if the TYPE=CONTAINER or TYPE=STATUS parameter is specified.

### Example: Display status information about damaged or orphaned data extents

Display information about the status of damaged data extents that are stored in a container.



```
query damaged pool1 type=status
```

Storage Pool Name	Non-Dedup Data Extent Count	Dedup Data Extent Count	Cloud Orphaned Extent Count
POOL1	58	145	

For cloud storage pools, the number of orphaned extents is also displayed.

Storage Pool Name	Non-Dedup Data Extent Count	Dedup Data Extent Count	Cloud Orphaned Extent Count
POOL1	65	238	18

## Example: Display information about a damaged file for a node type

---

Display information about damaged files that are stored in a node.

```
query damaged pool1 type=node
```

Node Name	Number of Damaged Files
POOL1	37

## Example: Display information about a damaged file for an inventory type

---

Display information about damaged files that are stored in an inventory.

```
query damaged pool2 type=inventory
```

```
Client's Name for File: /data/files/10.out
Type: Bkup
Node Name: NODE1
Filespace Name: /data/space
State: Available
Insertion time: 01/19/2015 16:01:35
Object ID: 2073
```

## Example: Display information about a damaged file for a container type

---

Display information about damaged files that are stored in a container.

```
query damaged pool3 type=container
```

```
Directory ID: 1
Directory: /abc/space/container1
Container: /abc/space/container1/00/0000000000000022.dcf
State: Unavailable
```

For cloud containers, only the name of the container is displayed.

```
Directory ID:
Directory:
Container: ibmsp.12520ae05b4011e613320a0027000000/
001-10006a3278bc34f0e4118a850090fa3dcb48/
00000000000001.ncf
State:
```

For local storage, the following information about a damaged container is displayed.

```
Directory ID: 1
Directory: localdirectory
Container: localdirectory/00/000000000000011.ncf
State: Unavailable
```

## Field descriptions

---

Client's Name for File (TYPE=INVENTORY only)

The name of the file.

Cloud Orphaned Extent Count (TYPE=STATUS only)

The number of orphaned extents in a cloud storage pool. Extents are considered orphaned if they do not have a corresponding database entry.

Container (TYPE=CONTAINER only)

The name of the container.

Deduplicated Extent Count (TYPE=STATUS only)

The number of damaged extents in the storage pool for deduplicated data.

Directory (TYPE=CONTAINER only)

The name of the storage pool directory.

Directory ID (TYPE=CONTAINER only)

The identification number of the storage pool directory.

Filespace Name (TYPE=INVENTORY only)

The name of file space.

Insertion time (TYPE=INVENTORY only)

The date and time that the object was stored on the server.

Node Name (TYPE=INVENTORY or TYPE=NODE only)

The name of the node.

Non-Deduplicated Extent Count (TYPE=STATUS only)

The number of damaged extents in the storage pool for data that is not deduplicated, such as metadata and client-encrypted data.

Number of Damaged Files (TYPE=NODE only)

The number of damaged files per node.

Object ID (TYPE=INVENTORY only)

The identification number of the object.

State (TYPE=INVENTORY or TYPE=CONTAINER only)

The state of the data in either the inventory or the container, depending on the type of data you are querying. The field can contain one of the following values:

Active

The version of the file in the inventory is active. There can be only one active version of the file in the inventory.

Inactive

The version of the file in the inventory is inactive. There can be multiple inactive versions of the file in the inventory.

Available

The state of the container is available.

Unavailable

The state of the container is unavailable. For example, a container might be unavailable if the header is corrupted or if the container cannot be opened.

Read-Only

The container is in a read-only state. Data in the container can be read, but data cannot be written to the container.

Pending

The container is pending deletion. The contents of the container were moved to a different container, and the container is ready to be deleted.

Type (TYPE=INVENTORY only)

The type of data in the file.

Table 1. Commands related to QUERY DAMAGED

Command	Description
AUDIT CONTAINER	Audit a directory-container storage pool.
QUERY CLEANUP	Query the cleanup status of a source storage pool.
QUERY CONTAINER	Displays information about a container.
REMOVE DAMAGED	Removes damaged data from a source storage pool.

## QUERY DATAMOVER (Display data mover definitions)

Use this command to display data mover definitions.

## Privilege class

Any administrator can issue this command.

## Syntax

```
.-*-----
>>-Query DATAMover----->
      '-data_mover_name-'

.-Format----Standard----.
>----->
      '-Format---+Standard-+'
          '-Detailed-'

.-Type----*-----
>----->>
      |                               (1) (2) |
      '-Type---+NAS-----+'
          +-NASCLUSTER-+
          '-NASVSERVER-'
```

Notes:

1. You must specify the TYPE parameter if FORMAT=DETAILED.
2. You can specify TYPE=NASCLUSTER and TYPE=NASVSERVER only on an AIX, Linux, or Windows operating system.

## Parameters

**data\_mover\_name**

Specifies the name of the data mover to display. You can specify multiple names with a wildcard character. The default displays all data movers.

**Format**

Specifies how the information is displayed. This parameter is optional. The default is STANDARD.

**Standard**

Specifies that name and address information is displayed.

**Detailed**

Specifies that complete information is displayed.

**Type**

Specifies the type of data mover to be displayed. If you specify FORMAT=DETAILED, you must specify a value for the TYPE parameter.

**NAS**

Specifies a NAS file server.

**AIX** | **Linux** | **Windows** | **NASCLUSTER**

**AIX** | **Linux** | **Windows** | **Windows** | Specifies a clustered NAS file server.

**AIX** | **Linux** | **Windows** | **NASVSERVER**

**AIX** | **Linux** | **Windows** | Specifies a virtual storage device within a cluster.

## Example: Display information about all data movers

Display the data movers on the server. Issue the command:

```
query datamover
```

```
Data Mover Name   Data Mover Type   Online
-----
NASMOVER1         NAS                Yes
NASMOVER2         NAS                No
```

See Field descriptions for field descriptions.

## Example: Display information about one data mover

---

Display partial information about data mover DATAMOVER6. Issue the command:

```
query datamover datamover6 type=nas

Source Name      Type           Online
-----
DATAMOVER6      NAS           Yes
```

See Field descriptions for field descriptions.

## Example: Display detailed information about one data mover

---

Display detailed information about data mover DATAMOVER6. The TYPE parameter is required when FORMAT=DETAILED. Issue the command:

```
query datamover datamover6 format=detailed type=nas

Data Mover Name:    DataMover6
Data Mover Type:    NAS
IP Address:         198.51.100.0
TCP/IP Port Number: 10000
User Name:          NDMPadmin
Storage Pool Data Format: NDMPDUMP
Online:             Yes
Last Update by (administrator): ADMIN
Last Update Date/Time: 05/23/2015 09:26:33
```

See Field descriptions for field descriptions.

[AIX](#) | [Linux](#) | [Windows](#)

## Example: Display detailed information about a clustered NAS data mover

---

Display detailed information about a clustered NAS data mover that is named CLUSTERA. Issue the following command:

```
query datamover clustera format=detailed type=nascluster

Data Mover Name:    CLUSTERA
Data Mover Type:    NASCLUSTER
IP Address:         192.0.2.255
TCP/IP Port Number: 10000
User Name:          ndmp
Storage Pool Data Format: NETAPPDUMP
Online:             Yes
Last Update by (administrator): ADMIN
Last Update Date/Time: 04/28/2015 09:26:33
```

See Field descriptions for field descriptions.

## Field descriptions

---

- Data Mover Name  
Specifies the name of the data mover.
- Data Mover Type  
Specifies the type of the data mover.
- IP Address  
Specifies the IP address of the data mover.
- TCP/IP Port Number  
Specifies the TCP port number for the data mover.
- User Name  
Specifies the user ID that the server uses to access the data mover.
- Storage Pool Data Format  
Specifies the data format that is used by the data mover.
- Online  
Specifies whether the data mover is online and available for use.
- Last Update by (administrator)  
Specifies the ID of the administrator who completed the last update.

Last Update Date/Time  
Specifies the date and time when the last update occurred.

## Related commands

---

Table 1. Commands related to QUERY DATAMOVER

Command	Description
DEFINE DATAMOVER	Defines a data mover to the IBM Spectrum Protect server.
DELETE DATAMOVER	Deletes a data mover.
UPDATE DATAMOVER	Changes the definition for a data mover.

## QUERY DB (Display database information)

---

Use this command to display information about the database.

### Privilege class

---

Any administrator can issue this command.

### Syntax

---

```
.-Format----Standard-----.  
>>-Query DB--+-----+----->>  
'-Format----+Standard--+'  
'-Detailed-'
```

### Parameters

---

#### Format

Specifies how the information is displayed. This parameter is optional. The default is STANDARD. The following values are possible:

#### Standard

Specifies that partial information is displayed.

#### Detailed

Specifies that complete information is displayed.

### Example: Display summary statistics about the database

---

Display statistical information about the database. Issue the command:

```
query db
```

```
Database Name  Total Pages  Usable Pages  Used Pages  Free Pages  
-----  
TSMDB1        32,776      32,504        24,220      8,284
```

See Field descriptions for field descriptions.

### Example: Display detailed database information

---

Display detailed statistical information about the database. Issue the command:

```
query db format=detailed
```

```
Database Name: TSM_DB2  
Total Space of File System (MB): 1,748,800  
Space Used on File System (MB): 2,304,355  
Space Used by Database (MB): 448  
Free Space Available (MB): 235,609  
Total Pages: 32,776
```

```

        Usable Pages: 32,504
        Used Pages: 24,220
        Free Pages: 8,284
    Buffer Pool Hit Ratio: 99.3
    Total Buffer Requests: 204,121
        Sort Overflows: 0
    Package Cache Hit Ratio: 89.8
    Last Database Reorganization: 05/25/2009 16:44:06
        Full Device Class Name: FILE
    Number of Database Backup Streams: 4
        Incrementals Since Last Full: 0
    Last Complete Backup Date/Time: 05/18/2009 22:55:19
        Compress Database Backups: Yes
        Protect Master Encryption Key: No

```

See Field descriptions for field descriptions.

## Field descriptions

---

### Database Name

The name of the database that is defined and configured for use by the IBM Spectrum Protect™ server.

**AIX** | **Linux** Total Space of File System (MB)

The total space, in megabytes, of the file systems in which the database is located.

**Windows** Total Space of File System (MB)

The total space, in megabytes, of the drives on which the database is located.

### Space Used on File System (MB)

The amount of database space, in megabytes, that is in use.

### Space Used by Database (MB)

The size of the database, in megabytes. The value does not include any temporary table space. The size of the database is calculated from the amount of space that is used on the file system containing the database.

### Free Space Available (MB)

The amount of database space, in megabytes, that is not in use.

### Total Pages

The total number of pages in the table space.

### Usable Pages

The number of usable pages in the table space.

### Used Pages

The number of used pages in the table space.

### Free Pages

The total number of free pages in all table spaces. The IBM Spectrum Protect database has up to 10 table spaces.

### Buffer Pool Hit Ratio

The total hit ratio percent.

### Total Buffer Requests

The total number of buffer pool data logical reads and index logical reads since the last time the database was started or since the database monitor was reset.

### Sort Overflows

The total number of sorts that ran out of the sort heap and might have required disk space for temporary storage.

### Package Cache Hit Ratio

A percentage that indicates how well the package cache is helping to avoid reloading packages and sections for static SQL from the system catalogs. It also indicates how well the package cache is helping to avoid recompiling dynamic SQL statements. A high ratio indicates that it is successful in avoiding these activities.

### Last Database Reorganization

The last time that the database manager completed an automatic reorganization activity.

### Full Device Class Name

The name of the device class that is used for full database backups.

### Number of Database Backup Streams

The number of concurrent data movement streams that were used during the database backup.

### Incrementals Since Last Full

The number of incremental backups that were completed since the last full backup.

### Last Complete Backup Date/Time

The date and time of the last full backup.

### Compress Database Backups

Specifies whether database backups are compressed.

### Protect Master Encryption Key

Specifies whether database backups include a copy of the server master encryption key.

## Related commands

Table 1. Commands related to QUERY DB

Command	Description
BACKUP DB	Backs up the IBM Spectrum Protect database to sequential access volumes.
EXTEND DBSPACE	Adds directories to increase space for use by the database.
QUERY DBSPACE	Displays information about the storage space defined for the database.

## QUERY DBSPACE (Display database storage space)

Use this command to display information about the directories used by the database to store data.

### Privilege class

Any administrator can issue this command.

### Syntax

```
>>-QUERY DBSpace-----<<
```

### Parameters

None.

### Example: Display database storage space information

Display information about database storage space. Issue the command:

```
query dbspace
```

AIX		Linux	
Location	Total Space of File System (MB)	Used Space on File System (MB)	Free Space Available (MB)
-----	-----	-----	-----
/tsmdb001	1,748,800	1,513,191.125	117,804.422
/tsmdb002	1,748,800	1,513,191.125	117,804.422

Windows			
Location	Total Space of File System (MB)	Used Space on File System (MB)	Free Space Available (MB)
-----	-----	-----	-----
d:\tsm\db001	1,748,800	1,513,191.125	117,804.422
e:\tsm\db002	1,748,800	1,513,191.125	117,804.422

See Field descriptions for field descriptions.

### Field descriptions

Location

Specifies the locations of database directories.

**AIX** Total Space of File System (MB)

**AIX** The total amount of space, in megabytes, of the file system in which the database is located.

**Windows** Total Space of File System (MB)

**Windows** The total amount of space, in megabytes, of the drives on which the database is located.

Used Space on File System (MB)

The amount of storage space, in megabytes, that is in use.

**AIX** | **Linux** When you run the QUERY DBSPACE command, the value in the output might be greater than the value that is obtained by running the df system command. The output from the df system command does not include the amount of space that is reserved for the root user.

**Linux** If you run the df system command, the default percentage of space that is reserved for the root user is 5%. You can change this default value.

Free Space Available (MB)

The amount of space, in megabytes, that is not in use.

**Windows** Free Space Available (MB)

**Windows** The amount of space remaining on the drive where the directory is located.

## Related commands

Table 1. Commands related to QUERY DBSPACE

Command	Description
BACKUP DB	Backs up the IBM Spectrum Protect database to sequential access volumes.
EXTEND DBSPACE	Adds directories to increase space for use by the database.
QUERY DB	Displays allocation information about the database.

**AIX** | **Linux** | **Windows**

## QUERY DEDUPSTATS (Query data deduplication statistics)

Use this command to display information about data deduplication statistics for a directory-container storage pool or a cloud storage pool.

You must issue the GENERATE DEDUPSTATS command before you can issue the QUERY DEDUPSTATS command.

### Privilege class

Any administrator can issue this command.

### Syntax

```
>>-Query DEDUPStats--+-+-----+-----+-----+----->
                        '-pool_name-' '-node_name-'

.-*-----.-.-Format---Standard-----
>+-----+-----+-----+----->
| .-,-----.- | '-Format---+Standard+-'
| V             | |                       '-Detailed-'
+---file_space_name---+
| .-,-----.- |
| V             |
'-----FSID---+-----'

.-CODEType---BOTH-----
>+-----+-----+-----+----->
'-CODEType---+UNICODE---+
                    +-NONUNICODE+
                    '-BOTH-----'

.-NAMEType---SERVER-----
>+-----+-----+-----+----->
'-NAMEType---+SERVER---+' '-BEGINDate---date-'
                    +-UNICODE+
                    '-FSID---'

>+-----+-----+-----+----->
'-BEGINTime---time-' '-ENDDate---date-'
```





The server converts the file space name that is entered from the server code page to the UTF-8 code page. The success of the conversion depends on the actual characters in the name and the server's code page. Conversion can fail if the string includes characters that are not available in the server code page, or if the server cannot access system conversion routines.

#### FSID

The server interprets the file space names as their FSIDs.

#### BEGINDate

Specifies the start date to query data deduplication statistics. This parameter is optional. You can use this parameter with the BEGINTIME parameter to specify a range for the date and time. If you specify a begin date without a begin time, the time is at 12:00 a.m. (midnight) on the date you specify.

Restriction: You can specify this parameter only when you specify the ALLSTATS=YES parameter.

Specify one of the following values:

Value	Description	Example
MM/DD/YYYY	A specific date.	09/15/2015
TODAY	The current date.	TODAY
TODAY-days or -days	The current date minus days specified.	TODAY -3 or -3.
EOLM (End Of Last Month)	The last day of the previous month.	EOLM
EOLM-days	The last day of the previous month minus days specified.	EOLM-1  To include records that were active a day before the last day of the previous month.
BOTM (Beginning Of This Month)	The first day of the current month.	BOTM
BOTM+days	The first day of the current month, plus days specified.	BOTM+9  To include records that were active on the 10th day of the current month.

#### BEGINTime

Specifies the start time to query the data deduplication statistics. This parameter is optional. You can use this parameter with the BEGINDATE parameter to specify a range for the date and time. If you specify a begin time without a begin date, the date is the current date at the time you specify.

Restriction: You can specify this parameter only when you specify the ALLSTATS=YES parameter.

Specify one of the following values:

Value	Description	Example
HH:MM:SS	A specific time.	10:30:08
NOW	The current time.	NOW
NOW+HH:MM or +HH:MM	The current time plus hours and minutes specified.	NOW+02:00 or +02:00.
NOW-HH:MM or -HH:MM	The current time minus hours and minutes specified.	NOW-02:00 or -02:00.

#### ENDDate

Specifies the end date to query data deduplication statistics. This parameter is optional. You can use this parameter with the ENDTIME parameter to specify a range for the date and time. If you specify an end date without an end time, the time is at 11:59:59 p.m. on the specified end date.

Restriction: You can specify this parameter only when you specify the ALLSTATS=YES parameter.

Specify one of the following values:

Value	Description	Example
MM/DD/YYYY	A specific date	09/15/1999
TODAY	The current date	TODAY
TODAY-days or -days	The current date minus days specified.	TODAY -3 or -3.

Value	Description	Example
EOLM (End Of Last Month)	The last day of the previous month.	EOLM
EOLM-days	The last day of the previous month minus days specified.	EOLM-1 To include records that were active a day before the last day of the previous month.
BOTM (Beginning Of This Month)	The first day of the current month.	BOTM
BOTM+days	The first day of the current month, plus days specified.	BOTM+9 To include records that were active on the 10th day of the current month.

#### ENDTime

Specifies the end time of the range to query the data deduplication statistics. This parameter is optional. You can use this parameter with the ENDDATE parameter to specify a range for the date and time. If you specify an end time without an end date, the date is the current date at the time you specify.

Restriction: You can specify this parameter only when you specify the ALLSTATS=YES parameter.

Specify one of the following values:

Value	Description	Example
HH:MM:SS	A specific time.	10:30:08
NOW	The current time.	NOW
NOW+HH:MM or +HH:MM	The current time plus hours and minutes on the specified end date	NOW+02:00 or +02:00.
NOW-HH:MM or -HH:MM	The current time minus hours and minutes on the specified end date	NOW-02:00 or -02:00.

#### ALLStats

Specifies whether to display all data deduplication statistics or only the most recently generated data deduplication statistics. This parameter is optional. Specify one of the following values:

No

Displays only data deduplication statistics that were most recently generated for each node and file space.

Yes

Displays all data deduplication statistics.

## Example: View data deduplication statistics in standard format

Display data deduplication statistics for a storage pool that is named POOL1. The data deduplication statistics are for node NODE1 and the statistics from 8 May 2015 are displayed. See Field descriptions for field descriptions.

```
query dedupstats pool1 node1 begindate=05/08/2015
      Date/Time: 05/05/2015 15:15:23
Storage Pool Name: POOL1
      Node Name: NODE1
      Filespace Name: \\fs1\al
          FSID: 41
          Type: Bkup
Total Saving Percentage: 86.62
Total Data Protected (MB): 311
```

## Example: View detailed data deduplication statistics

Display detailed information for data deduplication for a storage pool that is named POOL1.

```
query dedupstats pool1 format=detailed
      Date/Time: 05/05/2015 15:15:23
Storage Pool Name: POOL1
      Node Name: NODE1
      Filespace Name: \\fs1\al
```

```

FSID: 41
Type: Bkup
Total Data Protected (MB): 47,646
Total Space Used (MB): 10,139
Total Space Saved (MB): 37,507
Total Saving Percentage: 78.72
Deduplication Savings: 21,278,892,501
Deduplication Percentage: 42.59
Non-Deduplicated Extent Count: 1,658
Non-Deduplicated Extent Space Used: 732,626
Unique Extent Count: 189,791
Unique Extent Space Used: 23,385,014,635
Shared Extent Count: 178,712
Shared Extent Data Protected: 26,575,010,669
Shared Extent Space Used: 5,267,815,421
Compression Savings: 5,267,815,421
Compression Percentage: 62.93
Compressed Extent Count: 352,498
Uncompressed Extent Count: 17,663
Encryption Extent Space Used: 52,901,672
Encryption Percentage: 100.00
Encrypted Extent Count: 188
Unencrypted Extent Count: 0

```

## Field descriptions

---

### Date/Time

Displays the time and date that the data deduplication statistics are generated.

### Storage Pool Name

The name of the storage pool.

### Node Name

The name of the client node whose data is contained in the data deduplication statistics.

### Filespace Name

The name of the file space.

### FSID

The name of the file space identifier.

### Type

The type of data. The following values are possible:

#### Arch

Data that has been archived.

#### Bkup

Data that has been backed up.

#### SpMg

Data that has been migrated from an IBM Spectrum Protect for Space Management client.

### Total Data Protected (MB)

The logical amount of data, in megabytes, that is protected in the storage pool before data deduplication and compression. This value represents the sum of the Total Space Used (MB) and Total Space Saved (MB) values.

### Total Space Used (MB)

The total amount of used space in the storage pool, in megabytes. This value is the physical amount of data that is backed up after data deduplication and compression.

### Total Space Saved (MB)

The total amount of space, in megabytes, of data that is removed from the storage pool because of data deduplication and compression. This value represents the sum of the Deduplication Savings and Compression Savings values.

### Total Saving Percentage

The percentage of data that is removed from the storage pool because of compression and data deduplication.

### Deduplication Savings

The amount of used space that is saved in the storage pool because of data deduplication.

### Deduplication Percentage

The percentage of data that is removed from the storage pool because of data deduplication.

### Non-Deduplicated Extent Count

The number of data extents that are not deduplicated in the storage pool.

### Non-Deduplicated Extent Space Used

The amount of space that is used by data extents that are not deduplicated in the storage pool. This value applies to containers that have a .ncf file type and that do not have deduplicated data.

Tip: Data extents that are not deduplicated consist of the following data or file types:

- File metadata.
- Files that are less than 2 KB.
- Files that use client encryption.

#### Unique Extent Count

The number of data extents that are not shared by a node.

#### Unique Extent Space Used

The amount of space in the storage pool that is not shared by a node. This value applies to containers that have a .dcf file type and that do not have deduplicated data.

#### Shared Extent Count

The number of data extents that are used multiple times by the same node or by different nodes because of data deduplication.

#### Shared Extent Data Protected

The amount of space in the storage pool that is protected by shared data extents before data deduplication.

#### Shared Extent Space Used

The amount of space in the storage pool that is used by shared data extents after data deduplication.

#### Compression Savings

The amount of used space that is saved in the storage pool because of compression after data deduplication.

#### Compression Percentage

The percentage of data that is removed from the storage pool because of compression.

#### Compressed Extent Count

The number of data extents that are compressed.

#### Uncompressed Extent Count

The number of data extents that are uncompressed.

#### Encryption Extent Space Used

The amount of space in the storage pool that is used by encrypted data extents.

#### Encryption Percentage

The percentage of encrypted data in the storage pool.

#### Encrypted Extent Count

The number of data extents that are encrypted.

#### Unencrypted Extent Count

The number of data extents that are not encrypted.

## Related commands

---

Table 1. Commands related to QUERY DEDUPSTATS

Command	Description
DELETE DEDUPSTATS	Deletes data deduplication statistics.
GENERATE DEDUPSTATS	Generates data deduplication statistics.

## QUERY DEVCLASS (Display information on one or more device classes)

---

Use this command to display information on one or more device classes.

### Privilege class

---

Any administrator can issue this command.

### Syntax

---

```
..*-----  
>>-Query DEVclass--+----->  
    '-device_class_name-'  
  
.-Format----Standard----  
>--+-----<<
```

```
'-Format-----+Standard-+-'
      '-Detailed-'
```

## Parameters

### device\_class\_name

Specifies the name of the device class to be queried. This parameter is optional. You can use wildcard characters to specify this name. All matching device classes are displayed. If you do not specify a value for this parameter, all device classes are displayed.

### Format

Specifies how the information is displayed. This parameter is optional. The default value is STANDARD. Possible values are:

#### Standard

Specifies that partial information is displayed for the specified device class.

#### Detailed

Specifies that complete information is displayed for the specified device class.

## Example: List all device classes

Display information on all device classes.

```
query devclass
```

AIX	Linux	Windows				
Device Class Name	Device Access Strategy	Storage Pool Count	Device Type	Format	Est/Max Capacity (MB)	Mount Limit
8MMTAPE	Sequential	1	8MM	DRIVE	6,144.0	2
DISK	Random	4				
PLAINFILES	Sequential	1	FILE		50.0	1
8MMSP2	Sequential	2	8MM	DRIVE	44.4	DRIVES

See Field descriptions for field descriptions.

## Example: Display detailed information for a specific FILE device class

Display information in full detail on the PLAINFILES device class.

```
query devclass plainfiles format=detailed
```

```
Device Class Name: PLAINFILES
Device Access Strategy: Sequential
Storage Pool Count: 1
Device Type: FILE
Format:
Est/Max Capacity (MB): 50.0
Mount Limit: 1
Mount Wait (min):
Mount Retention (min):
Label Prefix:
```

### Windows

```
Drive Letter:
Library:
Directory:
Server Name:
Retry Period:
Retry Interval:
```

```
AIX Linux Windows Shared:
```

```
AIX Linux Primary Allocation (MB):
Secondary Allocation (MB):
Compression:
Retention:
Protection:
Expiration Date:
Unit:
Logical Block Protection:
Last Update by (administrator): ADMIN
Last Update Date/Time: 05/31/2000 13:15:36
```

See Field descriptions for field descriptions.

## Example: Display detailed information for a specific 3592 device class

---

Display full details on the 3592 device class.

```
query devclass 3592 format=detailed

    Device Class Name: 3592
    Device Access Strategy: Sequential
    Storage Pool Count: 1
    Device Type: 3592
    Format: 3592
    Est/Max Capacity (MB):
    Mount Limit: DRIVES
    Mount Wait (min): 60
    Mount Retention (min): 60
    Label Prefix: ADSM
    Drive Letter:
    Library: MANLIB
    Directory:
    Server Name:
    Retry Period:
    Retry Interval:
    Shared:
    High-level Address:
    WORM: No
    Scaled Capacity: 90
    Drive Encryption: On
    Primary Allocation (MB):
    Secondary Allocation (MB):
    Compression:
    Retention:
    Protection:
    Expiration Date:
    Unit:
    Logical Block Protection: Read/Write
    Last Update by (administrator): SERVER_CONSOLE
    Last Update Date/Time: 08/04/03 14:28:31
```

See Field descriptions for field descriptions.

## Field descriptions

---

### Device Class Name

The name of the device class.

### Device Access Strategy

How data is written to the device class.

### Storage Pool Count

The number of storage pools that are assigned to the device class.

### Device Type

The device type of the device class.

### Format

The recording format.

### Est/Max Capacity (MB)

The estimated or maximum capacity of a volume that is associated with the device class.

### Mount Limit

The maximum number of sequential access volumes that can be mounted concurrently or specifies that DRIVES is the mount limit.

### Mount Wait (min)

The maximum number of minutes to wait for a sequential access volume to be mounted.

### Mount Retention (min)

The number of minutes to retain an idle sequential access volume before dismounting it.

### Label Prefix

The high-level qualifier of the data set name that the server writes into the sequential access media labels.

### Windows Drive Letter

Windows The drive letter for a removable file.

#### Library

The name of the defined library object that contains the drives that are used by the device class.

#### Directory

The directory or directories for a shared FILE device class.

#### Server Name

The name of a defined server.

#### Retry Period

The interval over which the server attempts to contact a target server if communications failure is suspected.

#### Retry Interval

How often the retries are done within a retry period.

#### Shared

Whether this FILE device class is shared between the server and one or more storage agents.

#### High-level Address

The IP address of the device in dotted decimal format.

#### Minimum Capacity

The minimum capacity of a volume that is associated with the device class.

#### WORM

Whether this drive is a write once, read many (WORM) device.

#### Drive Encryption

Whether drive encryption is allowed. This field applies only to volumes in a storage pool that is associated with a device type of 3592, LTO, or ECARTRIDGE.

#### Scaled Capacity

The percentage of the media capacity that can be used to store data.

**AIX** | **Linux** Primary Allocation (MB)

**AIX** | **Linux** For FILE device classes that represent storage that is managed by a z/OS® media server. Specifies the initial amount of space that is dynamically allocated when a new volume is opened.

**AIX** | **Linux** Secondary Allocation (MB)

**AIX** | **Linux** For FILE device classes that represent storage that is managed by a z/OS media server. Specifies the amount of space by which a file volume is extended when space that is already allocated to the file volume is used up.

**AIX** | **Linux** Compression

**AIX** | **Linux** For tape device classes that represent storage that is managed by a z/OS media server. Specifies whether the data is compressed.

**AIX** | **Linux** Retention

**AIX** | **Linux** For tape device classes that represent storage that is managed by a z/OS media server. Specifies the number of days to retain the tape, if retention is used.

**AIX** | **Linux** Protection

**AIX** | **Linux** For tape device classes that represent storage that is managed by a z/OS media server. Specifies whether the volumes are protected by the RACF program.

**AIX** | **Linux** Expiration Date

**AIX** | **Linux** For tape device classes that represent storage that is managed by a z/OS media server. Specifies the expiration date that is placed on the tape labels for this device class, if expiration is used.

**AIX** | **Linux** Unit

**AIX** | **Linux** For tape device classes that represent storage that is managed by a z/OS media server. Specifies the esoteric unit name for the group of tape devices.

#### Logical Block Protection

Specifies whether logical block protection is enabled and, if it is, the mode. Possible values are Read/Write, Write-only, and No. You can use logical block protection only with the following types of drives and media:

- IBM® LTO5 and later
- IBM 3592 Generation 3 drives and later with 3592 Generation 2 media and later
- Oracle StorageTek T10000C and T10000D drives

#### Last Update by (administrator)

The administrator that made the last update to the device class.

#### Last Update Date/Time

The date and time of the last update.

## Related commands

Table 1. Commands related to QUERY DEVCLASS

Command	Description
---------	-------------



Command	Description
DEFINE DEVCLASS	Defines a device class.
<b>AIX</b>   <b>Linux</b> DEFINE DEVCLASS (z/OS media server)	<b>AIX</b>   <b>Linux</b> Defines a device class to use storage managed by a z/OS media server.
DEFINE SERVER	Defines a server for server-to-server communications.
DELETE DEVCLASS	Deletes a device class.
QUERY DIRSPACE	Displays information about FILE directories.
QUERY SERVER	Displays information about servers.
UPDATE DEVCLASS	Changes the attributes of a device class.
<b>AIX</b>   <b>Linux</b> UPDATE DEVCLASS (z/OS media server)	<b>AIX</b>   <b>Linux</b> Changes the attributes of a device class for storage managed by a z/OS media server.

## QUERY DIRSPACE (Query storage utilization of FILE directories)

Use this command to display information about free space in the directories associated with a device class with a device type of FILE.

### Privilege class

Any administrator can issue this command.

### Syntax

```
>>-Query DIRSpace--+-----+-----+----->>
                    '-device_class_name-'
```

### Parameters

device\_class\_name

Specifies the name of the device class to be queried. This parameter is optional. You can use wildcard characters to specify this name. All matching device classes of device type FILE are displayed. If you do not specify a value for this parameter, all device classes of device type FILE are displayed.

### Example: List FILE type device classes

Display information for all device classes with a device type of FILE. In the following example the unit M is equivalent to megabytes, and the unit G is equivalent to gigabytes.

```
query dirspace
```

**Windows**

Device Class	Directory	Estimated Capacity	Estimated Available
DBBKUP	/This/is/a/large/directory	13,000 M	5,543 M
DBBKUP	/This/is/directory2	13,000 M	7,123 M
DBBKUP2	/This/is/a/huge/directory	2,256 G	2,200 G

**Windows**

Device Class	Directory	Estimated Capacity	Estimated Available
DBBKUP	G:\This\is\a\large\directory	13,000 M	5,543 M
DBBKUP	G:\This\is\directory2	13,000 M	7,123 M
DBBKUP2	G:\This\is\a\huge\directory	2,256 G	2,200 G

## Field descriptions

---

- Device Class Name  
The name of the device class.
- Directory  
The path of the directory located on the server.
- Estimated Capacity  
The estimated total capacity for the directory.
- Estimated Available  
The estimated remaining available space for the directory.

## Related commands

---

Table 1. Commands related to QUERY DIRSPACE

Command	Description
DEFINE DEVCLASS	Defines a device class.
DELETE DEVCLASS	Deletes a device class.
QUERY DEVCLASS	Displays information about device classes.
UPDATE DEVCLASS	Changes the attributes of a device class.

## QUERY DOMAIN (Query a policy domain)

---

Use this command to display information on one or more policy domains.

### Privilege class

---

Any administrator can issue this command.

### Syntax

---

```
>>-Query Domain-.*-----.-Format----Standard-----.
'-domain_name-' '-Format----+Standard+-'
'-Detailed-'
```

### Parameters

---

- domain\_name  
Specifies the policy domain to query. This parameter is optional. You can use wildcard characters to specify names. If you do not specify a value for this parameter, all policy domains are displayed.
- Format  
Specifies how the information is displayed. This parameter is optional. The default value is STANDARD. Possible values are:
- Standard  
Specifies that partial information is displayed.
  - Detailed  
Specifies that complete information is displayed.

### Example: Display a summary of policy domains

---

Display partial information for all policy domains on the server. Issue the command:

```
query domain
```

Policy Domain Name	Activated Policy Set	Activated Policy Default Mgmt Class	Number of Registered Nodes	Description
--------------------	----------------------	-------------------------------------	----------------------------	-------------

EMPLOYEE- _RECORDS PROG1	VACATION	ACTIVEFI- LES	6	Employee Records Domain
PROG2			0	Programming Group Test Domain
STANDARD	STANDARD	STANDARD	1	Installed default policy domain

See Field descriptions for field descriptions.

## Example: Display the list of active-data pools

---

Display the active-data pool list. Issue the command:

```
query domain format=detailed

      Policy Domain Name: STANDARD
      Activated Policy Set: STANDARD
      Activation Date/Time: 05/16/2006 16:18:05
      Days Since Activation: 15
      Activated Default Mgmt Class: STANDARD
      Number of Registered Nodes: 1
      Description: Installed default policy domain.
      Backup Retention (Grace Period): 30
      Archive Retention (Grace Period): 365
      Last Update by (administrator): SERVER_CONSOLE
      Last Update Date/Time: 05/31/2006 15:17:48
      Managing profile:
      Changes Pending: Yes
      Active Data Pool List: ADPPPOOL
```

See Field descriptions for field descriptions.

## Field descriptions

---

### Policy Domain Name

The name of the policy domain.

### Activated Policy Set

The name of the policy set that was last activated in the domain.

The definitions in the last activated policy set and the ACTIVE policy set are not necessarily identical. When you activate a policy set, the server copies the contents of the policy set to the policy set with the special name ACTIVE. The copied definitions in the ACTIVE policy set can be modified only by activating another policy set. You can modify the original policy set without affecting the ACTIVE policy set. Therefore, definitions in the policy set that was last activated might not be the same as those in the ACTIVE policy set.

### Activation Date/Time

The date and time that the policy set was activated.

### Days Since Activation

The number of days since the policy set was activated.

### Activated Default Mgmt Class

The assigned default management class for the policy set.

### Number of Registered Nodes

The number of client nodes registered to the policy domain.

### Description

The description of the policy domain.

### Backup Retention (Grace Period)

The number of days to retain inactive backup versions of files when any of the following conditions occur:

- A file is rebound to a new management class, but neither the new management class nor default management class contains a backup copy group.
- The management class to which a file is bound no longer exists, and the default management class does not contain a backup copy group.



You must specify a value for this parameter if you specify a drive name.

#### drive\_name

Specifies the name assigned to the drive. This parameter is optional. You can use a wildcard character to specify this name. If you specify a drive name, you must also specify a *library\_name*.

#### Format

Specifies how the information is displayed. This parameter is optional. The default is STANDARD. Possible values are:

##### Standard

Specifies that partial information is displayed for the drive.

##### Detailed

Specifies that complete information is displayed for the drive.

## Example: List drives associated with the server

---

Display information about all drives associated with the server. Issue the command:

```
query drive
```

Library Name	Drive Name	Device Type	Online
LIB1	DRIVE01	3590	Yes
LIB2	DRIVE02	3590	Yes

See Field descriptions for field descriptions.

## Example: Display detailed information on a specific drive and library

---

Display detailed information about the drive named DRIVE02 that is associated with the library LIB2. Issue the command:

```
query drive lib2 drive02 format=detailed
```

```
Library Name: LIB2
Drive Name: DRIVE02
Device Type: 3590
On-Line: Yes
Drive State: Empty
Allocated to:
Last Update by (administrator): ADMIN
Last Update Date/Time: 02/29/2002 09:26:23
Cleaning Frequency (Gigabytes/ASNEEDED/NONE): NONE
```

See Field descriptions for field descriptions.

## Field descriptions

---

#### Library Name

The name of the library to which the drive is assigned.

#### Drive Name

The name assigned to the drive.

#### Device Type

The device type as specified in the associated device class. The server must have a path defined from the server to the drive in order to determine the true device type. As long as there is a path defined from the server to the drive, the server will display the true device type of the drive even if there are other paths defined to this drive. Exceptions to this occur if the device type is remote or unknown.

#### REMOTE

The server does not have a path to the device. The only defined paths to the device are from data movers.

#### UNKNOWN

No path exists.

Tip: Review the output of the QUERY PATH command to determine if the desired paths are defined. If they are not defined, define those desired paths using the DEFINE PATH command. Also, if using a data mover device, review the output of the QUERY DATAMOVER command to determine the type of the data mover device. If you are using a path from the server to a drive, the device type of the device class and the drive need to match. If you are using a path from a data mover device to a

drive, review the documentation for your type of data mover to ensure the device type of the device class is compatible with the type of data mover device.

#### On-Line

Specifies the status of the drive:

##### Yes

The drive is online and available for server operations.

##### No

The drive is offline and was put in this state by an administrator updating the status.

##### Unavailable Since

Specifies that the drive has been unavailable since *mm/dd/yy hh:mm:ss*. Output shows the time the server marked the drive as unavailable.

##### Polling Since

Specifies that the server is polling the drive because the drive stopped responding. Output shows the time the server detected a problem and began polling. The server polls a drive before stating it is unavailable. The time output follows the format: *mm/dd/yy hh:mm:ss*.

#### Read Formats

The read formats for the drive.

#### Write Formats

The write formats for the drive.

#### Element

The element number for the drive.

#### Drive State

This specifies the current state of this particular drive based on the result of the last SCSI command to the drive or library. The server tracks the state of the drive to improve its selection of a drive for an operation and its drive recovery operations. The values are:

##### Unavailable

The drive is not available to the library for operations.

##### Empty

The drive is empty and ready for operations.

##### Loaded

The drive is currently loaded, and the server is performing operations to the drive.

##### Unloaded

The media has been ejected from the drive.

##### Reserved

The drive is reserved for a mount request.

##### Unknown

The drive begins in drive state unknown as a result of being defined, as a result of server initialization, or as a result of having its status updated to online.

#### Volume Name

The volume name for the drive.

#### Allocated To

The name of the library client that is currently using the drive. This applies to shared SCSI libraries only; the field is left blank for all other libraries.

#### WWN

The World Wide Name for the drive.

#### Last Update by (administrator)

Who performed the last update to the drive.

#### Last Update Date/Time

The date and time when the last update occurred.

#### Cleaning Frequency (Gigabytes/ASNEEDED/NONE)

How often the server activates drive cleaning. This value can be the number of gigabytes, ASNEEDED, or NONE.

## Related commands

---

Table 1. Commands related to QUERY DRIVE

Command	Description
AUDIT LIBRARY	Ensures that an automated library is in a consistent state.

Command	Description
DEFINE DRIVE	Assigns a drive to a library.
DEFINE LIBRARY	Defines an automated or manual library.
DEFINE PATH	Defines a path from a source to a destination.
DELETE DRIVE	Deletes a drive from a library.
DELETE LIBRARY	Deletes a library.
QUERY LIBRARY	Displays information about one or more libraries.
UPDATE DRIVE	Changes the attributes of a drive.

## QUERY DRMEDIA (Query disaster recovery media)

Use this command to display information about database backup volumes, and volumes in copy storage pools, container-copy storage pools, and active-data storage pools. You can also use the command to create a file of executable commands to process the volumes.

The processing of volumes by this command depends on what the volumes are used for:

### Backups of the server database

To control whether the command processes database backup volumes, use the SOURCE parameter. The command can process volumes that are used for full plus incremental or snapshot database backups. You cannot specify virtual volumes (backup objects that are stored on another server). You can change volumes through each state, or you can use the TOSTATE parameter and skip states to simplify the movements.

### Copy storage pools

The QUERY DRMEDIA command always processes eligible copy storage-pool volumes.

### Container-copy storage pools

By default, volumes in container-copy storage pools are not eligible for processing by the QUERY DRMEDIA command. To process container-copy storage pool volumes, you must issue the SET DRMCOPYCONTAINERSTGPOOL command first, or specify the COPYCONTAINERSTGPOOL parameter on the QUERY DRMEDIA command.

### Active-data storage pools

By default, volumes in active-data storage pools are not eligible for processing by the QUERY DRMEDIA command. To process active-data pool volumes, you must issue the SET DRMACTIVEDATASTGPOOL command first, or specify the ACTIVEDATASTGPOOL parameter on the QUERY DRMEDIA command.

If you are using an external library and have moved a volume to the NOTMOUNTABLE state using the MOVE DRMEDIA command, the QUERY DRMEDIA command might still report the volume state as MOUNTABLE if it detects that the volume is in the library. Refer to the external library documentation for information about the procedures that you should follow when you use the MOVE DRMEDIA and the QUERY DRMEDIA commands.

## Privilege class

To issue this command, you must have one of the following privilege classes:

- If the CMD parameter is NOT specified: operator or system privilege.
- If the CMD parameter is specified and the REQSYSAUTHOUTFILE server option is set to NO: operator, unrestricted storage, or system privilege.
- If the CMD parameter is specified and the REQSYSAUTHOUTFILE server option is set to YES (the default): system privilege.

## Syntax

```

      .-*-----
>>-Query DRMedia----->
      '-volume_name-'

      .-WHEREState----All-----
>--+-----+----->
      '-WHEREState---+-----+'
          +-All-----+
          +-MOUNTABLE-----+
          +-NOTMOUNTABLE----+

```





#### VAULTRetrieve

Volumes in this state are located at the offsite vault, do not contain valid data, and can be moved back onsite for reuse or disposal:

- A copy storage pool volume is considered to be in the VAULTRETRIEVE state if it has been empty for at least the number of days specified with the REUSEDELAY parameter on the DEFINE STGPOOL command.
- A database backup volume is considered to be in the VAULTRETRIEVE state if it is associated with a database backup series that was expired based on the value specified using the SET DRMDBBACKUPEXPIREDDAYS command.

Important: When you issue QUERY DRMEDIA WHERESTATE=VAULTRETRIEVE, the server dynamically determines which volumes can be moved back onsite for reuse or disposal. Therefore, to ensure that you identify all volumes that are in a VAULTRETRIEVE state, issue QUERY DRMEDIA WHERESTATE=VAULTRETRIEVE without the BEGINDATE, ENDDATE, BEGINTIME or ENDTIME parameters. The *Last Update Date/Time* field in the output for QUERY DRMEDIA WHERESTATE=VAULTRETRIEVE displays the date and time that a volume was moved to the VAULT state, not VAULTRETRIEVE.

#### COURIERRetrieve

Volumes in this state are being moved back to the onsite location.

#### REmote

Volumes in this state contain valid data and are located at the offsite remote server.

#### BEGINDate

Specifies the beginning date used to select volumes. This parameter is optional. Volumes are considered eligible if the MOVE DRMEDIA command has changed the volume to its current state on or after the specified date. The default is the earliest date for which volume information exists.

You can specify the date using one of the following values:

Value	Description	Example
MM/DD/YYYY	A specific date	09/15/1998
TODAY	The current date	TODAY
TODAY-days or -days	The current date minus days specified. The maximum number of days is 9999.	TODAY-7 or -7.  To query volumes beginning with records changed to their current state a week ago, you can specify BEGINDATE=TODAY-7 or BEGINDATE=-7.
EOLM (End Of Last Month)	The last day of the previous month.	EOLM
EOLM-days	The last day of the previous month minus days specified.	EOLM-1  To include files that were active a day before the last day of the previous month.
BOTM (Beginning Of This Month)	The first day of the current month.	BOTM
BOTM+days	The first day of the current month, plus days specified.	BOTM+9  To include files that were active on the 10th day of the current month.

#### ENDDate

Specifies the ending date used to select volumes. This parameter is optional. Volumes are considered eligible if the MOVE DRMEDIA command has changed the volume to its current state on or before the specified date. The default is the current date.

You can specify the date using one of the following values:

Value	Description	Example
MM/DD/YYYY	A specific date	09/15/1998
TODAY	The current date	TODAY
TODAY-days or -days	The current date minus days specified. The maximum number of days is 9999.	TODAY-7 or -7.  To query volumes beginning with records changed to their current state a week ago, you can specify BEGINDATE=TODAY-7 or BEGINDATE=-7.

Value	Description	Example
EOLM (End Of Last Month)	The last day of the previous month.	EOLM
EOLM-days	The last day of the previous month minus days specified.	EOLM-1 To include files that were active a day before the last day of the previous month.
BOTM (Beginning Of This Month)	The first day of the current month.	BOTM
BOTM+days	The first day of the current month, plus days specified.	BOTM+9 To include files that were active on the 10th day of the current month.

#### BEGINTime

Specifies the beginning time used to select volumes. This parameter is optional. Volumes are considered eligible if the MOVE DRMEDIA command has changed the volume to its current state on or after the specified time and date. The default is midnight (00:00:00) on the date specified with the BEGINDATE parameter.

You can specify the time using one of the following values:

Value	Description	Example
HH:MM:SS	A specific time on the specified begin date	12:33:28
NOW	The current time on the specified begin date	NOW
NOW+HH:MM <i>or</i> +HH:MM	The current time plus hours and minutes on the specified begin date	NOW+03:00 <i>or</i> +03:00. If you issue QUERY DRMEDIA command at 9:00 with <code>BEGINTIME=NOW+03:00</code> or <code>BEGINTIME=+03:00</code> . The server displays volumes that were changed to their current state at 12:00 on the begin date that you specify.
NOW-HH:MM <i>or</i> -HH:MM	The current time minus hours and minutes on the specified begin date	NOW-03:30 <i>or</i> -03:30. If you issue QUERY DRMEDIA command at 9:00 with <code>BEGINTIME=NOW-03:30</code> or <code>BEGINTIME=-03:30</code> . The server displays volumes that were changed to their current state at 5:30 on the begin date that you specify.

#### ENDTime

Specifies the ending time used to select volumes. This parameter is optional. Volumes are considered eligible if the MOVE DRMEDIA command has changed the volume to its current state on or before the specified time and date. The default is 23:59:59.

You can specify the time using one of the following values:

Value	Description	Example
HH:MM:SS	A specific time on the specified end date	10:30:08
NOW	The current time on the specified end date	NOW
NOW+HH:MM <i>or</i> +HH:MM	The current time plus hours and minutes on the specified end date	NOW+03:00 <i>or</i> +03:00. If you issue QUERY DRMEDIA command at 9:00 with <code>ENDTIME=NOW+03:00</code> or <code>ENDTIME=+03:00</code> , IBM Spectrum Protect™ processes volumes that were changed to their current state at 12:00 on the end date you specify.

Value	Description	Example
NOW-HH:MM <i>or</i> -HH:MM	The current time minus hours and minutes on the specified end date	NOW-03:30 <i>or</i> -03:30  If you issue QUERY DRMEDIA command at 9:00 with ENDTIME=NOW-03:00 or ENDTIME=-03:00, IBM Spectrum Protect processes volumes that were changed to their current state at 6:00 on the end date you specify.

#### COPYstgpool

Specifies the name of the copy storage pool whose volumes are to be processed. This parameter is optional. You can use wildcard characters to specify this name. The copy storage pools specified with this parameter override those specified with the SET DRMCOPYSTGPOOL command.

If this parameter is not specified, the server selects the storage pools as follows:

- If the SET DRMCOPYSTGPOOL command was previously issued with valid copy storage pool names, the server processes only those storage pools.
- If the SET DRMCOPYSTGPOOL command has not been issued, or if all of the copy storage pools have been removed using the SET DRMCOPYSTGPOOL command, the server processes all copy storage pool volumes in the specified state (ALL, MOUNTABLE, NOTMOUNTABLE, COURIER, VAULT, VAULTRETRIEVE, COURIERRETRIEVE, or REMOTE).

#### Source

Specifies whether any database backup volumes are selected. This parameter is optional. The default is DBBACKUP.

Possible values are:

##### DBBackup

Full and incremental database backup volumes are selected.

##### DBSnapshot

Snapshot database backup volumes are selected.

##### DBNone

No database backup volumes are selected.

#### ACTIVEDatstgpool

Specifies the name of the active-data storage pool whose volumes are to be processed. This parameter is optional. You can use wildcard characters to specify this name. The active-data storage pools that are specified with this parameter override those specified with the SET DRMACTIVEDATASTGPOOL command.

If this parameter is not specified, the server selects the storage pools as follows:

- If the SET DRMACTIVEDATASTGPOOL command was previously issued with valid active-data storage pool names, the server processes only those storage pools.
- If the SET DRMACTIVEDATASTGPOOL command has not been issued, or all of the active-data storage pools have been removed using the SET DRMACTIVEDATASTGPOOL command, the server processes all active-data storage pool volumes in the specified state (ALL, NOTMOUNTABLE, COURIER, VAULT, VAULTRETRIEVE, COURIERRETRIEVE, or REMOTE). Volumes in the MOUNTABLE state are not processed.

#### COPYCONtainerstgpool

Specifies the name of the container-copy storage pool whose volumes are to be processed. This parameter is optional. You can use wildcard characters to specify this name. The container-copy storage pools that are specified using this parameter override those that are specified using the SET DRMCOPYCONTAINERSTGPOOL command.

If this parameter is not specified, the server selects the storage pools as follows:

- If the SET DRMCOPYCONTAINERSTGPOOL command was previously issued with names of valid container-copy storage pools, the server processes only those storage pools.
- If the SET DRMCOPYCONTAINERSTGPOOL command has not been issued, or if all container-copy storage pools were removed using the SET DRMCOPYCONTAINERSTGPOOL command, the server processes all container-copy pool volumes based on the value that is specified by the WHERESTATE parameter. If the parameter is set to a value of ALL, NOTMOUNTABLE, COURIER, VAULT, VAULTRETRIEVE, COURIERRETRIEVE, or REMOTE, the volumes are processed. If the value is set to MOUNTABLE, the volumes are not processed.

## Format

Specifies the information to be displayed. This parameter is optional. The default is STANDARD. Possible values are:

### Standard

Specifies that partial information is displayed.

### Detailed

Specifies that detailed information is displayed.

### Cmd

Specifies that executable commands are built for the selected volumes. If you specify FORMAT=CMD, you must also specify the CMD parameter.

## WHERELOCATION

Specifies the location of the volumes to be queried. This parameter is optional. The maximum length of the location is 255 characters. Enclose the text in quotation marks if it contains any blank characters. If you specify a target server name, the disaster recovery manager displays all database backup volumes and copy storage pool volumes located on the target server.

## CMd

Specifies the creation of executable commands to process the volume name and location obtained by this command. This parameter is optional. You must enclose the command specification in quotation marks. The maximum length of this parameter is 255 characters. The disaster recovery manager writes the commands to a file specified by the CMDFILENAME parameter or the SET DRMCMDFILENAME command, or generated by the QUERY DRMEDIA command. If the command length is greater than 240 characters, it is split into multiple lines and continuation characters (+) are added. You may need to alter the continuation character according to the product that runs the commands.

If you do not specify the FORMAT=CMD parameter, this command will not create any command lines.

### string

The command string. The string must not include embedded quotation marks. For example, this is a valid CMD parameter:

```
cmd="checkin libvol lib8mm &vol status=scratch"
```

This is an example of a CMD parameter that is *not* valid:

```
cmd=""checkin libvolume lib8mm" &vol status=scratch""
```

### substitution

Specifies a substitution variable to tell QUERY DRMEDIA to substitute a value for the variable. The variables are not case-sensitive, and must not contain blank spaces after the ampersand (&). The possible variables are:

#### &VOL

A volume name variable.

#### &LOC

A volume location.

#### &VOLDSN

The name of the file the server writes into the sequential access media labels. An example of a copy storage pool tape volume file name using the default prefix TSM is TSM.BFS. An example of a database backup tape volume file name using a prefix TSM310 defined with the device class is TSM310.DBB.

#### &NL

The new line character. When &NL is specified, QUERY DRMEDIA command splits the command at the &NL variable and does not append a continuation character. You must specify the proper continuation character before the &NL if one is required. If the &NL is not specified and the command line is greater than 240 characters, the line is split into multiple lines and continuation characters (+) are added.

AIX	Linux	CMDFilename
-----	-------	-------------

Specifies the fully qualified name of the file to contain the commands specified with CMD parameter. This parameter is optional.

If you do not specify a name with the SET DRMCMDFILENAME command, the server creates a file name by appending `exec.cmds` to the absolute directory path name of the IBM Spectrum Protect instance directory. If you specify a null string (" "), the commands are displayed on the console only. You can redirect the commands to a file using the redirection character for the operating system.

If the operation fails after the command file is created, the file is not deleted.

## Windows CMDFilename

**Windows** Specifies the fully qualified name of the file to contain the commands specified with CMD parameter. This parameter is optional.

If you do not specify a file name with the SET DRMCMDFILENAME command, the server creates a file name by appending `exec.cmd` to the directory that represents this instance of the server (typically the directory where the IBM Spectrum Protect server was originally installed). If you specify a null string (""), the commands are displayed on the console only. You can redirect the commands to a file by using `>` or `>>` provided by the system. The disaster recovery manager allocates the file name specified or generated. If the file exists, the disaster recovery manager tries to use it and any existing data is overwritten.

If the operation fails after the command file is created, the file is not deleted.

## APPend

Specifies whether to overwrite any existing contents of the command file or append the commands to the file. This parameter is optional. The default is NO. Possible values are:

### No

The disaster recovery manager overwrites the contents of the file.

### Yes

The disaster recovery manager appends the commands to the file.

## Example: List volumes to be sent to offsite storage

---

Display all volumes to be given to a courier for offsite storage.

```
query drmedia wherestate=notmountable
format=standard
```

Volume Name	State	Last Update Date/Time	Automated LibName
-----	-----	-----	-----
TAPE01	Not mountable	01/20/1998 14:25:22	
DBTP01	Not mountable	01/20/1998 14:25:22	
DBTP03	Not mountable	01/20/1998 14:31:53	

See Field descriptions for field descriptions.

## Example: Display information on volumes at the vault

---

Display detailed information about all volumes at the vault.

```
query drmedia wherestate=vault format=detailed

          Volume Name: DBTP02
                State: Vault
Last Update Date/Time: 01/20/1998 13:29:02
          Location: Ironmnt
          Volume Type: DBBackup
Copy Storage Pool Name:
Active-Data Storage Pool Name: TSMACTIVEPOOL
Automated LibName:
```

See Field descriptions for field descriptions.

## Field descriptions

---

### Volume Name

The name of the database backup or copy storage pool volume.

### State

The state of the volume.

### Last Update Date/Time

The date and time that the volume state was last updated. For volumes in the VAULTRETRIEVE state, this field displays the date and time that a volume was moved to the VAULT state, not VAULTRETRIEVE. The server does not "update" volumes to VAULTRETRIEVE. At the time the QUERY DRMEDIA command is issued, the server dynamically determines whether the data in copy storage pool volumes and database backup volumes is no longer valid and whether the volume can be brought back onsite for reuse or disposal.

#### Location

The Location field is displayed when the volume is not mountable or when it's not in the library. The Location field is empty if the volume is mountable and is in the library.

#### Volume Type

The type of volume. Possible values are:

##### DBBackup

A full or incremental database backup volume.

##### DBSnapshot

A database snapshot backup volume.

##### CopyStgPool

A copy storage pool volume.

##### ContcopyStgPool

A container-copy storage pool volume.

#### Copy Storage Pool Name

For a copy storage pool volume, the name of the copy storage pool.

#### Active Data Storage Pool Name

For an active-data storage pool volume, the name of the active-data storage pool.

#### Container-Copy Storage Pool Name

For a container-copy storage pool volume, the name of the container-copy storage pool.

#### Automated LibName

The name of the automated library if the volume is in a library.

## Related commands

Table 1. Commands related to QUERY DRMEDIA

Command	Description
BACKUP DB	Backs up the IBM Spectrum Protect database to sequential access volumes.
BACKUP STGPOOL	Backs up a primary storage pool to a copy storage pool.
CHECKOUT LIBVOLUME	Checks a storage volume out of an automated library.
MOVE DRMEDIA	Moves DRM media onsite and offsite.
QUERY DRMSTATUS	Displays DRM system parameters.
SET DRMACTIVEDATASTGPOOL	Specifies that active-data storage pools are managed by DRM.
 SET DRMCOPYCONTAINERSTGPOOL	Specifies the container-copy storage pools that are used in DRM commands.
SET DRMCOPYSTGPOOL	Specifies that copy storage pools are managed by DRM.
SET DRMDBBACKUPEXPIREDAYS	Specifies criteria for database backup series expiration.
SET DRMCMDFILENAME	Specifies a file name for containing DRM executable commands.
SET DRMFILEPROCESS	Specifies whether the MOVE DRMEDIA or QUERY DRMEDIA command processes files associated with a device type of file.

## QUERY DRMSTATUS (Query disaster recovery manager system parameters)

Use this command to display information about the system parameters defined for disaster recovery manager (DRM).

### Privilege class

Any administrator can issue this command.

### Syntax

>>-Query DRMStatus-----<<

## Parameters

---

None.

## Example: Display DRM system parameter information

---

Display information about the DRM system parameters:

```
query drmstatus

    Recovery Plan Prefix:
    Plan Instructions Prefix:
    Replacement Volume Postfix: @
    Primary Storage Pools: PRIM1 PRIM2
    Copy Storage Pools: COPY*
    Active-Data Storage Pools: TSMACTIVEPOOL
    Container-Copy Storage Pools: COPYCNRPOOL
    Not Mountable Location name: Local
    Courier Name: Fedex
    Vault Site Name: Ironmnt
    DB Backup Series expiration days: 30 Day(s)
    Recovery Plan File Expiration Days: 30 Days(s)
    Check Label?: No
    Process FILE Device Type?: No
    Command file name:
```

## Field descriptions

---

### Recovery Plan Prefix

User-specified prefix portion of the file name for the recovery plan file.

### Plan Instructions Prefix

User-specified prefix portion of the file names for the server recovery instructions files.

### Replacement Volume Postfix

The character added to the end of the replacement volume names in the recovery plan file.

### Primary Storage Pools

The primary storage pools that are eligible for processing by the PREPARE command. If this field is blank, all primary storage pools are eligible.

### Copy Storage Pools

The copy storage pools that are eligible for processing by the MOVE DRMEDIA, PREPARE, and QUERY DRMEDIA commands. If this field is blank, all copy storage pools are eligible.

### Active-Data Storage Pools

The active-data pools that are eligible for processing by the MOVE DRMEDIA, PREPARE, and QUERY DRMEDIA commands. If this field is blank, active-data pools are not eligible.

### Container-Copy Storage Pools

The container-copy storage pools that are eligible for processing by the MOVE DRMEDIA, PREPARE, and QUERY DRMEDIA commands. If this field is blank, container-copy storage pools are not eligible.

### Not Mountable Location Name

The name of the offsite location where the media to be shipped are stored.

### Courier Name

The name of the courier used to carry the media to the vault.

### Vault Site Name

The name of the vault where the media is stored.

### DB Backup Series Expiration Days

The minimum number of days that must elapse since a database series has been created before it is eligible to be expired. See the SET DRMDBBACKUPEXPIREDDAYS command for information about the criteria that must be met for database backup series expiration.

### Recovery Plan File Expiration Days

The minimum number of days that must elapse since a recovery plan file, stored on a target server, has been created before it is eligible to be expired. See the SET DRMRPFEXPIREDDAYS command for information about the criteria that must be met for recovery plan file expiration.

### Check Label?

Whether media labels are read for sequential media volumes checked out by the MOVE DRMEDIA command. Possible values are Yes or No.

Process FILE Device Type?

Whether MOVE DRMEDIA or QUERY DRMEDIA commands process database backup and copy storage pool volumes associated with a device class with a FILE device type. Possible values are Yes or No.

Command File Name

The full path file name that contains the executable commands generated by the MOVE DRMEDIA or QUERY DRMEDIA command.

## Related commands

Table 1. Commands related to QUERY DRMSTATUS

Command	Description
MOVE DRMEDIA	Moves DRM media onsite and offsite.
PREPARE	Creates a recovery plan file.
QUERY DRMEDIA	Displays information about disaster recovery volumes.
SET DRMCHECKLABEL	Specifies whether IBM Spectrum Protect should read volume labels during MOVE DRMEDIA command processing.
SET DRMACTIVEDATASTGPOOL	Specifies that active-data storage pools are managed by DRM.
<b>AIX</b>   <b>Linux</b>   <b>Windows</b> SET DRMCOPYCONTAINERSTGPOOL	Specifies the container-copy storage pools that are used in DRM commands.
SET DRMCOPYSTGPOOL	Specifies that copy storage pools are managed by DRM.
SET DRMCMDFILENAME	Specifies a file name for containing DRM executable commands.
SET DRMCOURIERNAME	Specifies the name of the courier for the disaster recovery media.
SET DRMDBBACKUPEXPIREDAYS	Specifies criteria for database backup series expiration.
SET DRMFILEPROCESS	Specifies whether the MOVE DRMEDIA or QUERY DRMEDIA command processes files associated with a device type of file.
SET DRMINSTRPREFIX	Specifies the prefix portion of the path name for the recovery plan instructions.
SET DRMPLANVPOSTFIX	Specifies the replacement volume names in the recovery plan file.
SET DRMPLANPREFIX	Specifies the prefix portion of the path name for the recovery plan.
SET DRMPRIMSTGPOOL	Specifies that primary storage pools are managed by DRM.
SET DRMRPFEXPIREDAYS	Set criteria for recovery plan file expiration.
SET DRMVAULTNAME	Specifies the name of the vault where DRM media is stored.
SET DRMNOTMOUNTABLENAME	Specifies the location name of the DRM media to be sent offsite.

## QUERY ENABLED (Query enabled events)

Use this command to display either a list of enabled events or a list of disabled events, whichever is shorter.

### Privilege class

Any administrator can issue this command.

### Syntax



```

>>-Query--ENabled--+-CONSOLE-----+----->
      +-ACTLOG-----+
      +-EVENTSERVER----+
      +-FILE-----+
      +-FILETEXT-----+
      |                (1) |
      +-NTEVENTLOG-----+
      |                (2) |
      +-SYSLOG-----+
      +-TIVOLI-----+
      '-USEREXIT-----'

>--+-----+----->>
  +-NODEname--==--node_name-----+
  '-SERVername--===server_name-'

```

Notes:

1. This parameter is only available for the Windows operating system.
2. This parameter is only available for the Linux operating system.

## Parameters

---

receiver

Specifies a type of receiver for enabled events. This is a required parameter. Valid values are:

ACTLOG

Specifies the IBM Spectrum Protect™ activity log as a receiver.

CONSOLE

Specifies the standard server console as a receiver.

EVENTSERVER

Specifies the event server as a receiver.

FILE

Specifies a user file as a receiver. Each logged event is a record in the file and a person cannot read each logged event easily.

FILETEXT

Specifies a user file as a receiver. Each logged event is a fixed-size, readable line.

**Windows** NTEVENTLOG

**Windows** Specifies the Windows application log as a receiver.

**Linux** SYSLOG

**Linux** Specifies the Linux system log as a receiver.

TIVOLI

Specifies the Tivoli Management Environment (TME) as a receiver.

USEREXIT

Specifies a user-written routine to which IBM Spectrum Protect writes information as a receiver.

NODEname

Specifies a node name to be queried. You can specify NODENAME or SERVERNAME. If neither parameter is specified, the query is for events enabled for the server running this command.

SERVername

Specifies a server name to be queried. You can specify NODENAME or SERVERNAME. If neither parameter is specified, the query is for events enabled for the server running this command.

## Example: Query the server for console events

---

Query the server for server events that are enabled for the console. There are 10000 possible server events. Either a list of enabled events or disabled events is displayed (whichever list is shorter).

```
query enabled console
```

```
9998 events are enabled for the CONSOLE receiver. The
following events are DISABLED for the CONSOLE receiver:
```

```
ANR8409, ANR8410
```



```

.-BEGINDate-----current_date-. .-BEGINTime-----00:00-.
>-----+-----+-----+-----+-----+-----+----->
'-BEGINDate-----date-----' '-BEGINTime-----time--'

.-ENDDate-----end_date-. .-ENDTime-----23:59-.
>-----+-----+-----+-----+-----+-----+----->
'-ENDDate-----date-----' '-ENDTime-----time--'

.-EXceptiononly-----No-----
>-----+-----+-----+-----+-----+-----+----->
'-EXceptiononly-----+No--+-'
                                     '-Yes-'

.-Format-----Standard-----
>-----+-----+-----+-----+-----+-----+-----><
'-Format-----+Standard+-'
                                     '-Detailed-'

```

## Parameters

### domain\_name (Required)

Specifies the name of the policy domain to which the schedules belong. You can use a wildcard character to specify this name.

### schedule\_name (Required)

Specifies the name of the schedule for which events are displayed. You can use a wildcard character to specify this name.

### Type=Client

Specifies that the query displays events for client schedules. This parameter is optional. The default is CLIENT.

### Nodes

Specifies the name of the client node that belongs to the specified policy domain for which events are displayed. You can specify multiple client nodes by separating the names with commas and no intervening spaces. You can use wildcard characters to specify nodes. If you do not specify a client name, events display for all clients that match the domain name and the schedule name.

### BEGINDate

Specifies the beginning date of the time range for events to be displayed. All events scheduled to start during this time are displayed. This parameter is optional. The default is the current date.

You can specify the date using one of the values below:

Value	Description	Example
MM/DD/YYYY	A specific date	09/15/1998
TODAY	The current date	TODAY
TODAY+days <b>or</b> +days	The current date plus days specified. The maximum number of days you can specify is 9999.	TODAY +3 <b>or</b> +3.
TODAY-days <b>or</b> -days	The current date minus days specified	TODAY-7 <b>or</b> -7.  To query events scheduled to start during the past seven days, specify BEGINDATE=TODAY-7 ENDDATE=TODAY or BEGINDATE=-7 ENDDATE=TODAY.
EOLM (End Of Last Month)	The last day of the previous month.	EOLM
EOLM-days	The last day of the previous month minus days specified.	EOLM-1  To include files that were active a day before the last day of the previous month.
BOTM (Beginning Of This Month)	The first day of the current month.	BOTM

Value	Description	Example
BOTM+days	The first day of the current month, plus days specified.	BOTM+9  To include files that were active on the 10th day of the current month.

#### BEGINTime

Specifies the beginning time of the range for events to be displayed. All events scheduled to start during this time are displayed. This parameter is optional. The default value is 00:00.

You can specify the time using one of the values below:

Value	Description	Example
HH:MM:SS	A specific time on the specified begin date	10:30:08
NOW	The current time on the specified begin date	NOW
NOW+HH:MM <b>or</b> +HH:MM	The current time plus hours and minutes on the specified begin date	NOW+03:00 <b>or</b> +03:00.  If you issue this command at 9:00 to query events scheduled to start 3 hours from now, you can specify either <code>BEGINTIME=NOW+03:00</code> or <code>BEGINTIME=+03:00</code> . IBM Spectrum Protect™ displays events at 12:00 on the specified begin date.
NOW-HH:MM <b>or</b> -HH:MM	The current time minus hours and minutes on the specified begin date	NOW-04:00 <b>or</b> -04:00.  If you issue this command at 9:00 to query events scheduled to start during the last 4 hours, you can specify either <code>BEGINTIME=NOW-04:00</code> <code>ENDTIME=NOW</code> or <code>BEGINTIME=-04:00</code> <code>ENDTIME=NOW</code> . IBM Spectrum Protect displays events at 5:00 on the specified begin date.

#### ENDDate

Specifies the ending date of the time range for events to be displayed. All events that were schedule to start during this time are displayed. This parameter is optional. The default is the value used for the `BEGINDATE`.

You can specify the date using one of the values below:

Value	Description	Example
MM/DD/YYYY	A specific date	09/15/1998
TODAY	The current date	TODAY
TODAY+days <b>or</b> +days	The current date plus days specified. The maximum number of days you can specify is 9999.	TODAY +3 <b>or</b> +3.
TODAY-days <b>or</b> -days	The current date minus days specified	TODAY-8 <b>or</b> -8.  To query events scheduled to start during a one-week period that ended yesterday, you can specify either <code>BEGINDATE=TODAY-8</code> <code>ENDDATE=TODAY-1</code> or <code>BEGINDATE=-8</code> <code>ENDDATE=-1</code> .
EOLM (End Of Last Month)	The last day of the previous month.	EOLM
EOLM-days	The last day of the previous month minus days specified.	EOLM-1  To include files that were active a day before the last day of the previous month.
BOTM (Beginning Of This Month)	The first day of the current month.	BOTM

Value	Description	Example
BOTM+days	The first day of the current month, plus days specified.	BOTM+9  To include files that were active on the 10th day of the current month.

#### ENDTime

Specifies the ending time of the range for events to be displayed. All events that were scheduled to start during this time are displayed. This parameter is optional. The default value is 23:59.

You can specify the time using one of the values below:

Value	Description	Example
HH:MM:SS	A specific time on the specified end date	10:30:08
NOW	The current time on the specified end date	NOW
NOW+HH:MM or +HH:MM	The current time plus hours and minutes on the specified end date	NOW+03:00 or +03:00.  If you issue this command at 9:00 to query events scheduled to start 3 hours from now, you can specify either BEGINTIME=NOW ENDTIME=NOW+03:00 or BEGINTIME=NOW ENDTIME=+03:00.
NOW-HH:MM or -HH:MM	The current time minus hours and minutes on the specified end date	NOW-04:00 or -04:00

#### EXceptiononly

Specifies the type of information you want on scheduled or completed events. This parameter is optional. The default is NO. You can specify one of the following values:

No

Specifies that the information on past and projected events is displayed.

Yes

Specifies that the events that failed or did not process as scheduled are displayed.

#### Format

Specifies how information displays. This parameter is optional. The default is STANDARD. The following values are possible:

Standard

Specifies that partial information for events displays.

Detailed

Specifies that complete information for events displays.

## Display partial information for unsuccessful events

Display partial information for all events that are scheduled for DOMAIN1 that did not run successfully. Limit the search to the client named JOE. Limit the events that are displayed to events that were scheduled to occur from February 11, 2001 (02/11/2001) to February 12, 2001 (02/12/2001).

```
query event domain1 * nodes=joe begindate=02/11/2001
enddate=02/12/2001 exceptiononly=yes
```

Scheduled Start	Actual Start	Schedule Name	Node Name	Status
02/11/1999 01:00:00	02/11/1999 01:13:55	BACK1	JOE	Failed
02/12/1999 01:00:00		DAILYBKP	JOE	Missed

See Field descriptions for field descriptions.

## Display partial information for scheduled events for a client

Display complete information for all events that are scheduled for processing. Use the start time as 10 days previous to today, and the finish includes today.

```
query event * * begindate=today-10 enddate=today
```

Scheduled Start	Actual Start	Schedule Name	Node Name	Status
02/04/2013 14:00:00		SCHD_INCR-DM1	TSM_CET_DM1	Missed
02/04/2013 14:00:00	02/04/2013 14:12:49	VDATAMVR1-IN1	VDATAMVR1-T1	Completed
02/04/2013 14:30:00	02/04/2013 14:33:10	VDATAMVR1-IN2	VDATAMVR1-T2	Completed
02/04/2013 15:00:00	02/04/2013 15:01:49	VDATAMVR1-IN3	VDATAMVR1-T3	Completed
02/04/2013 15:30:00	02/04/2013 15:42:00	VDATAMVR1-IN4	VDATAMVR1-T4	Completed
02/05/2013 14:00:00		SCHD_INCR-DM1	TSM_CET_DM1	Missed
02/05/2013 14:00:00	02/05/2013 14:05:22	VDATAMVR1-F1	VDATAMVR1-F1	Completed
02/05/2013 14:30:00	02/05/2013 14:32:53	VDATAMVR1-F2	VDATAMVR1-F2	Failed 12
02/05/2013 15:00:00	02/05/2013 15:00:38	VDATAMVR1-F3	VDATAMVR1-F3	Completed
02/05/2013 15:30:00	02/05/2013 15:36:41	VDATAMVR1-F4	VDATAMVR1-F4	Completed
02/06/2013 14:00:00		SCHD_INCR-DM1	TSM_CET_DM1	Missed
02/06/2013 14:00:00	02/06/2013 14:06:42	VDATAMVR1-F1	VDATAMVR1-F1	Completed
02/06/2013 14:30:00	02/06/2013 14:35:41	VDATAMVR1-F2	VDATAMVR1-F2	Completed
02/06/2013 15:00:00	02/06/2013 15:08:56	VDATAMVR1-F3	VDATAMVR1-F3	Completed
02/06/2013 15:30:00	02/06/2013 15:40:49	VDATAMVR1-F4	VDATAMVR1-F4	Completed
02/07/2013 14:00:00		SCHD_INCR-DM1	TSM_CET_DM1	Missed
02/07/2013 14:00:00	02/07/2013 14:03:43	VDATAMVR1-F1	VDATAMVR1-F1	Completed
02/07/2013 14:30:00	02/07/2013 14:35:10	VDATAMVR1-F2	VDATAMVR1-F2	Completed
02/07/2013 15:00:00	02/07/2013 15:09:12	VDATAMVR1-F3	VDATAMVR1-F3	Completed
02/07/2013 15:30:00	02/07/2013 15:40:21	VDATAMVR1-F4	VDATAMVR1-F4	Completed
02/08/2013 14:00:00		SCHD_INCR-DM1	TSM_CET_DM1	Missed
02/08/2013 14:00:00	02/08/2013 14:10:17	VDATAMVR1-F1	VDATAMVR1-F1	Completed
02/08/2013 14:30:00	02/08/2013 14:39:16	VDATAMVR1-F2	VDATAMVR1-F2	Completed
02/08/2013 15:00:00	02/08/2013 15:08:17	VDATAMVR1-F3	VDATAMVR1-F3	Completed
02/08/2013 15:30:00	02/08/2013 15:41:16	VDATAMVR1-F4	VDATAMVR1-F4	Completed
02/09/2013 14:00:00		SCHD_INCR-DM1	TSM_CET_DM1	Missed
02/09/2013 14:02:16		VDATAMVR1-F1	VDATAMVR1-F1	Failed 12
02/09/2013 14:30:00	02/09/2013 14:44:26	VDATAMVR1-F2	VDATAMVR1-F2	Failed 12
02/09/2013 15:00:00	02/09/2013 15:06:24	VDATAMVR1-F3	VDATAMVR1-F3	Failed 12
02/09/2013 15:30:00	02/09/2013 15:32:18	VDATAMVR1-F4	VDATAMVR1-F4	Completed
02/11/2013 14:00:00		SCHD_INCR-DM1	TSM_CET_DM1	Missed
02/11/2013 14:00:00	02/11/2013 14:01:05	VDATAMVR1-F1	VDATAMVR1-F1	Failed 12
02/11/2013 14:30:00	02/11/2013 14:31:42	VDATAMVR1-F2	VDATAMVR1-F2	Failed 12
02/11/2013 15:00:00	02/11/2013 15:06:17	VDATAMVR1-F3	VDATAMVR1-F3	Failed 12
02/11/2013 15:30:00	02/11/2013 15:30:19	VDATAMVR1-F4	VDATAMVR1-F4	Completed
02/12/2013 14:00:00		SCHD_INCR-DM1	TSM_CET_DM1	Missed
02/12/2013 14:00:00	02/12/2013 14:03:37	VDATAMVR1-F1	VDATAMVR1-F1	Completed
02/12/2013 14:30:00	02/12/2013 14:33:07	VDATAMVR1-F2	VDATAMVR1-F2	Completed
02/12/2013 15:00:00	02/12/2013 15:03:56	VDATAMVR1-F3	VDATAMVR1-F3	Completed
02/12/2013 15:30:00	02/12/2013 15:36:44	VDATAMVR1-F4	VDATAMVR1-F4	Completed
02/13/2013 14:00:00		SCHD_INCR-DM1	TSM_CET_DM1	Missed
02/13/2013 14:00:00	02/13/2013 14:06:24	VDATAMVR1-F1	VDATAMVR1-F1	Completed
02/13/2013 14:30:00	02/13/2013 14:34:50	VDATAMVR1-F2	VDATAMVR1-F2	Completed
02/13/2013 15:00:00	02/13/2013 15:15:01	VDATAMVR1-F3	VDATAMVR1-F3	Completed
02/13/2013 15:30:00	02/13/2013 15:30:18	VDATAMVR1-F4	VDATAMVR1-F4	Completed
02/14/2013 14:00:00		SCHD_INCR-DM1	TSM_CET_DM1	Future
02/14/2013 14:00:00		VDATAMVR1-F1	VDATAMVR1-F1	Future
02/14/2013 14:30:00		VDATAMVR1-F2	VDATAMVR1-F2	Future
02/14/2013 15:00:00		VDATAMVR1-F3	VDATAMVR1-F3	Future

See Field descriptions for field descriptions.

## Display detailed information for scheduled events for a client

Display the detailed information for events that are scheduled for processing by client DOC between the hours of 10:00 AM and 11:00 AM on November 1, 2005 (11/01/2005). Notice that when the status is FAILED, the result code is displayed.

```
query event domain1 * nodes=doc begindate=11/01/2005
begintime=10:00 endtime=11:00 enddate=11/01/2005
exceptionsonly=yes format=detailed
```

Scheduled Start	Actual Start	Schedule Name	Node Name	Status
11/01/2005 10:01:01	11/01/2005 10:03:46	T1	DOC	Failed 8
11/01/2005 10:16:01	11/01/2005 10:16:10	T1	DOC	Failed 4
11/01/2005 10:31:01	11/01/2005 10:33:08	T1	DOC	Completed
11/01/2005 10:46:01		T1	DOC	Missed
11/01/2005 10:57:49	11/01/2005 10:58:07	T0	DOC	Failed 12

## Field descriptions

**Policy Domain Name**

Specifies the name of the policy domain to which the schedule is assigned.

**Schedule Name**

Specifies the name of the schedule that initiated this event.

**Node Name**

Specifies the client that is scheduled to perform the operation.

**Scheduled Start**

Specifies the scheduled starting date and time for the event.

**Actual Start**

Specifies the date and time at which the client began processing the scheduled operation. No information is displayed if the scheduled operation has not started.

**Completed**

Specifies the date and time the scheduled event is completed.

**Status**

Specifies the status of the event at the time the QUERY EVENT command is issued. The following values are possible:

**Completed**

Specifies that the scheduled event is completed.

**Failed**

Specifies that the client reports a failure when you run the scheduled operation and successive retries failed.

**Failed - no restart**

Specifies an intermediate status, when a client session is interrupted by a communications error or timeout on the server. This status can be changed to a final status of "Completed" or "Failed" when the event completes.

**Future**

Specifies that the beginning of the startup window for the event is in the future. This status also indicates that an event record has not been created for this event.

**In Progress**

Specifies that the scheduled event is running and has not yet reported the completion state to the server.

Periodically check the status for completion of the scheduled event. If this status is not updated in a reasonable amount of time, review your client dsmsched.log and dsmerror.log to determine why the client did not report the outcome of this event to the server. If the scheduled backup failed, rerun the scheduled event or perform a manual incremental backup to ensure the data backup.

**Missed**

Specifies that the scheduled startup window for this event passed and the schedule did not begin.

**Pending**

Specifies that the QUERY EVENT command was issued during the startup window for the event, but processing the scheduled operation did not begin.

**Restarted**

Specifies that the client has tried to process the scheduled operation again.

**Severed**

Specifies that the communications with the client is severed before the event can complete.

**Started**

Specifies that the event has begun processing.

**Uncertain**

Specifies that the state of the event cannot be determined. The server specifies `Uncertain` if the QUERY EVENT command does not find an event record. An event record is not found if the record was deleted or if the server was unavailable during the scheduled startup window (the schedule was never started). Records with Uncertain status are not stored in the database. If you do not want these records to display, either specify `EXCEPTIONSONLY=YES` or delete the schedule if it is no longer needed.

**Attention:** When a scheduled operation is processing, and is not restarted within its specified duration, the Status field shows `Started`. If the operation continues beyond the specified duration, no event record is created. If a query is issued after the specified duration has passed, the Status shows as `Failed` even if the operation is still running. After the operation completes, an event record is created, and a subsequent query shows the result in the Status field.

**Result**

Specifies the return code that indicates whether the schedule processed successfully. If the return code is a value other than 0, examine the server activity log and the client's error log and schedule log.

Return code	Explanation
0	All operations were completed successfully.

Return code	Explanation
4	The operation was completed, but some files were not processed.
8	The operation was completed with at least one warning message.
12	The operation was completed with at least one error message. The count of error messages does not include notifications about skipped files.
-99	The operation failed because the session between the client and the server ended for an unknown reason. It is unknown whether the client can reconnect to the server to complete the schedule event.

If a schedule has ACTION=COMMAND as a parameter, and the command is not an IBM Spectrum Protect command, the command can produce other values in the Result field.

Reason

Specifies the reason for the return code.

## QUERY EVENT (Display administrative event schedules)

Use the QUERY EVENT command to display scheduled and completed events for selected administrative command schedules.

### Privilege class

Any administrator can issue this command.

### Syntax

```
>>-Query Evt--schedule_name--Type----Administrative----->
  .-BEGINdate----current_date-.  .-BEGINTime----00:00-.
>+-----+-----+-----+-----+-----+----->
  '-BEGINdate----date-----'  '-BEGINTime----time--'

  .-ENDDate----begin_date-.  .-ENDTime----23:59-.
>+-----+-----+-----+-----+-----+----->
  '-ENDDate----date-----'  '-ENDTime----time--'

  .-EXceptiononly----No-----
>+-----+-----+-----+-----+-----+----->
  '-EXceptiononly----+No--+-'
                               '-Yes-'

  .-Format----Standard-----
>+-----+-----+-----+-----+-----+-----><
  '-Format----+Standard+-'
                               '-Detailed-'
```

### Parameters

schedule\_name (Required)

Specifies the name of the schedule for which events display. You can use wildcard characters to specify names.

Type=Administrative (Required)

Specifies that the query displays events for administrative command schedules.

BEGINDate

Specifies the beginning date of the time range for events to be displayed. All events scheduled to start during this time are displayed. This parameter is optional. The default is the current date.

You can specify the date using one of the values below:

Value	Description	Example
MM/DD/YYYY	A specific date	09/15/1998
TODAY	The current date	TODAY



Value	Description	Example
TODAY+days <b>or</b> +days	The current date plus days specified. The maximum number of days you can specify is 9999.	TODAY +3 <b>or</b> +3.
TODAY-days <b>or</b> -days	The current date minus days specified	TODAY-7 <b>or</b> -7.  To query events scheduled to start during the past seven days, specify BEGINDATE=TODAY-7 ENDDATE=TODAY or BEGINDATE=-7 ENDDATE=TODAY.
EOLM (End Of Last Month)	The last day of the previous month.	EOLM
EOLM-days	The last day of the previous month minus days specified.	EOLM-1  To include files that were active a day before the last day of the previous month.
BOTM (Beginning Of This Month)	The first day of the current month.	BOTM
BOTM+days	The first day of the current month, plus days specified.	BOTM+9  To include files that were active on the 10th day of the current month.

#### BEGINTime

Specifies the beginning time of the range for events to be displayed. All events scheduled to start during this time are displayed. This parameter is optional. The default value is 00:00.

You can specify the time using one of the values below:

Value	Description	Example
HH:MM:SS	A specific time on the specified begin date	10:30:08
NOW	The current time on the specified begin date	NOW
NOW+HH:MM <b>or</b> +HH:MM	The current time plus hours and minutes on the specified begin date	NOW+03:00 <b>or</b> +03:00.  If you issue this command at 9:00 to query events scheduled to start 3 hours from now, you can specify either BEGINTIME=NOW+03:00 or BEGINTIME=+03:00. IBM Spectrum Protect™ displays events at 12:00 on the specified begin date.
NOW-HH:MM <b>or</b> -HH:MM	The current time minus hours and minutes on the specified begin date	NOW-04:00 <b>or</b> -04:00.  If you issue this command at 9:00 to query events scheduled to start during the last 4 hours, you can specify either BEGINTIME=NOW-04:00 ENDTIME=NOW or BEGINTIME=-04:00 ENDTIME=NOW. IBM Spectrum Protect displays events at 5:00 on the specified begin date.

#### ENDDate

Specifies the ending date of the time range for events to be displayed. All events that were schedule to start during this time are displayed. This parameter is optional. The default is the value used for the BEGINDATE.

You can specify the date using one of the values below:

Value	Description	Example
MM/DD/YYYY	A specific date	09/15/1998
TODAY	The current date	TODAY
TODAY+days <b>or</b> +days	The current date plus days specified. The maximum number of days you can specify is 9999.	TODAY +3 <b>or</b> +3.

Value	Description	Example
TODAY-days <b>or</b> -days	The current date minus days specified	TODAY-8 <b>or</b> -8.  To query events scheduled to start during a one-week period that ended yesterday, you can specify either BEGINDATE=TODAY-8 ENDDATE=TODAY-1 or BEGINDATE=-8 ENDDATE=-1.
EOLM (End Of Last Month)	The last day of the previous month.	EOLM
EOLM-days	The last day of the previous month minus days specified.	EOLM-1  To include files that were active a day before the last day of the previous month.
BOTM (Beginning Of This Month)	The first day of the current month.	BOTM
BOTM+days	The first day of the current month, plus days specified.	BOTM+9  To include files that were active on the 10th day of the current month.

#### ENDTime

Specifies the ending time of the range for events to be displayed. All events that were scheduled to start during this time are displayed. This parameter is optional. The default value is 23:59.

You can specify the time using one of the values below:

Value	Description	Example
HH:MM:SS	A specific time on the specified end date	10:30:08
NOW	The current time on the specified end date	NOW
NOW+HH:MM <b>or</b> +HH:MM	The current time plus hours and minutes on the specified end date	NOW+03:00 <b>or</b> +03:00.  If you issue this command at 9:00 to query events scheduled to start 3 hours from now, you can specify either BEGINTIME=NOW ENDTIME=NOW+03:00 or BEGINTIME=NOW ENDTIME=+03:00.
NOW-HH:MM <b>or</b> -HH:MM	The current time minus hours and minutes on the specified end date	NOW-04:00 <b>or</b> -04:00

#### EXceptiononly

Specifies the type of information you want on scheduled or completed events. This parameter is optional. The default is NO. You can specify one of the following values:

No

Specifies that the information on past and projected events is displayed.

Yes

Specifies that the events that failed or did not process as scheduled are displayed.

#### Format

Specifies how the information displays. This parameter is optional. The default value is STANDARD. Possible values are:

Standard

Specifies that partial information for events displays.

Detailed

Specifies that complete information for events displays.

## Example: List events for a specific administrative schedule

Display partial information for all events scheduled for an administrative schedule named DOSADMIN. Limit the query to events that are scheduled for March 30, 1999 (03/30/1999). Issue the command:

```
query event dosadmin type=administrative
begindate=03/30/1999
enddate=03/30/1999
```

Scheduled Start	Actual Start	Schedule Name	Status
03/30/1999 00:00:00	03/30/1999 00:00:01	DOSADMIN	Completed
03/30/1999 04:00:00	03/30/1999 04:00:01	DOSADMIN	Completed
03/30/1999 12:00:00		DOSADMIN	Future
03/30/1999 16:00:00		DOSADMIN	Future

## Field descriptions

### Scheduled Start

Specifies the scheduled starting date and time for the event.

### Actual Start

Specifies the date and time at which the client began processing the scheduled operation. No information displays if the schedule has not started executing.

### Schedule Name

Specifies the name of the schedule that initiated this event.

### Status

For administrative commands or scripts that specify WAIT=YES, the status of a scheduled event is STARTED until the operation specified by the command or script is completed. The final status of the scheduled event depends on the return code of the operation. However, if WAIT=YES and if the schedule is running a script that specifies PREVIEW=YES, the final status is COMPLETED, unless the script contained a syntax error.

For administrative commands or scripts that specify WAIT=NO, the status of a scheduled event is COMPLETED if the scheduled command or script started. The success of the schedule is independent of the success of the operation performed by the command or script.

## QUERY EVENTRULES (Query rules for server or client events)

Use this command to display the history of events that are enabled or disabled by a specified receiver for the server or for a client node.

## Privilege class

Any administrator can issue this command.

## Syntax

```

>>-Query--EVENTRULES-----*----->>
| .,-----|
| V          |
+---+---CONSOLE-----+
|   +-ACTLOG-----+
|   +-EVENTSERVER----+
|   +-FILE-----+
|   +-FILETEXT-----+
|   |                   (1) |
|   +-NTEVENTLOG-----+
|   |                   (2) |
|   +-SYSLOG-----+
|   +-TIVOLI-----+
|   '-USEREXIT-----'
+-NODEname----node_name----+
'-SERVername----server_name-'

```

### Notes:

1. This parameter is only available for the Windows operating system.
2. This parameter is only available for the Linux operating system.

## Parameters

receivers

Specifies the name of one or more receivers for enabled events. This parameter is optional.

You can use a wildcard character to specify all receivers.

Valid values are:

CONSOLE

Specifies the standard console as a receiver.

ACTLOG

Specifies the IBM Spectrum Protect™ activity log as a receiver.

EVENTSERVER

Specifies the event server as a receiver.

FILE

Specifies a user file as a receiver. Each logged event is a record in the file and a person cannot read each logged event easily.

FILETEXT

Specifies a user file as a receiver. Each logged event is a fixed-size, readable line.

**Windows** NTEVENTLOG

**Windows** Specifies the Windows application log as a receiver.

**Linux** SYSLOG

**Linux** Specifies the Linux system log as a receiver.

TIVOLI

Specifies the Tivoli Management Environment (TME) as a receiver.

USEREXIT

Specifies a user-written routine to which IBM Spectrum Protect writes information as a receiver.

NODENAME

Specifies a node name to be queried. You can use a wildcard character to specify a name. You can specify NODENAME or SERVERNAME. If neither parameter is specified, the query is for event rules for the server running this command.

SERVER

Specifies a server name to be queried. You can use a wildcard character to specify a name. You can specify NODENAME or SERVERNAME. If neither parameter is specified, the query is for event rules for the server running this command.

## Example: Display the history of client events for the server console

---

Display the history of client events enabled or disabled for the server console and activity log receivers.

```
query eventrules console,actlog nodename=*
```

Date/Time	Client Event Rules
05/29/97 13:39:58	ENABLE EVENTS CONSOLE ANE4001 NODENAMES=JEE
05/30/97 13:46:25	DISABLE EVENTS ACTLOG ANE4962 NODENAMES=JEE
05/30/97 13:46:25	DISABLE EVENTS ACTLOG ANE4963 NODENAMES=JEE
05/30/97 13:46:25	DISABLE EVENTS ACTLOG ANE4965 NODENAMES=JEE
05/30/97 13:46:25	DISABLE EVENTS ACTLOG ANE4966 NODENAMES=JEE
05/30/97 13:46:25	DISABLE EVENTS ACTLOG ANE4967 NODENAMES=JEE
05/30/97 13:46:25	DISABLE EVENTS ACTLOG ANE4968 NODENAMES=JEE
05/30/97 14:24:20	ENABLE EVENTS CONSOLE ANE4015 NODENAMES=RON
05/30/97 14:24:50	ENABLE EVENTS CONSOLE ANE4026 NODENAMES=DONNA
05/30/97 14:25:59	ENABLE EVENTS CONSOLE ANE4015 NODENAMES=DONNA

## Example: Display the history of client events for all receivers

---

Display the history of server events enabled or disabled for all receivers.

```
query eventrules
```

Date/Time	Server Event Rules
05/22/97 14:35:13	ENABLE EVENTS CONSOLE ANR2578
05/30/97 14:29:31	ENABLE EVENTS CONSOLE ANR0272
05/30/97 14:31:46	ENABLE EVENTS USEREXIT ANR0130
05/30/97 14:31:54	ENABLE EVENTS USEREXIT ANR0131
05/30/97 14:50:28	ENABLE EVENTS USEREXIT ANR0266

## Field descriptions

---

Date/Time

Specifies the date and time when the event was enabled or disabled.

Client Event Rules

Specifies client events that were enabled or disabled for the specified receivers.

Server Event Rules

Specifies server events that were enabled or disabled for the specified receivers.

## Related commands

---

Table 1. Commands related to QUERY ENABLED

Command	Description
BEGIN EVENTLOGGING	Starts event logging to a specified receiver.
DISABLE EVENTS	Disables specific events for receivers.
ENABLE EVENTS	Enables specific events for receivers.
END EVENTLOGGING	Ends event logging to a specified receiver.
QUERY ENABLED	Displays enabled or disabled events for a specific receiver.

## QUERY EVENTSERVER (Query the event server)

---

Use this command to display the name of the event server.

### Privilege class

---

Any administrator can issue this command.

### Syntax

---

```
>>-Query EVENTSErVer-----<<
```

### Example: Display the event server name

---

Display the name of the event server.

```
query eventserver
```

```
ANR1669I Server EVENT is defined as the event server.
```

## Related commands

---

Table 1. Commands related to QUERY EVENTSERVER

Command	Description
BEGIN EVENTLOGGING	Starts event logging to a specified receiver.
DEFINE EVENTSERVER	Defines a server as an event server.
DEFINE SERVER	Defines a server for server-to-server communications.
DELETE EVENTSERVER	Deletes reference to the event server.
DELETE SERVER	Deletes the definition of a server.
END EVENTLOGGING	Ends event logging to a specified receiver.

## QUERY EXPORT (Query for active or suspended export operations)

---

Use this command to list all restartable export operations. A restartable export is a server-to-server export operation whose FILEDATA value is not NONE. Only active server-to-server export operations that can be suspended are displayed.

Any EXPORT NODE or EXPORT SERVER operation with FILEDATA=NONE are not displayed. Additionally, the QUERY EXPORT command does not show export operations where the target device is either sequential media or virtual volumes.

## Privilege class

---

An administrator can issue this command.

## Syntax

---

```

>>-Query EXPort-----*----->
      '---export_identifier---'

.-State----All-----
>--+-----+----->
      '-State----+All-----+'
              +-RUnning---+
              '-SUSPended-'

>--+-----+----->
      '-PROcEss----process_number-'

.-Format----Standard-----
>--+-----+----->>
      '-Format----+Standard-+-'
              '-Detailed-'

```

## Parameters

---

### export\_identifier

This optional parameter is the unique string identifier for the server-to-server export operation. Wildcard characters can be used to specify this name, and all matching export operations are queried. If you do not specify a value for this parameter and you also do not specify a PROCESS identifier, then all export operations are queried.

### STate

This optional parameter queries the state of the valid server-to-server export operations. The default value is ALL. The possible values are:

#### ALL

Lists all running and suspended server-to-server export operations.

#### RUnning

Lists all active server-to-server export operations that are identifying eligible files or exporting files to the target server.

#### SUSPended

Lists all suspended server-to-server export operations. These suspended operations stopped running because of a failure or by the SUSPEND EXPORT command being issued.

### PROcEss

This optional parameter specifies the number of a running server-to-server export operation that you want to query. If PROCESS is specified, IBM Spectrum Protect™ only displays the running server-to-server export operation associated with the process number. If PROCESS is not specified, IBM Spectrum Protect displays information on all server-to-server export operations. You cannot specify this parameter if you specify an export identifier or if you specify the STATE parameter with a value of SUSPENDED.

### Format

This optional parameter specifies how the information is displayed. The default value is STANDARD. Possible values are:

#### Standard

Specifies that partial information is displayed for the specified export operations.

#### Detailed

When specified, displays all available information for the export operations.

## Example: Display running and suspended export operations

---

List information for all currently running and suspended export operations. Issue the following command:

```
query export state=all
```

Export Identifier	Start Time	State	Process ID	Command
MYEXPORTNODE	01/24/2007 10:30:03	Suspended	--	Export NODE me,you,them filesystem=c\$ nametype=unicode filedata=all durunits=indefinite toserver=athens exportid=MYEXPORTNODE
EXPORT_HOME_ DIRS	01/25/2007 09:30:03	Running	11	Export NODE n2,n3,n4 filesystem=/home nametype=server filedata=all durunits=indefinite toserver=athens exportid=EXPORT_HOME_DIRS
EXPORT_NODE_ 0001	01/25/2007 14:30:33	Running Not Suspendible	--	Export NODE n5,n6,n7 filesystem=d\$ nametype=unicode filedata=archive durunits=indefinite toserver=athens

See Field descriptions for field descriptions.

## Example: Display information about a running export operation

---

List information for the currently running export operation with process number "7." Issue the following command:

```
query export process=7
```

Export Identifier	Start Time	State	Process	Command
MYEXPORTNODE	01/24/2007 10:30:03	Running	7	Export NODE me,you,them filesystem=c\$ nametype=unicode filedata=all toserver=athens exportid=MYEXPORTNODE

See Field descriptions for field descriptions.

## Example: Display detailed information about all suspended export operations

---

List information for all currently suspended export operations. Issue the following command:

```
query export state=suspended format=detailed
```

```
Export Identifier: MyExportNode
Start Time: 01/24/2007 10:30:03
State: Suspended
Process Id: --
Command: Export NODE m* filesystem=c$
        nametype=unicode
        filedata=all durunits=indefinite
        toserver=athens
Phase: File list complete. Exporting
       eligible files
Total Running Time: 3 Days 0 Hours 24 Minutes
Current Process Running Time:
Export Operation Restart Count: 0
Date and Time of Last Restart: --
Date and Time of Last Suspend: 01/25/2007 08:30:11
Policy Domains Exported: 0
Policy Sets Exported: 0
```

```

    Schedules Exported: 0
    Mgmt Classes Exported: 0
    Copy Groups Exported: 0
    Administrators Exported: 1
    Option Sets Exported: 0
    Node Definitions Exported: 3
    Filespace Definitions Exported: 7
    Archive Files Exported: 50,000
    Backup Files Exported: 150,000
    Space Managed Files Exported: 0
    Archive Files Skipped: 0
    Backup Files Skipped: 25
    Space Managed Files Skipped: 0
    Total bytes Transferred (MB): 7,000
    Total Files to be Transferred: 900,000
    Files Remaining: 700,000

```

See Field descriptions for field descriptions.

## Example: Display information for server-to-server export operations

---

List detailed information for all currently running server-to-server export operations. Issue the following command:

```

query export state=running format=detailed

    Export Identifier: export_HOME_Dirs
    Start Time: 01/25/2007 09:30:03
    State: Running
    Process Id: 11
    Command: Export NODE n2,n3,n4
            filespace=/home nametype=
            server filedata=all
            toserver=athens
    Phase: Identifying and exporting
           eligible files
    Total Running Time: 0 Days 22 Hours 0 Minutes
    Current Process Running Time: 01:30:00
    Export Operation Restart Count: 4
    Date and Time of last Restart: 02/01/2007 11:00:03
    Date and Time of last Suspend: 01/31/2007 05:01:00
    Policy Domains Exported: 0
    Policy Sets Exported: 0
    Schedules Exported: 0
    Mgmt Classes Exported: 0
    Copy Groups Exported: 0
    Administrators Exported: 1
    Option Sets Exported: 0
    Node Definitions Exported: 3
    Filespace Definitions Exported: 7
    Archive Files Exported: 0
    Backup Files Exported: 1000
    Space Managed Files Exported: 0
    Archive Files Skipped: 0
    Backup Files Skipped: 0
    Space Managed Files Skipped: 0
    Total bytes Transferred (MB): 50
    Total Files to be Transferred: 400,000
    Files Remaining: 399,000

```

See Field descriptions for field descriptions.

## Field descriptions

---

### Export identifier

The unique identifier assigned to this server-to-server export operation.

### Start time

The time and date that this export operation was first initiated.

### State

The current state of this export operation. The value is one of the following:

Running - Not Suspendible



The operation is active and is transmitting definitions to the target server. The process cannot be suspended, and if the process fails while in this state, you cannot restart it.

#### Running

The operation is active and is either searching for eligible files or transmitting file data to the target server.

#### Running - Suspend in Progress

The operation is in the process of being suspended as a result of a SUSPEND EXPORT command. The export operation is fully suspended when all of the data from the export operation is saved. An export operation in this state does not respond to the following commands:

- CANCEL PROCESS
- CANCEL EXPORT
- RESTART EXPORT
- SUSPEND EXPORT

#### Suspended

The operation stopped running due to a failure or was suspended with the SUSPEND EXPORT command.

#### Process ID

The process ID for the export operation when the status is either "Initializing" or "Running".

#### Command

The full command issued to start this server-to-server export.

#### Phase

The current step that the operation is performing. The possible phases are shown in the order in which they are performed:

##### Creating definitions on target server

The operation is exporting definitions. The process cannot be suspended. Should the process fail in this phase, it cannot be restarted.

##### Identifying and exporting eligible files

The operation is building a list of eligible files for export. Some files may also be transmitted to the target during this phase. A process in this phase can be suspended. Should the process fail in this phase, it can be restarted.

##### File list complete. Exporting eligible files

The operation has completed building the list of eligible files for export and it is now transmitting the files to the target. A process in this phase can be suspended. Should the process fail in this phase, it can be restarted.

#### Total running time

The overall running time for this server-to-server export operation. For example, if this operation started and was then suspended and restarted two times, this value is the total running time of all three active processes of the export operation.

#### Current® process running time

The running time of the active process of a server-to-server export operation. No value is displayed for a suspended operation because no active process exists.

#### Export operation restart count

The number of times the server-to-server export operation was restarted.

#### Date and time of last restart

The last date and time at which this server-to-server export operation was restarted.

#### Date and time of last suspend

The last date and time at which this server-to-server export operation was suspended.

#### Policy domains exported

The number of policy domain definitions successfully exported to the target server.

#### Policy sets exported

The number of policy set definitions successfully exported to the target server.

#### Schedules exported

The number of schedule definitions successfully exported to the target server.

#### Mgmt classes exported

The number of management class definitions successfully exported to the target server.

#### Copy groups exported

The number of copy group definitions successfully exported to the target server.

#### Administrators exported

The number of administrator definitions successfully exported to the target server.

#### Option sets exported

The number of option set definitions successfully exported to the target server.

#### Node definitions exported

The number of node definitions successfully exported to the target server.

#### File space definitions exported

- The number of file space definitions successfully exported to the target server.
- Archive files exported
  - The number of archive files successfully exported to the target server.
- Backup files exported
  - The number of backup files successfully exported to the target server.
- Space managed files exported
  - The number of space managed files successfully exported to the target server.
- Archive files skipped
  - The number of archive files that were eligible for export but were skipped.
- Backup files skipped
  - The number of backup files that were eligible for export but were skipped.
- Space managed files skipped
  - The number of space managed files that were eligible for export but were skipped.
- Total bytes transferred (MB)
  - The total number of bytes transmitted so far to the target server for this export operation.
- Total files to be transferred
  - The total number of files transmitted so far to the target server for this export operation.
- Files remaining
  - The total number of files remaining to be transmitted to the target server for this export operation.

## Related commands

Table 1. Commands related to QUERY EXPORT

Command	Description
CANCEL PROCESS	Cancels a background server process.
CANCEL EXPORT	Deletes a suspended export operation.
EXPORT NODE	Copies client node information to external media or directly to another server.
EXPORT SERVER	Copies all or part of the server to external media or directly to another server.
IMPORT NODE	Restores client node information from external media.
IMPORT SERVER	Restores all or part of the server from external media.
QUERY PROCESS	Displays information about background processes.
RESTART EXPORT	Restarts a suspended export operation.
SUSPEND EXPORT	Suspends a running export operation.

AIX | Linux | Windows

## QUERY EXTENTUPDATES (Query updated data extents)

Use this command to display information about updates to data extents in directory-container storage pools and to determine what data extents are deleted and what is eligible for deletion.

### Privilege class

Any administrator can issue this command.

### Syntax

```
>>-Query EXTENTUPDates--pool_name-----<<
```

### Parameters

- pool\_name (Required)
  - Specifies the storage pool to query. You cannot use wildcards to specify this name.



```

'-Detailed-'
+-UNICODE+
'-FSID-----'

.-CODEType---BOTH-----
>-----<
'-CODEType---+UNICODE---+'
+-NONUNICODE+
'-BOTH-----'

```

## Parameters

---

### node\_name

Specifies the client node to which the file space belongs. You can use wildcard characters to specify this name. This parameter is optional. The default is all client node names.

You must specify a value for this parameter if you specify a file name.

### file\_space\_name

Specifies the name of the file space to be queried. You can use wildcard characters to specify this name. This parameter is optional. If a value is not specified, all file spaces are queried.

If a server includes clients that use Unicode-enabled files spaces, the server might have to convert the name that you enter. For example, the server might have to convert the file space name that you enter from the server code page to Unicode. For more information, see the NAMETYPE parameter. If you do not specify a file space name, or if you specify only a single wildcard character for the name, you can use the CODETYPE parameter to limit the operation to Unicode file spaces or to non-Unicode file spaces.

File space names are case-sensitive. You can use the QUERY FILESPACE command to determine the correct capitalization for the file space to be queried.

### Format

Specifies how the information is displayed. This parameter is optional. The default value is STANDARD. You can specify one of the following values:

#### Standard

Specifies that partial information is displayed for the specified file space.

#### Detailed

Specifies that complete information is displayed for the specified file space.

### NAMETYPE

Specify how you want the server to interpret the file space names that you enter. This parameter is useful when the server has clients with support for Unicode. You can use this parameter for Unicode-enabled IBM Spectrum Protect™ clients that have Windows, Macintosh OS X, and NetWare operating systems.

Use this parameter only when you enter a partly qualified or fully qualified file space name. The default value is SERVER. You can specify one of the following values:

#### SERVER

The server uses the server code page to interpret the file space names.

#### UNICODE

The server converts the file space name that is entered from the server code page to the UTF-8 code page. The success of the conversion depends on the actual characters in the name and the server code page. Conversion can fail if the string includes characters that are not available in the server code page, or if the server has problems accessing system conversion routines.

#### FSID

The server interprets the file space names as their file space IDs (FSIDs).

### CODETYPE

Specify what type of file spaces are to be included in the operation. The default is BOTH, meaning that file spaces are included regardless of code page type. Use this parameter only when you enter a single wildcard character for the file space name. You can specify one of the following values:

#### UNICODE

Include only file spaces that are in Unicode.

#### NONUNICODE

Include only file spaces that are not in Unicode.  
BOTH  
Include file spaces regardless of code page type.

## Example: List all file spaces

---

Query all file spaces that are associated with all client nodes.

```
query filesystem
```

Node Name	Filespace Name	FSID	Platform	Filespace Type	Is Filespace Unicode?	Capacity	Pct Util
JOE	\\joe\c\$	1	WinNT	NTFS	Yes	2,502.3	75.2
JOE	\\joe\d\$	2	WinNT	NTFS	Yes	6,173.4	59.6

See Field descriptions for field descriptions.

## Example: Display detailed file space information for a virtual file space

---

Display detailed information for the file space /HomeDir, which is a virtual file space mapping and belongs to the NAS node NAS1.

```
query filesystem nas1 /HomeDir
```

Node Name	Filespace Name	FSID	Platform	Filespace Type	Is Filespace Unicode?	Capacity	Pct Util
NAS1	/HomeDir	1	NetApp	WAFL (VFS)	No	2,502.3	75.2

See Field descriptions for field descriptions.

Important: You might not see the expected results after you request a detailed format because several fields must be completed by the API application. These fields include:

- File space type
- Platform
- Capacity
- Pct Util
- Last backup start Date/Time
- Last backup completion Date/Time

For more information about specific fields that are updated by the API, see the *IBM Spectrum Protect: Using the Application Programming Interface*.

## Example: Display detailed file space information for a specific file space and node

---

Display detailed information about the \\joe\c\$ file space that belongs to the client node JOE.

```
query filesystem joe \\joe\c$ nametype=unicode format=detailed
```

```
Node Name: JOE
Filespace Name: \\joe\c$
Hexadecimal Filespace Name: 5c5c6a6f655c6324
FSID: 1
Collocation Group Name: FSGRP1
Platform: WinNT
Filespace Type: NTFS
Is Filespace Unicode?: Yes
Capacity: 2,502.3
Pct Util: 75.2
Last Backup Start Date/Time:
Days Since Last Backup Started:
Last Backup Completion Date/Time:
Days Since Last Backup Completed:
Last Replication Start Date/Time: 12/02/2012, 12:42:00
Days Since Last Node Replication Started: 30
Last Replication Completion Date/Time: 12/02/2012, 12:42:00
Days Since Last Replication Completed: 30
```

```
Last Backup Date/Time From Client (UTC): 06/02/2013, 09:10:00
Last Archive Date/Time From Client (UTC): 06/02/2013, 09:10:00
Backup Replication Rule Name: ACTIVE_DATA
Backup Replication Rule State: ENABLED
Archive Replication Rule Name: DEFAULT
Archive Replication Rule State: ENABLED
Space Management Replication Rule Name: NONE
Space Management Replication Rule State: DISABLED
At-risk type: Custom interval
At-risk interval: 2,222
Decommissioned: No
Decommissioned Date:
MAC Address:
```

See Field descriptions for field descriptions.

## Field descriptions

---

Important: You might not see the expected results after requesting a detailed format because several fields must be completed by the API application. These fields include:

- Filespace Type
- Platform
- Capacity
- Pct Util
- Last Backup Start Date/Time
- Last Backup Completion Date/Time

For more information about specific fields that are updated by the API, see the *IBM Spectrum Protect: Using the Application Programming Interface*.

### Node Name

Specifies the name of the client node.

### Filespace Name

The name of the file space that belongs to the node.

File space names can be in a different code page or locale than the server. If they are, the names in the Operations Center and the administrative command-line interface might not be displayed correctly. Data is backed up and can be restored normally, but the file space name or file name might be displayed with a combination of invalid characters or blank spaces.

If the file space name is Unicode-enabled, the name is converted to the server code page for display. The success of the conversion depends on the operating system, the characters in the name, and the server code page. Conversion can be incomplete if the string includes characters that are not available in the server code page or if the server cannot access system conversion routines. If the conversion is incomplete, the name might contain question marks, blanks, unprintable characters, or ellipses (...).

### Hexadecimal Filespace Name

Specifies the hexadecimal name of the file space for the client node in UTF-8 format.

### FSID

Specifies the file space ID of the file space.

### Collocation Group Name

The name of the collocation group, if any, to which the file space belongs.

### Platform

Specifies the platform for the client node.

### Filespace Type

Specifies the type of file space.

A file space type that is appended with "(VFS)" denotes that this file space name is a virtual file space mapping for a directory path on a NAS device.

### Is Filespace Unicode?

Indicates whether the file space is Unicode.

### Capacity

Specifies the amount of space, in megabytes, assigned to this file space on the client node.

For a file space that is a virtual file space mapping for a directory path, this field represents the capacity of the file space on which the directory path is located.

#### Pct Util

Specifies the percentage of the file space that is occupied.

For a file space that is a virtual file space mapping for a directory path, the percentage used is calculated as the percentage of the capacity of the file space that was occupied by the directory at the time of the last full backup.

#### Last Backup Start Date/Time

Specifies the start date and time of the last incremental backup of the file space.

#### Days Since Last Backup Started

Specifies the number of days since the start of the last incremental backup of the file space.

#### Last Backup Completion Date/Time

Specifies the completion date and time of the last incremental backup of the file space.

#### Days Since Last Backup Completed

Specifies the number of days since the completion of the last incremental backup of the file space.

#### Last Replication Start Date/Time

Specifies the date and time that the last replication of file space data started.

#### Days Since Last Replication Started

Specifies the number of days since the last replication of file space data started.

#### Last Replication Completion Date/Time

Specifies the date and time that the last replication of file space data ended.

#### Days Since Last Replication Completed

Specifies the number of days since the last replication of file space data ended.

#### Last Backup Date/Time From Client (UTC)

The date and time, in Universal Time Coordinates (UTC), of the last backup operation for this file space.

#### Last Archive Date/Time From Client (UTC)

The date and time, in Universal Time Coordinates (UTC), of the last archive operation for this file space.

#### Backup Replication Rule Name

Specifies the replication rule that applies to backup data in the file space. The following values are possible:

##### ALL\_DATA

Replicates active and inactive backup data. The data is replicated with a normal priority.

##### ACTIVE\_DATA

Replicates only active backup data. The data is replicated with a normal priority.

Attention: If you specify ACTIVE\_DATA and one or more of the following conditions are true, inactive backup data on the target replication server is deleted, and inactive backup data on the source replication server is not replicated.

- When a server version earlier than Version 7.1.1 is installed on either the source or target replication servers.
- When you are using the REPLICATE NODE command with the FORCERECONCILE=YES parameter.
- When you are running the initial replication of a file space after you configure replication, restore the database, or upgrade both the source and target replication servers from a server version earlier than V7.1.1.

If the previous conditions are not true, all new and changed files since the last replication are replicated, including inactive files, and files are deleted when they expire.

##### ALL\_DATA\_HIGH\_PRIORITY

Replicates active and inactive backup data. The data is replicated with a high priority.

##### ACTIVE\_DATA\_HIGH\_PRIORITY

This rule is the same as the ACTIVE\_DATA replication rule except data is replicated with a high priority.

##### DEFAULT

Replicates backup data according to the client node rule for backup data. If the client node rule for backup data is DEFAULT, backup data is replicated according to the server rule for backup data.

##### NONE

Backup data in the file space is not replicated.

#### Backup Replication Rule State

Specifies whether replication of backup data in the file space is enabled or disabled. If the state is ENABLED, backup files are eligible for replication. If the state is DISABLED, backup files are not eligible for replication.

#### Archive Replication Rule Name

Specifies the replication rule that applies to archive data in the file space. The following values are possible:

**ALL\_DATA**

Replicates archive data. The data is replicated with a normal priority.

**ALL\_DATA\_HIGH\_PRIORITY**

Replicates archive data. The data is replicated with a high priority.

**DEFAULT**

Replicates archive data according to the client rule for archive data. If the client rule for archive data is DEFAULT, archive data is replicated according to the server rule for archive data.

**NONE**

Archive data in the file space is not replicated.

**Archive Replication Rule State**

Specifies whether replication of archive data in the file space is enabled or disabled. If the state is ENABLED, archive files are eligible for replication. If the state is DISABLED, archive files are not eligible for replication.

**Space Management Replication Rule Name**

Specifies the replication rule that applies to space-managed data in the file space. The following values are possible:

**ALL\_DATA**

Replicates space-managed data. The data is replicated with a normal priority.

**ALL\_DATA\_HIGH\_PRIORITY**

Replicates space-managed data. The data is replicated with a high priority.

**DEFAULT**

Replicates space-managed data according to the client rule for space-managed data. If the client rule for space-managed data is DEFAULT, space-managed data is replicated according to the server rule for space-managed data.

**NONE**

Space-managed data in the file space is not replicated.

**Space Management Replication Rule State**

Specifies whether replication of space-managed data in the file space is enabled or disabled. If the state is ENABLED, space-managed files are eligible for replication. If the state is DISABLED, space-managed files are not eligible for replication.

**At-risk type**

Specifies the at-risk evaluation type. Values can be Default, Bypassed, or Custom. Default indicates that the node is evaluated with the same interval that was specified for the nodes classification by the SET STATUSATRISKINTERVAL command. Bypassed indicates that the node is not evaluated for at-risk status by the status monitor. Custom indicates that the node is evaluated with the interval that was specified by the SET VMATRISKINTERVAL command, rather than the interval that was specified by the SET STATUSATRISKINTERVAL command.

**At-risk interval**

Specifies the amount of time, in hours, between client backup activity before the status monitor considers the client at-risk. This field applies only when the at-risk type is Custom.

**Decommissioned**

Specifies whether the virtual machine that the file space represents is decommissioned.

**Decommissioned Date**

Specifies the date that the virtual machine that the file space represents was decommissioned.

**MAC Address**

Specifies the media access control (MAC) address of the file spaces backed up for VMWare virtual machines. In the case where the virtual machine has multiple MAC addresses this is the lowest valued address.

## Related commands

---

Table 1. Commands related to QUERY FILESPACE

Command	Description
DEFINE VIRTUALFSMAPPING	Define a virtual file space mapping.
DELETE FILESPACE	Deletes data associated with client file spaces. If a file space is part of a collocation group and you remove the file space from a node, the file space is removed from the collocation group.
REGISTER NODE	Defines a client node to the server and sets options for that user.
REMOVE NODE	Removes a client from the list of registered nodes for a specific policy domain.



Command	Description
RENAME FILESPACE	Renames a client filesystem on the server.
UPDATE FILESPACE	Changes file-space node-replication rules.
UPDATE NODE	Changes the attributes that are associated with a client node.

## QUERY LIBRARY (Query a library)

Use this command to display information about libraries.

### Privilege class

Any administrator can issue this command.

### Syntax

```

>>-Query LIBRARY--*----->
                '-library_name-'

.-Format----Standard----.
>+-----+----->>
  '-Format----+Standard+-'
                '-Detailed-'

```

### Parameters

library\_name

Specifies the name of the library to be queried. You can use wildcards to specify names. This parameter is optional.

Format

Specifies how the information is displayed. This parameter is optional. The default value is STANDARD. Possible values are:

Standard

Specifies that partial information is displayed for the library.

Detailed

Specifies that complete information is displayed for the library.

### Example: Display summary information about a specific library

Display information about the library named AUTO. Issue the command:

```
query library auto
```

```

      Library Name: AUTO
      Library Type: SCSI
      ACS Id:
Private Category:
Scratch Category:
WORM Scratch Category:
External Manager:
      Shared: No
      LanFree:
ObeyMountRetention:

```

See Field descriptions for field descriptions.

### Example: Display detailed library information about a specific library

Display information in full detail about the library named EZLIFE. Issue the command:

AIX | Linux

```
query library ezlife format=detailed
```

AIX | Linux

```
Library Name: EZLIFE
Library Type: SCSI
ACS Id:
Private Category:
Scratch Category:
WORM Scratch Category:
External Manager:
Shared: Yes
LanFree:
ObeyMountRetention:
Primary Library Manager: EZSERVER
WWN:
Serial Number:
AutoLabel: OVERWRITE
Relabel Scratch: Yes
Last Update by (administrator): DOCTOR_MIKE
Last Update Date/Time: 2002-12-05 15:24:53
```

#### Windows

```
Library Name: EZLIFE
Library Type: SCSI
ACS Id:
Private Category:
Scratch Category:
WORM Scratch Category:
External Manager:
Shared: YES
LanFree:
ObeyMountRetention:
Primary Library Manager: EZSERVER
WWN:
Serial Number:
AutoLabel: OVERWRITE
Reset Drives: No
Relabel Scratch: Yes
Last Update by (administrator): DOCTOR_MIKE
Last Update Date/Time: 2000-12-05 15:24:53
```

See Field descriptions for field descriptions.

## Field descriptions

---

### Library Name

The name of the library.

### Library Type

The type of library.

### ACS Id

Specifies that the library is a StorageTek library that is controlled by StorageTek Automated Cartridge System Library Software (ACSL).

### Private Category

The category number for private volumes that must be mounted by name.

The information that is displayed in this field applies only to an IBM® 3494 or 3495 Tape Library Dataserver.

### Scratch Category

The category number to use for scratch volumes in the library.

The information that is displayed in this field applies only to an IBM 3494 or 3495 Tape Library Dataserver.

### WORM Scratch Category

The category number that is used for WORM scratch volumes in the library.

The information that is displayed in this field applies only to an IBM 3494 or 3495 Tape Library Dataserver.

### External Manager

The location of the external library manager where the server can send media access requests.

### Shared

Whether this library is shared with other IBM Spectrum Protect™ servers in a storage area network (SAN).

### LanFree

Whether an external library is used for LAN-free operations.

ObeyMountRetention  
Whether the server uses the value that is set for mount retention in the device class that is associated with this external library.

Primary Library Manager  
The name of the server that is responsible for controlling access to library resources.

WWN  
The Fibre Channel worldwide name for the library.

Serial Number  
Specifies the serial number for the library that is being queried.

AutoLabel  
Specifies whether the server attempts to automatically label tape volumes.

**AIX** | **Windows** Reset Drives  
**AIX** | **Windows** Specifies whether the server completes a target reset when the server is restarted or when a library client or storage agent re-connection is established.

Relabel Scratch  
Specifies whether the server relabels volumes that were deleted and returned to scratch.

Last Update by (administrator)  
Who completed the last update to the library.

Last Update Date/Time  
The date and time when the last update occurred.

## Related commands

Table 1. Commands related to QUERY LIBRARY

Command	Description
AUDIT LIBRARY	Ensures that an automated library is in a consistent state.
DEFINE LIBRARY	Defines an automated or manual library.
DEFINE PATH	Defines a path from a source to a destination.
DELETE LIBRARY	Deletes a library.
QUERY PATH	Displays information about the path from a source to a destination.
UPDATE LIBRARY	Changes the attributes of a library.

## QUERY LIBVOLUME (Query a library volume)

Use this command to display information about one or more volumes that are checked into an automated library for use by the IBM Spectrum Protect™ server.

### Privilege class

Any administrator can issue this command.

### Syntax

```

>>-Query LIBVolume-+-----+-----+-----+-----+----->
      .-*----- .-*-----
      '-library_name-' '-volume_name-'

      .-Format----Standard----.
>--+-----+-----+-----+----->>
      '-Format----Standard+-'
      '-Detailed-'

```

### Parameters

library\_name

Specifies the name of the library. You can use wildcard characters to specify this name. This parameter is optional. The default is all libraries.

volume\_name

Specifies the volume name. You can use wildcard characters to specify this name. This parameter is optional. The default is all volumes.

Format

Specifies how the information is displayed. This parameter is optional. The default value is STANDARD. Possible values are:

Standard

Specifies that partial information is displayed.

Detailed

Specifies that complete information is displayed.

## Example: List checked in volumes for a specific library

---

Display information about all of the volumes that are checked into the library named TAPE. See Field descriptions for field descriptions.

```
query libvolume tape
```

Library Name	Volume Name	Status	Owner	Last Use	Home Element	Device Type
-----	-----	-----	-----	-----	-----	-----
TAPE	000114	Scratch			1,000	LTO
TAPE	NY1602	Scratch			1,001	DLT

## Example: Display detailed information for a specific library

---

Display detailed information about a volume named JJY008. See Field descriptions for field descriptions.

```
query libvolume jjy008 format=detailed
```

```
Library Name: HPW3494
Volume Name: JJY008
Status: Private
Owner: SUNSET
Last Use: Data
Home Element:
Device Type:
Cleanings Left:
Media Type:
```

## Field descriptions

---

Library Name

The name of the library where the storage volume is located.

Volume Name

The name of the storage volume.

Status

The status of the storage volume according to the library inventory. If the status is Private, the volume is being used by IBM Spectrum Protect. If the status is Scratch, the volume is available for use.

Owner

The owner server of the volume, if the volume is private.

Last Use

The type of data on the volume. This field applies only to volumes in Private status. For storage pool volumes, this field shows **Data**. For database backup volumes (full, incremental, or snapshot), this field shows **DbBackup**.

Home Element

The element address of the library slot containing the volume.

Device Type

The type of device that the volume is used on. This field will display a value only for volumes checked into a library that has mixed media capabilities.

Cleanings Left

For cleaner cartridges, the number of cleanings left.

Media Type

The type of media the volume represents (for example, 8mm tape).

## Related commands

Table 1. Commands related to QUERY LIBVOLUME

Command	Description
AUDIT LIBRARY	Ensures that an automated library is in a consistent state.
CHECKIN LIBVOLUME	Checks a storage volume into an automated library.
CHECKOUT LIBVOLUME	Checks a storage volume out of an automated library.
DEFINE VOLUME	Assigns a volume to be used for storage within a specified storage pool.
LABEL LIBVOLUME	Labels volumes in manual or automated libraries.
QUERY LIBRARY	Displays information about one or more libraries.
UPDATE LIBVOLUME	Changes the status of a storage volume.

## QUERY LICENSE (Display license information)

Use this command to display license audit, license terms, and compliance information.

### Privilege class

Any administrator can issue this command.

### Syntax

```
>>-Query LICense-----<<
```

### Parameters

None.

To display the license information, issue the following command:

```
query license
```

The following example output is displayed:

```
ANR2017I Administrator
SERVER_CONSOLE issued command: QUERY LICENSE
      Last License Audit: 10/17/2016
                        14:28:08
Number of Data Protection for Oracle in use: 0
      Number of Data Protection for
      Oracle in try buy mode: 0
Number of Data Protection for Microsoft SQL in use: 0
      Number of Data Protection for
      Microsoft SQL in try buy mode: 0
Number of Data Protection for
      Microsoft Exchange in use: 0
      Number of Data Protection for
      MS Exchange in try buy mode: 0
      Number of TDP for Lotus Notes in use: 12
      Number of TDP for Lotus Notes in try buy mode: 0
Number of Data Protection for Lotus Domino in use: 0
      Number of Data Protection for
      Lotus Domino in try buy mode: 0
```

```

        Number of TDP for Informix in use: 1
    Number of TDP for Informix in try buy mode: 0
        Number of TDP for SAP R/3 in use: 0
    Number of TDP for SAP R/3 in try buy mode: 0
        Number of TDP for ESS in use: 0
    Number of TDP for ESS in try buy mode: 0
        Number of TDP for ESS R/3 in use: 0
    Number of TDP for ESS R/3 in try buy mode: 0
    Number of TDP for EMC Symmetrix in use: 0
    Number of TDP for EMC Symmetrix in try buy mode: 0
    Number of TDP for EMC Symmetrix R/3 in use: 6
    Number of TDP for EMC Symmetrix R/3 in try buy mode: 0
        Number of TDP for WAS in use: 0
    Number of TDP for WAS in try buy mode: 0
    Is IBM Spectrum Protect for Data Retention in use?: No
    Is IBM Spectrum Protect for Data Retention licensed?: Yes
        Is IBM Spectrum Protect Basic Edition in use: Yes
        Is IBM Spectrum Protect Basic Edition licensed: Yes
        Is IBM Spectrum Protect Extended Edition in use: No
    Is IBM Spectrum Protect Extended Edition licensed: Yes
        Server License Compliance: Valid

```

## Field descriptions

---

### Last License Audit

Specifies the date and time when the last license audit occurred.

### Number of Data Protection for Oracle in use

Specifies the number of Data Protection for Oracle that are in use. A product is in use if you purchased the product and registered the license.

### Number of Data Protection for Oracle in try buy mode

Specifies the number of Data Protection for Oracle that are in try buy mode.

### Number of Data Protection for Microsoft SQL in use

Specifies the number of Data Protection for Microsoft SQL that are in use. A product is in use if you purchased the product and registered the license.

### Number of Data Protection for Microsoft SQL in try buy mode

Specifies the number of Data Protection for Microsoft SQL that are in try buy mode.

### Number of Data Protection for Microsoft Exchange in use

Specifies the number of Data Protection for Microsoft Exchange that are in use. A product is in use if you purchased the product and registered the license.

### Number of Data Protection for Microsoft Exchange in try buy mode

Specifies the number of Data Protection for Microsoft Exchange that are in try buy mode.

### Number of TDP for Lotus Notes® in use

Specifies the number of TDP for Lotus Notes that are in use. A product is in use if you purchased the product and registered the license.

### Number of TDP for Lotus Notes in try buy mode

Specifies the number of TDP for Lotus Notes that are in try buy mode.

### Number of Data Protection for Lotus® Domino® in use

Specifies the number of Data Protection for Lotus Domino that are in use. A product is in use if you purchased the product and registered the license.

### Number of Data Protection for Lotus Domino in try buy mode

Specifies the number of Data Protection for Lotus Domino that are in try buy mode.

### Number of TDP for Informix® in use

Specifies the number of TDP for Informix that are in use. A product is in use if you purchased the product and registered the license.

### Number of TDP for Informix in try buy mode

Specifies the number of TDP for Informix that are in try buy mode.

### Number of TDP for SAP R/3 in use

Specifies the number of TDP for SAP R/3 that are in use. A product is in use if you purchased the product and registered the license.

### Number of TDP for SAP R/3 in try buy mode

Specifies the number of TDP for SAP R/3 that are in try buy mode.

### Number of TDP for ESS in use

Specifies the number of TDP for ESS that are in use. A product is in use if you purchased the product and registered the license.

### Number of TDP for ESS in try buy mode

- Specifies the number of TDP for ESS that are in try buy mode.
- Number of TDP for ESS R/3 in use
  - Specifies the number of TDP for ESS R/3 that are in use. A product is in use if you purchased the product and registered the license.
- Number of TDP for ESS R/3 in try buy mode
  - Specifies the number of TDP for ESS R/3 that are in try buy mode.
- Number of TDP for EMC Symmetrix in use
  - Specifies the number of TDP for EMC Symmetrix that are in use. A product is in use if you purchased the product and registered the license.
- Number of TDP for EMC Symmetrix in try buy mode
  - Specifies the number of TDP for EMC Symmetrix that are in try buy mode.
- Number of TDP for EMC Symmetrix R/3 in use
  - Specifies the number of TDP for EMC Symmetrix R/3 that are in use. A product is in use if you purchased the product and registered the license.
- Number of TDP for EMC Symmetrix R/3 in try buy mode
  - Specifies the number of TDP for EMC Symmetrix R/3 that are in try buy mode.
- Number of TDP for WAS in use
  - Specifies the number of TDP for WAS that are in use. A product is in use if you purchased the product and registered the license.
- Number of TDP for WAS in try buy mode
  - Specifies the number of TDP for WAS that are in try buy mode.
- Is IBM Spectrum Protect™ for Data Retention in use ?
  - Specifies whether the IBM Spectrum Protect for Data Retention is in use. A product is in use if you purchased the product and registered the license.
- Is IBM Spectrum Protect for Data Retention licensed ?
  - Specifies whether the IBM Spectrum Protect for Data Retention is licensed.
- Is IBM Spectrum Protect Basic Edition in use
  - Specifies whether the IBM Spectrum Protect Basic Edition is in use. A product is in use if you purchased the product and registered the license.
- Is IBM Spectrum Protect Basic Edition licensed
  - Specifies whether the IBM Spectrum Protect Basic Edition is licensed.
- Is IBM Spectrum Protect Extended Edition in use
  - Specifies whether the IBM Spectrum Protect Extended Edition is in use. A product is in use if you purchased the product and registered the license.
- Is IBM Spectrum Protect Extended Edition licensed
  - Specifies whether the IBM Spectrum Protect Extended Edition is licensed.
- Server License Compliance
  - Specifies whether the server license is valid.

## Related commands

Table 1. Commands related to QUERY LICENSE

Command	Description
AUDIT LICENSES	Verifies compliance with defined licenses.
QUERY AUDITOCCUPANCY	Displays the server storage utilization for a client node.
QUERY NODE	Displays partial or complete information about one or more clients.
QUERY PVUESTIMATE	Displays processor value unit estimates. Remember: The QUERY PVUESTIMATE command reports licenses by providing PVU information on a per-node basis for server devices.
QUERY STATUS	Displays the settings of server parameters, such as those selected by the SET commands.
REGISTER LICENSE	Registers a license with the IBM Spectrum Protect server.
REGISTER NODE	Defines a client node to the server and sets options for that user.

Command	Description
SET CPUINFOREFRESH	Specifies the number of days between client scans for workstation information used for PVU estimates.
SET LICENSEAUDITPERIOD	Specifies the number of days between automatic license audits.
UPDATE NODE	Changes the attributes that are associated with a client node.

## QUERY LOG (Display information about the recovery log)

Use this command to display information about the recovery log.

### Privilege class

Any administrator can issue this command.

### Syntax

```

.-Format-----Standard-----
>>-Query LOG--+-----+-----+----->>
'-Format-----+--Standard+-'
'-Detailed-'

```

### Parameters

#### Format

Specifies how the information is displayed. This parameter is optional. The default is STANDARD. The following values are possible:

#### Standard

Specifies that partial information is displayed.

#### Detailed

Specifies that complete information is displayed.

### Example: Display summary information about the recovery log

Display summary information about the recovery log. See Field descriptions for field descriptions.

```
query log
```

Total Space (MB)	Used Space (MB)	Free Space (MB)
-----	-----	-----
38,912	543.3	38,368.7

AIX

Linux

### Example: Display detailed information about the recovery log

Display detailed information about the recovery log. See Field descriptions for field descriptions.

```
query log format=detailed
```

```

Active Log Directory : /actlog
Total Space (MB): 524,032
Used Space (MB): 3,517
Free Space (MB): 520,515

Total Size of File System (MB): 564,443
Used Space on File System (MB): 527,049
Free Space on File System (MB): 8,722

Archive Log Directory : /archlog
Total Size of File System (MB): 603,751.82

```



```
Used Space on File System (MB): 80,642.30
Free Space on File System (MB): 523,109.52
Archive Log Compressed : Yes
```

```
Mirror Log Directory : /mirrorlog
Total Size of File System (MB): 564,443
Used Space on File System (MB): 527,049
Free Space on File System (MB): 8,722
```

```
Archive Failover Log Directory : /archfaillog
Total Size of File System (MB): 301,372.06
Used Space on File System (MB): 44,741.80
Free Space on File System (MB): 256,630.26
```

#### Windows

## Example: Display detailed information about the recovery log when the mirror log and the archive failover log are not defined

---

The output of this command on Windows systems is different. For example, the output contains blanks for the mirror log and the archive failover log.

Display information about the recovery log when the mirror log and the archive failover log are not defined.

```
query log format=detailed
```

#### Windows

```
Active Log Directory : d:\actlog
Total Space (MB): 524,032
Used Space (MB): 3,517
Free Space (MB): 520,515

Total Size of File System (MB): 564,443
Used Space on File System (MB): 527,049
Free Space on File System (MB): 8,722

Archive Log Directory : e:\archlog
Total Size of File System (MB): 603,751.82
Used Space on File System (MB): 80,642.30
Free Space on File System (MB): 523,109.52
Archive Log Compressed: Yes

Mirror Log Directory :
Total Size of File System (MB):
Used Space on File System (MB):
Free Space on File System (MB):

Archive Failover Log Directory :
Total Size of File System (MB):
Used Space on File System (MB):
Free Space on File System (MB):
```

## Field descriptions

---

### Total Space

Specifies the maximum size of the active log, in megabytes.

### Used Space

Specifies the amount of used active log space, in megabytes.

### Free Space

Specifies the amount of active log space that is not being used by uncommitted transactions, in megabytes.

### Total Size of File System

Specifies the total size of the file system, in megabytes.

### Space Used on File System

Specifies the amount of used space on the file system, in megabytes.

### Free Space on File System

Specifies the amount of space that is available on the file system, in megabytes.

### Archive Log Compressed

Specifies whether the archive logs are compressed.

#### Active Log Directory

Specifies the location where active log files are stored. When you change the active log directory, the server moves all archived logs to the archive log directory and all active logs to a new active log directory.

#### Mirror Log Directory

Specifies the location where the mirror for the active log is maintained.

#### Archive Failover Log Directory

Specifies the location into which the server saves archive logs if the logs cannot be archived to the archive log directory.

#### Archive Log Directory

Specifies the location into which the server can archive a log file after all the transactions that are represented in that log file are completed.

## QUERY MACHINE (Query machine information)

---

Use this command to display information for one or more machines. You can use this information to recover IBM Spectrum Protect™ client machines in case of a disaster.

Attention: IBM Spectrum Protect does not use the information in any way. It is available only to help you plan for the disaster recovery of client machines.

IBM Spectrum Protect displays information for multiple machines in the following order:

- According to the priority specified.
- Within a priority, according to the specified location and machine name.

### Privilege class

---

Any administrator can issue this command.

### Syntax

---

```
.-*-----.  
>>-Query MACHine-+-----+-----+----->  
                '-machine_name-' '-BUilding---building-'  
  
>--+-----+-----+----->  
    '-FLoor----floor-' '-ROom----room-'  
  
>--+-----+-----+----->  
    '-PRIority---priority-' '-ADSMServer---+Yes+-'  
                                '-No--'  
  
.Format----Standard-----.  
>--+-----+-----+----->>  
    '-Format----+Standard-----+  
        +-Detailed-----+  
        +-RECOVERYInstructions-+  
        '-Characteristics-----'
```

### Parameters

---

#### machine\_name

Specifies the name of one or more machines to be queried. You can use wildcard characters to specify this name. This parameter is optional. The default is all machines that meet the specified criteria.

#### BUilding

Specifies the name or number of the building that the machines are in. This parameter is optional. Enclose the text in quotation marks if it contains any blank characters.

#### FLoor

Specifies the name or number of the floor that the machines are on. This parameter is optional. Enclose the text in quotation marks if it contains any blank characters.

#### ROom

Specifies the name or number of the room that the machines are in. This parameter is optional. The text can be up to 16 characters. Enclose the text in quotation marks if it contains any blank characters.

#### PRIority

Specifies the priority number of the machines. This parameter is optional.

#### ADSMServer

Specifies if the machine contains an IBM Spectrum Protect server. This parameter is optional. The default is to display any machines that meet the other criteria. Possible values are:

Yes

The machine contains an IBM Spectrum Protect server.

No

The machines do not contain an IBM Spectrum Protect server.

#### Format

Specifies how the information is displayed. This parameter is optional. The default value is STANDARD. Possible values are:

Standard

Displays partial information for the machines.

Detailed

Displays all information for the machines.

RECOVERYInstructions

Displays only machine recovery instructions. This option is valid only when querying a specific machine.

Characteristics

Displays only machine characteristics. This option is valid only when querying a specific machine.

## Example: Display information for a specific machine

---

Display information for a machine named MACH1. See Field descriptions for field descriptions.

```
query machine MACH1
```

Machine Name	Machine Priority	Building	Floor	Room	Node Name	Recovery Media Name
MACH1	1	21	2	2929	VIRGINIA	RECMED1

## Example: Display detailed information for priority 1 machines

---

Display detailed information for all priority 1 machines on the second floor of building 21. See Field descriptions for field descriptions.

```
query machine * building=21 floor=2 priority=1  
format=detailed
```

```
Machine Name: MACH1  
Machine Priority: 1  
Building: 21  
Floor: 2  
Room: 2929  
Server?: Yes  
Description: TSM server machine  
Node Name: VIRGINIA  
Recovery Media Name: RECMED1  
Characteristics?: Yes  
Recovery Instructions?: Yes
```

## Field descriptions

---

#### Machine Name

The name of the machine.

#### Machine Priority

The recovery priority of the machine.

#### Building

The building in which the machine is located.

#### Floor

The floor on which the machine is located.

#### Room

The room in which the machine is located.

#### Server?

Whether the machine contains an IBM Spectrum Protect server.

Description  
A description of the machine.

Node Name  
The IBM Spectrum Protect client nodes associated with this machine.

Recovery Media Name  
The recovery media associated with this machine.

Characteristics?  
Whether the characteristics text of the machine is stored in the database.

Recovery Instructions?  
Specifies whether recovery instructions text for a machine is stored in the IBM Spectrum Protect database.

## Related commands

Table 1. Commands related to QUERY MACHINE

Command	Description
DEFINE MACHINE	Defines a machine for DRM.
DEFINE MACHNODEASSOCIATION	Associates an IBM Spectrum Protect node with a machine.
DEFINE RECMEDMACHASSOCIATION	Associates recovery media with a machine.
DELETE MACHINE	Deletes a machine.
INSERT MACHINE	Inserts machine characteristics or recovery instructions into the IBM Spectrum Protect database.
UPDATE MACHINE	Changes the information for a machine.

## QUERY MEDIA (Query sequential-access storage pool media)

Use this command to display information about the sequential-access primary and copy storage pool volumes moved by the MOVE MEDIA command.

### Privilege class

Any administrator with system or operator privilege can issue this command unless it includes the CMD parameter. If the CMD parameter is specified and the REQSYSAUTHOUTFILE server option is set to NO, the administrator must have operator, unrestricted storage, or system privilege. If the CMD parameter is specified and the REQSYSAUTHOUTFILE server option is set to YES (the default), the administrator must have system privilege.

The QUERY MEDIA command displays only volumes with an ACCESS MODE value of READONLY or READWRITE.

### Syntax

```

>>-Query MEDIA--+-----+--STGpool----pool_name----->
      '-volume_name-'

      .-Days----0----.
>--+-----+-----+-----+-----+-----+-----+----->
      '-Days----days-' |           .-,------. |
                        |           v           | |
                        '-WHERESTATUS-----+FULL-----+--'
                        +-FILLing-+
                        '-EMPTy---'

>--+-----+-----+-----+-----+-----+-----+----->
      '-WHEREACcEss-----+READWrite-+-'
                        '-READOnly--'

      .-Format----Standard----.
>--+-----+-----+-----+-----+-----+-----+----->
      '-Format----+Standard-+-'
                        +-Detailed-+

```



If FORMAT=CMD is specified but no command string is specified with the CMD parameter, the QUERY MEDIA command will fail.

#### WHEREState

Specifies the state of volumes to process. This parameter restricts processing to volumes that have the specified state. This parameter is optional. The default is ALL. Possible values are:

##### All

Specifies that volumes in all states are queried. The valid states are: MOUNTABLEINLIB and MOUNTABLENOTINLIB.

##### MOUNTABLEInlib

Specifies that volumes that are currently in the MOUNTABLEINLIB state are queried. Volumes in the MOUNTABLEINLIB state are in the library, and are onsite, contain valid data, and are available for onsite processing.

##### MOUNTABLENotinlib

Specifies that volumes that are currently in the MOUNTABLENOTINLIB state are queried. Volumes in the MOUNTABLENOTINLIB state are not in the library, do not contain valid data, and are not available for onsite processing.

#### WHEREOVFLocation

Specifies the overflow location of the volumes to display. This parameter is optional. This parameter restricts processing to volumes that are in the specified location. The maximum length of the location is 255 characters. The location must be enclosed in quotation marks if it contains any blank characters.

#### CMd

Specifies the creation of executable commands. Enclose the command specification in quotation marks. The maximum length of the command specification is 255 characters. This parameter is optional.

For each volume successfully processed by the QUERY MEDIA command, the server writes the associated commands to a file. Specify the file name with the CMDFILENAME parameter.

**AIX** **Linux** If you do not specify a filename, the command will generate a default filename by appending the string exec.cmds.media to the server directory.

**Windows** If you do not specify a filename, the command will generate a default filename by appending the string exec.cmd.media to the server directory.

#### Remember:

1. If the command written to the file exceeds 255 characters, it is split into multiple lines, and a continuation character (+) is added to all but the last line. You may need to alter the continuation character according to the requirements of the product that runs the commands.
2. If an executable command is specified with any value for FORMAT other than CMD, the command string is ignored, and the QUERY MEDIA command will not write any command line.

Specify a command string and any substitution variables:

#### string

Specifies the string to build an executable command to process the volume name or volume location or both. You can specify any free form text for the string. Do not use embedded quotation marks. For example, the following is a valid executable command specification:

```
cmd="checkin libvolume &vol"
```

The following is an invalid executable command specification:

```
cmd="checkin libvolume "&vol""
```

#### substitution

Specifies a variable for which you want the QUERY MEDIA command to substitute a value. The possible substitution variables are:

##### &VOL

Substitute the volume name for &VOL. You can specify lowercase characters, &vol. No spaces or blanks are allowed between ampersand, &, and VOL. If there are spaces or blanks between ampersand and VOL, the QUERY MEDIA command will treat them as strings and no substitution will be set. If &VOL is not specified, no volume name is set in the executable command.

##### &LOC

Substitute the volume location for &LOC. You can specify lowercase characters, &loc. No spaces or blanks are allowed between ampersand, &, and LOC. If there are spaces or blanks between ampersand and LOC, the QUERY MEDIA command will treat them as strings and no substitution will be set. If &LOC is not specified, no location name is set in the executable command.

#### &VOLDSN

Substitute the volume file name for &VOLDSN. An example of a copy storage pool tape volume file name using the defined prefix IBM Spectrum Protect™310 is IBM Spectrum Protect310.BFS. If &VOLDSN is not specified, no volume file name is set in the executable command.

#### &NL

Substitute the new line character for &NL. When &NL is specified, the QUERY MEDIA command will split the command at the position where the &NL is and will not append any continuation character. The user is responsible for specifying the proper continuation character before the &NL if one is required. The user is also responsible for the length of the line written. If the &NL is not specified and the command exceeds 255 characters, the command is split into multiple lines, and a continuation character (+) is added to all but the last line.

### CMDFilename

Specifies the full path name that will contain the commands specified with CMD parameter when FORMAT=CMD is specified. This parameter is optional. The maximum length of the file name is 1279 characters.

**AIX | Linux** If you specify "" with the CMDFILENAME parameter, the QUERY MEDIA command will generate a file name by appending the "exec.cmds.media" to the server directory. The server directory is the current working directory of the server process.

**Windows** If you specify "" with the CMDFILENAME parameter, the QUERY MEDIA command will generate a file name by appending the "exec.cmd.media" to the server directory. The server directory is the current working directory of the server process.

If you specify a null string ("") for the CMDFILENAME, the commands built are displayed on the console only. You can redirect the commands displayed to a file by using the redirection characters for the operating system (> or >>).

**AIX | Linux** If the filename is not specified, the command will generate a default filename by appending the string "exec.cmds.media" to the server directory.

**Windows** If the filename is not specified, the command will generate a default filename by appending the string "exec.cmd.media" to the server directory.

The QUERY MEDIA command automatically allocates the file name specified or generated. If the file name exists, the QUERY MEDIA command will attempt to use it and the existing data, if any, in the file to be overwritten. You can specify APPEND=YES to prevent the existing data from being overwritten. If the QUERY MEDIA command fails after the command file is allocated, the file is not deleted.

### APPend

Specifies to write at the beginning or the ending of the command file data. This parameter is optional. The default is NO. Possible values are:

#### No

Specifies to write the data from the beginning of the command file. If the given command file exists, its contents are overwritten.

#### Yes

Specifies to append the command file by writing at the end of the command file data.

## Example: Display information on a specific sequential access storage pool

Display all full and partial full volumes that are in the sequential access primary storage pool, ARCHIVE. See Field descriptions for field descriptions.

```
query media * stgpool=archive wherestatus=full, filling
```

Volume Name	State	Location	Automated LibName
TAPE01	Mountable in Library		LIB3494
TAPE03	Mountable not in Lib.	Room1234/Bldg31	

TAPE07 Mountable in Library  
TAPE09 Mountable not in Lib. Room1234/Bldg31

LIB3494

## Example: Display information on sequential access storage pool with a specific prefix

---

Display in detail all full volumes in MOUNTABLENOTINLIB state for sequential access storage pools that have a prefix name of ONSITE. See Field descriptions for field descriptions.

```
query media wherestate=mountablenotinlib stgpool=onsite*  
wherestatus=full format=detailed
```

```
Volume Name: TAPE21  
State: Mountable not in library  
Volume Status: Full  
Access: ReadOnly  
Last Reference Date: 01/30/98  
Last Update Date/Time: 08/20/1996 13:29:02  
Location: Rm569/bldg31  
Storage Pool Name: ONSITE.ARCHIVE  
Automated Libname:  
  
Volume Name: TAPE22  
State: Mountable not in library  
Volume Status: Full  
Access: ReadOnly  
Last Reference Date: 01/30/98  
Last Update Date/Time: 08/20/1996 15:29:02  
Location: Rm569/bldg31  
Storage Pool Name: ONSITE.ARCHIVEPOOL  
Automated Libname:
```

## Example: Generate checkin commands

---

Generate the CHECKIN LIBVOLUME commands for full and partially full volumes that are in the ONSITE.ARCHIVE primary storage pool and stored in the overflow location Room 2948/Bldg31.

```
query media * stgpool=onsite.archive format=cmd  
wherestatus=full,filling wherestate=mountablenotinlib  
whereovflocation=room2948/bldg31  
cmd="checkin libvol lib3494 &vol status=private"  
cmdfilename=/tsm/move/media/checkin.vols
```

The QUERY MEDIA command created the CHECKIN LIBVOLUME executable commands in /tsm/move/media/checkin.vols, which can be run by issuing the MACRO command with /tsm/move/media/checkin.vols as the macro name.

```
checkin libvol lib3494 TAPE04 status=private  
checkin libvol lib3494 TAPE13 status=private  
checkin libvol lib3494 TAPE14 status=private
```

## Field descriptions

---

### Volume Name

Specifies the name of the primary sequential access storage pool volume.

### State

Specifies the state of the volume.

### Volume Status

Specifies the status of the volume.

### Access

Specifies the access mode of the volume.

### Last Reference Date

Specifies the volume's last written date or last read date, whichever is more recent.

### Last Update Date/Time

Specifies the date and time when the volume was most recently updated.

### Location

Specifies where the volume is stored. If the volume is ejected from the library and its location is not specified or defined, a question mark (?) is displayed for the location.

### Storage Pool Name



Specifies the name of the sequential access storage pool where the volume is defined.  
Automated LibName  
Specifies the automated library name if the volume is in the library.

## Related commands

Table 1. Commands related to QUERY MEDIA

Command	Description
<b>AIX</b>   <b>Linux</b>   <b>Windows</b> MOVE MEDIA	Moves storage pool volumes that are managed by an automated library.

## QUERY MGMTCLASS (Query a management class)

Use this command to display information about management classes.

### Privilege class

Any administrator can issue this command.

### Syntax

```
>>-Query Mgmtclass----->
.---*---*-----
>--+-----+----->
|          .---*---*-----|
|'-domain_name-+-----+'
|          |          .---*-----|
|          |'-policy_set_name-+-----+'
|          |          |'-class_name-'
|
.-Format---Standard-----
>--+-----+----->>
|'-Format---Standard-+'
|          |'-Detailed-'
```

### Parameters

#### domain\_name

Specifies the policy domain associated with the management class to query. This parameter is optional. You can use wildcard characters to specify this name. If you do not specify a value for this parameter, management classes in all policy domains are queried. You must specify this parameter when querying an explicitly named management class.

#### policy\_set\_name

Specifies the policy set associated with the management class to query. This parameter is optional. You can use wildcard characters to specify this name. If you do not specify a value for this parameter, management classes in all policy sets are queried. You must specify this parameter when querying an explicitly named management class.

#### class\_name

Specifies the management class to query. This parameter is optional. You can use wildcard characters to specify this name. If you do not specify a value for this parameter, all management classes are queried.

#### Format

Specifies how the information is displayed. This parameter is optional. The default value is STANDARD. Possible values are:

##### Standard

Specifies that partial information is displayed.

##### Detailed

Specifies that complete information is displayed.

### Example: Display information for all management classes

Query all management classes for all policy domains. Create the output in standard format. See Field descriptions for field descriptions.

```
query mgmtclass
```

Policy Domain Name	Policy Set Name	Mgmt Class Name	Default Mgmt Class ?	Description
EMPLOYEE-RECORDS	ACTIVE	ACTIVEFILES	Yes	Modified default management class
EMPLOYEE-RECORDS	HOLIDAY	ACTIVEFILES	Yes	Modified default management class
EMPLOYEE-RECORDS	HOLIDAY	FILEHISTORY	No	Test modified management class
EMPLOYEE-RECORDS	VACATION	ACTIVEFILES	Yes	Original default management class
EMPLOYEE-RECORDS	VACATION	FILEHISTORY	No	Test modified management class
PROG1	SUMMER	MCLASS1	No	Technical Support Mgmt Class
PROG2	SUMMER	MCLASS1	No	Technical Support Mgmt Class
STANDARD	ACTIVE	STANDARD	Yes	Installed default management class
STANDARD	STANDARD	STANDARD	Yes	Installed default management class

To display information about management classes in a specific policy domain, for example the domain ENGPOLDOM, issue the following command:

```
query mgmtclass engpoldom * *
```

## Example: Display detailed information for a specific management class

Query the ACTIVEFILES management class that is assigned to the VACATION policy set of the EMPLOYEE\_RECORDS policy domain. Create the output in detailed format. See Field descriptions for field descriptions.

```
query mgmtclass employee_records vacation
activefiles format=detailed
```

```

Policy Domain Name: EMPLOYEE_RECORDS
Policy Set Name: VACATION
Mgmt Class Name: ACTIVEFILES
Default Mgmt Class ?: Yes
Description: Installed default management class
Space Management Technique: None
Auto-Migrate on Non-Use: 0
Migration Requires Backup?: Yes
Migration Destination: SPACEMGPOOL
Last Update by (administrator): $$CONFIG_MANAGER$$
Last Update Date/Time: 05/31/1998 13:15:45
Managing Profile: EMPLOYEE
Changes Pending: Yes

```

## Field descriptions

### Policy Domain Name

The policy domain.

### Policy Set Name

The policy set.

### Mgmt Class Name

The management class.

### Default Mgmt Class ?

Whether the management class is the default management class for the policy set.

### Description

The description of the management class.

### Space Management Technique

The space management technique for the management class, for IBM Spectrum Protect™ for Space Management clients.

### Auto-Migrate on Non-Use

The number of days that must elapse since a file was last accessed before it is eligible for automatic migration by IBM Spectrum Protect for Space Management clients.

**Migration Requires Backup?**

Whether a backup version of a file must exist before a file can be migrated by IBM Spectrum Protect for Space Management clients.

**Migration Destination**

The storage pool that is the destination for files migrated by IBM Spectrum Protect for Space Management clients.

**Last Update by (administrator)**

The administrator or server that most recently updated the management class. If this field contains `$$CONFIG_MANAGER$$`, the management class is associated with a domain that is managed by the configuration manager.

**Last Update Date/Time**

The date and time when the management class was most recently defined or updated.

**Managing profile**

The profile or profiles to which the managed server subscribed to get the definition of this management class.

**Changes Pending**

Whether or not changes are being made but not activated. Once the changes are activated, the field resets to No.

## Related commands

---

Table 1. Commands related to QUERY MGMTCLASS

Command	Description
COPY MGMTCLASS	Creates a copy of a management class.
DEFINE MGMTCLASS	Defines a management class.
DEFINE PROFASSOCIATION	Associates objects with a profile.
DELETE MGMTCLASS	Deletes a management class and its copy groups from a policy domain and policy set.
QUERY DOMAIN	Displays information about policy domains.
UPDATE MGMTCLASS	Changes the attributes of a management class.

## QUERY MONITORSETTINGS (Query the configuration settings for monitoring alerts and server status)

---

Use this command to display information about alert monitoring and server status settings.

### Privilege class

---

Any administrator can issue this command.

### Syntax

---

```
>>-Query MONITORSEttings-----<<
```

### Display monitoring settings

---

Display details about the monitoring settings. See Field descriptions for more details.

```
query monitorsettings
```

Example output:

```
Monitor Status: On
Status Refresh Interval (Minutes): 5
Status Retention (Hours): 48
Monitor Message Alerts: On
Alert Update Interval (Minutes): 10
```

```

Alert to Email: On
Send Alert Summary to Administrators: On
Alert from Email Address: DJADMIN@MYDOMAIN.COM
Alert SMTP Host: DJHOST.MYDOMAIN.COM
Alert SMTP Port: 25
Alert Active Duration (Minutes): 480
Alert Inactive Duration (Minutes): 480
Alert Closed Duration (Minutes): 60
Monitoring Admin: ADMIN
Monitored Group: MONGROUP
Monitored Servers: SERVER2
At-Risk Interval for Applications: 24
Skipped files as At-Risk for Applications?: Yes
At-Risk Interval for Virtual Machines: 24
Skipped files as At-Risk for Virtual Machines?: Yes
At-Risk Interval for Systems: 24
Skipped files as At-Risk for Systems?: Yes

```

## Field descriptions

---

### Monitor status

Specifies whether alert monitoring on the server is enabled or disabled.

### Status Refresh Interval (Minutes)

Specifies the number of minutes between intervals that the monitoring server gathers event data.

### Status Retention (Hours)

Specifies the number of hours that status monitoring indicators are retained.

### Monitor Message Alerts

Specifies whether alerts are sent to administrators by email.

### Alert Update Interval (Minutes)

Specifies the length of time, in minutes, that the alert monitor waits before the alert is updated and pruned on the server.

### Alert to Email

Specifies whether alerts are sent to administrators by email.

### Send Alert Summary to Administrators

Specifies the administrators that receive a summary of existing alerts on the server in an email.

### Alert from Email Address

Specifies the email address of the sender.

### Alert SMTP Host

Specifies the Simple Mail Transfer Protocol (SMTP) host mail server that is used to send alerts by email.

### Alert SMTP Port

Specifies the SMTP mail server port that is used to send alerts by email.

### Alert Active Duration (Minutes)

Specifies how long, in minutes, an alert remains active.

### Alert Inactive Duration (Minutes)

Specifies how long, in minutes, an alert remains inactive.

### Alert Closed Duration (Minutes)

Specifies how long, in minutes, an alert remains closed before it is deleted from the server.

### Monitoring Admin

Specifies the name of the monitoring administrator that is used to connect to the servers in the monitored group.

### Monitored Group

Specifies the name of the monitored server group.

### Monitored Servers

Specifies the names of the servers in the monitored server group. The monitor settings might be different on each monitored server. If so, issue the query command for each server to display the monitoring settings.

### At-Risk Interval for Applications

Specifies how long, in hours, an applications client can log no activity before it is considered at-risk.

### Skipped files as At-Risk for Applications?

Specifies that the server considers skipped files, by the client as a failure, and marks the client at-risk.

### At-Risk Interval for Virtual Machines

Specifies how long, in hours, a virtual client can log no activity before it is considered at-risk.

### Skipped files as At-Risk for Virtual Machines?

Specifies that the server considers skipped files, by the client as a failure and marks the client at-risk.

### At-Risk Interval for Systems

Specifies how long, in hours, a systems client can log no activity before it is considered at-risk.

### Skipped files as At-Risk for Systems?

Specifies that the server considers skipped files, by the client as a failure, and marks the client at-risk.

## Related commands

Table 1. Commands related to QUERY MONITORSETTINGS

Command	Description
DEFINE ALERTTRIGGER (Define an alert trigger)	Associates specified messages to an alert trigger.
DELETE ALERTTRIGGER (Remove a message from an alert trigger)	Removes a message number that can trigger an alert.
DELETE GRPMEMBER (Delete a server from a server group)	Deletes a server from a server group.
DELETE SERVER (Delete a server definition)	Deletes the definition of a server.
QUERY ALERTSTATUS (Query the status of an alert)	Displays information about alerts that have been issued on the server.
QUERY ALERTTRIGGER (Query the list of defined alert triggers)	Displays message numbers that trigger an alert.
SET ALERTMONITOR (Set the alert monitor to on or off)	Specifies whether alert monitoring is set to on or off.
SET STATUSATRISKINTERVAL (Specifies whether to enable client at-risk activity interval evaluation)	Specifies whether to enable client at-risk activity interval evaluation
SET STATUSMONITOR (Specifies whether to enable status monitoring)	Specifies whether to enable status monitoring.
SET STATUSSKIPASFAILURE (Specifies whether to use client at-risk skipped files as failure evaluation)	Specifies whether to use client at-risk skipped files as failure evaluation
UPDATE ALERTTRIGGER (Update a defined alert trigger)	Updates the attributes of one or more alert triggers.
UPDATE ALERTSTATUS (Update the status of an alert)	Updates the status of a reported alert.

## QUERY MONITORSTATUS (Query the monitoring status)

Use this command to display monitoring messages that are within the defined status retention period.

You can limit the output to a specified status, such as only messages with a status of active. If you do not specify any parameters, all messages are displayed.

### Privilege class

Any administrator can issue this command.

### Syntax

```

.-Format----Standard----.
>>-Query MONITORStatus-----+----->
      '-Format----+Standard+-'
                          '-Detailed-'

.-Type----Active-----.
>--+-----+-----+----->
  '-Type----+All-----+'  '-Activity----activity_name-'
      +-Active---+
      '-Inactive-'

>--+-----+-----+-----><
  '-Name----element_name-' |           .-,----- . |
                          |           v           | |
                          '-Status-----+Normal-----+'
                              +-Warning+
                              '-Error---'

```

## Parameters

---

### Format

Specifies the amount of information that is displayed. The default value is STANDARD. Specify one of the following values:

#### Standard

Specifies that only partial information is displayed for the specified messages.

#### Detailed

Specifies that all information is displayed for the specified messages.

### Type

This parameter restricts the output to only messages with the specified type value. Specify one of the following values:

#### ALL

Displays all information.

#### ACTive

Displays all active messages. This is the default value.

#### Inactive

Displays all inactive messages.

### ACTivity

Specifies the activity that you want to query. See the DEFINE STATUSTHRESHOLD command for details on available activities to query.

### NAME

Specifies the name that you want to query. The NAME value refers to the name of the element with the specified activity. For example, a status indicator that contains information about a storage pool that is called `backuppool` has the NAME set to BACKUPPOOL.

### STatus

Specifies the status of the messages that you want to query. You can specify multiple status values in a list by separating the values with commas and no intervening spaces. If you do not specify a value for this parameter, information for all status values is displayed. Specify one of the following values:

#### Normal

Displays all messages with a normal status.

#### Warning

Displays all messages with a warning status.

#### Error

Displays all messages with an error status.

## Display monitoring settings

---

Display details about the monitoring status.

```
Query MONITORStatus type=active
```

Example output:

```
      Server Name: SERVER1
      Activity Date: 03/05/2013 15:57:37
      Activity Name: CAPACITY OF PRIMARY DISK AND FILE STORAGE
      Element Name: CAPACITY OF PRIMARY DISK AND FILE STORAGE
Element Numeric Value: 0
Element String Value:
      Element State: NORMAL

      Server Name: SERVER1
      Activity Date: 03/05/2013 15:57:37
      Activity Name: USED CAPACITY OF PRIMARY DISK AND FILE STORAGE
      Element Name: USED CAPACITY OF PRIMARY DISK AND FILE STORAGE
Element Numeric Value: 0
Element String Value:
      Element State: NORMAL

      Server Name: SERVER1
      Activity Date: 03/05/2013 15:57:37
      Activity Name: CAPACITY OF PRIMARY TAPE STORAGE
      Element Name: CAPACITY OF PRIMARY TAPE STORAGE
```

```
Element Numeric Value: 0
Element String Value:
  Element State: NORMAL

  Server Name: SERVER1
  Activity Date: 03/05/2013 15:57:37
  Activity Name: USED CAPACITY OF PRIMARY TAPE STORAGE
  Element Name: USED CAPACITY OF PRIMARY TAPE STORAGE
Element Numeric Value: 0
Element String Value:
  Element State: NORMAL
```

## Display monitoring settings

---

Display details about the monitoring status.

```
query monitorstatus f=d type=active
```

Example output:

```
      Server Name: SERVER1
      Activity Date: 03/05/2013 15:57:37
      Activity Name: CAPACITY OF PRIMARY DISK AND
                    FILE STORAGE
      Element Name: CAPACITY OF PRIMARY DISK AND
                    FILE STORAGE
Element Numeric Value: 0
Element String Value:
  Element State: NORMAL
  Element Details:
    Primary Repair Suggestion:
    First Alternate Repair Suggestion:
    Second Alternate Repair Suggestion:

      Server Name: SERVER1
      Activity Date: 03/05/2013 15:57:37
      Activity Name: USED CAPACITY OF PRIMARY DISK AND
                    FILE STORAGE
      Element Name: USED CAPACITY OF PRIMARY DISK AND
                    FILE STORAGE
Element Numeric Value: 0
Element String Value:
  Element State: NORMAL
  Element Details:
    Primary Repair Suggestion:
    First Alternate Repair Suggestion:
    Second Alternate Repair Suggestion:

      Server Name: SERVER1
      Activity Date: 03/05/2013 15:57:37
      Activity Name: CAPACITY OF PRIMARY TAPE STORAGE
      Element Name: CAPACITY OF PRIMARY TAPE STORAGE
Element Numeric Value: 0
Element String Value:
  Element State: NORMAL
  Element Details:
    Primary Repair Suggestion:
    First Alternate Repair Suggestion:
    Second Alternate Repair Suggestion:

      Server Name: SERVER1
      Activity Date: 03/05/2013 15:57:37
      Activity Name: USED CAPACITY OF PRIMARY
                    TAPE STORAGE
      Element Name: USED CAPACITY OF PRIMARY
                    TAPE STORAGE
Element Numeric Value: 0
Element String Value:
  Element State: NORMAL
  Element Details:
    Primary Repair Suggestion:
    First Alternate Repair Suggestion:
    Second Alternate Repair Suggestion:
```

## Field descriptions

---

Server Name	The name of the server.
Activity Date	The last date and time activity was reported.
Activity Name	The name of the activity.
Element Name	The name of the element.
Element Numeric Value	The numeric value of the element.
Element String Value	The string value of the element.
Element State	The state of the element.
Element Details	The detailed information of the element.
Primary Repair Suggestion	The primary repair suggestion.
First Alternate Repair Suggestion	The repair suggestion to follow if the primary suggestion is not adequate.
Second Alternate Repair Suggestion	The repair suggestion to follow if the primary and first alternate suggestions are not adequate.

## Related commands

---

Table 1. Commands related to QUERY MONITORSTATUS

Command	Description
DEFINE STATUSTHRESHOLD (Define a status monitoring threshold)	Defines a status monitoring threshold.
DELETE STATUSTHRESHOLD (Delete a status monitoring threshold)	Deletes a status monitoring threshold.
QUERY MONITORSETTINGS (Query the configuration settings for monitoring alerts and server status)	Displays information about monitoring alerts and server status settings.
QUERY STATUSTHRESHOLD (Query status monitoring thresholds)	Displays information about a status monitoring thresholds.
SET STATUSATRISKINTERVAL (Specifies whether to enable client at-risk activity interval evaluation)	Specifies whether to enable client at-risk activity interval evaluation
SET STATUSMONITOR (Specifies whether to enable status monitoring)	Specifies whether to enable status monitoring.
SET STATUSREFRESHINTERVAL (Set refresh interval for status monitoring)	Specifies the refresh interval for status monitoring.
SET STATUSSKIPASFAILURE (Specifies whether to use client at-risk skipped files as failure evaluation)	Specifies whether to use client at-risk skipped files as failure evaluation
UPDATE STATUSTHRESHOLD (Update a status monitoring threshold)	Changes the attributes of an existing status monitoring threshold.

## QUERY MOUNT (Display information on mounted sequential access volumes)

---

Use this command to display information about the status of one or more sequential access volumes that are mounted.

### Privilege class

---



Any administrator can issue this command.

## Syntax

---

```
..*----- .-Format----Standard-----
>>-Query MOUNT--+-+-----+-----+-----><
'-volume_name-' '-Format-----+Standard+-'
'-Detailed-'
```

## Parameters

---

### volume\_name

Specifies the name of the mounted sequential access volume. You can use wildcard characters to specify this name. This parameter is optional. The default is all mounted volumes.

### Format

Specifies how the information is displayed. This parameter is optional. The default value is STANDARD. Possible values are:

#### Standard

Specifies that partial information is displayed.

#### Detailed

Specifies that complete information is displayed.

## Example: List all mounted sequential volumes

---

Display information on all mounted sequential media volumes.

```
query mount
```

### AIX

```
ANR8330I 3590 volume D6W992 is mounted R/O
in drive RMT1(/dev/rmt1), status: IN USE.
ANR8334I 1 volumes found.
ANR8331I 8MMTAPE volume WPD000 is mounted R/W
in drive 8MM.1 (/dev/mt0), status: DISMOUNTING.
ANR8334I 1 volumes found.
```

### Linux

```
ANR8330I 3590 volume D6W992 is mounted R/O
in drive RMT1/dev/IBmtape1, status: IN USE.
ANR8334I 1 volumes found.
ANR8331I 8MMTAPE volume WPD000 is mounted R/W
in drive 8MM.1 (/dev/tmsmscsi/mt0), status: DISMOUNTING.
ANR8334I 1 volumes found.
```

### Windows

```
ANR8330I 3590 volume D6W992 is mounted R/O
in drive RMT1(/dev/rmt1), status: IN USE.
ANR8334I 1 volumes found.
ANR8331I 8MMTAPE volume WPD000 is mounted R/W
in drive 8MM.1 (mt3.0.0.0), status: DISMOUNTING.
ANR8334I 1 volumes found.
```

### Remember:

1. If the status of a volume is full or if its access mode is read-only (R/O), the mount mode of the volume is R/O. To determine the status and access mode of a volume, issue the `QUERY VOLUME FORMAT=DETAILED` command. If a volume can be written to (that is, the status is filling or empty), the mount mode of the volume is read/write (R/W), even if it is only being read.
2. In a storage pool that is associated with the FILE or CENTERA device type, the server can complete concurrent multiple read-access and one write-access to the same volume. As a result, a volume in a storage pool with a device type of FILE or CENTERA can appear to be mounted more than once.
3. In the message ANR8448I, the drive name is listed as UNKNOWN for volumes of the FILE device type with a non-shared device class. The reason is that no drive is associated with the volumes; drive names are shown in the file-based library.

- If you issue the QUERY MOUNT command while the drive is being cleaned, the command output continues to show a DISMOUNTING status for the dismounted volume until the cleaning completes.

## Example: Display detailed information about mounted sequential volumes

Display details about mounted volumes.

```
query mount format=detailed

ANR2017I Administrator SERVER_CONSOLE issued command: QUERY
MOUNT format=detailed
ANR8487I Mount point in device class FILE is waiting for the
volume mount to
complete -- owning server: SERVER1, status: WAITING FOR VOLUME
(session: 0, process: 1).
ANR8488I LTO volume 015005L4 is mounted R/W in drive IBMVTL1
(/dev/rmt37) -- owning
server: SERVER1, status: IN USE (session: 0, process: 2).
ANR8486I Mount point in device class FILE is reserved -- owning
server: SERVER1,
status: RESERVED (session: 5, process: 0).
ANR8334I          3 matches found.
```

## Related commands

Table 1. Commands related to QUERY MOUNT

Command	Description
DISMOUNT VOLUME	Dismounts a sequential, removable volume by the volume name.
REPLY	Allows a request to continue processing.

## QUERY NASBACKUP (Query NAS backup images)

Use this command to display information about the file system image objects that have been backed up for a specific NAS node and file space. You can only use this command to display objects that were backed up for a NAS node using NDMP.

The server displays all matching objects, the dates that these objects were backed up, and information about a table of contents (TOC) for the object.

## Privilege class

Any administrator can issue this command.

## Syntax

```
>>-Query NASBackup--node_name--file_space_name----->
  .-BEGINDate---TODAY - 7-.  .-BEGINTime---00:00:00-.
>--+-----+-----+----->
  '-BEGINDate---date-----'  '-BEGINTime---time-----'

  .-ENDDate---TODAY-.  .-ENDTime---23:59:59-.
>--+-----+-----+----->
  '-ENDDate---date--'  '-ENDTime---time-----'

  .-TYPE---BACKUPImage-----
>--+-----+----->>
  '-TYPE---+BACKUPImage+-'
          '-SNAPMirror--'
```

## Parameters

node\_name (Required)

Specifies the name of the NAS node for which backup objects are displayed. You cannot use wildcards to specify this name.  
 filesystem\_name (Required)

Specifies the name of the file space for which backup objects are displayed. You can use wildcards to specify this name.

#### BEGINDate

Specifies the beginning date to select the backup objects to display. All backup objects that were created on or after the specified date are displayed. The default is seven days prior to the current date. You can use this parameter with the BEGINTIME parameter to specify a range for the date and time. This parameter is optional.

You can specify the date using one of the following values:

Value	Description	Example
MM/DD/YYYY	A specific date	09/15/2002
TODAY	The current date	TODAY
TODAY-days or -days	The current date minus days specified. The maximum number of days you can specify is 9999.	TODAY -7 or -7.  To display information about the image objects that have been created a week ago, you can specify BEGINDATE=TODAY-7 or BEGINDATE= -7.
EOLM (End Of Last Month)	The last day of the previous month.	EOLM
EOLM-days	The last day of the previous month minus days specified.	EOLM-1  To include files that were active a day before the last day of the previous month.
BOTM (Beginning Of This Month)	The first day of the current month.	BOTM
BOTM+days	The first day of the current month, plus days specified.	BOTM+9  To include files that were active on the 10th day of the current month.

#### BEGINTime

Specifies the beginning time to select the backup objects to display. All backup objects created on or after the specified time display. This parameter is optional. The default is midnight (00:00:00) on the date specified for the BEGINDATE.

You can specify the time using one of the following values:

Value	Description	Example
HH:MM:SS	A specific time on the specified begin date	10:30:08
NOW	The current time on the specified begin date	NOW
NOW+HH:MM or +HH:MM	The current time plus hours and minutes on the specified begin date	NOW+03:00 or +03:00.  If you issue this command at 9:00 with BEGINTIME=NOW+3 or BEGINTIME=+3, the server displays image objects with a time of 12:00 or later on the begin date.
NOW-HH:MM or -HH:MM	The current time minus hours and minutes on the specified begin date	NOW-04:00 or -04:00.  If you issue this command at 9:00 with BEGINTime=NOW-3:30 or BEGINTime= -3:30, the server displays image objects with a time of 5:30 or later on the begin date.

#### ENDDate

Specifies the ending date used to select the backup objects to be displayed. All backup objects created on or before the specified date are displayed. This parameter is optional. The default is the current date. You can use this parameter with the ENDTIME parameter to specify an ending date and time.

You can specify the date using one of the following values:

Value	Description	Example
MM/DD/YYYY	A specific date	09/15/2002

Value	Description	Example
TODAY	The current date	TODAY
TODAY-days or -days	The current date minus days specified. The maximum number of days you can specify is 9999.	TODAY-1 or -1. To display information created up to yesterday, you can specify ENDDATE=TODAY-1 or simply ENDDATE= -1.
EOLM (End Of Last Month)	The last day of the previous month.	EOLM
EOLM-days	The last day of the previous month minus days specified.	EOLM-1 To include files that were active a day before the last day of the previous month.
BOTM (Beginning Of This Month)	The first day of the current month.	BOTM
BOTM+days	The first day of the current month, plus days specified.	BOTM+9 To include files that were active on the 10th day of the current month.

#### ENDTime

Specifies the ending time used to select the backup objects to be displayed. All backup objects created on or before the specified time are displayed. This parameter is optional. The default is 23:59:59. You can use this parameter with the ENDDATE parameter to specify a range for the date and time.

You can specify the time using one of the following values:

Value	Description	Example
HH:MM:SS	A specific time on the specified end date	10:30:08
NOW	The current time on the specified end date	NOW
NOW+HH:MM or +HH:MM	The current time plus hours and minutes on the specified end date	NOW+03:00 or +03:00. If you issue this command at 9:00 with ENDTIME=NOW+3:00 or ENDTIME= +3:00, the server displays image objects with a time of 12:00 or later on the end date you specify.
NOW-HH:MM or -HH:MM	The current time minus hours and minutes on the specified end date	NOW-03:30 or -03:30. If you issue this command at 9:00 with ENDTIME=NOW-3:30 or ENDTIME= -3:30, the server displays image objects with a time of 5:30 or later on the end date you specify.

#### TYPE

Specifies the type of NDMP backup images for which you want to display information. The default value for this parameter is BACKUPIIMAGE. Other image types represent backup methods that might be specific to a particular file server. Possible values are:

##### BACKUPIImage

Specifies that the output should show only the standard NAS base and differential images. This is the default value for this parameter.

##### SNAPMirror

Specifies whether to display information about NetApp SnapMirror images. SnapMirror images are block-level full-backup images of a file system. A SnapMirror image can only be restored to a file system that has been prepared as a SnapMirror target volume. Refer to the documentation that came with your NetApp file server for more information. This parameter is valid for NetApp and IBM N-Series file servers only.

### Example:

Issue the QUERY NASBACKUP command to display information about a node, nas1, and a filespace, /vol/vol1.

```
query nasbackup nas1 /vol/vol1
```

Node Name	Filespace Name	Object Type (MB)	Object Size (MB)	Creation Date Contents	Has Table of Contents (TOC)	Mgmt Class Name	Image Storage Pool Name
NAS1	vol/vol1	Full image	1050.5	10/22/2002 10:50:57	YES	DEFAULT	NASBACKUPS
NAS1	vol/vol1	Differential image	9.1	10/22/2002 11:03:21	YES	DEFAULT	NASBACKUPS
NAS1	vol/vol1	Full image	1050.5	10/22/2006 10:43:00	YES	STANDARD	FILEPOOL
NAS1	vol/vol1	Differential image	9.1	10/25/2006 11:53:21	YES	STANDARD	FILEPOOL

## Example:

Issue the QUERY NASBACKUP command to display information about all NetApp SnapMirror to Tape images for a node, nas2, and a filespace, /vol/vol2.

```
query nasbackup nas2 /vol/vol2 type=snapmirror
```

Node Name	Filespace Name	Object Type	Object Size (MB)	Creation Date	Mgmt Class Name	Image Storage Pool Name
NAS2	vol/vol2	SnapMirror	1050.5	04/02/2008 10:50:57	STANDARD	MYPOOL
NAS2	vol/vol2	SnapMirror	1450.5	04/02/2008 11:03:21	STANDARD	MYPOOL

## Field descriptions

### Node Name

The name of the client node.

### Filespace Name

The name of the filespace.

### Object Type

The type of object backed up.

### Object Size (MB)

The size of the object in megabytes.

### Creation Date

The date the backup was created.

### Mgmt Class Name

The name of the management class.

### Image Storage Pool Name

The name of the storage where the backup resides.

## Related commands

Table 1. Commands related to QUERY NASBACKUP

Command	Description
BACKUP NODE	Backs up a network-attached storage (NAS) node.
BACKUP NAS (IBM Spectrum Protect™ client command)	Creates a backup of NAS node data.
QUERY TOC	Displays details about the table of contents for a specified backup image.
RESTORE NODE	Restores a network-attached storage (NAS) node.

## QUERY NODE (Query nodes)

Use this command to view information about one or more registered nodes.

## Privilege class

---

Any administrator can issue this command.

## Syntax

---

```
.-*-----.  
>>-Query Node-----+-----+-----+-----+----->  
      '-node_name-' |           .-,-----. |  
                  |           v           | |  
                  '-Dmain-----domain_name--+'  
  
.-Format-----Standard-----.  
>--+-----+-----+-----+-----+----->  
  '-Format-----+Standard--+'  
      '-Detailed-'  
  
.-Type-----Client-----.  
>--+-----+-----+-----+-----+----->>  
  '-AUTHentication-----+LOCAL--+' '-Type-----+Client--+'  
      '-LDap--'                +-NAS-----+  
                                +-Server--+  
                                '-Any-----'
```

## Parameters

---

### node\_name

Specifies the name of the client node to be queried. You can use wildcard characters to specify this name. All matching client nodes are queried. If you do not specify a value for this parameter, all client nodes are queried. The parameter is optional.

### Dmain

Specifies a list of policy domains that limit the client node query. Only nodes that are assigned to one of the specified policy domains are displayed. This parameter is optional. Separate the items in the list by commas, with no intervening spaces. You can use wildcard characters to specify a domain. All clients that are assigned to a matching domain are displayed. If you do not specify a value for this parameter, all policy domains are included in the query.

### Format

Specifies how the information is displayed. This parameter is optional. The default value is STANDARD. You can specify one of the following values:

#### Standard

Specifies that partial information is displayed for the specified client nodes.

#### Detailed

Specifies that complete information is displayed for the specified client nodes.

### Type

Specifies the type of node to include in the query results. The parameter is optional. The default value is CLIENT. You can specify one of the following values:

#### Any

Specifies any type of node.

#### Client

Specifies client nodes that are backup-archive clients, IBM Spectrum Protect™ for Space Management clients, or application clients.

#### NAS

Specifies NAS nodes.

#### Server

Specifies client nodes that are other servers.

### Authentication

Specifies the password authentication method for the node.

### Local

Display those nodes that authenticate to the IBM Spectrum Protect server.

LDap

Display those nodes that authenticate to an LDAP directory server. The node password is case-sensitive.

## Example: Display information about registered client nodes

---

Display information about all registered client nodes.

```
query node
```

Node Name	Platform	Policy Domain Name	Days Since Last Access	Days Since Password Set	Locked?
CLIENT1	AIX	STANDARD	6	6	No
GEORGE	AIX	STANDARD	1	1	No
JANET	AIX	STANDARD	1	1	No
JARED	Linux86	STANDARD	1	1	No
JOE2	Mac	STANDARD	<1	<1	No
TOMC	WinNT	STANDARD	1	1	No

## Example: Displayed detailed information about a client node

---

Display complete information about the client node named Joe.

```
query node joe format=detailed
```

```
Node Name: JOE
Platform: WinNT
Client OS Level: 4.00
Client Version: Version 5, Release 4,
Level 0.0
Application Version: Version 6, Release 4,
Level 0.4
Policy Domain Name: STANDARD
Last Access Date/Time: 09/24/2012 18:55:46
Days Since Last Access: 6
Password Set Date/Time: 09/24/2012 18:26:43
Days Since Password Set: 6
Invalid Sign-on Count: 0
Locked?: No
Contact:
Compression: Client
Archive Delete Allowed?: Yes
Backup Delete Allowed?: No
Registration Date/Time: 09/24/2012 18:26:43
Registering Administrator: SERVER_CONSOLE
Last Communication Method Used: Tcp/Ip
Bytes Received Last Session: 108,731
Bytes Sent Last Session: 698
Duration of Last Session: 0.00
Pct. Idle Wait Last Session: 0.00
Pct. Comm. Wait Last Session: 0.00
Pct. Media Wait Last Session: 0.00
Optionset:
URL: http://joe.host.name:1581
Node Type: Client
Password Expiration Period: 60
Keep Mount Point?: No
Maximum Mount Points Allowed: 2
Auto Filespace Rename: No
Validate Protocol: No
TCP/IP Name:
TCP/IP Address: 9.11.153.39
Globally Unique ID: 11.9c.54.e0.8a.b5.11.d6.b3.
c3.00.06.29.45.c1
Transaction Group Max: 0
Data Write Path: ANY
Data Read Path: ANY
Session Initiation: ClientOrServer
High-level Address:
```

Low-level Address: 1501  
Collocation Group Name:  
Proxynode Target:  
Proxynode Agent:  
Node Groups:  
Email Address:  
Deduplication: ServerOnly

AIX Linux

Users allowed to back up: ALL  
Replication State: Enabled  
Replication Mode: Send  
Backup Replication Rule: DEFAULT  
Archive Replication Rule: ALL\_DATA  
Space Management Replication Rule: None  
Replication Primary Server: PRODSERVER1  
Last Replicated to Server: DRSERVER1  
Client OS Name: WIN: Windows XP  
Client Processor Architecture: x86  
Client Products Installed: WIN, FCM, VE  
Client Target Version:  
Version 6, Release 2, Level 0.0  
Authentication: Local  
SSL Required: No  
Session Security: Strict  
Transport Method: TLS 1.2  
Split Large Objects: Yes  
At-risk type: Default interval  
At-risk interval:  
Utility URL:  
Replication Recovery of Damaged Files: Yes  
Decommissioned:  
Decommissioned Date:

## Field descriptions

---

### Node Name

The name of the client node.

### Platform

The operating system of the client node, as of the last time that the client node contacted the server. A question mark (?) is displayed until the client node first accesses the server and reports its operating system type.

### Client OS Level

The level of the operating system for the client as of the last time that the client node contacted the server.

### Client Version

The version of the client that is installed on the client node.

This field does not apply to NAS nodes.

### Application Version

The version of the Data Protection for VMware client.

### Policy Domain Name

The assigned policy domain of the client node.

### Last Access Date/Time

The last date and time that the client node accessed the server.

### Days Since Last Access

The number of days that elapsed since the last time that the client node accessed the server.

### Password Set Date/Time

The date and time that the password was set for the client node.

### Days Since Password Set

The number of days that elapsed since the password was set for the client node.

### Invalid Sign-on Count

The number of invalid sign-on attempts that were made since the last successful sign-on. This count can be non-zero only when the invalid password limit (SET INVALIDPWLIMIT) is greater than zero. When the number of invalid attempts equals the limit that is set by the SET INVALIDPWLIMIT command, the node is locked out of the system.

### Locked?

Whether the client node is locked out of IBM Spectrum Protect.

### Contact

Any contact information for the client node.



#### Compression

Whether compression is enabled on the client node.

This field does not apply to NAS nodes.

#### Archive Delete Allowed?

Whether the client node can delete its own archive files.

#### Backup Delete Allowed?

Whether the client node can delete its own backup files.

#### Registration Date/Time

The date and time that the client node was registered.

#### Registering Administrator

The name of the administrator that registered the client node.

#### Last Communication Method Used

The communication method that was last used by the client node to contact the server.

#### Bytes Received Last Session

The number of bytes received by the server during the last client node session.

This field does not apply to NAS nodes.

#### Bytes Sent Last Session

The number of bytes sent to the client node.

This field does not apply to NAS nodes.

#### Duration of Last Session

How long the most recent client node session lasted, in seconds.

This field does not apply to NAS nodes.

#### Pct. Idle Wait Last Session

The percentage of the total session time that the client was not running any functions.

This field does not apply to NAS nodes.

#### Pct. Comm. Wait Last Session

The percentage of the total session time that the client waited for a communication response from the server.

This field does not apply to NAS nodes.

#### Pct. Media Wait Last Session

The percentage of the total session time that the client waited for a removable volume to be mounted.

This field does not apply to NAS nodes.

#### Optionset

The name of the client option set.

#### URL

The URL of the IBM Spectrum Protect web client that is configured on the client system. You can use the URL in a web browser and in the Operations Center to remotely manage the client node.

#### Node Type

The type of client node. One of the following values is possible:

- Client: a backup-archive client, an IBM Spectrum Protect for Space Management client, or an application client
- Server: an IBM Spectrum Protect server
- NAS: a NAS file server

#### Password Expiration Period

The password expiration period of the client node.

#### Keep Mount Point?

Whether the client node retains a mount point during a session.

#### Maximum Mount Points Allowed

The number of mount points that a client node can use on the server for IBM Spectrum Protect for Space Management migration and for backup and archive operations. This parameter does not apply to nodes with a type of NAS or SERVER. If a client node was registered to a server at Version 3.7 or later, the value is 0-999, depending on the value that is set with the MAXNUMMP parameter of the REGISTER NODE command. If the client node was registered under previous versions of

the server and the MAXNUMMP parameter was not explicitly set by using the UPDATE NODE command, the value is set to NOLIMIT. The MAXNUMMP value is not evaluated or enforced during client data read operations such as restore, retrieve, and IBM Spectrum Protect for Space Management recall. However, mount points in use for data read operations are evaluated against attempted concurrent data store operations for the same client node. This evaluation might prevent the data store operations from acquiring mount points.

#### Auto Filespace Rename

Whether IBM Spectrum Protect prompts the client to rename file spaces when the client system upgrades to a client that supports Unicode. This field is valid only for client systems that use Windows, Macintosh OS X, or NetWare operating systems.

#### Validate Protocol (deprecated)

Whether the client has data validation enabled. If the client has data validation enabled, this field specifies whether IBM Spectrum Protect validates only the file data or all data, which includes file metadata. You can enable data validation by using the REGISTER NODE or UPDATE NODE command. This field is deprecated.

#### TCP/IP Name

The host name of the client node as of the last time that the client node contacted the server. The field is blank if the client software does not support reporting this information to the server.

#### TCP/IP Address

The TCP/IP address of the client node as of the last time that the client node contacted the server. The field is blank if the client software does not support reporting this information to the server.

#### Globally Unique ID

The globally unique identifier (GUID) as of the last time that the client node contacted the server. This GUID identifies the host computer on which the node is located.

#### Transaction Group Max

Specifies the number of files per transaction committed that are transferred between a client and a server. Client performance might be improved by using a larger value for this option.

#### Data Write Path

Specifies the transfer path that is used when the client sends data to the server, storage agent, or both, during storage operations. If a path is unavailable, the node cannot send any data.

**AIX** | **Linux** Data transfer path options are ANY, LAN, or LAN-free.

#### Data Read Path

Specifies the transfer path that is used when the server, storage agent, or both, read data for a client, during operations such as restore or retrieve. If a path is unavailable, data cannot be read.

**AIX** | **Linux** Data transfer path options are ANY, LAN, or LAN-free.

#### Session Initiation

Controls whether the server or client initiates sessions. The following two options are available:

- ClientOrServer
- Serveronly

#### High-level Address

Specifies the client IP address that the server contacts to initiate scheduled events when SESSIONINITIATION is set to SERVERONLY.

#### Low-level Address

Specifies the client port number on which the client listens for sessions from the server when SESSIONINITIATION is set to SERVERONLY.

#### Collocation Group Name

Specifies the name of the collocation group to which a node belongs. If a node does not belong to a collocation group, this field is blank.

Tip: If the node contains file spaces that are members of a file space collocation group, this field is left blank. You can find file space names by issuing the QUERY FILESPACE command.

#### Proxynode Target

Specifies which nodes are proxy nodes (agents) for other nodes, in a space-separated list. If there are no nodes in that type of association, this field is blank.

#### Proxynode Agent

Specifies the originating (target) node name for a proxy node session, in a space separated list. If there are no nodes in that type of association, this field is blank.

#### Node Groups

Specifies the name of the node group to which a node belongs. If a node does not belong to a node group, this field is blank.

## Email Address

Specifies the email address of the client node.

## Deduplication

The location where data is deduplicated. The value `ServerOnly` specifies that data stored by this node can be deduplicated on the server only. The `Clientorserver` value specifies that data stored by this node can be deduplicated on either the client or the server.

AIX	Linux
	Users allowed to back up

AIX	Linux
	Specifies whether a non-root user ID or only a root user ID can back up files to the server. ALL indicates all users, while ROOT indicates that just the root user ID can back up files to the server. This output is not available if the client node operating system is considered a single-user operating system.

## Replication State

Indicates whether the node is enabled for replication. The following values are possible:

### Enabled

The node is configured for replication and ready to replicate.

### Disabled

The node is configured for replication but is not ready to replicate.

### None

The node is not configured for replication.

## Replication Mode

Indicates whether the node is configured as the source of or target for replicated data. If this field is blank, the node is not configured for replication. The following values are possible:

### Send

The node is configured as the source of data for replication.

### Receive

The node is configured as the target of data for replication.

### SyncSend

The data that belongs to the node is to be synchronized with the node data that is on the target replication server. Synchronization applies only to nodes whose data was imported from a source replication server and imported to the target replication server. Synchronization occurs during replication.

### SyncReceive

The data that belongs to the node is to be synchronized with the node data that is on the source replication server. Synchronization applies only to nodes whose data was imported from a source replication server and imported to the target replication server. Synchronization occurs during replication.

### None

The node is not configured for replication.

## Replication Primary Server

Specifies the source replication server for the client node.

## Backup Replication Rule

## Archive Replication Rule

## Space Management Replication Rule

The replication rule that applies to back up, archive, and space-managed data that belongs to the node. The following values are possible:

### ALL\_DATA

Replicates backup, archive, or space-managed data. The data is replicated with normal priority.

### ACTIVE\_DATA

Replicates active backup data. The data is replicated with normal priority.

Attention: If you specify `ACTIVE_DATA` and one or more of the following conditions are true, inactive backup data on the target replication server is deleted, and inactive backup data on the source replication server is not replicated.

- When a server version earlier than Version 7.1.1 is installed on either the source or target replication servers.
- When you are using the `REPLICATE NODE` command with the `FORCERECONCILE=YES` parameter.
- When you are running the initial replication of a file space after you configure replication, restore the database, or upgrade both the source and target replication servers from a server version earlier than V7.1.1.

If the previous conditions are not true, all new and changed files since the last replication are replicated, including inactive files, and files are deleted when they expire.

### ALL\_DATA\_HIGH\_PRIORITY

Replicates backup, archive, or space-managed data. The data is replicated with high priority.

### ACTIVE\_DATA\_HIGH\_PRIORITY

This rule is the same as the ACTIVE\_DATA replication rule except data is replicated with a high priority.

**DEFAULT**

Replicates backup, archive, or space-managed data according to the domain rule for the data type.

**NONE**

No data is replicated. For example, if the replication rule for archive data is NONE, archive data that belongs to the node is not replicated.

**Last Replicated to Server**

Specifies the name of the server that the node was last replicated to and the name of the server that the client fails over to during restore operations.

**Client OS Name**

The operating system of the client. The client deployment wizard uses this information to deploy a package to the client. This field is reported only for IBM Spectrum Protect clients at V6.2.0.0 and later.

**Client Processor Architecture**

The client architecture. The client deployment wizard uses this value to determine which package to deploy when the client is being updated. This field is reported only for IBM Spectrum Protect clients at V6.2.0.0 and later.

**Client Products Installed**

The products that are on the node. The following products might be listed:

- BA (Backup-Archive Client)
- VE (Virtual Environments)
- FCM (FlashCopy® Manager)

**Client Target Version**

The version of the client that is installed at a time that is scheduled through the DEFINE SCHEDULE or UPDATE SCHEDULE command. This field is reported only for IBM Spectrum Protect clients at V6.2.0.0 and later.

**Authentication**

Specifies the password authentication method: LOCAL, LDAP, or LDAP (pending).

<b>Authentication Target</b>	<b>Authentication Method</b>
IBM Spectrum Protect server	LOCAL
LDAP directory server	LDAP
This node is configured to authenticate with an LDAP directory server, but the node did not yet authenticate.	LDAP (pending)

**SSL Required (deprecated)**

Specifies whether the security setting for the node requires the Secure Sockets Layer (SSL) protocol. Values can be YES, NO, or Default. You must have system level authority to update the node SSLREQUIRED setting. This field is deprecated.

**Session Security**

Specifies the level of session security that is enforced for the node. Values can be STRICT or TRANSITIONAL.

**Transport Method**

Specifies the transport method that was last used for the specified node. Values can be TLS 1.2, TLS 1.1, or NONE. A question mark (?) is displayed until a successful authentication is completed.

**Split Large Objects**

Specifies whether large objects that are stored by this node are automatically split into smaller pieces, by the server, to optimize server processing. Yes indicates that the server splits large objects (over 10 GB) into smaller pieces when stored by a client node. No indicates that this process is bypassed. The default value is Yes.

**At-risk type**

Specifies the at-risk evaluation type. Values can be Default, Bypassed, or Custom. Default indicates that the node is evaluated with the same interval that was specified for the nodes classification by the SET STATUSATRISKINTERVAL command. Bypassed indicates that the node is not evaluated for at-risk status by the status monitor. Custom indicates that the node is evaluated with the interval that was specified by the SET NODEATRISKINTERVAL command, rather than the interval that was specified by the SET STATUSATRISKINTERVAL command.

**At-risk interval**

Specifies the number of hours between two client backup activities, or two replication activities, after which the status monitor indicates that the activity is at risk. This field contains a value only when the At-risk type field contains the value of Custom.

**Utility URL**

Specifies the address of the IBM Spectrum Protect client management services that are configured on the client system. This URL is used by the Operations Center to access client log files so that you can remotely diagnose client issues from the Operations Center.

#### Replication Recovery of Damaged Files

Specifies whether damaged files can be recovered for this node from a target replication server.

#### Decommissioned

Specifies whether the client node is decommissioned. The following values are possible:

##### YES

Specifies that the node is decommissioned.

##### Null value

Specifies that the node is not decommissioned.

##### PENDING

Specifies that the node is being decommissioned, or the decommission process failed.

Tip: If you want to determine the status of a pending decommission process, follow the instructions in Decommissioning a client node.

#### Decommissioned Date

Specifies the date that the client node was decommissioned.

## Example: Display information about node roles

---

The example output is only a portion of the full display.

```
query node alvin f=d
```

```
Proxynode Agent:
Node Groups:
Email Address:
Deduplication: ServerOnly
Users allowed to back up: All
Role: Server
Role Override: UseReported
Processor Vendor: ORACLE
Processor Brand: UltraSPARC-T2
Processor Type: 4
Processor Model:
Processor Count: 1
Hypervisor:
API Application: NO
Scan Error: NO
MAC Address:
```

## Field Descriptions

---

#### Role

The processor role as reported by the client.

#### Role Override

The override value for role, which is specified with the UPDATE NODE command.

#### Processor Vendor

The processor vendor as reported by the client.

#### Processor Brand

The processor brand as reported by the client.

#### Processor Type

The processor type as reported by the client. This value specifies the number of processor cores that are used for PVU calculation.

#### Processor Model

The processor model as reported by the client.

#### Processor Count

The processor count as reported by the client.

#### Hypervisor

The hypervisor as reported by the client.

#### API Application

The client indicator that the client is an API application.

#### Scan Error

The indicator of whether the latest scan for processor information might be failing and needs investigation.  
 MAC Address  
 MAC Address as reported by the client.

## Example: View all nodes that authenticate to the IBM Spectrum Protect server

If you want to view all nodes that authenticate locally, specify the following command:

```
query node * authentication=local
```

Node Name	Platform	Policy Domain Name	Days Since Last Access	Days Since Password Set	Locked?
NODE1	WinNT	STANDARD	3	3	No
LOCAL	(?)	STANDARD	7	7	No

## Related commands

Table 1. Commands related to QUERY NODE

Command	Description
LOCK NODE	Prevents a client from accessing the server.
QUERY ADMIN	Displays information about one or more IBM Spectrum Protect administrators.
QUERY REPLNODE	Displays information about the replication status of a client node.
QUERY STATUS	Displays the settings of server parameters, such as those selected by the SET commands.
REGISTER NODE	Defines a client node to the server and sets options for that user.
REMOVE NODE	Removes a client from the list of registered nodes for a specific policy domain.
REMOVE REPLNODE	Removes a node from replication.
RENAME NODE	Changes the name for a client node.
REPLICATE NODE	Replicates data in file spaces that belong to a client node.
RESET PASSEXP	Resets the password expiration for nodes or administrators.
SET INVALIDPWLIMIT	Sets the number of invalid logon attempts before a node is locked.
SET MINPWLENGTH	Sets the minimum length for client passwords.
SET PASSEXP	Specifies the number of days after which a password is expired and must be changed.
UNLOCK NODE	Enables a locked user in a specific policy domain to access the server.
UPDATE NODE	Changes the attributes that are associated with a client node.

## QUERY NODEDATA (Query client data in volumes)

Use this command to display information about the data for one or more nodes in a sequential access storage pool. QUERY NODEDATA displays the name of the volume on which a node's data is written and the amount of space that is occupied by the data on that volume. This information is useful when you determine how to group nodes into collocated storage pools.

### Privilege class

Restriction: You cannot use this command to display information for container storage pools.

Any administrator can issue this command.

## Syntax

```
      .-|-----|
      v      |
>>-Query NODEData+-----node_name+-----+----->
      '-COLLOCGroup-----colloc_group-'
>-----><
      '-STGpool-----pool_name-' '-VOLUME-----vol_name-'
```

## Parameters

### node\_name

Specifies the name of the client node for which you want to locate data. You can specify one or more names. If you specify multiple names, separate the names with commas; do not use intervening spaces. You can also use wildcard characters to specify multiple names. You must specify either a node name or collocation group name, but not both.

### COLLOCGroup

Specifies the name of the collocation group for which you want to locate data. You must specify either a node name or collocation group name, but not both.

Important: If the amount of space that is needed to complete the query about a collocation group exceeds the SQL buffer limit, the QUERY NODEDATA command can fail. If the command fails for this reason, issue the QUERY COLLOGROUP command to display a list of nodes in the group. Then, issue the QUERY NODEDATA command for each node in the group.

### STGpool

Specifies the name of the sequential storage pool to query. This parameter is optional. You can use wildcard characters to specify the names. If a wildcard matches the name of a disk storage pool, the name of the disk storage pool is ignored. If you do not specify a value for this parameter, all sequential storage pools are queried.

### VOLUME

Specifies the volume that contains the data. This parameter is optional. You can use wildcard characters to specify multiple names. If you do not specify a value for this parameter, all volumes in the storage pool are queried.

## Use wildcards to display node data for a sequential access storage pool

Display information about where node data is stored in a sequential storage pool. Use a wildcard character to indicate node names. See Field descriptions for field descriptions.

```
query nodedata e*
```

Node Name	Volume Name	Storage Pool Name	Physical Space Occupied (MB)
EDU_J2	E:\tsm\server\00000117.BFS	EDU512	0.01
EDU_J2	E:\tsm\server\00000122.BFS	EDU319	0.01
EDU_J3	E:\tsm\server\00000116.BFS	EDU512	0.01
EDU_J3	E:\tsm\server\00000120.BFS	EDU319	0.01
EDU_J7	E:\tsm\server\00000118.BFS	EDU512	0.04
EDU_J7	E:\tsm\server\00000123.BFS	EDU319	0.04
EDU_JJ1	E:\tsm\server\00000116.BFS	EDU512	0.01
EDU_JJ1	E:\tsm\server\00000121.BFS	EDU512	0.01

## Display node data information for a specific collocation group

Display information about the location of node data in a sequential storage pool for a particular collocation group. In this example, nodes EDU\_J3 and EDU\_JJ1 are the only members that belong to collocation group, grp1, and have data in a sequential access storage pool.

```
query nodedata collocgroup=grp1
```

Node Name	Volume Name	Storage Pool Name	Physical Space Occupied (MB)
-----------	-------------	-------------------	------------------------------

```

-----
EDU_J3      E:\tsm\server\00000116.BFS      EDU512      0.01
EDU_J3      E:\tsm\server\00000120.BFS      EDU319      0.01
EDU_JJ1     E:\tsm\server\00000116.BFS      EDU512      0.01
EDU_JJ1     E:\tsm\server\00000121.BFS      EDU512      0.01

```

If you specify a file space collocation group, only the volumes of the file spaces that belong to the collocation group are displayed. If you specify a file space collocation group and a volume, the file space volumes within the collocation group that are also in the specified volume are displayed.

## Field descriptions

### Node Name

Specifies the name of the node.

### Volume Name

Specifies the name of the volume that contains the node data.

### Storage Pool Name

Specifies the name of the storage pool in which the volume is located.

### Physical Space Occupied (MB)

Specifies the amount of physical space that is occupied by the node's data. Physical space includes empty space within aggregates, from which files might be deleted or expired.

## Related commands

Table 1. Commands related to QUERY NODEDATA

Command	Description
DEFINE COLLOGROUP	Defines a collocation group.
DEFINE COLLOCMEMBER	Adds a client node or file space to a collocation group.
DEFINE STGPOOL	Defines a storage pool as a named collection of server storage media.
DELETE COLLOGROUP	Deletes a collocation group.
DELETE COLLOCMEMBER	Deletes a client node or file space from a collocation group.
MOVE NODEDATA	Moves data for one or more nodes, or a single node with selected file spaces.
QUERY COLLOGROUP	Displays information about collocation groups.
QUERY NODE	Displays partial or complete information about one or more clients.
QUERY STGPOOL	Displays information about storage pools.
REMOVE NODE	Removes a client from the list of registered nodes for a specific policy domain.
UPDATE COLLOGROUP	Updates the description of a collocation group.
UPDATE STGPOOL	Changes the attributes of a storage pool.

## QUERY NODEGROUP (Query a node group)

Use this command to display the node groups defined on the server.

### Privilege class

Any administrator can issue this command.

### Syntax

```

.-*-----

```



```

>>-Query NODEGroup--+-----+----->
                        '-group_name-'

.-Format---Standard----.
>--+-----+----->>
  '-Format---+Standard+-'
                        '-Detailed-'

```

## Parameters

---

### group\_name

Specifies the name of the node group to display. To specify multiple names, use a wildcard character. This parameter is optional. The default is to display all node groups.

### Format

Specifies how the information is displayed. This parameter is optional. The default value is STANDARD. Possible values are:

#### Standard

Specifies that partial information is displayed.

#### Detailed

Specifies that complete information is displayed. To display the members of the node group, you must specify FORMAT=DETAILED.

## Example: List node groups on the server

---

Display the node groups defined on the server. See Field descriptions for field descriptions.

```
query nodegroup
```

Node Group Name	Node Group Description
DEPT_ED	Education department
GROUP1	Low cap client nodes.

## Example: Display detailed node group information

---

Display complete information about all node groups and determine which client nodes belong to which node groups. See Field descriptions for field descriptions.

```
query nodegroup format=detailed
```

```

      Node Group Name: DEPT_ED
      Node Group Description: Education department
Last Update by (administrator): SERVER_CONSOLE
      Last Update Date/Time: 04/21/2006 10:59:03
      Node Group Member(s): EDU_1 EDU_7

      Node Group Name: GROUP1
      Node Group Description: Low cap client nodes.
Last Update by (administrator): SERVER_CONSOLE
      Last Update Date/Time: 04/21/2006 10:59:16
      Node Group Member(s): CHESTER REX NOAH JARED

```

## Field descriptions

---

### Node Group Name

The name of the node group.

### Node Group Description

The description for the node group.

### Last Update by (administrator)

The name of the administrator that defined or most recently updated the node group.

### Last Update Date/Time

The date and time that an administrator defined or most recently updated the node group.

### Node Group Member(s)

The members of the node group.

## Related commands

---

Table 1. Commands related to QUERY NODEGROUP

Command	Description
DEFINE BACKUPSET	Defines a previously generated backup set to a server.
DEFINE NODEGROUP	Defines a group of nodes.
DEFINE NODEGROUPMEMBER	Adds a client node to a node group.
DELETE BACKUPSET	Deletes a backup set.
DELETE NODEGROUP	Deletes a node group.
DELETE NODEGROUPMEMBER	Deletes a client node from a node group.
GENERATE BACKUPSET	Generates a backup set of a client's data.
QUERY BACKUPSET	Displays backup sets.
UPDATE BACKUPSET	Updates a retention value associated with a backup set.
UPDATE NODEGROUP	Updates the description of a node group.

## QUERY OCCUPANCY (Query client file spaces in storage pools)

Use this command to show where client file spaces are stored and how much space they occupy.

### Privilege class

Any administrator can issue this command.

### Syntax

```

>>-Query OCCupancy-+-----+----->
      | .-*-----* . |
      |-node_name-+-----+
                '-file_space_name-'

>--+-----+----->
  '-STGpool-----pool_name-'

>--+-----+----->
  '-DEVclass-----device_class_name-'

  .-Type-----ANY----- .  .-NAMEType-----SERVER----- .
>--+-----+-----+-----+----->
  '-Type-----+-ANY-----+-'  '-NAMEType-----+-SERVER-----+-'
      +-Backup---+          +-UNICODE+
      +-Archive--+          '-FSID----'
      '-SPacem--'

  .-CODEType-----BOTH----- .
>--+-----+-----+-----+-----><
  '-CODEType-----+-UNICODE-----+-'
      +-NONUNICODE+
      '-BOTH-----'

```

### Parameters

**node\_name**

Specifies the node that owns the file spaces that you want to locate. This parameter is optional. You can use wildcard characters to specify names. If you do not specify a value for this parameter, all nodes are queried.

**file\_space\_name**

Specifies the file space that you want to locate. This parameter is optional. You can use wildcard characters to specify names. If you do not specify a value for this parameter, all file spaces are queried. You must specify a node name if you specify a file space name.

For a server that has clients with Unicode support, you might need to have the server convert the file space name that you enter. For example, you might need to have the server convert the name that you enter from the server's code page to Unicode. See the NAMETYPE parameter for details. If you do not specify a file space name or specify only a single wildcard character for the name, you can use the CODETYPE parameter to limit the operation to Unicode file spaces or non-Unicode file spaces.

#### STGpool

Specifies the storage pool to query for files from the specified file space. This parameter is optional. You can use wildcard characters to specify names. If you do not specify a value for this parameter, all storage pools are queried.

#### DEVclass

Specifies the device class that is associated with the devices where the file spaces are stored. This parameter is optional. You can use wildcard characters to specify names. If you do not specify a value for this parameter, storage pools that are associated with any device class are queried.

#### Type

Specifies the types of files to query in the file spaces. This parameter is optional. The default value is ANY. Possible values are:

##### ANY

Specifies that all types of files are queried: back up versions of files, archived copies of files, and files that are migrated from IBM Spectrum Protect™ for Space Management clients.

##### Backup

Specifies that backup files are queried.

##### Archive

Specifies that archive files are queried.

##### SPacem

Specifies that space-managed files (files that were migrated by an IBM Spectrum Protect for Space Management client) are queried.

#### NAMETYPE

Specifies how you want the server to interpret the file space names that you enter. This parameter is useful when the server has clients with Unicode support. A backup-archive client with Unicode support is available only for Windows, Macintosh OS 9, Macintosh OS X, and NetWare. Use this parameter only when you specify a partly or fully qualified file space name.

The default value is SERVER. Possible values are:

##### SERVER

The server uses the server's code page to interpret the file space names.

##### UNICODE

The server converts the file space names from the server code page to the UTF-8 code page. The success of the conversion depends on the actual characters in the names and the server's code page. Conversion can fail if the string includes characters that are not available in the server code page, or if the server has a problem accessing system conversion routines.

##### FSID

The server interprets the file space names as their file space IDs (FSIDs).

#### CODETYPE

Specifies how you want the server to interpret the file space names that you enter. Use this parameter only when you enter a single wildcard character for the file space name or when you do not specify any file space name.

The default value is BOTH, which means that the file spaces are included regardless of code page type. Possible values are:

##### UNICODE

Include file spaces that are only Unicode enabled.

##### NONUNICODE

Include file spaces that are not only Unicode enabled.

##### BOTH

Include file spaces regardless of code page type.

## Example: Display file spaces assigned to a specific node

---

Display information about where all file spaces assigned to the node named DAISY are stored. See Field descriptions for field descriptions.

```
query occupancy daisy
```

Node Name	Type	Filespace Name	FSID	Storage Pool Name	Number of Files	Physical Space Occupied (MB)	Logical Space Occupied (MB)
DAISY	Bkup	DRIVED	1	COPYFILE	38	0.45	0.42

## Example: Display file spaces assigned to a specific node with a backup file type

Display information about the file spaces that belong to the node WAYNE, and that have a backup file type. See Field descriptions for field descriptions.

```
query occupancy wayne type=backup
```

Node Name	Type	Filespace Name	FSID	Storage Pool Name	Number of Files	Physical Space Occupied (MB)	Logical Space Occupied (MB)
WAYNE	Bkup	DWG1	1	BACKUPPOOL1	2,330	53.19	50.01
WAYNE	Bkup	OS2C	2	BACKUPPOOL1	1,554	32.00	31.30

## Field descriptions

### Node Name

The node that owns the file space. If the node was previously deleted, the node name DELETED is displayed.

### Type

The type of data. Possible values are:

#### Arch

Data that has been archived.

#### Bkup

Data that has been backed up.

#### SpMg

Data that has been migrated from an IBM Spectrum Protect for Space Management client.

### Filespace Name

The name of the file space that belongs to the node.

If the file space was previously deleted, the file space name DELETED is displayed.

File space names can be in a different code page or locale than the server. If they are, the names in the Operations Center and the administrative command-line interface might not be displayed correctly. Data is backed up and can be restored normally, but the file space name or file name might be displayed with a combination of invalid characters or blank spaces.

If the file space name is Unicode-enabled, the name is converted to the server code page for display. The success of the conversion depends on the operating system, the characters in the name, and the server code page. Conversion can be incomplete if the string includes characters that are not available in the server code page or if the server cannot access system conversion routines. If the conversion is incomplete, the name might contain question marks, blanks, unprintable characters, or ellipses (...).

### Storage Pool Name

The storage pool where the file space is located.

### Number of Files

The number of logical files that belong to the file space and are stored in this storage pool. When storing a file larger than 10 GB, the server splits the file into 10 GB fragments. The number of fragments is also included in this value for occupancy calculations.

### Physical Space Occupied (MB)

The amount of physical space that is occupied by the file space. Physical space includes empty space within aggregates, from which files might have been deleted or expired. For this value, 1 MB = 1048576 bytes.

Tip: This field does not display a value for storage pools that are set up for data deduplication. If you turn off data deduplication for a storage pool, a value for physical occupancy is not displayed until the storage pool is empty of deduplicated files.

### Logical Space Occupied (MB)

The amount of space that is occupied by logical files in the file space. Logical space is the space that is actually used to store files, excluding empty space within aggregates. For this value, 1 MB = 1048576 bytes.

FSID

The file space ID (FSID) for the file space. The server assigns a unique FSID when a file space is first stored on the server.

## Related commands

Table 1. Commands related to QUERY OCCUPANCY

Command	Description
DELETE FILESPACE	Deletes data associated with client file spaces. If a file space is part of a collocation group and you remove the file space from a node, the file space is removed from the collocation group.
QUERY FILESPACE	Displays information about data in file spaces that belong to a client.
QUERY NODE	Displays partial or complete information about one or more clients.

## QUERY OPTION (Query server options)

Use this command to display information about server options.

Change server options by editing the server options file or by issuing the SETOPT command. When you edit the server options file, you must restart the server before any changes take effect. Any changes you make by issuing the SETOPT command take effect immediately.

## Privilege class

Any administrator can issue this command.

## Syntax

```
>>-Query OPTion--+-----+----->>
                  .-*-----
                  +-----+-----
                  '-optionname-'
```

## Parameters

optionname

Specifies the name of an option in the server options file. This parameter is optional. You can use wildcard characters to specify this name. All matching server options display. If you do not specify this parameter, information on all options displays.

## Example: Display all server options

Display general information about all server options. The output lists all options with their specified values.

```
query option
```

## Example: Display options settings using a wildcard character

View the option settings for all options that begin with L.

```
query option l*
```

```
Server Option      Option Setting
-----
Language           AMENG
```

## Example: Display LDAP directory servers

View the settings for all LDAP directory servers.

```
query option ldapurl
```

Server Option	Option Setting
LDAP URL	ldap://tophoy.tucson.com/cn=tsmdata
LDAP URL	ldap://krypton.ibm.com/ou=tsmdata,dc=ibm,dc=com

## Field descriptions

**Server Option**  
Specifies the name of the option in the server options file.

**Option Setting**  
Specifies the name of the option in the server options file.

## Related commands

Table 1. Commands related to QUERY OPTION

Command	Description
SETOPT	Updates a server option without stopping and restarting the server.

## QUERY PATH (Display a path definition)

Use this command to display the path between a source and a destination.

### Privilege class

Any administrator can issue this command.

### Syntax

```

>>-Query PATH----->
      | .-*-----|
      |'-source_name-----'|
      |'-destination_name-'|

      .-SRCType----ANY-----
>--+----->
      '-SRCType----+ANY-----+'
          +-DATAMover-+
          '-SERVer----'

      .-DESTType---ANY-----
>--+----->
      '-DESTType---+ANY-----+'
          +-DRIVE--LIBRary----library_name-+
          '-LIBRary-----'

      .-Format----Standard-----
>--+----->>
      '-Format----+Standard-+-'
          '-Detailed-'
  
```

### Parameters

**source\_name**  
Specifies the name of a source for which to display paths. This parameter is optional. You can specify wildcard characters. The default is to display paths for all sources.

A source is a data mover, a server, or a storage agent.

destination\_name

Specifies the name of a destination for which to display paths. This parameter is optional. You can specify wildcard characters. The default is to display paths for all destinations.

SRCType

Specifies the type of the source. This parameter is optional. The default is to display paths for all source types. Possible values are:

ANY

Specifies to display paths with any source type.

DATAMover

Specifies to only display paths with the DATAMOVER source type.

SERVer

Specifies to only display paths with the SERVER source type. (A source that has a source type of SERVER is a storage agent.)

DESTType

Specifies the type of the destination. This parameter is optional. The default is to display paths for all destination types. Possible values are:

ANY

Specifies to display paths with any destination type.

DRive

Specifies to display only paths with the DRIVE destination type. When the destination type is a drive, you must specify the library name. You can refine which paths are displayed by entering a name in the LIBRARY parameter.

LIBRARY

Specifies that only paths with destination type LIBRARY display.

LIBRARY

Specifies the name of the library to which the drive belongs. This parameter is required when the destination type is a drive (DESTTYPE=DRIVE).

Format

Specifies how the information is displayed. This parameter is optional. The default is STANDARD. Possible values are:

Standard

Specifies that partial information is displayed.

Detailed

Specifies that complete information is displayed.

## Example: Display summary path information

---

Display information about paths for the source NETAPP1. See Field descriptions for field descriptions.

```
query path netapp1
```

Source Name	Source Type	Destination Name	Destination Type	Online
NETAPP1	DATAMOVER	DRIVE1	DRIVE	Yes
NETAPP1	DATAMOVER	NASLIB	LIBRARY	Yes

## Example: Display detailed path information

---

Display detailed information about paths for the source NETAPP1. See Field descriptions for field descriptions.

```
query path netapp1 format=detailed
```

Linux

```
Source Name: NETAPP1
Source Type: DATAMOVER
Destination Name: NASLIB
Destination Type: LIBRARY
Library:
Device: /dev/tmsmcsi/mc0
Directory:
On-Line: Yes
Last Update by (administrator): SERVER_CONSOLE
Last Update Date/Time: 06/21/2002 20:52:56
```

```

        Source Name: NETAPP1
        Source Type: DATAMOVER
    Destination Name: DRIVE1
    Destination Type: DRIVE
        Library: NASLIB
        Device: rst01
        Directory:
        On-Line: Yes
    Last Update by (administrator): SERVER_CONSOLE
        Last Update Date/Time: 06/21/2002 20:55:23

```

AIX | Windows

```

        Source Name: NETAPP1
        Source Type: DATAMOVER
    Destination Name: NASLIB
    Destination Type: LIBRARY
        Library:
        Device: mc0
        Directory:
        On-Line: Yes
    Last Update by (administrator): SERVER_CONSOLE
        Last Update Date/Time: 06/21/2001 20:52:56

```

```

        Source Name: NETAPP1
        Source Type: DATAMOVER
    Destination Name: DRIVE1
    Destination Type: DRIVE
        Library: NASLIB
        Device: rst01
        Directory:
        On-Line: Yes
    Last Update by (administrator): SERVER_CONSOLE
        Last Update Date/Time: 06/21/2001 20:55:23

```

AIX | Linux

## Example: Display detailed path information for a z/OS media server

---

Display detailed information about a z/OS® media server path. See Field descriptions for field descriptions.

```
query path format=detailed
```

```

        Source Name: SERVER1
        Source Type: SERVER
    Destination Name: ZOSMEDIA
    Destination Type: LIBRARY
        Library:
        Node Name:
        Device:
    External Manager:
    ZOS Media Server: MEDSERV1
    Comm. Method:
        LUN:
        Initiator: 0
        Directory:
        On-Line: Yes
    Last Update by (administrator): ADMIN
        Last Update Date/Time: 06/08/2011 15:33:39

```

## Field descriptions

---

Source Name

The name of the source.

Destination Name

The name of the destination.

Source Type

The type of the source.

Destination Type

The type of the destination.

Library



The name of the library that contains the drive that is the destination.

This field will be blank if the destination type is library. The library name is in destination name field when the destination is a library.

Node Name

The name of the device that is the destination.

Device

The name of the device that is the destination.

External Manager

The name of the external manager.

ZOS Media Server

The name of the z/OS media server.

Comm. Method

Specifies the type of communication method.

LUN

Specifies the logical unit name through which the disk can be accessed by the source.

Initiator

Specifies the initiator of the communication.

Directory

Specifies the directory location of a file on the source.

On-Line

Whether the path is online and available for use.

Last Update by (administrator)

The ID of the administrator who performed the last update.

Last Update Date/Time

The date and time when the last update occurred.

## Related commands

---

Table 1. Commands related to QUERY PATH

Command	Description
DEFINE PATH	Defines a path from a source to a destination.
DELETE PATH	Deletes a path from a source to a destination.
UPDATE PATH	Changes the attributes associated with a path.

## QUERY POLICYSET (Query a policy set)

---

Use this command to display information about one or more policy sets.

### Privilege class

---

Any administrator can issue this command.

### Syntax

---

```
.-*--*----->
>>-Query Policyset-+-----+----->
|                    .-*-----|
|'-domain_name-----+-----+
|                    '-policy_set_name-'

.-Format----Standard----.
>--+-----+----->>
|'-Format----+Standard-+-'
|                    '-Detailed-'
```

### Parameters

---

domain\_name

Specifies the policy domain associated with the policy set to query. This parameter is optional. You can use wildcard characters to specify names. If you do not specify a value for this parameter, all policy domains are queried. You must specify this parameter when querying an explicitly named policy set.

policy\_set\_name

Specifies the policy set to query. This parameter is optional. You can use wildcard characters to specify names. If you do not specify either ACTIVE or a policy set name, all policy sets are queried.

Format

Specifies how the information is displayed. This parameter is optional. The default value is STANDARD. Possible values are:

Standard

Specifies that partial information is displayed.

Detailed

Specifies that complete information is displayed.

## Example: List policy sets for all policy domains

Query all policy sets for all policy domains. Create the output in standard format. See Field descriptions for field descriptions.

```
query policysset
```

Policy Domain Name	Policy Set Name	Default Mgmt Class Name	Description
EMPLOYEE-RECORDS	ACTIVE	ACTIVEFILES	Personnel Department
EMPLOYEE-RECORDS	HOLIDAY	ACTIVEFILES	Personnel Department
EMPLOYEE-RECORDS	VACATION	ACTIVEFILES	Personnel Department
PROG1	SUMMER		Programming Group Policies
PROG2	SUMMER		Programming Group Policies
STANDARD	ACTIVE	STANDARD	Installed default policy set.
STANDARD	STANDARD	STANDARD	Installed default policy set.

## Example: Displayed detailed information about a specific policy set

Query the VACATION policy set that is in the EMPLOYEE\_RECORDS policy domain. Create the output in detailed format. See Field descriptions for field descriptions.

```
query policysset employee_records vacation
format=detailed
```

```

Policy Domain Name: EMPLOYEE_RECORDS
Policy Set Name: VACATION
Default Mgmt Class Name: ACTIVEFILES
Description: Personnel Department
Last Update by (administrator): $$CONFIG MANAGER$$
Last Update Date/Time: 05/31/1998 13:15:50
Managing profile: ADSM_INFO
Changes Pending: Yes
```

## Field descriptions

Policy Domain Name

The name of the policy domain.

Policy Set Name

The name of the policy set.

Default Mgmt Class Name

The management class assigned as the default for the policy set.

Description

The description of the policy set.

Last Update by (administrator)

The name of the administrator or server that most recently updated the policy set. If this field contains `$$CONFIG_MANAGER$$`, the policy set is associated with a domain that is managed by the configuration manager.

Last Update Date/Time  
The date and time when the policy set was most recently defined or updated.

Managing Profile  
The profile or profiles that manage the domain to which this policy set belongs.

Changes Pending  
Whether or not changes are being made but not activated. Once the changes are activated, the field resets to No.

## Related commands

Table 1. Commands related to QUERY POLICYSET

Command	Description
ACTIVATE POLICYSET	Validates and activates a policy set.
COPY POLICYSET	Creates a copy of a policy set.
DEFINE POLICYSET	Defines a policy set within the specified policy domain.
DELETE POLICYSET	Deletes a policy set, including its management classes and copy groups, from a policy domain.
QUERY DOMAIN	Displays information about policy domains.
UPDATE POLICYSET	Changes the description of a policy set.
VALIDATE POLICYSET	Verifies and reports on conditions the administrator must consider before activating the policy set.

## QUERY PROCESS (Query one or more server processes)

Use this command to display information about active background processes.

To cancel background processes, issue the CANCEL PROCESS command. To display detailed information about node replication processes, issue the QUERY REPLICATION command.

### Privilege class

Any administrator can issue this command.

### Syntax

```
>>-Query PRocess--+-+-----+----->
                    '-process_number-'
>--+-+-----+-----+-----<<
    '-DESCRiption----string-'  '-STATUs----string-'
```

### Parameters

#### process\_number

Specifies the number of the background process to be queried. This parameter is optional. If not specified, information about all background processes is displayed.

#### DESCRiption

Specifies a text string that you want to search for in the list of active processes' descriptions. Enclose the string expression in quotation marks if it contains blanks. You can use text and a wildcard character to specify this string. This parameter is optional.

#### STATUs

Specifies a text string that you want to search for in the list of active processes' statuses. Enclose the string expression in quotation marks if it contains blanks. You can use text and a wildcard character to specify this string. This parameter is optional.

## Example: Query a single background process

---

Display information about background process 202. See Field descriptions for field descriptions.

```
query process 202
```

Process Number	Process Description	Process Status
202	EXPORT SERVER	ANRONNNI EXPORT Identifier MYEXPORTSERVER ANR0648I Have copied the following: 8 Domains 2 Policy Sets 10 Management Classes 4 Copy Groups 1 Administrators 746 Bytes (0 errors have been detected) Current input volume(s): C:\BUILD\540\GA\BUILD\NT\I386\DEBUG\ -00000014.BFS, (6 Seconds)

## Example: Query all background processes

---

Display information about all background processes. See Field descriptions for field descriptions.

```
query process
```

Process Number	Process Description	Process Status
304	IDENTIFY DUPLICATES	Storage Pool FILEPOOL, Volume /tspmool2/00006664. BFS, Files Processed: 2000, Duplicate Extents Found: 344, Duplicate Bytes Found: 3,238,123, Current Physical File (bytes): 2,626,676,296. Status: Processing
284	IDENTIFY DUPLICATES	Storage Pool FILEPOOL, Volume /tspmool2/00006666. BFS, Files Processed: 2000, Duplicate Extents Found: 344, Duplicate Bytes Found: 3,238,123, Current Physical File (bytes): None. Status: Idle
4	Replicate Node	Replicating Node(s) IRONMAN. File spaces complete: 0. File spaces identifying and replicating: 1. File spaces replicating: 0. File spaces not started: 3. Files current: 11,920. Files replicated: 0 of 0. Files updated: 0 of 0. Files deleted: 0 of 0. Amount Replicated: 11,482 KB of 11,482 KB. Amount transferred: 11,482 KB. Elapsed time: 0 Day(s), 0 Hour(s), 1 Minute(s).
37	Expiration	Processed 12 nodes out of 30 total nodes, examined 411 objects, deleting 411 backup objects, 0 archive objects, 0 DB backup volumes, 0 recovery plan files;

0 objects have been retried and  
0 errors encountered.

## Example: Query all background replication processes

---

Display information about all background replication processes. See Field descriptions for field descriptions.

```
query process desc="replicate node"
```

Process Number	Process Description	Process Status
4	Replicate Node	Replicating Node(s) IRONMAN. File spaces complete: 0. File spaces identifying and replicating: 1. File spaces replicating: 0. File spaces not started: 3. Files current: 11,920. Files replicated: 0 of 0. Files updated: 0 of 0. Files deleted: 0 of 0. Amount Replicated: 11,482 KB of 11,482 KB. Amount transferred: 11,482 KB. Elapsed time: 0 Day(s), 0 Hour(s), 1 Minute(s).

## Example: Query all background replication processes for a specific node

---

Display information about all background replication processes. See Field descriptions for field descriptions.

```
query process desc="replicate node" status=ironman
```

Process Number	Process Description	Process Status
4	Replicate Node	Replicating Node(s) IRONMAN. File spaces complete: 0. File spaces identifying and replicating: 1. File spaces replicating: 0. File spaces not started: 3. Files current: 11,920. Files replicated: 0 of 0. Files updated: 0 of 0. Files deleted: 0 of 0. Amount Replicated: 11,482 KB of 11,482 KB. Amount transferred: 11,482 KB. Elapsed time: 0 Day(s), 0 Hour(s), 1 Minute(s).

## Example: Verify that a replication recovery process was initiated

---

After you start a node replication process with file recovery enabled, verify that the target replication server initiated the file recovery process. Issue the QUERY PROCESS command on the target replication server. For descriptions of fields, see Field descriptions.

```
query process
```

Process Number	Process Description	Process Status
4	Replicate Node - Recovery.	Replicating node(s) 3MAUTOIMPORT. File spaces complete: 87. File spaces identifying and replicating: 0. File spaces replicating: 6. File spaces not started: 0. Files current: 0. Files replicated: 0 of 14. Files updated: 0 of 0. Files deleted: 0 of 0. Amount replicated: 0 KB of 11,688 bytes.

Amount transferred: 0 KB.  
 Elapsed time:  
 0 Day(s), 0 Hour(s), 1 Minute(s).

## Example: Verify that damaged files are being recovered during a replication process

After you start a node replication process with file recovery enabled, verify that damaged files are being recovered. Issue the QUERY PROCESS command on the source replication server. For descriptions of fields, see Field descriptions.

query process

Process Number	Process Description	Process Status
6	Replicate Node (As Secondary Recovery)	Recovering damaged files from server SERVER2, process 4, number of active sessions 10.

AIX Linux Windows

## Example: Verify that the files are being converted

After you start a storage pool conversion process, verify that the files are being converted. For descriptions of fields, see Field descriptions.

query process

Process Number	Process Description	Process Status
6	Convert Stgpool	Converting storage pool FILEPOOL1 to directory-container storage pool NEWDEDUP1. Volumes Converted: 1 of 6, Volumes Failed: 0, Converted Files: 975, Converted Bytes: 196.27 MB, Skipped Files: 0, Skipped Bytes: 0 B, Total Bytes Transferred: 151.27 MB
7	Convert Stgpool	Converting storage pool DEDUPPOOL to directory-container storage pool DIRPOOL. Converted Files: 150 of 360, Converted Bytes: 79,598 KB of 388 MB. Unconverted Files: 12. Unconverted Bytes: 27 MB. Current input volume: /fvt/srv/BK01. Elapsed time: 0 Day(s), 0 Hour(s), 1 Minute(s).
8	Convert Stgpool	Converting storage pool FILEPOOL1 to directory-container storage pool NEWDEDUP1. Converted Files: 0, Converted Bytes: 0 B of 1.00 GB, Skipped Files: 0, Skipped Bytes: 0 B, Total Bytes Transferred: 0 B, Current input volume: /STORAGE/file1/00000005.BFS, Elapsed time: 0 Days, 0 Hours, 1 Minutes.
10	Convert Stgpool	Converting storage pool FILEPOOL1 to directory-container storage pool NEWDEDUP1. Converted Files: 1007, Converted Bytes: 285.44 MB of 1.33 GB, Skipped Files: 0, Skipped Bytes: 0 B, Total Bytes Transferred: 196.28 MB, Current input volume: /STORAGE/file1/00000004.BFS, Elapsed time: 0 Days, 0 Hours, 1 Minutes.

AIX Linux Windows

## Example: Verify movement from local disk to the cloud

After the data-transfer operation from the local disk to the cloud starts, verify that the data is moving. For descriptions of fields, see Field descriptions.

```
query process
```

Process Number	Process Description	Process Status
4	Local to Cloud Transfer	Local disk to cloud transfer for directory-container storage pool CLOUDPOOL. 1 container(s) processed. 2,100 KB in 4 data extent(s) transferred. Elapsed time: 0 Day(s), 0 Hour(s), 1 Minute(s).

## Field descriptions

Process Number

Specifies the number that is assigned to the active background process.

Process Description

Specifies a description of the active background process.

Process Status

Specifies the status of the active background process.

Tip: When a node replication process is finished on the target replication server, only end process information is stored in the activity summary table. The full summary for the replication process is stored in the activity summary table on the source replication server.

## Related commands

Table 1. Command related to QUERY PROCESS

Command	Description
CANCEL EXPORT	Deletes a suspended export operation.
CANCEL PROCESS	Cancel a background server process.
IDENTIFY DUPLICATES	Identifies duplicate data in a storage pool.
QUERY EXPORT	Displays the export operations that are currently running or suspended.
QUERY REPLICATION	Displays information about node replication processes.
QUERY REPLNODE	Displays information about the replication status of a client node.
RESTART EXPORT	Restarts a suspended export operation.
SUSPEND EXPORT	Suspends a running export operation.

## QUERY PROFILE (Query a profile)

Use this command to display information about profiles and associated objects. Issue this command from a configuration manager or from a managed server. You can use this command to get profile information from any configuration manager defined to the server, even if the server does not subscribe to any profile.

If you query a locked profile from the configuration manager to which the profile belongs, complete profile information is displayed. If you query a locked profile from another server, the query displays only that the profile is locked.

## Privilege class

Any administrator can issue this command.

## Syntax

```
.*-----
>>-Query PROFIle--+----->
                    '-profile_name-'

>--+----->
|                               (1) |
'-SERVer----server_name-----'

.-Format----Standard----.  .-USELocal----Yes----.
>--+-----+-----><
'-Format----+Standard+-'  '-USELocal----+Yes-+-'
                    '-Detailed-'                '-No--'
```

### Notes:

1. The server name you specify depends on the server from which you issue the command. See the description of the SERVER parameter.

## Parameters

### profile\_name

Specifies the profile to display. To specify multiple names, use a wildcard character. This parameter is optional. The default is to display all profiles.

### SERVer

Specifies the configuration manager whose profile information is displayed. The requirements for the name depends on where the query is issued:

- From a configuration manager: This parameter is optional. The default is the configuration manager's name.
- From a managed server: This parameter is optional. The default is the name of the configuration manager for this managed server.
- From a server that is neither a configuration manager nor a managed server: You must specify a name.

### Format

Specifies whether partial or detailed information is displayed. The default is STANDARD. Possible values are:

#### Standard

Specifies that partial information is displayed.

#### Detailed

Specifies that detailed information is displayed.

### USELocal

When you perform the query from a managed server, this parameter specifies whether the profile information is obtained from the configuration manager or the managed server. If the profile information does not exist on the managed server, the information is obtained from the configuration manager, regardless of the value of this parameter.

If you use this parameter on a server that is not managed by the configuration manager that owns the profile, the parameter is ignored. The default value is YES. Possible values are:

#### Yes

Specifies that the profile information, if available, is obtained from the managed server. The configuration manager is contacted if information is not available from the managed server.

#### No

Specifies that the profile information is obtained from the configuration manager even if the information is available from the managed server. This ensures that you receive current information about the profile.

## Example: List profiles from a configuration manager

Display profile information from a configuration manager. See Field descriptions for field descriptions.

```
query profile
```

```
Configuration      Profile name      Locked?
manager
```



SERVER	PROFILE	LOCKED
SERVER1	DEFAULT_PROFILE	No
SERVER1	ADMIN_INFO	No
SERVER1	EMPLOYEE	No
SERVER1	PERSONNEL	Yes

## Example: Display detailed profile information for a managed server

From a managed server, display current detailed information for profile ADMIN\_INFO. See Field descriptions for field descriptions. Note: When the profile is locked, most fields are not displayed.

```
query profile admin_info
format=detailed uselocal=no
```

```
Configuration manager: SERVER1
Profile name: ADMIN_INFO
Locked: No
Description: Distributed administrative schedules
Server administrators: DENNIS EMILY ANDREA
Policy domains: ADMIN RECORDS
Administrative command schedules: ** all objects **
Server Command Scripts:
Client Option Sets:
Servers:
Server Groups:
```

## Field descriptions

### Configuration manager

The name of the configuration manager that owns the profile.

### Profile name

The name of the profile.

### Locked?

Whether the profile is locked.

### Description

The description of the profile.

### Server administrators

The administrators that are associated with the profile.

### Policy domains

The policy domains that are associated with the profile.

### Administrative command schedules

The administrative schedules that are associated with the profile.

### Server Command Scripts

The server command scripts that are associated with the profile.

### Client Option Sets

The client option sets that are associated with the profile.

### Servers

The servers that are associated with the profile.

### Server Groups

The names of server groups that are associated with the profile.

## Related commands

Table 1. Commands related to QUERY PROFILE

Command	Description
COPY PROFILE	Creates a copy of a profile.
DEFINE PROFASSOCIATION	Associates objects with a profile.
DEFINE PROFILE	Defines a profile for distributing information to managed servers.
DEFINE SUBSCRIPTION	Subscribes a managed server to a profile.
DELETE PROFASSOCIATION	Deletes the association of an object with a profile.

Command	Description
DELETE PROFILE	Deletes a profile from a configuration manager.
LOCK PROFILE	Prevents distribution of a configuration profile.
SET CONFIGMANAGER	Specifies whether a server is a configuration manager.
UNLOCK PROFILE	Enables a locked profile to be distributed to managed servers.
UPDATE PROFILE	Changes the description of a profile.

## QUERY PROTECTSTATUS (Query the status of storage pool protection)

Use this command to display information about the status of storage pool protection for directory-container storage pools.

### Privilege class

Any administrator can issue this command.

### Syntax

```

.*-----
>>-Query PROTECTStatus--+----->
                          '-pool_name-'

.-Format---Standard----.
>--+-----+----->>
  '-Format---+Standard+-'
                          '-Detailed-'

```

### Parameters

#### pool\_name

Specifies the name of the directory-container storage pool to be queried. This parameter is optional. You can use wildcard characters to specify this name. If you do not specify a value, the status of all directory-container storage pools is displayed.

#### Format

Specifies how the information is displayed. This parameter is optional. The default value is STANDARD. Specify one of the following values:

#### Standard

Specifies that partial information is displayed.

#### Detailed

Specifies that complete information is displayed.

### Example: Display summary information about a specific storage pool

Display information about the storage pool that is named POOL1. Issue the following command:

```
query protectstatus pool1
```

Source Server Name	Source Storage Pool	Target Server Name	Target Storage Pool	Pct. Protected	Last Complete Protect
NEXT	POOL1	NEXT	POOL1COPY	96.55	02/17/2017 11:15:07
NEXT	POOL1	NEXT1	POOL2	99.99	02/17/2017 11:14:53
NEXT	POOL1	UNKNOWN	UNKNOWN	UNKNOWN	02/17/2017 11:13:44
NEXT1	POOL2	NEXT	POOL1	100.00	02/17/2017 12:56:58

See Field descriptions for field descriptions.

### Example: Display detailed information about a specific storage pool

Display information in full detail about the storage pool named, POOL1. Issue the following command:

```
query protectstatus pool1 format=detailed
```

```
    Source Server Name: NEXT
    Source Storage Pool: POOL1
    Target Server Name: NEXT
    Target Storage Pool: POOL1COPY
      Pct. Protected: 96.55
Data Extents Protected: 1,747
  Data Extents Total: 1,852
    Protected (MB): 165.33
      Total (MB): 171.23
Last Completed Protection: 02/17/2017 11:15:07
  Last Refresh Date/Time: 02/19/2017 00:27:12
```

See Field descriptions for field descriptions.

## Field descriptions

---

### Source Server Name

The name of the source server.

### Source Storage Pool

The name of the directory-container storage pool on the source server.

### Target Server Name

The name of the target server.

### Target Storage Pool

The name of the directory-container storage pool on the target server.

### Pct. Protected

The percentage of protected data in the directory-container storage pool.

### Data Extents Protected

The number of data extents that are protected in the directory-container storage pool.

### Data Extents Total

The total number of data extents in the directory-container storage pool.

### Protected (MB)

The total amount of protected data that is in the directory-container storage pool, in megabytes.

### Total (MB)

The total amount of data that is in the directory-container storage pool, in megabytes.

### Last Completed Protection

The date and time that the directory-container storage pool was last protected.

### Last Refresh Date/Time

The date and time that the directory-container storage pool was last refreshed.

## Related commands

---

Table 1. Commands related to QUERY PROTECTSTATUS

Command	Description
PROTECT STGPOOL	Protects a directory-container storage pool.

## QUERY PROXYNODE (Query proxy authority for a client node)

---

Use this command to display client nodes with authority to act as proxy to other client nodes in the IBM Spectrum Protect™ server.

### Privilege class

---

Any administrator can issue this command.

### Syntax

---

```
>>-Query PROXynode----Target-----+-----><
```

'-target\_node\_name-'

## Parameters

---

### Target

Specifies the name of the node targeted by the node with proxy authority. It is optional to specify a target node name. Wildcard names can be used to specify the target node name. A comma-separated list of node names is also allowed.

## Example: List client nodes with proxy authority

---

To display all IBM Spectrum Protect client nodes with proxy authority to the target node named MYCLUSTER, issue the following command.

```
query proxynode target=mycluster
```

Target Node	Agent Node
-----	-----
FRED	MOE MINIE MICKEY
ALPHA	BETA GAMMA DELTA

## Field descriptions

---

### Target Node

Specifies the name of the node targeted by the node with proxy authority.

### Agent Node

Specifies the name of the agent node.

## Related commands

---

Table 1. Commands related to QUERY PROXYNODE

Command	Description
GRANT PROXYNODE	Grant proxy authority to an agent node.
REVOKE PROXYNODE	Revoke proxy authority from an agent node.

## QUERY PVUESTIMATE (Display processor value unit estimate)

---

Use this command to obtain an estimate of the client devices and server devices that are being managed by the IBM Spectrum Protect™ server. In addition, this command provides an estimate of the processor value unit (PVU) totals for the server devices.

This command generates a PVU estimate that is based on the number of logical nodes that are defined to the IBM Spectrum Protect server. By contrast, the calculation of license obligations is based on the number of physical computers. There might not be a one-to-one correlation between the number of logical nodes and the number of physical computers. The report that is generated by the QUERY PVUESTIMATE command is an estimate, which is not legally binding.

For purposes of the QUERY PVUESTIMATE command, nodes on Microsoft Windows 7, Microsoft Windows XP Professional, and Apple systems are assumed to be client devices. Nodes on all other platforms are considered to be server devices. The server on which IBM Spectrum Protect is running is also classified as a server device. However, you can reclassify server devices as client devices if required. If your system includes retired workstations, test workstations, or others that can be ignored for purposes of PVU calculation, you can specify them as type other. To change a node classification, use the UPDATE NODE command or the REGISTER NODE command.

Note: The PVU information reported by IBM Spectrum Protect is not considered an acceptable substitute for the IBM® License Metric Tool.

## Privilege class

---

Any administrator can issue this command.

## Syntax

---

```

>>-Query PVUESTIMATE-----><
      .-Format---Standard-----
      '-Format---Standard-+-'
      '-Detailed-'

```

## Parameters

### Format

Specifies the output format. This parameter is optional. The default is Standard. The following values can be used:

#### Standard

Specifies standard output.

#### Detailed

Specifies detailed output.

## Example: Display the estimated number of devices and PVU

Display the estimated number of client devices and server devices, and the estimated PVU for the server devices, for an IBM Spectrum Protect server. Issue the following command:

```
query pvestimate
```

Table 1. Sample output for several products managed by one IBM Spectrum Protect server

Product	Number of Client Devices	Number of Server Devices	PVU of Server Devices
IBM Spectrum Protect Extended Edition	1,000	905	90,500
IBM Spectrum Protect for Storage Area Networks	50	10	1,000
IBM Spectrum Protect for Space Management	0	0	0
IBM Spectrum Protect for Mail	0	25	5,000
IBM Spectrum Protect for Databases	0	1,025	20,500
IBM Spectrum Protect for Enterprise Resource Planning	0	25	5,000
IBM Spectrum Protect for System Backup and Recovery	0	0	0
Other Node Classifications	Number		
Nodes earlier than Version 6.3 with no PVU information available at this time	10		
Nodes at Version 6.3 or later with no PVU match	9		
Nodes classified by the administrator as "other-device"	8		
Nodes defined as a non-licensed API application	6		

The following list provides details about the example fields:

### Product

The IBM Spectrum Protect product name.

### Number of Client Devices

The estimated number of client devices that are managed by the product. By default, only nodes on Microsoft Windows 7, Microsoft Windows XP Professional, and Apple systems are assumed to be client devices.

### Number of Server Devices

The estimated number of server devices that are managed by the product. By default, nodes on all platforms except for Microsoft Windows 7, Microsoft Windows XP Professional, and Apple systems are assumed to be server devices. This number also includes the server on which IBM Spectrum Protect is running.

### PVU of Server Devices

The estimated PVUs of all nodes that are connected as server devices.

### Nodes earlier than Version 6.3 with no PVU information available at this time

Devices that do not report processor information to the server.

### Nodes at Version 6.3 or later with no PVU match

Devices that do not report all required values or some values were reported as "Unknown".  
 Nodes classified by the administrator as "other-device"  
 Nodes that are excluded from PVU counting by the administrator by using the update node roleoverride=other command.  
 Nodes defined as a non-licensed API application  
 Nodes such as DB2® backup or custom API applications.

## Example: Display detailed node information

Display information for individual nodes by specifying the detailed (d) value for the Format parameter. Issue the following command:

```
tsm: PATMOS_630> query pvestimate f=d
```

Table 2. Node classifications for specific products

Product	Number of Client Devices	Number of Server Devices	PVU of Server Devices
IBM Spectrum Protect Extended Edition	1,000	905	90,500
- banode1	1		
- banode2		1	200
- banode3	1		
- banode3		1	100
IBM Spectrum Protect for Storage Area Networks	50	10	1,000
- stagent1		1	50
- stagent2		1	100
IBM Spectrum Protect for Space Management	0	0	0
IBM Spectrum Protect for Mail	0	25	5,000
- mailnode1		1	200
- mailnode2		1	100
IBM Spectrum Protect for Databases	0	1,025	20,500
- dbnode1		1	200
- dbnode2		1	100
IBM Spectrum Protect for Enterprise Resource Planning	0	25	5,000
- erpnode1		1	50
- erpnode2		1	100
IBM Spectrum Protect for System Backup and Recovery	0	0	0
<b>Other Node Classifications</b>	<b>Number</b>		
Nodes earlier than Version 6.3 with no PVU information available at this time	10		
- oldnode1	1		
- oldnode2	1		
- mailnote44	1		

Other Node Classifications	Number
- erpnode66	1
Nodes at Version 6.3 or later with no PVU match	10
- badcitnode1	1
- badcitnode2	1
- mailnode23	1
- erpnode34	1
Nodes classified by administrator as "other-device"	8
- overriddennode1	1
- overriddennode2	1
- mailnode77	
Nodes defined as a non-licensed API application	6
- vendorapinode1	1
- vendorapinode2	1

## Related commands

Table 3. Commands related to QUERY PVUESTIMATE

Command	Description
AUDIT LICENSES	Verifies compliance with defined licenses.
QUERY LICENSE	Displays information about licenses and audits.
QUERY NODE	Displays partial or complete information about one or more clients.
REGISTER LICENSE	Registers a license with the IBM Spectrum Protect server.
REGISTER NODE	Defines a client node to the server and sets options for that user.
SET CPUINFOREFRESH	Specifies the number of days between client scans for workstation information used for PVU estimates.
SET LICENSEAUDITPERIOD	Specifies the number of days between automatic license audits.
UPDATE NODE	Changes the attributes that are associated with a client node.

## QUERY RECOVERYMEDIA (Query recovery media)

Use this command to display information about the media (for example, boot media) needed to recover a machine. Media are displayed in alphabetical order by name.

Remember: IBM Spectrum Protect™ does not use the information. It is available only to help you plan for the disaster recovery of client machines.

## Privilege class

Any administrator can issue this command.

## Syntax

---

```
.-*-----.  
>>-Query RECOVERYMedia--+----->  
      '-media_name-'  
  
>--+----->  
      '-Type-----+B0ot--+-'  '-L0cation-----location-'  
      '-OTher-'  
  
.-Format-----Standard-----.  
>--+-----><  
      '-Format-----+Standard+-'  
      '-Detailed-'
```

## Parameters

---

### media\_name

Specifies the name of the recovery media. You can use wildcard characters to specify the name. This parameter is optional. The default is all recovery media.

### Type

Specifies the type of media to be queried. This parameter is optional. If this parameter is not specified, all recovery media are queried. Possible values are:

#### B0ot

Only boot media are queried.

#### OTher

All media other than boot media are queried.

### L0cation

Specifies the location of the recovery media to be queried. This parameter is optional. You can specify up to 255 characters. Enclose the description in quotation marks if it contains any blank characters.

### Format

Specifies how the information is displayed. This parameter is optional. Possible values are:

#### Standard

Displays partial information. This is the default.

#### Detailed

Displays all information.

## Example: Display summary information for a specific recovery media

---

Display information for the recovery media named RECMED1. See Field descriptions for field descriptions.

```
query recoverymedia RECMED1
```

Recovery Media Name	Volume Names	Location	Machine Name
-----	-----	-----	-----
RECMED1	vol1 vol2 vol3 vol4	IRONMOUNTAIN	MACH1

## Example: Display detailed information for a specific recovery media

---

Display detailed information for the recovery media named RECMED1. See Field descriptions for field descriptions.

```
query recoverymedia RECMED1 format=detailed
```

```
Recovery Media Name: RECMED1  
      Type: Boot  
      Volume Names: vol1 vol2 vol3 vol4  
      Location: IRONMOUNTAIN  
      Description:  
      Product:  
Product Information:  
      Machine Name: MACH1
```



## Field descriptions

---

### Recovery Media Name

The name of the recovery media.

### Type

Whether the recovery media are boot media or another type of media. Possible values are:

#### Boot

The recovery media are boot media.

#### Other

The recovery media are not boot media.

### Volume Names

The set of volumes that contain the data needed to recover machines associated with this media.

### Location

Where the recovery media is stored.

### Description

A description of the recovery media.

### Product

The product used to create the boot media.

### Product Information

Information about the product that created the boot media. This information may be needed for restoring the machine.

### Machine Name

The machines that are associated with this recovery media.

## Related commands

---

Table 1. Commands related to QUERY RECOVERYMEDIA

Command	Description
DEFINE RECMEDMACHASSOCIATION	Associates recovery media with a machine.
DEFINE RECOVERYMEDIA	Defines the media required to recover a machine.
DELETE RECOVERYMEDIA	Deletes recovery media.
UPDATE RECOVERYMEDIA	Changes the attributes of recovery media.

## QUERY REPLICATION (Query node replication processes)

---

Use this command to display information about running and ended node-replication processes.

Issue this command on the server that acts as a source for replicated data.

**Important:** You cannot display information about running replication processes for client nodes that are being converted from import and export operations to replication operations. The conversion process might run for a long time, but it occurs only once for a client node that is being converted.

By default, records about completed node-replication processes are retained for 30 calendar days. A *calendar day* consists of 24-hours, from midnight to midnight.

To display the retention period, issue the QUERY STATUS command. Check the value in the Replication Record Retention Period field. To change the retention period, issue the SET REPLRETENTION command.

## Privilege class

---

Any administrator can issue this command.

## Syntax

---

```
>>-Query REPLIcation--node_name----->
      .*-----.
```

```

>----->
| (1) |
|-----+---+file_space_name+---+|
| | |
| | |
| | |
| (2) |
|-----+---+|
|-----+---+|

.-NAMEType---SERVER-----
>----->
|-----+---+SERVER---+|
| | |
| | |
| | |
|-----+---+|

.-CODEType---BOTH-----
>----->
|-----+---+BOTH---+|
| | |
| | |
|-----+---+|

.-DISplay---1-----
>----->
|-----+---+number_of_days-|

>----->
|-----+---+process_identifier-|

.-Status---All----- .-Format---Standard-----
>----->
|-----+---+All---+| |-----+---+Standard+---+|
| | | |
| | | |
| | | |
|-----+---+| |-----+---+|
|-----+---+| |-----+---+|
|-----+---+| |-----+---+|
|-----+---+| |-----+---+|

```

Notes:

1. Do not mix FSIDs (file space identifiers) and file space names in the same command.
2. Do not specify FSID if you use wildcard characters for the client node name.

## Parameters

### node\_name (Required)

Specifies the name of the client node to be queried. You can use wildcard characters when you specify this name, with one exception. If the value of the NAMETYPE parameter is FSID, do not specify wildcard characters for the client node name. The FSID value indicates the file space identifier. File spaces with identical names can have different identifiers in different client nodes.

### file\_space\_name or FSID

Specifies the name of the file space or the file space identifier (FSID) to be queried. A name or FSID is optional. If you do not specify a name or an FSID, all file spaces are queried.

#### file\_space\_name

Specifies the name of the file space that has data to be queried. File space names are case-sensitive. To determine the correct capitalization for the file space, issue the QUERY FILESPACE command. Separate multiple names with commas with no intervening spaces. When you specify a name, you can use wildcard characters.

A server that has clients with Unicode-enabled file spaces might have to convert the file space name. For example, the server might have to convert a name from the server code page to Unicode. For details, see the NAMETYPE parameter. If you do not specify a file space name, or if you specify only a single wildcard character for the name, you can use the CODETYPE parameter to limit the operation to Unicode file spaces or to non-Unicode file spaces.

#### FSID

Specifies the file space identifier for the file space to be queried. The server uses FSIDs to find the file spaces to replicate. To determine the FSID for a file space, issue the QUERY FILESPACE command. Separate multiple FSIDs with commas with no intervening spaces. If you specify an FSID, the value of the NAMETYPE parameter must be FSID.

## NAMEType

Specifies how you want the server to interpret the file space names that you enter. You can use this parameter for IBM Spectrum Protect™ clients that are Unicode-enabled and that have Windows, Macintosh OS X, or NetWare operating systems.

Use this parameter only if you enter a partly qualified or fully qualified file space name. The default value is SERVER. You can specify one of the following values:

### SERVER

The server uses the server code page to interpret file space names.

### UNICODE

The server converts file space names from the server code page to the UTF-8 code page. The success of the conversion depends on the characters in the name and the server code page. Conversion can fail if the string includes characters that are not available in the server code page. Conversion can also fail if the server cannot access system conversion routines.

### FSID

The server interprets file space names by using their file space identifiers.

## CODEType

Specifies the type of file spaces to be included in the query. The default value is BOTH, which means that file spaces are included regardless of code page type. Use this parameter only if you enter a single wildcard character for the file space name. You can specify one of the following values:

### UNICODE

Include file spaces that are in Unicode only.

### NONUNICODE

Include file spaces that are not in Unicode only.

### BOTH

Include all file spaces regardless of code page type.

## DISplay

Specifies the number of days of node replication history to display. The default value is 1, which displays information about running node replication processes and about processes that completed during the current calendar day. The maximum value is 9999.

You can specify a number that is the same as or less than the number of days that are specified as the retention period for the replication history records. If you specify a value that is more than the value of the replication retention period or more than the number of days that replication records are collected, the server displays only the number of replication history records that are available. For example, suppose that the replication retention period is 30 days and that the replication process is running for only 10 days. If you specify `DISPLAY=20`, only 10 days of replication history are displayed.

## PROcessid

Specifies the node replication history that is associated with a particular process identified by the process identifier. This parameter is optional. If you do not specify this parameter, all processes are displayed for the number of days that are specified by the DISPLAY parameter.

Restarting the server can cause the server to reuse process IDs. Reuse of process IDs can result in duplicate process IDs for separate processes.

## STatus

Specifies the status of the file spaces to query. This parameter is optional. The default value is ALL. You can specify one of the following values:

### ALL

Specifies all file spaces that are replicating, file spaces that replicated successfully, and file spaces that did not finish replicating or replicated with errors.

### RUNning

Specifies all file spaces that are replicating to the target replication server.

### ENded

Specifies all file spaces that replicated successfully and file spaces that did not finish replicating or replicated with errors.

### FAiled

Specifies all file spaces that did not finish replicating or replicated with errors.

#### Format

Specifies how the information is displayed. This parameter is optional. The default value is STANDARD. You can specify one of the following values:

#### Standard

Specifies that partial information is displayed for node replication processes.

#### Detailed

Specifies that all available information for the node replication processes is displayed.

## Example: Display information about replication processes for a file space

---

Display information about replication processes for a file space in client node PAYROLL. The file space identifier is 10.

```
query replication ironman
```

NodeName	Filespace Name	FSID	Start Time	End Time	Status	Phase
IRONMAN	/space	2	02/08/11 21:44:19	02/08/11 21:48:14	Ended	None

```
query replication ironman format=detailed
```

```
Node Name: IRONMAN
Filespace Name: /space
FSID: 2
Start Time: 02/08/11 21:44:19
End Time: 02/08/11 21:48:14
Status: Ended
Process Number: 4
Command: replicate node ironman
Phase: None
Process Running Time: 0 Day(s) 0 Hour(s)
4 Minute(s)
Completion State: Complete
Reason For Incompletion: None
Backup Last Update Date/Time:
Backup Target Server:
Backup Files Needing No Action: 0
Backup Files To Replicate: 0
Backup Files Replicated: 0
Backup Files Not Replicated Due to Errors: 0
Backup Files Not Yet Replicated: 0
Backup Files To Delete: 0
Backup Files Deleted: 0
Backup Files Not Deleted Due To Errors: 0
Backup Files To Update: 0
Backup Files Updated: 0
Backup Files Not Updated Due To Errors: 0
Backup Bytes To Replicate (MB): 0
Backup Bytes Replicated (MB): 0
Backup Bytes Transferred (MB): 0
Backup Bytes Not Replicated Due
To Errors (MB): 0
Backup Bytes Not Yet Replicated (MB): 0

Archive Last Update Date/Time: 02/08/11 21:48:14
Archive Target Server: NIGLINA
Archive Files Needing No Action: 0
Archive Files To Replicate: 39,416
Archive Files Replicated: 39,206
Archive Files Not Replicated Due to Errors: 210
Archive Files Not Yet Replicated: 0
Archive Files To Delete: 0
Archive Files Deleted: 0
Archive Files Not Deleted Due To Errors: 0
Archive Files To Update: 0
Archive Files Updated: 0
```

```

Archive Files Not Updated Due To Errors: 0
  Archive Bytes To Replicate (MB): 4,335
  Archive Bytes Replicated (MB): 4,335
  Archive Bytes Transferred (MB): 0
  Archive Bytes Not Replicated
    Due To Errors (MB): 0
Archive Bytes Not Yet Replicated (MB): 0

  Space Managed Last Update Date/Time:
  Space Management Target Server:
Space Managed Files Needing No Action: 0
  Space Managed Files To Replicate: 0
  Space Managed Files Replicated: 0
  Space Managed Files Not Replicated
    Due to Errors: 0
Space Managed Files Not Yet Replicated: 0
  Space Managed Files To Delete: 0
  Space Managed Files Deleted: 0
  Space Managed Files Not Deleted
    Due To Errors: 0
  Space Managed Files To Update: 0
  Space Managed Files Updated: 0
  Space Managed Files Not Updated
    Due To Errors: 0
Space Managed Bytes To Replicate (MB): 0
  Space Managed Bytes Replicated (MB): 0
  Space Managed Bytes Transferred (MB): 0
  Space Managed Bytes Not Replicated
    Due To Errors (MB): 0
Space Managed Bytes Not Yet Replicated (MB): 0
  Total Files Needing No Action: 0
  Total Files To Replicate: 39,416
  Total Files Replicated: 39,206
Total Files Not Replicated Due To Errors: 210
  Total Files Not Yet Replicated: 0
  Total Files To Delete: 0
  Total Files Deleted: 0
Total Files Not Deleted Due To Errors: 0
  Total Files To Update: 0
  Total Files Updated: 0
Total Files Not Updated Due To Errors: 0
  Total Bytes To Replicate (MB): 4,335
  Total Bytes Replicated (MB): 4,335
  Total Bytes Transferred (MB):
  Total Bytes Not Replicated
    Due to Errors (MB):
Total Bytes Not Yet Replicated (MB):
  Estimated Percentage Complete: 100
  Estimated Time Remaining:
  Estimated Time of Completion:

```

## Field descriptions

---

**Node Name**

The name of the client node whose data is displayed.

**Filespace Name**

The name of the client file space whose data is displayed.

**FSID**

The file space identifier.

**Start Time**

The date and time that the node replication process started.

**End Time**

The date and time that the node replication process ended.

**Status**

The status of the node replication process. The following values are possible:

**Running**

The process is active and is either searching for eligible data or sending data to the target replication server.

**Ended**

The process ended or failed.  
Failed  
The process failed.

#### Process Number

The identifier for the node replication process.

The same process number can have different start times. If a replication process starts and the server is restarted, the server begins assigning process numbers that begin with the number 1. Replication processes that start after a server restart can obtain process numbers that are already assigned to other replication processes in the replication history. To identify unique replication processes, use the start time.

#### Command

The command that was issued to start the node replication process.

#### Phase

The phase of a running node-replication process. The following phases are listed in the order in which they occur:

##### Identifying

The node replication process started to identify data to be replicated, but data is not yet being sent to the target replication server.

##### Identifying and replicating

The node replication process is identifying data to be replicated and transferring the data to the target replication server.

##### Replicating

The node replication process identified the data and is transferring files to the target replication server.

##### None

The node replication process is not running.

#### Process Running Time

The running time of the node replication process.

#### Completion State

The state of the node replication process. The following values are possible:

##### Complete

The node replication process completed.

##### Incomplete

The node replication process ended without running to completion. To determine the reason, check the value in the Reason for Incompletion field.

#### Reason for Incompletion

The reason why the node replication process ended without completing. Possible values include *canceled* and *other*. The value *other* can indicate that the server was halted during replication or that the server failed.

#### Backup Last Update Date/Time

The date and time that statistics for backup were last updated. The specified time is the time that the files in the file space were identified for replication or when each batch of files was sent to the target replication server.

#### Archive Last Update Date/Time

The date and time that statistics for archive were last updated. The specified time is the time that the files in the file space were identified for replication or when each batch of files was sent to the target replication server.

#### Space Managed Last Update Date/Time

The date and time that statistics for space-managed files were last updated. The specified time is the time that the files in the file space were identified for replication or when each batch of files was sent to the target replication server.

#### Backup Target Server

The name of the target replication server for backup files.

#### Archive Target Server

The name of the target replication server for archive files.

#### Space Management Target Server

The name of the target replication server for space-managed files.

#### Backup Files Needing No Action

The number of backup files in the file space that did not need to be replicated, updated, or deleted.

#### Archive Files Needing No Action

The number of archive files in the file space that did not need to be replicated, updated, or deleted.

#### Space Managed Files Needing No Action

The number of space-managed files in the file space that did not need to be replicated, updated, or deleted.

#### Backup Files To Replicate

The number of backup files to replicate to the target replication server.

Archive Files To Replicate  
The number of archive files to replicate to the target replication server.

Space Managed Files To Replicate  
The number of space-managed files to replicate to the target replication server.

Backup Files Replicated  
The number of backup files that are replicated to the target replication server.

Archive Files Replicated  
The number of archive files that are replicated to the target replication server.

Space Managed Files Replicated  
The number of space-managed files that are replicated to the target replication server.

Backup Files Not Replicated Due To Errors  
The number of backup files that were not replicated to the target replication server because of errors.

Archive Files Not Replicated Due To Errors  
The number of archive files that were not replicated to the target replication server because of errors.

Space Managed Files Not Replicated Due To Errors  
The number of space-managed files that were not replicated to the target replication server because of errors.

Backup Files Not Yet Replicated  
The number of backup files that are not yet replicated to the target replication server.

Archive Files Not Yet Replicated  
The number of archive files that are not yet replicated to the target replication server.

Space Managed Files Not Yet Replicated  
The number of space-managed files that are not yet replicated to the target replication server.

Backup Files To Delete  
The number of backup files to be deleted on the target replication server.

Archive Files To Delete  
The number of archive files to be deleted on the target replication server.

Space Managed Files To Delete  
The number of space-managed files to be deleted on the target replication server.

Backup Files Deleted  
The number of backup files that are deleted on the target replication server.

Archive Files Deleted  
The number of archive files that are deleted on the target replication server.

Space Managed Files Deleted  
The number of space-managed files that are deleted on the target replication server.

Backup Files Not Deleted Due To Errors  
The number of backup files that were not deleted from the target replication server because of errors.

Archive Files Not Deleted Due To Errors  
The number of archive files that were not deleted from the target replication server because of errors.

Space Managed Files Not Deleted Due To Errors  
The number of space-managed files that were not deleted from the target replication server because of errors.

Backup Files To Update  
The number of backup files to update on the target replication server. If the metadata of a file is changed, the changed fields are sent to the target replication server.

Archive Files To Update  
The number of archive files to update on the target replication server. If the metadata of a file is changed, the changed fields are sent to the target replication server.

Space Managed Files To Update  
The number of space-managed files to update on the target replication server. If the metadata of a file is changed, the changed fields are sent to the target replication server.

Backup Files Updated  
The number of backup files that are updated on the target replication server.

Archive Files Updated  
The number of archive files that are updated on the target replication server.

Space Managed Files Updated  
The number of space-managed files that are updated on the target replication server.

Backup Files Not Updated Due To Errors  
The number of backup files that were not updated on the target replication server because of errors.

Archive Files Not Updated Due To Errors  
The number of archive files that were not updated on the target replication server because of errors.

Space Managed Files Not Updated Due To Errors  
The number of space-managed files that were not updated on the target replication server because of errors.

**Backup Bytes To Replicate (MB)**

The number of backup bytes to replicate to the target replication server.

**Archive Bytes To Replicate (MB)**

The number of archive bytes to replicate to the target replication server.

**Space Managed Bytes To Replicate (MB)**

The number of space-managed bytes to replicate to the target replication server.

**Backup Bytes Replicated (MB)**

The number of backup bytes that are replicated to the target replication server.

If a file was stored in a deduplicated storage pool, the number of bytes in the stored file might be less than the number of bytes in the original file. This field represents the number of physical bytes in the original file.

**Archive Bytes Replicated (MB)**

The number of archive bytes that are replicated to the target replication server.

If a file was stored in a deduplicated storage pool, the number of bytes in the stored file might be less than the number of bytes in the original file. This field represents the number of physical bytes in the original file.

**Space Managed Bytes Replicated (MB)**

The number of space-managed bytes that are replicated to the target replication server.

If a file was stored in a deduplicated storage pool, the number of bytes in the stored file might be less than the number of bytes in the original file. This field represents the number of physical bytes in the original file.

**Backup Bytes Transferred (MB)**

The number of backup bytes that were sent to the target replication server.

The value in this field represents the actual number of file bytes sent to the target replication server. This value is calculated by subtracting the number of bytes not sent because of deduplication from the number of bytes to replicate.

**Archive Bytes Transferred (MB)**

The number of archive bytes that were sent to the target replication server.

The value in this field represents the actual number of file bytes sent to the target replication server. This value is calculated by subtracting the number of bytes not sent because of deduplication from the number of bytes to replicate.

**Space Managed Bytes Transferred (MB)**

The number of space-managed bytes that were sent to the target replication server.

The value in this field represents the actual number of file bytes sent to the target replication server. This value is calculated by subtracting the number of bytes not sent because of deduplication from the number of bytes to replicate.

**Backup Bytes Not Replicated Due to Errors (MB)**

The number of backup bytes that were not replicated to the target replication server because of errors.

**Archive Bytes Not Replicated Due to Errors (MB)**

The number of archive bytes that were not replicated to the target replication server because of errors.

**Space Managed Bytes Not Replicated Due to Errors (MB)**

The number of space-managed bytes that were not replicated to the target replication server because of errors.

**Backup Bytes Not Yet Replicated (MB)**

The number of backup bytes not yet replicated to the target replication server.

**Archive Bytes Not Yet Replicated (MB)**

The number of archive bytes not yet replicated to the target replication server.

**Space Managed Bytes Not Yet Replicated (MB)**

The number of space-managed bytes not yet replicated to the target replication server.

**Total Files Needing No Action**

The total number of files in the file space that did not need to be replicated, updated, or deleted.

**Total Files To Replicate**

The total number of files to replicate to the target replication server.

**Total Files Replicated**

The total number of files that are replicated to the target replication server.

**Total Files Not Replicated Due To Errors**

The total number of files that were not replicated because of errors.

**Total files Not Yet Replicated**

The total number of files that are not yet replicated to the target replication server.

**Total Files To Delete**



The total number of files that were deleted on the target replication server.

**Total Files Deleted**  
The total number of files that are deleted on the target replication server.

**Total Files Not Deleted Due to Errors**  
The total number of backup, archive, and space-managed files that were not deleted on the target replication server because of errors.

**Total Files To Update**  
The total number of files to be updated on the target replication server. When the metadata of a file is changed, the changed fields are sent to the target replication server.

**Total Files Updated**  
The total number of files that are updated on the target replication server.

**Total Files Not Updated Due to Errors**  
The total number of backup, archive, and space-managed files that were not updated on the target replication server because of errors.

**Total Bytes To Replicate (MB)**  
The total number of bytes to replicate to the target replication server.

**Total Bytes Replicated (MB)**  
The total number of bytes that are replicated to the target server.

If a file was stored in a deduplicated storage pool, the number of bytes in the stored file might be less than the number of bytes in the original file. This field represents the number of physical bytes in the original file.

**Total Bytes Transferred (MB)**  
The total number of bytes that were transferred to the target replication server.

For files stored in a deduplicated storage pool, the value in this field includes the number of bytes in the original file before duplicate extents were removed. If duplicate extents were already on the target replication server, the number of bytes in the original file is more than the number of bytes transferred.

**Total Bytes Not Replicated Due to Errors (MB)**  
The total number of bytes that were skipped because the source replication server was unable to transfer them to the target replication server.

**Total Bytes Not Yet Replicated (MB)**  
The total number of bytes not yet transferred to the target replication server.

**Estimated Percentage Complete**  
The estimated completion percentage that is based on the number of bytes.

**Estimated Time Remaining**  
The estimated time that remains before the node replication process is complete.

**Estimated Time Of Completion**  
The estimated time when the node replication process ends.

Table 1. Commands related to QUERY REPLICATION

Command	Description
CANCEL REPLICATION	Cancels node replication processes.
QUERY ACTLOG	Displays messages from the server activity log.
QUERY FILESPACE	Displays information about data in file spaces that belong to a client.
QUERY NODE	Displays partial or complete information about one or more clients.
QUERY PROCESS	Displays information about background processes.
QUERY REPLNODE	Displays information about the replication status of a client node.
QUERY REPLRULE	Displays information about node replication rules.
REPLICATE NODE	Replicates data in file spaces that belong to a client node.
SET REPRETENTION	Specifies the retention period for replication history records.

## QUERY REPLNODE (Display information about replication status for a client node)

---

Use this command to display the number of files that are stored for each replicated file space. Information is displayed about file spaces for every client node that is configured for replication.

A client node is configured for replication if it is enabled or disabled.

### Privilege class

---

Any administrator can issue this command.

### Syntax

---

```
      .- ,----- .
      v |
>>-Query REPLNode-----node_name-----+----->
>--+-----+-----><
      '-target_server_name-'
```

### Parameters

---

node\_name (Required)

Specifies the client node that owns the files about which you want information. You can specify one or more names. If you specify multiple names, separate the names with commas. Do not use intervening spaces. You can use wildcard characters to specify multiple names.

Information about client nodes that match the file criteria, but that are not configured for replication, is not displayed.

target\_server\_name

Specifies the name of the replication server to query for replication information. This parameter is optional. If you do not specify a value for this parameter, the server that is the default target for replicated data is queried.

As the value for this parameter, you can also specify a server that was formerly a target for replicated data.

The client nodes that are defined to a replication server can be the source or the target of replicated data. To determine whether a particular client node is sending or receiving data, issue the QUERY NODE command. Look for the value *Send* or *Receive* in the Replication Mode field of the output.

To display the name of the active target replication server, issue the QUERY STATUS command, and look for the name in the Target Replication Server field.

### Example: List client node files on a source and a target replication server

---

The name of the client node is NODE1.

```
query replnode *
```

Node Name	Type	Filespace Name	FSID	Files on Server	Replication Server (1)	Files on Server (1)
NODE1	SpMg	/hmsmfs	1	1		
NODE1	Bkup	/lspace2	2	27		
NODE1	Arch	/lspace2	2	22	TGTSRV	22
NODE1	Bkup	/lspace	3	18,096		
NODE1	Arch	/lspace	3	61,150	TGTSRV	61,150
NODE2						

The number of files that are displayed for the replication servers might be different for the following reasons:

- The output of the QUERY REPLNODE command displays the number of files obtained from the occupancy table. The occupancy table contains only files that have a length greater than zero. Files that have a length of 0 and have been

replicated are not reflected in this output.

- If only active data is replicated to the target server, the number of files that are displayed for the source server will be larger than the number of files that are displayed on the target server. The reason for the difference is that the source replication server has both active and inactive data, and the target server has only active data.
- A client node might have data that was exported from the source replication server and imported to the target replication server. If that data was synchronized and if the client node also stored data to the target replication server, then the number of files on the target replication server will be greater than the number of files stored as a result of export-and-import operations and replication.
- When you replicate node data from a source server prior to version 7.1, to a target server at version 7.1 or later, files that are larger than 10 GB are split in to smaller files if the SPLITLARGEOBJECTS parameter for the node definition is set to Yes. Each of these split files are counted on the target server.

## Field descriptions

---

### Node Name

The name of the client node that owns the files.

### Type

The type of data. If this field is blank, the client node is configured for replication, but it does not have data on the replication server. In the example output, NODE2 is configured for replication, but it does not have backup, archive, or space-managed data.

The following values are possible:

#### Arch

Archive data

#### Bkup

Backup data

#### SpMg

Data that was migrated by IBM Spectrum Protect™ for Space Management clients

### Filespace Name

The name of the file space that belongs to the node.

If this field is blank, the client node is configured for replication, but it does not have data on the replication server.

File space names can be in a different code page or locale than the server. If they are, the names in the Operations Center and the administrative command-line interface might not be displayed correctly. Data is backed up and can be restored normally, but the file space name or file name might be displayed with a combination of invalid characters or blank spaces.

If the file space name is Unicode-enabled, the name is converted to the server code page for display. The success of the conversion depends on the operating system, the characters in the name, and the server code page. Conversion can be incomplete if the string includes characters that are not available in the server code page or if the server cannot access system conversion routines. If the conversion is incomplete, the name might contain question marks, blanks, unprintable characters, or ellipses (...).

### FSID

The file space identifier for the file space. The server assigns a unique FSID when a file space is initially stored on the server. If this field is blank, the client node is configured for replication, but it does not have data on the replication server.

### Files on Server

The number of backup, archive, and space-managed files on the server on which this command is issued. If this field is blank, the client node is configured for replication, but it does not have data on the replication server.

### Replication Server (1)

The name of the replication server that is being queried for information. If this field is blank, one or more of the following conditions might exist:

- The file space of the node on the replication server where the command was issued does not have any data.
- The client node is not defined on replication server (1).
- The client node is defined on replication server (1), but the node is not configured for replication.
- The corresponding file space on replication server (1) does not have data or the file space is not defined.

### Files on Server (1)

The number of files for the data type that are stored on the target replication server. This field can be blank. If it is, one or more of the following conditions might exist:

- Replication server (1) does not have any data.
- The client node is not defined on replication server (1).
- The client node is defined on replication server (1), but the node is not configured for replication.
- The corresponding file space on replication server (1) does not have data or the file space is not defined.

## Related commands

Table 1. Commands related to QUERY REPLNODE

Command	Description
QUERY FILESPACE	Displays information about data in file spaces that belong to a client.
QUERY NODE	Displays partial or complete information about one or more clients.
QUERY REPLICATION	Displays information about node replication processes.
QUERY REPLRULE	Displays information about node replication rules.
REPLICATE NODE	Replicates data in file spaces that belong to a client node.
UPDATE REPLRULE	Enables or disables replication rules.

## QUERY REPLRULE (Query replication rules)

Use this command to display information about replication rules.

Issue this command on the server that acts as a source for replicated data.

### Privilege class

Any administrator can issue this command.

### Syntax

```

>>-Query REPLRule-----*----->>
'--ALL_DATA-----+'
++ACTIVE_DATA-----+
+-ALL_DATA_HIGH_PRIORITY----+
'-ACTIVE_DATA_HIGH_PRIORITY-'

```

### Privilege class

Any administrator can issue this command.

### Parameters

rule\_name

Specifies the name of the replication rule that you want to display information about. This parameter is optional. You can use wildcard characters to specify one or more rules. If you do not specify this parameter, information about all rules is displayed in the query output. You can specify the following values:

ALL\_DATA

Displays information about the ALL\_DATA replication rule. This rule replicates backup, archive, or space-managed data. The data is replicated with a normal priority.

ACTIVE\_DATA

Displays information about ACTIVE\_DATA replication rule. This rule replicates only active backup data. The data is replicated with a normal priority. This rule is not valid for archive or space-managed data.

Attention: If you specify ACTIVE\_DATA and one or more of the following conditions are true, inactive backup data on the target replication server is deleted, and inactive backup data on the source replication server is not replicated.

- When a server version earlier than Version 7.1.1 is installed on either the source or target replication servers.
- When you are using the REPLICATE NODE command with the `FORCERECONCILE=YES` parameter.
- When you are running the initial replication of a file space after you configure replication, restore the database, or upgrade both the source and target replication servers from a server version earlier than V7.1.1.

If the previous conditions are not true, all new and changed files since the last replication are replicated, including inactive files, and files are deleted when they expire.

#### ALL\_DATA\_HIGH\_PRIORITY

Displays information about the ALL\_DATA\_HIGH\_PRIORITY rule. This rule replicates backup, archive, or space-managed data. The data is replicated with a normal priority. In a replication process, high-priority data is replicated before normal-priority data.

#### ACTIVE\_DATA\_HIGH\_PRIORITY

Displays information about the ACTIVE\_DATA\_HIGH\_PRIORITY rule.

This rule is the same as the ACTIVE\_DATA replication rule except data is replicated with a high priority.

## Example: Display information about a server replication rule

The name of the rule is ALL\_DATA\_HIGH\_PRIORITY

```
query replrule all_data_high_priority
```

```
Replication Rule Name: ALL_DATA_HIGH_PRIORITY
Target Replication Server:
Active Only: No
Enabled: Yes
```

## Field descriptions

#### Replication Rule Name

Specifies the name of the rule that was queried.

#### Target Replication Server

Specifies the name of the target replication server.

#### Active Only

Specifies whether the rule applies only to active backup data. The following values are possible:

Yes

Specifies that only active backup data is replicated for file spaces to which this rule is assigned.

No

Specifies that all backup data is replicated for file spaces to which this rule is assigned.

#### Enabled

Specifies whether the rule is enabled or disabled. The following values are possible:

Yes

Specifies that the rule is enabled for replication. Data in file spaces to which the rule is assigned is replicated.

No

Specifies that the rule is not enabled for replication. Data in file spaces to which the rule is assigned is not replicated.

## Related commands

Table 1. Commands related to QUERY REPLRULE

Command	Description
QUERY REPLICATION	Displays information about node replication processes.
QUERY REPLNODE	Displays information about the replication status of a client node.
UPDATE REPLRULE	Enables or disables replication rules.

## QUERY REPLSERVER (Query a replication server)

Use this command to view information about all replication servers that are known server. The output from this command includes server information for the server from which the command was issued. The command indicates whether a replication server definition is deleted as a result of a REMOVE REPLSERVER command.

## Privilege class

---

Any administrator can issue this command.

## Syntax

---

```
.-*-----.  
>>-Query REPLServer--+-----+----->>  
'-server_name-'
```

## Example: Display summary statistics about all replicating servers

---

Display information about the replicating server. Issue the command from either the source or the target replication server:

```
query replserver *  
  
Replication Globally Unique ID: 4d.83.fc.30.67.c1.11.e1.b8.  
                                40.f0.de.f1.5e.f1.89  
      Server Name: Server1  
      Last Replication:  
      Heartbeat:  
Failover High Level Address: server1.example.com  
Failover TCP Port Number: 1500  
Failover SSL Port Number: 1542  
Deletion in Progress: No  
Dissimilar Policies:  
  
Replication Globally Unique ID: 91.0f.ef.90.5c.cc.11.e1.ae.  
                                34.08.00.27.00.58.dc  
      Server Name: DRServer1  
      Last Replication: 06/30/2012 08:16:30 PM  
      Heartbeat: 07/09/2012 22:15:22 PM  
Fail over High Level Address: drserver1.example.com  
Failover TCP Port Number: 1500  
Failover SSL Port Number: 1542  
Deletion in Progress: No  
Dissimilar Policies: On  
  
Replication Globally Unique ID: 90.4f.53.b0.8e.cb.11.e3.a8.  
                                2f.00.14.5e.55.b3.67  
      Server Name: DRSERVER2  
      Last Replication: 04/01/14 12:38:28  
      Heartbeat: 05/29/14 11:15:44  
Failover High Level Address: drserver2.example.com  
Failover TCP Port Number: 1500  
Failover SSL Port Number:  
Deletion in Progress: No  
Dissimilar Policies: Off
```

## Example: Display summary statistics about a specific replicating server

---

Display information about the replicating server DRServer1. Issue the command from either the source or the target replication server:

```
query replserver drserver1  
  
Replication Globally Unique ID: 91.0f.ef.90.5c.cc.11.e1.ae.  
                                34.08.00.27.00.58.dc  
      Server Name: DRServer1  
      Last Replication: 06/30/2012 08:16:30 PM  
      Heartbeat: 07/09/2012 22:15:22 PM  
Fail over High Level Address: drserver1.example.com  
Failover TCP Port Number: 1500  
Failover SSL Port Number: 1542
```

Deletion in Progress: No  
Dissimilar Policies: On

## Parameters

---

### server\_name

Specifies the name of the replication server to be queried. You can use wildcard characters to specify this name. All matching servers are queried. If you do not specify a value for this parameter, all servers are queried. The parameter is optional.

## Field descriptions

---

### Replication Globally Unique ID

The unique identifier for the IBM Spectrum Protect™ server. The values for the Replication Globally Unique ID are created when a server is first used in a replication process.

Tip: The ID listed in the Replication Globally Unique ID field is not the same value as the value for the ID listed in the Machine Globally Unique ID field that is shown in the QUERY STATUS command.

### Server Name

The name of the replication server.

### Last Replication

The date of the last replication process that used the server.

### Heartbeat

The last time that the server completed a successful test communication session.

### Failover TCP Port Number

The active Transmission Control Protocol (TCP) client port on the replication server that is used for client connections. If the client is configured for TCP, the port is used to connect to the failover server.

### Failover SSL Port Number

The active Secure Sockets Layer (SSL) port on the replication server that is used for client connections. If the client is configured for SSL, the port is used to connect to the failover server.

### Failover High Level Address

The high-level address that the client uses to connect to the replication server during failover.

### Deletion in Progress

Specifies whether a REMOVE REPLSERVER command was issued for this replication server and is still in progress. The following values are possible:

#### Yes

The deletion of the replication server is in progress.

#### No

The deletion of the replication server is not in progress.

### Dissimilar Policies

Specifies whether the policies that are defined on the target replication server are enabled. The following values are possible:

#### On

The policies on the target replication server manage replicated client-node data.

#### Off

The policies on the source replication server manage replicated client-node data.

## Related commands

---

Table 1. Commands related to QUERY REPLSERVER

Command	Description
REMOVE REPLNODE (Remove a client node from replication)	Removes a node from replication.
REMOVE REPLSERVER (Remove a replication server)	Removes a server from replication.

## QUERY REQUEST (Query one or more pending mount requests)

---

Use the QUERY REQUEST command to show information about one or more pending mount requests. The server makes requests for the administrator to complete an action, like inserting a tape volume in a library after a CHECKIN LIBVOL is issued.

## Privilege class

---

Any administrator can issue this command.

## Syntax

---

```
>>-Query REQuest---+-----+----->>  
                    '-request_number-'
```

## Parameters

---

request\_number

Specifies the identification number of the pending mount request. This parameter is optional. The default is all pending mount requests.

## Example: List all pending mount requests

---

Display information about all pending mount requests after a CHECKIN LIBVOL is issued.

```
query request
```

## Output for a manual Library

---

### AIX

```
ANR8352I Requests outstanding:  
ANR8326I 001: Mount 8MM volume EXP001 R/W  
in drive 8MM.1 (/dev/mt0) of library  
MANUALLIB within 60 minute(s).
```

### Linux

```
ANR8352I Requests outstanding:  
ANR8326I 001: Mount 8MM volume EXP001 R/W  
in drive 8MM.1 (/dev/mt0) of library  
MANUALLIB within 60 minute(s).
```

### Windows

```
ANR8352I Requests outstanding:  
ANR8326I 001: Mount GENERICTAPE volume EXP001 R/W  
in drive 8MM.1 (mt3.0.0.0) of library  
MANUALLIB within 60 minute(s).
```

## Output for an automated Library

---

### AIX

### Windows

```
ANR8352I Requests outstanding:  
ANR8306I 001: Insert LTO volume 133540L5 R/W into the slot with  
element number 31 of library LTOLIB within 60 minutes; issue  
'REPLY' along with the request ID when ready.
```

### Linux

```
ANR8352I Requests outstanding:  
ANR8306I 001: Insert 3590 volume 133540 R/W into the slot with element  
number 31 of library 3590LIB within 60 minutes; issue 'REPLY'  
along with the request ID when ready.
```

## Related commands

---

Table 1. Related commands for QUERY REQUEST

Command	Description
CANCEL REQUEST	Cancels pending volume mount requests.



Command	Description
REPLY	Allows a request to continue processing.

## QUERY RESTORE (Query restartable restore sessions)

Use this command to display information about the restartable restore sessions.

### Privilege class

Any administrator can issue this command.

### Syntax

```
>>-Query--REStore--+-+-----+-----+-----+----->
                        '-node_name-'  '-file_space_name-'

.-Format-----Standard----- .-NAMEType-----SERVER-----
>--+-----+-----+-----+----->>
  '-Format-----+Standard-+-'  '-NAMEType-----+SERVER-+-'
                        '-Detailed-'          +-UNICode-+
                                                '-FSID-----'
```

### Parameters

#### node\_name

Specifies the client node to be queried. This parameter is optional. If you do not specify a value, all client nodes with restartable restore sessions are displayed. You must specify a value for this parameter if you specify a file space name.

#### file\_space\_name

Specifies the file space to be queried. This parameter is optional. If you do not specify a value, all file spaces are matched for the specified node.

For a server that has clients with support for Unicode, you may need to have the server convert the file space name that you enter. For example, you may need to have the server convert the name you enter from the server's code page to Unicode. See the NAMETYPE parameter for details.

#### Format

Specifies how the information is displayed. This parameter is optional. The default value is STANDARD. Possible values are:

##### Standard

Specifies that partial information is displayed.

##### Detailed

Specifies that complete information is displayed.

#### NAMETYPE

Specify how you want the server to interpret the file space names that you enter. This parameter is useful when the server has clients with support for Unicode. You can use this parameter for Unicode-enabled IBM Spectrum Protect™ clients using Windows, Macintosh OS 9, Macintosh OS X, and NetWare operating systems.

Use this parameter only when you enter a partly or fully qualified file space name. The default value is SERVER. Possible values are:

##### SERVER

The server uses the server's code page to interpret the file space names.

##### UNICode

The server converts the file space name entered from the server code page to the UTF-8 code page. The success of the conversion depends on the actual characters in the name and the server's code page. Conversion can fail if the string includes characters that are not available in the server code page, or if the server has a problem accessing system conversion routines.

##### FSID

The server interprets the file space names as their file space IDs (FSIDs).

## Example: Display a restartable restore session on a specific client node

---

Display detailed information about client node JAMES associated with file space DRIVE\_F\_R. See Field descriptions for field descriptions.

```
query restore james drive_f_r format=detailed

  Sess Number: -1
  Restore State: Restartable
  Elapsed Minutes: 2
  Node Name: JAMES
  FSID: 1
  Filespace Name: DRIVE_F_R:
  File Spec: /RESTORE/TESTDIRF\
```

## Field descriptions

---

### Sess Number

Specifies the session number for the restartable restore session. The number for active restore sessions is the same number displayed on the QUERY SESSION command. For restore sessions in the restartable state, a negative number is displayed for the session number. Any session number displayed in the QUERY RESTORE output may be specified from the QUERY RESTORE output.

### Restore State

- Active: Specifies the restore session is actively restoring files to the client.
- Restartable: Specifies the restore session failed and can be restarted from where it left off.

### Elapsed Minutes

Specifies the number of minutes since the restore session started. Any restartable restore session with an elapsed time greater than the RESTOREINTERVAL server option can be automatically deleted from the database when needed or during expiration processing. If the elapsed time is less than the RESTOREINTERVAL, you can delete this entry (and unlock the file space) only by issuing the CANCEL RESTORE command lowering the RESTOREINTERVAL value.

### Node Name

Specifies the node associated with the restartable restore session.

### FSID

Specifies the file space ID of the file space.

### Filespace Name

Specifies the file space associated with the restartable restore session.

File space names can be in a different code page or locale than the server. If they are, the names in the Operations Center and the administrative command-line interface might not be displayed correctly. Data is backed up and can be restored normally, but the file space name or file name might be displayed with a combination of invalid characters or blank spaces.

If the file space name is Unicode-enabled, the name is converted to the server code page for display. The success of the conversion depends on the operating system, the characters in the name, and the server code page. Conversion can be incomplete if the string includes characters that are not available in the server code page or if the server cannot access system conversion routines. If the conversion is incomplete, the name might contain question marks, blanks, unprintable characters, or ellipses (...).

### File Spec

Specifies the file specification used on the restore operation. The same file specification must be specified if a failed restore operation is to be restarted from where it stopped.

## Related commands

---

Table 1. Commands related to QUERY RESTORE

Command	Description
CANCEL RESTORE	Cancels a restartable restore session.

## QUERY RPFCONTENT (Query recovery plan file contents stored on a target server)

---

Use this command to display the contents of a recovery plan file stored on a target server (that is, when the DEVCLASS parameter was specified on the PREPARE command). You can issue this command from either the server that created the file (the source server) or the server that stores the recovery plan file (the target server). You cannot issue this command from the server console.

The output may be delayed if the file is on tape.

## Privilege class

---

To issue this command, you must have system privilege.

## Syntax

---

```
>>-Query RPFContent--plan_file_name----->
>--+DEVclass---device_class_name-----<
  '-NODENAME---node_name-----'
```

## Parameters

---

plan\_file\_name (Required)

Specifies the name of the recovery plan file to be queried. The format of the file name is servername.yyyymmdd.hhmmss. To see the names of existing files, issue the QUERY RPFFILE command.

DEVclass

Specifies the name of the device class used to create the recovery plan file. Wildcard characters are not allowed. Specify this parameter when:

- You want to display the contents of the recovery plan file that was created for this server.
- You are issuing this command to the same server on which the PREPARE command was issued (the source server).
- The specified device class name was used on the PREPARE command that created the recovery plan file.

NODENAME

Specifies the node name, registered on the target server, of the source server that created the recovery plan file. Wildcard characters are not allowed.

Specify this parameter when:

- You want to display the contents of the recovery plan file that was stored on this server.
- You are issuing this command to the server that was the target of the PREPARE command that created the recovery plan file.
- The specified node name is registered to this server with a node type of SERVER.
- The IBM Spectrum Protect™ server that created the recovery plan file is not available.

## Example: Display the source server recovery plan

---

On the source server, display the contents of a recovery plan file that was created for this server on March 19, 1998, at 6:10 A.M. The PREPARE command specifies the device class REMOTE. The output of this command is the entire contents of the recovery plan file.

```
query rpfcontent branch1.19980319.061000 devclass=remote
```

## Example: Display the target server recovery plan

---

On the target server, display the contents of a recovery plan file that was stored in this server on March 19, 1998, at 6:10 A.M. The server that created the file is registered on the target server as a node named POLARIS with a node type of SERVER. The output of this command is the entire contents of the recovery plan file.

```
query rpfcontent branch1.19980319.061000 nodename=polaris
```

## Related commands

---

Table 1. Commands related to QUERY RPFCONTENT

Command	Description
---------	-------------

Command	Description
PREPARE	Creates a recovery plan file.
QUERY RPFIL	Displays information about recovery plan files.
QUERY VOLHISTORY	Displays sequential volume history information that has been collected by the server.

**Related information:**

[Disaster recovery plan file](#)

## QUERY RPFIL (Query recovery plan file information stored on a target server)

Use this command to display information about recovery plan files stored on a target server. You can issue this command from either the server that created the file (the source server) or the server that stores the recovery plan file (the target server).

### Privilege class

Any administrator can issue this command.

### Syntax

```
>>-Query RPFil---+DEVclass----device_class_name+----->
      '-NODName-----node_name-----'

.-Source----DBBackup-----.-Format----Standard-----
>+-----+-----+-----+-----+-----+-----><
  '-Source----+DBBackup----+'  '-Format----+Standard-+-'
      '-DBSnapshot-'          '-Detailed-'
```

### Parameters

**DEVclass**

Specifies the name of the device class that was used to create the recovery plan files. Use this parameter when logged on to the server that created the recovery plan file. You can use wildcard characters in the device class name. All recovery plan files that are created with the device class specified are included in the query.

**NODName**

Specifies the node name, registered on the target server, of the source server that created the recovery plan files. Use this parameter when logged on to the target server. You can use this parameter when the source server is not available. You can use wildcard characters to specify the node name. All file objects that are stored with the node name specified are included in this query.

**Source**

Specifies the type of database backup that was specified when the recovery plan file was prepared. This parameter is optional. The default is DBBACKUP. Possible values are:

**DBBackup**

The recovery plan file was prepared with full and incremental database backups specified.

**DBSnapshot**

The recovery plan file was prepared with snapshot database backups specified.

**Format**

Specifies how the information is displayed. This parameter is optional. The default is STANDARD. Possible values are:

**Standard**

Displays partial information for the recovery plan file.

**Detailed**

Displays all information for the recovery plan file.

### Example: Display detailed information about the recovery plans

Display recovery plan files that were created for this server using the specified device class. See Field descriptions for field descriptions.

```
query rpf file devclass=* format=detailed
```

```
Recovery Plan File Name: ALASKA.20000406.170423
Node Name: BRANCH1
Device Class Name: REMOTE
Recovery Plan File Type: RPF FILE
Mgmt Class Name: STANDARD
Recovery Plan File Size: 16,255 Bytes
Marked for Deletion: Yes
Deletion Date: 06/12/2000 13:05:31
```

```
Recovery Plan File Name: ALASKA.20000407.170845
Node Name: BRANCH1
Device Class Name: REMOTE
Recovery Plan File Type: RPF SNAPSHOT
Mgmt Class Name: STANDARD
Recovery Plan File Size: 16,425 Bytes
Marked for Deletion: No
Deletion Date:
```

## Example: Display a list of recovery plans for a specific node name

---

Display a list of all recovery plan file objects that are stored with the specified node name (TYPE=SERVER). See Field descriptions for field descriptions.

```
query rpf file nodename=branch1
```

Recovery Plan File Name	Node Name	Device Class Name
-----	-----	-----
ALASKA.19980406.170423	BRANCH1	REMOTE
ALASKA.19980407.170845	BRANCH1	REMOTE

## Field descriptions

---

### Recovery Plan File Name

The recovery plan file name.

### Node Name

The node name that is registered with the target server and used to store the recovery plan file objects.

### Device Class Name

The device class name that is defined in the source server and used to create the recovery plan files.

### Recovery Plan File Type

The type of recovery plan file:

#### RPF FILE

The plan assumes full plus incremental database backups.

#### RPF SNAPSHOT

The plan assumes snapshot database backups.

### Mgmt Class Name

The management class name that the recovery plan file is associated with in the target server.

### Recovery Plan File Size

Estimated size of the recovery plan file object on the target server.

### Marked For Deletion

Whether the object that contains the recovery plan file has been deleted from the source server and marked for deletion on the target server if the grace period has not expired. Possible values are:

#### Yes

The object is marked for deletion.

#### No

The object is not marked for deletion.

### Deletion Date

Date that the object has been deleted from the source server and marked for deletion on the target server. This field is blank if the object has not been marked for deletion.

## Related commands

Table 1. Commands related to QUERY RPFIL

Command	Description
PREPARE	Creates a recovery plan file.
QUERY VOLHISTORY	Displays sequential volume history information that has been collected by the server.
QUERY RPFCONTENT	Displays the contents of a recovery plan file.

## QUERY SAN (Query the devices on the SAN)

Use this command to obtain information about devices that can be detected on a storage area network (SAN) so that you can configure IBM Spectrum Protect™ for LAN-free data movement.

**AIX** The QUERY SAN command requires the libhbaapi.a that supports SNIA common Host Bus Adapter (HBA) API. With this library object, IBM Spectrum Protect can call the hbaapi functions that are specified in the SNIA common HBA API standard.

**Windows** The QUERY SAN command requires the hbaapi.dll that supports SNIA common Host Bus Adapter (HBA) API. With this library object, IBM Spectrum Protect can call the hbaapi functions that are specified in the SNIA common HBA API standard.

**Linux** The QUERY SAN command requires the libhbaapi.so that supports SNIA common Host Bus Adapter (HBA) API. With this library object, IBM Spectrum Protect can call the hbaapi functions that are specified in the SNIA common HBA API standard. The QUERY SAN command might not show all the devices if the SANDISCOVERY server option is not set to ON.

### Privilege class

Any administrator can issue this command.

### Syntax

```

      .-Type-----Any-----.
>>-Query SAN-----+----->
      '-Type-----+Any-----+'
                +-DRive---+
                '-LIBRARY-'

      .-Format-----Standard-----.
>-----+-----+----->>
      '-Format-----+Standard-+-'
                '-Detailed-'
```

### Parameters

#### Type

Specifies the type of device that is displayed. This parameter is optional. The default value is Any. Possible values are:

##### Any

Specifies that any device detected on the SAN is displayed.

##### DRive

Specifies that only drive devices are displayed.

##### LIBRARY

Specifies that only library devices are displayed.

#### Format

Specifies the type of information that is displayed. This parameter is optional. The default value is Standard. Possible values are:

##### Standard

Specifies that the information displayed is summarized.

##### Detailed

Specifies that complete information is displayed.

Tip: The output might not display the serial number of the device. If this happens, look on the back of the device or contact the manufacturer of the device.

## Example: List drive devices

---

Display summary information for drive devices on a SAN. See Field descriptions for field descriptions.

```
query san type=drive
```

Device Type	Vendor	Product	Serial	Device
-----	-----	-----	-----	-----
LIBRARY	STK	L180	MPC01000128	/dev/smc1
DRIVE	STK	9840D	331001017229	/dev/rmt3
DRIVE	Quantum	DLT4000	JF62806275	/dev/rmt4
DRIVE	Quantum	DLT4000	JP73213185	/dev/rmt5
DRIVE	STK	9840D	331000028779	/dev/rmt6

## Example: Display drive device information

---

Display detailed information for all drive devices on a SAN. See Field descriptions for field descriptions.

```
query san type=drive format=detailed
```

```
Device Type:  DRIVE
Vendor:       IBM
Product:     03570B02
Serial Number:
Device:      mt10.2.0.3
DataMover:   No
Node WWN:    5005076206039E05
Port WWN:    5005076206439E05
LUN:         0
SCSI Port:   3
SCSI Bus:    0
SCSI Target: 10
```

## Field descriptions

---

### Device Type

The type of device that is being displayed.

### Vendor

The name of the device's vendor.

### Product

The name of the product that is assigned by the vendor.

### Serial Number

The serial number of the device.

### Device

The device special file name.

### Data Mover

Whether the device is a data mover.

### Node WWN

The worldwide name for the device.

### Port WWN

The worldwide name for the device, which is specific to the port that the device is connected to.

### LUN

The Logical Unit Number of the device.

### SCSI Port

The port of the Fibre Channel (or SCSI) Host Bus Adapter.

### SCSI Bus

The bus of the Host Bus Adapter card.

### SCSI Target

The target number of the device.

## Related commands

---

Table 1. Commands related to QUERY SAN





#### schedule\_name

Specifies the name of the schedule that belongs to the specified policy domain. You can use a wildcard character to specify this name. If you specify a schedule name, you must also specify a policy domain name.

#### Type=Client

Specifies that the query displays client schedules. This parameter is optional. The default is CLIENT.

#### Nodes

Specifies the name of one or more client nodes that are associated with the schedules to be displayed. This parameter is optional. You can use a wildcard character to specify client nodes. If you do not specify a client name, all schedules matching the DOMAINNAME and SCHEDULENAME parameters are displayed. You can specify multiple client nodes by separating the names with commas and no intervening spaces.

#### Format

Specifies how information is displayed. This parameter is optional. The default is STANDARD. Possible values are:

##### Standard

Specifies that partial information is displayed for the schedules.

##### Detailed

Specifies that detailed information is displayed for the schedules.

The standard format displays a blank in the period column and an asterisk in the day column for enhanced schedules. To display complete information about an enhanced schedule, issue FORMAT=DETAILED.

## Example: List schedules for a specific policy domain

---

Display all schedules that belong to the EMPLOYEE\_RECORDS policy domain. See Field descriptions: Schedules for a specific policy domain for field descriptions.

```
query schedule employee_records
```

The standard format displays a blank in the period column and an asterisk in the day column for enhanced schedules. To display complete information about an enhanced schedule, issue FORMAT=DETAILED.

Domain	*	Schedule Name	Action	Start Date/Time	Duration	Period	Day
EMPLOY EE_RE- CORDS		WEEKLY_BACKUP	Inc Bk	2004.06.04 17.04.20	1 H	1 D	Any
EMPLOY- EE_RE- CORDS		EMPLOYEE_BACKUP	Inc Bk	2004.06.04 17.04.20	1 H		(*)

## Field descriptions: Schedules for a specific policy domain

---

#### Domain

Specifies the name of the policy domain to which the specified schedule belongs.

#### \*(Asterisk)

Specifies whether the corresponding schedule has expired. If there is an asterisk in this column, the corresponding schedule has expired.

#### Schedule Name

Specifies the name of the schedule.

#### Action

Specifies the action that occurs when this schedule is processed.

#### Start Date/Time

Specifies the initial starting date and time for this schedule.

#### Duration

Specifies the length of the startup window for this schedule.

#### Period

Specifies the time between startup windows (assuming DAYOFWEEK=ANY). The column is blank for enhanced schedules.

#### Day

Specifies the day of the week on which the startup windows for the schedule begin. The column contains an asterisk for enhanced schedules.

## Example: Display detailed client schedules

---

From a managed server, display detailed information about client schedules. See Field descriptions: Detailed client schedules for field descriptions.

```
query schedule * type=client format=detailed

      Policy Domain Name: ADMIN_RECORDS
      Schedule Name: ADMIN_BACKUP
      Description:
        Action: Backup
        Subaction: vApp
        Options:
        Objects:
        Priority: 5
      Start Date/Time: 04/06/2013 17.04.20
      Duration: 1 Hour(s)
Maximum Run Time (Minutes): 0
      Schedule Style: Classic
      Period: 1 Day(s)
      Day of Week: Any
      Month:
      Day of Month:
      Week of Month:
      Expiration:
Last Update by (administrator): $$CONFIG_MANAGER$$
      Last Update Date/Time: 04/06/2013 17.51.49
      Managing profile: ADMIN_INFO

      Policy Domain Name: EMPLOYEE_RECORDS
      Schedule Name: EMPLOYEE_BACKUP
      Description:
        Action: Incremental
        Subaction:
        Options:
        Objects:
        Priority: 5
      Start Date/Time: 2004.06.04 17.04.33
      Duration: 1 Hour(s)
Maximum Run Time (Minutes): 0
      Schedule Style: Enhanced
      Period:
      Day of Week: Any
      Month: Mar, Jun, Nov
      Day of Month: -14, 14, 22
      Week of Month: Last
      Expiration:
Last Update by (administrator): $$CONFIG_MANAGER$$
      Last Update Date/Time: 2004.06.04 17.18.30
      Managing profile: EMPLOYEE
```

## Field descriptions: Detailed client schedules

---

### Policy Domain Name

Specifies the name of the policy domain.

### Schedule Name

Specifies the name of the schedule.

### Description

Specifies the description of the schedule.

### Action

Specifies the type of action that occurs when this schedule is run. See the DEFINE SCHEDULE command for a listing of actions.

### Subaction

Specifies that the type of operation identified by the ACTION parameter is to be scheduled. See the DEFINE SCHEDULE command for a listing of subactions.

### Options

Specifies the options that are supplied to the DSMC command when the schedule is run.

### Objects

Specifies the objects for which the specified action is performed.

### Priority

Specifies the priority value for the schedule.

**Start Date/Time**  
Specifies the initial starting date and time for the schedule.

**Duration**  
Specifies the length of the startup window for the schedule.

**Maximum Run Time (Minutes)**  
Specifies the number of minutes during which all client sessions that are started by the scheduled operation should be completed. If sessions are still running after the maximum run time, the server issues a warning message, but the sessions continue to run.

**Schedule Style**  
Specifies whether classic or enhanced schedule rules are used.

**Period**  
Specifies the time between startup windows (assuming DAYOFWEEK=ANY). This is not displayed for enhanced syntax schedules.

**Day of Week**  
Specifies the day of the week on which the startup windows for the schedule begin. Using a standard format displays an asterisk in the day of week field for enhanced schedules.

**Month**  
Specifies the months during which the schedule will run. This is not displayed for classic syntax schedules.

**Day of Month**  
Specifies the days of the month during which the schedule will run. This is not displayed for classic syntax schedules.

**Week of Month**  
Specifies the weeks (first, second, third, fourth, or last) of the month during which the schedule will run. This is not displayed for classic syntax schedules.

**Expiration**  
Specifies the date and time on which this schedule expires. If this column is blank, the schedule does not expire.

**Last Update by (administrator)**  
Specifies the name of the administrator that most recently updated the schedule. If this field contains a \$\$CONFIG\_MANAGER\$\$, the schedule is associated with a domain that is managed by the configuration manager.

**Last Update Date/Time**  
Specifies the last date and time the schedule was last updated.

**Managing Profile**  
Specifies the profile or profiles to which the managed server subscribed to get the definition of this schedule.

## QUERY SCHEDULE (Query an administrative schedule)

---

Use this command to display information about one or more administrative schedules.

### Privilege class

---

Any administrator can issue this command.

### Syntax

---

```

>>-Query SCHEDULE--*-----+-----+---Type---Administrative--->
                        '-schedule_name-'

.-Format---Standard----.
>--+-----+----->>
  '-Format---Standard+-'
                        '-Detailed-'

```

### Parameters

---

**schedule\_name**  
Specifies the name of the schedule to be queried. You can use a wildcard character to specify this name.

**Type=Administrative (Required)**  
Specifies that the query displays administrative command schedules.

**Format**  
Specifies how information is displayed. This parameter is optional. The default is STANDARD. Possible values are:

#### Standard

Specifies that partial information is displayed for the schedules.

#### Detailed

Specifies that detailed information is displayed for the schedules.

The standard format displays a blank period column and an asterisk in the day column for enhanced schedules. Issue `FORMAT=DETAILED` to display complete information about an enhanced schedule.

## Example: Display detailed information on administrative command schedules

---

From a managed server, display detailed information about administrative command schedules. See Field descriptions for field descriptions.

```
query schedule * type=administrative
format=detailed

        Schedule Name: BACKUP_ARCHIVEPOOL
        Description:
          Command: backup db
          Priority: 5
        Start Date/Time: 2004.06.04 16.57.15
          Duration: 1 Hour(s)
Maximum Run Time (Minutes): 0
        Schedule Style: Classic
          Period: 1 Day(s)
          Day of Week: Any
          Month:
        Day of Month:
        Week of Month:
        Expiration:
          Active: No
Last Update by (administrator): $$CONFIG MANAGER$$
        Last Update Date/Time: 2004.06.04 17.51.49
        Managing Profile: ADMIN_INFO

        Schedule Name: MONTHLY_BACKUP
        Description:
          Command: q status
          Priority: 5
        Start Date/Time: 2004.06.04 16.57.14
          Duration: 1 Hour(s)
Maximum Run Time (Minutes): 0
        Schedule Style: Enhanced
          Period:
          Day of Week: Tue,Thu,Fri
          Month: Aug,Nov
        Day of Month:
        Week of Month: Second,Third
        Expiration:
          Active: No
Last Update by (administrator): $$CONFIG MANAGER
        Last Update Date/Time: 2004.06.04 17.51.49
        Managing Profile: ADMIN_INFO
```

## Field descriptions

---

#### Schedule Name

Specifies the name of the schedule.

#### Description

Specifies the description of the schedule.

#### Command

Specifies the command that is scheduled.

#### Priority

Specifies the priority value for this schedule.

#### Start Date/Time

Specifies the initial starting date and time for this schedule.

#### Duration

Specifies the length of the startup window.

### Maximum Run Time (Minutes)

Specifies the number of minutes during which server processes that are started by the scheduled commands must be completed. If processes are still running after the maximum run time, the central scheduler cancels the processes.

Tips:

- This parameter does not apply to some processes, such as duplicate-identification processes, which can continue to run after the maximum run time.
- Another cancel time might be associated with some commands. For example, the MIGRATE STGPOOL command can include a parameter that specifies the length of time that the storage pool migration runs before the migration is automatically canceled. If you schedule a command for which a cancel time is defined, and you also define a maximum run time for the schedule, the processes are canceled at whichever cancel time is reached first.

### Schedule Style

Specifies whether classic or enhanced schedule rules are used.

### Period

Specifies the time between startup windows (assuming DAYOFWEEK=ANY). This is not displayed for enhanced syntax schedules.

### Day of Week

Specifies the day of the week on which the startup windows begin.

### Month

Specifies the months during which the schedule will run. This is not displayed for classic syntax schedules.

### Day of Month

Specifies the days of the month during which the schedule will run. This is not displayed for classic syntax schedules.

### Week of Month

Specifies the weeks (first, second, third, fourth, or last) of the month during which the schedule will run. This is not displayed for classic syntax schedules.

### Expiration

Specifies the date after which this schedule will no longer be used. If this column is blank, the schedule does not expire.

### Active?

Specifies whether the schedule has been processed according to the time and date set for this schedule.

### Last Update by (administrator)

Specifies the name of the administrator that most recently updated the schedule. If this field contains a \$\$CONFIG\_MANAGER\$\$, the schedule is associated with a domain that is managed by the configuration manager.

### Last Update Date/Time

Specifies the last date and time the schedule was modified.

### Managing Profile

Specifies the profile or profiles to which the managed server subscribed to get the definition of this schedule.

## QUERY SCRATCHPADENTRY (Query a scratch pad entry)

---

Use this command to display data that is contained in the scratch pad.

### Privilege class

---

Any administrator can issue this command.

### Syntax

---

```
>>-Query SCRATCHPadentry----->
.
.*--*--*-----
>--+-----+-----+-----+----->
|          |          |          |          |
'-major_category--+-----+-----+-----+-----'
|          |          |          |          |
'-minor_category--+-----+-----+-----+-----'
|          |          |          |          |
'-subject-'

.-Line-----*-----
>--+-----+-----+-----+----->>
'-Line-----number-'
```

## Parameters

---

### major\_category

Specifies the major category to be queried. This parameter is case sensitive. You can query all major categories by omitting this parameter.

### minor\_category

Specifies the minor category to be queried. This parameter is case sensitive. You can query all minor categories in the major category by omitting this parameter.

### subject

Specifies the subject to be queried. This parameter is case sensitive. You can query all subjects in the minor category by omitting this parameter.

### Line

Specifies the number of the line to be queried. For *number*, enter an integer in the range 1 - 1000. You can query all lines of data in the subject by omitting this parameter.

## Example: Query scratch pad entries

---

Query a database that stores information about the location of all administrators.

```
query scratchpadentry admin_info location
```

```
Scratchpad major category: admin_info
Scratchpad minor category: location
Scratchpad subject: codjo
Scratchpad line number: 1
Scratchpad data: Toronto 5A24
Date/time of creation: 2013-09-10, 10:15:50
Last Update Date/Time: 2013-09-10, 10:15:50
Last Update by (administrator): CODJO
```

```
Scratchpad major category: admin_info
Scratchpad minor category: location
Scratchpad subject: jane
Scratchpad line number: 1
Scratchpad data: Raleigh GF85
Date/time of creation: 2013-09-09, 14:29:40
Last Update Date/Time: 2013-09-09, 14:29:40
Last Update by (administrator): JANE_W
```

```
Scratchpad major category: admin_info
Scratchpad minor category: location
Scratchpad subject: jane
Scratchpad line number: 2
Scratchpad data: Out of the office from 1-15 Nov.
Date/time of creation: 2013-09-09, 14:30:05
Last Update Date/Time: 2013-10-31, 16:55:52
Last Update by (administrator): JANE_W
```

```
Scratchpad major category: admin_info
Scratchpad minor category: location
Scratchpad subject: montse
Scratchpad line number: 1
Scratchpad data: Barcelona B19
Date/time of creation: 2013-09-10, 04:34:37
Last Update Date/Time: 2013-09-10, 04:34:37
Last Update by (administrator): MONTSERRAT
```

## Field descriptions

---

### Scratchpad data

The data that is stored in the scratch pad entry.

### Date/time of creation

The date and time at which the scratch pad entry was created.

### Last Update Date/Time

The date and time at which the scratch pad entry was last updated.

### Last Update by (administrator)

The administrator who last updated the scratch pad entry.

## Related commands

Table 1. Commands related to QUERY SCRATCHPADENTRY

Command	Description
DEFINE SCRATCHPADENTRY	Creates a line of data in the scratch pad.
DELETE SCRATCHPADENTRY	Deletes a line of data from the scratch pad.
SET SCRATCHPADRETENTION	Specifies the amount of time for which scratch pad entries are retained.
UPDATE SCRATCHPADENTRY	Updates data on a line in the scratch pad.

## QUERY SCRIPT (Query IBM Spectrum Protect scripts)

Use this command to display information about scripts.

You can use this command with the DEFINE SCRIPT command to create a new script by using the contents from another script.

### Privilege class

The privilege class that is required for this command depends on whether the Outputfile parameter is specified in the command.

- If the Outputfile parameter is not specified, any administrator can issue this command.
- If the Outputfile parameter is specified and the REQSYSAUTHOUTFILE server option is set to YES, the administrator must have system privilege.
- If the Outputfile parameter is specified and the REQSYSAUTHOUTFILE server option is set to NO, the administrator must have operator, policy, storage, or system privilege.

### Syntax

```
.*-----  
>>-Query SCRIPT--+----->  
      '-script_name-'  
  
.-FORMAT----Standard-----  
>--+-----+-----><  
  '-FORMAT----+Standard-----+'  
      +-Detailed-----+  
      +-Lines-----+  
      '-Raw--+-----+-'  
          '-Outputfile----file_name-'
```

### Parameters

#### script\_name

Specifies the name of the script for which information is to be displayed. You can include a wildcard character to specify this name.

Important: If you do not specify a script, the query displays information about all scripts. The time that is used to process this command and the amount of information that is displayed can be extensive.

#### Format

Specifies the output format for displaying script information. The default is STANDARD. Possible values are:

##### Standard

Specifies that only the script name and description in a script are displayed.

##### Detailed

Specifies that detailed information about the script is displayed. This information includes the commands in the script and their line numbers, the date of the last update and the administrator that completed the updates.

##### Lines

Specifies that the script name, the line number of the commands, comment lines, and the commands in the script are displayed.

##### Raw

Specifies that commands contained in the script are written to a file named with the Outputfile parameter. This format is a way of directing output from a script to a file so that it can be copied into another script by using the DEFINE SCRIPT command.

If no output file is specified, the IBM Spectrum Protect™ server outputs the "query script" with "format=raw" to the console.

#### Outputfile

Specifies the name of the file to which output is directed when you specify FORMAT=Raw. The file that you specify must be on the server that is running this command. If the file exists, the query output is appended to the end of the file.

### Example: List the script descriptions

---

Display the standard information about scripts.

```
query script *

Name                Description
-----
QCOLS              Display columns for a specified SQL table
QSAMPLE            Sample SQL Query
EXAMPLE            Backup the store pools and database when no sessions
```

### Example: Display the contents of a script with line numbers

---

Display the lines of information for a script named Q\_AUTHORITY.

```
query script q_authority format=lines

Name      Line   Command
-----
Q_AUTHORITY 1      /* -----*/
              5      /* Script Name:  Q_AUTHORITY      */
              10     /* Description: Display administrators that */
              15     /*           have the authority to issue */
              20     /*           commands requiring a      */
              25     /*           specific privilege.      */
              30     /* Parameter 1: privilege name - in the form */
              35     /*           x_priv - EX. policy_priv */
              40     /* Example:  run q_authority storage_priv */
              45     /* -----*/
              50     select admin_name from admins where -
              55     upper(system_priv) <> 'NO' or -
              60     upper($1) <> 'NO'
```

### Example: Create a script from an existing script

---

Query the ENGDEV script and direct the output to a file named MY.SCRIPT.

```
query script engdev format=raw outputfile=my.script
```

### Example: Display detailed script information

---

Display detailed information about scripts. See Field descriptions for field descriptions.

```
query script * format=detailed

                Name: QCOLS
                Line Number: DESCRIPTION
                Command: Display columns for a specified SQL
                table
Last Update by (administrator): SERVER_CONSOLE
                Last Update Date/Time: 12/02/1997 16:05:29

                Name: QCOLS
                Line Number: 1
                Command: select colname from columns where
                tabname='$1'
```



## Field descriptions

---

### Name

The name of the script.

### Line Number

The line number of the script or the string DESCRIPTION.

### Command

The command included on the line number that is displayed in the previous field.

### Last Update by (administrator)

The name of the administrator that defined or most recently updated the script.

### Last Update Date/Time

The date and time that the administrator defined or updated the script.

## Related commands

---

Table 1. Commands related to QUERY SCRIPT

Command	Description
COPY SCRIPT	Creates a copy of a script.
DEFINE SCRIPT	Defines a script to the IBM Spectrum Protect server.
DELETE SCRIPT	Deletes the script or individual lines from the script.
RENAME SCRIPT	Renames a script to a new name.
RUN	Runs a script.
UPDATE SCRIPT	Changes or adds lines to a script.

### Related concepts:

Server scripts

## QUERY SERVER (Query a server)

---

Use this command to display information about a server definition.

### Privilege class

---

Any administrator can issue this command.

### Syntax

---

```
>>-Query SERVER-+-----+-----+-----+-----+-----<<
                .*----- .-Format---Standard-----
                '-server_name-' '-Format---+Standard+-'
                                '-Detailed-'
```

### Parameters

---

#### server\_name

Specifies the name of the server to be queried. You can use wildcard characters to specify this name. This parameter is optional. The default is all server names.

#### Format

Specifies how the information is displayed. The parameter is optional. The default is STANDARD.

#### Standard

Specifies that partial information is displayed.

#### Detailed

Specifies that complete information is displayed.

## Example: List all servers

---

Display information in standard format about all servers. See Field descriptions for field descriptions.

```
query server *
```

Server Name	Comm. Method	High-level Address	Low-level Address	Days Since Last Access	Server Password Set	Virtual Volume Password Set	Allow Replacement
SERVER_A	TCPIP	9.115.35.6	1501	11	Yes	No	No
SERVER_B	TCPIP	9.115.45.24	1500	<1	Yes	No	No
ASTRO	TCPIP	9.115.32.21	1500	24	Yes	No	No

## Example: Display detailed information about a specific server

---

From a managed server, display detailed information about SERVER\_A. See Field descriptions for field descriptions.

```
query server server_a format=detailed
```

```
Server Name: SERVER_A
Comm. Method: TCPIP
Transfer Method: TCPIP
High-level Address: 9.115.4.15
Low-level Address: 1500
Description:
Allow Replacement: No
Node Name:
Last Access Date/Time: 07/09/2013 09:00:00
Days Since Last Access: <1
Compression: Client's choice
Archive Delete Allowed?: No
URL:
Registration Date/Time: 07/08/2013 09:15:09
Registering Administrator: $$CONFIG_MANAGER$$
Bytes Received Last Session: 362
Bytes Sent Last Session: 507
Duration of Last Session: 0.00
Pct. Idle Wait Last Session: 0.00
Pct. Comm. Wait Last Session: 0.00
Pct. Media Wait Last Session: 0.00
Grace Deletion Period: 5
Managing profile:
Server Password Set: Yes
Server Password Set Date/Time: 07/08/2013 09:15:09
Days Since Server Password Set: 1
Invalid Sign-on Count for Server: 0
Virtual Volume Password Set: No
Virtual Volume Password Set Date/Time: (?)
Days Since Virtual Volume Password Set: (?)
Invalid Sign-on Count for Virtual Volume Node: 0
Validate Protocol: No
Version: 7
Release: 1
Level: 0.0
Role(s): Replication
SSL: No
Session Security: Strict
Transport Method: TLS 1.2
```

## Field descriptions

---

### Server Name

The name of the server.

### Comm. Method

The communication method that is used to connect to the server.

### Transfer Method

The method that is used for server-to-server data transfer.

### High-level Address

The IP address (in dotted decimal format) of the server.

Low-level Address  
The port number of the server.

Description  
The server description.

Allow Replacement  
Specifies whether a server definition on a managed server can be replaced with a definition from a configuration manager.

Node Name  
The name of the client node.

Last Access Date/Time  
The last date and time that the client node accessed the server.

Days Since Last Access  
The number of days since the client node accessed the server.

Compression  
The type of compression that is completed by IBM Spectrum Protect™ on client files.

Archive Delete Allowed?  
Specifies whether the client node can delete its own archive files. A value of (?) denotes that this field is not set and does not apply to this definition.

URL  
The URL used to access this server from a web browser-based interface.

Registration Date/Time  
The date and time that the client node was registered.

Registering Administrator  
The name of the administrator that registered the client node.

Bytes Received Last Session  
The number of bytes received by the server during the last client node session.

Bytes Sent Last Session  
The number of bytes sent to the client node.

Duration of Last Session  
The length of the last client node session, in seconds.

Pct. Idle Wait Last Session  
The percentage of the total session time during which the client did not complete any functions.

Pct. Comm. Wait Last Session  
The percentage of the total session time that the client waited for a response from the server.

Pct. Media Wait Last Session  
The percentage of the total session time that the client waited for a removable volume to be mounted.

Grace Deletion Period  
The number of days an object remains on the target server after it is marked for deletion.

Managing Profile  
The profile from which the managed server got the definition of this server.

Server Password Set  
Specifies whether the password for the server is set.

Server Password Set Date/Time  
Specifies when the password for the server is set.

Days since Server Password Set  
The number of days since the server password was set.

Invalid Sign-on count for Server  
The maximum number of invalid sign-on attempts that the server can accept.

Virtual Volume Password Set  
Specifies whether the password used to log on to the target server is set.

Virtual Volume Password Set Date/Time  
Specifies when the password for virtual volume support is set.

Days Since Virtual Volume Password Set  
The number of days since the password for virtual volume support was set.

Invalid Sign-on Count for Virtual Volume Node  
The maximum number of invalid sign-on attempts that are accepted on the target server.

Validate Protocol (deprecated)  
Specifies whether the storage agent has the data validation function enabled. This field is deprecated.

Version  
The software version of the IBM Spectrum Protect server.

**Release**

The software release of the IBM Spectrum Protect server.

**Level**

The software level of the IBM Spectrum Protect server.

**Role(s)**

The role of the server. For example, one of the roles that the server is used for is replication.

**SSL**

Specifies whether Secure Sockets Layer (SSL) communication is used.

**Session Security**

Specifies the level of session security that is enforced for the server. Values can be STRICT or TRANSITIONAL.

**Transport Method**

Specifies the transport method that was last used for the specified server. Values can be TLS 1.2, TLS 1.1, or NONE. A question mark (?) is displayed until a successful authentication is completed.

## Related commands

---

Table 1. Commands related to QUERY SERVER

Command	Description
DEFINE DEVCLASS	Defines a device class.
DEFINE SERVER	Defines a server for server-to-server communications.
DELETE DEVCLASS	Deletes a device class.
DELETE FILESPACE	Deletes data associated with client file spaces. If a file space is part of a collocation group and you remove the file space from a node, the file space is removed from the collocation group.
DELETE SERVER	Deletes the definition of a server.
<b>AIX</b>   <b>Linux</b>   <b>Windows</b> PROTECT STGPOOL	<b>AIX</b>   <b>Linux</b>   <b>Windows</b> Protects a directory-container storage pool.
QUERY NODE	Displays partial or complete information about one or more clients.
RECONCILE VOLUMES	Reconciles source server virtual volume definitions and target server archive objects.
REGISTER NODE	Defines a client node to the server and sets options for that user.
REMOVE NODE	Removes a client from the list of registered nodes for a specific policy domain.
REPLICATE NODE	Replicates data in file spaces that belong to a client node.
SET REPLSERVER	Specifies a target replication server.
UPDATE DEVCLASS	Changes the attributes of a device class.
UPDATE NODE	Changes the attributes that are associated with a client node.
UPDATE SERVER	Updates information about a server.

## QUERY SERVERGROUP (Query a server group)

---

Use this command to display information about server groups and group members.

### Privilege class

---

Any administrator can issue this command.

### Syntax

---

.-\*-----.

```
>>-QUERY SERVERGroup--+-+-----+----->>
                    '-group_name-'
```

## Parameters

---

**group\_name**  
Specifies the server group to query. This parameter is optional. You can use wildcard characters to specify this name.

## Example: List server groups

---

From a managed server, query all server groups. Field descriptions for field descriptions.

```
query servergroup *
```

Server Group	Members	Description	Managing Profile
ADMIN_GROUP	SERVER_A SERVER_B SERVER_C SERVER_D	Headquarters	ADMIN_INFO

## Field descriptions

---

**Server Group**  
The name of the server group.

**Members**  
The group members.

**Description**  
The description of the server group.

**Managing Profile**  
The profile or profiles to which the managed server subscribed to get the definition of the server groups.

## Related commands

---

Table 1. Commands related to QUERY SERVERGROUP

Command	Description
COPY SERVERGROUP	Creates a copy of a server group.
DEFINE SERVERGROUP	Defines a new server group.
DELETE SERVERGROUP	Deletes a server group.
QUERY SERVER	Displays information about servers.
RENAME SERVERGROUP	Renames a server group.
UPDATE SERVERGROUP	Updates a server group.

## QUERY SESSION (Query client sessions)

---

Use this command to display information about administrative, node, and server sessions.

## Privilege class

---

Any administrator can issue this command.

## Syntax

---

```
>>-Query SEssion--+-+-----+----->>
                    '-sessnum-'
```

```
>--+-+-----+----->
    '-MINTIMethreshold---minutes-'
```

```

>----->
'-MAXTHroughput-----kilobytes_per_second-'

.-Format-----Standard-----.-Type-----*-----
>----->
'-Format-----+Standard+-' '-Type-----+Admin--+'
          '-Detailed-'                +-Node---+
                                         '-Server-'

.-CLIENTName-----*-----
>----->>
'-CLIENTName-----client_name--'

```

## Parameters

---

### sessnum

Specifies the number of the administrative or client node session to query. This parameter is optional. If you do not specify a value for this parameter, all sessions display.

### MINTIMethreshold

Specifies to display sessions that had at least this number of minutes elapse from the time the client sent data to the server for storage. This parameter is optional. The minimum number of minutes is 1. The maximum number of minutes is 99999999.

### MAXTHroughput

Specifies to display sessions that are transferring data at a rate less than this number of kilobytes per second. This parameter is optional. The minimum number of kilobytes per second is 0. The maximum number of kilobytes per second is 99999999.

### Format

Specifies how the information displays. This parameter is optional. The default value is STANDARD. The following values are possible:

#### Standard

Specifies that partial information displays for the session.

#### Detailed

Specifies that complete information displays for the session.

### Type

Specifies the type of sessions to include in the query results. If you do not specify a value for this parameter, all types of sessions are queried. This parameter is optional. You can specify one of the following values:

#### Admin

Specifies that administrative sessions are displayed.

#### Node

Specifies that node sessions are displayed.

#### Server

Specifies that server sessions are displayed.

### CLIENTName

Specifies the name of an administrator, client node, or server to be queried. You can specify one or more names. You can also specify node groups and proxy nodes. If you specify multiple names, separate the names with commas; use no intervening spaces. You can use wildcard characters with node names but not with node group names. The parameter is optional.

During node replication, the client name on the target server is displayed as *node\_name (server\_name)*, where *node\_name* is the node whose data is being replicated, and *server\_name* is the name of the source server. You can specify either the node name or the server name in the CLIENTName parameter to display the replication sessions.

## Example: List active client node sessions

---

Display information about all administrative and client node sessions that are communicating with the server. See Field descriptions for field descriptions.

```
query session
```

Sess Number	Comm. Method	Sess State	Wait Time	Bytes Sent	Bytes Recvd	Sess Type	Platform	Client Name
4	TCP/IP	Run	0 S	1.4 K	162	Admin	WinNT	ADMIN

## Example: Display detailed information about active client node sessions

Display detailed information about all administrative and client node sessions that are communicating with the server. See Field descriptions for field descriptions.

```
query session format=detailed
```

```

      Sess Number: 4
      Comm. Method: Tcp/Ip
      Sess State: Run
      Wait Time: 0 S
      Bytes Sent: 1.4 K
      Bytes Recvd: 162
      Sess Type: Admin
      Platform: WinNT
      Client Name: ADMIN
Media Access Status:
      User Name:
Date/Time First Data Sent:
Proxy By Storage Agent:
      Actions:
Failover Mode: No

```

## Field descriptions

### Sess Number

Specifies a unique session identification number that is assigned by the server.

### Comm. Method

Specifies the method that is used by the client to communicate with the server.

### Sess State

Specifies the current communications state of the server. The following states are possible:

#### End

The session is ending (session resources are released).

#### IdleW

Waiting for client's next request (session is idle).

#### MediaW

The session is waiting for access to a sequential access volume.

#### RecvW

Waiting to receive an expected message from the client.

#### Run

The server is running a client request (and not waiting to send data).

#### SendW

The server is waiting to send data to the client (waiting for data to be delivered to the client node that was already sent).

#### SSLiW

The session is waiting for Secure Sockets Layer (SSL) initialization to complete.

#### Start

The session is starting (authentication is in progress).

### Wait Time

Specifies the amount of time (seconds, minutes, or hours) the server is in the current state shown.

### Bytes Sent

Specifies the number of bytes of data that is sent to the client node since the session was initiated.

### Bytes Recvd

Specifies the number of bytes of data that is received from the client node since the session was initiated.

### Sess Type

Specifies the type of session in process: ADMIN for an administrative session, NODE for a client node session, or SERVER. SERVER specifies the server starts a session and initiates server-to-server operations such as central configuration, library sharing, and storage agent sessions.

### Platform

Specifies the type of operating system that is associated with the client.

#### Client Name

Specifies the name of the client node or the administrator.

For node replication sessions, the client name is updated to *node\_name (server\_name)* on the target server after data transfer starts.

#### Media Access Status

Specifies the type of media wait state. When a session is in a media wait state, this field displays a list of all mount points and sequential volumes for the session. The list of mount points specifies the device class and the associated storage pool. The list of volumes specifies the primary storage pool volumes in addition to any copy storage pool and active-data pool volumes along with their assigned storage pool.

The server allows multiple sessions to read and one session to write to a volume concurrently in a storage pool that is associated with the FILE or CENTERA device type. As a result, a volume in a storage pool with a device type of FILE or CENTERA can appear as the current volume for more than one session.

#### Proxy by Storage Agent

Specifies the storage agent that is the proxy for LAN-free data movement for the node.

#### User Name

Specifies the user ID of the node, on a multi-user system, that connects to the server when it is not the same system user who originally connected to the server.

#### Date/Time First Data Sent

Specifies the date and time that the client first sent data to the server for storage.

#### Actions

Displays a list of actions that are performed during the session. An action is listed only once, even if the action occurs multiple times during a session. The following actions are possible:

##### BkIns

One or more backup objects were stored on the server. The operation might have been an incremental backup or a selective backup.

##### BkUpd

One or more attributes were updated for a backup object that is stored on the server.

##### BkDel

One or more backup objects that are stored on the server are deleted.

##### BkRebind

One or more backup objects that are stored on the server are bound to a different management class.

##### NoQueryRestore

A no-query restore operation was initiated from the client to restore backed-up files from the server to the client system.

##### ArIns

One or more archive objects were stored on the server.

##### ObjRtrv

One or more files were retrieved from the server. This might have been to retrieve archive files, or to restore backup data (except for backup data from a no-query restore operation).

##### MigIns

One or more files are migrated and stored on the server by IBM Spectrum Protect™ for Space Management (HSM client).

##### MigDel

One or more space-managed files that were stored on the server are deleted.

##### MigRebind

One or more space-managed files that are stored on the server are bound to a different management class.

##### MigRecall

One or more space-managed files that are stored on the server are recalled.

##### MigUpd

The attributes for one or more space-managed files that are stored on the server are updated.

##### FSAdd

The client node added one or more new file spaces to server storage.

##### FSUpd

The client node updated attributes for one or more file spaces that are defined to the server.

##### DefAuth

A SET ACCESS command is processed by the client node, which caused an authorization rule for access to the client node's data to be added.



#### Failover Mode

Specifies whether the client session was started in failover mode. The following values are possible:

#### Force

The FORCEFAILOVER flag is specified on the client and the session is forced into failover mode.

#### Yes

The client session was started in failover mode.

#### No

The client session was not started in failover mode.

## Related commands

---

Table 1. Command related to QUERY SESSION

Command	Description
CANCEL SESSION	Cancels active sessions with the server.

## QUERY SHREDSTATUS (Query shredding status)

---

Use this command to display information about data waiting to be shredded.

### Privilege class

---

To issue this command you must have administrator privilege.

### Syntax

---

```

>>-QUERY SHREDstatus--+-Format---Standard-----+-----><
                        '-Format---Standard-+-'
                        '-Detailed-'

```

### Parameters

---

#### Format

Specifies how the information is displayed. This parameter is optional. The default is STANDARD. Possible values are:

#### Standard

Specifies that partial information is displayed. This is the default.

#### Detailed

Specifies that complete information is displayed.

### Example: Display summary shredding information

---

Show partial information about data shredding on the server. See Field descriptions for field descriptions.

```
query shredstatus
```

```

Shredding      Objects
Active         Awaiting
               Shred
-----
NO             4

```

### Example: Display detailed shredding information

---

Display detailed information about data shredding on the server. See Field descriptions for field descriptions.

```
query shredstatus format=detailed
```

```

Shredding  Objects  Occupied  Data Left
Active     Awaiting  Space     To Shred

```

	Shred	(MB)	(MB)
NO	4	182	364

## Field descriptions

### Shredding Active

Indicates whether or not the server is actively shredding data at this time.

### Objects Awaiting Shred

The number of objects currently waiting to be shredded.

### Occupied Space (MB)

The amount of server storage space occupied by the objects currently waiting to be shredded, in megabytes. This is the amount of space that will become available when the objects are shredded.

### Data Left to Shred (MB)

The amount of data that still needs to be shredded.

## Related commands

Table 1. Commands related to QUERY SHREDSTATUS

Command	Description
BACKUP STGPOOL	Backs up a primary storage pool to a copy storage pool.
DEFINE STGPOOL	Defines a storage pool as a named collection of server storage media.
EXPORT NODE	Copies client node information to external media or directly to another server.
GENERATE BACKUPSET	Generates a backup set of a client's data.
GENERATE BACKUPSETTOC	Generates a table of contents for a backup set.
MOVE DATA	Moves data from a specified storage pool volume to another storage pool volume.
QUERY STGPOOL	Displays information about storage pools.
SETOPT	Updates a server option without stopping and restarting the server.
SHRED DATA	Manually starts the process of shredding deleted data.
UPDATE STGPOOL	Changes the attributes of a storage pool.

## QUERY SPACETRIGGER (Query the space triggers)

Use this command to display the settings for storage pool space triggers.

### Privilege class

Any administrator can issue this command.

### Syntax

```
>>-Query SPACETrigger--STG--+-----+----->
                               '-STGPOOL---storage_pool-'

.-Format---Standard-----
>--+-----+----->>
  '-Format---+Standard+-'
                               '-Detailed-'
```

### Parameters

STG

Specifies a storage pool space trigger.

STGPOOL

Specifies one or more storage pools (using a wildcard) for which storage pool trigger information will be displayed. If STG is specified but STGPOOL is not, the default storage pool space trigger, if any, is displayed.

Format

Specifies how the information is displayed. This parameter is optional. The default is STANDARD. Possible values are:

Standard

Specifies that partial information is displayed.

Detailed

Specifies that complete information is displayed.

## Example: Display detailed settings for a storage pool space trigger

Issue this command:

```
query spacetrigger stg stgpool=archivepool format=detailed
```

### AIX

```
STGPOOL Full Percentage: 50
STGPOOL Expansion Percentage: 20
STGPOOL Expansion prefix: /usr/tivoli/tsm/server/filevol/
STGPOOL: ARCHIVEPOOL
Last Update by (administrator): SERVER_CONSOLE
Last Update Date/Time: 05/10/2004 11:59:59
```

### Linux

```
STGPOOL Full Percentage: 50
STGPOOL Expansion Percentage: 20
STGPOOL Expansion prefix: /opt/tivoli/tsm/server/filevol/
STGPOOL: ARCHIVEPOOL
Last Update by (administrator): SERVER_CONSOLE
Last Update Date/Time: 05/10/2004 11:59:59
```

### Windows

```
STGPOOL Full Percentage: 50
STGPOOL Expansion Percentage: 20
STGPOOL Expansion prefix: c:\program files\tivoli\filevol\
STGPOOL: ARCHIVEPOOL
Last Update by (administrator): SERVER_CONSOLE
Last Update Date/Time: 05/10/2004 11:59:59
```

## Field descriptions

STGPOOL Full Percentage

The trigger utilization percentage at which IBM Spectrum Protect™ allocates more space for the storage pool.

STGPOOL Expansion Percentage

The percentage of space by which the storage pool should be expanded.

STGPOOL Expansion prefix

The prefix associated with the space trigger.

STGPOOL

The storage pool name associated with the query.

Last Update by (administrator)

The administrator who last updated the storage pool space trigger.

Last Update Date/Time

The date and time when the administrator last updated the storage pool space trigger.

## Related commands

Table 1. Commands related to QUERY SPACETRIGGER

Command	Description
DEFINE SPACETRIGGER	Defines a space trigger to expand the space for a storage pool.

Command	Description
DELETE SPACETRIGGER	Deletes the storage pool space trigger.
UPDATE SPACETRIGGER	Changes attributes of storage pool space trigger.

## QUERY STATUS (Query system parameters)

Use the QUERY STATUS command to display information about system parameters.

Use this command for the following reasons:

- To display the service level of the server
- To display information about the general server parameters, such as those defined by the SET commands
- To request information about client sessions, such as the availability of the server, password authentication, accounting settings, or the retention period for the information that is retained in the activity log
- To display information about the central scheduler, such as the central scheduling mode of the server
- To display the maximum number of repeated attempts that are allowed after a failed attempt to run a scheduled command
- To display whether subfiles can be backed up to this server, as indicated by the SET SUBFILE command
- To display information about a target replication server
- To display licensing information

Tip: To display information about a target replication server, you must issue the command from the target replication server.

### Privilege class

Any administrator can issue this command.

### Syntax

```
>>-Query SStatus-----<<
```

### Parameters

None.

### Example: Query the status of a configuration manager

Display general information about server parameters. The command is run from a configuration manager. For descriptions of displayed fields, see Field descriptions.

```
query status
```

**AIX**

```

                Server Name: SETSHOT
Server host name or IP address: setshot
  Server TCP/IP port number: 1500
        Crossdefine: On
      Server Password Set: Yes
Server Installation Date/Time: 2016-07-08, 09:45:53
  Server Restart Date/Time: 2016-10-10, 05:38:49
        Authentication: Off
Password Expiration Period: 9,999 Day(s)
Invalid Sign-on Attempt Limit: 0
      Minimum Password Length: 0
        Registration: Closed
      Subfile Backup: Client
        Availability: Enabled
Inbound Sessions Disabled:
Outbound Sessions Disabled:
        Accounting: Off
      Activity Log Retention: 30 Day(s)
Activity Log Number of Records: 222919
        Activity Log Size: 6 M

```

Activity Summary Retention Period: 30 Day(s)  
 License Audit Period: 30 Day(s)  
 Last License Audit: 2016-10-21, 07:40:20  
 Server License Compliance: Valid  
 Central Scheduler: Active  
 Maximum Sessions: 300  
 Maximum Scheduled Sessions: 75  
 Event Record Retention Period: 14 Day(s)  
 Client Action Duration: 5 Day(s)  
 Schedule Randomization Percentage: 25  
 Query Schedule Period: Client  
 Maximum Command Retries: Client  
 Retry Period: Client  
 Client-side Deduplication Verification Level: 0 %  
 Scheduling Modes: Any  
 Active Receivers: CONSOLE ACTLOG  
 Configuration manager?: Off  
 Refresh interval: 60  
 Last refresh date/time:  
 Context Messaging: On  
 Table of Contents (TOC) Load Retention: 120 Minute(s)  
 Machine Globally Unique ID: d4.cg.f6.ae.04.6e.11.e3.80.1f.00.21.5e.18.df.01  
 Archive Retention Protection: Off  
 Database Directories: /TSMserver/DB1,/TSMserver/DB2  
 Total Space of File System (MB): 222,720.00  
 Used Space on File System (MB): 47,780.74  
 Free Space Available (MB): 174,939.26  
 Encryption Strength: AES  
 Client CPU Information Refresh Interval: 180  
 Outbound Replication: Enabled  
 Target Replication Server: POWER  
 Default Replication Rule for Archive: ALL\_DATA  
 Default Replication Rule for Backup: ALL\_DATA  
 Default Replication Rule for Space Management: ALL\_DATA  
 Replication Record Retention Period: 30 Day(s)  
 LDAP User:  
 LDAP Password Set: No  
 Default Authentication: Local  
 Failover High Level Address:  
 Scratchpad retention: 365 Day(s)  
 Replication Recovery of Damaged Files: On  
 SUR Occupancy (TB): 5.66  
 SUR Occupancy Date/Time: 2016-10-10, 05:39:33  
 Front-End Capacity (MB): 226,331  
 Front-End Client Count: 6  
 Front-End Capacity Date: 2016-10-13, 09:20:02  
 Product Offering: IBM Spectrum Protect

Linux

Server Name: GOBI  
 Server host name or IP address:  
 Server TCP/IP port number: 1500  
 Crossdefine: On  
 Server Password Set: Yes  
 Server Installation Date/Time: 2016-07-08, 11:29:03  
 Server Restart Date/Time: 2016-11-10, 14:25:03  
 Authentication: On  
 Password Expiration Period: 90 Day(s)  
 Invalid Sign-on Attempt Limit: 0  
 Minimum Password Length: 0  
 Registration: Closed  
 Subfile Backup: No  
 Availability: Enabled  
 Inbound Sessions Disabled:  
 Outbound Sessions Disabled:  
 Accounting: Off  
 Activity Log Retention: 30 Day(s)  
 Activity Log Number of Records: 21346  
 Activity Log Size: <1 M  
 Activity Summary Retention Period: 30 Day(s)  
 License Audit Period: 30 Day(s)  
 Last License Audit: 2016-10-21, 23:27:23  
 Server License Compliance: Valid  
 Central Scheduler: Active

Maximum Sessions: 500  
 Maximum Scheduled Sessions: 250  
 Event Record Retention Period: 14 Day(s)  
 Client Action Duration: 5 Day(s)  
 Schedule Randomization Percentage: 25  
 Query Schedule Period: Client  
 Maximum Command Retries: Client  
 Retry Period: Client  
 Client-side Deduplication Verification Level: 0 %  
 Scheduling Modes: Any  
 Active Receivers: CONSOLE ACTLOG  
 Configuration manager?: Off  
 Refresh interval: 60  
 Last refresh date/time:  
 Context Messaging: Off  
 Table of Contents (TOC) Load Retention: 120 Minute(s)  
 Machine Globally Unique ID: fc.e7.be.58.4a.a7.11.e0.8a.c8.e4.1f.13.34.11.e0  
 Archive Retention Protection: Off  
 Database Directories:  
 /TSMdbspace1/gpcinst1,/TSMdbspace2/gpcinst1,/TSMdbspace3/gpcinst1  
 Total Space of File System (MB): 302,379.84  
 Used Space on File System (MB): 106,793.65  
 Free Space Available (MB): 195,586.20  
 Encryption Strength: AES  
 Client CPU Information Refresh Interval: 180  
 Outbound Replication: Enabled  
 Target Replication Server:  
 Default Replication Rule for Archive: ALL\_DATA  
 Default Replication Rule for Backup: ALL\_DATA  
 Default Replication Rule for Space Management: ALL\_DATA  
 Replication Record Retention Period: 30 Day(s)  
 LDAP User:  
 LDAP Password Set: No  
 Default Authentication: Local  
 Failover High Level Address:  
 Scratchpad retention: 365 Day(s)  
 Replication Recovery of Damaged Files: Off  
 SUR Occupancy (TB): 0.00  
 SUR Occupancy Date/Time: 2016-10-10, 14:25:35  
 Front-End Capacity (MB): 226,331  
 Front-End Client Count: 6  
 Front-End Capacity Date: 2016-10-13, 09:20:02  
 Product Offering: IBM Spectrum Protect

**Windows**

Server Name: EXCELSIOR  
 Server host name or IP address: excelsior.storage.  
 newyork.example.com  
 Server TCP/IP port number: 1500  
 Crossdefine: On  
 Server Password Set: Yes  
 Server Installation Date/Time: 2016-07-08, 18:02:50  
 Server Restart Date/Time: 2016-11-10, 11:48:32  
 Authentication: On  
 Password Expiration Period: 90 Day(s)  
 Invalid Sign-on Attempt Limit: 0  
 Minimum Password Length: 0  
 Registration: Closed  
 Subfile Backup: No  
 Availability: Enabled  
 Inbound Sessions Disabled:  
 Outbound Sessions Disabled:  
 Accounting: On  
 Activity Log Retention: 30 Day(s)  
 Activity Log Number of Records: 1346376  
 Activity Log Size: 37 M  
 Activity Summary Retention Period: 30 Day(s)  
 License Audit Period: 30 Day(s)  
 Last License Audit: 2016-10-21, 17:05:16  
 Server License Compliance: Valid  
 Central Scheduler: Active  
 Maximum Sessions: 25  
 Maximum Scheduled Sessions: 12

```

Event Record Retention Period: 14 Day(s)
Client Action Duration: 5 Day(s)
Schedule Randomization Percentage: 25
Query Schedule Period: Client
Maximum Command Retries: Client
Retry Period: Client
Client-side Deduplication Verification Level: 0 %
Scheduling Modes: Any
Active Receivers: CONSOLE ACTLOG
NTEVENTLOG
Configuration manager?: Off
Refresh interval: 60
Last refresh date/time:
Context Messaging: Off
Table of Contents (TOC) Load Retention: 120 Minute(s)
Machine Globally Unique ID: e9.3e.f1.70.ff.c5.11.e2.
a5.67.5c.f3.fc.0c.5e.60
Archive Retention Protection: Off
Database Directories: e:\Server1\TSMDBdir
Total Space of File System (MB): 102,270.00
Used Space on File System (MB): 22,032.79
Free Space Available (MB): 80,237.20
Encryption Strength: AES
Client CPU Information Refresh Interval: 180
Outbound Replication: Enabled
Target Replication Server: EXPLORER
Default Replication Rule for Archive: ALL_DATA
Default Replication Rule for Backup: ALL_DATA
Default Replication Rule for Space Management: ALL_DATA
Replication Record Retention Period: 30 Day(s)
LDAP User: cn=excelsior_ldapadmin,ou=excelsior,
ou=John Doe,dc=tsmadldap,dc=storage,
dc=newyork, dc=example,dc=com
LDAP Password Set: Yes
Default Authentication: LDAP
Failover High Level Address:
Scratchpad retention: 365 Day(s)
Replication Recovery of Damaged Files: On
SUR Occupancy (TB): 8.98
SUR Occupancy Date/Time: 2016-10-10, 11:49:27
Front-End Capacity (MB): 226,331
Front-End Client Count: 6

```

#### Windows

```

Front-End Capacity Date: 2016-10-13, 09:20:02
Product Offering: IBM Spectrum Protect

```

## Field descriptions

---

### Server Name

Specifies the name of the server.

### Server host name or IP address

Specifies the server TCP/IP address.

### Server TCP/IP port number

Specifies the server port address.

### Crossdefine

Specifies whether another server that is running the DEFINE SERVER command automatically defines itself to this server. See the SET CROSSDEFINE command.

### Server Password Set

Specifies whether the password was set for the server.

### Server Installation Date/Time

Specifies the date and time when the server was installed.

### Server Restart Date/Time

Specifies the last date and time when the server was started.

### Authentication

Specifies whether password authentication is set on or off.

### Password Expiration Period

Specifies the period, in days, after which the administrator or client node password expires.

### Invalid Sign-on Attempt Limit

Specifies the number of invalid sign-on attempts before a node is locked.

**Minimum Password Length**  
Specifies the minimum number of characters for the password.

**Registration**  
Specifies whether client node registration is open or closed.

**Subfile Backup**  
Specifies whether subfiles can be backed up to this server, as indicated by the SET SUBFILE command.

**Availability**  
Specifies whether the server is enabled or disabled.

**Inbound Sessions Disabled**  
Specifies the names of servers from which server-to-server communications are not allowed. To enable inbound server sessions, use the ENABLE SESSIONS command.

**Outbound Sessions Disabled**  
Specifies the names of servers to which server-to-server communications are not allowed. To enable outbound server sessions, use the ENABLE SESSIONS command.

**Accounting**  
Specifies whether an accounting record is generated at the end of each client node session.

**Activity Log Retention**  
Specifies the number of days information is retained in the activity log, or the size of the log.

**Activity Log Number of Records**  
Specifies the number of records in the activity log.

**Activity Log Size**  
Specifies the size of the activity log.

**Activity Summary Retention Period**  
Specifies the number of days information is retained in the SQL activity summary table.

**License Audit Period**  
Specifies the period, in days, after which the license manager automatically audits the IBM Spectrum Protect™ license. Additional licensing information is available by using the QUERY LICENSE command.

**Last License Audit**  
Specifies the date and time when the last license audit occurred. Additional licensing information is available by using the QUERY LICENSE command.

**Server License Compliance**  
Specifies whether the server is in compliance (Valid) or out of compliance (Failed) with the license terms. Use the QUERY LICENSE command to see what factors are causing the server to fail to comply with the license terms.

**Central Scheduler**  
Specifies whether central scheduling is running (active or inactive).

**Maximum Sessions**  
Specifies the maximum number of client/server sessions.

**Maximum Scheduled Sessions**  
Specifies the maximum number of client/server sessions available for processing scheduled work.

**Event Record Retention Period**  
Specifies the number of days central scheduler event records are retained.

**Client Action Duration**  
Specifies the duration of the period during which the client processes the schedule that is defined with the DEFINE CLIENTACTION command.

**Schedule Randomization Percentage**  
Specifies how much of the startup window is used for running scheduled events in client-polling mode.

**Query Schedule Period**  
Specifies the frequency with which clients poll the server to obtain scheduled work, in client-polling mode. If the value in this field is Client, the polling frequency is determined by the client node.

**Maximum Command Retries**  
Specifies the maximum number of times that a client scheduler tries to run a scheduled command after a failed attempt. If the value in this field is Client, the client node determines the maximum number.

**Retry Period**  
Specifies the number of minutes between failed attempts by the client scheduler to contact the server or to run a scheduled command. If the value in this field is Client, the client node determines the number of minutes.

**Client-side Deduplication Verification Level**  
Specifies a percentage of extents to be verified by the IBM Spectrum Protect server. The extents are created during client-side data deduplication.

**Scheduling Modes**  
Specifies the central scheduling modes that are supported by the server.

**Active Receivers**



Specifies the receivers for which event logging began.

**Configuration manager?**  
Specifies whether the server is a configuration manager.

**Refresh interval**  
Specifies the interval that elapses before the managed server requests a refresh of any changes from a configuration manager.

**Last refresh date/time**  
If the server is a managed server, specifies the date and time of the last successful refresh of configuration information from the configuration manager.

**Context Messaging**  
Specifies whether context messaging is enabled or disabled.

**Table of Contents (TOC) Load Retention**  
Specifies the approximate number of minutes that unreferenced TOC data is retained in the database.

**Machine Globally Unique ID**  
The globally unique identifier (GUID) as of the last time that the server was started. This GUID identifies the host system to which the current server belongs.

**Archive Retention Protection**  
Specifies whether archive data retention protection is activated or deactivated.

**Database Directories**  
Specifies the locations of the database directories.

**Total Space of File System (MB)**  
Specifies the total size of the file system.

**Used Space on File System (MB)**  
Specifies the amount of space that is in use on the file system.

**Free Space Available (MB)**  
Specifies the amount of space that is available.

**Encryption Strength**  
Indicates data encryption strength: AES or DES.

**Client CPU Information Refresh Interval**  
Specifies the number of days that elapse between client scans for CPU information that is used for PVU estimation.

**Outbound Replication**  
Specifies whether replication processing is enabled or disabled. If outbound replication is disabled, new replication processes cannot start on the server.

**Target Replication Server**  
Specifies the name of the server that is the target for node replication operations. If a target replication server does not exist, this field is blank.

**Default Replication Rule for Archive**  
Specifies the server replication rule that applies to archive data. The following values are possible:

**ALL\_DATA**  
Replicates archive data. The data is replicated with a normal priority.

**ALL\_DATA\_HIGH\_PRIORITY**  
Replicates archive data. The data is replicated with a high priority.

**NONE**  
Archive data is not replicated.

**Default Replication Rule for Backup**  
Specifies the server replication rule that applies to backup data. The following values are possible:

**ALL\_DATA**  
Replicates active and inactive backup data. The data is replicated with a normal priority.

**ACTIVE\_DATA**  
Replicates only active backup data. The data is replicated with a normal priority.  
Attention: If you specify ACTIVE\_DATA and one or more of the following conditions are true, inactive backup data on the target replication server is deleted, and inactive backup data on the source replication server is not replicated.

- When a server version earlier than Version 7.1.1 is installed on either the source or target replication servers.
- When you are using the REPLICATE NODE command with the `FORCERECONCILE=YES` parameter.
- When you are running the initial replication of a file space after you configure replication, restore the database, or upgrade both the source and target replication servers from a server version earlier than V7.1.1.

If the previous conditions are not true, all new and changed files since the last replication are replicated, including inactive files, and files are deleted when they expire.

#### ALL\_DATA\_HIGH\_PRIORITY

Replicates active and inactive backup data. The data is replicated with a high priority.

#### ACTIVE\_DATA\_HIGH\_PRIORITY

This rule is the same as the ACTIVE\_DATA replication rule except data is replicated with a high priority.

#### NONE

Backup data is not replicated.

#### Default Replication Rule for Space Management

Specifies the server replication rule that applies to space-managed data. The following values are possible:

#### ALL\_DATA

Replicates space-managed data. The data is replicated with a normal priority.

#### ALL\_DATA\_HIGH\_PRIORITY

Replicates space-managed data. The data is replicated with a high priority.

#### NONE

Space-managed data is not replicated.

#### Replication Record Retention Period

Specifies the number of days that replication history records are retained in the database of the source replication server.

#### LDAP User

Specifies the user ID that is named in the SET LDAPUSER command. This user ID can issue administrative commands on the namespace that is reserved for IBM Spectrum Protect on the LDAP directory server.

#### LDAP Password Set

This output field shows if a password is defined for the user ID that is named in the SET LDAPUSER command. The values are YES and NO. If YES, the user ID that is named in the SET LDAPUSER command can issue administrative commands on the LDAP namespace that is reserved for IBM Spectrum Protect. If NO, issue the SET LDAPPASSWORD command to set the password for the user ID that is named in the SET LDAPUSER command.

#### Default Authentication

Specifies the default password authentication method: LOCAL or LDAP.

Authentication Target	Authentication Method
IBM Spectrum Protect server	LOCAL
LDAP directory server	LDAP

When you issue the SET DEFAULTAUTHENTICATION command, you define the resulting authentication method for all REGISTER ADMIN and REGISTER NODE commands. The default is LOCAL.

#### Failover High Level Address

Specifies the high-level address for the failover server that is used by the client. Client restore operations fail over to this high-level address when the interface that is used by the client is different from the interface that is used by replication.

#### Scratchpad retention

Specifies the number of days for which scratch pad entries are retained since they were last updated.

#### Replication Recovery of Damaged Files

Specifies whether node replication is enabled to recover damaged files from a target replication server. This is a system-side setting. If ON is specified, the node replication process can be configured to detect damaged files on a source replication server and replace them with undamaged files from a target replication server. If OFF is specified, damaged files are not recovered from a target replication server.

#### SUR Occupancy (TB)

If you have an IBM Spectrum Protect Suite (SUR) license, this field specifies the SUR occupancy on the server. The *SUR occupancy* is the amount of space that is used to store data that is managed by the IBM Spectrum Protect products that are included in the SUR bundle.

#### SUR Occupancy Date/Time

Specifies the date and time when SUR occupancy data was last collected.

#### Front-End Capacity (MB)

Specifies the amount of primary data that is reported as being backed up by clients. Clients include applications, virtual machines, and systems. This value is used for the front-end licensing model.

#### Front-End Client Count

Specifies the number of clients that reported capacity usage based on the front-end licensing model.

#### Front-End Capacity Date

Specifies the date and time when front-end capacity data was last collected.

#### Product Offering

Specifies a product offering.

Value specified by the SET PRODUCTOFFERING command	Value shown in the QUERY STATUS command output
ENTry	IBM Spectrum Protect Entry
DATARet	IBM Spectrum Protect for Data Retention
BASIC	IBM Spectrum Protect
EE	IBM Spectrum Protect Extended Edition
SUIte	IBM Spectrum Protect Suite
SUITEEntry	IBM Spectrum Protect Suite Entry
SUITEArchive	IBM Spectrum Protect Suite - Archive
SUITEProtectier	IBM Spectrum Protect Suite - ProtecTier
SUITEFrontend	IBM Spectrum Protect Suite - FrontEnd
SUITEENTRYFrontend	IBM Spectrum Protect Suite Entry - FrontEnd
CLEAR	NULL

## Related commands

Table 1. Commands related to QUERY STATUS

Command	Description
BEGIN EVENTLOGGING	Starts event logging to a specified receiver.
DISABLE REPLICATION	Prevents outbound replication processing on a server.
DISABLE SESSIONS	Prevents new sessions from accessing IBM Spectrum Protect but permits existing sessions to continue.
ENABLE REPLICATION	Allows outbound replication processing on a server.
ENABLE SESSIONS	Resumes server activity following the DISABLE command or the ACCEPT DATE command.
END EVENTLOGGING	Ends event logging to a specified receiver.
QUERY LICENSE	Displays information about licenses and audits.
SET ACCOUNTING	Specifies whether accounting records are created at the end of each client session.
SET ACTLOGRETENTION	Specifies the number of days to retain log records in the activity log.
SET CONTEXTMESSAGING	Specifies to turn on context messaging to debug an ANR9999D message.
SET CPUINFOREFRESH	Specifies the number of days between client scans for workstation information used for PVU estimates.
SET CROSSDEFINE	Specifies whether to cross define servers.
SET DEDUPVERIFICATIONLEVEL	Specifies the percentage of extents verified by the server during client-side deduplication.
SET DEFAULTAUTHENTICATION	Specifies the default password authentication method for any REGISTER NODE or REGISTER ADMIN commands.
SET EVENTRETENTION	Specifies the number of days to retain records for scheduled operations.
SET LDAPPASSWORD	Sets the password for the LDAPUSER.
SET LDAPUSER	Sets the user who oversees the passwords and administrators on the LDAP directory server.
SET MAXCMDRETRIES	Specifies the maximum number of retries after a failed attempt to execute a scheduled command.

Command	Description
SET MAXSCHEDESESSIONS	Specifies the maximum number of client/server sessions available for processing scheduled work.
SET PASSEXP	Specifies the number of days after which a password is expired and must be changed.
SET PRODUCTOFFERING	Set the product offering licensed to your enterprise.
SET QUERYSCHEDPERIOD	Specifies the frequency for clients to obtain scheduled work, in client-polling mode.
SET RANDOMIZE	Specifies the randomization of start times within a window for schedules in client-polling mode.
SET REPLRECOVERDAMAGED	Specifies whether node replication is enabled to recover damaged files from a target replication server.
SET RETRYPERIOD	Specifies the time between retry attempts by the client scheduler.
SET SCHEDMODES	Specifies the central scheduling mode for the server.
SET SERVERHLADDRESS	Specifies the high-level address of a server.
SET SERVERLLADDRESS	Specifies the low-level address of a server.
SET SERVERNAME	Specifies the name by which the server is identified.
SET SERVERPASSWORD	Specifies the server password.
SET SUMMARYRETENTION	Specifies the number of days to retain information for the activity summary table.
SET TOCLOADRETENTION	Specifies the number of minutes to retain information for unreferenced TOC sets.

## QUERY STATUSTHRESHOLD (Query status monitoring thresholds)

Use this command to display information about status monitoring thresholds.

Status monitoring thresholds compare the defined conditions to the status monitoring server queries and inserts the results in the status monitoring table.

Multiple thresholds can be defined for an activity. For example, you can create a threshold that provides a warning status if storage pool capacity utilization is greater than 80%. You can then create another threshold that provides error status if storage pool capacity utilization is greater than 90%.

Note: If a threshold is already defined for an EXISTS condition, you cannot define another threshold with one of the other condition types.

### Privilege class

Any administrator can issue this command.

### Syntax

```

      .-*-----
>>-Query STAtusthreshold--+-+----->
      '-threshold_name-'

      .-Format----Standard----.
>--+-+----->
      '-Format----+Standard+-' '-Activity----activity-'
      '-Detailed-'

>--+-+----->
      '-Condition----+EXists+-' '-Value----value_name-'

```



ACTIVELOGCHECK	ACTIVE LOG UTILIZATION (%)	>	90	ERROR
AVGSTGPLW	AVERAGE STORAGE POOL UTILIZATION (%)	>	85	WARNING
AVGSTGPLE	AVERAGE STORAGE POOL UTILIZATION (%)	>	90	ERROR

## Query status thresholds and display detailed format

Query status thresholds and display the output in detailed format, by issuing the following command:

```
query statusthreshold f=d
```

```
Threshold Name: ACTIVELOGCHECK
Activity Name: ACTIVE LOG UTILIZATION (%)
Condition Name: >
Value: 90
Report Status: ERROR
Server Name: TSMAMP24
```

```
Threshold Name: AVGSTGPLW
Activity Name: AVERAGE STORAGE POOL UTILIZATION (%)
Condition Name: >
Value: 85
Report Status: WARNING
Server Name: TSMAMP24
```

```
Threshold Name: AVGSTGPLE
Activity Name: AVERAGE STORAGE POOL UTILIZATION (%)
Condition Name: >
Value: 95
Report Status: ERROR
Server Name: TSMAMP24
```

## Related commands

Table 1. Commands related to QUERY STATUSTHRESHOLD

Command	Description
DEFINE STATUSTHRESHOLD (Define a status monitoring threshold)	Defines a status monitoring threshold.
DELETE STATUSTHRESHOLD (Delete a status monitoring threshold)	Deletes a status monitoring threshold.
QUERY MONITORSTATUS (Query the monitoring status)	Displays information about monitoring alerts and server status settings.
QUERY MONITORSETTINGS (Query the configuration settings for monitoring alerts and server status)	Displays information about monitoring alerts and server status settings.
SET STATUSATRISKINTERVAL (Specifies whether to enable client at-risk activity interval evaluation)	Specifies whether to enable client at-risk activity interval evaluation
SET STATUSMONITOR (Specifies whether to enable status monitoring)	Specifies whether to enable status monitoring.
SET STATUSREFRESHINTERVAL (Set refresh interval for status monitoring)	Specifies the refresh interval for status monitoring.
SET STATUSSKIPASFAILURE (Specifies whether to use client at-risk skipped files as failure evaluation)	Specifies whether to use client at-risk skipped files as failure evaluation
UPDATE STATUSTHRESHOLD (Update a status monitoring threshold)	Changes the attributes of an existing status monitoring threshold.

# QUERY STGPOOL (Query storage pools)

Use this command to display information about one or more storage pools. You can also use this command to monitor migration processes for storage pools.

## Privilege class

Any administrator can issue this command.

## Syntax

```
.*----- .-Format----Standard----.
>>-Query STGpool-+-----+-----+----->
                    '-pool_name-' '-Format----+Standard+-'
                                     '-Detailed-'

.-Pooltype----ANY-----
>+-----+-----+----->>
  '-Pooltype----+ANY-----+'
                    +-Primary-----+
                    +-Copy-----+
                    +-COPYCONTAINER-+
                    '-ACTIVEdata----'
```

## Parameters

### pool\_name

Specifies the storage pool to query. This parameter is optional. You can use wildcard characters to specify this name. If you do not specify a value for this parameter, all storage pools are displayed.

### Format

Specifies how the information is displayed. This parameter is optional. The default value is STANDARD. Specify one of the following values:

#### Standard

Specifies that partial information is displayed.

#### Detailed

Specifies that complete information is displayed.

### Pooltype

Specifies the type of storage pool to query. This parameter is optional. The default value is ANY. Specify one of the following values:

#### ANY

Query primary storage pools, copy storage pools, and active-data pools.

#### Primary

Query only primary storage pools.

#### Copy

Query only copy storage pools.

#### COPYCONTAINER

Query only container-copy storage pools.

#### ACTIVEdata

Query only active-data storage pools.

## Example: Display detailed random-access disk storage pool information

Tip: In the examples of detailed output, some fields are blank because the item does not apply in the specified environment. Display details for a storage pool that is named DISKPOOL. See Field descriptions for field descriptions.

```
query stgpool diskpool format=detailed
```

```
Storage Pool Name: DISKPOOL
Storage Pool Type: Primary
Device Class Name: DISK
```

```

Storage Type: DEVCLASS
Cloud Type:
Cloud URL:
Cloud Identity:
Cloud Location:
Estimated Capacity: 66 G
Space Trigger Util: 0.0
Pct Util: 0.0
Pct Migr: 3.1
Pct Logical: 100.0
High Mig Pct: 90
Low Mig Pct: 70
Migration Delay: 0
Migration Continue: Yes
Migration Processes: 1
Reclamation Processes: 1
Next Storage Pool:
Reclaim Storage Pool:
Maximum Size Threshold: No Limit
Access: Read/Write
Description:
Overflow Location:
Cache Migrated Files?:
Collocate?: Group
Reclamation Threshold: 60
Offsite Reclamation Limit:
Maximum Scratch Volumes Allowed: 32
Number of Scratch Volumes Used: 1
Delay Period for Container Reuse: 1 Day(s)
Migration in Progress?: No
Amount Migrated (MB): 0.00
Elapsed Migration Time (seconds): 0
Reclamation in Progress?: No

Last Update by (administrator): SERVER_CONSOLE
Last Update Date/Time: 01/03/2014 13:57:16
Storage Pool Data Format: Native
Copy Storage Pool(s):
Active Data Pool(s):
Continue Copy on Error?: No
CRC Data: Yes
Reclamation Type: Threshold
Overwrite Data when Deleted: 2 Time(s)
Deduplicate Data?: No
Processes For Identifying Duplicates:
Compressed:
Deduplication Savings:
Compression Savings:
Total Space Saved:
Auto-copy Mode: Client
Contains Data Deduplicated by Client?: No
Maximum Simultaneous Writers:
Protect Processes:
Protection Storage Pool:
Protect Local Storage Pool(s):
Reclamation Volume Limit:

Date of Last Protection to Remote Pool:
Date of Last Protection to Local Pool:
Deduplicate Requires Backup?:
Encrypted:
Pct Encrypted:
Cloud Space Utilized (MB):
Bucket Name:
Local Estimated Capacity:
Local Pct Util:
Local Pct Logical:

```

## Example: Display detailed sequential-access disk storage pool information

---

Display details for a storage pool that is named FILEPOOL. See Field descriptions for field descriptions.

```
query stgpool filepool format=detailed
```



```

Storage Pool Name: FILEPOOL
Storage Pool Type: Primary
Device Class Name: FILEC
Storage Type: DEVCLASS
Cloud Type:
Cloud URL:
Cloud Identity:
Cloud Location:
Estimated Capacity: 66 G
Space Trigger Util: 0.0
Pct Util: 0.0
Pct Migr: 3.1
Pct Logical: 100.0
High Mig Pct: 90
Low Mig Pct: 70
Migration Delay: 0
Migration Continue: Yes
Migration Processes: 1
Reclamation Processes: 1
Next Storage Pool:
Reclaim Storage Pool:
Maximum Size Threshold: No Limit
Access: Read/Write
Description:
Overflow Location:
Cache Migrated Files?:
Collocate?: Group
Reclamation Threshold: 60
Offsite Reclamation Limit:
Maximum Scratch Volumes Allowed: 32
Number of Scratch Volumes Used: 1
Delay Period for Container Reuse: 1 Day(s)
Migration in Progress?: No
Amount Migrated (MB): 0.00

Elapsed Migration Time (seconds): 0
Reclamation in Progress?: No
Last Update by (administrator): SERVER_CONSOLE
Last Update Date/Time: 01/02/2014 13:57:16
Storage Pool Data Format: Native
Copy Storage Pool(s):
Active Data Pool(s):
Continue Copy on Error?: No
CRC Data: Yes
Reclamation Type: Threshold
Overwrite Data when Deleted:
Deduplicate Data?: Yes
Processes For Identifying Duplicates: 1
Compressed:
Deduplication Savings: 65,396 K (49.99%)
Compression Savings:
Total Space Saved: 65,396 K (49.99%)
Auto-copy Mode: Client
Contains Data deduplicated by Client?: Yes
Maximum Simultaneous Writers:
Protect Processes:
Protection Storage Pool:
Protect Local Storage Pool(s):
Reclamation Volume Limit:
Date of Last Protection to Remote Pool:
Date of Last Protection to Local Pool:
Deduplicate Requires Backup?:
Encrypted:
Pct Encrypted:
Cloud Space Utilized (MB):
Bucket Name:
Local Estimated Capacity:
Local Pct Util:
Local Pct Logical:

```

## Example: Display detailed sequential storage pool information

---

Display details for an active-data sequential storage pool that is named FILEPOOL that uses a FILE type device class. See Field descriptions for field descriptions.

```
query stgpool filepool format=detailed
```

```
Storage Pool Name: FILEPOOL
Storage Pool Type: Active-data
Device Class Name: FILEC
Storage Type: DEVCLASS
Cloud Type:
Cloud URL:
Cloud Identity:
Cloud Location:
Estimated Capacity: 0.0 M
Space Trigger Util: 0.0
Pct Util: 0.0
Pct Migr: 0.0
Pct Logical: 0.0
High Mig Pct: 90
Low Mig Pct: 70
Migration Delay: 0
Migration Continue: Yes
Migration Processes: 1
Reclamation Processes: 1
Next Storage Pool:
Reclaim Storage Pool:
Maximum Size Threshold: No Limit
Access: Read/Write
Description:
Overflow Location:
Cache Migrated Files?:
Collocate?: Group
Reclamation Threshold: 60
Offsite Reclamation Limit:
Maximum Scratch Volumes Allowed: 99
Number of Scratch Volumes Used: 0
Delay Period for Container Reuse: 1 Day(s)
Migration in Progress?: No
Amount Migrated (MB): 0.00

Elapsed Migration Time (seconds): 0
Reclamation in Progress?: No
Last Update by (administrator): SERVER_CONSOLE
Last Update Date/Time: 01/02/2014 11:37:57
Storage Pool Data Format: Native
Copy Storage Pool(s):
Active Data Pool(s):
Continue Copy on Error?:
CRC Data: Yes
Reclamation Type: Threshold
Overwrite Data when Deleted:
Deduplicate Data?: Yes
Processes For Identifying Duplicates: 1
Compressed:
Deduplication Savings: 65,396 K (49.99%)
Compression Savings:
Total Space Saved: 65,396 K (49.99%)
Auto-copy Mode:
Contains Data Deduplicated by Client?: No
Maximum Simultaneous Writers:
Protect Processes:
Protection Storage Pool:
Protect Local Storage Pool(s):
Reclamation Volume Limit:
Date of Last Protection to Remote Pool:
Date of Last Protection to Local Pool:
Deduplicate Requires Backup?:
Encrypted:
Pct Encrypted:
Cloud Space Utilized (MB):
Bucket Name:
Local Estimated Capacity:
Local Pct Util:
Local Pct Logical:
```

## Example: Display summary information for a specific storage pool

Display information for a storage pool that is named POOL1. See Field descriptions for field descriptions.

```
query stgpool pool1
```

Storage Pool Name	Device Class Name	Estimated Capacity	Pct Util	Pct Migr	High Mig Pct	Low Mig Pct	Next Storage Pool
POOL1	DISK	58.5 M	0.8	0.7	90	70	POOL2

## Example: Display detailed 8 mm tape storage pool information

Display details for the storage pool named 8MMPPOOL. See Field descriptions for field descriptions.

```
query stgpool 8mmpool format=detailed
```

```
Storage Pool Name: 8MMPPOOL
Storage Pool Type: Primary
Device Class Name: 8MMTAPE
Storage Type: DEVCLASS
Cloud Type:
Cloud URL:
Cloud Identity:
Cloud Location:
Estimated Capacity: 0.0 M
Space Trigger Util: 0.0
Pct Util: 0.0
Pct Migr:
Pct Logical: 0.0
High Mig Pct: 90
Low Mig Pct: 70
Migration Delay: 0
Migration Continue: Yes
Migration Processes: 1
Reclamation Processes: 1
Next Storage Pool:
Reclaim Storage Pool:
Maximum Size Threshold: 5 M
Access: Read/Write
Description: Main storage pool
Overflow Location: Room1234/Bldg31
Cache Migrated Files?:
Collocate?: No
Reclamation Threshold: 60
Offsite Reclamation Limit:
Maximum Scratch Volumes Allowed: 5
Number of Scratch Volumes Used: 3
Delay Period for Container Reuse: 1 Day(s)
Migration in Progress?: No
Amount Migrated (MB): 0.00

Elapsed Migration Time (seconds): 0
Reclamation in Progress?: No
Last Update by (administrator): ADMIN
Last Update Date/Time: 01/08/2014 06:55:45
Storage Pool Data Format: Native
Copy Storage Pool(s): COPYPOOL1
Active Data Pool(s): ACTIVEPOOL1 ACTIVEPOOL2
Continue Copy on Error?: Yes
CRC Data: Yes
Reclamation Type: Threshold
Overwrite Data when Deleted:
Deduplicate Data?: No
Processes For Identifying Duplicates:
Compressed:
Deduplication Savings:
Compression Savings:
Total Space Saved:
Compressed: No
Deduplication Savings:
Compression Savings:
```

```

Total Space Saved:
  Auto-copy Mode: Client
Contains Data Deduplicated by Client?: No
  Maximum Simultaneous Writers:
  Protect Processes:
  Protection Storage Pool:
Protect Local Storage Pool(s):
  Reclamation Volume Limit:

Date of Last Protection to Remote Pool:
Date of Last Protection to Local Pool:
  Deduplicate Requires Backup?:
  Encrypted:
  Pct Encrypted:
Cloud Space Utilized (MB):
  Bucket Name:
Local Estimated Capacity:
  Local Pct Util:
  Local Pct Logical:

```

## Example: Display detailed NAS2CLASS storage pool information

---

Display details for a storage pool, NAS2LIBPOOL. When you set up this storage pool, you set the data format to NETAPPDUMP. See Field descriptions for field descriptions.

```

query stgpool nas2libpool format=detailed

Storage Pool Name: NAS2
Storage Pool Name: NAS2LIBPOOL
Storage Pool Type: Primary
Device Class Name: NAS2CLASS
  Storage Type: DEVCLASS
  Cloud Type:
  Cloud URL:
  Cloud Identity:
  Cloud Location:
Estimated Capacity: 0.0 M
Space Trigger Util:
  Pct Util: 0.0
  Pct Migr:
  Pct Logical: 0.0
  High Mig Pct:
  Low Mig Pct:
Migration Delay:
Migration Continue:
Migration Processes:
Reclamation Processes:
  Next Storage Pool:
  Reclaim Storage Pool:
Maximum Size Threshold:
  Access: Read/Write
  Description:
  Overflow Location:
Cache Migrated Files?:
  Collocate?: Group
Reclamation Threshold:
Offsite Reclamation Limit:
Maximum Scratch Volumes Allowed: 50
Number of Scratch Volumes Used: 0
Delay Period for Container Reuse: 1 Day(s)
Migration in Progress?:
  Amount Migrated (MB):

Elapsed Migration Time (seconds):
  Reclamation in Progress?:
Last Update by (administrator): SERVER_CONSOLE
  Last Update Date/Time: 01/02/2014 16:24:43
Storage Pool Data Format: NetApp Dump
  Copy Storage Pool(s):
  Active Data Pool(s):
Continue Copy on Error?: No
  CRC Data: No
  Reclamation Type:

```

```

    Overwrite Data when Deleted:
      Deduplicate Data?: No
    Processes For Identifying Duplicates:
      Compressed:
      Deduplication Savings:
      Compression Savings:
      Total Space Saved:
      Auto-copy Mode: Client
    Contains Data Deduplicated by Client?: No
      Maximum Simultaneous Writers:
      Protect Processes:
      Protection Storage Pool:
    Protect Local Storage Pool(s):
      Reclamation Volume Limit:

    Date of Last Protection to Remote Pool:
    Date of Last Protection to Local Pool:
      Deduplicate Requires Backup?:
      Encrypted:
      Pct Encrypted:
    Cloud Space Utilized (MB):
      Bucket Name:
    Local Estimated Capacity:
      Local Pct Util:
      Local Pct Logical:

```

## Example: Display detailed information for a directory-container storage pool that is used for data deduplication

---

Display details for a directory-container storage pool, DPOOL1. See Field descriptions for field descriptions.

```
query stgpool dpool1 format=detailed
```

```

    Storage Pool Name: DPOOL1
    Storage Pool Type: Primary
    Device Class Name:
      Storage Type: Directory
      Cloud Type:
      Cloud URL:
      Cloud Identity:
      Cloud Location:
    Estimated Capacity: 798 G
    Space Trigger Util:
      Pct Util: 3.4
      Pct Migr:
      Pct Logical: 100.0
      High Mig Pct:
      Low Mig Pct:
    Migration Delay:
    Migration Continue:
    Migration Processes:
    Reclamation Processes:
      Next Storage Pool:
      Reclaim Storage Pool:
    Maximum Size Threshold: No Limit
      Access: Read/Write
    Description:
      Overflow Location:
    Cache Migrated Files?:
      Collocate?:
    Reclamation Threshold:
    Offsite Reclamation Limit:
    Maximum Scratch Volumes Allowed:
    Number of Scratch Volumes Used:
    Delay Period for Container Reuse: 1 Day(s)
    Migration in Progress?:
      Amount Migrated (MB):

    Elapsed Migration Time (seconds):
      Reclamation in Progress?:
    Last Update by (administrator): SERVER_CONSOLE
      Last Update Date/Time: 01/02/2014 16:24:43

```

```

Storage Pool Data Format: Native
  Copy Storage Pool(s):
  Active Data Pool(s):
  Continue Copy on Error?:
    CRC Data: No
    Reclamation Type:
  Overwrite Data when Deleted:
    Deduplicate Data?: Yes
Processes For Identifying Duplicates:
  Compressed: Yes
Space Used for Protected Data: 1,599 M
  Total Pending Space: 100 M
  Deduplication Savings: 1,331 M (67.56%)
  Compression Savings: 194,805 K (29.82%)
  Total Space Saved: 1,521 M (77.22%)
  Auto-copy Mode:
Contains Data Deduplicated by Client?:
  Maximum Simultaneous Writers: No Limit
  Protect Processes:
  Protection Storage Pool: DPOOL2
Protect Local Storage Pool(s):
  Reclamation Volume Limit:

Date of Last Protection to Remote Pool:
Date of Last Protection to Local Pool:
  Deduplicate Requires Backup?:
    Encrypted:
    Pct Encrypted: 34.56%
Cloud Space Utilized (MB):
  Bucket Name:
Local Estimated Capacity:
  Local Pct Util:
  Local Pct Logical:

```

## Example: Display detailed information for a cloud-container storage pool that is used for data deduplication

---

Display details for a cloud container storage pool, CPOOL1. See Field descriptions for field descriptions.

```

query stgpool cpool1 format=detailed

Storage Pool Name: CPOOL1
Storage Pool Type: Primary
Device Class Name:
  Storage Type: CLOUD
  Cloud Type: SWIFT
  Cloud URL: http://localhost.local
  Cloud Identity: Bailey
  Cloud Location: ONPREMISE
Estimated Capacity:
Space Trigger Util:
  Pct Util:
  Pct Migr:
  Pct Logical: 0.0
  High Mig Pct:
  Low Mig Pct:
  Migration Delay:
  Migration Continue:
  Migration Processes:
  Reclamation Processes:
  Next Storage Pool:
  Reclaim Storage Pool:
Maximum Size Threshold: No Limit
  Access: Read/Write
  Description:
  Overflow Location:
  Cache Migrated Files?:
  Collocate?:
  Reclamation Threshold:
Offsite Reclamation Limit:
Maximum Scratch Volumes Allowed:
Number of Scratch Volumes Used:

```

```

    Delay Period for Volume Reuse: 1
    Migration in Progress?:
    Amount Migrated (MB):

Elapsed Migration Time (seconds):
    Reclamation in Progress?:
    Last Update by (administrator): CODY
    Last Update Date/Time: 2015-05-28, 10:47:52
    Storage Pool Data Format: Native
    Copy Storage Pool(s):
    Active Data Pool(s):
    Continue Copy on Error?:
    CRC Data: No
    Reclamation Type:
    Overwrite Data when Deleted:
    Deduplicate Data?: Yes
    Processes For Identifying Duplicates:
    Compressed: Yes
    Deduplication Savings: 9,241 K (89.76%)
    Compression Savings: 1,033 K (98.81%)
    Total Space Saved: 10,274 K (99.79%)
    Auto-copy Mode:
    Contains Data Deduplicated by Client?:
    Maximum Simultaneous Writers: No Limit
    Protect Processes:
    Protection Storage Pool:
    Protect Local Storage Pool(s):
    Reclamation Volume Limit:
    Date of Last Protection to Remote Pool:
    Date of Last Protection to Local Pool:
    Deduplicate Requires Backup?:
    Encrypted: Yes
    Pct Encrypted: 34.56%
    Cloud Space Utilized (MB): 4,231
    Bucket Name: ibmsp.
    C8ae4ec058cf11e680fe0a270000000
    Local Estimated Capacity: 168 G
    Local Pct Util: 0.1
    Local Pct Logical: 100.0

```

## Field descriptions

---

### Storage Pool Name

The name of the storage pool.

### Storage Pool Type

The type of storage pool.

### Device Class Name

The name of the device class that is assigned to the storage pool.

### Storage Type

The type of storage that is defined for the storage pool. The following storage types can be shown:

#### DEVCLASS

The storage pool specifies a device class, which determines the type of device where data is stored.

#### DIRECTORY

The storage pool creates logical containers for data in file system directories.

#### CLOUD

The storage pool creates logical containers for data in a cloud environment.

### Cloud Type

For cloud storage pools, the type of cloud platform.

### Cloud URL

For cloud storage pools, the URL for accessing the on-premises private cloud or off-premises public cloud.

### Cloud Identity

For cloud storage pools, the user ID for accessing the on-premises private cloud or off-premises public cloud.

### Cloud Location

For cloud storage pools, indicates whether the cloud is an on-premises private cloud or off-premises public cloud.

### Estimated Capacity

The estimated capacity of the storage pool in megabytes (M) or gigabytes (G).

For DISK devices, estimated capacity is the capacity of all volumes in the storage pool, including any volumes that are varied offline.

For sequential-access storage pools, estimated capacity is the total estimated space of all the sequential-access volumes in the storage pool, regardless of their access mode. At least one volume must be used in a sequential-access storage pool (either a scratch volume or a private volume) to calculate estimated capacity.

For tape and FILE devices, the estimated capacity for the storage pool includes the following factors:

- The capacity of all the scratch volumes that the storage pool already acquired or can acquire. The number of scratch volumes is defined by the MAXSCRATCH parameter on the DEFINE STGPOOL or UPDATE STGPOOL command.
- The total number of available scratch volumes in the tape library.
- Estimated capacity is the smaller number between the MAXSCRATCH value and the total number of available scratch volumes in the tape library.

The calculations for estimated capacity depend on the available space of the storage for the device that is assigned to the storage pool. For FILE storage pools, the capacity for the storage pool is reduced if the available storage is less than the total estimated space of all the FILE volumes in the storage pool. The value that is displayed for capacity is reduced by the size of a FILE volume incrementally as the available space continues to decline.

For Centera, value represents the total capacity of the Centera storage device that is being queried.

#### Space Trigger Util

Utilization of the storage pool, as calculated by the storage pool space trigger, if any, for this storage pool. You can define space triggers for storage pools that are associated with DISK or FILE device types only.

For sequential access devices, space trigger utilization is expressed as follows as a percentage of the number of used bytes on each sequential access volume relative to the size of the volume and estimated capacity of all existing volumes in the storage pool. It does not include potential scratch volumes. Unlike the calculation for percent utilization, the calculation for space trigger utilization favors creation of new private file volumes by the space trigger over usage of more scratch volumes.

For disk devices, space trigger utilization is expressed as a percentage of the estimated capacity, including cached data. However, it excludes data that is on any volumes that are varied offline. The value for space trigger utilization can be higher than the value for percent migration if you issue QUERY STGPOOL while a file creation is in progress. The value for space trigger utilization is determined by the amount of space that is allocated while the transaction is in progress. The value for percent migration represents only the space that is occupied by committed files. At the end of the transaction, these values are synchronized.

The value for space trigger utilization includes cached data on disk volumes. Therefore, when cache is enabled and migration occurs, the value remains the same because the migrated data remains on the volume as cached data. The value decreases only when the cached data expires or when the space that cached files occupy must be used for noncached files.

#### Pct Util

An estimate of the utilization of the storage pool, as a percentage.

For sequential access devices, it is a percentage of the number of active bytes on each sequential access volume and the estimated capacity of all volumes in the storage pool. The percentage includes the number of potential scratch volumes that might be allocated.

For disk devices, it is a percentage of the estimated capacity, including cached data and data that is on any volumes that are varied offline. The value for Pct Util can be higher than the value for Pct Migr if you issue this command while a file creation transaction is in progress. The value for Pct Util is determined by the amount of space that is allocated, while the transaction is in progress. The value for Pct Migr represents only the space that is occupied by committed files. At the end of the transaction, these values become synchronized.

The Pct Util value includes cached data on disk volumes. Therefore, when cache is enabled and migration occurs, the Pct Util value remains the same because the migrated data remains on the volume as cached data. The Pct Util value decreases only when the cached data expires or when the space that cached files occupy must be used for noncached files.

For Centera, this represents an estimate of the utilization of the entire Centera storage device, not the storage pool that is being queried.

#### Pct Migr (primary storage pools only)



An estimate of the percentage of data in the storage pool that can be migrated. The server uses this value and the high and low migration thresholds to determine when to start and stop migration.

For random-access disk devices, this value is specified as a percentage of the value for the estimated capacity, excluding cached data, but including data on any volumes varied offline.

For sequential-access disk devices, this value is specified as a percentage of the value for the estimated capacity. The value includes the capacity of all the scratch volumes that are specified for the pool. For other types of sequential-access devices, this value is the percentage of the total number of volumes in the pool that contain at least one byte of active data. The total number of volumes includes the maximum number of scratch volumes.

The Pct Util value includes cached data on a volume; the Pct Migr value excludes cached data. Therefore, when cache is enabled and migration occurs, the Pct Migr value decreases but the Pct Util value remains the same because the migrated data remains on the volume as cached data. The Pct Util value decreases only when the cached data expires or when the space that cached files occupy must be used for noncached files.

#### Pct Logical

The logical occupancy of the storage pool as a percentage of the total occupancy. Logical occupancy is space that is occupied by client files that might or might not be part of an aggregate. A Pct Logical value less than 100% indicates that there is vacant space within aggregates in the storage pool.

#### High Mig Pct (primary storage pools only)

The high migration threshold, which specifies when the server can begin migration for the storage pool. The server starts migration processes when capacity utilization reaches this threshold.

#### Low Mig Pct (primary storage pools only)

The low migration threshold, which specifies when the server can stop migration for the storage pool. The server stops migration processes when capacity utilization reaches this threshold.

#### Migration Delay (primary storage pools only)

The minimum number of days that a file must remain in a storage pool before the server can migrate the file to the next storage pool. For a disk storage pool, the days are counted from the time that the file was stored in the storage pool or last retrieved by a client. For a sequential access storage pool, the days are counted from the time that the file was stored in the storage pool.

#### Migration Continue (primary storage pools only)

Whether the server continues to migrate files to the next storage pool even if the files have not been in the pool for the number of days that are specified by the migration delay.

#### Migration Processes

The number of parallel processes that are used for migrating files from a random or sequential access primary storage pool.

#### Reclamation Processes

The number of parallel processes that are used for reclaiming the volumes in a sequential access primary or copy storage pool.

#### Next Storage Pool (primary storage pools only)

The storage pool that is the destination for data that is migrated from this storage pool.

#### Reclaim Storage Pool (primary, sequential access storage pools only)

If specified, the storage pool that is the destination for data that is moved from volumes during reclamation processing. If no pool is specified, by default reclamation processing moves data only among volumes within the same storage pool.

#### Maximum Size Threshold (primary storage pools only)

The maximum size of files that might be stored in the storage pool.

#### Access

The access mode for data in the storage pool. The following access modes are possible:

##### Read/Write

The data can be accessed in read-write mode.

##### Read only

The data can be accessed in read-only mode.

##### Converting

The storage pool is being converted to a directory-container storage pool.

##### Conversion Stopped

The process of converting the storage pool to a directory-container storage pool is stopped.

##### Conversion Cleanup Needed

To convert the storage pool successfully, you must clean up the storage pool. Conversion could not complete because of damaged data. Issue the QUERY CLEANUP command to identify damaged files.

##### Converted

The storage pool is converted to a directory-container storage pool.

## Description

The description of the storage pool.

## Overflow Location (sequential access storage pools only)

The location where volumes in the storage pool are stored when they are ejected from an automated library with the MOVE MEDIA command.

## Cache Migrated Files? (random access storage pools only)

Whether caching is enabled for files that are migrated to the next storage pool.

## Collocate? (sequential access storage pools only)

Whether collocation is disabled or enabled. If collocation is disabled, the value of this field is No. If collocation is enabled, the possible values are Group, Node, and File space.

## Reclamation Threshold (sequential access storage pools only)

The threshold that determines when volumes in a storage pool are reclaimed. The server compares the percentage of reclaimable space on a volume to this value to determine whether reclamation is necessary.

## Offsite Reclamation Limit

The number of offsite volumes that have space that is reclaimed during reclamation for this storage pool. This field applies only when POOLTYPE=COPY.

## Maximum Scratch Volumes Allowed (sequential access storage pools only)

The maximum number of scratch volumes that the server can request for the storage pool.

## Number of Scratch Volumes Used (sequential access storage pools only)

The number of scratch volumes that are used in the storage pool.

## Delay Period for Container Reuse (container storage pools only)

The number of days that must elapse after all files are deleted from a container before the server reuses the container.

## Migration in Progress? (primary storage pools only)

Whether at least one migration process is active for the storage pool.

## Amount Migrated (MB) (primary storage pools only)

The amount of data, in megabytes, that is migrated, if migration is in progress. If migration is not in progress, this value indicates the amount of data that was migrated during the last migration. When multiple, parallel migration processes are used for the storage pool, this value indicates the total amount of data that is migrated by all processes.

## Elapsed Migration Time (seconds) (primary storage pools only)

The amount of time that elapsed since migration began, if migration is active. If migration is not active, this value indicates the amount of time that is required to complete the last migration. When multiple, parallel migration processes are used for the storage pool, this value indicates the total time from the beginning of the first process until the completion of the last process.

## Reclamation in Progress? (sequential access storage pools only)

Whether a reclamation process is active for the storage pool.

## Last Update by (administrator)

The name of the administrator that is defined or most recently updated the storage pool.

## Last Update Date/Time

The date and time that an administrator defined or most recently updated the storage pool.

## Storage Pool Data Format

The type of data format that is used to write data to this storage pool (for example NATIVE, NETAPPDUMP, CELERRADUMP, or NDMPDUMP).

## Copy Storage Pool(s)

The copy storage pools that are listed have data that is simultaneously written to them when data is backed up or archived to the primary storage pool queried by this command.

## Active Data Pool(s)

The active-data pools that are listed here have data that is simultaneously written to them when data is backed up to the primary storage pool queried by this command.

## Continue Copy on Error?

Whether a server continues to write data to other copy storage pools in the list or ends the entire transaction when a write failure occurs to one of the copy pools in the list. This field applies only to primary random-access and primary sequential-access storage pools.

## CRC Data

Whether data is validated by a cyclic redundancy check (CRC) when data is transferred during data storage and retrieval on a device.

## Reclamation Type

Whether volumes in this storage pool are reclaimed by threshold or by SnapLock retention date.

## Overwrite Data when Deleted

The number of times data will be physically overwritten after it is deleted from the database.

## Deduplicate Data?

Whether data in the storage pool is deduplicated.

## Processes for Identifying Duplicates

The number of duplicate-identification processes that are specified as the default for the storage pool. The number of duplicate-identification processes that are specified in this field might not equal the number of duplicate-identification processes that are running.

#### Compressed

Whether the storage pool is compressed.

#### Additional space for protected data

The amount of space, in MB, that is used to protect data from remote servers. This is the total amount of space used for data received from other servers as a result of running the PROTECT STGPOOL command.

#### Total Unused Pending Space

The amount of space that is scheduled to become available in a directory-container storage pool. The space is occupied by deduplicated data extents that will be removed from the storage pool when the time period specified by the REUSEDELAY parameter on the DEFINE STGPOOL command expires.

#### Deduplication Savings

The amount and percentage of data that is saved in the storage pool by using data deduplication.

#### Compression Savings

The amount of data that is saved in the storage pool by compression.

#### Total Space Saved

The total amount of data that was saved in the storage pool.

#### Auto-copy Mode

Indicates whether data is written simultaneously to copy storage pools or active-data pools during client store sessions, server import processes, server data migration processes, or all three operations. The value CLIENT indicates either client store or server import operations. The value ALL indicates that simultaneous-write operations occur whenever this pool is a target for any of the eligible operations.

If the storage pool is a copy storage pool or an active-data pool or if the simultaneous-write function is disabled, this field is blank.

#### Contains Data Deduplicated by Client?

Indicates whether the storage pool contains data that was deduplicated by clients. Storage pools that contain data that is deduplicated by clients are not accessible for LAN-free data movement by storage agents V6.1 or earlier.

Tip: This field is blank for container storage pools. You cannot use container storage pools for LAN-free data movement.

#### Maximum Simultaneous Writers

The maximum number of I/O that can run concurrently on the storage pool.

#### Protect Processes

The set of protect processes.

#### Protection Storage Pool

The name of the container storage pool where the data is protected to on the target replication server.

#### Protect Local Storage Pool(s)

Indicates whether local storage pools are protected.

#### Reclamation Volume Limit

For container-copy storage pools, indicates the maximum number of volumes that the server reclaims during storage pool protection.

#### Date of Last Protection to Remote Pool

The date that the storage pool was last protected to a storage pool on a remote server.

#### Date of Last Protection to Local Pool

The date that the storage pool was last protected to a storage pool on the local server.

#### Deduplicate Requires Backup?

Indicates whether the sequential storage pool must be backed up if the storage pool contains deduplicated data.

#### Encrypted

For directory-container or cloud-container storage pools, indicates whether client data is encrypted before it is written to the storage pool.

#### Pct Encrypted

The percentage of deduplicated client data that is encrypted in the directory-container or cloud-container storage pool.

#### Cloud Space Utilized (MB)

For cloud storage pools, the space that is used by the cloud storage, in megabytes.

#### Bucket Name

For cloud storage pools that use Simple Storage Service (S3), the name IBM Spectrum Protect™ assigns to the S3 bucket or IBM® Cloud Object Storage vault. This value can also be the name you assigned to the bucket by using the BUCKETNAME parameter in the DEFINE STGPOOL command or the UPDATE STGPOOL command.

#### Local Estimated Capacity

For cloud storage pools that use local storage, the estimated capacity of the local storage in megabytes (M) or gigabytes (G).

#### Local Pct Util

For cloud storage pools that use local storage, an estimate of the utilization of the local storage component of the cloud storage pool, as a percentage.

#### Local Pct Logical

For cloud storage pools that use local storage, the logical occupancy of the cloud storage pool as a percentage of the total occupancy. Logical occupancy is space that is occupied by client files that might or might not be part of an aggregate. A Local Pct Logical value less than 100% indicates that there is vacant space within aggregates in the cloud storage pool.

## Related commands

Table 1. Commands related to QUERY STGPOOL

Command	Description
CONVERT STGPOOL	Convert a storage pool to a directory-container storage pool.
COPY ACTIVE DATA	Copies active backup data.
DEFINE STGPOOL	Defines a storage pool as a named collection of server storage media.
DELETE STGPOOL	Deletes a storage pool from server storage.
QUERY STGPOOLDIRECTORY	Displays information about storage pool directories.
UPDATE STGPOOL	Changes the attributes of a storage pool.

AIX	Linux	Windows
-----	-------	---------

## QUERY STGPOOLDIRECTORY (Query a storage pool directory)

Use this command to display information about one or more storage pool directories.

### Privilege class

Any administrator can issue this command.

### Syntax

```

>>-Query STGPOOLDIRECTORY -*----->
                          .-*----->
                          '-directory-'
                          .-ACCESS---Any----->
>+-----+-----+-----+----->
  '-STGpool---pool_name-' '-ACCESS---+READwrite---+'
                                   +-READOnly----+
                                   +-DESTROYED---+
                                   +-Any-----+
                                   '-UNAVAILABLE-'
                          .-Format----Standard----->
>+-----+-----+-----+----->
  '-Format---+Standard-+'

```

## Parameters

---

### directory

Specifies the storage pool directory to query. This parameter is optional.

\*

Specifies that an asterisk (\*) represents a wildcard character. Use wildcard characters such as an asterisk to match any characters. Alternatively, you can use a question mark (?) or a percent sign (%) to match exactly one character. This is the default.

### directory

Specifies the storage pool directory. If you do not specify a value for this parameter, all storage pool directories are displayed. The maximum length of the storage pool directory is 1024.

### STGpool

Specifies the name of the storage pool to query. If you do not specify a value for this parameter, all storage pool directories are displayed. The maximum length of the storage pool name is 30. This parameter is optional.

### Access

Specifies that output is restricted by directory access mode. This parameter is optional. Specify one of the following values:

#### READWrite

Display all storage pool directories with an access mode of `READWRITE`.

#### READOnly

Display all storage pool directories with an access mode of `READONLY`.

#### DESTroyed

Display all storage pool directories with an access mode of `DESTROYED`. The directories are designated as permanently damaged in the storage pool directory.

#### Any

Display all storage pool directories. This is the default.

#### UNAVailable

Display directories with an access mode of `UNAVAILABLE`.

### Format

Specifies how the information is displayed. This parameter is optional. The default value is `STANDARD`. You can specify one of the following values:

#### Standard

Specifies that partial information is displayed.

#### Detailed

Specifies that complete information is displayed.

## Example: Display summary information for a specific storage pool directory

---

Display information for the storage pool directory that is named `DPOOL`. See Field descriptions for field descriptions.

```
query stgpooldirectory C:\data
```

Storage Pool Name	Directory	Access
DPOOL	C:\data	Read/Write

## Example: Display detailed storage pool directory information

---

Display details for the storage pool directory named that is named `DPOOL`.

```
query stgpooldirectory stgpool=dpool format=detailed
```

AIX | Linux

```
Storage Pool Name: DPOOL
Directory: /storage/sampleDir
Access: Read/Write
```

```

Free Space (MB): 323,170
Total Space (MB): 476,938
File System: /storage
Absolute Path: /storage/data

```

**Windows**

```

Storage Pool Name: DPOOL
Directory: /storage2/sampleDir
Access: Read/Write
Free Space (MB): 323,170
Total Space (MB): 476,938
File System: /storage
Absolute Path: /storage2/sampleDir

```

## Field descriptions

### Storage Pool Name

The name of the storage pool.

### Directory

The name of the storage pool directory.

### Access

The access mode of the data in the storage pool directory.

### Free Space (MB)

The amount of space in the storage pool directory, in megabytes, that is not in use.

### Total Space (MB)

The total amount of space in the storage pool directory, in megabytes.

### File System

The name of the file system where the storage pool directory is located.

### Absolute Path

The absolute path name where the storage pool directory is located. The absolute path name contains the name of the root directory and all subdirectories in the path name. All symbolic links are resolved in the absolute path name.

Table 1. Commands related to QUERY STGPOOLDIRECTORY

Command	Description
DEFINE STGPOOL	Defines a storage pool as a named collection of server storage media.
<b>AIX</b>   <b>Linux</b>   <b>Windows</b> DEFINE STGPOOLDIRECTORY	Defines a storage pool directory to a directory-container or cloud-container storage pool.
<b>AIX</b>   <b>Linux</b>   <b>Windows</b> DELETE STGPOOLDIRECTORY	Deletes a storage pool directory from a directory-container or cloud-container storage pool.
<b>AIX</b>   <b>Linux</b>   <b>Windows</b> UPDATE STGPOOLDIRECTORY	Changes the attributes of a storage pool directory.

## QUERY SUBSCRIBER (Display subscriber information)

Use this command on a configuration manager to display information about subscribers and their profile subscriptions.

### Privilege class

Any administrator can issue this command.

### Syntax

```

>>-Query SUBSCRIBer-+-----+----->
                    .-*-----*
                    '-server_name-'

```

```

.-PROFILE---*-----
>-----<
'-PROFILE---profile_name-'

```

## Parameters

### server\_name

Specifies the name of a managed server for which subscription information is displayed. You can use wildcard characters to specify multiple server names. This parameter is optional. The default is all managed servers.

### PROFILE

Specifies a profile name for which information is displayed. You can use wildcard characters to specify multiple profile names. This parameter is optional. The default is all profiles.

## Example: List a configuration manager's profile subscriptions

Display subscriber information for all profile subscriptions to this configuration manager. See Field descriptions for field descriptions.

```
query subscriber
```

Subscriber	Profile name	Is current?	Last update date/time
SERVER2	DEFAULT_PROFILE	Yes	Thu, May 14, 1998 01:14:42 PM
SERVER2	SETUP	Yes	Thu, May 14, 1998 01:14:42 PM

## Field descriptions

### Subscriber

The name of the subscriber (managed server).

### Profile name

The name of the profile.

### Is current?

Whether the subscription has been refreshed with the current information associated with the profile. Possible values are:

#### Yes

The managed server is current.

#### No

The managed server is not current. If this field is NO after the profile has been refreshed, check the server messages for error conditions that might cause the refresh to fail.

#### Unknown

Either the managed server has a more recent version of the profile than the configuration manager, or the profile no longer exists on the configuration manager, but the subscription is still associated with the profile.

### Last update date/time

Specifies the date and time that configuration information for the subscription was successfully distributed to the subscriber.

## Related commands

Table 1. Commands related to QUERY SUBSCRIBER

Command	Description
DEFINE SUBSCRIPTION	Subscribes a managed server to a profile.
DELETE SUBSCRIBER	Deletes obsolete managed server subscriptions.
DELETE SUBSCRIPTION	Deletes a specified profile subscription.
NOTIFY SUBSCRIBERS	Notifies servers to refresh their configuration information.
SET CONFIGMANAGER	Specifies whether a server is a configuration manager.

Command	Description
QUERY SUBSCRIPTION	Displays information about profile subscriptions.

## QUERY SUBSCRIPTION (Display subscription information)

Use this command on a managed server to display profile subscription information.

### Privilege class

Any administrator can issue this command.

### Syntax

```
>>-Query SUBSCRIPTION--+-*-----+-----><
                          '-profile_name-'
```

### Parameters

profile\_name

Specifies the name of the profile for which subscription information is displayed. You can use wildcard characters to specify multiple names. This parameter is optional. The default is all profiles.

### Example: Display description information

Display subscription information for all profiles.

```
query subscription
```

```
Configuration      Profile name      Last update
manager            date/time
-----
SERVER1            ADMIN_INFO        Thu, May 14, 1998
                   01:35:13 PM
SERVER1            DEFAULT_PROFILE   Thu, May 14, 1998
                   01:35:13 PM
SERVER1            EMPLOYEE          Thu, May 14, 1998
                   01:35:13 PM
```

### Field descriptions

Configuration manager

The name of the configuration manager.

Profile name

The name of the profile.

Last update date/time

When the most recent configuration information was successfully distributed to the subscriber.

### Related commands

Table 1. Commands related to QUERY SUBSCRIPTION

Command	Description
DEFINE SUBSCRIPTION	Subscribes a managed server to a profile.
DELETE SUBSCRIBER	Deletes obsolete managed server subscriptions.
DELETE SUBSCRIPTION	Deletes a specified profile subscription.
NOTIFY SUBSCRIBERS	Notifies servers to refresh their configuration information.



Command	Description
QUERY SUBSCRIBER	Displays information about subscribers and their subscriptions to profiles.

## QUERY SYSTEM (Query the system configuration and capacity)

Use this command to obtain consolidated information about the server's configuration and capacity.

This command consolidates output from select statements, SHOW commands, and other IBM Spectrum Protect™ commands. Output is generated from several IBM Spectrum Protect commands, for example:

- QUERY ASSOCIATION
- QUERY COPYGROUP
- QUERY DATAMOVER
- QUERY DB
- QUERY DBSPACE
- QUERY DEVCLASS
- QUERY DIRSPACE
- QUERY DOMAIN
- QUERY LIBRARY
- QUERY LOG
- QUERY MGMTCLASS
- QUERY OPTION
- QUERY PROCESS
- QUERY REPLRULE
- QUERY SCHEDULE
- QUERY SERVER
- QUERY SESSION
- QUERY STATUS
- QUERY STGPOOL
- QUERY VOLHISTORY
- QUERY VOLUME

### Privilege class

Any administrator can issue this command.

### Syntax

```
>>-Query SYStem-----<<
```

### Example: View consolidated system information

Issue the QUERY SYSTEM command to obtain consolidated system information. For sample outputs for these query commands, see the individual commands.

```
query system
```

### Related commands

Table 1. Commands related to QUERY SYSTEM

Command	Description
QUERY ASSOCIATION	Displays the clients associated with one or more schedules.
QUERY COPYGROUP	Displays the attributes of a copy group.
QUERY DB	Displays allocation information about the database.

Command	Description
QUERY DBSPACE	Displays information about the storage space defined for the database.
QUERY DEVCLASS	Displays information about device classes.
QUERY DOMAIN	Displays information about policy domains.
QUERY LOG	Displays information about the recovery log.
QUERY MGMTCLASS	Displays information about management classes.
QUERY OPTION	Displays information about server options.
QUERY PROCESS	Displays information about background processes.
QUERY SCHEDULE	Displays information about schedules.
QUERY SESSION	Displays information about all active administrator and client sessions with IBM Spectrum Protect.
QUERY STATUS	Displays the settings of server parameters, such as those selected by the SET commands.
QUERY STGPOOL	Displays information about storage pools.
QUERY VOLHISTORY	Displays sequential volume history information that has been collected by the server.
QUERY VOLUME	Displays information about storage pool volumes.

## QUERY TAPEALERTMSG (Display status of SET TAPEALERTMSG command)

Use this command to display the status of the SET TAPEALERTMSG command. You can enable or disable tape alerts. When enabled, IBM Spectrum Protect™ can retrieve diagnostic information from a tape or library device and display it using ANR messages. When disabled, IBM Spectrum Protect will not query a device for this information.

### Privilege class

To issue this command, you must have system privilege or unrestricted storage privilege.

### Syntax

```
>>-Query TAPEAlertmsg-----<<
```

### Example: Display the status of the QUERY TAPEALERTMSG command

Use the QUERY TAPEALERTMSG command to determine if tape alerts are to be retrieved from devices and displayed in the form of ANR messages.

```
query tapealertmsg
```

```
ANR2017I Administrator SERVER_CONSOLE issued command:
QUERY TAPEALERTMSG
ANR8960I QUERY TAPEALERTMSG: The display of Tape Alerts from SCSI
devices is Enabled.
```

### Related commands

Table 1. Commands related to QUERY TAPEALERTMSG

Command	Description
---------	-------------

Command	Description
SET TAPEALERTMSG	Specifies whether tape and library devices report diagnostic information to the server.

## QUERY TOC (Display table of contents for a backup image)

Use this command to display directory and file information contained in the table of contents (TOC) for a specified backup image. This command does not load table of contents information into the IBM Spectrum Protect™ database. The specified table of contents are read from a storage pool each time the QUERY TOC command is issued.

This command cannot be issued from the server console. If the table of contents is stored on removable media, a mount point is required and output is delayed while the storage pool volume is mounted.

### Privilege class

To issue this command you must have either system privilege, policy privilege for the domain to which the node is assigned, or client owner authority over the node.

### Syntax

```
>>-Query TOC--node_name--filespace_name----->
>--+-----+----->
  '-CREATIONDate----date--CREATIONTime----time-'
. -Format----Standard----.
>--+-----+----->>
  '-Format----+Standard+-'
      '-Detailed-'
```

### Parameters

node\_name (Required)

Specifies the name of the NAS node to which the table of contents (TOC) belongs. You cannot use wildcards to specify this name.

filespace\_name (Required)

Specifies the name of the file space to which the table of contents belongs. The file space name you specify cannot contain wildcard characters.

CREATIONDate

Specifies the creation date of the backup image for which the table of contents is to be displayed. This parameter is optional. If you specify CREATIONDATE, you must also specify CREATIONTIME. If you do not specify these parameters, the contents of the latest backup image for the specified node and file space will be displayed, provided that this image has a table of contents. You can only specify the creation date as the following:

Value	Description	Example
MM/DD/YYYY	A specific date	05/15/2002

This specifies that you want to display the contents of the backup image created on this date. You can obtain this date from the output of the QUERY NASBACKUP command.

CREATIONTime

Specifies the creation time of the backup image for which the table of contents is to be displayed. This parameter is optional. If you specify CREATIONTIME, you must also specify CREATIONDATE. If you do not specify these parameters, the contents of the latest backup image for the specified node and file space will be displayed, provided that this image has a table of contents. You can only specify the creation time as the following:

Value	Description	Example
HH:MM:SS	A specific time on the specified creation date.	10:30:08

This specifies that you want to display the contents of the backup image created on this time for the specified date. You can obtain this time from the output of the QUERY NASBACKUP command.

Format

Specifies how the information is displayed. This parameter is optional. The default value is STANDARD. Possible values are:

**Standard**

Specifies that partial information is displayed for the files.

**Detailed**

Specifies that complete information is displayed for the files, including the hexadecimal representation of each file or directory name.

## Example: Display detailed table of contents information for a specific node

---

Use the QUERY TOC command to display information in the table of contents belonging to NAS node NETAPP in the file space /vol/vol1 created on 12/06/2002 at 11:22:46. Specify a detailed format.

```
query toc netapp /vol/vol1 creationdate=12/06/2002 creationtime=11:22:46
format=detailed
```

Objects in the image backed up on 12/06/2002 11:22:46  
for filesystem /vol/vol1 in node NETAPP:

```
Object Name: /.etc
Hexadecimal Object Name: 2f657463
Object Type: Directory
Object Size: 4,096
Last data Modification Date/Time: 07/31/2002 14:21:19

Object Name: /.etc/oldmaps/ndmp
Hexadecimal Object Name: 2f6574632f6f6c646d6170
732f6e646d70
Object Type: Directory
Object Size: 4,096
Last data Modification Date/Time: 07/31/2002 14:21:19

Object Name: /.etc/oldmaps/ndmp/TSM
/vol/vol1/3df0e8fd
Hexadecimal Object Name: 2f6574632f6f6c646d6170
732f6e646d702f54534d2
02f766f6c2f766f6c312f3
364663065386664
Object Type: File
Object Size: 36,864
Last data Modification Date/Time: 12/06/2002 11:14:22
```

## Field descriptions

---

**Object Name**

The name of the object.

**Hexadecimal Object Name**

The name of the object in hexadecimal format.

**Object Type**

The type of the object.

**Object Size**

The size of the object.

**Last data Modification Date/Time**

The date and time the object was last modified.

## Related commands

---

Table 1. Commands related to QUERY TOC

Command	Description
BACKUP NODE	Backs up a network-attached storage (NAS) node.
QUERY NASBACKUP	Displays information about NAS backup images.
RESTORE NODE	Restores a network-attached storage (NAS) node.

# QUERY VIRTUALFSMAPPING (Query a virtual file space mapping)

Use this command to query a virtual file space mapping definition.

## Privilege class

Any administrator can issue this command.

## Syntax

```
>>-Query VIRTUALFSmapping ----->
      .-*-----
>--+-----+----->>
      |          .-*-----|
      |-node_name--+-----+
      |          '-virtual_filespace_name-'
```

## Parameters

### node\_name

Specifies the client node to which the virtual file space belongs. You can use wildcard characters to specify this name. This parameter is optional. The default is all client node names. You must specify a value for this parameter if you specify a virtual file space name.

### virtual\_file\_space\_name

Specifies the name of the virtual file space mappings to be queried. You can use wildcard characters to specify this name. This parameter is optional. If a value is not specified, all virtual file space mappings are queried. Virtual file space mapping names are case sensitive. Use the QUERY VIRTUALFSMAPPING command to determine the correct capitalization for the virtual file space mapping to be queried.

## Example: Display virtual file spaces for a specific node

Display the currently defined virtual file spaces for node NAS1. See Field descriptions for field descriptions.

```
query virtualfsmapping nas1
```

Node Name	Virtual Filespace Mapping Name	Filespace Name	Path	Hexadecimal Path?
NAS1	/mikesdir	/vol/vol2	/mikes	No
NAS1	/tmpdir	/vol/vol1	/tmp	No
NAS1	/nonASCIIIDir	/vol/vol3	2f73657276657231	Yes

## Field descriptions

### Node Name

Specifies the name of the client node.

### Virtual Filespace Mapping Name

Specifies the name of the virtual file space mapping.

### Filespace Name

The name of the file space that belongs to the node.

File space names can be in a different code page or locale than the server. If they are, the names in the Operations Center and the administrative command-line interface might not be displayed correctly. Data is backed up and can be restored normally, but the file space name or file name might be displayed with a combination of invalid characters or blank spaces.

If the file space name is Unicode-enabled, the name is converted to the server code page for display. The success of the conversion depends on the operating system, the characters in the name, and the server code page. Conversion can be incomplete if the string includes characters that are not available in the server code page or if the server cannot access system conversion routines. If the conversion is incomplete, the name might contain question marks, blanks, unprintable characters, or ellipses (...).



You can specify the date using one of the values below:

Value	Description	Example
MM/DD/YYYY	A specific date	09/15/1998
TODAY	The current date	TODAY
TODAY-days <b>or</b> -days	The current date minus days specified	TODAY-7 <b>or</b> -7.  To display information beginning with records created a week ago, specify BEGINDATE=TODAY-7 or BEGINDATE=-7.
EOLM (End Of Last Month)	The last day of the previous month.	EOLM
EOLM-days	The last day of the previous month minus days specified.	EOLM-1  To include files that were active a day before the last day of the previous month.
BOTM (Beginning Of This Month)	The first day of the current month.	BOTM
BOTM+days	The first day of the current month, plus days specified.	BOTM+9  To include files that were active on the 10th day of the current month.

#### ENDDate

Specifies that you want to display information ending with records created on the specified date. This parameter is optional. The default is the current date.

You can specify the date using one of the values below:

Value	Description	Example
MM/DD/YYYY	A specific date	09/15/1998
TODAY	The current date	TODAY
TODAY-days <b>or</b> -days	The current date minus days specified. The maximum number of days is 9999.	TODAY-1 <b>or</b> -1.  To display records created up to yesterday, specify ENDDATE=TODAY-1 or ENDDATE=-1.
EOLM (End Of Last Month)	The last day of the previous month.	EOLM
EOLM-days	The last day of the previous month minus days specified.	EOLM-1  To include files that were active a day before the last day of the previous month.
BOTM (Beginning Of This Month)	The first day of the current month.	BOTM
BOTM+days	The first day of the current month, plus days specified.	BOTM+9  To include files that were active on the 10th day of the current month.

#### BEGINTime

Specifies that you want to display information beginning with records created at the specified time. This parameter is optional. The default is midnight (00:00:00).

You can specify the time using one of the values below:

Value	Description	Example
HH:MM:SS	A specific time on the specified begin date	12:33:28
NOW	The current time on the specified begin date	NOW

Value	Description	Example
NOW+HH:MM <b>or</b> +HH:MM	The current time plus hours and minutes on the specified begin date	NOW+03:00 <b>or</b> +03:00.  If you issue this command at 9:00 with BEGINTIME=NOW+03:00 or BEGINTIME=+03:00, IBM Spectrum Protect displays records with a time of 12:00 or later on the begin date.
NOW-HH:MM <b>or</b> - HH:MM	The current time minus hours and minutes on the specified begin date	NOW-03:30 <b>or</b> -03:30.  If you issue this command at 9:00 with BEGINTIME=NOW-03:30 or BEGINTIME=-03:30, IBM Spectrum Protect displays records with a time of 5:30 or later on the begin date.

#### ENDTime

Specifies that you want to display information ending with records created at the specified time on the end date. This parameter is optional. The default is the current time.

You can specify the time using one of the values below:

Value	Description	Example
HH:MM:SS	A specific time on the specified end date	10:30:08
NOW	The current time on the specified end date	NOW
NOW+HH:MM <b>or</b> +HH:MM	The current time plus hours and minutes on the specified end date	NOW+03:00 <b>or</b> +03:00.  If you issue this command at 9:00 with ENDTIME=NOW+03:00 or ENDTIME=+03:00, IBM Spectrum Protect displays records with a time of 12:00 or later on the end date.
NOW-HH:MM <b>or</b> -HH:MM	The current time minus hours and minutes on the specified end date	NOW-03:30 <b>or</b> -03:30  If you issue this command at 9:00 with ENDTIME=NOW-3:30 or ENDTIME=-3:30, IBM Spectrum Protect displays records with a time of 5:30 or earlier on the end date.

#### Type

Specifies the type of records to display from the volume history file. This parameter is optional. The default is ALL. Possible values are:

All

Specifies all records.

BACKUPSET

Specifies to display only information about backup set volumes.

DBBackup

Specifies to display only records that contain information about full and incremental database backup volumes, that is with the volume types of BACKUPFULL and BACKUPINCR.

DBRpf

Specifies to display only records that contain information about full and incremental database backup volumes and recovery plan file object volumes (volume types of BACKUPFULL, BACKUPINCR, and RPFIL).

DBSnapshot

Specifies to display only records that contain information about volumes used for database snapshot backups.

EXPort

Specifies only records that contain information about export volumes.

REMote

Specifies to display only records that contain information about volumes used by library clients.

RPFil

Specifies to display only records that contain information about file objects of a recovery plan that are saved on a target server and that were created assuming database full and incremental backups. The parameter displays only records about recovery plan files that are saved on another IBM Spectrum Protect server by using the server-to-server virtual volume function for IBM Spectrum Protect.

RPFSnapshot



Specifies to display only records that contain information about file objects of a recovery plan that are saved on a target server and that were created assuming database snapshot backups. RPFSSnapshot only displays records about recovery plan files that are saved on another IBM Spectrum Protect server by using the server-to-server virtual volume function for IBM Spectrum Protect.

**STGDelete**

Specifies only records that contain information about deleted sequential storage pool volumes.

**STGNew**

Specifies only records that contain information about new sequential access storage volumes.

**STGReuse**

Specifies only records that contain information about reused sequential storage pool volumes.

## Example: Display volume history information for a storage pool volume

---

Display volume history information for a storage pool volume stored in the database. See Field descriptions for field descriptions. Issue the command:

```
query volhistory type=stgnew
```

```
          Date/Time: 02/25/2011 18:28:06
          Volume Type: STGNEW
          Backup Series:
Backup Operation:
          Volume Seq:
          Device Class: FILE
          Volume Name: /adsmfct/server/prvoll
          Volume Location:
          Command:
Database Backup ID High:
Database Backup ID LOW:
Database Backup Home Position:
Database Backup HLA:
Database Backup LLA:
Database Backup Total Data Bytes (MB):
Database Backup total Log Bytes (MB):
Database Backup Block Num High:
Database Backup Block Num Low:
Database Backup Stream Id:
Database Backup Volume Sequence for Stream:
```

Note: The volume history file will contain additional fields that do not appear in the query output. These fields are specific to database backup and restore support. They are not intended for use or modification by IBM Spectrum Protect administrators. The fields will be bracketed with a message indicating these are for IBM Spectrum Protect internal use only and not meant to be modified.

## Example: Display volume history information for a database backup volume

---

Display volume history information for a database backup volume stored in the database. See Field descriptions for field descriptions. Issue the command:

```
query volhistory type=dbb
```

```
          Date/Time: 02/25/2011 18:28:06
          Volume Type: BACKUPFULL
          Backup Series: 176
Backup Operation: 0
          Volume Seq: 0
          Device Class: FILE
          Volume Name: /adsmfct/server/prvoll
          Volume Location:
          Command:
Database Backup ID High: 0
Database Backup ID LOW: 0
Database Backup Home Position: 0
Database Backup HLA:
Database Backup LLA:
Database Backup Total Data Bytes (MB): 0
Database Backup total Log Bytes (MB): 0
Database Backup Block Num High: 0
Database Backup Block Num Low: 0
```

Note: The volume history file will contain additional fields that do not appear in the query output. These fields are specific to database backup and restore support. They are not intended for use or modification by IBM Spectrum Protect administrators. The fields will be bracketed with a message indicating these are for IBM Spectrum Protect internal use only and not meant to be modified.

## Field descriptions

---

### Date/Time

The date and time that the volume was created.

### Volume Type

The type of volume:

#### BACKUPFULL

Full database backup volume.

#### BACKUPINCR

Incremental database backup volume.

#### BACKUPSET

Client backup set volume.

#### DBSNAPSHOT

Snapshot database backup volume.

#### EXPORT

Export volume.

#### REMOTE

A volume used on the library client, which is the IBM Spectrum Protect server named in the Volume Location field. See the volume history on the server that is the library client to get details about how the volume is used.

#### RPFIL

Recovery plan file object volume created assuming full and incremental database backups.

#### RPFSnapshot

Recovery plan file object volume created assuming snapshot database backups.

#### STGDELETE

Deleted sequential access storage pool volume.

#### STGNEW

Added sequential access storage pool volume.

#### STGREUSE

Reused sequential access storage pool volume.

### Backup Series

The value of this field depends on the volume type:

- For BACKUPFULL or BACKUPINCR volume types: the backup series identifier.
- For the DBSNAPSHOT volume type: the identifier of the backup series that is associated with the DBSNAPSHOT entry.
- For the RPFIL volume type: the identifier of the backup series that is associated with the RPFIL entry.
- For the RPFSnapshot volume type: the identifier of the backup series that is associated with the RPFSnapshot entry.
- For BACKUPSET volume types: this field is blank.
- For all other volume types: always 0.

A backup series is a full backup and all incremental backups that apply to that full backup. Another series begins with the next full backup of the database.

### Backup Operation

For BACKUPFULL or BACKUPINCR volume types: the operation number of this backup volume within the backup series. The full backup within a backup series is operation 0. The first incremental backup for that full backup is operation 1, the second incremental backup is operation 2, and so on.

For DBSNAPSHOT volume types: the operation number of this DBSNAPSHOT volume within the DBSNAPSHOT series.

For all other volume types: always 0.

This field is blank when the volume type is BACKUPSET.

#### Volume Seq

The sequence or position of the volume within the backup series.

- For BACKUPFULL or BACKUPINCR volume types: the sequence, or position, of the volume within the backup series. Volume sequence 1 identifies the first volume used for the first operation (a full backup), and so on. For example, if the full backup occupies three volumes, these volumes are identified as volume sequence 1, 2, and 3, respectively. The first volume of the next operation (the first incremental backup) is then volume sequence 4.
- For BACKUPSET volume types: the sequence, or position, of the volume within the BACKUPSET series.
- For DBSNAPSHOT volume types: the sequence, or position, of the volume within the DBSNAPSHOT series. Volume sequence 1 identifies the first volume used for the first DBSNAPSHOT operation, and so on.
- For EXPORT volume types: the sequence number of the volume when it was used for exporting data.
- For RPFIL volume types: the value of this field is always one (1).
- For all other volume types: always 0.

#### Device Class

The name of the device class associated with this volume.

#### Volume Name

The name of the volume.

#### Volume Location

The location of the volume. This information is available only for the following volume types:

- BACKUPFULL
- BACKUPINCR
- EXPORT
- REMOTE
- RPFIL

For the volume type of REMOTE, this location field is the server name of the library client that owns this volume.

For the volume type of RPFIL, this location field is the server name defined in the device class definition used by the PREPARE command when the DEVCLASS parameter is specified.

#### Command

When the volume type is EXPORT or BACKUPSET and the volume sequence is 1 (for example, the first volume), this field shows the command that was used to generate the volume. If the EXPORT or BACKUPSET is on more than one volume, the command is displayed with the first volume but not with any of the other volumes.

For any volume type other than EXPORT or BACKUPSET, this field is blank.

Tip: The following fields are not used by IBM Spectrum Protect servers that are V6.3 or later. However, the fields are displayed for compatibility with earlier releases.

- Database Backup ID High
- Database Backup ID Low
- Database Backup Home Position
- Database Backup HLA
- Database Backup LLA
- Database Backup Total Data Bytes (MB)
- Database Backup Total Log Bytes (MB)
- Database Backup Block Num High
- Database Backup Block Num Low

## Related commands

Table 1. Commands related to QUERY VOLHISTORY

Command	Description
BACKUP VOLHISTORY	Records volume history information in external files.
DELETE VOLHISTORY	Removes sequential volume history information from the volume history file.
PREPARE	Creates a recovery plan file.

Command	Description
QUERY RPFIL	Displays information about recovery plan files.
QUERY BACKUPSET	Displays backup sets.
UPDATE VOLHISTORY	Adds or changes location information for a volume in the volume history file.

## QUERY VOLUME (Query storage pool volumes)

Use this command to display information about one or more storage pool volumes.

### Privilege class

Any administrator can issue this command.

### Syntax

```

>>-Query Volume-----*----->
      '-volume_name-'

>----->
|          .-,-----|. |
|          V          | |
|'-ACCess-----+READWrite-----+|
|          +-READOnly-----+
|          +-UNAVailable--+
|          +-OFFsite-----+
|          '-DEStroyed---'

                                     .-STGpool-----*-----
>-----+-----+-----+----->
|          .-,-----|. |   '-STGpool-----pool_name-'
|          V          | |
|'-STatus-----+ONline--+|
|          +-OFFline+
|          +-EMPTy---+
|          +-PENding+
|          +-FILLing+
|          '-FULl----'

.-DEVclass-----*-----
>-----+-----+----->
|'-DEVclass-----device_class_name-'

.-Format-----Standard-----
>-----+-----+-----><
|'-Format-----+Standard+|
|          '-Detailed-'

```

### Parameters

#### volume\_name

Specifies the volume to query. This parameter is optional. You can use wildcard characters to specify names. If you do not specify a name, all storage pool volumes are included in the query.

#### ACCess

Specifies that output is restricted by volume access mode. This parameter is optional. You can specify multiple access modes by separating the modes with commas and no intervening spaces. If you do not specify a value for this parameter, output is not restricted by access mode. Possible values are:

#### READWrite

Display volumes with an access mode of READWRITE. Client nodes and server processes can read from and write to files stored on the volumes.

#### READOnly

Display volumes with an access mode of READONLY. Client nodes and server processes can read only files that are stored on the volumes.

**UNAVailable**

Display volumes with an access mode of UNAVAILABLE. Client nodes and server processes cannot access files that are stored on the volumes.

**OFFsite**

Display copy storage pool volumes with an access mode of OFFSITE. The volumes are at offsite locations from which they cannot be mounted.

**DESTroyed**

Display primary storage pool volumes with an access mode of DESTROYED. The volumes are designated as permanently damaged.

**Status**

Specifies that output is restricted by volume status. This parameter is optional. You can specify multiple status values by separating values with commas and no intervening spaces. If you do not specify a value for this parameter, output is not restricted by volume status. Possible values are:

**ONline**

Display random access volumes that are available to the server.

**OFFline**

Display random access volumes that are not available to the server.

**EMPTy**

Display sequential access volumes that have no data.

**PENding**

Display volumes with a status of PENDING. These volumes might be sequential-access volumes from which all files were deleted, but for which the time specified by the REUSEDELAY parameter on the DEFINE STGPOOL command has not elapsed. These volumes might also be random-access disk volumes that were deleted, but that still contain discarded data that is waiting to be shredded. After the data is shredded, the volume will be physically deleted.

**FILLing**

Display sequential access volumes that the server has written to but has not yet filled to capacity.

**FULL**

Display sequential access volumes that the server filled.

**STGPool**

Specifies the storage pool to include in the query. This parameter is optional. You can use wildcard characters to specify names. If you do not specify a storage pool name, all storage pools are included in the query.

**DEVclass**

Specifies the device class to include in the query. This parameter is optional. You can use wildcard characters to specify names. If you do not specify a device class name, all devices are included in the query.

**Format**

Specifies how the information is displayed. This parameter is optional. The default value is STANDARD. Possible values are:

**Standard**

Specifies that partial information is displayed.

**Detailed**

Specifies that complete information is displayed.

AIX

Linux

## Example: List all file storage pool volumes

Display information on all storage pool volumes with the device class name of FILE. See Field descriptions for field descriptions.

```
query volume devclass=file
```

Volume Name	Storage Pool Name	Device Class Name	Estimated Capacity	Pct Util	Volume Status
/FCT/SERVER/COV011	COPYSTG	FILE	0.0 M	0.0	Pending
/FCT/SERVER/COV012	COPYSTG	FILE	0.0 M	0.0	Empty
/FCT/SERVER/COV013	COPYSTG	FILE	0.0 M	0.0	Empty
/FCT/SERVER/PRV011	PRIMESTG	FILE	0.0 M	0.0	Empty
/FCT/SERVER/PRV012	PRIMESTG	FILE	0.0 M	0.0	Empty

Windows

## Example: List all storage pool volumes with the same prefix

Display information on all storage pool volumes that are prefixed with the name ATF. See Field descriptions for field descriptions.

```
query volume atf*
```

Volume Name	Storage Pool Name	Device Class Name	Estimated Capacity	Pct Util	Volume Status
ATF001	8MMPPOOL	8MMTAPE	4.8 G	18.2	Filling
ATF002	8MMPPOOL	8MMTAPE	4.8 G	18.2	Filling

AIX Linux

## Example: Display detailed information about a specific storage pool volume

Display details about the storage pool volume named /fct/server/covoll. See Field descriptions for field descriptions.

```
query volume covoll format=detailed
```

```
Volume Name: /FCT/SERVER/COVOLL
Storage Pool Name: COPYSTG
Device Class Name: DISK
Estimated Capacity: 10.0 M
Scaled Capacity Applied:
Pct Util: 6.7
Volume Status: On-line
Access: Read/Write
Pct. Reclaimable Space: 3.2
Scratch Volume?: Yes
In Error State?: No
Number of Writable Sides: 1
Number of Times Mounted: 11
Write Pass Number: 1
Approx. Date Last Written: 04/14/1998 16:17:26
Approx. Date Last Read: 04/01/1998 13:26:18
Date Became Pending:
Number of Write Errors: 0
Number of Read Errors: 0
Volume Location:
Volume is MVS Lanfree Capable: No
Last Update by (administrator): COLLIN
Last Update Date/Time: 05/01/1998 14:07:27
Begin Reclaim Period:
End Reclaim Period:
Logical Block Protected:
Drive Encryption Key Manager:
```

Windows

## Example: Display detailed information about a specific storage pool volume

Display details about the storage pool volume WPDV00. See Field descriptions for field descriptions.

```
query volume wpdv00 format=detailed
```

```
Volume Name: WPDV00
Storage Pool Name: TAPEPOOL
Device Class Name: TAPE
Estimated Capacity: 5.8 M
Scaled Capacity Applied:
Pct Util: 0.1
Volume Status: On-line
Access: Read/Write
Pct. Reclaimable Space: 3.2
Scratch Volume?: Yes
In Error State?: No
Number of Writable Sides: 1
Number of Times Mounted: 11
Write Pass Number: 1
Approx. Date Last Written: 04/14/1998 16:17:26
Approx. Date Last Read: 04/01/1998 13:26:18
Date Became Pending:
```

```

    Number of Write Errors: 0
    Number of Read Errors: 0
    Volume Location:
Volume is MVS Lanfree Capable: No
Last Update by (administrator): COLLIN
    Last Update Date/Time: 05/01/1998 14:07:27
    Begin Reclaim Period:
    End Reclaim Period:
    Logical Block Protected:
Drive Encryption Key Manager:

```

## Example: Display detailed information about a storage pool volume with a specific device class

---

Display details about a volume in a storage pool with a device class name of FILECLASS. See Field descriptions for field descriptions.

```
query volume devclass=fileclass format=detailed
```

```

Windows Volume Name: Z:\WORM_CFS\0000000E.BFS
AIX Linux Volume Name: /WORM_FILESYS/0000000E.BFS
Storage Pool Name: FILEPOOL
Device Class Name: FILECLASS
Estimated Capacity: 2.0 G
Scaled Capacity Applied:
    Pct Util: 0.0
    Volume Status: Filling
    Access: Read/Write
Pct. Reclaimable Space: 0.0
    Scratch Volume?: Yes
    In Error State?: No
Number of Writable Sides: 1
Number of Times Mounted: 1
    Write Pass Number: 1
Approx. Date Last Written: 03/22/2004 15:23:46
Approx. Date Last Read: 03/22/2004 15:23:46
    Date Became Pending:
Number of Write Errors: 0
Number of Read Errors: 0
    Volume Location:
Volume is MVS Lanfree Capable: No
Last Update by (administrator):
    Last Update Date/Time: 03/22/2004 15:23:46
    Begin Reclaim Period: 03/22/2005
    End Reclaim Period: 04/22/2005
    Logical Block Protected:
Drive Encryption Key Manager:

```

## Example: Display detailed information about a specific storage pool volume

---

Display details about a storage pool volume that is named 000642. The volume is in a storage pool that is associated with a 3592 device class. See Field descriptions for field descriptions.

```
query volume 000642 format=detailed
```

```

    Volume Name: 000642
    Storage Pool Name: 3592POOL
    Device Class Name: 3592CLASS
    Estimated Capacity: 2.0 G
Scaled Capacity Applied:
    Pct Util: 0.0
    Volume Status: Filling
    Access: Read/Write
Pct. Reclaimable Space: 0.0
    Scratch Volume?: Yes
    In Error State?: No
Number of Writable Sides: 1
Number of Times Mounted: 1
    Write Pass Number: 1
Approx. Date Last Written: 03/22/2004 15:23:46
Approx. Date Last Read: 03/22/2004 15:23:46

```

Date Became Pending:  
Number of Write Errors: 0  
Number of Read Errors: 0  
Volume Location:  
Volume is MVS Lanfree Capable: No  
Last Update by (administrator):  
Last Update Date/Time: 03/22/2004 15:23:46  
Begin Reclaim Period: 03/22/2005  
End Reclaim Period: 04/22/2005  
Logical Block Protected: Yes  
Drive Encryption Key Manager: IBM Spectrum Protect

## Field descriptions

---

### Volume Name

The name of the storage pool volume.

### Storage Pool Name

The storage pool to which the volume is defined.

### Device Class Name

The device class that is assigned to the storage pool.

### Estimated Capacity

The estimated capacity of the volume, in megabytes (M), gigabytes (G), or terabytes (T).

For DISK devices, this value is the capacity of the volume.

For sequential access devices, this value is an estimate of the total space available on the volume, which is based on the device class.

### Scaled Capacity Applied

The percentage of capacity to which a volume is scaled. For example, a value of 20 for a volume whose maximum capacity is 300 GB indicates that the volume can store only 20 percent of 300 GB, or 60 GB. This attribute applies only to IBM® 3592 devices.

### Pct Util

An estimate of the utilization of the volume. The utilization includes all space that is occupied by both files and aggregates, including empty space within aggregates.

For DISK volumes, the utilization also includes space that is occupied by cached data.

### Volume Status

The status of the volume.

### Access

Whether the volume is available to the server.

### Pct. Reclaimable Space (sequential access volumes only)

The amount of space on this volume that can be reclaimed because data has expired or been deleted. This value is compared to the reclamation threshold for the storage pool to determine whether reclamation is necessary. Reclaimable space includes empty space within aggregates.

When determining which volumes in a storage pool to reclaim, the server first determines the reclamation threshold. The reclamation threshold is indicated by the value of the THRESHOLD parameter on the RECLAIM STGPOOL command or, if that value was not specified, the value of the RECLAIM parameter in a storage pool definition. The server then examines the percentage of reclaimable space for each volume in the storage pool. If the percentage of reclaimable space on a volume is greater than the reclamation threshold of the storage pool, the volume is a candidate for reclamation.

For example, suppose that storage pool FILEPOOL has a reclamation threshold of 70 percent. This value indicates that the server can reclaim any volume in the storage pool that has a percentage of reclaimable space that is greater than 70 percent. The storage pool has three volumes:

- FILEVOL1 with 65 percent reclaimable space
- FILEVOL2 with 80 percent reclaimable space
- FILEVOL3 with 95 percent reclaimable space

When reclamation begins, the server compares the percent of reclaimable space for each volume with the reclamation threshold of 70 percent. In this example, FILEVOL2 and FILEVOL3 are candidates for reclamation because their percentages of reclaimable space are greater than 70.

For volumes that belong to a SnapLock storage pool, the value is displayed but is not used.



Scratch Volume? (sequential access volumes only)

Whether this volume is returned to scratch when the volume becomes empty.

In Error State?

Whether the volume is in an error state. The server cannot write to volumes in an error state.

Number of Writable Sides

This information is reserved for IBM Spectrum Protect™.

Number of Times Mounted

The number of times that the server opened the volume for use. The number of times that the server opened the volume is not always the same as the number of times that the volume was physically mounted in a drive. After a volume is physically mounted, the server can open the same volume multiple times for different operations, for example for different client backup sessions.

Write Pass Number (sequential access volumes only)

The number of times the volume was written to from the beginning to the end.

Approx. Date Last Written

The approximate date on which the volume was last written.

Approx. Date Last Read

The approximate date on which the volume was last read.

Date Became Pending

The date that the status of the volume was changed to pending.

Number of Write Errors

The number of writing errors that occurred on the volume.

Number of Read Errors

The number of reading errors that occurred on the volume.

Volume Location

The location of the volume.

Volume is MVS Lanfree Capable

Whether the volume is LAN-free capable. A LAN-free capable volume is one that was defined and used (at least once) by the IBM Spectrum Protect z/OS® data manager server.

Last Update by (administrator)

The administrator that defined or most recently updated the volume.

Last Update Date/Time

When the volume was defined or most recently updated.

Begin Reclaim Period

Represents the date after which the server begins reclaiming this volume, but not later than the date represented by the end reclaim period. If, when the reclaim period begins, there are files on the volume that have not expired, they are moved to a new WORM volume during reclamation processing. This field displays a date only if this volume is in a storage pool for which the value of the RECLAMATIONTYPE parameter is SNAPLOCK.

If more than one archive is stored on the same volume, the start of the volume's reclamation period is based on the date of the most recent archive. For SnapLock volumes, the RETVer parameter of the DEFINE COPYGROUP command determines how long an archive is stored. If RETVer is set to 100 days, the volume's reclamation period will start 100 days after the first archive is stored on it. If a second archive is stored on the same volume, the reclamation start date will be adjusted to 100 days after the new archive is stored. If the RETVer value is changed after the first archive is stored, the latest reclamation date will apply for all of the archives on the volume. For example, assume RETVer is set to 100 for an initial archive, but is then changed to 50. If a second archive is stored on the volume three days after the first, the reclamation period will not start until 100 days after the first archive was stored.

End Reclaim Period

Represents the date by which the IBM Spectrum Protect must complete reclamation processing on this volume to ensure continued protection of the data. It also represents the Last Access Date physical file attribute in the NetApp Filer, which prevents the file from being deleted until after that date. This field displays a date only if this volume is in a storage pool for which the value of the RECLAMATIONTYPE parameter is SNAPLOCK.

Drive Encryption Key Manager

The drive encryption key manager. This field applies only to volumes in a storage pool that is associated with a device type of 3592, LTO, or ECARTRIDGE.

Logical Block Protected

Specifies whether logical block protection is enabled for the volume. You can use logical block protection only with the following types of drives and media:

- IBM LTO5 and later
- IBM 3592 Generation 3 drives and later with 3592 Generation 2 media and later
- Oracle StorageTek T10000C and T10000D drives

## Related commands

---

Table 1. Commands related to QUERY VOLUME

Command	Description
DEFINE DEVCLASS	Defines a device class.
DEFINE VOLUME	Assigns a volume to be used for storage within a specified storage pool.
DELETE VOLUME	Deletes a volume from a storage pool.
UPDATE DEVCLASS	Changes the attributes of a device class.
UPDATE VOLUME	Updates the attributes of storage pool volumes.
VARY	Specifies whether a disk volume is available to the server for use.

## QUIT (End the interactive mode of the administrative client)

---

Use this command to end an administrative client session in interactive mode.

You cannot use the QUIT command from the SERVER\_CONSOLE administrative ID, or the console, batch, or mount modes of the administrative client.

### Privilege class

---

Any administrator can issue this command.

### Syntax

---

```
>>-QUIT-----<<
```

### Parameters

---

None.

### Example: End an interactive administrative client session

---

End an administrative client session in the interactive mode.

```
quit
```

### Related commands

---

None.

## RECLAIM STGPOOL (Reclaim volumes in a sequential-access storage pool)

---

Use this command to reclaim volumes in a sequential-access storage pool. Reclamation does not move inactive versions of backup data from volumes in active-data pools.

This command cannot be used for the following types of storage pools:

- Container-copy storage pools. Space in these storage pools is reclaimed as part of the processing that is done by PROTECT STGPOOL commands.
- Storage pools with one of the following data formats:
  - NETAPPDUMP
  - CELERRADUMP

- o NDMPDUMP
- Storage pools that use a CENTERA device class.
- Storage pools that use a Write Once Read Many (WORM) device class. Reclamation is not necessary because WORM volumes are not reusable, but you can run reclamation to consolidate data onto fewer volumes.

Use this command only if you are not going to use automatic reclamation for the storage pool. This command accepts the values of the RECLAIMPROCESS and RECLAIMSTGPOOL attributes of the storage pool definition. This command also accepts the values of the OFFSITERECLAIMLIMIT and RECLAIM parameters of the storage pool definition, if not overridden by the OFFSITERECLAIMLIMIT and THRESHOLD command parameters.

Tips:

- When you issue this command, duplicate data in a primary storage pool, copy storage pool, or active-data pool that is set up for data deduplication is removed.
- When you use this command to restore deduplicated objects to the same storage pool, any duplicate data blocks are replaced with references to deduplicated extents.

For storage pools defined with RECLAMATIONTYPE=SNAPLOCK, this command also deletes empty WORM FILE volumes that exceeded their reclaim period.

## Privilege class

---

To issue this command, you must have system privilege, unrestricted storage privilege, or restricted storage privilege for the storage pool that is being reclaimed and the reclaim storage pool, if applicable.

## Syntax

---

```
>>-RECLaim STGpool--pool_name--+-----+----->
                          '-Threshold---number-'
                          .-Wait---No-----
>--+-----+-----+-----+----->
  '-Duration---minutes-'  '-Wait---+No--+-'
                          '-Yes-'
>--+-----+-----+-----+----->>
  '-OFFSITERECLAIMLimit---number_of_volumes-'
```

## Parameters

---

pool\_name (Required)

Specifies the storage pool in which volumes are to be reclaimed.

DURATION

Specifies the maximum number of minutes that the reclamation runs before it is automatically canceled. You can specify a number 1 - 9999. This parameter is optional.

After the specified number of minutes elapses, the next time the server checks the reclamation process the server stops the reclamation process. The server checks the reclamation process when the server mounts another eligible volume from the storage pool that is being reclaimed. The server also checks the reclamation process when the server begins to reclaim a new batch of files from the currently mounted volume. As a result, the reclamation can run longer than the value you specified for this parameter.

Until the server checks the reclamation process, there is no indication the duration period expired. When the server stops the reclamation process, the server issues message ANR4927W: Reclamation terminated for volume xxx - duration exceeded.

If you do not specify this parameter, the process stops only when no more volumes meet the threshold.

If you specify a duration value for reclamation of a copy storage pool with offsite volumes, you might cause the reclamation to end before any volumes are reclaimed. In most situations when you initiate reclamation for a copy storage pool with offsite volumes, consider limiting the number of offsite volumes to be reclaimed rather than limiting the duration. For details, see the OFFSITERECLAIMLIMIT parameter.

THRESHOLD

Specifies the percentage of reclaimable space on a volume that makes it eligible for reclamation. Reclaimable space is the amount of space that is occupied by files that are expired or deleted from the server database. Reclaimable space also includes unused space.

You can specify a number 1 - 99. This parameter is optional. If not specified, the RECLAIM attribute of the storage pool definition is used.

To determine the percentage of reclaimable space for a volume, issue the QUERY VOLUME command and specify FORMAT=DETAILED. The value in the field Pct. Reclaimable Space is the percentage of reclaimable space for the volume.

Specify a value of 50 percent or greater for this parameter so that files stored on two volumes can be combined into a single target volume.

#### OFFSITERECLAIMLimit

Specifies the maximum number of offsite storage pool volumes that the server tries to reclaim. This parameter is valid only for copy storage pools. You can specify a number 0 - 99999. This parameter is optional. If not specified, the OFFSITERECLAIMLIMIT attribute of the storage pool definition is used.

#### Wait

Specifies whether to wait for the server to complete processing this command in the foreground. This parameter is optional. The default is NO. You can specify one of the following values:

##### No

Specifies that the server processes this command in the background.

You can continue with other tasks while the command is processed. Messages that are created from the background process are displayed either in the activity log or the server console, depending on where messages are logged.

If you cancel this process, some files might already be moved to new volumes before the cancellation.

##### Yes

Specifies that the server processes this command in the foreground. The operation must complete before you can continue with other tasks. Output messages are displayed to the administrative client when the operation completes. Messages are also displayed either in the activity log or the server console, or both, depending on where the messages are logged.

Restriction: You cannot specify WAIT=YES from the server console.

## Example: Reclaim volumes in a sequential-access storage pool

Reclaim volumes in the storage pool named TAPEPOOL. Specify that reclamation ends as soon as possible after 60 minutes.

```
reclaim stgpool tapepool duration=60
```

## Related commands

Table 1. Commands related to RECLAIM STGPOOL

Command	Description
CANCEL PROCESS	Cancel a background server process.
MIGRATE STGPOOL	Migrates files from a primary storage pool to the next storage pool in the hierarchy.
MOVE DRMEDIA	Moves DRM media onsite and offsite.
QUERY DRMEDIA	Displays information about disaster recovery volumes.
QUERY PROCESS	Displays information about background processes.
QUERY STGPOOL	Displays information about storage pools.

## RECONCILE VOLUMES (Reconcile differences in the virtual volume definitions)

Issue this command from the source server to reconcile differences between virtual volume definitions on the source server and archive files on the target server. IBM Spectrum Protect™ finds all volumes of the specified device class on the source server and

all corresponding archive files on the target server. The target server inventory is also compared to the local definition for virtual volumes to see if inconsistencies exist.

## Privilege class

To issue this command, you must have system privilege.

## Syntax

```

>>-REConcile Volumes-----*----->
                          '-device_class_name-'

.-Fix---No-----
>--+----->>
  '-Fix---No---'
    '-Yes-'
  
```

## Parameters

### device\_class\_name

Specifies the device class name of the virtual volumes. If you do not specify a name, IBM Spectrum Protect reconciles all virtual volumes. This parameter is optional.

### FIX

Specifies whether or not IBM Spectrum Protect attempts to correct any identified inconsistencies. This parameter is optional. The default is NO. Possible values are:

#### No

Specifies that IBM Spectrum Protect does not fix any inconsistencies.

#### Yes

Specifies that IBM Spectrum Protect makes the following corrections:

- IBM Spectrum Protect marks as unavailable storage pool volumes on the source server that cannot be located on the target server. Volumes that are only found in the volume history, such as database backups and import and export volumes, are reported as being inconsistent.
- Archive files on the target server that do not correspond to any virtual volumes on the source server are marked for deletion from the target server.

The following table shows the details of the actions taken:

FIX=	At the Source Server	At the Target Server	Action
NO	Volumes exist	No files exist	Report error
		Files exist but are marked for deletion	
		Active files exist but attributes do not match	
	Volumes do not exist	Active files exist	Report error
YES	Volumes exist	Files exist but are marked for deletion	None
		No files exist	Report error <b>Storage pool volumes:</b> Marked as unavailable

FIX=	At the Source Server	At the Target Server	Action
		Files exist but marked for deletion	Report error  <b>Storage pool volumes:</b> If attributes match, mark files on the target server as active again, mark volumes on the source server as unavailable, and recommend that an AUDIT VOLUME be done to verify the data. If attributes do not match, mark volumes as unavailable.
		Active files exist but attributes do not match	Report error  <b>Storage pool volumes:</b> Mark as unavailable and recommend that an AUDIT VOLUME be done to verify the data.
	Volumes do not exist	Active files exist	Mark files for deletion on the target server.
		Files exist but marked for deletion	None

## Example: Reconcile differences in the virtual volume definitions

Reconcile the differences between all virtual volumes definitions on the source server and archive files on the target server to correct any inconsistencies.

```
reconcile volumes remotel fix=yes
```

## Related commands

Table 1. Commands related to RECONCILE VOLUMES

Command	Description
DEFINE DEVCLASS	Defines a device class.
DEFINE SERVER	Defines a server for server-to-server communications.
DELETE SERVER	Deletes the definition of a server.
QUERY SERVER	Displays information about servers.
UPDATE SERVER	Updates information about a server.

## REGISTER commands

Use the REGISTER commands to define or add objects to IBM Spectrum Protect™.

- REGISTER ADMIN (Register an administrator ID)
- REGISTER LICENSE (Register a new license)
- REGISTER NODE (Register a node)

## REGISTER ADMIN (Register an administrator ID)

Use this command to add an administrator to the server. After registration, the administrator can issue a limited set of commands, including all query commands. To provide additional privileges, use the GRANT AUTHORITY command.

## Privilege class

To issue this command, you must have system privilege.

When you register an administrator with the same name as an existing node, be aware of the administrator authentication method and the SSLREQUIRED setting. Any node that has the same name as the administrator that is being registered inherits those settings.

For users of Lightweight Directory Access Protocol (LDAP) servers:

- The information in this documentation applies to the LDAP authentication method that is preferred for IBM Spectrum Protect™ V7.1.7 or later servers. For instructions about using the previous LDAP authentication method, see Managing passwords and logon procedures.
- Do not specify an administrative user ID that matches a node name. If the administrative user ID matches the node name, you might see unexpected behavior because of automatic password changes that update the same password twice. As a result, the password might become unknown to the administrative user ID. Alternatively, the password update operation might fail.

## Syntax

---

```
>>-REGISTER Admin--admin_name--+-----+----->
                                     '-password-'
>--+-----+-----+----->
| (1) | | '-CONTACT----text-'
|-----PASSEXP----days-|
.-FORCEPwreset----No-----
>--+-----+----->
'-FORCEPwreset----+No--+-'
                                     '-Yes-'
>--+-----+----->
'-EMAILAddress----userID@node-'
(2)
.------AUTHentication----LOCAL-.
>--+-----+----->
'-AUTHentication----+LOCAL+----'
                                     '-LDap--'
(3)
.-SSLrequired----DEFAULT-----
>--+-----+----->
'-SSLrequired----+Yes-----+'
                                     +-No-----+
                                     '-DEFAULT-'
.-SESSIONSECurity----TRANSitional----
>--+-----+----->
'-SESSIONSECurity----+STRict-----+'
                                     '-TRANSitional-'
.-ALert----No-----
>--+-----+-----><
'-ALert----+Yes--+-'
                                     '-No--'
```

### Notes:

1. The PASSEXP command does not apply to administrators who authenticate to an LDAP directory server.
2. The default value can change if you issued the SET DEFAULTAUTHENTICATION command and specified LDAP.
3. The SSLREQUIRED parameter is deprecated.

## Parameters

---

### admin\_name (Required)

Specifies the name of the administrator to be registered. The maximum length of the name is 64 characters.

You cannot specify an administrator name of NONE.

If you plan to authenticate the administrator ID with an LDAP server, ensure that the administrator ID does not match the name of any node that authenticates with an LDAP server.

### password

Specifies the password of the administrator to be registered. The maximum length of the password is 64 characters.

If you authenticate passwords locally with the IBM Spectrum Protect server, you must specify a password. The password is not case-sensitive.

If you authenticate passwords with a Lightweight Directory Access Protocol (LDAP) server, do not specify a password on the REGISTER ADMIN command.

#### PASSExp

Specifies the number of days the password remains valid. You can set the password expiration period in the range 0 - 9999 days. A value of 0 means that the password never expires. This parameter is optional. If you do not specify this parameter, the password is set with the global expiration period of 90 days. This parameter does not affect passwords that authenticate with an LDAP directory server.

#### CONtact

Specifies information identifying the administrator being registered. This parameter is optional. The maximum length of this string is 255 characters. The contact information must be enclosed in quotation marks if it contains any blanks.

#### FORCEPwreset

Specifies whether the administrator is required to change or reset the password. This parameter is optional. The default value is NO. Possible values are:

##### No

Specifies that the administrator does not need to change or reset the password while attempting to sign on to the server.

##### Yes

Specifies that the administrator's password expires at the next sign-on. The client or administrator must change or reset the password then. If a password is not specified, you receive an error message.

Restriction: For administrative user IDs that authenticate with an LDAP server, password expiration is set by using LDAP server utilities. For this reason, do not specify FORCEPWRESET=YES if you specify AUTHENTICATION=LDAP.

#### EMAILAddress

Specifies the email address for this administrator.

#### AUTHentication

This parameter specifies the authentication method for the administrator user ID. Specify one of the following values: LDAP or LOCAL. The parameter is optional and defaults to LOCAL. The default can change to LDAP if you use the SET DEFAULTAUTHENTICATION command and specify LDAP.

##### LOcal

Specifies that the local IBM Spectrum Protect server database is used.

##### LDap

Specifies that the administrator user ID authenticates passwords with an LDAP directory server. Passwords that authenticate with an LDAP directory server are case-sensitive.

Tip: A password is not required if you register an administrator and select AUTHENTICATION=LDAP. At logon, you are prompted for a password.

#### SSLrequired (deprecated)

Specifies whether the administrator user ID must use the Secure Sockets Layer (SSL) protocol to communicate between the IBM Spectrum Protect server and the backup-archive client. When you authenticate passwords with an LDAP directory server, you must protect the sessions by using SSL or another network security method.

Important: Beginning with IBM Spectrum Protect Version 8.1.2, this parameter is deprecated. Validation that was enabled by this parameter is replaced by the TLS 1.2 protocol, which is enforced by the SESSIONSECURITY parameter. The SSLREQUIRED parameter is ignored. Update your configuration to use the SESSIONSECURITY parameter.

#### SESSIONSECurity

Specifies whether the administrator must use the most secure settings to communicate with an IBM Spectrum Protect server. This parameter is optional.

You can specify one of the following values:

##### STRict

Specifies that the strictest security settings are enforced for the administrator. The STRICT value uses the most secure communication protocol available, which is currently TLS 1.2. The TLS 1.2 protocol is used for SSL sessions between the server and the administrator. To specify whether the server uses TLS 1.2 for the entire session or only for authentication, see the SSL client option.

To use the STRICT value, the following requirements must be met to ensure that the administrator can authenticate with the server:



- Both the administrator and server must be using IBM Spectrum Protect software that supports the SESSIONSECURITY parameter.
- The administrator must be configured to use the TLS 1.2 protocol for SSL sessions between the server and the administrator.

Administrators set to STRICT that do not meet these requirements are unable to authenticate with the server.

#### TRANSitional

Specifies that the existing security settings are enforced for the administrator. This is the default value. This value is intended to be used temporarily while you update your security settings to meet the requirements for the STRICT value.

If SESSIONSECURITY=TRANSITIONAL and the administrator has never met the requirements for the STRICT value, the administrator will continue to authenticate by using the TRANSITIONAL value. However, after an administrator meets the requirements for the STRICT value, the SESSIONSECURITY parameter value automatically updates from TRANSITIONAL to STRICT. Then, the administrator can no longer authenticate by using a version of the client or an SSL/TLS protocol that does not meet the requirements for STRICT. In addition, after an administrator successfully authenticates by using a more secure communication protocol, the administrator can no longer authenticate by using a less secure protocol. For example, if an administrator that is not using SSL is updated and successfully authenticates by using TLS 1.2, the administrator can no longer authenticate by using no SSL protocol or TLS 1.1. This restriction also applies when you use functions such as command routing or server-to-server export, when the administrator authenticates to the IBM Spectrum Protect server as an administrator from another server.

#### ALert

Specifies whether alerts are sent to an administrators email address.

#### Yes

Specifies that alerts are sent to the specified administrators email address.

#### No

Specifies that alerts are not sent to the specified administrators email address. This is the default value.

Tip: Alert monitoring must be enabled, and email settings must be correctly defined to successfully receive alerts by email. To view the current settings, issue the QUERY MONITORSETTINGS command.

## Example: Register an administrator

Define an administrator, LARRY, with the password PASSONE. You can identify LARRY as second-shift personnel by specifying this information with the CONTACT parameter. Issue the command:

```
register admin larry passone contact='second shift'
```

## Example: Register an administrator ID and set the authentication method

Define an administrator ID for Harry so that Harry can authenticate to an LDAP server. Issue the command:

```
register admin harry authentication=ldap
```

## Example: Register an administrator and enforce strict session security

Register an administrator named Harry, and require Harry to use the strictest security settings to authenticate with the server. Issue the command:

```
register admin harry sessionsecurity=strict
```

## Related commands

Table 1. Commands related to REGISTER ADMIN

Command	Description
GRANT AUTHORITY	Assigns privilege classes to an administrator.
LOCK ADMIN	Prevents an administrator from accessing IBM Spectrum Protect.
QUERY ADMIN	Displays information about one or more IBM Spectrum Protect administrators.

Command	Description
QUERY MONITORSETTINGS (Query the configuration settings for monitoring alerts and server status)	Displays information about monitoring alerts and server status settings.
REGISTER NODE	Defines a client node to the server and sets options for that user.
REMOVE ADMIN	Removes an administrator from the list of registered administrators.
RENAME ADMIN	Changes an IBM Spectrum Protect administrator's name.
SET DEFAULTAUTHENTICATION	Specifies the default password authentication method for any REGISTER NODE or REGISTER ADMIN commands.
SET PASSEXP	Specifies the number of days after which a password is expired and must be changed.
UNLOCK ADMIN	Enables a locked administrator to access IBM Spectrum Protect.
UPDATE ADMIN	Changes the password or contact information associated with any administrator.
UPDATE NODE	Changes the attributes that are associated with a client node.

**Related tasks:**

Naming Tivoli Storage Manager objects

**Related information:**

Ssl client option

## REGISTER LICENSE (Register a new license)

Use this command to register new licenses for server components, including IBM Spectrum Protect™ (base), IBM Spectrum Protect Extended Edition, and IBM Spectrum Protect for Data Retention.

Licenses are stored in enrollment certificate files. The enrollment certificate files contain licensing information for the server product. The NODELOCK file preserves the licensing information for your installation. Your license agreement determines what you are licensed to use, even if you cannot use the REGISTER LICENSE command to register all components. You are expected to comply with the license agreement and use only what you have purchased. Use of the REGISTER LICENSE command implies that you agree to and accept the license terms specified in your license agreement.

Important:

- Before upgrading from a previous version of IBM Spectrum Protect, you must delete or rename the NODELOCK file.
- To unregister licenses, you must erase the NODELOCK file in the server instance directory of your installation, and reregister any previously registered licenses.
- You cannot register licenses for IBM Spectrum Protect for Mail, IBM Spectrum Protect for Databases, IBM Spectrum Protect for ERP, and IBM Spectrum Protect for Space Management.

To generate a report that can help you understand the license requirements for your system, run the QUERY PVUESTIMATE command. The report contains estimates of the number of client devices and PVU totals for server devices. The estimates are not legally binding.

### Privilege class

To issue this command, you must have system privilege.

### Syntax

```
>>-REGister LICense--FILE--==--+tsmbasic.lic+----->>
                                +-tsmee.lic----+
                                +-dataret.lic--+
                                '-*.lic-----'
```

## Parameters

### FILE

Specifies the name of the enrollment certificate file containing the license to be registered. The specification can contain a wildcard (\*). Enter the complete file name or a wildcard in place of the file name. The file names are case-sensitive. The following values can be used:

tsmbasic.lic

To license base IBM Spectrum Protect.

tsmee.lic

To license IBM Spectrum Protect Extended Edition. This includes the disaster recovery manager, large libraries, and NDMP.

dataret.lic

To license IBM Spectrum Protect for Data Retention. This is required to enable Data Retention Protection as well as Expiration and Deletion Suspension (Deletion Hold).

\*.lic

To license all IBM Spectrum Protect licenses for server components.

## Example: Register a license

Register the base IBM Spectrum Protect license.

```
register license file=tsmbasic.lic
```

## Related commands

Table 1. Commands related to REGISTER LICENSE

Command	Description
AUDIT LICENSES	Verifies compliance with defined licenses.
QUERY LICENSE	Displays information about licenses and audits.
QUERY PVUESTIMATE	Displays processor value unit estimates.
QUERY STATUS	Displays the settings of server parameters, such as those selected by the SET commands.
SET LICENSEAUDITPERIOD	Specifies the number of days between automatic license audits.

## REGISTER NODE (Register a node)

Use this command to register a node to the server.

This command can create an administrative user ID with client owner authority over the node. You can use this administrative user ID to access the web backup-archive client from remote locations through a web browser.

Tip:

- In earlier product releases, the REGISTER NODE command automatically created an administrative user ID whose name matched the node name. Beginning with IBM Spectrum Protect™ V8.1, the REGISTER NODE command does not automatically create an administrative user ID that matches the node name.
- If you plan to use the LAN-free option with this node, you must register an administrative ID that matches the node name. To register the administrative ID, use the USERID parameter or manually register the administrator and grant owner authority to the node.

If a client requires a different policy domain than STANDARD, you must register the client node with this command or update the registered node.

Requirement: When you set `sslrequired=serveronly` in a REGISTER NODE command, the admin SSLREQUIRED setting reverts to YES. To use a non-SSL session with a storage agent, rename the admin with the identical name by issuing the RENAME ADMIN command.

For users of Lightweight Directory Access Protocol (LDAP) servers: The information in this documentation applies to the LDAP authentication method that is preferred for IBM Spectrum Protect V7.1.7 or later servers. For instructions about using the

previous LDAP authentication method, see Managing passwords and logon procedures.

When you register or update a node, you can specify whether damaged files on the node can be recovered from a replication server. Files can be recovered only if all the following conditions are met:

- Version 7.1.1 or later, is installed on the source and target replication servers.
- The REPLRECOVERDAMAGED system parameter is set to ON. The system parameter can be set by using the SET REPLRECOVERDAMAGED command.
- The source server includes at least one file that is marked as damaged in the node that is being replicated.
- The node data was replicated before the damage occurred.

The following table describes how parameter settings affect the recovery of damaged, replicated files.

Table 1. Settings that affect the recovery of damaged files

Setting for the REPLRECOVERDAMAGED system parameter	Value of the RECOVERDAMAGED parameter on the REPLICATE NODE command	Value of the RECOVERDAMAGED parameter on the REGISTER NODE and UPDATE NODE commands	Result
OFF	YES, NO, or not specified	YES or NO	During node replication, standard replication occurs and damaged files are not recovered from the target replication server.
OFF	ONLY	YES or NO	An error message is displayed because files cannot be recovered when the REPLRECOVERDAMAGED system parameter is set to OFF.
ON	YES	YES or NO	During node replication, standard replication occurs and damaged files are recovered from the target replication server.
ON	NO	YES or NO	During node replication, standard replication occurs and damaged files are not recovered from the target replication server.
ON	ONLY	YES or NO	Damaged files are recovered from the target replication server, but standard node replication does not occur.
ON	Not specified	YES	During node replication, standard replication occurs and damaged files are recovered from the target replication server.
ON	Not specified	NO	During node replication, standard replication occurs and damaged files are not recovered from the target replication server.

## Privilege class

To issue this command, you must have system privilege, unrestricted policy privilege, or restricted policy privilege for the policy domain to which the client node is assigned.

## Syntax

```
>>-REGister Node--node_name--+-----+----->
                                   '-password-'

                                   .-USerid----NONE-----
>+-----+-----+-----+----->
  | (1)          | '-USerid----+NONE-----+'
```



```

>----->
'-EMAILAddress----userID@node-'

.-DEDUPLICATION----Clientorserver----.
>----->
'-DEDUPLICATION----+Clientorserver+-'
                '-SERVEROnly----'

.-BACKUPINITiation----All-----.
>----->
|                                     (4) |
'-BACKUPINITiation----+All--+-----'
                '-ROOT-'

>----->
'-REPLState----+Enabled--+-'
                '-DISabled-'

.-BKREPLRuledefault----DEFAULT-----.
>----->
| (5) |
'-----BKREPLRuledefault----+ALL_DATA-----+-'
                +-ACTIVE_DATA-----+
                +-ALL_DATA_HIGH_PRIORITY----+
                +-ACTIVE_DATA_HIGH_PRIORITY+-
                +-DEFAULT-----+
                '-NONE-----'

.-ARREPLRuledefault----DEFAULT-----.
>----->
| (5) |
'-----ARREPLRuledefault----+ALL_DATA-----+-'
                +-ALL_DATA_HIGH_PRIORITY+-
                +-DEFAULT-----+
                '-NONE-----'

.-SPREPLRuledefault----DEFAULT-----.
>----->
| (5) |
'-----SPREPLRuledefault----+ALL_DATA-----+-'
                +-ALL_DATA_HIGH_PRIORITY+-
                +-DEFAULT-----+
                '-NONE-----'

.-RECOVERDamaged----Yes-----.
>----->
'-RECOVERDamaged----+Yes+-'
                '-No--'

.-ROLEOVERRIDE----Userreported----.
>----->
'-ROLEOVERRIDE----+Client-----+'
                +-Server-----+
                +-Other-----+
                '-Userreported-'

(6)
.------AUTHentication----Local-.
>----->
'-AUTHentication----+Local+----'
                '-LDap--'

(7)
.-SSLrequired----Default-----.
>----->
'-SSLrequired----+Yes-----+'
                +-No-----+
                +-Default----+
                '-SERVErOnly-'

.-SESSIONSECurity----TRANSitional----.
>----->
'-SESSIONSECurity----+STRict-----+'

```



If you plan to use the LAN-free option with this node, use the USERID parameter to register an administrative ID that matches the node name.

For users of LDAP servers: If you plan to authenticate the node with an LDAP server, keep the default setting (USERID=NONE) or specify an administrative user ID that differs from the node name. If the administrative user ID matches the node name, you might see unexpected behavior because of automatic password changes that update the same password twice. As a result, the password might become unknown to the administrative user ID. Alternatively, the password update operation might fail.

#### CONtact

Specifies a text string of information that identifies the node. The parameter is optional. The maximum length of the text string is 255 characters. The contact information must be enclosed in quotation marks if it contains any blanks.

#### DOmain

Specifies the name of the policy domain to which the node is assigned. The parameter is optional. If you do not specify a policy domain name, the node is assigned to the default policy domain (STANDARD).

When a source server is registered as a node, it is assigned to a policy domain. Data from the source server is stored in the storage pool that is specified in the archive copy group of the default management class of that domain.

#### COMPrission

Specifies whether the client node compresses its files before it sends these files to the server for backup and archive. The parameter is optional. The default value is CLIENT.

Restriction: This parameter does not apply to nodes with a type of NAS or SERVER.

You can specify one of the following values:

##### Client

Specifies that the client determines whether to compress files.

##### Yes

Specifies that the client node compresses its files before it sends these files to the server for backup and archive.

##### No

Specifies that the client node does not compress its files before it sends these files to the server for backup and archive.

#### ARCHDElete

Specifies whether the client node can delete its own archive files from the server. The parameter is optional. The default value is YES. You can specify one of the following values:

##### Yes

Specifies that the client node can delete its own archive files from the server.

##### No

Specifies that the client node cannot delete its own archive files from the server.

#### BACKDElete

Specifies whether the client node can delete its own backup files from the server. The parameter is optional. The default value is NO. You can specify one of the following values:

##### No

Specifies that the client node cannot delete its own backup files from the server.

##### Yes

Specifies that the client node can delete its own backup files from the server.

#### CLOptset

Specifies the name of the option set to be used by the client. The parameter is optional.

#### FORCEPwreset

Specifies whether to force a client to change or reset the password. The parameter is optional. The default value is NO. You can specify one of the following values:

##### No

Specifies that the password expiration period is set by the SET PASSEXP command. The client does not need to change or reset the password while the client is logging on to the server.

##### Yes

Specifies that the client node password expires at the next logon. The client must change or reset the password then. If a password is not specified, you receive an error message.

Restriction: For nodes that authenticate with an LDAP server, password expiration is set by using LDAP server utilities. For this reason, do not specify FORCEPWRESET=YES if you specify AUTHENTICATION=LDAP.



## Type

Specifies the type of node that is being registered. The parameter is optional. The default value is CLIENT. You can specify one of the following values:

### Client

Specifies that the client node is a Backup-Archive Client, IBM Spectrum Protect for Space Management client, or application client.

### NAS

Specifies that the node is a network-attached storage (NAS) file server whose data is protected by using NDMP operations. The node name cannot be SERVER.

Note: The name of the NAS node must be the same as the data mover. Therefore, the name cannot be changed after a corresponding data mover is defined.

### Server

Specifies that the client node is a source server that is being registered on the target server.

## URL

Specifies the URL of the IBM Spectrum Protect web client that is configured on the client system. You can use the URL in a web browser and in the Operations Center to remotely manage the client node.

This parameter is optional. The URL must include the DNS name or IP address of the client system, and the port number that is defined on the client system for the IBM Spectrum Protect web client. For example, `http://client.mycorp.com:1581`

## UTILITYUrl

Specifies the address of the IBM Spectrum Protect client management services that are configured on the client system. This URL is used by the Operations Center to access client log files so that you can remotely diagnose client issues from the Operations Center.

This parameter is optional. You can specify a URL of up to 200 characters in length. The URL must start with `https`. It includes the DNS name or IP address of the client system, and the port number that is defined on the client system for the IBM Spectrum Protect client management services. For example, `https://client.mycorp.com:9028`

If you omit the port number, the Operations Center uses the port number 9028, which is the default port number when you install the client management services on the client system.

## MAXNUMMP

Specifies the maximum number of mount points a node is allowed to use on the server or storage agent only for operations such as backup, archive, and IBM Spectrum Protect for Space Management migration. The parameter is optional and does not apply to nodes with a type of NAS or SERVER. The default value is 1. You can specify an integer in the range 0 - 999. A value of 0 specifies that a node cannot acquire any mount point for a client data store operation. The MAXNUMMP value is not evaluated or enforced during client data read operations such as restore, retrieve, and IBM Spectrum Protect for Space Management recall. However, mount points in use for data read operations are evaluated against attempted concurrent data store operations for the same client node and might prevent the data store operations from being able to acquire mount points.

For volumes in a storage pool that is associated with the FILE or CENTERA device type, the server can have multiple sessions to read and one process to write to the same volume concurrently. To increase concurrency and provide efficient access for nodes with data in FILE or CENTERA storage pools, increase the value of the MAXNUMMP parameter.

For nodes that store data into primary storage pools with the simultaneous-write function that is enabled, you must adjust the value of the MAXNUMMP parameter to specify the correct number of mount points for each client session. A client session requires one mount point for the primary storage pool and one mount point for each copy storage pool and each active-data pool.

For server-to-server backup, if one server is at a different version than the other server, set the number of mount points on the target server to a value higher than one. Otherwise, you receive an error.

A storage agent independently tracks the number of points that are used during a client session. If a node has a storage agent that is installed, it might exceed the MAXNUMMP value. The MAXNUMMP value might also be exceeded under conditions where the node does not have to wait for a mount point.

Note: The server might preempt a client operation for a higher priority operation and the client might lose a mount point if no other mount points are available.

## KEEPMP

Specifies whether the client node keeps the mount point for the entire session. The parameter is optional. The default value is NO. You can specify one of the following values:

**Yes**

Specifies that the client node must retain the mount point during the entire session. If policy definitions cause data to be stored to a disk storage pool after the data is stored to a sequential access storage pool, any mount points that are held by the session will not be released.

**No**

Specifies that the client node releases the mount point during the session. If policy definitions cause data to be stored to a disk storage pool after the data is stored to a sequential access storage pool, any mount points that are held by the session will be released.

**AUTOFSRename**

Specify whether file spaces are automatically renamed when you upgrade the client system to support Unicode or specify whether file spaces are renamed by the client, if needed. The parameter is optional. The default is NO. Setting the parameter to YES enables automatic renaming, which occurs when the client runs one of the following operations: archive, selective backup, full incremental backup, or partial incremental backup. The automatic renaming changes the names of existing backed-up file spaces that are not in Unicode in server storage. Then, the file spaces are backed up in Unicode. You can use this parameter for Unicode-enabled IBM Spectrum Protect clients by using Windows, Macintosh OS X, and NetWare operating systems.

After the client with support for Unicode is installed, any new file spaces that the client backs up are stored in server storage by using the UTF-8 code page. UTF-8 is a byte-oriented encoding form that is specified by the Unicode Standard.

You can specify one of the following values:

**Yes**

Existing file spaces are automatically renamed when you upgrade to a client that supports Unicode and the client runs one of the following operations: archive, selective backup, full incremental backup, or partial incremental backup. The renaming occurs whether the client uses the graphical user interface, the command line, or the client scheduler.

For example, the server renames a drive as follows:

```
Original name: D_DRIVE  
New name: D_DRIVE_OLD
```

The new name indicates that the file space is stored on the server in a format that is not Unicode.

**No**

Existing file spaces are not automatically renamed when the client system upgrades to a client that supports Unicode, and the client runs one of the following operations: archive, selective backup, full incremental backup, or partial incremental backup.

**Client**

The option AUTOFSRENAME in the client's option file determines whether file spaces are renamed.

By default, the client option is set to PROMPT. When the client system upgrades to a client that supports Unicode and the client runs an IBM Spectrum Protect operation with the graphical user interface or the command line, the program displays a one-time prompt to the user about whether to rename file spaces.

When the client scheduler runs an operation, the program does not prompt for a choice about renaming, and does not rename file spaces. Backups of existing file spaces are sent as before (not in Unicode).

**VALIDateprotocol (deprecated)**

Specifies whether IBM Spectrum Protect completes a cyclic redundancy check (CRC) to validate the data that is sent between the client and server. The parameter is optional. The default is NO.

Important: Beginning in V8.1.2, this parameter is deprecated. The validation that was enabled by this parameter is replaced by the TLS 1.2 protocol, which is enforced by the SESSIONSECURITY parameter. The VALIDATEPROTOCOL parameter is ignored. Update your configuration to use the SESSIONSECURITY parameter.

**TXNGroupmax**

Specifies the number of files per transaction commit that are transferred between a client and a server. The parameter is optional. Client performance might be improved by using a larger value for this option.

The default value is 0. Specifying 0 indicates that the node uses the server global value that is set in the server options file. To use a value other than the server global value, specify a value of 4 through 65,000 for this parameter. The node value takes precedence over the server value.

Attention: Increasing the TXNGROUPMAX value increases the recovery log usage. Higher recovery log usage might increase the risk of running out of log space. Evaluate the performance of each node before you change the parameter.

#### DATAWritepath

Specifies the transfer path that is used when the client sends data to the server, storage agent, or both, during storage operations such as backup or archive. The parameter is optional. The default is ANY.

Note: If a path is unavailable, the node cannot send any data. For example, if you select the LAN-free option but a LAN-free path is not defined, the operation fails.

You can specify one of the following values:

##### ANY

Specifies that data is sent to the server, storage agent, or both, by any available path. A LAN-free path is used if one is available. If a LAN-free path is unavailable, the data is moved by using the LAN.

##### LAN

Specifies that data is sent by using the LAN.

##### LANFree

Specifies that data is sent by using a LAN-free path.

#### DATAReadpath

Specifies the transfer path that is used when the server, storage agent, or both read data for a client, during operations such as restore or retrieve. The parameter is optional. The default is ANY.

Note: If a path is unavailable, data cannot be read. For example, if you select the LAN-free option but a LAN-free path is not defined, the operation fails. The value for the transfer path also applies to failover connections. If the value is set to LANFree, failover cannot occur for the node on the secondary server.

You can specify one of the following values:

##### ANY

Specifies that the server, storage agent, or both use any available path to read data. A LAN-free path is used if one is available. If a LAN-free path is unavailable, the data is read by using the LAN.

##### LAN

Specifies that data is read by using the LAN.

##### LANFree

Specifies that data is read by using a LAN-free path.

#### TARGETLevel

Specifies the client deployment package that is targeted for this node. You can substitute an applicable release package for Version.Release.Modification.Fix (V.R.M.F) Level. For example: `TARGETLevel=6.2.0.0`.

You must specify each segment with a number that is applicable to a deployment package. You cannot use an asterisk in any field as a substitution for a valid number. The parameter is optional.

Restriction: The TARGETLEVEL parameter does not apply to nodes with a type of NAS or SERVER.

#### SESSIONInitiation

Controls whether the server or the client initiates sessions. The default is that the client initiates sessions. The parameter is optional.

##### Clientorserver

Specifies that the client might initiate sessions with the server by communicating on the TCP/IP port that is defined with the server option TCPPOINT. Server-prompted scheduling might also be used to prompt the client to connect to the server.

##### SERVEROnly

Specifies that the server does not accept client requests for sessions. All sessions must be initiated by server-prompted scheduling on the port that is defined for the client with the REGISTER or UPDATE NODE commands. You cannot use the client acceptor, dsmcad, to start the scheduler when SESSIONINITIATION is set to SERVERONLY.

##### HLAddress

Specifies the client IP address that the server contacts to initiate scheduled events. This parameter must be used when SESSIONINITIATION is set to SERVERONLY, regardless of any addresses that are previously used by the client to contact the server.

The address can be specified either in numeric or host name format. If a numeric address is used, it is saved without verification by a domain name server. If the address is not correct, it can cause failures when the

server attempts to contact the client. Host name format addresses are verified with a domain name server. Verified names are saved and resolved with Domain Name Services when the server contacts the client.

#### LLAddress

Specifies the client port number on which the client listens for sessions from the server. This parameter must be used when SESSIONINITIATION is set to SERVERONLY, regardless of any addresses that are previously used by the client to contact the server.

The value for this parameter must match the value of client option TCPCLIENTPORT. The default value is 1501.

#### EMAILAddress

This parameter is used for more contact information. The parameter is optional. The information that is specified by this parameter is not acted upon by IBM Spectrum Protect.

#### DEDUPLICATION

Specifies where data deduplication can occur for this node. The parameter is optional. You can specify one of the following values:

##### Clientorserver

Specifies that data that is stored by this node can be deduplicated on either the client or the server. This value is the default. For data deduplication to take place on the client, you must also specify a value of YES for the DEDUPLICATION client option. You can specify this option in the client option file or in the client option set on the IBM Spectrum Protect server.

##### SERVEROnly

Specifies that data that is stored by this node can be deduplicated on the server only.

#### BACKUPINITiation

Specifies whether the non-root user ID on the client node can back up files to the server. The parameter is optional. The default value is ALL, indicating that non-root user IDs can back up data to the server. You can select one of the following values:

##### All

Specifies that non-root user IDs can back up files to the server. ALL is the default if BACKUPINITIATION is not specified.

##### ROOT

Specifies that the root user ID can back up files to the server. If you are using the V6.4 or later backup-archive client, authorized users have the same privileges as the root user ID.

Restriction: The attribute is ignored by the server if the backup-archive client connects from an operating system other than AIX, Linux, Solaris, or Mac OS.

Remember: The application programming interface (API) is affected by the BACKUPINITIATION parameter on the server. By default, all API users are allowed to back up data. Setting the parameter to ROOT on an API node is not recommended.

#### REPLState

Specifies whether data that belongs to the client node is ready to be replicated. This parameter is optional. Specify this parameter only if you are issuing the REGISTER NODE command on a server that is configured to replicate data to a target replication server. If you register a client node on a source replication server and set up replication for the node, do not register the node on the target replication server. The client node is created automatically on the target server the first time that replication occurs.

You can select one of the following values:

##### ENabled

Specifies that the client node is configured for replication and is ready to replicate. When you specify this parameter, the replication mode in the client node definition on the source replication server is automatically set to SEND. This setting indicates that data that belongs to the client node is sent to a target server during replication.

When replication first occurs for the client node, the replication state of the node on the target replication server is automatically set to ENABLED. The replication mode on the target replication server is set to RECEIVE. This setting indicates that data that belongs to the client node is received from a source replication server. To determine the replication state and mode, issue the QUERY NODE command on a source or a target replication server.

##### DISabled

Specifies that the node is configured for replication but that replication does not occur until you enable it.

#### BKREPLRuledefault, ARREPLRuledefault, and SPREPLRuledefault

Specifies the replication rule that applies to a data type if the file space rules for the data type are set to DEFAULT.

Restriction: You can specify the BKREPLRULEDEFAULT, ARREPLRULEDEFAULT, or SPREPLRULEDEFAULT parameter only if you specify the REPLSTATE parameter.

#### BKREPLRuledefault

Specifies the replication rule for backup data.

#### ARREPLRuledefault

Specifies the replication rule for archive data.

#### SPREPLRuledefault

Specifies the replication rule for space-managed data.

If the file space rules for the data type are set to DEFAULT and you do not specify a rule for the BKREPLRULEDEFAULT, ARREPLRULEDEFAULT, or SPREPLRULEDEFAULT parameter, data is replicated according to the server rule for the data type.

You can specify normal-priority replication or high-priority replication rules. In a replication process that includes both normal and high-priority data, high-priority data is replicated first. Before you specify a rule, consider the order in which you want the data to be replicated.

You can specify the following rules:

#### ALL\_DATA

Replicates active and inactive backup data, archive data, or space-managed data. The data is replicated with a normal priority.

#### ACTIVE\_DATA

Replicates only active backup data. The data is replicated with a normal priority. This rule is valid only for BKREPLRULEDEFAULT.

Attention:

If you specify ACTIVE\_DATA and one or more of the following conditions are true, inactive backup data on the target replication server is deleted, and inactive backup data on the source replication server is not replicated.

- When a release version earlier than Version 7.1.1 is installed on either the source or target replication servers.
- When you are using the REPLICATE NODE command with the FORCERECONCILE=YES parameter.
- When you are running the initial replication of a file space after you configure replication, restore the database, or upgrade both the source and target replication servers from a release version earlier than V7.1.1.

If the previous conditions are not true, all new and changed files since the last replication are replicated, including inactive files, and files are deleted when they expire.

#### ALL\_DATA\_HIGH\_PRIORITY

Replicates active and inactive backup data, archive data, or space-managed data. Data is replicated with a high priority.

#### ACTIVE\_DATA\_HIGH\_PRIORITY

This rule is the same as the ACTIVE\_DATA replication rule except data is replicated with a high priority. This rule is valid only for BKREPLRULEDEFAULT.

#### DEFAULT

Replicates data according to the server replication rule for backup data.

For example, suppose that you want to replicate the archive data in all the file spaces that belongs to a client node. Replication of the archive data is a high priority. One method to accomplish this task is to specify ARREPLRULEDEFAULT=DEFAULT. Ensure that the file space rules for archive data are also set to DEFAULT and that the server rule for archive data is set to ALL\_DATA\_HIGH\_PRIORITY.

Restriction: If a node is configured for replication, the file space rules are set to DEFAULT after the node stores data on the source replication server.

#### NONE

Data of the specified type is not replicated.

For example, if you do not want to replicate space-managed data that belongs to a client node, specify SPREPLRULEDEFAULT=NONE

#### RECOVERDamaged

Specifies whether damaged files can be recovered for this node from a target replication server. The parameter is optional. The default value is YES. You can specify one of the following values:

Yes

Specifies that recovery of damaged files from a target replication server is enabled for this node.

No

Specifies that recovery of damaged files from a target replication server is not enabled for this node.

Tip: The value of the RECOVERDAMAGED parameter is only one of several settings that determine whether damaged files are recovered. For information about how to specify the settings, see *Settings that affect the recovery of damaged files*.

## ROLEOVERRIDE

Specifies whether to override the reported role of the client for processor value unit (PVU) estimation reporting. The default is USEREPORTEd. The parameter is optional.

The role reported by the client is either client-device (for example, a workstation) or server-device (for example, file/print server, application server, database). By default, the client reports its role that is based on the client type and the operating system. All clients initially report their role as server-device, except for Backup-Archive Clients running Microsoft Windows workstation distributions (Windows Vista) and Macintosh OS X.

Specify one of the following values:

Client

Specifies a client-device.

Server

Specifies a server-device.

Other

Specifies that this node is not to be used for PVU estimation reporting. This value can be useful when multiple nodes are deployed for a physical system (for example, virtual environments, test nodes, retired nodes, and nodes not in production or clustering).

Usereported

Use the reported role that is provided by the client.

## AUTHentication

This parameter specifies the password authentication method for the node. Specify one of the following values: LDAP or LOCAL. The parameter is optional and defaults to LOCAL. The default can change to LDAP if you use the SET DEFAULTAUTHENTICATION command and specify LDAP.

Local

Specifies that the local IBM Spectrum Protect server database is used.

LDap

Specifies that the node uses an LDAP server for password authentication.

## SSLrequired (deprecated)

Specifies whether the node must use the Secure Sockets Layer (SSL) protocol to communicate with the IBM Spectrum Protect server. The parameter is optional. When you authenticate passwords with an LDAP directory server, you must protect the sessions by using SSL or another network security method.

Important: Beginning with V8.1.2, this parameter is deprecated. The validation that was enabled by this parameter is replaced by the TLS 1.2 protocol, which is enforced by the SESSIONSECURITY parameter. The SSLREQUIRED parameter is ignored. Update your configuration to use the SESSIONSECURITY parameter.

## SESSIONSECurity

Specifies whether the node must use the most secure settings to communicate with an IBM Spectrum Protect server. This parameter is optional.

You can specify one of the following values:

STRict

Specifies that the strictest security settings are enforced for the node. The STRICT value uses the most secure communication protocol available, which is currently TLS 1.2. The TLS 1.2 protocol is used for SSL sessions between the server and the node. To specify whether the server uses TLS 1.2 for the entire session or only for authentication, see the SSL client option.

To use the STRICT value, the following requirements must be met to ensure that the node can authenticate with the server:

- Both the node and server must be using IBM Spectrum Protect software that supports the SESSIONSECURITY parameter.
- The node must be configured to use the TLS 1.2 protocol for SSL sessions between the server and the node.

Nodes set to STRICT that do not meet these requirements are unable to authenticate with the server.

#### TRANSitional

Specifies that the existing security settings are enforced for the node. This is the default value. This value is intended to be used temporarily while you update your security settings to meet the requirements for the STRICT value.

If SESSIONSECURITY=TRANSITIONAL and the node has never met the requirements for the STRICT value, the node will continue to authenticate by using the TRANSITIONAL value. However, after a node meets the requirements for the STRICT value, the SESSIONSECURITY parameter value automatically updates from TRANSITIONAL to STRICT. Then, the node can no longer authenticate by using a version of the client or an SSL/TLS protocol that does not meet the requirements for STRICT. In addition, after a node successfully authenticates by using a more secure communication protocol, the node can no longer authenticate by using a less secure protocol. For example, if a node that is not using SSL is updated and successfully authenticates by using TLS 1.2, the node can no longer authenticate by using no SSL protocol or by using TLS 1.1. This restriction also applies when you use functions such as virtual volumes, when the node authenticates to the IBM Spectrum Protect server as a node from another server.

#### SPLITLARGEObjects

Specifies whether large objects that are stored by this node are automatically split into smaller pieces, by the server, to optimize server processing. The parameter is optional. Specifying Yes causes the server to split large objects (over 10 GB) into smaller pieces when stored by a client node. Specifying No bypasses this process. Specify No only if your primary concern is maximizing throughput of backups directly to tape. The default value is Yes.

### Example: Register a client node that only the root user can back up

---

Register the client node `mete0rite` with password `KingK0ng` to back up files from only the root user to the server.

```
register node mete0rite KingK0ng
backupinit=root
```

### Example: Register a client node and password and set compression on

---

Register the client node `JOEOS2` with the password `SECRETCODE` and assign this node to the `DOM1` policy domain. This node can delete its own backup and archive files from the server. All files are compressed by the client node before they are sent to the server. This command automatically creates a `JOEOS2` administrative user ID with password `SECRETCODE`. In addition, the administrator now has client owner authority to the `JOEOS2` node.

```
register node joeos2 secretcode domain=dom1
  archdelete=yes backdelete=yes
  compression=yes
```

### Example: Grant client owner authority for an existing administrative user

---

Grant client owner authority to an existing administrative user ID, `HELPAADMIN`, when you register the client node `JAN`. This step would not automatically create an administrator ID named `JAN`, but would grant client owner authority for this node to the `HELPAADMIN` administrator.

```
register node jan pwdsafe userid=helpadmin
```

### Example: Register a NAS file server node that uses NDMP operations

---

Register a node name of `NAS1` for a NAS file server that is using NDMP operations. Assign this node to a special NAS domain.

```
register node nas1 pw4pw domain=nasdom type=nas
```

### Example: Register a node and specify the maximum number of files per transaction commit

---

Register a node name of `ED` and set the `TXNGroupmax` to 1,000.

```
register node ed pw45twx txngroupmax=1000
```

### Example: Register a node and allow it to deduplicate data on the client system

---

Register a node name of JIM and allow it to deduplicate data on the client system.

```
register node jim jim deduplication=clientorserver
```

## Example: Register a node name of ED and set the role as a server-device for PVU estimation reporting

---

Register a node name of ED and set the role as a server-device for PVU estimation reporting.

```
register node ed pw45twx roleoverride=server
```

## Example: Register a node on a source replication server

---

Define NODE1 to a source replication server. Specify a replication rule for the backup data that belongs to NODE1 so that active backup data is replicated with a high priority. Enable replication for the node.

```
register node node1 bkreplruledefault=active_data_high_priority replstate=enabled
```

## Example: Register a node that authenticates with an LDAP server

---

Register a node name of NODE17 that must authenticate with an LDAP server.

```
register node node17 authentication=ldap
```

Tip: When you register a node in this way, an administrative user ID is not created.

## Example: Register a node to communicate with a server by using strict session security

---

Register a node name of NODE4 to use the strictest security settings to authenticate with the server.

```
register node node4 sessionsecurity=strict
```

## Example: Register a node and enable recovery of damaged files

---

Register a node name of PAYROLL. For the PAYROLL node, enable the recovery of damaged files from a target replication server.

```
register node payroll recoverdamaged=yes
```

## Related commands

---

Table 2. Commands related to REGISTER NODE

Command	Description
DEFINE ASSOCIATION	Associates clients with a schedule.
DEFINE DATAMOVER	Defines a data mover to the IBM Spectrum Protect server.
DEFINE MACHNODEASSOCIATION	Associates an IBM Spectrum Protect node with a machine.
DELETE FILESPACE	Deletes data associated with client file spaces. If a file space is part of a collocation group and you remove the file space from a node, the file space is removed from the collocation group.
LOCK NODE	Prevents a client from accessing the server.
QUERY FILESPACE	Displays information about data in file spaces that belong to a client.
QUERY NODE	Displays partial or complete information about one or more clients.
QUERY PVUESTIMATE	Displays an estimate of the client-devices and server-devices being managed.
QUERY REPLNODE	Displays information about the replication status of a client node.



Command	Description
REGISTER ADMIN	Defines a new administrator without granting administrative authority.
REMOVE NODE	Removes a client from the list of registered nodes for a specific policy domain.
REMOVE REPLNODE	Removes a node from replication.
RENAME NODE	Changes the name for a client node.
REPLICATE NODE	Replicates data in file spaces that belong to a client node.
RESET PASSEXP	Resets the password expiration for nodes or administrators.
SET DEFAULTAUTHENTICATION	Specifies the default password authentication method for any REGISTER NODE or REGISTER ADMIN commands.
SET PASSEXP	Specifies the number of days after which a password is expired and must be changed.
SET CPUINFOREFRESH	Specifies the number of days between client scans for workstation information used for PVU estimates.
SET DEDUPVERIFICATIONLEVEL	Specifies the percentage of extents verified by the server during client-side deduplication.
SET REPLRECOVERDAMAGED	Specifies whether node replication is enabled to recover damaged files from a target replication server.
UNLOCK NODE	Enables a locked user in a specific policy domain to access the server.
UPDATE ADMIN	Changes the password or contact information associated with any administrator.
UPDATE FILESPACE	Changes file-space node-replication rules.
UPDATE NODE	Changes the attributes that are associated with a client node.

**Related concepts:**

[UNIX and Linux client root and authorized user tasks](#)

**Related information:**

Ssl client option

## REMOVE commands

Use the REMOVE commands to remove an object from IBM Spectrum Protect™.

- REMOVE ADMIN (Delete an administrative user ID)
- [AIX](#) | [Linux](#) | [Windows](#) REMOVE DAMAGED (Remove damaged data from a source storage pool)
- REMOVE NODE (Delete a node or an associated machine node)
- REMOVE REPLNODE (Remove a client node from replication)
- REMOVE REPLSERVER (Remove a replication server)

## REMOVE ADMIN (Delete an administrative user ID)

Use this command to remove an administrative user ID from the system.

You cannot remove the last system administrative user ID or the SERVER\_CONSOLE administrative ID from the system.

For users of Lightweight Directory Access Protocol (LDAP) servers: The information in this documentation applies to the LDAP authentication method that is preferred for IBM Spectrum Protect™ V7.1.7 or later servers. For instructions about using the previous LDAP authentication method, see Managing passwords and logon procedures.

## Privilege class

To issue this command, you must have system privilege.

## Syntax

```
>>-REMOve Admin--admin_name--+-SYNCLdapdelete---No-----><
                                     '-SYNCLdapdelete---+No---+'
                                     '-Yes-'
```

## Parameters

admin\_name (Required)

Specifies the administrative user ID to be removed.

SYNCLdapdelete

Specifies whether to delete the administrative user ID on the Lightweight Directory Access Protocol (LDAP) server.

Yes

Deletes the administrative user ID on the LDAP server.

Restriction: Do not specify a value of YES. (The value of YES is appropriate only for users of the previous LDAP authentication method, which is described in Managing passwords and logon procedures.)

No

Does not delete the administrative user ID on the LDAP server. This is the default value.

## Example: Remove an administrative user ID

Remove an administrative user ID larry that is not defined on an LDAP server. Issue the following command:

```
remove admin larry
```

## Related commands

Table 1. Commands related to REMOVE ADMIN

Command	Description
LOCK ADMIN	Prevents an administrator from accessing IBM Spectrum Protect.
QUERY ADMIN	Displays information about one or more IBM Spectrum Protect administrators.
REGISTER ADMIN	Defines a new administrator without granting administrative authority.
RENAME ADMIN	Changes an IBM Spectrum Protect administrator's name.

AIX Linux Windows

## REMOVE DAMAGED (Remove damaged data from a source storage pool)

After storage pool conversion, use this command to remove damaged data from a storage pool that uses a FILE device class, a tape device class, or a virtual tape library (VTL).

The REMOVE DAMAGED command permanently deletes damaged data from the storage pool.

Tip: Before you remove damaged data from the storage pool, try to recover an undamaged version of the data from a copy or active-data storage pool by issuing the RESTORE STGPOOL command. Recover an undamaged version of the data from a target replication server by issuing the REPLICATE NODE command and specifying the RECOVERDAMAGED=YES parameter.

## Privilege class

To issue this command, you must have restricted storage privilege.

## Syntax

```
.*-----.
```

```
>>-REMOve DAMAgeD--pool_name--+-+-----+----->
      | .,-----, |
      | v         | |
      '---node_name--+'

.-Wait-----No-----
>--+-+-----+----->>
  '-Wait-----+No--+-'
    '-Yes-'
```

## Parameters

### pool\_name (Required)

Specify a primary storage pool that uses a FILE device class, a tape device class, or a virtual tape library (VTL). The storage pool contains the damaged data. This parameter is required.

### node\_name

Specifies the name of the client node. Separate multiple names with commas and no intervening spaces. You can use a wildcard character instead of a node name if you want to remove damage from all of the nodes in the storage pool.

### Wait

Specifies whether to wait for the server to remove damaged data from the storage pool. This parameter is optional. The default value is NO. You can specify this parameter only from an administrative command line. You can specify one of the following values:

#### No

Specifies that the command processes run in the background.

#### Yes

Specifies that the command processes run in the foreground. Messages are not displayed until the command completes processing.

## Example: Remove damaged data from a storage pool and wait for the server to complete processing

Remove damaged data from a storage pool that is named POOL1 and wait for the server to complete processing in the foreground.

```
remove damaged pool1 wait=yes
```

Table 1. Commands related to REMOVE DAMAGED

Command	Description
CONVERT STGPOOL	Convert a storage pool to a directory-container storage pool.
PROTECT STGPOOL	Protects a directory-container storage pool.
REPAIR STGPOOL	Repairs a directory-container storage pool.

## REMOVE NODE (Delete a node or an associated machine node)

Use this command to remove a node from the server. If you are using disaster recovery manager and the node to be removed is associated with a machine, the association between the node and the machine is also deleted.

If a node is part of a collocation group and you remove the node from the server, the node is removed from the collocation group. If a node is removed and the node contained file spaces in a file space collocation group, those file spaces are removed from the group member list.

If you remove a node that stored data in a deduplicated storage pool, the node name DELETED is displayed in the QUERY OCCUPANCY command output until all data deduplication dependencies are removed.

When a node is removed, the corresponding administrative ID is removed only if the following issues are true:

- The administrator name is identical to the node name.
- The administrator has client owner or client access authority *only* to the node that is being removed.
- The administrator is not a managed object.

Before you can remove a node, you must delete all backup and archive file spaces that belong to that node.

Before you can remove a NAS node that has a corresponding data mover, you must complete the following tasks in order:

1. Delete any paths from the data mover
2. Delete the data mover
3. Delete all virtual file space definitions for the node
4. Remove the NAS node

For users of Lightweight Directory Access Protocol (LDAP) servers: The information in this documentation applies to the LDAP authentication method that is preferred for IBM Spectrum Protect™ V7.1.7 or later servers. For instructions about using the previous LDAP authentication method, see *Managing passwords and logon procedures*.

## Privilege class

To issue this command, you must have system privilege, unrestricted policy privilege, or restricted policy privilege for the policy domain to which the client node is assigned.

## Syntax

```

                .-SYNCLdapdelete-----No-----.
>>-REMOve Node--node_name--+-----+-----><
                '-SYNCLdapdelete-----+No--+-'
                                '-Yes-'

```

## Parameters

node\_name (Required)

Specifies the name of the node to be removed.

SYNCLdapdelete

Specifies whether to remove the node from the Lightweight Directory Access Protocol (LDAP) server.

Yes

Specifies that the node is removed.

Restriction: Do not specify a value of YES. (The value of YES is appropriate only for users of the previous LDAP authentication method, which is described in *Managing passwords and logon procedures*.)

No

Specifies that the node is not removed. This is the default value.

## Example: Remove a client node

Remove the client node LARRY.

```
remove node larry
```

## Related commands

Table 1. Commands related to REMOVE NODE

Command	Description
<b>AIX</b>   <b>Windows</b> DELETE MACHNODEASSOCIATION	<b>AIX</b>   <b>Windows</b> Deletes association between a machine and node.
DELETE DATAMOVER	Deletes a data mover.
DELETE FILESPACE	Deletes data associated with client file spaces. If a file space is part of a collocation group and you remove the file space from a node, the file space is removed from the collocation group.
DELETE PATH	Deletes a path from a source to a destination.
DELETE VIRTUALFSMAPPING	Delete a virtual file space mapping.
LOCK NODE	Prevents a client from accessing the server.
QUERY COLLOGGROUP	Displays information about collocation groups.

Command	Description
<b>AIX</b>   <b>Windows</b> QUERY MACHINE	<b>AIX</b>   <b>Windows</b> Displays information about machines.
QUERY NODE	Displays partial or complete information about one or more clients.
QUERY SESSION	Displays information about all active administrator and client sessions with IBM Spectrum Protect.
REGISTER NODE	Defines a client node to the server and sets options for that user.
RENAME NODE	Changes the name for a client node.

## REMOVE REPLNODE (Remove a client node from replication)

Use this command to remove a node from replication if you no longer want to replicate the data that belongs to the node.

You cannot delete client node data by issuing the REMOVE REPLNODE command. You can issue the command on a source or on a target replication server. You can only issue this command from an administrative command-line client. You cannot issue this command from the server console.

If you issue the REMOVE REPLNODE command for a client node whose replication mode is set to SEND or RECEIVE, the mode is set to NONE. The replication state is also set to NONE. After you remove a client node from replication, the target replication server can accept backup, archive, and space-managed data directly from the node.

If a client node is removed from replication, information in the database about replication for the node is deleted. If the client node is enabled for replication later, the replication process replicates all the data that is specified by replication rules and settings.

When you issue the REMOVE REPLNODE command, the data that belongs to a client node is not deleted. To delete file space data that belongs to the client node, issue the DELETE FILESPACE command for each of the file spaces that belong to the node. If you do not want to keep the client node definition, issue the REMOVE NODE command. To delete file space data and the client node definition, issue DELETE FILESPACE and REMOVE NODE on the target replication server.

Restriction: If a node replication process is running for a client node that is specified by this command, the command fails and the replication information for the node is not removed.

### Privilege class

To issue this command, you must have system privilege, unrestricted policy privilege, or restricted policy privilege for the policy domain to which the client node is assigned.

### Syntax

```

      .- ,----- .
      v |
>>-REMOve REPLNode-----+node_name-----+-----><
                          '-node_group_name-'

```

### Parameters

node\_name or node\_group\_name (Required)

Specifies the name of the client node or defined group of client nodes that you want to remove from replication. To specify multiple client node names and client-node group names, separate the names with commas and no intervening spaces.

You can use wildcard characters to specify client node names, but not to specify client-node group names. You cannot combine node or node group names with the domain name.

### Example: Remove three client nodes and a client node group from replication

The names of the client nodes are NODE1, NODE2, and NODE3. The name of the client node group is PAYROLL. Issue the following command on the source and target replication servers:

```
remove replnode node*,payroll
```

## Related commands

---

Table 1. Commands related to REMOVE REPLNODE

Command	Description
QUERY NODE	Displays partial or complete information about one or more clients.
QUERY REPLICATION	Displays information about node replication processes.

## REMOVE REPLSERVER (Remove a replication server)

---

Use this command to remove or to switch to a replication server from the list of replication servers. This command deletes all information about replication state for all nodes that were replicated to that server.

You can issue the command on a source or on a target replication server.

Restriction: You cannot delete client node data by using the REMOVE REPLSERVER command.

Use the command to switch replication servers and to remove replication information for an old server. The command does not affect the current replication mode or state of any node definitions. Issue the command on both the source and target servers to keep the replication state information about both servers consistent.

Restriction: If you specify the default replication server for the REMOVE REPLSERVER command and a node replication process is running, the command fails and no replication information is removed.

This command runs as a background operation and it cannot be canceled. IBM Spectrum Protect™ deletes replication information that is associated with the specified server as a series of batch database transactions. If a system failure occurs, a partial deletion can occur.

## Privilege class

---

To issue this command, you must have system privilege.

## Syntax

---

```
>>-REMOve REPLServer--GUID-----><
```

## Parameters

---

replication\_guid (Required)

The unique identifier for the replication server that is being removed. You can use wildcards to specify the Replication Global Unique Identifier (GUID), however, only one GUID can match the wildcard. If the wildcard sequence matches more than one GUID, the command fails. You must qualify the wildcard string until only the GUID that you want to delete is found.

## Example: Use a wildcard to remove a replication server

---

Remove a replication server by using a wildcard character to indicate the GUID.

```
remove replserver e*
```

## Related commands

---

Table 1. Commands related to REMOVE REPLSERVER

Command	Description
REMOVE REPLNODE (Remove a client node from replication)	Removes a node from replication.

Command	Description
QUERY REPLSERVER (Query a replication server)	Displays information about replicating servers.

## RENAME commands

Use the RENAME commands to change the name of an existing object.

- RENAME ADMIN (Rename an administrator)
- RENAME FILESPACE (Rename a client file space on the server)
- RENAME NODE (Rename a node)
- RENAME SCRIPT (Rename an IBM Spectrum Protect script)
- RENAME SERVERGROUP (Rename a server group)
- RENAME STGPOOL (Change the name of a storage pool)

## RENAME ADMIN (Rename an administrator)

Use this command to change an administrative user ID. Existing information for this administrator such as password, contact information, and privilege classes is not altered.

If you assign an existing administrative user ID to another person, use the UPDATE ADMIN command to change the password.

When an administrator and a node share a name and you change the administrator authentication method, the node authentication method also changes. If you rename an administrator to the same name as an existing node, the authentication method and the SSLREQUIRED setting for the node can change. If those settings are different, after the renaming, both administrator and node will have the same authentication method and SSLREQUIRED setting.

For users of Lightweight Directory Access Protocol (LDAP) servers:

- The information in this documentation applies to the LDAP authentication method that is preferred for IBM Spectrum Protect™ V7.1.7 or later servers. For instructions about using the previous LDAP authentication method, see Managing passwords and logon procedures.
- Do not rename an administrative user ID to match a node name. If the names match, you might see unexpected behavior because of automatic password changes that update the same password twice. As a result, the password might become unknown to the administrative user ID. Alternatively, the password update might fail.

You cannot rename the SERVER\_CONSOLE administrative ID.

## Privilege class

To issue this command, you must have system privilege.

## Syntax

```
>>-REName Admin--current_admin_name--new_admin_name----->
      .-SYNCldapdelete----No-----
>-----+----->>
      '-SYNCldapdelete----+No---+'
                '-Yes-'
```

## Parameters

current\_admin\_name (Required)

Specifies the administrative user ID to be renamed.

new\_admin\_name (Required)

Specifies the new administrative user ID. The maximum length of the name is 64 characters.

SYNCldapdelete

Specifies whether to delete the administrative user ID on the Lightweight Directory Access Protocol (LDAP) server and replace the ID with a new one.

Yes

Deletes the administrative user ID on the LDAP server and replaces it with a new ID.

Restriction: Do not specify a value of YES. (The value of YES is appropriate only for users of the previous LDAP authentication method, which is described in Managing passwords and logon procedures.)

No

Does not delete and replace the administrative user ID on the LDAP server. This is the default value.

## Example: Rename an administrator

Rename the IBM Spectrum Protect administrator CLAUDIA to BILL.

```
rename admin claudia bill
```

## Related commands

Table 1. Commands related to RENAME ADMIN

Command	Description
QUERY ADMIN	Displays information about one or more IBM Spectrum Protect administrators.
UPDATE ADMIN	Changes the password or contact information associated with any administrator.

## RENAME FILESPACE (Rename a client file space on the server)

Use this command to rename an existing client file space on the server to a new file space name or to rename imported file spaces.

You might want to rename a file space that was imported or to cause the creation of new Unicode-enabled file spaces for Unicode-enabled clients.

Restriction: Do not rename NAS or VMware file spaces. If you rename a NAS or VMware file space, it is no longer visible and cannot be restored. To restore a renamed NAS or VMware file space, you must rename it back to its original name and set the force parameter as follows:force=yes

## Privilege class

Any administrator with unrestricted policy authority or with restricted policy authority over the client's policy domain can issue this command.

## Syntax

```
>>-REName Filespace--node_name----->
>--current_file_space_name--new_file_space_name----->
.-NAMEType-----SERVER-----
>+-----+----->
'-NAMEType-----+SERVER--+'
      +-UNICODE+
      '-FSID----'
.-NEWNAMEType-----SERVER-----
>+-----+-----+-----><
|                                     (1) | '-force---yes-'
'-NEWNAMEType-----+UNICODE---+'
      '-HEXadecimal-'
```

Notes:

1. This parameter is the default when you specify NAMEType=UNICODE.



## Parameters

---

### node\_name (Required)

Specifies the name of the client node to which the file space to be renamed belongs.

### current\_file\_space\_name (Required)

Specifies the name of the file space to be renamed. A file space name is case-sensitive and must be specified exactly as defined to the server. Virtual file space mapping names are allowed.

### new\_file\_space\_name (Required)

Specifies the new name for the file space. A client file space name is case-sensitive and must be specified exactly as it is to be defined to the server. This parameter cannot be an existing virtual file space mapping name. If the `current_file_space_name` is a virtual file space, the `new_file_space_name` must follow all the rules for defining a virtual file space name. See the `DEFINE VIRTUALFSMAPPING` command for more information.

Important: If the new name type is hexadecimal, specify valid UTF-8 hexadecimal values so the server's code page displays the file space name as intended. For example, do not specify a value that can be interpreted as a backspace. When you rename a file space that is part of a file space collocation group, the collocation group is updated with the new name.

### NAMEType

Specify how you want the server to interpret the current file space name that you enter. This parameter is useful when the server has clients with support for Unicode. You can use this parameter for Unicode-enabled IBM Spectrum Protect™ clients with Windows, Macintosh OS X, and NetWare operating systems.

The default value is `SERVER`. If a virtual file space mapping name is specified, you must use `SERVER`. Possible values are:

#### SERVER

The server uses the server's code page to interpret the file space name.

#### UNICODE

The server converts the file space name that is entered from the server code page to the UTF-8 code page. The success of the conversion depends on the actual characters in the name and the server's code page. Conversion can fail if the string includes characters that are not available in the server code page, or if the server cannot access system conversion routines.

#### FSID

The server interprets the file space name as the file space ID (FSID).

### NEWNAMETYPE

Specify how you want the server to interpret the new file space name that you enter. The default is `SERVER` if you specified the `NAMETYPE` as `SERVER`, or if the file space to be renamed is not Unicode. The default is `UNICODE` if you specified the `NAMETYPE` as `UNICODE`, or if the file space to be renamed is Unicode. If a virtual file space mapping name is specified, you must use `SERVER`. Possible values are:

#### SERVER

The server uses the server's code page to interpret the file space name.

#### UNICODE

The server converts the file space name that is entered from the server code page, to the UTF-8 code page. The success of the conversion depends on the actual characters in the name and the server's code page. If the conversion is not successful, you might want to specify the `HEXADECIMAL` parameter.

#### HEXADECIMAL

The server interprets the file space name that you enter as the hexadecimal representation of a name in Unicode. Using hexadecimal ensures that the server is able to correctly rename the file space, regardless of the server's code page.

To view the hexadecimal representation of a file space name, you can use the `QUERY FILESPACE` command with `FORMAT=DETAILED`.

Restriction: You cannot specify a new name of a type that is different from the original name. You can rename a file space that is Unicode to another name in Unicode. You can rename a file space that is not Unicode, and use a new name in the server's code page. You cannot mix the two types.

### force

To rename a NAS or VMware file space you must set this parameter as follows: `force=yes`

## Rename an imported file space to prevent overwriting

---

An AIX® client node named LARRY backed up file space `/r033` to the IBM Spectrum Protect server. The file space was exported to tape and later reimported to the server. When this file space was imported, a system-generated name, `/r031`, was created for it because `/r033` existed for client node LARRY.

Client node LARRY, however, already had a file space named /r031 that was not backed up, therefore, was unknown to the server. Unless the imported file space is renamed, it overlays file space /r031 because the file space name generated by the IMPORT function is the same as a file space on client node LARRY that is unknown to the server.

Use the following command to rename imported file space /r031. The new name, /imported-r033, identifies that the new file space is an imported image of file space /r033.

```
rename filepace larry /r031 /imported-r033
```

## Rename file space to create a Unicode-enabled file space

Client JOE is using an English Unicode-enabled IBM Spectrum Protect client. JOE backed up several large file spaces that are not Unicode that is enabled in server storage. File space \\joe\c\$ contains some files with Japanese file names that cannot be backed up to a file space that is not Unicode that is enabled. Because the file spaces are large, the administrator does not want to convert all of JOE's file spaces to Unicode-enabled file spaces now. The administrator wants to rename only the non-Unicode file space, \\joe\c\$, so that the next backup of the file space causes the creation of a new Unicode-enabled file space. The new Unicode-enabled file space allows the Japanese files to be successfully backed up.

Use the following command to rename \\joe\c\$:

```
rename filepace joe \\joe\c$ \\joe\c$_old
```

## Related commands

Table 1. Commands related to RENAME FILESPACE

Command	Description
DEFINE VIRTUALFSMAPPING	Define a virtual file space mapping.
DELETE FILESPACE	Deletes data associated with client file spaces. If a file space is part of a collocation group and you remove the file space from a node, the file space is removed from the collocation group.
EXPORT NODE	Copies client node information to external media or directly to another server.
QUERY FILESPACE	Displays information about data in file spaces that belong to a client.
QUERY OCCUPANCY	Displays file space information by storage pool.

## RENAME NODE (Rename a node)

Use this command to rename a node.

If you are assigning an existing node ID to another person, use the UPDATE NODE command to change the password.

For users of Lightweight Directory Access Protocol (LDAP) servers:

- The information in this documentation applies to the LDAP authentication method that is preferred for IBM Spectrum Protect™ V7.1.7 or later servers. For instructions about using the previous LDAP authentication method, see Managing passwords and logon procedures.
- Do not rename a node to match an existing administrative user ID. If you rename a node, and the node name matches an administrative user ID, you might see unexpected behavior because of automatic password changes that update the same password twice. As a result, the password might become unknown to the administrative user ID. Alternatively, the password update might fail.

Restrictions:

- You cannot rename a NAS node name that has a corresponding data mover defined. If the data mover has defined paths, the paths must first be deleted.
- If a node is configured for replication, it cannot be renamed.

If you rename a node to the same name as an existing administrator, the administrator authentication method and SSLREQUIRED setting are updated to match the node. When a node and an administrator share a name and you change the node authentication

method or the node SSLREQUIRED setting, the administrator settings also change. You must have system level authority to update the node authentication method or the node SSLREQUIRED setting and also update a same-named administrator.

## Privilege class

You must have system privilege, unrestricted policy privilege, or restricted policy privilege for the policy domain to which the client node is assigned.

## Syntax

```
>>-REName Node--current_node_name--new_node_name----->
      .-SYNCLdapdelete---No-----
>--+-----+-----><
      '-SYNCLdapdelete---+No---+'
                          '-Yes-'
```

## Parameters

current\_node\_name (Required)

Specifies the name of the node to be renamed.

new\_node\_name (Required)

Specifies the new name of the node. The maximum length is 64 characters.

SYNCLdapdelete

Specifies whether the node name is deleted and replaced on the Lightweight Directory Access Protocol (LDAP) server.

Yes

Specifies that the node name is deleted and replaced.

Restriction: Do not specify a value of YES. (The value of YES is appropriate only for users of the previous LDAP authentication method, which is described in Managing passwords and logon procedures.)

No

Specifies that the node name is not deleted and replaced. This is the default value.

## Example: Rename a node

Rename the node JOE to JOYCE.

```
rename node joe joyce
```

## Example: Rename a node that shares a namespace with other servers

Rename the node JOYCE to JOE and do not delete the previous name from corresponding LDAP servers.

```
rename node joyce joe
```

## Related commands

Table 1. Commands related to RENAME NODE

Command	Description
QUERY NODE	Displays partial or complete information about one or more clients.
UPDATE NODE	Changes the attributes that are associated with a client node.

### Related tasks:

Managing NAS file server nodes

## RENAME SCRIPT (Rename an IBM Spectrum Protect script)

Use this command to rename an IBM Spectrum Protect™ script.

## Privilege class

---

To issue this command, you must have operator, policy, system, storage, or system privilege.

## Syntax

---

```
>>-REName SCRIPT--current_script_name--new_script_name -----<<
```

## Parameters

---

current\_script\_name (Required)

Specifies the name of the script to rename.

new\_script\_name (Required)

Specifies the new name for the script. The name can contain as many as 30 characters.

## Example: Rename a script

---

Rename SCRIPT1 to a new script named SCRIPT2.

```
rename script script1 script2
```

## Related commands

---

Table 1. Commands related to RENAME SCRIPT

Command	Description
COPY SCRIPT	Creates a copy of a script.
DEFINE SCRIPT	Defines a script to the IBM Spectrum Protect server.
DELETE SCRIPT	Deletes the script or individual lines from the script.
QUERY SCRIPT	Displays information about scripts.
RUN	Runs a script.
UPDATE SCRIPT	Changes or adds lines to a script.

## RENAME SERVERGROUP (Rename a server group)

---

Use this command to rename a server group.

## Privilege class

---

To issue this command, you must have system privilege.

## Syntax

---

```
>>-REName SERVERGroup--current_group_name--new_group_name-----<<
```

## Parameters

---

current\_group\_name (Required)

Specifies the server group to rename.

new\_group\_name (Required)

Specifies the new name of the server group. The maximum length of the name is 64 characters.

## Example: Rename a server group

---

Rename server group WEST\_COMPLEX to BIG\_WEST.

```
rename servergroup west_complex big_west
```

## Related commands

---

Table 1. Commands related to RENAME SERVERGROUP

Command	Description
COPY SERVERGROUP	Creates a copy of a server group.
DEFINE SERVERGROUP	Defines a new server group.
DELETE SERVERGROUP	Deletes a server group.
QUERY SERVERGROUP	Displays information about server groups.
UPDATE SERVERGROUP	Updates a server group.

## RENAME STGPOOL (Change the name of a storage pool)

---

Use this command to change the name of a storage pool. You can change storage pool names to use the same names on a configuration manager and its managed servers.

When you rename a storage pool, any administrators with restricted storage privilege for the old storage pool automatically retain restricted storage privilege for the renamed storage pool. If the renamed storage pool is in a storage pool hierarchy, the hierarchy is preserved. You must update the management class or copy group to specify the new storage pool name as the destination for files.

If processes are active when a storage pool is renamed, the old name might still be displayed in messages or queries for those processes.

### Privilege class

---

To issue this command, you must have system privilege.

### Syntax

---

```
>>-REName STGpool--current_pool_name--new_pool_name-----<<
```

### Parameters

---

current\_pool\_name (Required)

Specifies the storage pool to rename.

new\_pool\_name (Required)

Specifies the new name of the storage pool. The maximum length of the name is 30 characters.

### Example: Change the name of a storage pool

---

Rename storage pool STGPOOLA to STGPOOLB:

```
rename stgpool stgpoola stgpoolb
```

## Related commands

---

Table 1. Commands related to RENAME STGPOOL

Command	Description
BACKUP STGPOOL	Backs up a primary storage pool to a copy storage pool.
DEFINE STGPOOL	Defines a storage pool as a named collection of server storage media.
DELETE STGPOOL	Deletes a storage pool from server storage.

Command	Description
QUERY STGPOOL	Displays information about storage pools.
RESTORE STGPOOL	Restores files to a primary storage pool from copy storage pools.
UPDATE STGPOOL	Changes the attributes of a storage pool.

AIX Linux Windows

## REPAIR STGPOOL (Repair a directory-container storage pool)

Use this command to repair deduplicated extents in a directory-container storage pool. Damaged deduplicated extents are repaired with extents that are backed up to the target replication server or to container-copy storage pools on the same server.

Restrictions:

- You can issue the REPAIR STGPOOL command only if you already issued the PROTECT STGPOOL command to back up data to another storage pool on a replication target server or on the same server.
- When you repair a directory-container storage pool from the replication server, the REPAIR STGPOOL command fails when any of the following conditions occur:
  - The target server is unavailable.
  - The target storage pool is damaged.
  - A network outage occurs.
- When you repair a directory-container storage pool from container-copy pools, the REPAIR STGPOOL command fails when any of the following conditions occur:
  - The container-copy storage pool is unavailable.
  - The container-copy storage pool is damaged.

### Privilege class

To issue this command, you must have system privilege.

### Syntax when the source is the replication server

```

                .-SRCLOCation-----Replserver-.
>>-REPAir STGPool--pool_name-----+----->
                '-SRCLOCation-----Replserver-'

                .-MAXSESSions-----1-----
>--+-----+----->
                '-MAXSESSions-----number_sessions--'

                .-Preview-----No----- .-Wait-----No-----
>--+-----+-----><
                '-Preview-----+No--+-' '-Wait-----+No--+-'
                    '-Yes-'                '-Yes-'

```

### Syntax when the source is a storage pool on the same server

```

>>-REPAir STGPool--pool_name--SRCLOCation-----Local----->

                .-Preview-----No----- .-Wait-----No-----
>--+-----+-----><
                '-Preview-----+No--+-' '-Wait-----+No--+-'
                    '-Yes-'                '-Yes-'

```

### Parameters

pool\_name (Required)

Specifies the name of the directory-container storage pool that contains the data that must be repaired.

SRCLOCation

Specifies the source location that is used to repair the data. The default value is REPLSERVER. This parameter is only required when the source location is on the same server. You can specify one of the following values:

Local

Specifies that the data is repaired from container-copy storage pools on the same server.

Replserver

Specifies that the data is repaired from a directory-container storage pool on the target replication server.

MAXSESSions

Specifies the maximum number of data sessions that can send data to a target server. This parameter is optional when you repair data from a replication server.

The value that you specify can be in the range 1 - 20. The default value is 1. If you increase the number of sessions, you can repair the storage pool faster.

When you set a value for the MAXSESSIONS parameter, ensure that the available bandwidth and the processor capacity of the source and target servers are sufficient.

Tips:

- If you issue a QUERY SESSION command, the total number of sessions might exceed the number of data sessions.
- The number of sessions that are used to repair storage pools depends on the amount of data that is repaired. If you repair only a small amount of data, there is no benefit to increasing the number of sessions.

Preview

Specifies whether to preview data or to repair the data. This parameter is optional. The default value is NO. You can specify one of the following values:

No

Specifies that the data is repaired to the storage pool but the data is not previewed.

Yes

Specifies that the data is previewed but not repaired.

Wait

Specifies whether to wait for the server to complete the repair processing of the storage pool. This parameter is optional. The default value is NO. You can specify this parameter only from an administrative command line. You can specify one of the following values:

No

Specifies that the command processes run in the background. To monitor the background processing of the REPAIR STGPOOL command, issue the QUERY PROCESS command.

Yes

Specifies that the command processes run in the foreground. Messages are not displayed until the command completes processing.

## Example: Repair a storage pool and preview the data

---

Repair a storage pool that is named POOL1 and preview the data.

```
repair stgpool pool1 preview=yes
```

## Example: Repair a storage pool and specify a maximum number of sessions

---

Repair a storage pool that is named POOL1 and specify 10 maximum sessions.

```
repair stgpool pool1 maxsessions=10
```

## Example: Repair a storage pool from tape

---

Repair a storage pool that is named POOL1 and specify local for the source location.

```
repair stgpool pool1 SRCLocation=local
```

Table 1. Commands related to REPAIR STGPOOL

Command	Description
---------	-------------

Command	Description
DEFINE STGPOOL (directory-container)	Define a directory-container storage pool.
DEFINE STGPOOL (container-copy)	Define a container-copy storage pool that stores copies of data from a directory-container storage pool.
DEFINE STGPOOLDIRECTORY	Defines a storage pool directory to a directory-container or cloud-container storage pool.
PROTECT STGPOOL	Protects a directory-container storage pool.

## REPLICATE NODE (Replicate data in file spaces that belong to a client node)

Use this command to replicate data in file spaces that belong to one or more client nodes or defined groups of client nodes.

When you issue this command, a process is started in which data that belongs to the specified client nodes is replicated according to replication rules. Files that are no longer stored on the source replication server, but that exist on the target replication server, are deleted during this process.

If a node replication process is already running for a client node that is specified by this command, the node is skipped, and replication begins for other nodes that are enabled for replication.

After the node replication process is completed, a recovery process can be started on the target replication server. Files are recovered only if all the following conditions are met:

- Version 7.1.1 or later, is installed on the source and target replication servers.
- The REPLRECOVERDAMAGED system parameter is set to ON. The system parameter can be set by using the SET REPLRECOVERDAMAGED command.
- The source server includes at least one file that is marked as damaged in the node that is being replicated.
- The node data was replicated before the damage occurred.

The following table describes how settings affect the recovery of damaged, replicated files.

Restriction: You cannot use the REPLRECOVERDAMAGED parameter for directory-container or cloud storage pools.

Table 1. Settings that affect the recovery of damaged files

Setting for the REPLRECOVERDAMAGED system parameter	Value of the RECOVERDAMAGED parameter on the REPLICATE NODE command	Value of the RECOVERDAMAGED parameter on the REGISTER NODE and UPDATE NODE commands	Result
OFF	YES, NO, or not specified	YES or NO	During node replication, standard replication occurs and damaged files are not recovered from the target replication server.
OFF	ONLY	YES or NO	An error message is displayed because files cannot be recovered when the REPLRECOVERDAMAGED system parameter is set to OFF.
ON	YES	YES or NO	During node replication, standard replication occurs and damaged files are recovered from the target replication server.
ON	NO	YES or NO	During node replication, standard replication occurs and damaged files are not recovered from the target replication server.
ON	ONLY	YES or NO	Damaged files are recovered from the target replication server, but standard node replication does not occur.





```

>----->
|           .-,------. |
|           V              |
'-DATAtype-----+All-----+'
|                   |
|                   +-BACKUP-----+
|                   +-BACKUPActive--+
|                   +-ARCHive-----+
|                   '-SPACEManaged-'
|
|.-PRIORITY---ALL-----|
>----->
'-PRIORITY---+ALL-----+'
|                   |
|                   +-HIGH---+
|                   '-NORMAL-'
|
|.-MAXSESSions---10-----|
>----->
'-MAXSESSions-----number_sessions---'
|
|.-Preview---No-----|
>----->
'-Preview---+No-----+'
|                   |
|                   .-LISTfiles---No-----|
|                   '-Yes-----+'
|                   '-LISTfiles---+No--+-'
|                   '-Yes-'
|
|.-Wait---No-----|
>----->
'-Wait---+No--+-'   '-RECOVERDamaged---+Yes--+-'
|                   |                   |
|                   '-Yes-'           +-No---+
|                                   '-Only-'
|
|.-FORCEREConcile---No-----|
>----->
'-FORCEREConcile---+No--+-'
|                   '-Yes-'
|
|.-TRANSFERMethod---Tcpi-----|
>----->
'-TRANSFERMethod---+Tcpi-----+'
|                   |
|                   (3) |
|                   '-Fasp-----'

```

#### Notes:

1. Do not mix file space identifiers (FSIDs) and file space names in the same command.
2. Do not specify FSID if you use wildcard characters for the client node name.
3. **Linux** The TRANSFERMETHOD parameter is available only on Linux x86\_64 operating systems.

## Parameters

### node\_name or node\_group\_name (Required)

Specifies the name of the client node or defined group of client nodes whose data is to be replicated. You can also specify a combination of client node names and client-node group names. To specify multiple client node names or client-node group names, separate the names with commas with no intervening spaces. You can use wildcard characters with client node names but not with client-node group names. The replication rules for all file spaces in the specified client nodes are checked.

### filespace\_name or FSID

Specifies the name of the file space or the file space identifier (FSID) to be replicated. A name or FSID is optional. If you do not specify a name or an FSID, all the data in all the file spaces for the specified client nodes is eligible for replication.

### filespace\_name

Specifies the name of the file space that has data to be replicated. File space names are case-sensitive. To determine the correct capitalization for the file space, issue the QUERY FILESPACE command. Separate multiple names with commas with no intervening spaces. When you specify a name, you can use wildcard characters.

A server that has clients with file spaces that are enabled for Unicode might have to convert the file space name. For example, the server might have to convert a name from the server code page to Unicode. For details, see the NAMETYPE parameter. If you do not specify a file space name, or if you specify a single wildcard character for the name, you can use the CODETYPE parameter to limit the operation to Unicode file spaces or to non-Unicode file spaces.

#### FSID

Specifies the file space identifier for the file space to be replicated. The server uses FSIDs to find the file spaces to replicate. To determine the FSID for a file space, issue the QUERY FILESPACE command. Separate multiple FSIDs with commas with no intervening spaces. If you specify an FSID, the value of the NAMETYPE parameter must be FSID.

#### NAMETYPE

Specifies how you want the server to interpret the file space names that you enter. You can use this parameter for IBM Spectrum Protect™ clients that are enabled for Unicode and that have Windows, Macintosh OS X, or NetWare operating systems.

Use this parameter only when you enter a partly qualified or fully qualified file space name. The default value is SERVER. You can specify one of the following values:

##### SERVER

The server uses the server code page to interpret file space names.

##### UNICODE

The server converts file space names from the server code page to the UTF-8 code page. The success of the conversion depends on the characters in the name and the server code page. Conversion can fail if the string includes characters that are not available in the server code page or if the server cannot access system conversion routines.

##### FSID

The server interprets file space names by using their file space identifiers.

#### CODETYPE

Specifies the type of file spaces to be included in node replication processing. Use this parameter only when you enter a single wildcard character for the file space name. The default value is BOTH, which specifies that file spaces are included regardless of code page type. You can specify one of the following values:

##### UNICODE

Specifies file spaces that are only in Unicode.

##### NONUNICODE

Specifies file spaces that are not in Unicode.

##### BOTH

Specifies all file spaces regardless of code page type.

#### DATATYPE

Specifies the type of data to be replicated. Data is replicated according to the replication rule that applies to the data type. This parameter is optional. You can specify one or more data types. If you do not specify a data type, all backup, archive, and space-managed data is replicated. Separate multiple data types with commas with no intervening spaces. You cannot use wildcard characters. You can specify one of the following values:

##### ALL

Replicates all backup, archive, and space-managed data in a file space according to the rule that is assigned to the data type. For example, suppose that NODE1 has a single file space. The following replication rules apply:

- The file space rules for backup and archive data in the file space are set to ALL\_DATA.
- The file space rule for space-managed data is set to DEFAULT.
- The client node rule for space-managed data is set to NONE.

If you issue `REPLICATE NODE NODE1 DATATYPE=ALL`, only backup data and archive data are replicated.

##### BACKUP

Replicates active and inactive backup data in a file space if the controlling replication rule is ALL\_DATA, ACTIVE\_DATA, ALL\_DATA\_HIGH\_PRIORITY, or ACTIVE\_DATA\_HIGH\_PRIORITY.

##### BACKUPActive

Replicates only active backup data in a file space if the controlling replication rule is ACTIVE\_DATA or ACTIVE\_DATA\_HIGH\_PRIORITY.

##### ARCHIVE

Replicates archive data only in a file space if the controlling replication rule is ALL\_DATA or ALL\_DATA\_HIGH\_PRIORITY.

SPACEManaged

Replicates only space-managed data in a file space if the controlling replication rule is ALL\_DATA or ALL\_DATA\_HIGH\_PRIORITY.

PRIOrity

Specifies the data to replicate based on the priority of the replication rule. You can specify one of the following values:

All

Replicates all data in a file space if the controlling replication rule is ALL\_DATA, ACTIVE\_DATA, ALL\_DATA\_HIGH\_PRIORITY, or ACTIVE\_DATA\_HIGH\_PRIORITY.

High

Replicates only data in a file space that has a controlling replication rule of ALL\_DATA\_HIGH\_PRIORITY or ACTIVE\_DATA\_HIGH\_PRIORITY.

Normal

Replicates only data in a file space that has a controlling replication rule of ALL\_DATA or ACTIVE\_DATA.

MAXSESSions

Specifies the maximum allowable number of data sessions to use for sending data to a target replication server. This parameter is optional. The value can be 1 - 99. The default value is 10.

Increasing the number of sessions can improve node replication throughput.

When you set this value, consider the number of logical and physical drives that can be dedicated to the replication process. To access a sequential-access volume, IBM Spectrum Protect uses a mount point and, if the device type is not FILE, a physical drive. The number of available mount points and drives depends on the following factors:

- Other IBM Spectrum Protect and system activity
- The mount limits of the device classes for the sequential access storage pools that are involved

Ensure that sufficient mount points and drives are available to allow node replication processes to complete. Each replication session might need a mount point on the source and target replication servers for storage pool volumes. If the device type is not FILE, each session might also need a drive on both the source and target replication servers.

When you set a value for MAXSESSIONS, also consider the available bandwidth and the processor capacity of the source and target replication servers.

Tip:

- The value that is specified by the MAXSESSIONS parameter applies only to data sessions. Data sessions are sessions during which data is sent to a target replication server. However, if you issue a QUERY SESSION command, the total number of sessions might exceed the number of data sessions. The difference is because of short control sessions that are used for querying and setting up replication operations.
- The value of the MAXSESSIONS parameter represents the maximum allowable number of sessions. The number of sessions that are used for replication depends on the amount of data to be replicated. If you are replicating only a small amount of data, you do not achieve any benefit by increasing the number of sessions. The total number of sessions might be less than the value that is specified by the MAXSESSIONS parameter.

Preview

Specifies whether to preview data. This parameter is optional. The default value is NO. You can specify one of the following values:

No

Specifies that the data is replicated to the target server but that the data is not previewed.

Yes

Specifies that data is previewed but not replicated. If you specify PREVIEW=YES, only volumes that must be physically mounted, such as tape volumes, are displayed. Volumes that are assigned to storage pools that have a device class of FILE are not displayed.

The following information is displayed in the output:

- The names of client nodes whose data would be replicated.
- The number of files that would be replicated or deleted.
- The estimated amount of time it would take to complete the node replication process.

- A list of volumes that would be mounted.
- A summary of information about replicated, damaged data. The summary lists the number of nodes, file spaces, files, and bytes that can be recovered during a replication recovery process. The summary is displayed only if RECOVERDAMAGED=YES or RECOVERDAMAGED=ONLY is specified.

If the client node data that is specified by the REPLICATE NODE command was never replicated and you specify PREVIEW=YES, the node and its file spaces are automatically defined on the target replication server.

#### LISTfiles

Specifies whether to list the names of files that would be replicated. This parameter is optional. The default is NO. Specifying this parameter signifies that the WAIT parameter is set to YES and that you cannot issue the WAIT parameter from the server console.

You can specify one of the following values:

No

Specifies that the names of files that would be replicated are not displayed.

Yes

Specifies that the names of files that would be replicated are displayed.

#### Wait

Specifies whether to wait for the server to complete processing this command in the foreground. This parameter is optional. The default value is NO. You can specify one of the following values:

No

Specifies that the command processes in the background. To monitor the background processing of the REPLICATE NODE command, issue the QUERY PROCESS command.

Yes

Specifies that the command processes in the foreground. Messages are not displayed until the command completes processing. You cannot specify WAIT=YES from the server console.

#### RECOVERDamaged

Specifies whether a recovery process is started on a target replication server after the node replication process is completed. This parameter is optional, and it overrides any value that you specified for the RECOVERDamaged parameter when you defined or updated a node. You can specify one of the following values:

Yes

Specifies that a replication process is started to recover damaged files, but only if the setting for the REPLRECOVERDAMAGED system parameter is ON. If the setting is OFF, damaged files are not recovered.

No

Specifies that damaged files are not recovered.

Only

Specifies that a replication process is started for the sole purpose of recovering damaged files, but only if the setting for the REPLRECOVERDAMAGED system parameter is ON. If the setting is OFF, damaged files are not recovered, and you receive a notification that recovery was not started.

Restriction: If you specify an invalid combination of values and settings for file recovery, replication is stopped, and an error message is displayed.

#### FORCEREconcile

Specifies whether to compare all files on the source replication server with files on the target replication server and to synchronize the differences between them. Before V7.1.1, this behavior was the default for replication processing. When IBM® Tivoli® Storage Manager V7.1.1 or later is installed on the source and target replication servers, a reconcile is automatically completed during initial replication. After initial replication, you might use this parameter for the following reasons:

- To synchronize files on the source and target replication servers if they are different.
- To replicate inactive files that were skipped after you change your replication rules from ACTIVE\_DATA to ALL\_DATA.
- To delete inactive files from the target replication server when you change your replication rules from ALL\_DATA to ACTIVE\_DATA.
- To ensure that you replicate only active data when you are using the ACTIVE\_DATA replication rule so that the target replication server has active files only.
- To resynchronize the files so that the target replication server has the same files as the source replication server if you have previously or are currently using the policies on the target replication server to manage replicated files.

- To resynchronize the files on the source and target replication servers if the database is regressed to an earlier point-in-time by using a method other than the DSMSEV RESTORE DB command.
- To rebind files to the new management class on the target replication server if this management class did not exist when the files were replicated. You must be using the policies that are defined on the target replication server to manage replicated files.

Remember: When the ACTIVE\_DATA rule is assigned, a reconcile is completed only for active files on the source replication server.

This parameter is optional. You can specify one of the following values:

No

Specifies that replication processing does not force a reconcile to compare all files on the source replication server with files on the target replication server. Instead, replication processing tracks file changes on the source replication server since the last replication and synchronizes these changes on the target replication server. NO is the default value.

Yes

Specifies that replication processing forces a reconcile to compare all files on the source replication server with files on the target replication server and synchronizes the files on the target replication server with the source replication server.

**Linux** TRANSFERMethod

**Linux** Specifies the method that is used for server-to-server data transfer. This parameter is optional. You can specify one of the following values:

Tcpip

Specifies that TCP/IP is used to transfer data. This value is the default.

Fasp

Specifies that Aspera® Fast Adaptive Secure Protocol (FASP) technology is used to transfer data. Aspera FASP technology can help you optimize data transfer in a wide area network (WAN). If you specify TRANSFERMETHOD=FASP, you override any TRANSFERMETHOD parameters that you specified on the DEFINE SERVER or UPDATE SERVER commands.

Restrictions:

- Only data that is stored in a directory-container storage pool can be transferred by using Aspera FASP technology. Data that is not stored in a directory-container storage pool is transferred by using TCP/IP.
- Before you enable Aspera FASP technology, determine whether the technology is appropriate for your system environment and install the appropriate licenses. For instructions, see Determining whether Aspera FASP technology can optimize data transfer in your system environment. If the licenses are missing or expired, node replication fails.
- If WAN performance meets your business needs, do not enable Aspera FASP technology.

## Example: Replicate data by data type and priority

Replicate high-priority active backup data and high-priority archive data that belongs to all the client nodes in group PAYROLL.

```
replicate node payroll datatype=backupactive,archive priority=high
```

## Example: Replicate all the data that belongs to a node according to the assigned replication rules

NODE1 has a single file space. The following replication rules apply:

- File space rules:
  - Backup data: ACTIVE\_DATA
  - Archive data: DEFAULT
  - Space-managed data: DEFAULT
- Client node rules:
  - Backup data: DEFAULT
  - Archive data: ALL\_DATA\_HIGH\_PRIORITY
  - Space-managed data: DEFAULT
- Server rules:
  - Backup data: ALL\_DATA

- o Archive data: ALL\_DATA
- o Space-managed data: NONE

```
replicate node node1 priority=all
```

Active backup data in the file space is replicated with normal priority. Archive data is replicated with high priority. Space-managed data is not replicated.

## Example: Recover damaged files without starting the full replication process

Without starting the full replication process, recover any damaged files in the client nodes of the PAYROLL group. Ensure that the setting for the REPLRECOVERDAMAGED system parameter is ON. Then, issue the following command:

```
replicate node payroll recoverdamaged=only
```

## Related commands

Table 2. Commands related to REPLICATE NODE

Command	Description
CANCEL PROCESS	Cancels a background server process.
CANCEL REPLICATION	Cancels node replication processes.
QUERY FILESPACE	Displays information about data in file spaces that belong to a client.
QUERY NODE	Displays partial or complete information about one or more clients.
QUERY REPLICATION	Displays information about node replication processes.
QUERY REPLNODE	Displays information about the replication status of a client node.
QUERY REPLRULE	Displays information about node replication rules.
QUERY SERVER	Displays information about servers.
QUERY STATUS	Displays the settings of server parameters, such as those selected by the SET commands.
REGISTER NODE	Defines a client node to the server and sets options for that user.
REMOVE REPLNODE	Removes a node from replication.
<b>AIX</b>   <b>Linux</b>   <b>Windows</b> PROTECT STGPPOOL	Protects a directory-container storage pool.
SET REPLRECOVERDAMAGED	Specifies whether node replication is enabled to recover damaged files from a target replication server.
UPDATE FILESPACE	Changes file-space node-replication rules.
UPDATE NODE	Changes the attributes that are associated with a client node.
UPDATE REPLRULE	Enables or disables replication rules.
VALIDATE REPLICATION	Verifies replication for file spaces and data types.

## REPLY (Allow a request to continue processing)

Use this command and an identification number to inform the server that you have completed a requested operation. Not all server requests require a reply. This command is required only if the request message specifically indicates that a reply is needed.

## Privilege class

To issue this command, you must have system privilege or operator privilege.

## Syntax

---

```
>>-REply--request_number--+-----+-----><
                          '-LABEL-----volume_label-'
```

## Parameters

---

### request\_number **(Required)**

Specifies the identification number of the request.

### LABEL

Specifies the label to be written on a volume when you reply to a message from a LABEL LIBVOLUME command process. This parameter is optional.

## Example: Reply to a request

---

Respond to a reply request using 3 as the request number.

```
reply 3
```

## Related commands

---

Table 1. Commands related to REPLY

Command	Description
CANCEL REQUEST	Cancels pending volume mount requests.
QUERY REQUEST	Displays information about all pending mount requests.

## RESET PASSEXP (Reset password expiration)

---

Use the RESET PASSEXP command to reset the password expiration period to the common expiration period for administrator and client node passwords. The RESET PASSEXP command does not apply to passwords that are stored on an LDAP directory server.

Restriction: You cannot reset the password expiration period to the common expiration period with the SET PASSEXP command.

Use the QUERY STATUS command to display the common password expiration period.

Restriction: If you do not specify either the NODE or ADMIN parameters, the password expiration period for all client nodes and administrators will be reset.

## Privilege class

---

To issue this command, you must have system privilege.

## Syntax

---

```
>>-RESet PASSExp--+-----+----->
                |         .-,------. |
                |         v             | |
                '-Node-----node_name-+-'

>--+-----+----->>
|         .-,------. |
|         v             | |
'-Admin-----admin_name-+-'
```

## Parameters

---

Node



Specifies the name of the node whose password expiration period you would like to reset. To specify a list of nodes, separate the names with commas and no intervening spaces. This parameter is optional.

Admin

Specifies the name of the administrator whose password expiration period you would like to reset. To specify a list of administrators, separate the names with commas and no intervening spaces. This parameter is optional.

## Example: Reset the password expiration for specific client nodes

---

Reset the password expiration period for client nodes bj and katie.

```
reset passexp node=bj,katie
```

## Example: Reset the password expiration for all users

---

Reset the password expiration period for all users to the common expiration period.

```
reset passexp
```

## Related commands

---

Table 1. Commands related to RESET PASSEXP

Command	Description
QUERY STATUS	Displays the settings of server parameters, such as those selected by the SET commands.
SET PASSEXP	Specifies the number of days after which a password is expired and must be changed.
UPDATE ADMIN	Changes the password or contact information associated with any administrator.
UPDATE NODE	Changes the attributes that are associated with a client node.

## RESTART EXPORT (Restart a suspended export operation)

---

Use this command to restart a suspended export operation.

An export operation is suspended when any of the following conditions is detected:

- A SUSPEND EXPORT command is issued for the running export operation
- Segment preemption - the file being read for export is deleted by some other process
- Communication errors on a server-to-server export
- No available mount points
- Necessary volumes are unavailable
- I/O errors encountered

Important: Nodes or file spaces (on the exporting server) in the original export operation that are subsequently renamed are not included in the resumed operation. Any remaining data for nodes or file spaces on the target server that are deleted prior to resumption are discarded.

## Privilege class

---

You must have system privilege to issue this command.

## Syntax

---

```
>>-RESTART EXPORT .-*-----+----->>  
                    '---export_identifier---'
```

## Parameters

---

export\_identifier

This optional parameter is the unique identifier for the suspended server-to-server export operation. You can use the wildcard character to specify this name. The export identifier name can be found by issuing the QUERY EXPORT command to list all the currently suspended server-to-server export operations.

## Example: Restart a suspended export

Restart the suspended export operation identified by the export identifier EXPORTALLACCTNODES.

```
restart export exportallacctnodes
```

## Related commands

Table 1. Commands related to RESTART EXPORT

Command	Description
CANCEL EXPORT	Deletes a suspended export operation.
EXPORT NODE	Copies client node information to external media or directly to another server.
EXPORT SERVER	Copies all or part of the server to external media or directly to another server.
QUERY EXPORT	Displays the export operations that are currently running or suspended.
SUSPEND EXPORT	Suspends a running export operation.

## RESTORE commands

Use the RESTORE commands to restore IBM Spectrum Protect™ storage pools or volumes.

- RESTORE NODE (Restore a NAS node)
- RESTORE STGPOOL (Restore storage pool data from a copy pool or an active-data pool)
- RESTORE VOLUME (Restore primary volume data from a copy pool or an active-data pool)

## RESTORE NODE (Restore a NAS node)

Use this command to initiate a restore operation for a network-attached storage (NAS) node.

You can use the RESTORE NODE command to restore backups that were created by using either the client's BACKUP NAS command or the server's BACKUP NODE command. NAS data may be restored from primary or copy native IBM Spectrum Protect™ pools; primary or copy NAS pools; or any combination needed to achieve the restore.

## Privilege class

To issue this command, you must have system privilege, policy privilege for the domain to which the node is assigned, or client owner authority over the node.

## Syntax

```
>>-RESTORE Node--node_name--source_file_system----->
      .-source_file_system-----
>--+-----+----->
  '-destination_file_system-'

>--+-----+----->
  |                                     |
  |               .-,------.       |
  |               v               |
  |'-FILELIST--==--+---file_name+-----+-'
  |               '-FILE:--file_list-'
```

```

.-NAMEType-----SERVER-----
>-----+-----+----->
'-NAMEType-----+SERVER-----+'
      +-HEXadecimal-+
      '-UNICODE-----'

.-PITDate-----TODAY-----
>-----+-----+----->
'-PITDate-----+mm/dd/yyyy-----+'
      +-TODAY-----+
      +-TODAY-numdays-+
      '- -numdays-----'

.-PITTime-----NOW----- .-Wait-----No-----
>-----+-----+-----+----->
'-PITTime-----+hh:mm:ss--+-' '-Wait-----+No--+-'
      +-NOW-----+           '-Yes-'
      +-NOW-hh:mm-+
      '- -hh:mm--'

.-TYPE-----BACKUPImage-----
>-----+-----+----->>
'-TYPE-----+BACKUPImage-+-'
      '-SNAPMirror--'

```

## Parameters

### node\_name (Required)

Specifies the name of the node to restore. You cannot use wildcard characters or specify a list of names.

### source\_file\_system (Required)

Specifies the name of the file system to restore. You cannot use wildcard characters for this name. You cannot specify more than one file system to restore. Virtual file space names are allowed.

### destination\_file\_system

Specifies that the file server restores the data to an existing, mounted file system on the file server. This parameter is optional. The default is the original location of the file system on the file server. Virtual file space names are allowed.

### FILELIST

Specifies the list of file or directory names to be restored. This parameter is optional. The default is to restore the entire file system. If this value is specified, the server attempts to restore the objects from the appropriate image. If the PITDATE and PITTIME parameters are specified, then the file is restored from the last backup image prior to the specified time. If no PITDATE and PITTIME parameters are specified, the file is restored from the latest backup image of the file system.

If the image is a differential backup, objects are first restored from the corresponding full backup and then from the differential backup. The restore is done by scanning the appropriate images for the specified objects and restoring any that are found. The TOCs for these images is not accessed, so the server does not check whether the objects are actually contained within the images.

The folder path and file name must be entered using forward slash (/) symbols. No ending forward slash (/) is needed at the end of the file name. All arguments that contain a space must have double quotation marks ("argument with spaces") surrounding the entire argument.

```
FILELIST="/path/to/filename1 with blanks",/path/to/filename2_no_blanks
```

Any file names that contain commas must have double quotation marks surrounding the entire argument, surrounded by single quotation marks ("argument with commas").

```
FILELIST='"/path/to/filename1,with,commas"',/path/to/filename2_no_commas
```

To restore a complete directory, specify a directory name instead of a file name. All files in the directory and its subdirectories are restored. An ending forward slash (/) is not needed at the end of the directory name:

```
FILELIST=/path/to/mydir
```

### file\_name

Specifies one or more file or directory names to be restored. The names you specify cannot contain wildcards. Multiple names must be separated with commas and no intervening blanks. File names are case-sensitive.

FILE:file\_list

Specifies the name of a file that contains a list of the file or directory names to be restored. In the specified file, each file or directory name must be on a separate line. Blank lines and comment lines that begin with an asterisk are ignored. For example:

To restore files FILE01, FILE02, and FILE03, create a file named RESTORELIST that contains a line for each file:

```
FILE01
FILE02
FILE03
```

You can specify the files to be restored with the command as follows:

```
FILELIST=FILE:RESTORELIST
```

#### NAMEType

Specifies how you want the server to interpret the names specified as FILELIST=file\_name or the names listed in the file specified with FILELIST=file\_list. This parameter is useful when the names may contain Unicode characters. It has no effect if the FILELIST parameter is not specified. The default value is SERVER. Possible values are:

##### SERVER

The server uses the server's code page to interpret the names.

##### HEXadecimal

The server interprets the names that you enter as the hexadecimal representation of a name in Unicode. To view the hexadecimal representation of a file or directory name, you can use the QUERY TOC command with FORMAT=DETAILED.

##### UNICODE

The server interprets the names as being UTF-8 encoded. This option only applies when you have specified a list with FILELIST=FILE:file\_list.

Restriction: Network Data Management Protocol (NDMP) has limitations that prevent IBM Spectrum Protect from reporting whether or not individual files and directories are successfully restored.

#### PITDate

Specifies the point-in-time date. When used with the PITTIME parameter, PITDATE establishes the point in time from which you want to select the data to restore. The latest data that was backed up on or before the date and time that you specify will be restored. This parameter is optional. The default is TODAY.

You can specify the date by using one of the following values:

Value	Description	Example
MM/DD/YYYY	A specific date	06/25/2001
TODAY	The current date	TODAY
TODAY-days or -days	The current date minus days specified	TODAY-7 or -7.  To restore data that was backed up a week ago, specify PITDATE=TODAY-7 or PITDATE=-7.
EOLM (End Of Last Month)	The last day of the previous month.	EOLM
EOLM-days	The last day of the previous month minus days specified.	EOLM-1  To include files that were active a day before the last day of the previous month.
BOTM (Beginning Of This Month)	The first day of the current month.	BOTM
BOTM+days	The first day of the current month, plus days specified.	BOTM+9  To include files that were active on the 10th day of the current month.

#### PITTime

Specifies the point-in-time time. When used with the PITDATE parameter, PITTIME establishes the point in time from which you want to select the data to restore. The latest data that was backed up on or before the date and time that you specify will be restored. This parameter is optional. The default is the current time.

You can specify the time by using one of the following values:

Value	Description	Example
HH:MM:SS	A specific time on the specified date	12:33:28

Value	Description	Example
NOW	The current time on the specified date	NOW
NOW-HH:MM or -HH:MM	The current time minus hours and minutes on the specified begin date	NOW-03:30 or -03:30.  If you issue this command at 9:00 with PITTIME=NOW-03:30 or PITTIME=-03:30, the server restores backup records with a time of 5:30 or later on the point-in-time date.

#### Wait

Specifies whether to wait for the server to complete processing this command in the foreground. The default is NO. Possible values are:

#### No

Specifies that the server processes this command in the background. Use the QUERY PROCESS command to monitor the background processing of this command.

#### Yes

Specifies that the server processes this command in the foreground. You wait for the command to complete before continuing with other tasks. The server then displays the output messages to the administrative client when the command completes.

Restriction: You cannot specify WAIT=YES from the server console.

#### TYPE

Specifies the type of image to restore. The default value for this parameter is BACKUPIMAGE and it is used to restore data from standard NDMP base or differential backups. Other image types represent backup methods that might be specific to a particular file server. Possible values are:

#### BACKUPImage

Specifies that the file system should be restored from the appropriate standard NDMP backup images. This is the default method for performing an NDMP restore operation. Using the BACKUPIMAGE type, you can restore data from base and differential backups, and data at the file level.

#### SNAPMirror

Specifies that the file system should be retrieved from a NetApp SnapMirror image. SnapMirror images are block-level full-backup images of a NetApp file system. A SnapMirror image can only be restored to a file system that has been prepared as a SnapMirror target volume. Refer to the documentation that came with your NetApp file server for details.

After a SnapMirror image is retrieved and copied to a target file system, IBM Spectrum Protect breaks the SnapMirror relationship that was created by the file server during the operation. After the restore is complete, the target file system returns to the same state as that of the original file system at the point-in-time of the backup.

When setting the TYPE parameter to SNAPMIRROR, note the following restrictions:

Restrictions:

- You cannot specify the FILELIST parameter.
- Neither the *source\_file\_system\_name* nor the *destination\_file\_system\_name* can be a virtual filesystem name.
- This parameter is valid for NetApp and IBM® N-Series file servers only.

### Example: Restore a complete directory

Restore all of the files and subdirectories in the directory /mydir.

```
restore node nasnode /myfs /dest filelist=/path/to/mydir
```

### Example: Restore data from a file system

Restore the data from the /vol/vol10 file system on NAS node NAS1.

```
restore node nas1 /vol/vol10
```

### Example: Restore a directory-level backup to the same location

Restore the directory-level backup to the original location. The source is the virtual file space name `/MIKESDIR` and no destination is specified.

```
restore node nas1 /mikesdir
```

For this example and the next example, assume the following virtual file space definitions exist on the server for the node `NAS1`.

VFS Name	Filesystem	Path
<code>/mikesdir</code>	<code>/vol/vol2</code>	<code>/mikes</code>
<code>/TargetDirVol2</code>	<code>/vol/vol2</code>	<code>/tmp</code>
<code>/TargetDirVol1</code>	<code>/vol/vol1</code>	<code>/tmp</code>

## Example: Restore a directory-level backup to a different file system

Restore the directory-level backup to a different file system but preserve the path.

```
restore node nas1 /mikesdir /vol/vol0
```

## Related commands

Table 1. Commands related to RESTORE NODE

Command	Description
BACKUP NODE	Backs up a network-attached storage (NAS) node.
CANCEL PROCESS	Cancels a background server process.
DEFINE VIRTUALFSMAPPING	Define a virtual file space mapping.
QUERY NASBACKUP	Displays information about NAS backup images.
QUERY TOC	Displays details about the table of contents for a specified backup image.

## RESTORE STGPOOL (Restore storage pool data from a copy pool or an active-data pool)

Use this command to restore files from one or more copy storage pools or active-data pools to a primary storage pool.

IBM Spectrum Protect™ restores all the primary storage pool files that:

- Have been identified as having errors
- Reside on a volume with an access mode of DESTROYED

Restriction: You cannot use this command for container storage pools. Use the `REPLICATE STGPOOL` command to protect data for container storage pools.

You can also use this command to identify volumes that contain damaged, primary files. During restore processing, a message is issued for every volume in the restored storage pool that contains damaged, non-cached files. Use the `QUERY CONTENT` command to identify damaged, primary files on a specific volume.

You cannot restore a storage pool defined with a `CENTERA` device class.

In addition to restoring data to primary storage pools that have `NATIVE` or `NONBLOCK` data formats, this command also lets you restore data to primary storage pools that have `NDMP` data formats (`NETAPPDUMP`, `CELERRADUMP`, or `NDMPDUMP`). The primary storage pool must have the same data format as the copy storage pool from which data is to be restored. IBM Spectrum Protect supports backend data movement for `NDMP` images.

Tip: To restore NAS client-node data to NAS storage pools, you must manually change the access mode of the volumes to `DESTROYED` using the `UPDATE VOLUME` command. However, if you are using disaster recovery manager, the plan file will contain the information the server needs to automatically mark the volumes as `DESTROYED`.

Restoration of files might be incomplete if backup file copies in copy storage pools or active-data pools were moved or deleted by other IBM Spectrum Protect processes during restore processing. To prevent this problem, do not issue the following commands for copy storage pool or active-data pool volumes while restore processing is in progress:

- `MOVE DATA`

- DELETE VOLUME (DISCARDATA=YES)
- AUDIT VOLUME (FIX=YES)

Also, you can prevent reclamation processing for your copy storage pools by setting the RECLAIM percentage to 100 with the UPDATE STGPOOL command.

## Privilege class

To issue this command, you must have system privilege, unrestricted storage privilege, or restricted storage privilege for the primary storage pool for which files are to be restored. If you are a restricted storage administrator and you want to restore files to a new primary storage pool, you must also have authority for the new storage pool.

## Syntax

```
>>-RESTORE STGpool--primary_pool_name----->
>--+-----+----->
' -COPYstgpool----copy_pool_name-'
.-ACTIVEDATAOnly----No-----
>--+-----+----->
' -ACTIVEDATAOnly----+No-----+-'
' -Yes--| A |-'
>--+-----+----->
' -NEWstgpool----new_primary_pool_name-'
.-MAXPRocess----1-----.-Preview----No-----
>--+-----+----->
' -MAXPRocess----number-' ' -Preview----+No--+-'
' -Yes-'
.-Wait----No-----
>--+-----+-----><
' -Wait----+No--+-'
' -Yes-'

A (Yes)

|--ACTIVEDATAPool----active-data_pool_name-----|
```

## Parameters

**primary\_pool\_name** (Required)

Specifies the name of the primary storage pool that is being restored.

**COPYstgpool**

Specifies the name of the copy storage pool from which the files are to be restored. This parameter is optional. If this parameter is not specified, files are restored from any copy pool in which copies can be located. Do not use this parameter with the **ACTIVEDATAONLY** or **ACTIVEDATAPOOL** parameters.

**ACTIVEDATAOnly**

Specifies that active versions of backup files are to be restored from active-data pools only. This parameter is optional. The default is **NO**. If this parameter is not specified, files are restored from copy-storage pools. Do not use this parameter with the **COPYSTGPOOL** parameter. Possible values are:

**No**

Specifies that the storage pool will not be restored from active-data pools.

**Yes**

Specifies that the storage pool will be restored from active-pool or pools that you specify using the **ACTIVEDATAPOOL** parameter. If you specify **YES** as a value for **ACTIVEDATAONLY**, but do not specify a value for **ACTIVEDATAPOOL**, files are restored from any active-data pool in which active versions of backup files can be located.

**Attention:** Restoring a primary storage pool from an active-data pool might cause some or all inactive files to be deleted from the database if the server determines that an inactive file needs to be replaced but cannot find it in the active-data pool.

#### ACTIVEDATAPool

Specifies the name of the active-data pool from which the active versions of backup files are to be restored. This parameter is optional. If this parameter is not specified, files are restored from any active-data pool in which active versions of backup files can be located.

#### NEWstgpool

Specifies the name of the new storage pool to which to restore the files. This parameter is optional. If this parameter is not specified, files are restored to the original primary storage pool (the pool being restored).

#### MAXPProcess

Specifies the maximum number of parallel processes that are used for restoring files. Using multiple, parallel processes may improve throughput for the restore. This parameter is optional. You can specify a value from 1 to 999. The default is 1.

When determining this value, consider the number of mount points (logical drives) and physical drives that can be dedicated to this operation. To access a sequential access volume, IBM Spectrum Protect uses a mount point, and, if the device type is not FILE, a physical drive. The number of available mount points and drives depends on other IBM Spectrum Protect and system activity and on the mount limits of the device classes for the sequential access storage pools that are involved in the restore.

Each process needs a mount point for copy storage pool volumes, and, if the device type is not FILE, each process also needs a drive. If you are restoring files in a sequential storage pool, each process needs an additional mount point for primary storage pool volumes and, if the device class is not FILE, an additional drive. For example, suppose you specify a maximum of 3 processes to restore a primary sequential storage pool from a copy storage pool of the same device class. Each process requires two mount points and two drives. To run all three processes, the device class must have a mount limit of at least 6, and at least 6 mount points and 6 drives must be available.

To preview a restore, only one process is used and no mount points or drives are needed.

#### Preview

Specifies if you want to preview but not perform the restore. The preview lets you identify volumes required to restore the storage pool. The preview displays:

- A list of primary storage pool volumes that contain damaged files.
- The number of files and the number of bytes to be restored, assuming that the access mode of the required copy storage pool volumes is READWRITE or READONLY when the restore operation is performed.
- A list of copy storage pool volumes containing files to be restored. These volumes must be mounted if you perform the restore.
- A list of any volumes containing files that cannot be restored.

Note: For only a list of offsite copy storage pool volumes to be mounted during a restore, change the access mode of the copy pool volumes to UNAVAILABLE. This prevents reclamation and move data processing of the volumes until they are moved onsite for the restore.

This parameter is optional. The default is NO. Possible values are:

#### No

Specifies that the restore is done.

#### Yes

Specifies that you want to preview the restore but not do the restore.

#### Wait

Specifies whether to wait for the server to complete processing this command in the foreground. This parameter is optional. The default is NO. Possible values are:

#### No

Specifies that the server processes this command in the background.

You can continue with other tasks while the command is being processed.

Messages created from the background process are displayed either in the activity log or the server console, depending on where messages are logged. To cancel a background process, use the CANCEL PROCESS command. If you cancel this process, some files may have already been restored prior to the cancellation.

#### Yes

Specifies that the server performs this operation in the foreground. The operation must complete before you can continue with other tasks. The server then displays the output messages to the administrative client when the operation completes.

Note: You cannot specify WAIT=YES from the server console.



## Example: Restore files from a copy storage pool to the primary storage pool

Restore files from any copy storage pool to the primary storage pool, PRIMARY\_POOL.

```
restore stgpool primary_pool
```

## Example: Restore files from a specific active-data pool to the primary storage pool

Restore files from active-data pool ADP1 to the primary storage pool PRIMARY\_POOL.

```
restore stgpool primary_pool activedataonly=yes activedatapool=adp1
```

## Related commands

Table 1. Commands related to RESTORE STGPOOL

Command	Description
BACKUP STGPOOL	Backs up a primary storage pool to a copy storage pool.
CANCEL PROCESS	Cancels a background server process.
COPY ACTIVATEDATA	Copies active backup data.
QUERY CONTENT	Displays information about files in a storage pool volume.
QUERY PROCESS	Displays information about background processes.
RESTORE VOLUME	Restores files stored on specified volumes in a primary storage pool from copy storage pools.
UPDATE STGPOOL	Changes the attributes of a storage pool.
UPDATE VOLUME	Updates the attributes of storage pool volumes.

## RESTORE VOLUME (Restore primary volume data from a copy pool or an active-data pool)

Use this command to restore all files on damaged volumes in a primary storage pool that was backed up to a copy storage pool or copied to an active-data pool. IBM Spectrum Protect™ does not restore cached copies of files and removes those cached files from the database during restore processing.

In addition to restoring data to volumes in storage pools that have NATIVE or NONBLOCK data formats, this command also lets you restore data to volumes in storage pools that have NDMP data formats (NETAPPDUMP, CELERRADUMP, or NDMPDUMP). The volumes to be restored must have the same data format as the volumes in the copy storage pool. IBM Spectrum Protect supports backend data movement for NDMP images.

This command changes the access mode of the specified volumes to DESTROYED. When all files on a volume are restored to other locations, the destroyed volume is empty and is deleted from the database.

The restoration may be incomplete for one or more of the following reasons:

- Files were either never backed up or the backup copies are marked as damaged. Use the QUERY CONTENT command to get more information on the remaining files on the volume.
- A copy storage pool was specified on the RESTORE command, but files were backed up to a different copy storage pool. Use the PREVIEW parameter when you issue the RESTORE command again to determine if this is the problem.
- Volumes in the copy storage pool needed to perform the restore operation are offsite or unavailable. Check the activity log for messages that occurred during restore processing.
- Backup file copies in copy storage pools were moved or deleted by other processes during a restore. See note 3.
- An active-data pool was specified for the restore, and inactive files were not available to be copied.

Important:

1. You cannot restore volumes in storage pools defined with a CENTERA device class.
2. Before you restore a random-access volume, issue the VARY command to vary the volume offline.

3. To prevent copy storage pools files from being moved or deleted by other processes, do not issue the following commands for copy storage pool volumes during a restore:

- o MOVE DATA
- o DELETE VOLUME (DISCARDATA=YES)
- o AUDIT VOLUME (FIX=YES)

To prevent reclamation processing of copy storage pools, issue the UPDATE STGPOOL command with the RECLAIM parameter set to 100.

## Privilege class

To issue this command you must have system privilege, unrestricted storage privilege, or restricted storage privilege for the primary storage pool. If you have restricted privilege and want to restore files to a new primary storage pool, you must also have authority for the new storage pool.

## Syntax

```

      .-,------.
      V          |
>>-RESTORE Volume---volume_name+----->
>--+-----+----->
  '-COPYstgpool---copy_pool_name-'
      .-ACTIVEDATAOnly---No-----.
>--+-----+----->
  '-ACTIVEDATAOnly---+No-----+'
      '-Yes--| A |-'
>--+-----+----->
  '-NEWstgpool---new_primary_pool_name-'
      .-MAXProcess---1-----.  .-Preview---No-----.
>--+-----+-----+----->
  '-MAXProcess---number-'  '-Preview---+No--+-'
      '-Yes-'
      .-Wait---No-----.
>--+-----+----->>
  '-Wait---+No--+-'
      '-Yes-'

A (Yes)

|--ACTIVEDATAPool---active_data_pool_name-----|

```

## Parameters

**volume\_name** (Required)

Specifies the name of the primary storage pool volume to be restored. To specify a list of volumes that belong to the same primary storage pool, separate the names with commas and no intervening spaces.

**COPYstgpool**

Specifies the name of the copy storage pool from which the files are to be restored. This parameter is optional. If you do not specify this parameter, files are restored from any copy pool in which copies can be located. Do not use this parameter with the ACTIVEONLY or ACTIVEPOOL parameters.

**ACTIVEDATAOnly**

Specifies that active versions of backup files are to be restored from active-data pools only. This parameter is optional. The default is NO. If this parameter is not specified, files are restored from copy-storage pools. Do not use this parameter with the COPYSTGPOOL parameter. Possible values are:

No

Specifies that the storage pool will not be restored from active-data pools.

Yes

Specifies that the storage pool will be restored from active-pool or pools that you specify using the ACTIVEPOOL parameter. If you specify YES as a value for ACTIVEONLY, but do not specify a value for

ACTIVEDATAPOOL, files are restored from any active-data pool in which active versions of backup files can be located.

Attention: Restoring a volume from an active-data pool might cause some or all inactive files to be deleted from the database if the server determines that an inactive file needs to be replaced but cannot find it in the active-data pool.

#### ACTIVEDATAPool

Specifies the name of the active-data pool from which the active versions of backup files are to be restored. This parameter is optional. If this parameter is not specified, files are restored from any active-data pool in which active versions of backup files can be located.

#### NEWstgpool

Specifies the name of the new storage pool to which to restore the files. This parameter is optional. If you do not specify this parameter, files are restored to the original primary storage pool.

#### MAXPProcess

Specifies the maximum number of parallel processes to use for restoring files. Using parallel processes may improve throughput. This parameter is optional. You can specify a value from 1 to 999. The default is 1.

When determining this value, consider the number of mount points (logical drives) and physical drives that can be dedicated to this operation. To access a sequential access volume, IBM Spectrum Protect uses a mount point, and, if the device type is not FILE, a physical drive. The number of available mount points and drives depends on other IBM Spectrum Protect and system activity and on the mount limits of the device classes for the sequential access storage pools that are involved in the restore.

Each process needs a mount point for copy storage pool volumes. If the device type is not FILE, each process also needs a drive. If you are restoring a sequential storage pool, each process needs an additional mount point for primary storage pool volumes and, if the device type is not FILE, an additional drive. For example, suppose you specify a maximum of three processes to back up a primary sequential storage pool to a copy storage pool of the same device class. Each process requires two mount points and two drives. To run all three processes, the device class must have a mount limit of at least 6, and at least 6 mount points and 6 drives must be available.

To preview a backup, only one process is used and no mount points or drives are needed.

#### Preview

Specifies if you want to preview but not perform the restore. You can use this option to identify the offsite volumes required to restore a storage pool. This parameter is optional. The default is NO. Possible values are:

##### No

Specifies that you want to perform the restore operation.

##### Yes

Specifies that you want to preview the restore operation but restore the data.

Tip: If you preview a restore to see a list of offsite copy pool volumes to be mounted, you should you change the access mode of the identified volumes to UNAVAILABLE. This prevents reclamation and MOVE DATA processing for these volumes until they are transported to the onsite location for use in restore processing.

The preview displays the following:

- The number of files and bytes to be restored, if the access mode of the copy storage pool volumes is READWRITE or READONLY when the restoration is performed.
- A list of copy storage pool volumes containing files to be restored. These volumes must be mounted if you perform the restore.
- A list of volumes containing files that cannot be restored.

#### Wait

Specifies whether to wait for the server to complete processing this command in the foreground. This parameter is optional. This default is NO. Possible values are:

##### No

Specifies that the server processes this command in the background.

You can continue with other tasks while the command is being processed. Messages created from the background process are displayed either in the activity log or the server console, depending on where messages are logged.

To cancel a background process, use the CANCEL PROCESS command. If you cancel this process, some files may have already been backed up prior to the cancellation.

##### Yes

Specifies that the server processes this command in the foreground. The operation must complete before you can continue with other tasks. The server then displays the output messages to the administrative client when the command completes.

Remember: You cannot specify WAIT=YES from the server console.

## Example: Restore primary volume data files

Restore files stored on volume PVOL2 in primary storage pool PRIMARY\_POOL.

```
restore volume pvol2
```

## Example: Restore primary volume data files from an active-data pool

Restore files stored on volume VOL001 in primary pool PRIMARY\_POOL from active-data pool ADP1.

```
restore volume vol001 activedataonly=yes activedatapool=adp1
```

## Related commands

Table 1. Commands related to RESTORE VOLUME

Command	Description
BACKUP STGPOOL	Backs up a primary storage pool to a copy storage pool.
COPY ACTIVATEDATA	Copies active backup data.
CANCEL PROCESS	Cancels a background server process.
QUERY PROCESS	Displays information about background processes.
RESTORE STGPOOL	Restores files to a primary storage pool from copy storage pools.

## REVOKE commands

Use the REVOKE commands to revoke privileges or access.

- REVOKE AUTHORITY (Remove administrator authority)
- REVOKE PROXYNODE (Revoke proxy authority for a client node)

## REVOKE AUTHORITY (Remove administrator authority)

Use this command to revoke one or more privilege classes from an administrator.

You can also use this command to reduce the number of policy domains to which a restricted policy administrator has authority and the number of storage pools to which a restricted storage administrator has authority.

If you use the REVOKE AUTHORITY command without the CLASSES, DOMAINS, and STGPOLS parameters, you will revoke all privileges for the specified administrator.

At least one administrator must have system privilege; therefore, if the administrator is the only one with system privilege, you cannot revoke the authority.

## Privilege class

To issue this command, you must have system privilege.

## Syntax

```
>>-REVoKe AUTHority--admin_name----->
```

```
>--+-----+----->  
|                .-,------. |
```

```

| (1) V | |
|'-Classes-----+System-----+-'
|           +-Policy-----+
|           +-Storage-----+
|           +-Operator-----+
|           '-Node--| A |-'
>----->
| .-,----- . |
| V | |
|'-Domains-----domain_name-+-'
>-----<
| .-,----- . |
| (1) V | |
|'-STGpools-----pool_name-+-'

```

A

```

.-AUTHority----Access-----
|-----+-----+-----+-----+-----+
|'-AUTHority----+Access-+-' '-Node-----node_name-----'
|           '-Owner--'

```

Notes:

1. If all these parameters are omitted, all administrator privileges will be revoked for this administrator.

## Parameters

---

admin\_name (Required)

Specifies the name of the administrator whose administrative privilege is to be revoked or reduced.

Classes

Specifies one or more administrative privilege classes to be revoked. You can specify more than one class by separating each with a comma.

System

Indicates that system authority is to be revoked for this administrator. If CLASSES=SYSTEM is specified, no other classes can be specified, and the DOMAINS and STGPOOLS parameters cannot be specified.

Policy

Indicates that policy privilege is to be revoked for this administrator. To revoke all policy privilege, specify CLASSES=POLICY and do not specify the DOMAINS parameter.

Storage

Indicates that storage privilege is to be revoked for this administrator. To revoke all storage privilege, specify CLASSES=STORAGE and do not specify the STGPOOLS parameter.

Operator

Indicates that operator privilege is to be revoked for this administrator.

Node

Indicates that node privilege is to be revoked for this user.

AUTHority

Indicates the authority level to revoke for a user with node privilege. This parameter is optional.

If an administrator already has system or policy privilege to the policy domain to which the node belongs, this command will not change the administrator's privilege.

Possible authority levels are:

Access

Indicates that client access authority is revoked. This is the default when CLASSES=NODE is specified. Note: A client node can set the REVOKEREMOTEACCESS option to prevent access by a user with node privilege and client access authority. If a user with node privilege has client owner authority, or has system or policy privileges to the policy domain to which the node belongs, that administrator can still access the web backup-archive client.

Owner

Indicates that client owner authority is revoked.

#### DOmains

Indicates that you want to revoke an administrator's client access or client owner authority to all clients in the specified policy domain. This parameter cannot be used together with the NODE parameter.

#### NOde

Indicates that you want to revoke an administrator's client access or client owner authority to the node. This parameter cannot be used together with the DOMAIN parameter.

#### DOmains

When used with CLASSES=POLICY, specifies a list of policy domains that can no longer be managed by a restricted policy administrator. (The administrator was authorized to manage these domains until the REVOKE command was issued.) This parameter is optional. The items in the list are separated by commas, with no intervening spaces. You can use wildcard characters to specify a name. Authority for all matching domains is revoked. If DOMAINS is specified, the parameter CLASSES=POLICY is optional.

#### STGpools

Specifies a list of storage pools that can no longer be managed by a restricted policy administrator. (The administrator had been authorized to manage these storage pools until the REVOKE command was issued.) This parameter is optional. The items in the list are separated by commas, with no intervening spaces. You can use wildcard characters to specify a name. Authority for all matching storage pools will be revoked. If STGPOOLS is specified then the parameter CLASSES=STORAGE is optional.

## Usage notes

---

1. To change an unrestricted storage administrator to a restricted storage administrator, you must first use this command to revoke the unrestricted privilege. Then, use the GRANT AUTHORITY command to grant the administrator restricted storage privilege and to identify the storage pools to which the administrator has authority.

To revoke unrestricted storage privilege from an administrator, specify the CLASSES=STORAGE parameter. You cannot use the STGPOOLS parameter to revoke authority for selected storage pools from an unrestricted storage administrator.

2. To change an unrestricted policy administrator to a restricted policy administrator, you must first use this command to revoke the unrestricted privilege. Then, use the GRANT AUTHORITY command to grant the administrator restricted policy privilege and to identify the policy domains to which the administrator has authority.

To revoke unrestricted policy privilege from an administrator, specify the CLASSES=POLICY parameter. You cannot use the DOMAINS parameter to revoke authority for selected domains from an unrestricted administrator.

## Example: Revoke certain administrative privileges

---

Revoke part of administrator CLAUDIA's privileges. CLAUDIA has restricted policy privilege for the policy domains EMPLOYEE\_RECORDS and PROG1. Restrict CLAUDIA's policy privilege to the EMPLOYEE\_RECORDS policy domain.

```
revoke authority claudia classes=policy
domains=employee_records
```

## Example: Revoke all administrative privileges

---

Administrator LARRY currently has operator and restricted policy privilege. Revoke all administrative privileges for administrator LARRY. To revoke all administrative privileges for an administrator, identify the administrator, but do not specify CLASSES, DOMAINS, or STGPOOLS. LARRY remains an administrator but he can only use those commands that can be issued by any administrator.

```
revoke authority larry
```

## Example: Revoke node privilege

---

Help desk personnel user CONNIE currently has node privilege with client owner authority for client node WARD3. Revoke her node privilege with client owner authority.

```
revoke authority connie classes=node
authority=owner node=ward3
```

## Related commands

---

Table 1. Commands related to REVOKE AUTHORITY

Command	Description
GRANT AUTHORITY	Assigns privilege classes to an administrator.
QUERY ADMIN	Displays information about one or more IBM Spectrum Protect™ administrators.

## REVOKE PROXYNODE (Revoke proxy authority for a client node)

Use this command to revoke authority for an agent client node to perform backup and restore operations for a target node on the IBM Spectrum Protect™ server.

### Privilege class

To issue this command, you must have one of the following privilege classes:

- System privilege
- Unrestricted policy privilege

### Syntax

```
>>-REvOke PROXynode TArget-----target_node_name----->
>--AGent-----agent_node_name-----<
```

### Parameters

TArget (Required)

Specifies the target node to which an agent node has been granted proxy authority. Wildcard characters and comma-separated lists of node names are allowed.

AGent (Required)

Specifies which node has authority to act as proxy to the target node. Wildcard characters and comma-separated lists of node names are allowed.

### Example: Revoke a node's proxy authority

To revoke authority from target node NASCLUSTER to act as proxy for all agent nodes which start with the letter M, issue the following command.

```
revoke proxynode target=nascluster agent=m*
```

### Related commands

Table 1. Commands related to REVOKE PROXYNODE

Command	Description
GRANT PROXYNODE	Grant proxy authority to an agent node.
QUERY PROXYNODE	Display nodes with authority to act as proxy nodes.

## ROLLBACK (Rollback uncommitted changes in a macro)

Use this command within a macro to undo any processing changes made by commands run by the server but not yet committed to the database. A committed change is permanent and cannot be rolled back. The ROLLBACK command is useful for testing macros.

Ensure that your administrative client session is not running with the ITEMCOMMIT option when using this command.

Important: SETOPT commands inside a macro cannot be rolled back.

### Privilege class

Any administrator can issue this command.

## Syntax

---

```
>>-ROLLBACK-----><
```

## Parameters

---

None

## Example: Rollback changes in a macro

---

Run the REGN macro with the ROLLBACK command to verify that the macro works without committing any changes. The macro contents are:

```
/* Macro to register policy
administrators and grant authority */
REGister Admin sara hobby
GRant AUTHority sara CLasses=Policy
REGister Admin ken plane
GRant AUTHority ken CLasses=Policy
ROLLBACK /* prevents any changes from being committed */
```

## Related commands

---

Table 1. Commands related to ROLLBACK

Command	Description
COMMIT	Makes changes to the database permanent.
MACRO	Runs a specified macro file.

### Related concepts:

Administrative client macros

## RUN (Run an IBM Spectrum Protect script)

---

Use this command to run an IBM Spectrum Protect™ script. To issue this command on another server, the script being run must be defined on that server.

You can include RUN commands in scripts as long as they do not create loops. For example, you should avoid including RUN commands where SCRIPT\_A runs SCRIPT\_B and SCRIPT\_B runs SCRIPT\_A.

Important: IBM Spectrum Protect does not have a command that can cancel a script after it starts. To stop a script, you must halt the server.

## Privilege class

---

To issue this command, you must have operator, policy, system, storage, or system privilege.

## Syntax

---

```
>>-RUN--script_name--+-----+----->
      | .,----- . |
      | v           | |
      '---substitution_value+-'

.-Preview----No-----.-Verbose----No-----
>--+-----+-----><
  '-Preview----+No--+-' '-Verbose----+No--+-'
    '-Yes-'              '-Yes-'
```



## Parameters

---

script\_name (Required)

Specifies the name of the script you want processed. The name you specify cannot be a substitution variable, such as \$1.

substitution\_value

Specifies one or more values to substitute for variables when the script is run. In a script, a substitution variable consists of a '\$' character, followed by a number. When you run the script, IBM Spectrum Protect replaces the substitution variables defined in a script with the values you supply with this command. You must specify values for each substitution variable defined in the script or the script will fail. This parameter is optional.

Preview

Specifies whether to preview the command lines of a script without actually processing the script. The default is NO.

Possible values are:

Yes

Specifies that the command lines included in a script are displayed, but the script is not processed.

No

Specifies that the command lines included in a script are displayed and the script is processed.

Verbose

Specifies whether command lines, variable substitution, and conditional logic testing used in a script are displayed as the script is being processed. This parameter is ignored if PREVIEW=YES is specified. The default is NO.

Possible values are:

Yes

Specifies that the command lines, variable substitution, and conditional logic testing are displayed as the script is being processed.

No

Specifies that the command lines, variable substitution, and conditional logic testing do not display as the script is being processed.

### Example: View the commands generated by a script with a table name substitution variable

---

To run the following example script, called QSAMPLE, you issue a RUN command that specifies the table name ACTLOG as the value for the substitution variable, \$1. Use the output to preview the commands generated by the script before running the commands.

```
001 /* This is a sample SQL Query in wide format */
005 SET SQLDISPLAYMODE WIDE
010 SELECT colname FROM -
015 COLUMNS WHERE TABNAME='$1'

run qsample actlog preview=yes

ANR1461I RUN: Executing command script QSAMPLE.
ANR1466I RUN: Command script QSAMPLE, Line 5 :
           set sqldisplaymode wide.
ANR1466I RUN: Command script QSAMPLE, Line 15 :
           select colname from columns where tabname='ACTLOG'.
ANR1470I RUN: Command script QSAMPLE completed successfully
           (PREVIEW mode)
```

### Example: Run a script to display and run the commands generated by the script

---

Run the same script as show in the prior example to display both the generated commands and the results of the commands.

```
run qsample actlog verbose=yes

ANR1461I RUN: Executing command script QSAMPLE.
ANR1466I RUN: Command script QSAMPLE, Line 5 :
           set sqldisplaymode wide.
ANR1466I RUN: Command script QSAMPLE, Line 5 : RC=RC_OK
ANR1466I RUN: Command script QSAMPLE, Line 15 :
           select colname from columns where tabname='ACTLOG'.

COLNAME
-----
DATE_TIME
```

```
MSGNO
SEVERITY
MESSAGE
ORIGINATOR
NODENAME
OWNERNAME
SCHEDNAME
DOMAINNAME
SESSID
```

```
ANR1462I RUN: Command script QSAMPLE, Line 15 : RC=RC_OK
ANR1462I RUN: Command script QSAMPLE completed successfully.
```

## Example: Run a script to display just the results of the commands in the script

---

Run the previous example script, without displaying just the results of the generated commands in the script.

```
run qsample actlog verbose=no
```

```
COLNAME
-----
DATE_TIME
MSGNO
SEVERITY
MESSAGE
ORIGINATOR
NODENAME
OWNERNAME
SCHEDNAME
DOMAINNAME
SESSID
```

```
ANR1462I RUN: Command script QSAMPLE completed successfully.
```

## Related commands

---

Table 1. Commands related to RUN

Command	Description
COPY SCRIPT	Creates a copy of a script.
DEFINE SCRIPT	Defines a script to the IBM Spectrum Protect server.
DELETE SCRIPT	Deletes the script or individual lines from the script.
QUERY SCRIPT	Displays information about scripts.
RENAME SCRIPT	Renames a script to a new name.
UPDATE SCRIPT	Changes or adds lines to a script.

### Related tasks:

Running a server script

## SELECT (Perform an SQL query of the IBM Spectrum Protect database)

---

Use the SELECT command to create and format a customized query of the IBM Spectrum Protect™ database.

IBM Spectrum Protect provides an SQL interface to a DB2® program. Restrictions and guidelines for handling SQL queries are handled directly by DB2.

To help you find what information is available, IBM Spectrum Protect provides three system catalog tables:

SYSCAT.TABLES

Contains information about all tables that can be queried with the SELECT command.

SYSCAT.COLUMNS

Describes the columns in each table.

You can issue the SELECT command to query these tables to determine the location of the information that you want.

## Usage notes

---

You cannot issue the SELECT command from a server console.

Because the select command does not lock and unlock records, contention for a record can cause the server to erroneously issue message ANR2034E: `SELECT: No match found using this criteria`. Check your selection criteria, and if you believe that it is correct, try the command again.

To stop the processing of a SELECT command after it starts, cancel the administrative session from which the command was issued. Cancel the session from either the server console or another administrative session.

Temporary table spaces are used to process SQL queries within DB2. Inadequate temporary space can cause SQL queries to fail.

To export output to a comma-separated file for import into a spreadsheet, use `-comma` and `>` command-line options on the `dsmdmc` command.

## Privilege class

---

Any administrator can issue this command.

## Syntax

---

For SELECT statement syntax and guidelines, search the DB2 product information.

Important: The appropriate syntax for the timestamp Select statement is:

```
SELECT * FROM SUMMARY WHERE ACTIVITY='EXPIRATION' AND START_TIME >'2009-05-10 00:00:00' AND  
START_TIME <'2009-05-11 23:23:23'
```

## List of examples

---

The SELECT command is used to customize a wide variety of queries. To give you an idea of what you can do with the command, this section includes many examples. There are, however, many more possibilities. Query output is shown only for the more complex commands to illustrate formatting.

The following list summarizes the example SELECT commands:

- List administrator user ID passwords that are authenticated with an external LDAP directory server
- List available tables
- List client nodes and administrative clients that are currently locked from server access
- List client nodes and administrative clients that have not specified the correct password lately
- List nodes in the standard policy domain that are not associated with the daily backup schedule DAILYBACKUP
- List the administrators that have policy authority
- List type E (ERROR) or W (WARNING) messages that have been issued in the time period for which activity log records have been maintained
- List the administrative schedules that have been defined or altered by administrator JAKE
- List the relative administrative schedule priorities
- List the management classes that have an archive copy group with a retention period greater than 365 days
- List the client nodes that are in each policy domain
- Count how many files have been archived from each node
- List the clients that are using space management
- Determine how many volumes would be reclaimed if the reclamation threshold is changed to 50 percent for storage pool TAPE
- Determine how many backup files would be affected for each node if the DAILY management class in the STANDARD policy domain is changed or deleted
- For all active client sessions, determine how long have they been connected and their effective throughput in bytes per second
- Determine how long the current background processes have been running and determine their effective throughput in time and files per second
- Count the number of client nodes are there for each platform type
- Count the number of file spaces each client node has and list the client nodes ascending order
- Obtain statistical information for calculating the number of off-site volumes that have their space reclaimed during reclamation of a storage pool
- Obtain PVU estimate detail records

- Obtain information about the node roles
- Obtain information about status

## Example: List administrator user IDs that authenticate to the IBM Spectrum Protect server

---

List all the administrator user IDs whose passwords authenticate with the IBM Spectrum Protect server:

```
select admin_name from admins where
authentication=local
```

## Example: List available tables

---

List all the tables available for querying the IBM Spectrum Protect database.

```
select * from syscat.tables

      ABSHEMA: SERVER1
      TABNAME: ACTLOG
      CREATE_TIME: 1999-05-01 07:39:06
      COLCOUNT: 10
INDEX_COLCOUNT: 1
      UNIQUE_INDEX: FALSE
      REMARKS: Server activity log

      TABSCHEMA: SERVER1
      TABNAME: ADMIN_SCHEDULES
      CREATE_TIME: 1995-05-01 07:39:06
      COLCOUNT: 14
INDEX_COLCOUNT: 1
      UNIQUE_INDEX: TRUE
      REMARKS: Administrative command schedules

      TABSCHEMA: SERVER1
      TABNAME: ADMINS
      CREATE_TIME: 1995-05-01 07:39:06
      COLCOUNT: 15
INDEX_COLCOUNT: 1
      UNIQUE_INDEX: TRUE
      REMARKS: Server administrators

      TABSCHEMA: SERVER1
      TABNAME: ARCHIVES
      CREATE_TIME: 1995-05-01 07:39:06
      COLCOUNT: 10
INDEX_COLCOUNT: 5
      UNIQUE_INDEX: FALSE
      REMARKS: Client archive files
```

## Example: List client nodes and administrative clients that are currently locked from server access

---

```
select node_name from nodes where locked='YES'

select admin_name from admins where locked='YES'
```

## Example: List client nodes, administrative clients, and servers that are using transitional session security

---

```
select node_name from nodes where session_security='Transitional'

select admin_name from admins where session_security='Transitional'

select server_name from servers where session_security='Transitional'
```

## Example: List client nodes and administrative clients that have not specified the correct password lately

---

```
select node_name from nodes where invalid_pw_count <>0
select admin_name from admins where invalid_pw_count <>0
```

---

### Example: List nodes in the standard policy domain that are not associated with the daily backup schedule DAILYBACKUP

---

```
select node_name from nodes where domain_name='STANDARD' and
node_name not in (select node_name from associations
where domain_name='STANDARD' and
schedule_name='DAILYBACKUP')
```

---

### Example: List the administrators who have policy authority

---

```
select admin_name from admins where
upper(system_priv) <>'NO'
or upper(policy_priv) <>'NO'
```

---

### Example: List type E (ERROR) or W (WARNING) messages that have been issued in the time period for which activity log records have been maintained

---

```
select date_time,msgno,message from actlog
where severity='E' or severity='W'
```

---

### Example: List the administrative schedules that have been defined or altered by administrator JAKE

---

```
select schedule_name from admin_schedules
where chg_admin='JAKE'
```

---

### Example: List the relative administrative schedule priorities

---

```
select schedule_name,priority from admin_schedules order
by priority
```

---

### Example: List the management classes that have an archive copy group with a retention period greater than 365 days

---

```
select domain_name,set_name,class_name from ar_copygroups
where retver='NOLIMIT' or cast(retver as integer) >365
```

---

### Example: List the management classes that specify more than five backup versions

---

```
select domain_name,set_name,class_name from bu_copygroups
where verexists ='NOLIMIT' or
cast(verexists as integer)>5
```

---

### Example: List the client nodes that are using the client option set named SECURE

---

```
select node_name from nodes where option_set='SECURE'
```

---

### Example: List the client nodes that are in each policy domain

---

```
select domain_name,num_nodes from domains
```

---

### Example: Count how many files have been archived from each node

---

Attention: This command might take a long time to complete.

```
select node_name,count(*) from archives
group by node_name
```

---

### Example: List the clients that are using space management

---

```
select node_name from auditocc where spacemg_mb <>0
```

## Example: Determine how many volumes would be reclaimed if the reclamation threshold is changed to 50 percent for storage pool TAPE

---

```
select count(*) from volumes where stgpool_name='TAPE'
and upper(status)='FULL' and pct_utilized < 50
```

## Example: Determine how many backup files would be affected for each node if the DAILY management class in the STANDARD policy domain is changed or deleted

---

Note: This command takes significant time and resources to complete.

```
select node_name, count(*) as "Files" from backups
where class_name='DAILY' and node_name in
(select node_name from nodes where domain_name='STANDARD')
group by node_name
```

## Example: For all active client sessions, determine how long have they been connected and their effective throughput in bytes per second

---

```
select session_id as "Session",
client_name as "Client",
state as "State",
current_timestamp-start_time as "Elapsed Time",
(cast(bytes_sent as decimal(18,0)) /
cast(second(current_timestamp-start_time) as decimal(18,0)))
as "Bytes sent/second",
(cast(bytes_received as decimal(18,0)) /
cast(second(current_timestamp-start_time) as decimal(18,0)))
as "Bytes received/second"
from sessions
```

```
      Session: 24
      Client: ALBERT
      State: Run
      Elapsed Time: 0 01:14:05.000000
      Bytes sent/second: 564321.9302768451
      Bytes received/second: 0.0026748857944
```

```
      Session: 26
      Client: MILTON
      State: Run
      Elapsed Time: 0 00:06:13.000000
      Bytes sent/second: 1638.5284210992221
      Bytes received/second: 675821.6888561849
```

## Example: Determine how long the current background processes have been running and determine their effective throughput in time and files per second

---

Note: Expiration does not report the number of bytes processed.

```
select process_num as "Number",
process,
current_timestamp-start_time as "Elapsed Time",
(cast(files_processed as decimal(18,0)) /
cast(second(current_timestamp-start_time) as decimal(18,0)))
as "Files/second",
(cast(bytes_processed as decimal(18,0)) /
cast(second(current_timestamp-start_time) as decimal(18,0)))
as "Bytes/second"
from processes
```

```
      Number: 1
      PROCESS: Expiration
      Elapsed Time: 0 00:24:36.000000
      Files/second: 6.3216755870092
      Bytes/second: 0.0000000000000
```

## Example: Count the number of client nodes for each platform type

---

```
select platform_name,count(*) as "Number of Nodes"
from nodes group by platform_name
```

PLATFORM_NAME	Number of Nodes
AIX	6
SunOS	27
Win32	14
Linux	20

## Example: Count the number of file spaces each client node has and list the client nodes ascending order

---

```
select node_name, count(*) as "number of filespaces"
from filespaces group by node_name order by 2
```

NODE_NAME	number of filespaces
ALBERT	2
MILTON	2
BARNEY	3
SEBASTIAN	3
MAILHOST	4
FALCON	4
WILBER	4
NEWTON	4
JEREMY	4
WATSON	5
RUSSELL	5

## Example: Obtain statistical information for calculating the number of off-site volumes that have their space reclaimed during reclamation of a storage pool.

---

```
select * from summary where activity='OFFSITE RECLAMATION'
```

```
START_TIME: 2004-06-16 13:47:31.000000
END_TIME: 2004-06-16 13:47:34.000000
ACTIVITY: OFFSITE RECLAMATION
NUMBER: 4
ENTITY: COPYPOOL
COMMMETH:
ADDRESS:
SCHEDULE_NAME:
EXAMINED: 170
AFFECTED: 170
FAILED: 0
BYTES: 17821251
IDLE: 0
MEDIAS: 0
PROCESSES: 2
SUCCESSFUL: YES
VOLUME_NAME:
DRIVE_NAME:
LIBRARY_NAME:
LAST_USE:
COMM_WAIT:
NUM_OFFSITE_VOLS: 2
```

## Example: Identify which storage pools contain data that was deduplicated by clients

---

```
select stgpool_name,has_client_dedup_data from stgpools
```

STGPOOL_NAME	HAS_CLIENT_DEDUP_DATA
ADPOOL	NO
ARCHIVEPOOL	NO

```

BACKUPPOOL          NO
COPYDEDUP           NO
COPYNODEDUP         NO
FILEPOOL            YES
FILEPOOL2           NO
LANFREEFILEPOOL     YES
SPACEMGPOOL         NO

```

## Example: Obtain information about the database

---

```

select * from db

    DATABASE_NAME: TSMDB1
TOT_FILE_SYSTEM_MB: 2048000
    USED_DE_SPACE_MB: 12576
    FREE_SPACE_MB: 1576871
    TOTAL_PAGES: 983044
    USABLE_PAGES: 982908
    USED_PAGES: 977736
    FREE_PAGES: 5172
    BUFF_HIT_RATIO: 96.2
    TOTAL_BUFF_REQ: 53967
    SORT_OVERFLOW: 0
    LOCK_ESCALATION: 0
    PKG_HIT_RATIO: 70.0
    LAST_REORG: 2010-07-15 17:32:55.000000
    FULL_DEV_CLASS: OUTFILE
    NUM_BACKUP_INCR: 0
    LAST_BACKUP_DATE: 2010-01-21 10:37:59.000000
    PHYSICAL_VOLUMES: 0
    PAGE_SIZE:
    NUM_BACKUP_STREAMS: 4

```

## Example: Obtain PVU estimate detail records

---

Generate the PVU estimate for a node named ACCTSRECSRV, which is used by the IBM Spectrum Protect Extended Edition product.

```

select * from pvuestimate_details where node_name='ACCTSRECSRV'

    PRODUCT: PRODEE
    LICENSE_NAME: MGSYSLAN
    NODE_NAME: ACCTSRECSRV
    LAST_USED: 2008-01-20 16:12:24.000000
    TRYBUY: FALSE
    PROC_VENDOR: IBM
    PROC_BRAND: POWER5+ QCM
    PROC_TYPE: 4
    PROC_MODEL:
    PROC_COUNT: 2
    ROLE: SERVER
    ROLE_OVERRIDE: USEREPORTED
    ROLE_EFFECTIVE: SERVER
    VALUE_UNITS: 50
    VALUE_FROM_TABLE: YES
    PVU: 100
    SCAN_ERROR : NO
    API_CLIENT: NO
    PVU_AGNOSTIC: NO
    HYPERVISOR: VMWARE
    GUID: 01.2e.1c.80.e5.04-
        .11.da.aa.ab.00.-
        15.58.0b.d9.47
    VERSION: 6
    RELEASE: 3
    LEVEL: 1
    VENDOR_D: IBM(R)
    BRAND_D: POWER5(TM) QCM
    TYPE_D: Quad-core Module
    MODEL_D: All Existing
    PRODUCT_D: IBM Spectrum Protect Extended Edition

```



## Field descriptions

---

### PRODUCT

Rollup of license types into products at the level presented in the QUERY PVUESTIMATE command. Possible values are PRODEE, PROTBASIC, PRODDATARET, PRODMAIL, PRODDDB, PRODSYSB, PRODSPACE, PRODSAN, PRODERP, or blank.

### LICENSE\_NAME

The license assigned to this node.

### NODE\_NAME

The node name.

### LAST\_USED

Date and time the identified node last connected to the system under this license.

### TRYBUY

Indicates if running under try and buy mode. Possible values are TRUE or FALSE.

### PROC\_VENDOR

Processor vendor name as reported by the client.

### PROC\_BRAND

Processor brand name as reported by the client.

### PROC\_TYPE

Processor type as reported by the client. This value also reflects the number of cores. Example values are 1=SINGLE CORE, 2=DUO CORE, and 4=QUAD CORE.

### PROC\_MODEL

Processor model as reported by the client.

### PROC\_COUNT

Processor quantity.

### ROLE

Node role. Possible values are CLIENT, SERVER, or OTHER.

### ROLE\_OVERRIDE

Override value specified in the UPDATE NODE command.

### ROLE\_EFFECTIVE

Actual role based on the values in the ROLE and ROLE\_OVERRIDE fields.

### VALUE\_UNITS

Assigned processor value unit (PVU) for the processor.

### PVU

Calculated PVU value.

$$\text{PVU per node} = \text{number of processors per node} * \text{processor type} * \text{pvu value}$$

where the `processor type` represents the number of cores, and the `pvu value` is the value defined for the processor type in the IBM® PVU table.

### VALUE\_FROM\_TABLE

Flag that indicates whether the PVU was calculated based on the IBM PVU table. Possible values are YES or NO. If NO, a value of 100 is applied for each node defined as a server. If no role is defined for a node, the role of server is assumed for purposes of PVU calculation.

### SCAN\_ERROR

Flag that indicates whether license information was reported by client. Possible values are YES or NO.

### API\_CLIENT

Flag that indicates an API application. Possible values are YES or NO.

### PVU\_AGNOSTIC

Flag indicating that the client version release level is earlier than IBM Spectrum Protect V6.3. If the version is earlier than 6.3, valid PVU metrics are not expected. Possible values are YES or NO.

### HYPERVISOR

Name of the virtual machine software as reported by the client.

### GUID

Globally Unique Identifier (GUID) of the computer where the node is located. The GUID is obtained from the node table.

### VERSION

Version of client.

### RELEASE

Release of client.

### LEVEL

Level of client.

### VENDOR\_D

Processor vendor display value from the PVU table.

BRAND\_D

Processor brand display value from the PVU table.

TYPE\_D

Processor type display value from the PVU table.

MODEL\_D

Processor model display value from the PVU table.

PRODUCT\_D

Product display value from the PVU table. The following values are possible:

- IBM Spectrum Protect
- IBM Spectrum Protect Extended Edition
- IBM Spectrum Protect for Data Retention
- IBM Spectrum Protect for SAN
- IBM Spectrum Protect for Space Management
- IBM Spectrum Protect for Mail
- IBM Spectrum Protect for Databases
- IBM Spectrum Protect for Enterprise Resource Planning
- IBM Spectrum Protect for System Backup and Recovery
- Blank

## Example: Obtain role and PVU-related information

---

The following example shows partial results for a selected node, including PVU-related information and role information. Possible roles are CLIENT, SERVER, or OTHER. PVU is calculated only for nodes defined as servers.

```
select * from nodes
```

```
ROLE: CLIENT
  ROLE_O: USERREPORTED
  PVENDOR: INTEL
  PBRAND: INTEL
  PTYPE: 4
  PMODEL:
  PCOUNT: 1
HYPERVISOR:
  PAPI: NO
  SCANNEROR: NO
```

## SET commands

---

Use the SET commands to specify values that affect many different IBM Spectrum Protect™ operations.

- SET ACCOUNTING (Set accounting records on or off)
- SET ACTLOGRETENTION (Set the retention period or the size of the activity log)
- SET ALERTACTIVEDURATION (Set the duration of an active alert)
- SET ALERTCLOSEDDURATION (Set the duration of a closed alert)
- SET ALERTEMAIL (Set the alert monitor to email alerts to administrators)
- SET ALERTEMAILFROMADDR (Set the email address of the sender)
- SET ALERTEMAILSMTPHOST (Set the SMTP mail server host name)
- SET ALERTEMAILSMTPPORT (Set the SMTP mail server host port)
- SET ALERTINACTIVEDURATION (Set the duration of an inactive alert)
- SET ALERTMONITOR (Set the alert monitor to on or off)
- SET ALERTSUMMARYTOADMINS (Set the list of administrators to receive alert summaries by email )
- SET ALERTUPDATEINTERVAL (Set how often the alert monitor updates and prunes alerts)
- SET ARCHIVERETENTIONPROTECTION (Activate data retention protection)
- SET ARREPLRULEDEFAULT (Set the server replication rule for archive data)
- SET BKREPLRULEDEFAULT (Set the server replication rule for backup data)
- SET CLIENTACTDURATION (Set the duration period for the client action)
- SET CONFIGMANAGER (Specify a configuration manager)
- SET CONFIGREFRESH (Set managed server configuration refresh)
- SET CONTEXTMESSAGING (Set message context reporting on or off)
- SET CPUINFOREFRESH (Refresh interval for the client workstation information scan)
- SET CROSSDEFINE (Specifies whether to cross-define servers)
- SET DBRECOVERY (Set the device class for automatic backups)

- SET DEDUPVERIFICATIONLEVEL (Set the percentage of extents to verify)
- SET DEFAULTAUTHENTICATION (Set the default authentication method for REGISTER NODE and REGISTER ADMIN commands)
- SET DISSIMILARPOLICIES (Enable the policies on the target replication server to manage replicated data)
- SET DRMACTIVEDATASTGPOOL (Specify the active-data pools to be managed by DRM)
- SET DRMCHECKLABEL (Specify label checking)
- SET DRMCMDFILENAME (Specify the name of a file to contain commands)
- |     |       |         |
|-----|-------|---------|
| AIX | Linux | Windows |
|-----|-------|---------|

 SET DRMCOPYCONTAINERSTGPOOL (Specify the container-copy storage pools to be processed by DRM commands)
- SET DRMCOPYSTGPOOL (Specify the copy storage pools to be managed by DRM)
- SET DRMCOURIERNAME (Specify the courier name)
- SET DRMDBBACKUPEXPIREDAYS (Specify DB backup series expiration)
- SET DRMFILEPROCESS (Specify file processing)
- SET DRMINSTRPREFIX (Specify the prefix for recovery instructions file names)
- SET DRMNOTMOUNTABLENAME (Specify the not mountable location name)
- SET DRMPPLANPREFIX (Specify a prefix for recovery plan file names)
- SET DRMPPLANVPOSTFIX (Specify replacement volume names)
- SET DRMPRIMSTGPOOL (Specify the primary storage pools to be managed by DRM)
- SET DRMRPFEXPIREDAYS (Set criteria for recovery plan file expiration)
- SET DRMVaultNAME (Specify the vault name)
- SET EVENTRETENTION (Set the retention period for event records)
- SET FAILOVERHLADDRESS (Set a failover high level address)
- SET INVALIDPWLIMIT (Set the number of invalid logon attempts)
- SET LDAPPASSWORD (Set the LDAP password for the server)
- SET LDAPUSER (Specify an ID for an LDAP directory server)
- SET LICENSEAUDITPERIOD (Set license audit period)
- SET MAXCMDRETRIES (Set the maximum number of command retries)
- SET MAXSCHEDESESSIONS (Set maximum scheduled sessions)
- SET MINPWLENGTH (Set minimum password length)
- SET MONITORINGADMIN (Set the name of the monitoring administrator)
- SET MONITOREDSEVERGROUP (Set the group of monitored servers)
- SET NODEATRISKINTERVAL (Specifies at-risk mode for an individual node)
- SET PASSEXP (Set password expiration date)
- SET PRODUCTOFFERING (Set the product offering that is licensed to your enterprise)
- SET QUERYSCHEDPERIOD (Set query period for polling client nodes)
- SET RANDOMIZE (Set randomization of scheduled start times)
- SET REPLRECOVERDAMAGED (Specify whether damaged files are recovered from a replication server)
- SET REPLRETENTION (Set the retention period for replication records)
- SET REPLSERVER (Set the target replication server)
- SET RETRYPERIOD (Set time between retry attempts)
- SET SCHEDMODES (Select a central scheduling mode)
- SET SERVERHLADDRESS (Set the high-level address of a server)
- SET SERVERLLADDRESS (Set the low-level address of a server)
- SET SERVERNAME (Specify the server name)
- SET SERVERPASSWORD (Set password for server)
- SET SPREPLRULEDEFAULT (Set the server replication rule for space-managed data)
- SET STATUSATRISKINTERVAL (Specifies whether to enable client at-risk activity interval evaluation)
- SET STATUSMONITOR (Specifies whether to enable status monitoring)
- SET STATUSREFRESHINTERVAL (Set refresh interval for status monitoring)
- SET STATUSSKIPASFILURE (Specifies whether to use client at-risk skipped files as failure evaluation)
- SET SUBFILE (Set subfile backup for client nodes)
- SET SUMMARYRETENTION (Set number of days to keep data in activity summary table)
- SET TAPEALERTMSG (Set tape alert messages on or off)
- SET TOCLOADRETENTION (Set load retention period for table of contents)
- SET VMATRISKINTERVAL (Specifies the at-risk mode for an individual VM filespace)

## SET ACCOUNTING (Set accounting records on or off)

---

Use this command to determine whether an accounting record is created every time a client node session ends. An accounting record tracks the amount of storage used by a client node session.

Use the QUERY STATUS command to determine whether accounting records are generated. At installation, this value is set to OFF.

The accounting records are stored in an accounting file named dsmacct.log.

**AIX** | **Linux** The environment variable, DSMSEV\_ACCOUNTING\_DIR, specifies the directory where the accounting file is located.

**Windows** A registry entry controls the location of the accounting log.

## Privilege class

---

To issue this command, you must have system privilege.

## Syntax

---

```
>>-Set ACCounting--+-ON--+------><
                        '-OFF-'
```

## Parameters

---

- ON  
Specifies that the server creates an accounting record every time a client node session ends.
- OFF  
Specifies that the server does not create accounting records.

## Example: Create accounting records

---

To create an accounting record at the end of each client node session issue the command:

```
set accounting on
```

## Related commands

---

Table 1. Commands related to SET ACCOUNTING

Command	Description
QUERY STATUS	Displays the settings of server parameters, such as those selected by the SET commands.

## SET ACTLOGRETENTION (Set the retention period or the size of the activity log)

---

Use this command to manage the activity log records by date or size. The activity log contains normal activity messages generated by the server. These messages include information about server and client operations, such as the start time of sessions or device I/O errors.

Activity log information includes messages, such as the following:

- Client session starts and ends
- Migration starts and ends
- Diagnostic error messages
- Scheduled administrative command output

At server installation, activity log management is retention-based, and the retention period is set to 30 days.

You can choose to adjust the length of time that the activity log retains messages to avoid insufficient or outdated data. The server automatically removes the messages from the activity log after the retention period passes.

Alternatively, you can choose to limit the total size of the activity log to control the amount of space occupied by the activity log. The server will periodically remove the oldest activity log records until the activity log size no longer exceeds the configured maximum size allowed.

You can issue the QUERY STATUS command to display the current number of records in the activity log and the size (in megabytes) that the activity log currently occupies.

## Privilege class

To issue this command, you must have system privilege.

## Syntax

```
>>-Set ACTlogretention--number--+-Mgmtstyle---Date-----><
                                     '-Mgmtstyle---Date+-'
                                     '-Size-'
```

## Parameters

number (Required)

Specifies the number of days to retain messages in the activity log when the log is managed by date, or specifies the maximum size of the activity log when it is managed by size. With retention-based management, a value of 1 specifies to retain the activity log records only for the current day. With size-based management, a value of 1 specifies a maximum size of 1 MB for the activity log. You can specify a number from 0 to 9999. A value of 0 disables activity log retention.

Mgmtstyle

Specifies whether activity log management is retention-based or size-based. This parameter is optional. The default is DATE. Possible values are:

Date

Specifies that activity log management is retention-based.

Size

Specifies that activity log management is size-based.

## Example: Set the activity log retention period

Set the server to retain activity log records for 60 days. Issue the command:

```
set actlogretention 60
```

## Example: Set the activity log size

Set the server to limit the size of the activity log to 300 MB. Issue the command:

```
set actlogretention 300 mgmtstyle=size
```

## Related commands

Table 1. Command related to SET ACTLOGRETENTION

Command	Description
QUERY ACTLOG	Displays messages from the server activity log.
QUERY STATUS	Displays the settings of server parameters, such as those selected by the SET commands.

## SET ALERTACTIVEDURATION (Set the duration of an active alert)

Use this command to specify how long an alert remains active before it becomes inactive. If an active alert is triggered again, the duration is restarted.

## Privilege class

To issue this command, you must have system privilege.

## Syntax

---

```
>>-Set ALERTACTiveduration -number_mins-----<<
```

## Parameters

---

number\_mins (Required)

Specifies the number of minutes that an alert remains active before it becomes inactive. Specify a value from 1 to 20160. The initial server default value is 480 minutes.

## Set the duration of an active alert to one day

---

Issue the following command to specify that alerts remain active for 1440 minutes before they change to inactive status:

```
set alertactiveduration 1440
```

## Related commands

---

Table 1. Commands related to SET ALERTACTIVEDURATION

Command	Description
QUERY MONITORSETTINGS (Query the configuration settings for monitoring alerts and server status)	Displays information about monitoring alerts and server status settings.
SET ALERTINACTIVEDURATION (Set the duration of an inactive alert)	Specifies how long an alert remains inactive before it is closed.
SET ALERTCLOSEDDURATION (Set the duration of a closed alert)	Specifies how long an alert remains closed before it is deleted.
SET ALERTMONITOR (Set the alert monitor to on or off)	Specifies whether alert monitoring is set to on or off.
SET ALERTUPDATEINTERVAL (Set how often the alert monitor updates and prunes alerts)	Specifies how often the alert monitor updates and prunes alerts from the database.

## SET ALERTCLOSEDDURATION (Set the duration of a closed alert)

---

Use this command to specify how long an alert remains closed before it is deleted.

## Privilege class

---

To issue this command, you must have system privilege.

## Syntax

---

```
>>-Set ALERTClosedduration -number_mins-----<<
```

## Parameters

---

number\_mins (Required)

Specifies the number of minutes that an alert remains closed before it is deleted. Setting the value to 0 causes alerts to be deleted immediately after they are closed. Specify a value from 0 to 99999. The default value is set to 60 minutes when the IBM Spectrum Protect™ server database is initially formatted.

## Delete alerts two hours after they are closed

---

Specify that alerts remain closed for 120 minutes before they are deleted:

```
set alertclosedduration 120
```

## Related commands

Table 1. Commands related to SET ALERTCLOSEDDURATION

Command	Description
QUERY MONITORSETTINGS (Query the configuration settings for monitoring alerts and server status)	Displays information about monitoring alerts and server status settings.
SET ALERTACTIVEDURATION (Set the duration of an active alert)	Specifies how long an alert remains active before it is moved to inactive status.
SET ALERTINACTIVEDURATION (Set the duration of an inactive alert)	Specifies how long an alert remains inactive before it is closed.
SET ALERTMONITOR (Set the alert monitor to on or off)	Specifies whether alert monitoring is set to on or off.
SET ALERTUPDATEINTERVAL (Set how often the alert monitor updates and prunes alerts)	Specifies how often the alert monitor updates and prunes alerts from the database.

## SET ALERTEMAIL (Set the alert monitor to email alerts to administrators)

Use this command to enable alerts to be sent to specified administrators by email.

### Privilege class

To issue this command, you must have system privilege.

### Syntax

```
>>-Set ALERTEMail---ON---+-----><
      '-Off-'
```

### Parameters

ON

Specifies that alerts can be sent to specified administrators by email.

OFF

Specifies that alerts cannot be sent to specified administrators by email. When the server database is initially formatted, the ALERTEMAIL setting is set to OFF.

### Enable alerts to be sent to the administrator when they occur

Enable alerts to be sent by email by issuing the following command:

```
SET ALERTEMAIL ON
```

## Related commands

Table 1. Commands related to SET ALERTEMAIL

Command	Description
QUERY MONITORSETTINGS (Query the configuration settings for monitoring alerts and server status)	Displays information about monitoring alerts and server status settings.
SET ALERTEMAILFROMADDR (Set the email address of the sender)	Specifies the email address of the alert sender.
SET ALERTEMAILSMTPHOST (Set the SMTP mail server host name)	Specifies the SMTP mail server host name that is used to send alerts by email.
SET ALERTEMAILSMTPPORT (Set the SMTP mail server host port)	Specifies the SMTP mail server port that is used to send alerts by email.

Command	Description
SET ALERTSUMMARYTOADMINS (Set the list of administrators to receive alert summaries by email )	Specifies the administrators that want to receive alert summaries by email.

## SET ALERTEMAILFROMADDR (Set the email address of the sender)

Use this command to specify the email address of the alert sender.

### Privilege class

To issue this command, you must have system privilege.

### Syntax

```
>>-Set ALERTEMAILFRomaddr -email_address-----<<
```

### Parameters

email\_address (Required)

Specifies the email address of the sender. Email addresses are in the form of *name@domain*. Email names, including the address, cannot exceed 64 characters in length, and the domain name cannot exceed 255 characters in length.

### Specify the email address of the alert sender

Specify the email address of the sender by issuing the following command:

```
set alertemailfromaddr djadmin@mydomain.com
```

### Related commands

Table 1. Commands related to SET ALERTEMAILFROMADDR

Command	Description
QUERY MONITORSETTINGS (Query the configuration settings for monitoring alerts and server status)	Displays information about monitoring alerts and server status settings.
SET ALERTEMAIL (Set the alert monitor to email alerts to administrators)	Enables alerts to be sent by email to specified administrators.
SET ALERTEMAILSMTPHOST (Set the SMTP mail server host name)	Specifies the SMTP mail server host name that is used to send alerts by email.
SET ALERTEMAILSMTPPORT (Set the SMTP mail server host port)	Specifies the SMTP mail server port that is used to send alerts by email.
SET ALERTSUMMARYTOADMINS (Set the list of administrators to receive alert summaries by email )	Specifies the administrators that want to receive alert summaries by email.

## SET ALERTEMAILSMTPHOST (Set the SMTP mail server host name)

Use this command to specify the Simple Mail Transfer Protocol (SMTP) mail server host name that is used to send the alert email.

### Privilege class

To issue this command, you must have system privilege.

### Syntax



```
>>-Set ALERTEMAILSMTPHost--host_name-----><
```

## Parameters

host\_name (Required)  
Specifies the SMTP mail server host name.

## Specify the host name for the SMTP mail server as mail.domain.com

Specify mail.domain.com as the SMTP mail server, by issuing the following command:

```
set alertemailsmtpost mail.domain.com
```

## Related commands

Table 1. Commands related to SET ALERTEMAILSMTPHOST

Command	Description
SET ALERTEMAIL (Set the alert monitor to email alerts to administrators)	Enables alerts to be sent by email to specified administrators.
SET ALERTEMAILFROMADDR (Set the email address of the sender)	Specifies the email address of the alert sender.
SET ALERTEMAILSMTPPORT (Set the SMTP mail server host port)	Specifies the SMTP mail server port that is used to send alerts by email.
SET ALERTSUMMARYTOADMINS (Set the list of administrators to receive alert summaries by email)	Specifies the administrators that want to receive alert summaries by email.

## SET ALERTEMAILSMTPPORT (Set the SMTP mail server host port)

Use this command to specify the port number for the SMTP mail server. This mail server is used to send the alerts by email.

## Privilege class

To issue this command, you must have system privilege.

## Syntax

```
>>-Set ALERTEMAILSMTPPort--tcp_port-----><
```

## Parameters

tcp\_port (Required)  
Specifies the port number of the SMTP mail server. Specify a value of 1 through 32767. The default port number is 25.

## Specify the port number of the SMTP mail server

Specify port number 450 as your SMTP mail server by issuing the following command:

```
set alertemailsmtpport 450
```

## Related commands

Table 1. Commands related to SET ALERTEMAILSMTPPORT

Command	Description
---------	-------------

Command	Description
SET ALERTEMAIL (Set the alert monitor to email alerts to administrators)	Enables alerts to be sent by email to specified administrators.
SET ALERTEMAILFROMADDR (Set the email address of the sender)	Specifies the email address of the alert sender.
SET ALERTEMAILSMTPHOST (Set the SMTP mail server host name)	Specifies the SMTP mail server host name that is used to send alerts by email.
SET ALERTSUMMARYTOADMINS (Set the list of administrators to receive alert summaries by email)	Specifies the administrators that want to receive alert summaries by email.

## SET ALERTSUMMARYTOADMINS (Set the list of administrators to receive alert summaries by email)

Use this command to specify the administrators that want to receive alert summaries by email, every hour.

### Privilege class

To issue this command, you must have system privilege.

### Syntax

```
>>-Set ALERTSUMMARYToadmins---+--admin_name-+-----><
                        ',-----'
```

### Parameters

admin\_name (Required)

Specifies the administrator name that wants to receive alert summaries by email. You can specify up to three administrator names by separating them with commas and no intervening spaces.

### Specify two administrators to receive alert summaries

Specify that administrators HARRY and COLIN want to receive alert summaries, by issuing the following command:

```
set alertsummarytoadmins HARRY,COLIN
```

### Related commands

Table 1. Commands related to SET ALERTSUMMARYTOADMINS

Command	Description
SET ALERTEMAIL (Set the alert monitor to email alerts to administrators)	Enables alerts to be sent by email to specified administrators.
SET ALERTEMAILFROMADDR (Set the email address of the sender)	Specifies the email address of the alert sender.
SET ALERTEMAILSMTPHOST (Set the SMTP mail server host name)	Specifies the SMTP mail server host name that is used to send alerts by email.
SET ALERTEMAILSMTPPORT (Set the SMTP mail server host port)	Specifies the SMTP mail server port that is used to send alerts by email.

## SET ALERTINACTIVEDURATION (Set the duration of an inactive alert)

Use this command to specify how long an alert remains inactive. After the inactive duration is past, the alert is closed.

## Privilege class

---

To issue this command, you must have system privilege.

## Syntax

---

```
>>-Set ALERTINactiveduration -number_mins-----><
```

## Parameters

---

number\_mins (Required)

Specifies the number of minutes that an alert remains inactive before it is closed. You can specify a value in the range 1 - 20160. The initial server default value is 480 minutes.

## Change alert status from inactive to closed after 60 minutes

---

Issue the following command to specify that an alert remains in inactive status for 60 minutes before it changes to closed status:

```
set alertinactiveduration 60
```

## Related commands

---

Table 1. Commands related to SET ALERTINACTIVEDURATION

Command	Description
SET ALERTACTIVEDURATION (Set the duration of an active alert)	Specifies how long an alert remains active before it is moved to inactive status.
SET ALERTCLOSEDDURATION (Set the duration of a closed alert)	Specifies how long an alert remains closed before it is deleted.
SET ALERTMONITOR (Set the alert monitor to on or off)	Specifies whether alert monitoring is set to on or off.
SET ALERTUPDATEINTERVAL (Set how often the alert monitor updates and prunes alerts)	Specifies how often the alert monitor updates and prunes alerts from the database.

## SET ALERTMONITOR (Set the alert monitor to on or off)

---

Use this command to turn the alert monitor on or off.

## Privilege class

---

To issue this command, you must have system privilege.

## Syntax

---

```
>>-Set ALERTMONITOR .-OFF-. -+-ON--+-----><
```

## Parameters

---

ON

Specifies that the IBM Spectrum Protect™ server monitors alerts.

OFF

Specifies that the IBM Spectrum Protect server does not monitor alerts. When the IBM Spectrum Protect server database is initially formatted, the alert monitoring setting is set to OFF.

## Turn on alert monitoring

---

Turn on alert monitoring by issuing the following command:

```
set alertmonitor on
```

## Related commands

Table 1. Commands related to SET ALERTMONITOR

Command	Description
SET ALERTACTIVEDURATION (Set the duration of an active alert)	Specifies how long an alert remains inactive before it is closed.
SET ALERTINACTIVEDURATION (Set the duration of an inactive alert)	Specifies how long an alert remains inactive before it is closed.
SET ALERTCLOSEDDURATION (Set the duration of a closed alert)	Specifies how long an alert remains closed before it is deleted.
SET ALERTUPDATEINTERVAL (Set how often the alert monitor updates and prunes alerts)	Specifies how often the alert monitor updates and prunes alerts from the database.

## SET ALERTUPDATEINTERVAL (Set how often the alert monitor updates and prunes alerts)

Use this command to specify how often the alert monitor updates and prunes alerts that are stored in the IBM Spectrum Protect™ server database.

During this check interval, the alert monitor examines each alert on the server and completes the following actions:

- The alert monitor determines whether the active or inactive durations elapsed. If the specified duration elapses, the alert status is updated to the next state. For example:
  - Active to Inactive
  - Inactive to Closed
- If an alert is closed for the duration that is specified by the SET ALERTCLOSEDDURATION command, the alert is deleted.

You can use the QUERY MONITORSETTINGS command to determine whether alert monitoring is on. Use the SET ALERTMONITOR command to turn on alert monitoring.

## Privilege class

To issue this command, you must have system privilege.

## Syntax

```
>>-Set ALERTUPDateinterval -number_mins-----<<
```

## Parameters

number\_mins (Required)

Specifies the length of time, in minutes, that the monitor waits before alerts are updated and pruned on the server. Specify a value from 1 to 9999. The server has an initial default value of 10 minutes.

## Set alert update interval to 60 minutes

Specify that alerts are updated every hour by issuing the following command:

```
set alertupdateinterval 60
```

## Related commands

Table 1. Commands related to SET ALERTUPDATEINTERVAL

Command	Description
SET ALERTACTIVEDURATION (Set the duration of an active alert)	Specifies how long an alert remains active before it is moved to inactive status.
SET ALERTINACTIVEDURATION (Set the duration of an inactive alert)	Specifies how long an alert remains inactive before it is closed.
SET ALERTCLOSEDDURATION (Set the duration of a closed alert)	Specifies how long an alert remains closed before it is deleted.
SET ALERTMONITOR (Set the alert monitor to on or off)	Specifies whether alert monitoring is set to on or off.

## SET ARCHIVERETENTIONPROTECTION (Activate data retention protection)

Use this command to activate and deactivate archive data retention protection. The server cannot contain any data in order for this command to work. At installation, the value is set to OFF.

When archive data retention protection is active:

- Only archive copies can be stored on the server.
- No archive copy can be deleted until the RETVER parameter in the DEFINE COPYGROUP (archive) command is satisfied.

Defining storage pools of type RECLAMATIONTYPE=SNAPLOCK is only supported on servers with data retention protection enabled.

Use the QUERY STATUS command to display the status of archive data retention protection.

### Privilege class

To issue this command you must have system privilege or unrestricted storage privilege.

### Syntax

```
>>-Set ARCHIVERETENTIONPROTECTION +-OFF+-----><
                                     '-ON--'
```

### Parameters

- OFF  
Specifies that archive data retention protection is not active.
- ON  
Specifies the archive data retention protection is active.

### Example: Activate data retention protection

Activate archive data retention protection by issuing the following command:

```
set archiveretentionprotection on
```

### Related commands

Table 1. Commands related to SET ARCHIVERETENTIONPROTECTION

Command	Description
ACTIVATE POLICYSET	Validates and activates a policy set.
AUDIT VOLUME	Compares database and storage pool information, and optionally, resolves any inconsistencies.

Command	Description
DEFINE COPYGROUP	Defines a copy group for backup or archive processing within a specified management class.
DEFINE VOLUME	Assigns a volume to be used for storage within a specified storage pool.
DELETE FILESPACE	Deletes data associated with client file spaces. If a file space is part of a collocation group and you remove the file space from a node, the file space is removed from the collocation group.
QUERY COPYGROUP	Displays the attributes of a copy group.
QUERY STATUS	Displays the settings of server parameters, such as those selected by the SET commands.
UPDATE COPYGROUP	Changes one or more attributes of a copy group.

## SET ARREPLRULEDEFAULT (Set the server replication rule for archive data)

Use this command to set the server replication rule for archive data.

Restriction: The replication rule that you set with this command is applied only if file space rules and client node rules for archive data are set to DEFAULT.

Issue this command on the server that acts as a source for replicated data.

You can specify a normal-priority replication rule or a high-priority replication rule. In a replication process that includes both normal-priority and high-priority data, high-priority data is replicated first. Before you specify a rule, consider the order in which you want the data to be replicated.

For example, suppose that your client nodes contain archive data and backup data. Replication of the archive data is a higher priority than the backup data. To prioritize the archive data, issue the SET ARREPLRULEDEFAULT command and specify the ALL\_DATA\_HIGH\_PRIORITY replication rule. To prioritize the backup data, issue the SET BKREPLRULEDEFAULT command and specify the ALL\_DATA replication rule for backup data. The ALL\_DATA rule for backup data replicates backup data with a normal priority.

### Privilege class

To issue this command, you must have system privilege.

### Syntax

```
>>-Set ARREPLRuledefault--+-ALL_DATA-----+-----><
                               +-ALL_DATA_HIGH_PRIORITY--+
                               '-NONE-----'
```

### Parameters

- ALL\_DATA  
Replicates archive data with a normal priority.
- ALL\_DATA\_HIGH\_PRIORITY  
Replicates archive data with a high priority.
- NONE  
Archive data is not replicated.

### Example: Set the server replication rule for archive data

Set up the default rule for archive data to replicate with a high priority.

```
set arreplruledefault all_data_high_priority
```

## Related commands

Table 1. Commands related to SET ARREPLRULEDEFAULT

Command	Description
QUERY FILESPACE	Displays information about data in file spaces that belong to a client.
QUERY NODE	Displays partial or complete information about one or more clients.
QUERY REPLICATION	Displays information about node replication processes.
QUERY REPLRULE	Displays information about node replication rules.
QUERY STATUS	Displays the settings of server parameters, such as those selected by the SET commands.
REPLICATE NODE	Replicates data in file spaces that belong to a client node.
SET BKREPLRULEDEFAULT	Specifies the server node-replication rule for backup data.
SET SPREPLRULEDEFAULT	Specifies the server node-replication rule for space-managed data.
UPDATE FILESPACE	Changes file-space node-replication rules.
UPDATE REPLRULE	Enables or disables replication rules.
VALIDATE REPLICATION	Verifies replication for file spaces and data types.

## SET BKREPLRULEDEFAULT (Set the server replication rule for backup data)

Use this command to set the server replication rule for backup data.

Restriction: The replication rule that you set with this command is applied only if file space rules and client node rules for backup data are set to DEFAULT.

Issue this command on the server that acts as a source for replicated data.

You can specify normal-priority replication rules or high-priority replication rules. In a replication process that includes both normal and high-priority data, high-priority data is replicated first. Before you specify a rule, consider the order in which you want the data to be replicated.

For example, suppose that your client nodes contain archive data and active backup data. Replication of the active backup data is a higher priority than the archive data. To prioritize the backup data, issue the SET BKREPLRULEDEFAULT command and specify the ACTIVE\_DATA\_HIGH\_PRIORITY replication rule. To prioritize the archive data, issue the SET ARREPLRULEDEFAULT command and specify the ALL\_DATA replication rule for archive data. The ALL\_DATA rule for archive data replicates archive data with a normal priority.

## Privilege class

To issue this command, you must have system privilege.

## Syntax

```
>>-Set BKREPLRuledefault--+-ALL_DATA-----+-----><
      +-ACTIVE_DATA-----+
      +-ALL_DATA_HIGH_PRIORITY----+
      +-ACTIVE_DATA_HIGH_PRIORITY-+
      '-NONE-----'
```

## Parameters

#### ALL\_DATA

Replicates active and inactive backup data. The data is replicated with normal priority.

#### ACTIVE\_DATA

Replicates active backup data. The data is replicated with normal priority.

Attention: If you specify ACTIVE\_DATA and one or more of the following conditions are true, inactive backup data on the target replication server is deleted, and inactive backup data on the source replication server is not replicated.

- When a server version earlier than Version 7.1.1 is installed on either the source or target replication servers.
- When you are using the REPLICATE NODE command with the FORCERECONCILE=YES parameter.
- When you are running the initial replication of a file space after you configure replication, restore the database, or upgrade both the source and target replication servers from a server version earlier than V7.1.1.

If the previous conditions are not true, all new and changed files since the last replication are replicated, including inactive files, and files are deleted when they expire.

#### ALL\_DATA\_HIGH\_PRIORITY

Replicates active and inactive backup data. Data is replicated with a high priority.

#### ACTIVE\_DATA\_HIGH\_PRIORITY

This rule is the same as the ACTIVE\_DATA replication rule except data is replicated with a high priority.

#### NONE

Backup data is not replicated.

## Example: Set the server replication rule for backup data

Set up the default rule for backup data to replicate only active data and to replicate the data with a high priority.

```
set bkreplruledefault active_data_high_priority
```

## Related commands

Table 1. Commands related to SET BKREPLRULEDEFAULT

Command	Description
QUERY FILESPACE	Displays information about data in file spaces that belong to a client.
QUERY NODE	Displays partial or complete information about one or more clients.
QUERY REPLICATION	Displays information about node replication processes.
QUERY REPLRULE	Displays information about node replication rules.
QUERY STATUS	Displays the settings of server parameters, such as those selected by the SET commands.
REPLICATE NODE	Replicates data in file spaces that belong to a client node.
SET ARREPLRULEDEFAULT	Specifies the server node-replication rule for archive data.
SET REPLRETENTION	Specifies the retention period for replication history records.
SET SPREPLRULEDEFAULT	Specifies the server node-replication rule for space-managed data.
UPDATE FILESPACE	Changes file-space node-replication rules.
UPDATE REPLRULE	Enables or disables replication rules.
VALIDATE REPLICATION	Verifies replication for file spaces and data types.

## SET CLIENTACTDURATION (Set the duration period for the client action)

Use this command to specify the duration for the schedule that was defined with the DEFINE CLIENTACTION command. A client action defines a schedule that runs one time on a client.



The program deletes these event records whether or not the client has processed the schedule. However, the schedules are not deleted until after the first event records are deleted. The retention period for events defaults to 10 days at installation.

## Privilege class

---

To issue this command, you must have system privilege.

## Syntax

---

```
>>-SET CLIENTACTDuration--days-----<
```

## Parameters

---

days (Required)

Specifies the number of days during which the schedule for the client action is active. You can specify an integer from 0 to 999. The default is 5 days.

The number of days you specify determines how long the database retains the schedule before deletion. A value of 0 indicates that the schedule duration is indefinite, and the schedule and associations are not deleted from the database.

## Example: Set a 15-day duration period for the client action

---

To specify that the schedule for the client action be active for 15 days issue the following command.

```
set clientactduration 15
```

## Related commands

---

Table 1. Commands related to SET CLIENTACTDURATION

Command	Description
DEFINE CLIENTACTION	Defines a command to be performed at a client node.
QUERY STATUS	Displays the settings of server parameters, such as those selected by the SET commands.

## SET CONFIGMANAGER (Specify a configuration manager)

---

Use this command to specify whether a server is a configuration manager. On a configuration manager, you can define configuration profiles to which other servers can subscribe.

You cannot designate a server as a configuration manager if the server subscribes to one or more profiles on another configuration manager.

If a server is a configuration manager, you cannot change this designation until you delete all profiles, including the default profile.

Issue the QUERY STATUS command to determine if a server is a configuration manager. When a server is installed, it is not designated as a configuration manager.

## Privilege class

---

To issue this command, you must have system privilege.

## Syntax

---

```
>>-Set CONFIGManager--+-OFF-+-----<
                        '-ON--'
```

## Parameters

---

ON

Specifies that the server is a configuration manager.

When you designate a server as a configuration manager, IBM Spectrum Protect™ creates a default profile named DEFAULT\_PROFILE and associates with the profile all servers and server groups defined on the configuration manager. You can modify or delete the default profile.

OFF

Specifies that the server is not a configuration manager.

## Example: Specify a configuration manager

---

Designate a server as a configuration manager.

```
set configmanager on
```

## Related commands

---

Table 1. Commands related to SET CONFIGMANAGER

Command	Description
DEFINE PROFILE	Defines a profile for distributing information to managed servers.
QUERY STATUS	Displays the settings of server parameters, such as those selected by the SET commands.
SET CONFIGREFRESH	Specifies a time interval for managed servers to contact configuration managers.

## SET CONFIGREFRESH (Set managed server configuration refresh)

---

Use this command on a managed server to specify how often that server contacts its configuration manager for updated configuration information.

To display the current setting, issue the QUERY STATUS command. At installation, the interval is set to 60 minutes.

## Privilege class

---

To issue this command, you must have system privilege.

## Syntax

---

```
>>-Set CONFIGRefresh--minutes-----><
```

## Parameters

---

minutes (Required)

Specifies the interval, in minutes, before a managed server contacts its configuration manager for configuration updates. Specify an integer from 0 to 10000.

- If the value is greater than 0, the managed server immediately contacts the configuration manager. The next contact occurs when the specified interval is reached.
- If the value is 0, the managed server does not contact the configuration manager.

This value is ignored if the server does not subscribe to at least one profile on a configuration manager.

## Example: Set a 45-minute refresh interval

---

Specify that a managed server contacts its configuration manager every 45 minutes.

```
set configrefresh 45
```

## Related commands

Table 1. Commands related to SET CONFIGREFRESH

Command	Description
DEFINE PROFASSOCIATION	Associates objects with a profile.
DEFINE PROFILE	Defines a profile for distributing information to managed servers.
DELETE PROFASSOCIATION	Deletes the association of an object with a profile.
NOTIFY SUBSCRIBERS	Notifies servers to refresh their configuration information.
SET CONFIGMANAGER	Specifies whether a server is a configuration manager.
UPDATE PROFILE	Changes the description of a profile.

## SET CONTEXTMESSAGING (Set message context reporting on or off)

Use this command to get additional information when ANR9999D messages occur. IBM Spectrum Protect™ polls the server components for information that includes process name, thread name, session ID, transaction data, locks that are held, and database tables that are in use.

Note: When consecutive messages are issued from the same code area by the same thread, only the first of these messages will report the context information.

## Privilege class

To issue this command, you must have system privilege.

## Syntax

```
>>-Set CONTEXTmessaging--+-ON--+-----<<  
      '-OFF-'
```

## Parameters

- ON  
Specifies to enable message context reporting.
- OFF  
Specifies to disable message context reporting.

## Example: Set message context reporting on or off

Turn on context messaging to receive additional information that could help determine the cause of ANR9999D messages.

```
set contextmessaging on
```

## Related commands

Table 1. Commands related to SET CONTEXTMESSAGING

Command	Description
QUERY STATUS	Displays the settings of server parameters, such as those selected by the SET commands.

## SET CPUINFOREFRESH (Refresh interval for the client workstation information scan)

---

Use this command to specify the number of days between client scans of workstation information that is used to estimate the processor value unit (PVU).

### Privilege class

---

To issue this command, you must have system privilege.

### Syntax

---

```
>>-Set CPUINFOREFRESH--days-----<<
```

### Parameters

---

days (Required)

Specifies the number of days between scans for client devices. To retrieve the current setting, issue the QUERY STATUS command. The possible values are 1 - 9999. The default is 180.

### Example: Set the amount of time before the next refresh to 90 days

---

```
SET CPUINFOREFRESH 90
```

### Related commands

---

Table 1. Commands related to SET CPUINFOREFRESH

Command	Description
QUERY PVUESTIMATE	Displays an estimate of the client-devices and server-devices being managed.

## SET CROSSDEFINE (Specifies whether to cross-define servers)

---

Use this command to specify whether a server is automatically defined to another server.

### Privilege class

---

To issue this command, you must have system privilege.

### Syntax

---

```
>>-Set CROSSDefine--ON-------<<  
      '-OFF-'
```

### Parameters

---

ON

Specifies that a server may be cross-defined to another server. To automatically define one server to another, you must also permit cross defining in the server definition.

OFF

Specifies that a server may not be cross-defined to another server.

### Example: Specifies whether to cross-define servers

---

Set cross define on to allow a server to be cross-defined to another server.

set crossdefine on

## Related commands

Table 1. Command related to SET CROSSDEFINE

Command	Description
DEFINE SERVER	Defines a server for server-to-server communications.
SET SERVERHLADDRESS	Specifies the high-level address of a server.
SET SERVERLLADDRESS	Specifies the low-level address of a server.
SET SERVERPASSWORD	Specifies the server password.

## SET DBRECOVERY (Set the device class for automatic backups)

Use this command to specify the device class and number of data streams to be used for automatic database backups. You can also use this command to configure the BACKUP DB command to automatically back up the master encryption key for the server.

The master encryption key is used to encrypt data in directory-container and cloud-container storage pools, and to encrypt sensitive information in the server database. If you do not back up the master encryption key, you might not be able to access any of these encrypted items if a disaster occurs.

If you run the BACKUP DB command, and the device class is not the one that is specified in the SET DBRECOVERY command, a warning message is returned. However, the backup operation continues and is not affected.

### Privilege class

To issue this command, you must have system or unrestricted storage privilege.

### Syntax

```
>>-SET DBRECOVery--device_class_name----->
. -NUMStreams----1----- . -COMPRESS----No-----
>--+-----+-----+-----+----->
' -NUMStreams----number-' ' -COMPRESS----+No--+-'
                                     '-Yes-'

. -PROTECTKeys----Yes-----
>--+-----+-----+-----+----->
' -PROTECTKeys----+No--+-'
                                     '-Yes-'

>--+-----+-----+-----+----->>
' -PASSWORD----password_name-'
```

### Parameters

#### device\_class\_name (Required)

Specifies the device class to use for database backups.

#### NUMStreams

Specifies the number of parallel data movement streams to use when you back up the database. The default value is 1, and the maximum number is 32. Increasing this value causes a corresponding increase in the number of database backup sessions to be used and in the number of drives to be used for the device class. A NUMSTREAMS value that is specified in the BACKUP DB command overrides any value set in the SET DBRECOVERY command. The NUMSTREAMS value is used for all types of database backups.

If a value is specified that is greater than the number of drives available for the device class, the number of available drives are used. The available drives are defined to the device class by the MOUNTLIMIT parameter or by the number of online drives for the specified device class. The session is displayed in the QUERY SESSION output.

If you increase the number of streams, more volumes are used from the corresponding device class for this operation.

Using more volumes might improve the speed of the database backups, but at the cost of more volumes that are not fully

used.

#### COMPRESS

Specifies whether volumes are compressed during database backup processing. This parameter is optional. The default value is No. You can specify one of the following values:

No

Specifies that the volumes that are created by the BACKUP DB command are not compressed.

Yes

Specifies that the volumes that are created by the BACKUP DB command are compressed.

If you specify the COMPRESS parameter on the BACKUP DB command, it overrides any value that is set in the SET DBRECOVERY command. Otherwise, the value that is set in the SET DBRECOVERY command is used.

Restrictions:

- Use caution when you specify the COMPRESS parameter. Using compression during database backups can reduce the size of the backup files. However, compression can increase the time to complete database backup processing.
- Do not back up compressed data to tape. If your system environment stores database backups on tape, set the COMPRESS parameter to No in the SET DBRECOVERY and BACKUP DB commands.

#### PROTECTKeys

Specifies that database backups include a copy of the master encryption key for the server that is used to encrypt storage pool data. This parameter is optional. The default value is Yes. You can specify one of the following values:

No

Specifies that database backups do not include a copy of the master encryption key for the server.

Attention: If you specify PROTECTKEYS=NO, you must manually back up the master encryption key for the server and make the key available when you implement disaster recovery.

Yes

Specifies that database backups include a copy of the master encryption key for the server.

Attention: If you specify PROTECTKEYS=YES, you must also specify the PASSWORD parameter.

#### PASSword

Specifies the password that is used to protect the database backups. The default is to protect database backups.

Important: Ensure that you remember this password. If you specify a password for database backup, you must specify the same password on the RESTORE DB command to restore the database.

## Example: Specify a device class for database backups

Specify the DBBACK device class for database backups. Run the following command:

```
set dbrecovery ddback
```

## Example: Specify a device class and number of streams for database backups

Specify the DBBACK device class for database backups, and specify that the backup is to use two data movement streams. Run the following command:

```
set dbrecovery ddback numstreams=2
```

AIX

Linux

Windows

## Example: Protect storage pool encryption keys in database backups

Encrypt storage pool data by specifying that database backups include a copy of the master encryption key for the server. Run the following command:

```
set dbrecovery ddback protectkeys=yes password=password_name
```

## Related commands

Table 1. Commands related to SET DBRECOVERY

Command	Description
---------	-------------

Command	Description
BACKUP DB	Backs up the IBM Spectrum Protect database to sequential access volumes.
QUERY DB	Displays allocation information about the database.
QUERY DBSPACE	Displays information about the storage space defined for the database.

## SET DEDUPVERIFICATIONLEVEL (Set the percentage of extents to verify)

Use this command to verify extents sent to the server during client-side data deduplication.

A rogue application that resides on a client system and that imitates the client, API, or GUI application can initiate an attack on the server. To reduce server vulnerability to such attacks, you can specify a percentage of client extents for the server to verify.

If the server detects that a security attack is in progress, the current session is canceled. In addition, the setting of the DEDUPLICATION parameter on the REGISTER NODE command is changed. The setting is changed from CLIENTORSERVER to SERVERONLY. The SERVERONLY setting disables client-side data deduplication for that node.

The server also issues a message that a potential security attack was detected and that client-side data deduplication was disabled for the node. If client-side data deduplication is disabled, all other client operations (for example, backup operations) continue. Only client-side data deduplication is disabled. If client-side data deduplication is disabled for a node because a potential attack was detected, the server deduplicates the data that is eligible for client-side data deduplication.

### Privilege class

To issue this command, you must have system privilege.

### Syntax

```
>>-Set DEDUPVERificationlevel-.-0-----+.----->>
'-percent_value-'
```

### Parameters

percent\_value (Required)

Specify an integer value 0 - 100 to indicate the percentage of client extents to be verified. A value of 0 indicates that no client extents are verified. The default for this command is 0.

Tips:

- Verifying extents consumes processing power and adversely affects server performance. For optimal performance, do not specify values greater than 10 for this command.
- To display the current value for SET DEDUPVERIFICATIONLEVEL, issue the QUERY STATUS command.

### Example: Specify a minimum level of data deduplication verification

To specify that 1% of extents created during client-side data deduplication are verified, issue the following command:

```
set dedupverificationlevel 1
```

### Example: Turn off data deduplication verification

To specify that none of the extents created during client-side data deduplication are verified, issue the following command:

```
set dedupverificationlevel 0
```

### Related commands

Table 1. Commands related to SET DEDUPVERIFICATIONLEVEL

Command	Description
DEFINE STGPOOL	Defines a storage pool as a named collection of server storage media.
QUERY CONTENT	Displays information about files in a storage pool volume.
QUERY STATUS	Displays the settings of server parameters, such as those selected by the SET commands.
REGISTER NODE	Defines a client node to the server and sets options for that user.
UPDATE NODE	Changes the attributes that are associated with a client node.
UPDATE STGPOOL	Changes the attributes of a storage pool.

## SET DEFAULTAUTHENTICATION (Set the default authentication method for REGISTER NODE and REGISTER ADMIN commands)

Use this command to set the default password authentication method for nodes and administrators that are the result of REGISTER NODE or REGISTER ADMIN commands.

If you specify LDAP, you establish the default value for authenticating to an external directory for any new REGISTER NODE or REGISTER ADMIN commands. This command makes it easier to register nodes or administrators when you use an LDAP directory server.

Tip: The default authentication setting can be overwritten when the authentication method is specified in a REGISTER NODE or REGISTER ADMIN command.

### Privilege class

To issue this command you must have system privilege.

### Syntax

```
>>-SET DEFAULTAUTHentication---Local+----->>
      '-LDap--'
```

### Parameters

#### LOcal

Specifies that any future REGISTER NODE or REGISTER ADMIN commands that you issue use LOCAL as the default authentication parameter value. Locally-authenticated passwords are those stored on the IBM Spectrum Protect™ server. The passwords authenticated locally are not case sensitive.

#### LDap

Specifies that any future REGISTER NODE or REGISTER ADMIN commands that you issue use LDAP as the default authentication parameter value. LDAP-authenticated passwords are those stored on an LDAP directory server and are case sensitive.

### Example: Set the default password authentication value to LDAP

Specify that any REGISTER NODE or REGISTER ADMIN commands that you issue authenticate passwords with an LDAP directory server.

```
set defaultauthentication ldap
```

### Related commands

Table 1. Commands related to SET DEFAULTAUTHENTICATION

Command	Description
---------	-------------



Command	Description
SET LDAPPASSWORD	Sets the password for the LDAPUSER.
SET LDAPUSER	Sets the user who oversees the passwords and administrators on the LDAP directory server.
SET LDAPUSER	Sets the user who oversees the passwords and administrators on the LDAP directory server.
REGISTER ADMIN	Defines a new administrator without granting administrative authority.
REGISTER NODE	Defines a client node to the server and sets options for that user.

## SET DISSIMILARPOLICIES (Enable the policies on the target replication server to manage replicated data)

Use the SET DISSIMILARPOLICIES command to enable the policies that are defined on the target replication server to manage replicated client-node data. If you do not use the policies on the target replication server, replicated client-node data is managed by policies on the source replication server.

Ensure that IBM Spectrum Protect™, Version 7.1.1 or later, is installed on the source and target replication servers before you issue this command. Issue this command on the source replication server.

Before you use the policies that are defined on a target replication server, you must issue the VALIDATE REPLPOLICY command for that target replication server. This command displays the differences between the policies for the client nodes on the source replication server and policies on the target replication server. You can modify the policies on the target replication server before you enable these policies to manage replicated client-node data.

To obtain the name of the target replication server for which you want to manage data and to check whether the policies on the target replication server are set to ON, use the QUERY REPLSERVER command. At installation, the value is set to OFF.

### Privilege class

To issue this command, you must have system privilege.

### Syntax

```
>>-Set DISSIMILARPolicies--target_server_name-----<<
                                     .-OFF-.
                                     +-OFF-+
                                     '-ON--'
```

### Parameters

target\_server\_name (Required)

Specifies the name of the target replication server for which you want to enable the policies.

ON

Specifies that replicated client-node data is managed by the policies that are defined on the target replication server.

OFF

Specifies that replicated client-node data is managed by the policies that are defined on the source replication server. Off is the default value.

### Example: Use the policies on a target replication server

To managed replicated client-node data from the target replication server, CVTCVS\_LXS\_SRV2, issue the following command on the source replication server:

```
set dissimilarpolicies CVTCVS_LXS_SRV2 on
```

## Related commands

Table 1. Commands related to SET DISSIMILARPOLICIES

Command	Description
QUERY REPLSERVER	Displays information about replicating servers.
VALIDATE REPLPOLICY	Verifies the policies on the target replication server.

## SET DRMACTIVEDATASTGPOOL (Specify the active-data pools to be managed by DRM)

Use this command to specify names of the active-data pools to be recovered after a disaster. IBM Spectrum Protect™ uses these names if the PREPARE , MOVE DRMEDIA, or QUERY DRMEDIA command does not include the ACTIVEDATASTGPOOL parameter.

By default, volumes in active-data pools are not eligible for processing by disaster recovery manager. To process active-data pool volumes, you must issue the SET DRMACTIVEDATASTGPOOL command, or you must use the ACTIVEDATASTGPOOL command-line parameter on the MOVE DRMEDIA, QUERY DRMEDIA, or PREPARE command.

Use the QUERY DRMSTATUS command to display the current settings.

### Privilege class

To issue this command, you must have system privilege.

### Syntax

```
          .-.,-----  
          v |  
>>-Set DRMACTIVEDatastgpool----active-data_pool_name+-----><
```

### Parameters

active-data\_pool\_name (Required)

Specifies the active-data pool names. Separate multiple names with commas with no intervening spaces. You can use wildcard characters. The specified names will overwrite any previous settings. If you enter a null string (""), all current names are removed, and no active-data pool volumes in MOUNTABLE state are processed if they were not explicitly entered as MOVE DRMEDIA , QUERY DRMEDIA, or PREPARE command parameters.

### Example: Set an eligible active-data pool

Set ACTIVEPOOL1 as the eligible active-data pool.

```
set drmactivedatapool activedatastgpool1
```

## Related commands

Table 1. Commands related to SET DRMACTIVEDATASTGPOOL

Command	Description
MOVE DRMEDIA	Moves DRM media onsite and offsite.
PREPARE	Creates a recovery plan file.
QUERY DRMEDIA	Displays information about disaster recovery volumes.
QUERY DRMSTATUS	Displays DRM system parameters.
SET DRMCOPYSTGPOOL	Specifies that copy storage pools are managed by DRM.
SET DRMPRIMSTGPOOL	Specifies that primary storage pools are managed by DRM.

## SET DRMCHECKLABEL (Specify label checking)

---

Use this command to specify whether IBM Spectrum Protect™ reads the labels of sequential media checked out by the MOVE DRMEDIA command. At installation, the value of the DRMCHECKLABEL is set to YES.

Use the QUERY DRMSTATUS command to check the current setting.

**AIX** | **Linux** This command does not apply to 349X device types.

### Privilege class

---

To issue this command, you must have system privilege.

### Syntax

---

```
>>-Set DRMCHECKLabel--+-Yes-+-----><
+-Yes-+
'-No--'
```

### Parameters

---

Yes

Specifies that IBM Spectrum Protect reads the labels of sequential media checked out by the MOVE DRMEDIA command.

No

Specifies that IBM Spectrum Protect does not read the labels of sequential media checked out by the MOVE DRMEDIA command.

### Example: Specify no label checking

---

Specify that no label checking is completed.

```
set drmchecklabel no
```

### Related commands

---

Table 1. Commands related to SET DRMCHECKLABEL

Command	Description
MOVE DRMEDIA	Moves DRM media onsite and offsite.
QUERY DRMSTATUS	Displays DRM system parameters.

## SET DRMCMDFILENAME (Specify the name of a file to contain commands)

---

Use this command to name a file that can contain the commands created when the MOVE DRMEDIA or QUERY DRMEDIA commands are issued. If the SET DRMCMDFILENAME is not issued, the MOVE DRMEDIA or QUERY DRMEDIA command generates a file name.

Use the QUERY DRMSTATUS command to display the current command file name.

### Privilege class

---

To issue this command, you must have system privilege.

### Syntax

---

```
>>-Set DRMCMDFilename--file_name-----><
```

## Parameters

file\_name (Required)

**AIX** | **Linux** Specifies a full path name for a file to contain the commands created by the MOVE DRMEDIA or QUERY DRMEDIA command.

**Windows** Specifies a full path name for a file to contain the commands created by the MOVE DRMEDIA or QUERY DRMEDIA command. The file name can be up to 259 characters.

Attention: If a file of the same name already exists, MOVE DRMEDIA or QUERY DRMEDIA command tries to use it, and the existing data is overwritten.

## Example: Specify a file name to contain DRMEDIA commands

**AIX** | **Linux** Specify a file name of /adsm/drm/orm/exec.cmds.

```
set drmcmdfilename /adsm/drm/orm/exec.cmds
```

**Windows** Specify a file name of c:\drm\orm\exec.cmd.

```
set drmcmdfilename c:\drm\orm\exec.cmd
```

## Related commands

Table 1. Commands related to SET DRMCMDFILENAME

Command	Description
MOVE DRMEDIA	Moves DRM media onsite and offsite.
QUERY DRMEDIA	Displays information about disaster recovery volumes.
QUERY DRMSTATUS	Displays DRM system parameters.

**AIX** | **Linux** | **Windows**

## SET DRMCOPYCONTAINERSTGPOOL (Specify the container-copy storage pools to be processed by DRM commands)

Use this command to specify the container-copy storage pools to be processed by the MOVE DRMEDIA or QUERY DRMEDIA command when that command does not include the COPYCONTAINERSTGPOOL parameter.

By default, volumes in container-copy storage pools are not processed by the MOVE DRMEDIA and QUERY DRMEDIA commands. To process the volumes, you must issue the SET DRMCOPYCONTAINERSTGPOOL command, or you must use the COPYCONTAINERSTGPOOL parameter on the MOVE DRMEDIA or QUERY DRMEDIA command.

Tip: To display the current settings, use the QUERY DRMSTATUS command.

## Privilege class

To issue this command, you must have system privilege.

## Syntax

```
>>-Set DRMCOPYCONTAINERstgpool---pool_name+-----><
```

## Parameters

pool\_name (Required)

Specifies the names of the container-copy storage pools. Separate multiple names with commas and no intervening spaces. You can use wildcard characters. The specified names replace any previous setting. If you enter a null string (""), all current names are removed.

## Example: Specify storage pools to be processed by the MOVE DRMEDIA and QUERY DRMEDIA commands

---

Set CONTCOPY1 and CONTCOPY2 as the container-copy storage pools to be processed.

```
set drmcopystgpool contcopy1,contcopy2
```

## Related commands

---

Table 1. Commands related to SET DRMCOPYCONTAINERSTGPOOL

Command	Description
MOVE DRMEDIA	Moves DRM media onsite and offsite.
QUERY DRMEDIA	Displays information about disaster recovery volumes.
QUERY DRMSTATUS	Displays DRM system parameters.

## SET DRMCOPYSTGPOOL (Specify the copy storage pools to be managed by DRM)

---

Use this command to specify names of the copy storage pools to be recovered after a disaster. IBM Spectrum Protect™ uses these names if the PREPARE command does not include the COPYSTGPOOL parameter.

If the MOVE DRMEDIA or QUERY DRMEDIA command does not include the COPYSTGPOOL parameter, the command processes the volumes in the MOUNTABLE state that are in the copy storage pool named by the SET DRMCOPYSTGPOOL command. At installation, all copy storage pools are eligible for DRM processing.

Use the QUERY DRMSTATUS command to display the current settings.

## Privilege class

---

To issue this command, you must have system privilege.

## Syntax

---

```
set drmcopystgpool copy_pool_name
```

## Parameters

---

copy\_pool\_name (Required)

Specifies the copy storage pool names. Separate multiple names with commas and no intervening spaces. You can use wildcard characters. The specified names replace any previous setting. If you enter a null string (""), all current names are removed, and all copy storage pools are eligible for processing.

## Example: Set an eligible copy storage pool

---

Set COPYSTGPOOL1 as the eligible copy storage pool.

```
set drmcopystgpool copystgpool1
```

## Related commands

---

Table 1. Commands related to SET DRMCOPYSTGPOOL

Command	Description
MOVE DRMEDIA	Moves DRM media onsite and offsite.
PREPARE	Creates a recovery plan file.
QUERY DRMEDIA	Displays information about disaster recovery volumes.
QUERY DRMSTATUS	Displays DRM system parameters.
SET DRMPRIMSTGPOOL	Specifies that primary storage pools are managed by DRM.

## SET DRMCOURIERNAME (Specify the courier name)

Use this command to specify the courier name. At installation, this name is set to COURIER. The MOVE DRMEDIA command uses the courier name to set the location of volumes that are moving to the COURIER state.

You can use the QUERY DRMSTATUS to see the name of the courier.

### Privilege class

To issue this command, you must have system privilege.

### Syntax

```
>>-Set DRMCOURiername--courier_name-----><
```

### Parameters

*courier\_name* (Required)

Specifies the name of the courier. The name can be up to 255 characters. Enclose the name in quotation marks if it contains any blank characters.

### Example: Set the courier name

Set the name of the courier to Joe's Courier Service.

```
set drmcouriername "Joe's Courier Service"
```

### Related commands

Table 1. Commands related to SET DRMCOURIERNAME

Command	Description
MOVE DRMEDIA	Moves DRM media onsite and offsite.
QUERY DRMEDIA	Displays information about disaster recovery volumes.
QUERY DRMSTATUS	Displays DRM system parameters.

## SET DRMDBBACKUPEXPIREDAYS (Specify DB backup series expiration)

Use this command to specify when a database backup series is eligible to be expired.

The value set by this command applies to both a snapshot and a full plus incremental database backup series. Any type of database backup series is eligible for expiration if all of the following are true:

- The age of the last volume of the series exceeds the expiration value set with the SET DRMDBBACKUPEXPIREDAYS command and the value that is specified for the DELgraceperiod parameter in the DEFINE SERVER command. The DELgraceperiod parameter applies only to remote database backups. The default value for the DELgraceperiod parameter

is 5 days. For example, if you set the value for the SET DRMDBBACKUPEXPIREDDAYS command to 7 days and set the value for the DELgraceperiod parameter to 6 days, the remote database backup series does not expire until 13 days elapse.

- For volumes that are not virtual volumes, all volumes in the series are in the VAULT state.
- The volume is not part of the most recent database backup series.

Remember: The most recent backup series of either type is not deleted.

See the MOVE DRMEDIA command for more information on the expiration of database backup volumes that are not virtual volumes. See the EXPIRE INVENTORY command for more information on expiration of database backup volumes that are virtual volumes.

Use the QUERY DRMSTATUS to see the number of days specified.

## Privilege class

---

To issue this command, you must have system privilege.

## Syntax

---

```
>>-Set DRMDBBackupexpiredays--days-----<<
```

## Parameters

---

days (Required)

Specifies the number of days that must elapse since a database series was created before it is eligible to be expired. The number of days must match the volume reuse delay period for copy storage pools that are managed by disaster recovery manager. Specify an integer value 0 - 9999.

## Example: Set the database backup series expiration

---

Set the database backup series expiration value to 60.

```
set drmdbbackupexpiredays 60
```

## Related commands

---

Table 1. Commands related to SET DRMDBBACKUPEXPIREDDAYS

Command	Description
DSMSERV RESTORE DB	Restores an IBM Spectrum ProtectIBM Spectrum Protect™ database.
MOVE DRMEDIA	Moves DRM media onsite and offsite.
QUERY DRMEDIA	Displays information about disaster recovery volumes.
QUERY DRMSTATUS	Displays DRM system parameters.
QUERY VOLHISTORY	Displays sequential volume history information that has been collected by the server.
DEFINE SERVER	Defines a server for server-to-server communications.

## SET DRMFILEPROCESS (Specify file processing)

---

Use this command to specify if the MOVE DRMEDIA or QUERY DRMEDIA command should process database backup volumes and copy storage pool volumes that are associated with a FILE device class. At installation, the value is set to NO. Use the QUERY DRMSTATUS to determine the current setting.

## Privilege class

---

To issue this command, you must have system privilege.

## Syntax

```
>>-Set DRMFILEProcess--+-No--+.-----><
                        +-No--+
                        '-Yes-'
```

## Parameters

No

Specifies that the MOVE DRMEDIA and QUERY DRMEDIA commands does not process database backup and copy storage pool volumes that are associated with a FILE device class. This is the default.

Yes

Specifies that the MOVE DRMEDIA and QUERY DRMEDIA commands process database backup and copy storage pool volumes that are associated with a FILE device class.

## Example: Specify that the DRMEDIA commands do not include FILE type device classes

Set the file processing value to no.

```
set drmfileprocess no
```

## Related commands

Table 1. Commands related to SET DRMFILEPROCESS

Command	Description
MOVE DRMEDIA	Moves DRM media onsite and offsite.
QUERY DRMEDIA	Displays information about disaster recovery volumes.
QUERY DRMSTATUS	Displays DRM system parameters.

## SET DRMINSTRPREFIX (Specify the prefix for recovery instructions file names)

Use this command to specify a prefix to the recovery instructions file name. If you issue this command, IBM Spectrum Protect™ uses the specified prefix if the PREPARE command is issued without the INSTRPREFIX parameter.

Use the QUERY DRMSTATUS command to display the current value for the prefix.

**AIX** | **Linux** the prefix is the current IBM Spectrum Protect server working directory.

**Windows** If no prefix is set, the prefix is set to the directory representing this instance of the server, which is typically the directory that the server was originally installed from.

## Privilege class

To issue this command, you must have system privilege.

## Syntax

```
>>-Set DRMINSTRPrefix--prefix-----><
```

## Parameters

**AIX** | **Linux** prefix (Required)  
**AIX** | **Linux**



Specifies a path name prefix for the files that contain the recovery instructions. When processing the PREPARE command, IBM Spectrum Protect appends the name of the appropriate recovery plan file stanza to find the file. The maximum length is 250 characters.

The prefix can be one of the following:

- **Directory path:** End the prefix with a forward slash (/). For example:

```
/admsrv/recinstr/
```

For the RECOVERY.INSTRUCTIONS.GENERAL file, the resulting file name would be:

```
/admsrv/recinstr/RECOVERY.INSTRUCTIONS.GENERAL
```

- **Directory path followed by a string:** IBM Spectrum Protect treats the string as part of the file name. For example:

```
/admsrv/recinstr/accounts
```

For the RECOVERY.INSTRUCTIONS.GENERAL file, the resulting file name would be:

```
/admsrv/recinstr/accounts.RECOVERY.INSTRUCTIONS.GENERAL
```

- **String only:** IBM Spectrum Protect specifies the directory path and appends the appropriate recovery plan file stanza name.
  - IBM Spectrum Protect uses the name of the current working directory. For example, the current working directory is `/opt/tivoli/tsm/server/bin`. You specify the following:

```
shipping
```

For the RECOVERY.INSTRUCTIONS.GENERAL file, the resulting file name would look like this:

```
/opt/tivoli/tsm/server/bin/shipping.RECOVERY.INSTRUCTIONS.GENERAL
```

**Windows** prefix (Required)

**Windows**

Specifies a path name prefix for the files that contain the recovery instructions. When processing the PREPARE command, IBM Spectrum Protect appends the name of the appropriate recovery plan file stanza to find the file. The maximum length is 200 characters.

The prefix can be one of the following:

- **Directory path:** End the prefix with a back slash (\). For example:

```
c:\admsrv\recinstr\
```

For the RECOVERY.INSTRUCTIONS.GENERAL file, the resulting file name would be:

```
c:\admsrv\recinstr\RECOVERY.INSTRUCTIONS.GENERAL
```

- **Directory path followed by a string:** IBM Spectrum Protect treats the string as part of the file name. For example:

```
c:\admsrv\recinstr\accounts
```

For the RECOVERY.INSTRUCTIONS.GENERAL file, the resulting file name would be:

```
c:\admsrv\recinstr\accounts.RECOVERY.INSTRUCTIONS.GENERAL
```

- **String only:** IBM Spectrum Protect specifies the directory path and appends the appropriate recovery plan file stanza name. The directory path is the directory representing this instance of the IBM Spectrum Protect server (typically the original IBM Spectrum Protect server installation directory). For example, the directory representing this instance of the server is `c:\Program Files\Tivoli\TSM;\server2`, and you specify the following prefix:

```
shipping
```

The resulting recovery plan file name is:

```
c:\Program Files\Tivoli\TSM;\server2\shipping.19971115.051421
```

## Example: Specify the recovery plan prefix

AIX

Linux

Specify reading the recovery plan instructions from directory /drmpln/primerv.

```
set drminstrprefix /drmpln/primerv/
```

Windows

Specify reading the recovery plan instructions from directory c:\win32app\ibm\adsm\server2\.

```
set drminstrprefix c:\win32app\ibm\adsm\server2\
```

## Related commands

Table 1. Commands related to SET DRMINSTRPREFIX

Command	Description
PREPARE	Creates a recovery plan file.
QUERY DRMSTATUS	Displays DRM system parameters.

## SET DRMNOTMOUNTABLENAME (Specify the not mountable location name)

Use this command to specify the name of the onsite location for storing the media. At installation, the name is set to NOTMOUNTABLE. Use the QUERY DRMSTATUS command to see the location name.

The location name is used by the MOVE DRMEDIA command to set the location of volumes that are moving to the NOTMOUNTABLE state.

### Privilege class

To issue this command, you must have system privilege.

### Syntax

```
>>-Set DRMNOTMOuntablename--location-----><
```

### Parameters

location (Required)

Specifies the name of the onsite location for storing the media. The name can be up to 255 characters. Enclose the name in quotation marks if it contains any blank characters.

### Example: Specify the name of the onsite location

Set the name of the location to room 123/31.

```
set drmnotmountablename "room 123/31"
```

## Related commands

Table 1. Commands related to SET DRMNOTMOUNTABLENAME

Command	Description
MOVE DRMEDIA	Moves DRM media onsite and offsite.
QUERY DRMEDIA	Displays information about disaster recovery volumes.
QUERY DRMSTATUS	Displays DRM system parameters.

## SET DRMPLANPREFIX (Specify a prefix for recovery plan file names)

Use this command to specify a prefix for a recovery plan file name.

If you issue this command, IBM Spectrum Protect™ uses the specified prefix if the PREPARE command does not include the PLANPREFIX parameter.

Use the QUERY DRMSTATUS command to display the current value for the recovery plan prefix.

## Privilege class

---

To issue this command, you must have system privilege.

## Syntax

---

```
>>-Set DRMPLANPrefix--prefix-----<<
```

## Parameters

---

**AIX** | **Linux** prefix (Required)

**AIX** | **Linux** Specifies the prefix for a recovery plan file name. The maximum length of the prefix is 250 characters. If you enter a null string (""), the current prefix is removed, and the server uses the algorithm described in the PLANPREFIX parameter in the PREPARE command.

For the prefix, you can specify:

- **A directory path followed by a forward slash (/):** IBM Spectrum Protect appends to the prefix the date and time in the `yyyymmdd.hhmmss` format. For example, the SET DRMPLANPREFIX is set to the following:

```
/admsrv/recplans/
```

The resulting recovery plan file name is:

```
/admsrv/recplans/19971115.051421
```

- **A directory path followed by a string:** IBM Spectrum Protect uses the string as part of the file name. IBM Spectrum Protect appends to the prefix the date and time in the `.yyyymmdd.hhmmss` format (note the initial period). For example, the SET DRMPLANPREFIX is set to the following:

```
/admsrv/recplans/accounting
```

The resulting recovery plan filename is:

```
/admsrv/recplans/accounting.19971115.051421
```

- **A string that is not preceded by a directory path:** IBM Spectrum Protect appends to the prefix the date and time information in the `.yyyymmdd.hhmmss` format (note the initial period). IBM Spectrum Protect determines the directory path as follows:

- IBM Spectrum Protect uses the directory path name of the current working directory of the IBM Spectrum Protect server. For example, the current IBM Spectrum Protect working directory is `/opt/tivoli/tsm/server/bin`The SET DRMPLANPREFIX command is set to the following:

```
shipping
```

The resulting recovery plan file name is:

```
/opt/tivoli/tsm/server/bin/shipping.19971115.051421
```

**Windows** prefix (Required)

**Windows** Specifies a prefix for the path name used to generate the recovery plan file name. The prefix can be up to 200 characters. IBM Spectrum Protect uses the prefix if the PREPARE command is issued without the PLANPREFIX parameter. IBM Spectrum Protect builds a unique recovery plan file name by appending to the prefix the date and time format: `yyyymmdd.hhmmss` (for example, `19951115.051421`). If you enter a null string (""), the current prefix is removed, and the server uses the algorithm described in the PLANPREFIX parameter in the PREPARE command.

For the prefix, you can specify:

1. A directory path
2. A directory path followed by a string
3. A string

The following describes the rules for possible prefix specifications:

1. To specify a directory path for the prefix, end the prefix with a back slash (\). IBM Spectrum Protect appends to the prefix the date and time information using the `yyyymmdd.hhmmss` format. For example the SET DRMPLANPREFIX is set to the following:

```
c:\admsrv\recplans\
```

The resulting recovery plan file name is:

```
c:\admsrv\recplans\19951115.051421
```

**Important:** If you issue the SET DRMPLANPREFIX command from a command line client and the last character in the command line is a back slash, IBM Spectrum Protect interprets it as a continuation character. To avoid this, enclose the prefix in quotation marks. For example: `"c:\admsrv\recplans\"`

2. If the prefix is a directory path followed by a string, IBM Spectrum Protect uses the string as part of the file name. IBM Spectrum Protect appends to the prefix the date and time in the `.yyyymmdd.hhmmss` format (note the initial period). For example, the SET DRMPLANPREFIX is set to the following

```
c:\admsrv\recplans\accounting
```

The resulting recovery plan filename is the following:

```
c:\admsrv\recplans\accounting.19951115.051421
```

3. If the prefix is a string that is not preceded by a directory path, IBM Spectrum Protect appends to the prefix the date and time information in the `.yyyymmdd.hhmmss` format (note the initial period). The directory path that IBM Spectrum Protect uses is the directory path representing this instance of the IBM Spectrum Protect server (typically the directory that the IBM Spectrum Protect server was originally installed from). For example, the directory representing this instance of the server is `c:\Program Files\Tivoli\TSM;\server2`, and you set the prefix to:

```
shipping
```

The resulting recovery plan filename is:

```
c:\Program Files\Tivoli\TSM;\server2\shipping.19951115.051421
```

## Example: Specify a prefix for recovery plan file names

Specify a prefix so that the generated recovery plan files are stored in the following directory:

- **AIX** **Linux** /drmplan/primsrv
- **Windows** c:\drmtest\prepare\

Issue the command: **AIX** **Linux**

```
set drmplanprefix /drmplan/primsrv/
```

**Windows**

```
set drmplanprefix c:\drmtest\prepare\
```

## Related commands

Table 1. Commands related to SET DRMPLANPREFIX

Command	Description
PREPARE	Creates a recovery plan file.
QUERY DRMSTATUS	Displays DRM system parameters.

## SET DRMPLANVPOSTFIX (Specify replacement volume names)

Use this command to specify the character to be appended to replacement volume names in the recovery plan file. The character can help you find or generate replacement volume names when you use the recovery plan file.

At installation, the character is set to @. IBM Spectrum Protect™ generates replacement names for primary storage pool volumes that were added by the DEFINE VOLUME command. Use the appended character to:

- Find replacement volume names in the recovery plan stanzas so that you can change the names at recovery time. For example, you may not know the names of the available tape volumes at the recovery site.
- Generate replacement volume names. You need a naming convention that works for any device type in your primary storage pools. Consider the following:
  - The generated length of replacement volume name
  - Legal characters in the replacement volume name
  - Conflicts with existing volume names
  - A replacement volume name must be different from any destroyed, existing, or new volume name.

Use the QUERY DRMSTATUS command to see the character added to the end of the replacement volume names.

## Privilege class

---

To issue this command, you must have system privilege.

## Syntax

---

```
>>-Set DRMPLANVpostfix--character-----<<
```

## Parameters

---

character (Required)

Specifies the character appended to the replacement volume names in the recovery plan file. Specify an alphanumeric or special character.

**AIX** Attention: A special character can cause unpredictable results in the AIX® shell or command line environment.

**Windows** Attention: A special character can cause unpredictable results in the Windows batch/command line environment.

## Example: Specify the appended character for replacement volume names

---

Set the character appended to the replace volume names to R.

```
set drmplnvpostfix R
```

## Related commands

---

Table 1. Commands related to SET DRMPLANVPOSTFIX

Command	Description
PREPARE	Creates a recovery plan file.
QUERY DRMSTATUS	Displays DRM system parameters.

## SET DRMPRIMSTGPOOL (Specify the primary storage pools to be managed by DRM)

---

Use this command to specify the names of primary storage pools that you want to recover. If the PREPARE command does not include the PRIMSTGPOOL parameter, DRM processes the names specified in this command.

Use the QUERY DRMSTATUS command to display the current settings. At installation, all primary storage pools defined to the server are eligible for DRM processing.

## Privilege class

---

To issue this command, you must have system privilege.

## Syntax

---

```

      .-.-.-.-.-.
      |
      v
>>-Set DRMPRIMstgpool---primary_pool_name-+-----><

```

## Parameters

primary\_pool\_name (Required)

Specifies the names of the primary storage pool names you want to recover. Separate multiple names with commas and no intervening spaces. You can use wildcard characters to specify names. The names that you specify replace any previous setting. If you enter a null string (""), all current names are removed, and all primary storage pools are eligible for DRM processing.

## Example: Set a primary storage pool to be managed by DRM

Set the primary storage pool to be managed by DRM to PRIMSTGPOOL1.

```
set drmpriestgpool primstgpool1
```

## Related commands

Table 1. Commands related to SET DRMPRIMSTGPOOL

Command	Description
PREPARE	Creates a recovery plan file.
QUERY DRMSTATUS	Displays DRM system parameters.
SET DRMCOPYSTGPOOL	Specifies that copy storage pools are managed by DRM.

## SET DRMRPFEXPIREDAYS (Set criteria for recovery plan file expiration)

Use this command to specify when recovery plan files are eligible for expiration. This command and expiration processing apply only to recovery plan files that were created with the DEVCLASS parameter specified on the PREPARE command (that is, virtual volumes of type RPFIL and RPSNAPSHOT). Expiration processing on the source server expires plan files that are stored on the target server. Locally created recovery plan files are not expired.

An RPFIL file is associated with a full plus incremental database backup series. An RPFNSNAPSHOT file is associated with a database snapshot backup series.

Attention: The latest RPFIL and RPFNSNAPSHOT files are never deleted.

A recovery plan file is eligible for expiration if both of the following are true:

- The last recovery plan file of the series exceeds the expiration value that is specified with the SET DRMRPFEXPIREDAYS command and the value that is specified for the DELgraceperiod parameter in the DEFINE SERVER command. The default value for the DELgraceperiod parameter is 5 days. For example, if you set the value for the SET DRMRPFEXPIREDAYS command to 80 days and set the value for the DELgraceperiod parameter to 6 days, the recovery plan file does not expire until 86 days elapse.
- The latest recovery plan file is not associated with the most recent database backup series.

For more information about expiration processing, see the EXPIRE INVENTORY command.

## Privilege class

To issue this command, you must have system privilege.

## Syntax

```
>>-Set DRMRPFExpiredays--days-----><
```

## Parameters

days (Required)

Specifies the number of days that must elapse before a recovery plan file expires. You can specify a number 0 - 9999. At installation, this value is set to 60.

## Example: Set the recovery plan expiration

Set the recovery plan file expiration value to 30.

```
set drmrpfexpiredays 30
```

## Related commands

Table 1. Commands related to SET DRMRPFEXPIREDDAYS

Command	Description
PREPARE	Creates a recovery plan file.
QUERY DRMSTATUS	Displays DRM system parameters.
QUERY RPFCONTENT	Displays the contents of a recovery plan file.
QUERY RPFFILE	Displays information about recovery plan files.
QUERY VOLHISTORY	Displays sequential volume history information that has been collected by the server.
SET DRMDBBACKUPEXPIREDDAYS	Specifies criteria for database backup series expiration.
DEFINE SERVER	Defines a server for server-to-server communications.

## SET DRMVaultNAME (Specify the vault name)

Use this command to specify the vault name. At installation the name is set to VAULT. Use the QUERY DRMSTATUS command to see the name of the vault.

## Privilege class

To issue this command, you must have system privilege.

## Syntax

```
>>-SET DRMVaultname--vault_name-----<<
```

## Parameters

vault\_name (Required)

Specifies the name of the vault. The name can be up to 255 characters. Enclose the name in quotation marks if it contains any blank characters.

## Example: Specify a vault name

Specify `ironmountain` as the vault name.

```
set drmvaultname ironmountain
```

## Related commands

Table 1. Commands related to SET DRMVaultNAME

Command	Description
MOVE DRMEDIA	Moves DRM media onsite and offsite.
QUERY DRMEDIA	Displays information about disaster recovery volumes.

Command	Description
QUERY DRMSTATUS	Displays DRM system parameters.

## SET EVENTRETENTION (Set the retention period for event records)

Use this command to set the retention period for event records in the server database that will allow you to monitor completed schedules. An event record is created whenever processing of a scheduled command is started or missed.

You can adjust the length of time that the server maintains event information to avoid insufficient or outdated data. The server automatically removes the event records from the database after the retention period passes and the startup window for the event has elapsed.

You can issue the QUERY EVENT command to display information about scheduled and completed events.

You can issue the DELETE EVENT command to delete event records regardless of whether their retention period has passed.

You can issue the QUERY STATUS command to display the value for the event retention period. At installation, this value is set to 10 days.

### Privilege class

To issue this command, you must have system privilege.

### Syntax

```
>>-Set EVentretention--days-----><
```

### Parameters

days (Required)

The number of days that the database retains event records. You can specify an integer from 0 to 9999. A value of 0 indicates that only event records for the current day are retained.

### Example: Set the retention period for event records

Set the retention period to 15 days.

```
set eventretention 15
```

### Related commands

Table 1. Commands related to SET EVENTRETENTION

Command	Description
DELETE EVENT	Deletes event records before a specified date and time.
QUERY EVENT	Displays information about scheduled and completed events for selected clients.
QUERY STATUS	Displays the settings of server parameters, such as those selected by the SET commands.

## SET FAILOVERHLADDRESS (Set a failover high level address)

Use this command to specify the IP address that a client uses to connect to this server as the secondary replication server during failover, if the address is different from the IP address that is specified for the replication process.

You must specify the address of the server that is used if the high-level address (HLA) is different. This command is required only if you use separate dedicated networks for server-to-server communication and client access.



## Privilege class

---

To issue this command, you must have system privilege.

## Syntax

---

```
>>-SET FAILOVERHladdress--high_level_address-----<
```

## Parameters

---

high\_level\_address (Required)

Specifies a server HLA as a numeric dotted decimal name or a host name to use during failover. If you specify a host name, a server that can resolve the name to the dotted decimal format must be available.

To remove the failover IP address, issue the command without specifying a value.

## Example: Set a failover high-level address

---

The name of the HLA that you want to set for failover operations on this server.

```
set failoverhladdress server1
```

## Example: Remove a high-level address

---

To remove a high-level address for a failover server, issue the following command:

```
set failoverhladdress
```

## Related commands

---

Table 1. Commands related to QUERY REPLSERVER

Command	Description
QUERY REPLSERVER (Query a replication server)	Displays information about replicating servers.
REMOVE REPLSERVER (Remove a replication server)	Removes a server from replication.

## SET INVALIDPWLIMIT (Set the number of invalid logon attempts)

---

Use this command to set the number of invalid logon attempts that are allowed before a node is locked.

The SET INVALIDPWLIMIT command also applies to LDAP directory servers that store complex node passwords. LDAP directory servers can limit the number of invalid password attempts independent of the IBM Spectrum Protect™ server. You might not want to set up the LDAP directory server for invalid attempts for the IBM Spectrum Protect namespace if you use the SET INVALIDPWLIMIT command.

## Privilege class

---

To issue this command, you must have system privilege.

## Syntax

---

```
>>-Set--INVALIDPwlimit--number-----<
```

## Parameters

---

number (Required)

Specifies the number of invalid logon attempts allowed before a node is locked.

You can specify an integer from 0 to 9999. A value of 0 means that invalid logon attempts are not checked. A value of 1 means that if a user issues an invalid password one time, the node is locked by the server. The default is 0.

Important: If your password is authenticated with an LDAP directory server, it can be managed by the LDAP server and the IBM Spectrum Protect server. Not all IBM Spectrum Protect server commands affect passwords that authenticate with an LDAP server. For example, the SET PASSEXP and RESET PASSEXP commands do not affect passwords that authenticate with an LDAP directory server. You can manage your password features through the IBM Spectrum Protect server. If you issued the SET INVALIDPWLIMIT command, all IBM Spectrum Protect passwords are controlled by the limit that you set. If you configure the LDAP directory server to limit the number of invalid password attempts, a conflict might occur.

## Example: Define the number of allowed invalid login attempts

Set the number of invalid logon attempts allowed.

```
set invalidpwlimit 6
```

## Related commands

Table 1. Commands related to SET INVALIDPWLIMIT

Command	Description
QUERY ADMIN	Displays information about one or more IBM Spectrum Protect administrators.
QUERY NODE	Displays partial or complete information about one or more clients.
QUERY STATUS	Displays the settings of server parameters, such as those selected by the SET commands.
SET MINPWLENGTH	Sets the minimum length for client passwords.

## SET LDAPPASSWORD (Set the LDAP password for the server)

Use this command to define a password for the user or account ID that you specified by using the SET LDAPUSER command.

Requirement: You must define the LDAPURL option and issue the SET LDAPUSER command before you issue the SET LDAPPASSWORD command. If the LDAPURL option is not defined when you set the user password for the Lightweight Directory Access Protocol (LDAP) server, you must restart the IBM Spectrum Protect™ server after you define the LDAPURL option.

## Privilege class

To issue this command, you must have system privilege.

## Syntax

```
>>-Set LDAPPassword--ldap_user_password-----<<
```

## Parameters

ldap\_user\_password

Specifies the password that the IBM Spectrum Protect server uses when it authenticates to the LDAP server. The maximum length of the password is 64 characters. If you have equal signs within your password, you must contain the whole password within quotation marks. You can use the following characters:

```
a b c d e f g h i j k l m n o p q r s t u v w x y z
A B C D E F G H I J K L M N O P Q R S T U V W X Y Z
0 1 2 3 4 5 6 7 8 9 . ! @ # $ % ^ & * _ - + = ` ( )
| { } [ ] : ; < > , ? / ~
```

## Example: Set an LDAP password

```
set ldappassword LdAp20&12PaSsWoRd
```

## Example: Set an LDAP password that includes an equal sign

---

```
set ldappassword "LdAp=LastWoRd"
```

## Related commands

---

Table 1. Commands related to SET LDAPPASSWORD

Command	Description
AUDIT LDAPDIRECTORY	Audit an IBM Spectrum Protect-controlled namespace on an LDAP directory server.
SET DEFAULTAUTHENTICATION	Specifies the default password authentication method for any REGISTER NODE or REGISTER ADMIN commands.
SET LDAPUSER	Sets the user who oversees the passwords and administrators on the LDAP directory server.

## SET LDAPUSER (Specify an ID for an LDAP directory server)

---

Use this command to specify the ID of a user or account that can access a Lightweight Directory Access Protocol (LDAP) server.

The specified ID must have read access to the accounts on the LDAP server that are used for authentication. To modify LDAP IDs or reset passwords for LDAP IDs, the specified ID must have write authority for accounts on the LDAP server.

Tip: The information in this documentation applies to the LDAP authentication method that is preferred for IBM Spectrum Protect™ V7.1.7 or later servers. For instructions about using the previous LDAP authentication method, see Managing passwords and logon procedures.

## Privilege class

---

To issue this command, you must have system privilege.

## Syntax

---

```
>>-Set LDAPUser--ldap_user_dn-----<<
```

## Parameters

---

ldap\_user\_dn  
Specifies the ID of a user or account that can access an LDAP server.

## Example: Specify an administrative user ID for conducting operations on an LDAP server

---

To specify an administrator with a user ID of JACKSPRATT, who represents a US company that is named EXAMPLE, issue the following command:

```
set ldapuser JackSpratt@us.example.com
```

## Related commands

---

Table 1. Commands related to SET LDAPUSER

Command	Description
AUDIT LDAPDIRECTORY	Audit an IBM Spectrum Protect-controlled namespace on an LDAP directory server.
SET DEFAULTAUTHENTICATION	Specifies the default password authentication method for any REGISTER NODE or REGISTER ADMIN commands.

Command	Description
SET LDAPPASSWORD	Sets the password for the LDAPUSER.

## SET LICENSEAUDITPERIOD (Set license audit period)

Use this command to specify the period, in days, between automatic license audits performed by IBM Spectrum Protect™.

### Privilege class

To issue this command, you must have system privilege.

### Syntax

```
>>-Set--LICenseauditperiod--+-30---.
                             |-----+-----|-----><
                             | -days- |
```

### Parameters

**days**  
Specifies the number of days between automatic server license audits. This parameter is optional. The default value is 30. You can specify an integer from 1 to 30, inclusive.

### Example: Specify a 14 day server license audit

Specify that the server audits licenses every 14 days.

```
set licenseauditperiod 14
```

### Related commands

Table 1. Commands related to SET LICENSEAUDITPERIOD

Command	Description
AUDIT LICENSES	Verifies compliance with defined licenses.
QUERY AUDITOCCUPANCY	Displays the server storage utilization for a client node.
QUERY LICENSE	Displays information about licenses and audits.
QUERY STATUS	Displays the settings of server parameters, such as those selected by the SET commands.
REGISTER LICENSE	Registers a license with the IBM Spectrum Protect server.

## SET MAXCMDRETRIES (Set the maximum number of command retries)

Use this command to set the maximum number of times that a scheduler on a client node can retry a failed, scheduled command.

You can use the command to override the maximum number of retries that are specified by the client node. A client's value is overridden only if the client is able to connect with the server.

This command is used with the SET RETRYPERIOD command to regulate the time and the number of retry attempts to rerun failed command.

You can issue the QUERY STATUS command to display the current retry value. At installation, IBM Spectrum Protect™ is configured so that each client determines its own retry value.

### Privilege class

To issue this command, you must have system privilege.

## Syntax

---

```
>>-Set MAXCMDRetries--+-+-----+----->>  
                        '-number-'
```

## Parameters

---

number

Specifies the maximum number of times the scheduler on a client node can retry a failed scheduled command. This parameter is optional.

The default is that each client determines its own value for this parameter. You can specify an integer from 0 to 9999. See the appropriate client documentation for more information on setting the maximum command retries from the client.

## Example: Set the maximum number of command retries to 2

---

Retry, only twice, a failed attempt to process a scheduled command.

```
set maxcmdretries 2
```

## Related commands

---

Table 1. Command related to SET MAXCMDRETRIES

Command	Description
QUERY STATUS	Displays the settings of server parameters, such as those selected by the SET commands.
SET RETRYPERIOD	Specifies the time between retry attempts by the client scheduler.

## SET MAXSCHEDESESSIONS (Set maximum scheduled sessions)

---

Use this command to set the number of sessions that the server can use to process scheduled operations. This command specifies the maximum number of scheduled sessions as a percentage of the total number of available server sessions.

Limiting the number of sessions ensures that some are available for unscheduled operations, such as backup or archive. You can increase either the total number of sessions (with the MAXSESSIONS parameter) or the maximum percentage of scheduled sessions. Increasing the total number of sessions available, however, can affect server performance. Increasing the maximum percentage of scheduled sessions can reduce the sessions available for unscheduled operations.

## Privilege class

---

To issue this command, you must have system privilege.

## Syntax

---

```
>>-Set MAXSCHedsessions--percent----->>
```

## Parameters

---

percent (Required)

Specifies the percentage of total server sessions that can be used for scheduled operations. You can specify an integer from 0 to 100. The MAXSESSIONS parameter in the server options file determines the maximum number of total available server sessions.

If you set the maximum percentage of scheduled sessions to 0, no scheduled events can begin. If you set the maximum percentage of scheduled sessions to 100, the maximum number of scheduled sessions is the value of the MAXSESSIONS option.

Tip: If the maximum number of scheduled sessions do not coincide with the percentage that you set in the SET MAXSCHEDESESSIONS command, run the SET MAXSCHEDESESSIONS command again. Look in the MAXSESSIONS option and determine the number that is specified there. If the MAXSESSIONS option number changed and you did not issue the SET MAXSCHEDESESSIONS command since the change, the maximum number of scheduled sessions can change.

## Set a maximum of 20 sessions for scheduled activities

The MAXSESSIONS option has a value of 80. If you want no more than 20 sessions to be available for scheduled activity, set the percentage to 25.

```
set maxschedsessions 25
```

## Related commands

Table 1. Commands related to SET MAXSCHEDESESSIONS

Command	Description
QUERY OPTION	Displays information about server options.
QUERY STATUS	Displays the settings of server parameters, such as those selected by the SET commands.

## SET MINPWLENGTH (Set minimum password length)

Use this command to set the minimum length of a password.

## Privilege class

To issue this command, you must have system privilege.

## Syntax

```
>>--Set--MINPwlength--length----->>
```

## Parameters

length (Required)

Specifies the minimum length of a password. You can specify an integer from 0 to 64. A value of 0 means that the password length is not checked. The default value for minimum password length is set to 0.

## Example: Set the minimum password length

Set the minimum password length to 5 characters.

```
set minpwlenth 5
```

## Related commands

Table 1. Commands related to SET MINPWLENGTH

Command	Description
QUERY STATUS	Displays the settings of server parameters, such as those selected by the SET commands.
SET INVALIDPWLIMIT	Sets the number of invalid logon attempts before a node is locked.

## SET MONITOREDSEVERGROUP (Set the group of monitored servers)

Use this command to set the group of servers that are being monitored for alerts and status. You can also use this command to change or remove the group of monitored servers.

### Privilege class

To issue this command, you must have system privilege.

### Syntax

```
>>-Set MONITOREDSEVERGroup--+-----+----->>  
                               '-group_name-'
```

### Parameters

group\_name

Specifies the IBM Spectrum Protect™ server group name that contains all monitored servers. You can remove a monitored server group name by issuing the command without specifying a value, or by specifying an empty value (""). Any existing monitoring for alerts and status from remote servers is ended.

### Set the name of a monitored server group

Set the name of a monitored server group SUBS, by issuing the following command:

```
set monitoredservergroup subs
```

### Remove the name of a monitored server group

Remove the monitored server group, by issuing the following command:

```
set monitoredservergroup
```

### Related commands

Table 1. Commands related to SET MONITOREDSEVERGROUP

Command	Description
DEFINE SERVERGROUP (Define a server group)	Defines a new server group.
DEFINE GRPMEMBER (Add a server to a server group)	Defines a server as a member of a server group.
DELETE GRPMEMBER (Delete a server from a server group)	Deletes a server from a server group.
QUERY SERVERGROUP (Query a server group)	Displays information about server groups.
QUERY MONITORSETTINGS (Query the configuration settings for monitoring alerts and server status)	Displays information about monitoring alerts and server status settings.
SET MONITORINGADMIN (Set the name of the monitoring administrator)	Set the name of the monitoring administrator.

## SET MONITORINGADMIN (Set the name of the monitoring administrator)

Use this command to set the name of the monitoring administrator that is used to connect to the servers in the monitored server group.

To display the name of the monitored server group, issue the QUERY MONITORSETTINGS command.

The administrator name that you specify must match the name of an existing administrator, otherwise the command fails.

### Privilege class

To issue this command, you must have system privilege.

## Syntax

---

```
>>-Set MONITORINGADMIN--+-+-----+----->>  
                        '-admin_name-'
```

## Parameters

---

admin\_name

Specifies administrator names. You can remove names by issuing the command without specifying a value, or by specifying an empty value ("").

## Set the monitoring administrator name

---

Set the name of the monitoring administrator to MONADMIN, by issuing the following command:

```
set monitoringadmin monadmin
```

## Remove the monitoring administrator name

---

Remove the monitoring administrator, by issuing the following command:

```
set monitoringadmin ""
```

## Related commands

---

Table 1. Commands related to SET MONITORINGADMIN

Command	Description
QUERY MONITORSETTINGS (Query the configuration settings for monitoring alerts and server status)	Displays information about monitoring alerts and server status settings.
SET MONITOREDSEVERGROUP (Set the group of monitored servers)	Set the group of monitored servers.

## SET NODEATRISKINTERVAL (Specifies at-risk mode for an individual node)

---

Use this command to adjust the at-risk evaluation mode for an individual node.

## Privilege class

---

To issue this command, you must have system privilege, policy privilege for the domain to which the node is assigned, or client owner authority over the node.

## Syntax

---

```
>>---Set NODEATRISKINTERVAL--node_name----->  
  
>---TYPE---+---DEFAULT-----+-----><  
          +-BYPASSED-----+  
          '-CUSTOM--Interval---value-'
```

## Parameters

---

node\_name (Required)

Specifies the name of the client node that you want to update.



## TYPE (Required)

Specifies the at-risk evaluation type. Specify one of the following values:

### DEFAULT

Specifies that the node is evaluated with the same interval that was specified for the nodes classification by the SET STATUSATRISKINTERVAL command. The value is either system or applications, or VM, and is determined by the status monitor.

For example, you can specify `TYPE = DEFAULT`, which allows the status monitor to go ahead and classify the node automatically. Then the interval that is used, is the interval that was defined for that classification by the SET STATUSATRISKINTERVAL command.

### BYPASSED

Specifies that the node is not evaluated for at-risk status by the status monitor. The at risk status is also reported as bypassed to the Operations Center.

### CUSTOM

Specifies that the node is evaluated with the specified interval, rather than the interval that was specified by the SET STATUSATRISKINTERVAL command.

## Interval

Specifies the amount of time, in hours, between client backup activity before the status monitor considers the client to be at risk. You can specify an integer in the range 6 - 8808. You must specify this parameter when `TYPE = CUSTOM`. You do not specify this parameter when `TYPE = BYPASSED` or `TYPE = DEFAULT`. The interval value for all client types is set to 24 at server installation.

## Set node name to use a custom 90 day at-risk interval

Set the at-risk interval for a node named *fred* to 90 days.

```
set nodeatriskinterval fred type=custom interval=2160
```

## Bypass the at-risk interval evaluation

Bypass the at-risk interval checking for a node named *bob*.

```
set nodeatriskinterval bob type=bypassed
```

## Related commands

Table 1. Commands related to set nodeatriskinterval

Command	Description
SET STATUSATRISKINTERVAL (Specifies whether to enable client at-risk activity interval evaluation)	Specifies whether to enable client at-risk activity interval evaluation
SET VMATRISKINTERVAL (Specifies the at-risk mode for an individual VM filespace)	Sets the at-risk mode for a VM filespace
QUERY MONITORSTATUS (Query the monitoring status)	Displays information about monitoring alerts and server status settings.
QUERY MONITORSETTINGS (Query the configuration settings for monitoring alerts and server status)	Displays information about monitoring alerts and server status settings.
SET STATUSMONITOR (Specifies whether to enable status monitoring)	Specifies whether to enable status monitoring.
SET STATUSREFRESHINTERVAL (Set refresh interval for status monitoring)	Specifies the refresh interval for status monitoring.
SET STATUSSKIPASFAILURE (Specifies whether to use client at-risk skipped files as failure evaluation)	Specifies whether to use client at-risk skipped files as failure evaluation
QUERY NODE (Query nodes)	Displays partial or complete information about one or more clients.

Command	Description
QUERY FILESPACE (Query one or more file spaces)	Displays information about data in file spaces that belong to a client.

## SET PASSEXP (Set password expiration date)

Use this command to set the expiration period for administrator and client node passwords. You can either set a common password expiration period for all administrators and client node passwords or selectively set password expiration periods.

Restriction: The SET PASSEXP command does not apply to passwords that authenticate with an LDAP directory server.

You can override the SET PASSEXP setting for one or more nodes by using the REGISTER NODE or UPDATE NODE command with the PASSEXP parameter.

The NODE or ADMIN parameters must be specified to change the password expiration period for client nodes or administrators with selectively set password expiration periods. If you do not specify the NODE or ADMIN parameters, *all* client node and administrator passwords will use the new password expiration period. If you selectively set a password expiration period for a client node or administrator that does not already have a set password expiration period, it is not modified if you later set a password expiration for all users.

### Privilege class

To issue this command, you must have system privilege.

### Syntax

```
>>-Set PASSExp--days--+-+-----+----->
|           .-,----- . |
|           v              | |
|'-Node-----node_name--+'
>-----><
|           .-,----- . |
|           v              | |
|'-Admin-----admin_name--+'
>-----><
```

### Parameters

#### days (Required)

Specifies the number of days that a password remains valid.

You can specify from 1 to 9999 if you do not specify the NODE or the ADMIN parameter. If you specify the NODE or the ADMIN parameter, you can specify from 0 to 9999. A value of 0 means that the password never expires. If a password expires, the server prompts for a new password when the administrator or client node contacts the server.

#### Node

Specifies the name of the node for which you are setting the password expiration period. To specify a list of nodes, separate the names with commas and no intervening spaces. This parameter is optional.

#### Admin

Specifies the name of the administrator whose password expiration period you would like to set. To specify a list of administrators, separate the names with commas and no intervening spaces. This parameter is optional.

### Example: Set the administrator and client node password expiration

Set the administrator and client node password expiration period to 45 days.

```
set passexp 45
```

### Example: Set an administrator's password expiration

Set the administrator LARRY's password expiration period to 120 days.

```
set passexp 120 admin=larry
```

## Related commands

---

Table 1. Commands related to SET PASSEXP

Command	Description
QUERY STATUS	Displays the settings of server parameters, such as those selected by the SET commands.
REGISTER NODE	Defines a client node to the server and sets options for that user.
RESET PASSEXP	Resets the password expiration for nodes or administrators.
UPDATE ADMIN	Changes the password or contact information associated with any administrator.
UPDATE NODE	Changes the attributes that are associated with a client node.

## SET PRODUCTOFFERING (Set the product offering that is licensed to your enterprise)

---

Use the SET PRODUCTOFFERING command to define the IBM Spectrum Protect™ product offering that is licensed to your enterprise.

The definition is used to determine whether automatic storage capacity measurement calculations are required and made available for use by the IBM® License Metric Tool (ILMT). Run this command only if you are using ILMT to determine license consumption.

For product offerings where automatic storage capacity measurement calculations are made available for use by ILMT, the parameter also defines which capacity measurement approach is used for those calculations.

The capacity measurement approach is defined by the licensing terms of your specific product offering. To determine the currently calculated storage capacity for your product offering, see Verifying license compliance.

The same storage capacity information is made available to ILMT on a weekly interval. After an applicable product offering is defined by using this command, IBM Spectrum Protect makes the current capacity calculation for that offering available to the ILMT. After the initial capacity calculation is made available to ILMT, IBM Spectrum Protect updates the value weekly.

### Privilege class

---

To run this command, you must have system privilege.

### Syntax

---

```
>>-SET PRODUCTOFFERING--product_offering-----<<
```

### Parameters

---

**product\_offering** (Required)

Specifies a product offering. The maximum length of the text string is 255 characters. The following options are available:

**ENTry**

Specifies that the product offering licensed in your enterprise is IBM Spectrum Protect Entry. This product offering uses a Per Managed Server licensing metric. Capacity measurements for this product offering are not applicable.

**DATARet**

Specifies that the product offering licensed in your enterprise is IBM Spectrum Protect for Data Retention. Capacity measurements for this product offering are not calculated automatically or made available for use by ILMT.

**BASIC**

Specifies that the product offering licensed in your enterprise is IBM Spectrum Protect. This product offering uses a processor value unit (PVU) licensing metric. Capacity measurements for this product offering are not applicable.

EE

Specifies that the product offering licensed in your enterprise is IBM Spectrum Protect Extended Edition. This product offering uses a PVU licensing metric. Capacity measurements for this product offering are not applicable.

SUIte

Specifies that the product offering licensed in your enterprise is IBM Spectrum Protect Suite. Capacity measurements for this product offering are calculated automatically and made available for use by ILMT.

SUITEEntry

Specifies that the product offering licensed in your enterprise is IBM Spectrum Protect Suite Entry. Capacity measurements for this product offering are calculated automatically and made available for use by ILMT.

SUITEArchive

Specifies that the product offering licensed in your enterprise is IBM Spectrum Protect Suite - Archive. Capacity measurements for this product offering are calculated automatically and made available for use by ILMT.

SUITEProtectier

Specifies that the product offering licensed in your enterprise is IBM Spectrum Protect Suite - ProtecTier. Capacity measurements for this product offering are calculated automatically and made available for use by ILMT.

SUITEFrontend

Specifies that the product offering licensed in your enterprise is IBM Spectrum Protect Suite - FrontEnd. Capacity measurements for this product offering are calculated automatically and made available for use by ILMT.

SUITEENTRYFrontend

Specifies that the product offering licensed in your enterprise is IBM Spectrum Protect Suite Entry - FrontEnd. Capacity measurements for this product offering are calculated automatically and made available for use by ILMT.

CLEAR

No product offering is specified.

## Example: Set the product offering to IBM Spectrum Protect (BASIC)

```
set productoffering BASIC
```

## Related commands

Table 1. Commands related to SET PRODUCTOFFERING

Command	Description
QUERY STATUS	Displays the settings of server parameters, such as those selected by the SET commands.

## SET QUERYSCHEDPERIOD (Set query period for polling client nodes)

Use this command to regulate how often client nodes contact the server to obtain scheduled work when it is running in the client-polling scheduling mode.

Each client can set its own retry period at the time its scheduler is started. You can use this command to override the value specified by all clients that can connect with the server.

If client nodes poll more frequently for schedules, the nodes receive changes to schedules more quickly. However, increased polling by the client nodes also increases network traffic.

You can issue the QUERY STATUS command to display the value for the period between schedule queries. At installation, IBM Spectrum Protect™ is configured so that each client node determines its own value for this setting.

## Privilege class

To issue this command, you must have system privilege.

## Syntax

---

```
>>-Set QUERYSChedperiod--++-----+----->><
                          '-hours-'
```

## Parameters

---

hours

Specifies the maximum number of hours the scheduler on a client node waits between attempts to contact the server to obtain a schedule. This parameter is optional. You can specify an integer from 1 to 9999. If you do not specify a value for this parameter, each client determines its own value for this parameter.

## Example: Set the polling period for all client nodes

---

Have all clients using the polling scheduling mode contact the server every 24 hours.

```
set querieschedperiod 24
```

## Related commands

---

Table 1. Commands related to SET QUERYSCHEDPERIOD

Command	Description
QUERY STATUS	Displays the settings of server parameters, such as those selected by the SET commands.
SET SCHEDMODES	Specifies the central scheduling mode for the server.

## SET RANDOMIZE (Set randomization of scheduled start times)

---

Use this command to set randomized start times within the startup window of each schedule for clients by using the client-polling scheduling mode. A startup window is the start time and duration during which a schedule must be initiated. A client-polling scheduling mode is a client/server communication technique where the client queries the server for work.

Each schedule has a window during which it can be run. To balance network and server load, the start times for clients can be scattered across that window. Use this command to specify the fraction of the window over which start times for clients are distributed.

The randomization occurs at the beginning of the window to allow time for retries, if necessary. When the scheduling mode is not set to polling, randomization does not occur if the client's first contact with the server is after the start time for the event.

You can issue the QUERY STATUS command to display the value for the schedule randomization percentage. At installation, the value is 25 percent.

Set the randomization percentage to a value greater than 0 to prevent communication errors. Communication errors can result from a large group of clients contacting the server simultaneously. If you do experience communication errors, you can increase the randomization percentage so that client contact is spread out. This decreases the chance for communication overload and failure.

## Privilege class

---

To issue this command, you must have system privilege.

## Syntax

---

```
>>-Set RANDomize--percent----->><
```

## Parameters

---

percent (Required)

Specifies the percentage of the startup window over which the start times for individual clients are distributed. You can specify an integer from 0 to 50.

A value of 0 indicates that no randomization occurs and that all clients run schedules at the beginning of the startup windows.

A value of 50 indicates that clients are assigned start times that are randomly scattered across the first half of each startup window.

At installation, this value is 25, indicating that the first 25 percent of the window is used for randomization.

If you have specified DURUNITS=INDEFINITE in the DEFINE SCHEDULE command, the percentage is applied to a 24 hour period. For example, a value of 25 percent would result in a 6 hour window.

## Example: Set randomization of scheduled start times

Set randomization to 50 percent.

```
set randomize 50
```

## Related commands

Table 1. Commands related to SET RANDOMIZE

Command	Description
DEFINE SCHEDULE	Defines a schedule for a client operation or an administrative command.
QUERY STATUS	Displays the settings of server parameters, such as those selected by the SET commands.
SET SCHEDMODES	Specifies the central scheduling mode for the server.

## SET REPLRECOVERDAMAGED (Specify whether damaged files are recovered from a replication server)

Use this command to enable the system-wide recovery of damaged files from a target replication server. If this setting is turned on, the node replication process can be configured to detect damaged files on the source replication server and replace them with undamaged files from the target replication server.

The REPLRECOVERDAMAGED system parameter affects all file recovery processes across all replication processes for all nodes and file spaces. File recovery is possible only if the server software, Version 7.1.1 or later, is installed on the source and target replication servers, and if the node data was replicated before the file damage occurred.

To display the current setting, use the QUERY STATUS command.

When you install the server, the default setting is ON.

If you upgrade the server and no damaged files are detected, the default setting is ON.

If you upgrade the server and damaged files are detected, the parameter is set to OFF, and a message is issued to indicate that the recovery of damaged files is disabled. The OFF setting prevents the server from scanning database tables for damaged objects that can be recovered. Prevention of the scan is necessary in case many damaged files are detected. In that case, a scan can take a considerable amount of time, and should be scheduled when use of server resources is at a minimum. When you are ready to start the scan and recover damaged files, you must issue the SET REPLRECOVERDAMAGED command and specify the ON setting. After the server successfully completes the scan, the REPLRECOVERDAMAGED system parameter is set to ON.

The following table describes how the REPLRECOVERDAMAGED system parameter and other parameters affect the recovery of damaged, replicated files.

Table 1. Settings that affect the recovery of damaged files

Setting for the REPLRECOVERDAMAGED system parameter	Value of the RECOVERDAMAGED parameter on the REPLICATE NODE command	Value of the RECOVERDAMAGED parameter on the REGISTER NODE and UPDATE NODE commands	Result
OFF	YES, NO, or not specified	YES or NO	During node replication, standard replication occurs and damaged files are not recovered from the target replication server.
OFF	ONLY	YES or NO	An error message is displayed because files cannot be recovered when the REPLRECOVERDAMAGED system parameter is set to OFF.
ON	YES	YES or NO	During node replication, standard replication occurs and damaged files are recovered from the target replication server.
ON	NO	YES or NO	During node replication, standard replication occurs and damaged files are not recovered from the target replication server.
ON	ONLY	YES or NO	Damaged files are recovered from the target replication server, but standard node replication does not occur.
ON	Not specified	YES	During node replication, standard replication occurs and damaged files are recovered from the target replication server.
ON	Not specified	NO	During node replication, standard replication occurs and damaged files are not recovered from the target replication server.

## Privilege class

To issue this command, you must have system privilege.

## Syntax

```

.-Set REPLRECOVERDamaged-----ON-----
>>+----->>
'-Set REPLRECOVERDamaged-----+Off+-'
'-ON--'

```

## Parameters

ON

Specifies that node replication is enabled to recover damaged files from a target replication server.

OFF

Specifies that node replication is not enabled to recover damaged files from a target replication server.

## Example: Enable recovery of damaged files

To specify a system-wide setting that enables the server to recover damaged files from a target replication server, issue the following command:

```
set replrecoveredamaged on
```

## Related commands

Table 2. Commands related to SET REPLRECOVERDAMAGED

Command	Description
QUERY STATUS	Displays the settings of server parameters, such as those selected by the SET commands.
REGISTER NODE	Defines a client node to the server and sets options for that user.
REPLICATE NODE	Replicates data in file spaces that belong to a client node.
UPDATE NODE	Changes the attributes that are associated with a client node.

## SET REPLRETENTION (Set the retention period for replication records)

To maintain adequate information about replication processes, you can use this command to adjust the length of time that the source replication server retains replication records in its database. The SET REPLRETENTION command specifies the retention period for client-node replication records in the source replication-server database. You can use client node replication records to monitor running and completed processes.

A replication record is created when REPLICATE NODE command processing is started. By default, IBM Spectrum Protect™ retains client-node replication records for 30 calendar days. A calendar day consists of 24 hours, from midnight to midnight. For example, suppose that the retention period is two calendar days. If a replication process completes at 11:00 p.m. on day *n*, a record of that process is retained for 25 hours until midnight on day *n+1*. To display the retention period for replication records, issue the QUERY STATUS command on the source replication server.

Issue the SET REPLRETENTION command on the server that acts as a source for replicated data.

### Privilege class

To issue this command, you must have system privilege.

### Syntax

```
..-30-----.  
>>-Set REPLREtention--+-----+----->>  
    '-number_of_days-'
```

### Parameters

number\_of\_days (Required)

The number of days that the source replication server retains replication records. You can specify an integer 0 - 9999. The default value is 30.

### Example: Set a retention period for client-node replication records

You want to retain client-node replication records for 10 days.

```
set replretention 10
```

## Related commands

Table 1. Commands related to SET REPLRETENTION

Command	Description
QUERY REPLICATION	Displays information about node replication processes.
QUERY REPLNODE	Displays information about the replication status of a client node.



Command	Description
QUERY REPLRULE	Displays information about node replication rules.
REPLICATE NODE	Replicates data in file spaces that belong to a client node.
QUERY STATUS	Displays the settings of server parameters, such as those selected by the SET commands.

## SET REPLSERVER (Set the target replication server)

Use this command to set the name of a target replication server. You can also use this command to change or remove a target replication server.

Issue this command on the server that acts as a source for replicated data.

To display the name of a target replication server, issue the QUERY STATUS command on a source replication server.

Important:

- The server name that you specify with this command must match the name of an existing server definition. It must also be the name of the server to be used as the target replication server. If the server name specified by this command does not match the server name of an existing server definition, the command fails.
- Use care when you are changing or removing a target replication server. If you change a target replication server, replicated client-node data is sent to a different target replication server. If you remove a target replication server, client node data is not replicated.

### Privilege class

To issue this command, you must have system privilege.

### Syntax

```
>>-Set REPLSERVER-----+-----><
                        '-target_server_name-'
```

### Parameters

target\_server\_name

Specifies the name of the target replication server. The name that you specify must match the name of an existing server. The maximum length of a name is 64 characters.

To remove a target replication server, issue the command without specifying a value.

Note: If you do not want to continue replicating data, you can remove the node replication configuration after you remove the target replication server.

### Example: Set a target replication server

The name of the server that you want to set as the target replication server is SERVER1.

```
set replserver server1
```

### Related commands

Table 1. Commands related to SET REPLSERVER

Command	Description
DEFINE SERVER	Defines a server for server-to-server communications.
QUERY SERVER	Displays information about servers.

Command	Description
QUERY STATUS	Displays the settings of server parameters, such as those selected by the SET commands.
UPDATE SERVER	Updates information about a server.
REMOVE REPLNODE	Removes a node from replication.
REMOVE REPLSERVER	Removes a server from replication.

## SET RETRYPERIOD (Set time between retry attempts)

Use this command to set the number of minutes the scheduler on a client node waits between retry attempts after a failed attempt to contact the server or after a scheduled command fails to process.

Each client can set its own retry period at the time its scheduler program is started. You can use this command to override the values specified by all clients that can connect with the server.

This command is used in conjunction with the SET MAXCMDRETRIES command to regulate the period of time and the number of retry attempts to run a failed command.

You can issue the QUERY STATUS command to display the value for the period between retries. At installation, IBM Spectrum Protect™ allows each client to determine its own retry period.

### Privilege class

To issue this command, you must have system privilege.

### Syntax

```
>>-Set RETRYPeriod--+++++----->><
                    '-minutes-'
```

### Parameters

minutes

Specifies the number of minutes the scheduler on a client node waits between retry attempts after a failed attempt to contact the server or after a scheduled command fails to process. When setting the retry period, set a time period that permits more than one retry attempt within a typical startup window. You can specify an integer from 1 to 9999.

### Example: Set a fifteen minute time period between retry attempts

Have the client scheduler retry failed attempts to contact the server or to process scheduled commands every fifteen minutes.

```
set retryperiod 15
```

### Related commands

Table 1. Commands related to SET RETRYPERIOD

Command	Description
QUERY STATUS	Displays the settings of server parameters, such as those selected by the SET commands.
SET MAXCMDRETRIES	Specifies the maximum number of retries after a failed attempt to execute a scheduled command.

## SET SCHEDMODES (Select a central scheduling mode)

Use this command to determine how the clients communicate with the server to begin scheduled work. You must configure each client to select the scheduling mode in which it operates.

Use this command with the SET RETRYPERIOD command to regulate the time and the number of retry attempts to process a failed command.

You can issue the QUERY STATUS command to display the value for the scheduling mode supported. At installation, this value is ANY.

## Privilege class

---

To issue this command, you must have system privilege.

## Syntax

---

```
>>-Set SCHEDMODEs---+ANY-----+-----><
      +-Polling--+
      '-PRompted-'
```

## Parameters

---

ANY

Specifies that clients can run in either the client-polling or the server-prompted scheduling mode.

POLLing

Specifies that only the client-polling mode can be used. Client nodes poll the server at prescribed time intervals to obtain scheduled work.

PRompted

Specifies that only the server-prompted mode can be used. This mode is only available for clients that communicate with TCP/IP. Client nodes wait to be contacted by the server when scheduled work needs to be performed and a session is available.

## Example: Restrict scheduled operations to clients using client-polling

---

Clients can run under both server-prompted and client-polling central scheduling. You want to temporarily restrict the scheduled operations to clients that use the client-polling mode. If you set the schedule mode to POLLING, the server discontinues prompting clients to run scheduled commands. This means that any client scheduler using the server-prompted mode waits until you set the schedule mode to ANY or PROMPTED.

```
set schedmodes polling
```

## Related commands

---

Table 1. Command related to SET SCHEDMODES

Command	Description
QUERY STATUS	Displays the settings of server parameters, such as those selected by the SET commands.
SET RETRYPERIOD	Specifies the time between retry attempts by the client scheduler.

## SET SCRATCHPADRETENTION (Set scratch pad retention time)

---

Use this command to set the amount of time for which scratch pad entries are retained.

## Privilege class

---

To issue this command, you must have system privilege.

## Syntax

---

```
>>-SET SCRATCHPADRETENTION--days-----><
```

## Parameters

---

days (Required)

Specifies the number of days that a scratchpad entry is retained after the last update to the scratchpad entry. You can enter an integer in the range 1 - 9999.

## Example: Retain scratch pad entries for 367 days after they are updated

---

```
set scratchpadretention 367
```

## Related commands

---

Table 1. Commands related to SET SCRATCHPADRETENTION

Command	Description
DEFINE SCRATCHPADENTRY	Creates a line of data in the scratch pad.
DELETE SCRATCHPADENTRY	Deletes a line of data from the scratch pad.
QUERY SCRATCHPADENTRY	Displays information that is contained in the scratch pad.
UPDATE SCRATCHPADENTRY	Updates data on a line in the scratch pad.

## SET SERVERHLADDRESS (Set the high-level address of a server)

---

Use this command to set the high-level address (IP) of a server. IBM Spectrum Protect™ uses the address when you issue a DEFINE SERVER command with CROSSDEFINE=YES. You must use the SET SERVERHLADDRESS command for all automatic client deployments.

## Privilege class

---

To issue this command, you must have system privilege.

## Syntax

---

```
>>-Set SERVERHladdress--ip_address-----><
```

## Parameters

---

ip\_address (Required)

Specifies a server high-level address as a numeric dotted decimal name or a host name. If a host name is specified, a server that can resolve the name to the dotted decimal form must be available.

## Example: Set the high-level address of a server

---

Set the high-level address of HQ\_SERVER to 9.230.99.66.

```
set serverhladdress 9.230.99.66
```

## Related commands

---

Table 1. Command related to SET SERVERHLADDRESS

Command	Description
SET CROSSDEFINE	Specifies whether to cross define servers.
SET SERVERLLADDRESS	Specifies the low-level address of a server.

Command	Description
SET SERVERPASSWORD	Specifies the server password.

## SET SERVERLLADDRESS (Set the low-level address of a server)

Use this command to set the low-level address of a server. IBM Spectrum Protect™ uses the address when you issue a DEFINE SERVER command with CROSSDEFINE=YES.

### Privilege class

To issue this command, you must have system privilege.

### Syntax

```
>>-Set SERVERLLaddress--tcp_port-----><
```

### Parameters

tcp\_port (Required)

Specifies the low-level address of the server. Generally, this address is identical to the TCPPOINT option in the server option file of the server.

### Example: Set the low-level address of a server

Set the low-level address of HQ\_SERVER to 1500.

```
set serverlladdress 1500
```

### Related commands

Table 1. Command related to SET SERVERLLADDRESS

Command	Description
SET CROSSDEFINE	Specifies whether to cross define servers.
SET SERVERHLADDRESS	Specifies the high-level address of a server.
SET SERVERPASSWORD	Specifies the server password.

## SET SERVERNAME (Specify the server name)

Use this command to change the server name. When you install the IBM Spectrum Protect™ server, the name is set at installation to SERVER1.

Use the QUERY STATUS command to display the server name.

If you migrate from ADSM to IBM Spectrum Protect, the name is set to ADSM or the name last specified to ADSM with a SET SERVERNAME command.

Important:

- If this is a source server for a virtual volume operation, changing its name can impact its ability to access and manage the data it has stored on the corresponding target server.
- To prevent problems related to volume ownership, do not change the name of a server if it is a library client.

When changing the name of a server, be aware of the following additional restrictions:

- Windows clients use the server name to identify which passwords belong to which servers. Changing the server name after the clients are connected forces the clients to reenter the passwords.

- You must set unique names on servers that communicate with each other. On a network where clients connect to multiple servers, it is recommended that all of the servers have unique names.

## Privilege class

---

To issue this command, you must have system privilege.

## Syntax

---

```
>>-Set SERVERname--server_name-----><
```

## Parameters

---

server\_name (Required)

Specifies the new server name. The name must be unique across a server network for enterprise event logging, enterprise configuration, command routing, or virtual volumes. The maximum length of the name is 64 characters.

## Example: Name the server

---

Name the server WELLS\_DESIGN\_DEPT.

```
set servername wells_design_dept
```

## Related commands

---

Table 1. Command related to SET SERVERNAME

Command	Description
QUERY STATUS	Displays the settings of server parameters, such as those selected by the SET commands.

## SET SERVERPASSWORD (Set password for server)

---

Use this command to set the password for communication between servers to support enterprise administration and enterprise event logging and monitoring.

## Privilege class

---

To issue this command, you must have system privilege.

## Syntax

---

```
>>-Set SERVERPAssword--password-----><
```

## Parameters

---

password (Required)

Specifies a password for the server. Other servers must have the same password in their definitions of this server.

## Example: Set a server password

---

Set the password for HQ\_SERVER to agave.

```
set serverpassword agave
```

## Related commands

---

Table 1. Command related to SET SERVERPASSWORD

Command	Description
SET CROSSDEFINE	Specifies whether to cross define servers.
SET SERVERHLADDRESS	Specifies the high-level address of a server.
SET SERVERLLADDRESS	Specifies the low-level address of a server.

## SET SPREPLRULEDEFAULT (Set the server replication rule for space-managed data)

Use this command to set the server replication rule for space-managed data.

Restriction: The replication rule that you set with this command is applied only if file space rules and client node rules for space-managed data are set to DEFAULT.

Issue this command on the server that acts as a source for replicated data.

You can specify a normal-priority replication rule or a high-priority replication rule. In a replication process that includes both normal and high-priority data, high-priority data is replicated first. Before you specify a rule, consider the order in which you want the data to be replicated.

For example, suppose that your client nodes contain space-managed data and backup data. Replication of the space-managed data is a higher priority than the backup data. To prioritize the space-managed data, issue the SET SPREPLRULEDEFAULT command and specify the ALL\_DATA\_HIGH\_PRIORITY replication rule. To prioritize the backup data, issue the SET BKREPLRULEDEFAULT command and specify the ALL\_DATA replication rule for backup data. The ALL\_DATA rule for backup data replicates backup data with a normal priority.

### Privilege class

To issue this command, you must have system privilege.

### Syntax

```
>>-Set SPREPLRuledefault---ALL_DATA-----+----->>
      +-ALL_DATA_HIGH_PRIORITY--+
      '-NONE-----'
```

### Parameters

- ALL\_DATA  
Replicates space-managed data with a normal priority.
- ALL\_DATA\_HIGH\_PRIORITY  
Replicates space-managed data with a high priority.
- NONE  
Space-managed data is not replicated.

### Example: Set the server replication rule for space-managed data

Set up the default rule for space-managed data to replicate with a high priority.

```
set spreplruledefault all_data_high_priority
```

### Related commands

Table 1. Commands related to SET BKREPLRULEDEFAULT

Command	Description
QUERY FILESPACE	Displays information about data in file spaces that belong to a client.

Command	Description
QUERY NODE	Displays partial or complete information about one or more clients.
QUERY REPLICATION	Displays information about node replication processes.
QUERY REPLRULE	Displays information about node replication rules.
QUERY STATUS	Displays the settings of server parameters, such as those selected by the SET commands.
REPLICATE NODE	Replicates data in file spaces that belong to a client node.
SET ARREPLRULEDEFAULT	Specifies the server node-replication rule for archive data.
SET BKREPLRULEDEFAULT	Specifies the server node-replication rule for backup data.
UPDATE FILESPACE	Changes file-space node-replication rules.
UPDATE REPLRULE	Enables or disables replication rules.
VALIDATE REPLICATION	Verifies replication for file spaces and data types.

## SET STATUSATRISKINTERVAL (Specifies whether to enable client at-risk activity interval evaluation)

Use this command to adjust the backup activity interval that is used when the status monitor assesses whether clients are at risk.

### Privilege class

To issue this command, you must have system privilege.

### Syntax

```
>>---Set STATUSATRISKINTERVAL--TYPE-------+All-----+----->
                                     +-Applications-+
                                     +-VM-----+
                                     '-SSystems-----'

>----Interval--===value-----><
```

### Parameters

#### TYPE (Required)

Specifies the type of client that should be evaluated. Specify one of the following values:

ALL

Specify this setting for all client types.

APplications

Specify this setting for only application client types.

VM

Specify this setting for virtual system clients types.

SYstems

Specify this setting for systems client types.

#### Interval (Required)

Specifies the amount of time, in hours, between client activity before the status monitor considers the client to be at risk.

You can specify an integer in the range 6 - 8808. The interval value for all client types is set to 24 at server installation.

### Set systems to use a two-week at-risk interval

Set the at-risk interval check for systems client types to 2 weeks.



```
set statusriskinterval type=systems interval=336
```

## Related commands

Table 1. Commands related to

Command	Description
DEFINE STATUSTHRESHOLD (Define a status monitoring threshold)	Defines a status monitoring threshold.
DELETE STATUSTHRESHOLD (Delete a status monitoring threshold)	Deletes a status monitoring threshold.
QUERY MONITORSTATUS (Query the monitoring status)	Displays information about monitoring alerts and server status settings.
QUERY MONITORSETTINGS (Query the configuration settings for monitoring alerts and server status)	Displays information about monitoring alerts and server status settings.
QUERY STATUSTHRESHOLD (Query status monitoring thresholds)	Displays information about a status monitoring thresholds.
SET STATUSMONITOR (Specifies whether to enable status monitoring)	Specifies whether to enable status monitoring.
SET STATUSREFRESHINTERVAL (Set refresh interval for status monitoring)	Specifies the refresh interval for status monitoring.
SET STATUSSKIPASFAILURE (Specifies whether to use client at-risk skipped files as failure evaluation)	Specifies whether to use client at-risk skipped files as failure evaluation
UPDATE STATUSTHRESHOLD (Update a status monitoring threshold)	Changes the attributes of an existing status monitoring threshold.

## SET STATUSMONITOR (Specifies whether to enable status monitoring)

Use this command to enable and disable status monitoring. Turning status monitoring on for the first time also sets the default threshold values, and increases the event record retention to at least 14 days.

### Privilege class

To issue this command, you must have system privilege.

### Syntax

```
.-Set STATUSMonitor-----Off-----.  
>>-+-----+-----+-----+----->>  
'-Set STATUSMonitor-----+ON--+-'  
      '-Off-'
```

### Parameters

ON

Specifies that the status monitoring is turned on. The first time that you set status monitoring to ON, it sets all the default threshold values that are specified in the DEFINE STATUSTHRESHOLD and UPDATE STATUSTHRESHOLD commands. It also sets the retention value for event records to at least 14 days. For example, when you turn status monitoring on, the default values for primary storage pool utilization is automatically set to display a warning when the threshold value reaches 80%, and an error when the threshold reaches 90% utilization.

OFF

Specifies that the status monitoring is turned off. Off is the default value.

### Enable status monitoring

Set status monitoring to on to enable status monitoring.

```
set statusmonitor on
```

## Related commands

Table 1. Commands related to SET STATUSMONITOR

Command	Description
DEFINE STATUSTHRESHOLD (Define a status monitoring threshold)	Defines a status monitoring threshold.
DELETE STATUSTHRESHOLD (Delete a status monitoring threshold)	Deletes a status monitoring threshold.
QUERY MONITORSTATUS (Query the monitoring status)	Displays information about monitoring alerts and server status settings.
QUERY MONITORSETTINGS (Query the configuration settings for monitoring alerts and server status)	Displays information about monitoring alerts and server status settings.
QUERY STATUSTHRESHOLD (Query status monitoring thresholds)	Displays information about a status monitoring thresholds.
SET STATUSATRISKINTERVAL (Specifies whether to enable client at-risk activity interval evaluation)	Specifies whether to enable client at-risk activity interval evaluation
SET STATUSREFRESHINTERVAL (Set refresh interval for status monitoring)	Specifies the refresh interval for status monitoring.
SET STATUSSKIPFAILURE (Specifies whether to use client at-risk skipped files as failure evaluation)	Specifies whether to use client at-risk skipped files as failure evaluation
UPDATE STATUSTHRESHOLD (Update a status monitoring threshold)	Changes the attributes of an existing status monitoring threshold.

## SET STATUSREFRESHINTERVAL (Set refresh interval for status monitoring)

Use this command to specify the number of minutes between status monitoring server queries.

### Privilege class

To issue this command, you must have system privilege.

### Syntax

```
>>-Set STATUSREFreshinterval--minutes----->>
```

### Parameters

minutes (Required)

Specifies the approximate number of minutes between status monitoring server queries. You can specify an integer in the range 1 - 2440. The default value is 5.

Restrictions:

- In a storage environment that is monitored by the Operations Center, set the same refresh interval on the hub and spoke servers. If you use different intervals, the Operations Center can show inaccurate information for spoke servers.
- Short status refresh intervals use more space in the server database and might require more processor and disk resources. For example, decreasing the interval by half doubles the required database and archive log space. Long intervals reduce the currency of Operations Center data but better suit a high-latency network configuration.
- A status refresh interval of less than 5 minutes can cause the following issues:

- Operations Center data that is supposed to be refreshed after the defined interval takes a longer time to be refreshed.
- Operations Center data that is supposed to be refreshed almost immediately when a related change occurs in the storage environment also takes a longer time to be refreshed.

## Set the refresh interval for status monitoring

Specify that the server status is queried every 6 minutes, by issuing the following command:

```
set statusrefreshinterval 6
```

## Related commands

Table 1. Commands related to SET STATUSREFRESHINTERVAL

Command	Description
DEFINE STATUSTHRESHOLD (Define a status monitoring threshold)	Defines a status monitoring threshold.
DELETE STATUSTHRESHOLD (Delete a status monitoring threshold)	Deletes a status monitoring threshold.
QUERY MONITORSTATUS (Query the monitoring status)	Displays information about monitoring alerts and server status settings.
QUERY MONITORSETTINGS (Query the configuration settings for monitoring alerts and server status)	Displays information about monitoring alerts and server status settings.
QUERY STATUSTHRESHOLD (Query status monitoring thresholds)	Displays information about a status monitoring thresholds.
SET STATUSATRISKINTERVAL (Specifies whether to enable client at-risk activity interval evaluation)	Specifies whether to enable client at-risk activity interval evaluation
SET STATUSMONITOR (Specifies whether to enable status monitoring)	Specifies whether to enable status monitoring.
SET STATUSSKIPASFAILURE (Specifies whether to use client at-risk skipped files as failure evaluation)	Specifies whether to use client at-risk skipped files as failure evaluation
UPDATE STATUSTHRESHOLD (Update a status monitoring threshold)	Changes the attributes of an existing status monitoring threshold.

## SET STATUSSKIPASFAILURE (Specifies whether to use client at-risk skipped files as failure evaluation)

Use this command to enable the status monitor to consider clients as at risk when evaluating the status for each client.

### Privilege class

To issue this command, you must have system privilege.

### Syntax

```
>>-Set STATUSSKIPASFAILURE--+Yes-+----->
                               '-No--'
```

```
>--TYPE--++All-----<
          +-Applications-+
          +-VM-----+
          '-Systems-----'
```

### Parameters

#### State (Required)

Specifies whether to enable the check for skipped files during the last backup. This check signifies that the client is at-risk if any files were skipped. Client data that is skipped or not backed up properly is considered at risk.

#### Yes

Specifies that the server evaluates whether a client is at risk.

#### No

Specifies that the server does not evaluate whether a client is at risk.

#### TYPE (Required)

Specifies the type of client that should be evaluated. Specify one of the following values:

#### ALL

Specify this setting for all client types.

#### APplications

Specify this setting for only application client types.

#### VM

Specify this setting for virtual system clients types.

#### SyStems

Specify this setting for systems client types.

## Disable at-risk evaluation for virtual system client types

Disable the at-risk evaluation for virtual systems client types by issuing the following command:

```
set statusskipasfailure off type=vm
```

## Related commands

Table 1. Commands related to SET STATUSSKIPASFAILURE

Command	Description
DEFINE STATUSTHRESHOLD (Define a status monitoring threshold)	Defines a status monitoring threshold.
DELETE STATUSTHRESHOLD (Delete a status monitoring threshold)	Deletes a status monitoring threshold.
QUERY MONITORSTATUS (Query the monitoring status)	Displays information about monitoring alerts and server status settings.
QUERY MONITORSETTINGS (Query the configuration settings for monitoring alerts and server status)	Displays information about monitoring alerts and server status settings.
QUERY STATUSTHRESHOLD (Query status monitoring thresholds)	Displays information about a status monitoring thresholds.
SET STATUSATRISKINTERVAL (Specifies whether to enable client at-risk activity interval evaluation)	Specifies whether to enable client at-risk activity interval evaluation
SET STATUSMONITOR (Specifies whether to enable status monitoring)	Specifies whether to enable status monitoring.
SET STATUSREFRESHINTERVAL (Set refresh interval for status monitoring)	Specifies the refresh interval for status monitoring.
UPDATE STATUSTHRESHOLD (Update a status monitoring threshold)	Changes the attributes of an existing status monitoring threshold.

## SET SUBFILE (Set subfile backup for client nodes)

Use this command to set up the server to allow clients to back up subfiles. On the client's workstation, the SUBFILECACHEPATH and SUBFILECACHESIZE options must be specified in the client's options file (dsm.opt). If you are using a Windows client, you must also specify the SUBFILEBACKUP option.

With subfile backups, when a client's file has been previously backed up, any subsequent backups are typically made to the portion (a subfile) of the client's file that has changed, rather than the entire file.

Use the QUERY STATUS command to determine whether subfiles can be backed up to the server running this command.

## Privilege class

---

To issue this command, you must have system privilege.

## Syntax

---

```
>>-Set SUBFILE---Client+-----><
                '-No-----'
```

## Parameters

---

Client

Specifies that the client node can determine whether to use subfile backup.

No

Specifies that the subfile backups are not to be used. At installation, this value is set to No.

## Example: Set subfile backup for client nodes

---

Allow the client node to backup subfiles on the server.

```
set subfile client
```

## Related commands

---

Table 1. Command related to SET SUBFILE

Command	Description
QUERY STATUS	Displays the settings of server parameters, such as those selected by the SET commands.

## SET SUMMARYRETENTION (Set number of days to keep data in activity summary table)

---

Use this command to specify the number of days to keep information in the SQL activity summary table.

The SQL activity summary table contains statistics about each client session and server processes. For a description of the information in the SQL activity summary table, issue the following command:

```
select colname, remarks from columns where tablename='SUMMARY'
```

Issue the QUERY STATUS command to display the number of days the information is kept. At installation, IBM Spectrum Protect™ allows each server to determine its own number of days for keeping information in the SQL activity summary table.

## Privilege class

---

To issue this command, you must have system privilege.

## Syntax

---

```
>>-Set SUMmaryretention+-----><
                '-days-'
```

## Parameters

---

days

Specifies the number of days to keep information in the activity summary table. You can specify a number from 0 to 9999. A value of 0 means that information in the activity summary table is not kept. A value of 1 specifies to keep the activity summary table for the current day.

## Example: Specify the number of days to keep information in the SQL activity summary table

Set the server to retain the activity summary table information for 15 days.

```
set summaryretention 15
```

## Related commands

Table 1. Commands related to SET SUMMARYRETENTION

Command	Description
QUERY STATUS	Displays the settings of server parameters, such as those selected by the SET commands.
SET ACTLOGRETENTION	Specifies the number of days to retain log records in the activity log.
QUERY ACTLOG	Displays messages from the server activity log.
SELECT	Allows customized queries of the IBM Spectrum Protect database.

## SET TAPEALERTMSG (Set tape alert messages on or off)

Use this command to allow the IBM Spectrum Protect™ server to log notification of diagnostic information from library and drive devices. At installation, this value is set to OFF. When enabled, the server can retrieve diagnostic information from a tape or library device and display it using ANR messages. When disabled, the server will not query a device for this information.

## Privilege class

To issue this command, you must have system privilege or unrestricted storage privilege.

## Syntax

```
>>-Set TAPEAlertmsg--+-ON--+------>>  
                '-OFF-'
```

## Parameters

ON

Specifies that diagnostic information will be reported to the server.

OFF

Specifies that diagnostic information will not be reported to the server.

## Example: Set tape alert messages on

Allow the server to receive diagnostic information messages.

```
set tapealertmsg on
```

## Related commands

Table 1. Command related to SET TAPEALERTMSG

Command	Description
---------	-------------

Command	Description
QUERY TAPEALERTMSG	Displays whether the server logs hardware diagnostic information.

## SET TOCLOADRETENTION (Set load retention period for table of contents)

Use this command to specify the approximate number of minutes that unreferenced table of contents data will remain loaded in the server database.

During NDMP-controlled backup operations of NAS file systems, the server can optionally collect information about files and directories in the image and store this information in a table of contents within a storage pool. The web client can be used to examine files and directories in one or more file-system images by displaying entries from the table of contents data. The server loads the necessary table of contents data into a temporary database table.

Once the data have been loaded, the user can then select those files and directories to be restored. Because this database table is temporary, the data will only remain loaded for a specified time since the last reference to that data. At installation, the retention time is set to 120 minutes. Use the QUERY STATUS command to see the table of contents load retention time.

### Privilege class

To issue this command you must have system privilege.

### Syntax

```
>>-Set TOCLOADRetention--minutes-----<<
```

### Parameters

minutes (Required)

Specifies the approximate number of minutes that an unreferenced table of contents data is retained in the database. You can specify an integer from 30 to 1000.

### Example: Define the load retention period for the table of contents

Use the command, SET TOCLOADRETENTION, to specify that unreferenced table of contents data is to be retained in the database for 45 minutes.

```
set toclloadretention 45
```

### Related commands

Table 1. Commands related to SET TOCLOADRETENTION

Command	Description
QUERY STATUS	Displays the settings of server parameters, such as those selected by the SET commands.

## SET VMATRISKINTERVAL (Specifies the at-risk mode for an individual VM filespace)

Use this command to adjust the at-risk evaluation mode for an individual VM filespace.

### Privilege class

To issue this command, you must have system privilege, policy privilege for the domain to which the node is assigned, or client owner authority over the node.

## Syntax

```
>>---Set VMATRISKINTERVAL--node_name--fsid----->>  
>--TYPE---+--DEFAULT---+-------+----->>  
      +-BYPASSED+  '-Interval---value-'  
      '-CUSTOM---'
```

## Parameters

node\_name (Required)

Specifies the name of the client node, that owns the VM filespace, that you want to update.

fsid (Required)

Specifies the filespace ID of the client node that you want to update.

TYPE (Required)

Specifies which at-risk evaluation mode the status monitor should use when evaluating the at-risk classification for the specified nodes VM filespace. Specify one of the following values:

DEFAULT

Specifies that the VM filespace is evaluated with the same interval that was specified for the SET STATUSATRISKINTERVAL command.

BYPASSED

Specifies that the VM filespace is not evaluated for at-risk status by the status monitor. The at-risk status is also reported as bypassed to the Operations Center.

CUSTOM

Specifies that the VM filespace is evaluated with the specified interval, rather than the interval that was specified for the SET STATUSATRISKINTERVAL command.

Interval

Specifies the amount of time, in hours, between client backup activity before the status monitor considers the client to be at risk. You can specify an integer in the range 6 - 8808. You must specify this parameter when TYPE = CUSTOM. You do not specify this parameter when TYPE = BYPASSED or TYPE = DEFAULT. The interval value for all client types is set to 24 at server installation.

## Set node name to use a custom 90 day at-risk interval

Set the at-risk interval for a node named *charlievm* (filespace ID 50) on datacenter node named *alice* to use a 90 day at-risk interval. You can issue the QUERY FILESPACE command to determine the filespace ID for the VM.

```
set vmatriskinterval alice 50 type=custom interval=2160
```

## Bypass the at-risk interval evaluation

Exclude the VM called *davevm* (filespace ID 213) on datacenter node named *erin* from at-risk interval checking. You can issue the QUERY FILESPACE command to determine the filespace ID for the VM called *davevm*. Then set the at-risk interval check for the VM as bypassed.

```
set vmatriskinterval erin 213 type=bypassed
```

## Related commands

Table 1. Commands related to set vmatriskinterval

Command	Description
SET STATUSATRISKINTERVAL (Specifies whether to enable client at-risk activity interval evaluation)	Specifies whether to enable client at-risk activity interval evaluation
SET NODEATRISKINTERVAL (Specifies at-risk mode for an individual node)	Sets the at-risk mode and interval for a node



Command	Description
QUERY MONITORSTATUS (Query the monitoring status)	Displays information about monitoring alerts and server status settings.
QUERY MONITORSETTINGS (Query the configuration settings for monitoring alerts and server status)	Displays information about monitoring alerts and server status settings.
SET STATUSMONITOR (Specifies whether to enable status monitoring)	Specifies whether to enable status monitoring.
SET STATUSREFRESHINTERVAL (Set refresh interval for status monitoring)	Specifies the refresh interval for status monitoring.
SET STATUSSKIPASFAILURE (Specifies whether to use client at-risk skipped files as failure evaluation)	Specifies whether to use client at-risk skipped files as failure evaluation
QUERY NODE (Query nodes)	Displays partial or complete information about one or more clients.
QUERY FILESPACE (Query one or more file spaces)	Displays information about data in file spaces that belong to a client.

## SETOPT (Set a server option for dynamic update)

You can use the SETOPT command to update most server options dynamically without stopping and restarting the server. For the DBDIAGLOGSIZE option, you must stop and start the server. A SETOPT command contained in a macro or a script cannot be rolled back.

### Privilege class

To issue this command, you must have system privilege.

### Syntax

```
>>-SETOPT--option_name--option_value-----<<
```

### Parameters

option\_name (Required)

Specifies a text string of information identifying the server option to be updated. The maximum length of the text string is 255 characters. The following options are available:

- ADMINCOMMTIMEOUT
- ADMINIDLETIMEOUT
- ALLOWREORGINDEX
- ALLOWREORGTABLE
- ARCHLOGCOMPRESS
- BACKUPINITIATIONROOT
- CHECKTAPEPOS
- CLIENTDEDUPTXNLIMIT
- COMMTIMEOUT
-  DATEFORMAT
- DBDIAGLOGSIZE
- DBDIAGPATHFSTHRESHOLD
- DEDUPTIER2FILESIZE
- DEDUPTIER3FILESIZE
- DEDUPREQUIRESBACKUP
- DNSLOOKUP
- EXPINTERVAL
- EXPQUIET
- FSUSEDTHRESHOLD

- IDLETimeout
- LDAPCACHEDURATION
- MAXSessions
- MOVEBatchsize
- MOVESizethresh
- NDMPPREFDATAINTERFACE
- **Windows** NUMBERFORMAT
- NUMOPENVOLsallowed
- RECLAIMDELAY
- RECLAIMPERIOD
- REORGBEGINTime
- REORGDURation
- RESOURCETimeout
- RESTOREINTERVAL
- RETENTIONEXTENSION
- **AIX** **Linux** **Windows** SANDISCOVERY
- **AIX** **Linux** **Windows** SANREFRESHTIME
- SERVERDEDUPTXNlimit
- SHREDding
- **Windows** TCPPORT
- THROUGHPUTDatathreshold
- THROUGHPUTTimethreshold
- **Windows** TIMEFORMAT
- TXNGroupmax

option\_value (Required)

Specifies the value for the server option.

## Example: Set the maximum number of client sessions

Update the server option for the maximum number of client sessions to a value of 40.

```
setopt maxsessions 40
```

## Related commands

Table 1. Commands related to SETOPT

Command	Description
QUERY OPTION	Displays information about server options.
QUERY SYSTEM	Displays details about the IBM Spectrum ProtectIBM Spectrum Protect™ server system.

## SHRED DATA (Shred data)

Use this command to manually start the process of shredding deleted sensitive data. Manual shredding is possible only if automatic shredding is disabled.

You can control automatic shred processing with the SHREDDING server option.

This command creates a background process that can be canceled with the CANCEL PROCESS command. To display information on background processes, use the QUERY PROCESS command.

If data from a storage pool that enforces shredding is deleted while a manual shredding process is running, it will be added to the running process.

## Privilege class

To issue this command you must have system privilege.

## Syntax



Command	Description
QUERY PROCESS	Displays information about background processes.
QUERY SHREDSTATUS	Displays information about data waiting to be shredded.

## SUSPEND EXPORT (Suspend a currently running export operation)

Use this command to suspend a currently running server-to-server export operation which has a FILEDATA value that is not NONE. The export operation that you want to suspend must be past the initialization phase to be eligible for suspension. The state of the export operation is saved. The operation can be restarted by issuing the RESTART EXPORT command.

### Privilege class

You must have system privilege to issue this command.

### Syntax

```
>>-SUSPend EXPORT +-----+----->>
                    .-*-----*
                    '---export_identifier---'
```

### Parameters

#### EXPORTIdentifier

This optional parameter specifies the name of the export operation. You can find a name by issuing the QUERY EXPORT command to list all the currently running server-to-server export operations that can be suspended. You can also use the wildcard character to specify the name.

### Example: Suspend a specific export operation

Suspend the running export operation EXPORTALLACCTNODES. No output is generated when you issue the SUSPEND EXPORT command. You must issue the QUERY EXPORT command to verify that the EXPORTALLACCTNODES operation is suspended.

```
suspend export exportallacctnodes
```

### Example: Suspend all running export operations

Suspend all the export operations with a state of RUNNING.

```
suspend export *
```

### Related commands

Table 1. Commands related to SUSPEND EXPORT

Command	Description
CANCEL EXPORT	Deletes a suspended export operation.
EXPORT NODE	Copies client node information to external media or directly to another server.
EXPORT SERVER	Copies all or part of the server to external media or directly to another server.
QUERY EXPORT	Displays the export operations that are currently running or suspended.
RESTART EXPORT	Restarts a suspended export operation.

## UNLOCK commands

---

Use the UNLOCK commands to reestablish access after an object was locked.

- UNLOCK ADMIN (Unlock an administrator)
- UNLOCK NODE (Unlock a client node)
- UNLOCK PROFILE (Unlock a profile)

## UNLOCK ADMIN (Unlock an administrator)

---

Use the UNLOCK ADMIN command to allow a locked administrator to access the server again. You can also unlock multiple administrators that authenticate with the same method.

### Privilege class

---

To issue this command, you must have system privilege.

### Syntax

---

```
>>-UNLOCK Admin--+-*-----+--+-----+--><
                '-admin_name-'  '-AUTHentication-----Local--'
                                '-LDap--'
```

### Parameters

---

admin\_name (Required)

Specifies the name of the administrator to unlock. You can use wildcard characters to specify the administrator name. You do not have to enter an administrator name if you want to unlock all of the administrators according to their method of authentication. Use the wildcard with an authentication method to unlock multiple administrators. The parameter is required (no default wildcard).

AUTHentication

Specifies the method of password authentication that is needed for an administrator to log on.

Local

Specifies that you want to unlock administrator user IDs that authenticate passwords with the IBM Spectrum Protect™ server.

LDap

Specifies that you want to unlock administrator user IDs that authenticate passwords with an LDAP directory server.

### Example: Unlock an administrator user ID

---

The administrator user ID JOE is locked out of IBM Spectrum Protect. Allow JOE to access the server. Issue the following command:

```
unlock admin joe
```

### Example: Unlock all administrator user IDs that authenticate passwords with an LDAP directory server

---

The administrator user ID that use passwords that authenticate with an LDAP directory server must be unlocked so the IDs can communicate with the IBM Spectrum Protect server.

```
unlock admin * authentication=ldap
```

### Related commands

---

Table 1. Commands related to UNLOCK ADMIN

Command	Description
LOCK ADMIN	Prevents an administrator from accessing IBM Spectrum Protect.

Command	Description
QUERY ADMIN	Displays information about one or more IBM Spectrum Protect administrators.

## UNLOCK NODE (Unlock a client node)

Use this command to allow a locked client node to access the server again. You can also unlock multiple nodes that use the same method of authentication.

### Privilege class

To issue this command, you must have system privilege, unrestricted policy privilege, or restricted policy privilege for the policy domain to which the client node is assigned.

### Syntax

```
>>-UNLOCK Node--+*-----+-----+><
                '-node_name-' '-AUTHentication-----+Local--'
                                     '-LDap--'
```

### Parameters

node\_name (Required)

Specifies the name of the client node to unlock. You can use wildcard characters to specify the node name. You do not have to enter a node name if you want to unlock all of the nodes according to their method of authentication. Use the wildcard with an authentication method to unlock groups of nodes. The parameter is required. There is no default wildcard character available.

AUTHentication

Specifies the node password authentication method. This parameter is optional.

Local

Specifies that you want to unlock nodes that authenticate passwords with the IBM Spectrum Protect™ server.

LDap

Specifies that you want to unlock nodes that authenticate passwords with an LDAP directory server.

### Example: Unlock a node

The client node SMITH is locked out of IBM Spectrum Protect. Allow SMITH to access the server.

```
unlock node smith
```

### Example: Unlock all nodes that authenticate with the IBM Spectrum Protect server

The nodes that are not authenticating passwords with LDAP directory servers must be unlocked.

```
unlock node * authentication=local
```

### Related commands

Table 1. Commands related to UNLOCK NODE

Command	Description
LOCK NODE	Prevents a client from accessing the server.
QUERY NODE	Displays partial or complete information about one or more clients.

## UNLOCK PROFILE (Unlock a profile)

Use this command on a configuration manager to unlock a configuration profile so it can be distributed to subscribing managed servers.

## Privilege class

---

To issue this command, you must have system privilege.

## Syntax

---

```
>>-UNLOCK PROFILE--profile_name-----><
```

## Parameters

---

profile\_name (Required)  
Specifies the profile to unlock. You can use wildcard characters to indicate multiple names.

## Example: Unlock a profile

---

Unlock a profile named TOM.

```
unlock profile tom
```

## Related commands

---

Table 1. Commands related to UNLOCK PROFILE

Command	Description
COPY PROFILE	Creates a copy of a profile.
DEFINE PROFASSOCIATION	Associates objects with a profile.
DEFINE PROFILE	Defines a profile for distributing information to managed servers.
DELETE PROFASSOCIATION	Deletes the association of an object with a profile.
DELETE PROFILE	Deletes a profile from a configuration manager.
LOCK PROFILE	Prevents distribution of a configuration profile.
QUERY PROFILE	Displays information about configuration profiles.
SET CONFIGMANAGER	Specifies whether a server is a configuration manager.
UPDATE PROFILE	Changes the description of a profile.

## UPDATE commands

---

Use the UPDATE command to modify one or more attributes of an existing IBM Spectrum Protect™ object.

- UPDATE ADMIN (Update an administrator)
- UPDATE ALERTTRIGGER (Update a defined alert trigger)
- UPDATE ALERTSTATUS (Update the status of an alert)
- UPDATE BACKUPSET (Update a retention value assigned to a backup set)
- UPDATE CLIENTOPT (Update a client option sequence number)
- UPDATE CLOPTSET (Update a client option set description)
- UPDATE COLLOCGROUP (Update a collocation group)
- UPDATE COPYGROUP (Update a copy group)
- UPDATE DATAMOVER (Update a data mover)
- UPDATE DEVCLASS (Update the attributes of a device class)
- UPDATE DOMAIN (Update a policy domain)
- UPDATE DRIVE (Update a drive)
- UPDATE FILESPACE (Update file-space node-replication rules)





Specify one of the following values:

**APplication**

Alert is classified as application category. For example, you can specify this category for messages that are associated with application (TDP) clients.

**INventory**

Alert is classified as inventory category. For example, you can specify this category for messages that are associated with the database, active log file, or archive log file.

**CLient**

Alert is classified as client category. For example, you can specify this category for messages that are associated with general client activities.

**DEvice**

Alert is classified as device category. For example, you can specify this category for messages that are associated with device classes, libraries, drives, or paths.

**SErver**

Alert is classified as general server category. For example, you can specify this category for messages that are associated with general server activities or events.

**STorage**

Alert is classified as storage category. For example, you can specify this category for messages that are associated with storage pools.

**SYstems**

Alert is classified under system clients category. For example, you can specify this category for messages that are associated with system backup and archive or hierarchical storage management (HSM) backup-archive clients.

**VMclient**

Alert is classified under VMclient category. For example, you can specify this category for messages that are associated with virtual machine clients.

**ADmin**

This optional parameter specifies the name of the administrator who receives email notification of this alert. The alert trigger is defined successfully even if no administrator names are specified.

**ADDadmin**

Specifies the administrator name that you want to add to the list of administrators that receive email alerts. Specify multiple administrator names, which are separated by commas, and no intervening spaces.

**DELadmin**

Specifies the administrator name that you want to delete from the list of administrators that receive email alerts. Specify multiple administrator names, which are separated by commas, and no intervening spaces.

## Update alert trigger

---

Add the names of the administrators that want to be notified when ANR1073E, ANR1074E alerts occur, and also delete the name of an administrator that no longer wants to be notified, by issuing the following command:

```
update alerttrigger ANR1073E,ANR1074E ADDadmin=djee,cdawson,mhaye deladmin=harryh
```

## Related commands

---

Table 1. Commands related to UPDATE ALERTTRIGGER

Command	Description
DEFINE ALERTTRIGGER (Define an alert trigger)	Associates specified messages to an alert trigger.
DELETE ALERTTRIGGER (Remove a message from an alert trigger)	Removes a message number that can trigger an alert.
QUERY ALERTSTATUS (Query the status of an alert)	Displays information about alerts that have been issued on the server.
QUERY ALERTTRIGGER (Query the list of defined alert triggers)	Displays message numbers that trigger an alert.
QUERY MONITORSETTINGS (Query the configuration settings for monitoring alerts and server status)	Displays information about monitoring alerts and server status settings.
UPDATE ALERTSTATUS (Update the status of an alert)	Updates the status of a reported alert.

# UPDATE ALERTSTATUS (Update the status of an alert)

---

Use this command to update the status of a reported alert.

## Privilege class

---

Any administrator can issue this command.

## Syntax

---

```
          .-,------.
          v          |
>>-UPDate ALERTStatus-----+--alert_id+----->
>--+-----+-----+-----+----->
  '-Status-----+Inactive-+-'  '-ASSigned-----text-'
          '-Closed---'
>--+-----+-----+-----+----->>
  '-RESolvedby-----text-'  '-REMark-----text-'
```

## Parameters

---

### alert\_id (Required)

Specifies the alert that you want to update. You can specify multiple message numbers by separating them with commas and no intervening spaces.

### SStatus

Specifies the status type that you want to update. Alerts can be changed from active to inactive or closed, or from inactive to closed. Possible values are:

#### Inactive

Active alerts can be changed to inactive status.

#### Closed

Active and inactive alerts can be changed to closed status.

### ASSigned

Specifies the administrator name that is assigned the alert that you want to query.

### RESolvedby

Specifies the administrator name that resolved the alert that you want to query.

### REMark

This parameter specifies comment text. The comment text cannot exceed 255 characters. If the description contains any blank spaces, enclose the entire text in quotation marks ("""). Remove previously defined text by specifying a null string (""") for this value.

## Update the comment text in an alert

---

Issue the following command to update the comment text for alert ID number 25 and indicate that *DJADMIN* is working on the alert:

```
update alertstatus 25 assigned=DJADMIN
```

## Update alert status

---

Issue the following command to change alert ID number 72 to the closed status, and add a remark about how the alert was resolved:

```
update alertstatus 72 status=closed remark="Increased the file system size for
the active log"
```

## Related commands

---

Table 1. Commands related to UPDATE ALERTSTATUS

Command	Description
DEFINE ALERTTRIGGER (Define an alert trigger)	Associates specified messages to an alert trigger.
DELETE ALERTTRIGGER (Remove a message from an alert trigger)	Removes a message number that can trigger an alert.
QUERY ALERTSTATUS (Query the status of an alert)	Displays information about alerts that have been issued on the server.
QUERY ALERTTRIGGER (Query the list of defined alert triggers)	Displays message numbers that trigger an alert.
QUERY MONITORSETTINGS (Query the configuration settings for monitoring alerts and server status)	Displays information about monitoring alerts and server status settings.
UPDATE ALERTTRIGGER (Update a defined alert trigger)	Updates the attributes of one or more alert triggers.

## UPDATE ADMIN (Update an administrator)

Use this command to change the password or contact information for an administrator. However, you cannot update the SERVER\_CONSOLE administrator name.

**AIX** | **Linux** Passwords for administrators must be changed after a length of time that is determined by the SET PASSEXP command. The SET PASSEXP command does not affect passwords that authenticate with a Lightweight Directory Access Protocol (LDAP) server.

Restriction: You cannot update the authentication method for your own user ID. If necessary, another administrator must make that change. Also, when you update a password with the UPDATE ADMIN command, you cannot use a wildcard with the `admin_name` parameter.

Administrators with the same name as a node can be created during a REGISTER NODE command. To keep the node and administrator with the same name synchronized, the authentication method and the SSLREQUIRED setting for the node are updated to match the administrator. If the administrator authentication method is changed from LOCAL to LDAP and a password is not provided, the node is put in "LDAP pending" status. A password is then requested at the next logon. Passwords between same-named nodes and administrators are kept in sync through any authentication change.

You must use the RENAME ADMIN command to change the name of a registered administrator.

For users of Lightweight Directory Access Protocol (LDAP) servers:

- The information in this documentation applies to the LDAP authentication method that is preferred for IBM Spectrum Protect™ V7.1.7 or later servers. For instructions about using the previous LDAP authentication method, see Managing passwords and logon procedures.
- If an administrative user ID matches a node name, do not update the authentication method to LDAP. If you do, you might see unexpected behavior because of automatic password changes that update the same password twice. As a result, the password might become unknown to the administrative user ID. Alternatively, the password update operation might fail.

## Privilege class

To issue this command to change another administrator password or contact information, you must have system privilege. Any administrator can issue this command to update his or her own password or contact information.

## Syntax

```

>>-UPDate Admin-----admin_name----->
                                     '-password-'
>--+-----+-----+-----+----->
   '-PASSExp----days-'   '-CONTACT----text-'
>--+-----+-----+-----+----->
   '-FORCEPwreset----+No--+-'
                               '-Yes-'
>--+-----+-----+-----+----->

```



#### EMAILAddress

This parameter is used for additional contact information. The information that is specified by this parameter is not acted upon by IBM Spectrum Protect.

#### AUTHentication

This parameter determines the password authentication method that the administrator ID uses; either LDAP or LOCAL.

#### Local

Specifies that the administrator uses the local IBM Spectrum Protect server database to store passwords for authentication.

#### LDap

Specifies that the administrator uses an LDAP directory server for password authentication.

#### SYNCLdapdelete

This parameter applies only if an administrator who authenticates to an LDAP server wants to revert to local authentication.

#### Yes

Specifies that the administrator is deleted from the LDAP server.

Restriction: Do not specify a value of YES. (The value of YES is appropriate only for users of the previous LDAP authentication method, which is described in Managing passwords and logon procedures.)

#### No

Specifies that the administrator is not deleted from the LDAP server. This is the default.

#### SSLrequired (deprecated)

Specifies whether the administrator user ID must use the Secure Sockets Layer (SSL) protocol to communicate between the IBM Spectrum Protect server and the backup-archive client. When you authenticate passwords with an LDAP directory server, you must protect the sessions by using SSL or another network security method.

Important: Beginning with IBM Spectrum Protect Version 8.1.2, this parameter is deprecated. Validation that was enabled by this parameter is replaced by the TLS 1.2 protocol, which is enforced by the SESSIONSECURITY parameter. The SSLREQUIRED parameter is ignored. Update your configuration to use the SESSIONSECURITY parameter.

#### SESSIONSECurity

Specifies whether the administrator must use the most secure settings to communicate with an IBM Spectrum Protect server. This parameter is optional.

You can specify one of the following values:

#### STRict

Specifies that the strictest security settings are enforced for the administrator. The STRICT value uses the most secure communication protocol available, which is currently TLS 1.2. The TLS 1.2 protocol is used for SSL sessions between the server and the administrator. To specify whether the server uses TLS 1.2 for the entire session or only for authentication, see the SSL client option.

To use the STRICT value, the following requirements must be met to ensure that the administrator can authenticate with the server:

- Both the administrator and server must be using IBM Spectrum Protect software that supports the SESSIONSECURITY parameter.
- The administrator must be configured to use the TLS 1.2 protocol for SSL sessions between the server and the administrator.

Administrators set to STRICT that do not meet these requirements are unable to authenticate with the server.

#### TRANSitional

Specifies that the existing security settings are enforced for the administrator. This is the default value. This value is intended to be used temporarily while you update your security settings to meet the requirements for the STRICT value.

If SESSIONSECURITY=TRANSITIONAL and the administrator has never met the requirements for the STRICT value, the administrator will continue to authenticate by using the TRANSITIONAL value. However, after an administrator meets the requirements for the STRICT value, the SESSIONSECURITY parameter value automatically updates from TRANSITIONAL to STRICT. Then, the administrator can no longer authenticate by using a version of the client or an SSL/TLS protocol that does not meet the requirements for STRICT. In addition, after an administrator successfully authenticates by using a more secure communication protocol, the administrator can no longer authenticate by using a less secure protocol. For example, if an administrator that is not using SSL is updated and successfully authenticates by using TLS 1.2, the administrator can no longer authenticate by using no SSL protocol or TLS 1.1.

This restriction also applies when you use functions such as command routing or server-to-server export, when the administrator authenticates to the IBM Spectrum Protect server as an administrator from another server.

#### ALert

Specifies whether alerts are sent to an administrators email address.

#### Yes

Specifies that alerts are sent to the specified administrators email address.

#### No

Specifies that alerts are not sent to the specified administrators email address. This is the default value.

Tip: Alert monitoring must be enabled, and email settings must be correctly defined to successfully receive alerts by email. To view the current settings, issue the QUERY MONITORSETTINGS command.

## Example: Update a password and password expiration period

Update the administrator LARRY to have the password SECRETWORD and a password expiration period of 120 days. The administrator in this example is authenticated to the IBM Spectrum Protect server.

```
update admin larry secretword passexp=120
```

## Example: Update all administrators to communicate with a server by using strict session security

Update all administrators to use the strictest security settings to authenticate with the server.

```
update admin * sessionsecurity=strict
```

## Related commands

Table 1. Commands related to UPDATE ADMIN

Command	Description
QUERY ADMIN	Displays information about one or more IBM Spectrum Protect administrators.
QUERY STATUS	Displays the settings of server parameters, such as those selected by the SET commands.
QUERY MONITORSETTINGS (Query the configuration settings for monitoring alerts and server status)	Displays information about monitoring alerts and server status settings.
REGISTER ADMIN	Defines a new administrator without granting administrative authority.
REGISTER NODE	Defines a client node to the server and sets options for that user.
RENAME ADMIN	Changes an IBM Spectrum Protect administrator's name.
SET PASSEXP	Specifies the number of days after which a password is expired and must be changed.
UPDATE NODE	Changes the attributes that are associated with a client node.

#### Related tasks:

Naming Tivoli Storage Manager objects

#### Related information:

Ssl client option

## UPDATE BACKUPSET (Update a retention value assigned to a backup set)

Use this command to update the retention value associated with a client's backup set.

## Privilege class

To issue this command, you must have system privilege or policy privilege for the domain to which the client node is assigned.

## Syntax

```
.-,-,-----
V
>>-UPDate BACKUPSET-----+node_name-----+----->
                          '-node_group_name-'

.-,-,-----
V
>----backup_set_name+---RETention---+days---+----->
                          '-NOLimit-'

>--+-----+-----+----->
  '-BEGINDate---date-'  '-BEGINTime---time-'

>--+-----+-----+----->
  '-ENDDate---date-'  '-ENDTime---time-'

>--+-----+-----+----->
  '-WHERERETention---+days---+-'
                          '-NOLimit-'

.-,-----
>--+-----+----->
|                                     .-,-,-----
|                                     V
|                                     +FILE--+-----'
|                                     '-IMAGE-'

>--+-----+-----+----->
  '-WHEREDEscription---description-'

.-,-----
>--+-----+-----+-----><
  '-Preview---No---+'  '-VERsion---+Any---+-'
                          '-Yes-'                          '-Latest-'
```

## Parameters

node\_name or node\_group\_name (Required)

Specifies the names of the client nodes or node groups whose data is contained in the specified backup set to be updated. To specify multiple node and node group names, separate the names with commas and no intervening spaces. The node names that you specify can contain wildcard characters, but node group names cannot contain wildcard characters.

backup\_set\_name (Required)

Specifies the name of the backup set to update. The backup set name you specify can contain wildcard characters. You can specify more than one backup set name by separating the names with commas and no intervening spaces.

RETention (Required)

Specifies the updated number of days to retain the backup set on the server. You can specify an integer from 0 to 30000. The values are:

days

Specifies the updated number of days to retain the backup set.

NOLimit

Specifies that the backup set is retained on the server indefinitely. If you specify NOLIMIT, the server retains the volumes containing the backup set forever, unless a user or administrator deletes the volumes from server storage. Attention: Updating the retention period of a backup set may cause it to expire at a different time from other backup sets that might be stored on the same output media. In either case, the media will not be made available for other uses until all of its backup sets have expired.

BEGINDate

Specifies the beginning date in which the backup set to update was created. This parameter is optional. The default is the current date. You can use this parameter with the BEGINTIME parameter to specify a range for the date and time. If you specify a begin date without a begin time, the time will be at 12:00 a.m. (midnight) on the date you specify. You can specify the date by using one of the following values:

<b>Value</b>	<b>Description</b>	<b>Example</b>
MM/DD/YYYY	A specific date	09/15/1999
TODAY	The current date	TODAY
TODAY+days <i>or</i> +days	The current date plus days specified.	TODAY +3 <i>or</i> +3.
TODAY-days <i>or</i> -days	The current date minus days specified.	TODAY-3 <i>or</i> -3.
EOLM (End Of Last Month)	The last day of the previous month.	EOLM
EOLM-days	The last day of the previous month minus days specified.	EOLM-1  To include files that were active a day before the last day of the previous month.
BOTM (Beginning Of This Month)	The first day of the current month.	BOTM
BOTM+days	The first day of the current month, plus days specified.	BOTM+9  To include files that were active on the 10th day of the current month.

#### BEGINTime

Specifies the beginning time in which the backup set to update was created. This parameter is optional. The default is the current time. You can use this parameter with the BEGINDATE parameter to specify a range for the date and time. If you specify a begin time without a begin date, the date will be the current date at the time you specify.

You can specify the time by using one of the following values:

<b>Value</b>	<b>Description</b>	<b>Example</b>
HH:MM:SS	A specific time	10:30:08
NOW	The current time	NOW
NOW+HH:MM <i>or</i> +HH:MM	The current time plus hours and minutes on the specified end date	NOW+02:00 <i>or</i> +02:00.
NOW-HH:MM <i>or</i> -HH:MM	The current time minus hours and minutes on the specified end date	NOW-02:00 <i>or</i> -02:00.

#### ENDDate

Specifies the ending date in which the backup set to update was created. This parameter is optional. You can use this parameter with the ENDTIME parameter to specify a range for the date and time. If you specify an end date without an ending time, the time will be at 11:59:59 p.m. on the specified end date.

You can specify the date by using one of the following values:

<b>Value</b>	<b>Description</b>	<b>Example</b>
MM/DD/YYYY	A specific date	09/15/1999
TODAY	The current date	TODAY
TODAY+days <i>or</i> +days	The current date plus days specified.	TODAY +3 <i>or</i> +3.
TODAY-days <i>or</i> - days	The current date minus days specified.	TODAY -3 <i>or</i> -3.
EOLM (End Of Last Month)	The last day of the previous month.	EOLM
EOLM-days	The last day of the previous month minus days specified.	EOLM-1  To include files that were active a day before the last day of the previous month.
BOTM (Beginning Of This Month)	The first day of the current month.	BOTM



Value	Description	Example
BOTM+days	The first day of the current month, plus days specified.	BOTM+9  To include files that were active on the 10th day of the current month.

#### ENDTime

Specifies the ending time in which the backup set to update was created. This parameter is optional. You can use this parameter with the ENDDATE parameter to specify a range for the date and time. If you specify an end time without an end date, the date will be the current date at the time you specify.

You can specify the time by using one of the following values:

Value	Description	Example
HH:MM:SS	A specific time	10:30:08
NOW	The current time	NOW
NOW+HH:MM <i>or</i> +HH:MM	The current time plus hours and minutes specified	NOW+02:00 <i>or</i> +02:00.
NOW-HH:MM <i>or</i> -HH:MM	The current time minus hours and minutes specified	NOW-02:00 <i>or</i> -02:00.

#### WHERERetention

Specifies the retention value, specified in days, that is associated with the backup set to update. The values are:

days

Specifies that the backup set that is retained this number of days is updated.

NOLimit

Specifies that the backup set retained indefinitely is updated.

#### WHEREDescription

Specifies the description that is associated with the backup set to update. This parameter is optional. You can specify wildcard characters for the description. Enclose the description in quotation marks if it contains any blank characters.

#### WHEREDataType

Specifies the backup sets containing the specified types of data are to be updated. This parameter is optional. The default is that backup sets for all types of data (file level, image, and application) are to be updated. To specify multiple data types, separate each data type with a comma and no intervening spaces. Possible values are:

ALL

Specifies that backup sets for all types of data (file level, image, and application) are to be updated. This is the default.

FILE

Specifies that a file level backup set is to be updated. File level backup sets contain files and directories backup up by the backup-archive client.

IMAGE

Specifies that an image backup set is to be updated. Image backup sets contain images created by the backup-archive client BACKUP IMAGE command.

#### Preview

Specifies whether to preview the list of backup sets to update, without actually updating the backup sets. This parameter is optional. The default is No. The values are:

No

Specifies that the backup sets are updated.

Yes

Specifies that the server displays the backup sets to update, without actually updating the backup sets.

#### VERSION

Specifies the version of the backup set to update. Backup sets with the same prefix name are considered to be different versions of the same backup set. This parameter is optional. The default is to update any version that matches the criteria specified on the command. The values are:

Any

Specifies that any version that matches the criteria specified on the command should be updated.

## Latest

Specifies that only the most recent version of the backup set should be updated. If other criteria specified on the command (for example, ENDDATE or WHERERETENTION) exclude the most recent version of the backup set, then no backup set will be updated.

## Example: Update a retention period

---

Update the retention period where the description is Healthy Computers. The retention period is assigned to backup set PERS\_DATA.3099 that contains data from client node JANE. Change the retention period to 70 days.

```
update backupset jane pers_data.3099
retention=70 wheredescription="healthy computers"
```

## Related commands

---

Table 1. Commands related to UPDATE BACKUPSET

Command	Description
DEFINE BACKUPSET	Defines a previously generated backup set to a server.
DEFINE NODEGROUP	Defines a group of nodes.
DEFINE NODEGROUPMEMBER	Adds a client node to a node group.
DELETE BACKUPSET	Updates a retention value associated with a backup set.
DELETE NODEGROUP	Deletes a node group.
DELETE NODEGROUPMEMBER	Deletes a client node from a node group.
GENERATE BACKUPSET	Generates a backup set of a client's data.
GENERATE BACKUPSETTOC	Generates a table of contents for a backup set.
QUERY BACKUPSET	Displays backup sets.
QUERY BACKUPSETCONTENTS	Displays contents contained in backup sets.
QUERY NODEGROUP	Displays information about node groups.
UPDATE NODEGROUP	Updates the description of a node group.

## UPDATE CLIENTOPT (Update a client option sequence number)

---

Use this command to update the sequence number of a client option in a client option set.

### Privilege class

---

To issue this command, you must have system privilege or unrestricted policy privilege.

### Syntax

---

```
>>-UPDate CLIENTOpt--option_set_name--option_name----->
>>-current_sequence_number--new_sequence_number-----><
```

### Parameters

---

- option\_set\_name (Required)  
Specifies the name of the option set.
- option\_name (Required)  
Specifies a valid client option.
- current\_sequence\_number (Required)  
Specifies the current sequence number of the option.

new\_sequence\_number (Required)  
Specifies the new sequence number of the option.

## Example: Update a client option sequence number

---

To update the current client option sequence number issue the following command:

```
update clientopt eng dateformat 0 9
```

## Related commands

---

Table 1. Commands related to UPDATE CLIENTOPT

Command	Description
COPY CLOPTSET	Copies a client option set.
DEFINE CLIENTOPT	Adds a client option to a client option set.
DELETE CLIENTOPT	Deletes a client option from a client option set.
DELETE CLOPTSET	Deletes a client option set.
QUERY CLOPTSET	Displays information about a client option set.

## UPDATE CLOPTSET (Update a client option set description)

---

Use this command to update the description for a client option set.

## Privilege class

---

To issue this command, you must have system privilege, unrestricted policy privilege, or restricted policy privilege for the policy domain to which the client node is assigned.

## Syntax

---

```
>>-UPDate CLOptset--option_set_name----->  
>--DESCription----description-----<
```

## Parameters

---

option\_set\_name (Required)  
Specifies the name of the option set.

DESCription (Required)  
Specifies a description of the client option set. The maximum length of the description is 255 characters. Enclose the description in quotation marks if it contains blank characters.

## Example: Update a client option set description

---

Update the description for a client option set named ENG.

```
update cloptset eng description="unix"
```

## Related commands

---

Table 1. Commands related to UPDATE CLOPTSET

Command	Description
COPY CLOPTSET	Copies a client option set.
DEFINE CLIENTOPT	Adds a client option to a client option set.
DEFINE CLOPTSET	Defines a client option set.

Command	Description
DELETE CLIENTOPT	Deletes a client option from a client option set.
DELETE CLOPTSET	Deletes a client option set.
QUERY CLOPTSET	Displays information about a client option set.
UPDATE CLIENTOPT	Updates the sequence number of a client option in a client option set.

## UPDATE COLLOGROUP (Update a collocation group)

Use this command to modify the description of a collocation group.

### Privilege class

To issue this command, you must have system or unrestricted storage privilege.

### Syntax

```
>>-UPDate COLLOGGroup--group_name----->
>>-DESCRiption---description-----<
```

### Parameters

group\_name

Specifies the name of the collocation group whose description you want to update.

DESCRiption (Required)

Specifies a description of the collocation group. This parameter is required. The maximum length of the description is 255 characters. If the description contains any blanks, enclose the entire description in quotation marks.

### Example: Update a collocation group

Update the collocation group, GROUP1, with a new description.

```
update collogroup group1 "Human Resources"
```

### Related commands

Table 1. Commands related to UPDATE COLLOGROUP

Command	Description
DEFINE COLLOGROUP	Defines a collocation group.
DEFINE COLLOCMEMBER	Adds a client node or file space to a collocation group.
DEFINE STGPOOL	Defines a storage pool as a named collection of server storage media.
DELETE COLLOGROUP	Deletes a collocation group.
DELETE COLLOCMEMBER	Deletes a client node or file space from a collocation group.
MOVE NODEDATA	Moves data for one or more nodes, or a single node with selected file spaces.
QUERY COLLOGROUP	Displays information about collocation groups.
QUERY NODE	Displays partial or complete information about one or more clients.
QUERY NODEDATA	Displays information about the location and size of data for a client node.

Command	Description
QUERY STGPOOL	Displays information about storage pools.
REMOVE NODE	Removes a client from the list of registered nodes for a specific policy domain.
UPDATE STGPOOL	Changes the attributes of a storage pool.

## UPDATE COPYGROUP (Update a copy group)

Use this command to update a backup or archive copy group. To allow clients to use the updated copy group, you must activate the policy set that contains the copy group.

Tip: The UPDATE COPYGROUP command fails if you specify a copy storage pool as a destination.

The UPDATE COPYGROUP command takes two forms, depending upon whether the update is for a backup copy group or for an archive copy group. The syntax and parameters for each form are defined separately.

Table 1. Commands related to UPDATE COPYGROUP

Command	Description
ACTIVATE POLICYSET	Validates and activates a policy set.
ASSIGN DEFMGMTCLASS	Assigns a management class as the default for a specified policy set.
COPY MGMTCLASS	Creates a copy of a management class.
DEFINE COPYGROUP	Defines a copy group for backup or archive processing within a specified management class.
DEFINE MGMTCLASS	Defines a management class.
DELETE COPYGROUP	Deletes a backup or archive copy group from a policy domain and policy set.
DELETE MGMTCLASS	Deletes a management class and its copy groups from a policy domain and policy set.
EXPIRE INVENTORY	Manually starts inventory expiration processing.
QUERY COPYGROUP	Displays the attributes of a copy group.
QUERY MGMTCLASS	Displays information about management classes.

- UPDATE COPYGROUP (Update a backup copy group)  
Use this command to update a defined backup copy group.
- UPDATE COPYGROUP (Update a defined archive copy group)  
Use this command to update a defined archive copy group.

## UPDATE COPYGROUP (Update a backup copy group)

Use this command to update a defined backup copy group.

### Privilege class

To issue this command, you must have system privilege, unrestricted policy privilege, or restricted policy privilege for the policy domain to which the copy group belongs.

### Syntax

```
>>-UPDate COpYgroup--domain_name--policy_set_name--class_name-->
>--+-----+-----+-----+-----+----->
  '-STANDARD-'  '-Type-----Backup-'
```

```

>---+-----+-----+-----+-----+-----+-----+----->
  '-DESTination-----pool_name-'  '-FREQuency-----days-'
>---+-----+-----+-----+-----+-----+-----+----->
  '-VERExists-----+number--+-'
                        '-NOLimit-'
>---+-----+-----+-----+-----+-----+-----+----->
  '-VERDeleted-----+number--+-'
                        '-NOLimit-'
>---+-----+-----+-----+-----+-----+-----+----->
  '-RETEExtra-----+days---+-'  '-RETOOnly-----+days---+-'
                        '-NOLimit-'                        '-NOLimit-'
>---+-----+-----+-----+-----+-----+-----+----->
  '-MODE-----+MODified--+-'
                        '-ABSolute-'
>---+-----+-----+-----+-----+-----+-----+----->
  '-SERialization-----+SHRStatic---+'
                        +-Static-----+
                        +-SHRDYnamic--+
                        '-DYnamic----+'
>---+-----+-----+-----+-----+-----+-----+-----><
  '-TOCDestination-----pool_name---'

```

## Parameters

domain\_name (Required)

Specifies the policy domain to which the copy group belongs.

policy\_set\_name (Required)

Specifies the policy set to which the copy group belongs. You cannot update a copy group in the ACTIVE policy set.

class\_name (Required)

Specifies the management class to which the copy group belongs.

STANDARD

Specifies the copy group, which must be STANDARD. This parameter is optional.

Type=Backup

Specifies that you want to update a backup copy group. This parameter is optional.

DESTination

Specifies the primary storage pool where the server initially stores backup data. This parameter is optional. You cannot specify a copy storage pool as the destination.

FREQuency

Specifies how frequently the server can back up a file. This parameter is optional. The server backs up a file only when the specified number of days has elapsed since the last backup. The FREQUENCY value is used only during a full incremental backup operation. This value is ignored during selective backup or partial incremental backup. You can specify an integer from 0 to 9999. The value 0 means that the server can back up a file regardless of when the file was last backed up.

VERExists

Specifies the maximum number of backup versions to retain for files that are currently on the client file system. This parameter is optional.

If an incremental backup causes the limit to be exceeded, the server expires the oldest backup version that exists in server storage. Possible values are:

number

Specifies the number of backup versions to retain for files that are currently on the client file system. You can specify an integer from 1 to 9999.

NOLimit

Specifies that you want the server to retain all backup versions.

The number of backup versions to retain is controlled by this parameter until versions exceed the retention time specified by the RETEXTRA parameter.

VERDeleted

Specifies the maximum number of backup versions to retain for files that have been deleted from the client file system after being backed up using the server. This parameter is optional.

If a user deletes a file from the client file system, the next incremental backup causes the server to change the active backup version of the file to inactive and expire the oldest versions in excess of this number. The expiration date for the remaining versions is determined by the retention time specified by the RETEXTRA or RETONLY parameter. Possible values are:

number

Specifies the number of backup versions to retain for files that are deleted from the client file system after being backed up. You can specify a value from 0 to 9999.

NOLimit

Specifies that you want the server to retain all backup versions for files that are deleted from the client file system after being backed up.

RETEExtra

Specifies the number of days that the server retains a backup version after that version becomes inactive. A version of a file becomes inactive when the client stores a more recent backup version, or when the client deletes the file from the workstation and then runs a full incremental backup. The server deletes inactive versions based on retention time even if the number of inactive versions does not exceed the number allowed by the VEREXISTS or VERDELETED parameters. This parameter is optional. Possible values are:

days

Specifies the number of days to retain inactive backup versions. You can specify an integer from 0 to 9999.

NOLimit

Specifies that you want to retain inactive backup versions indefinitely.

If you specify NOLIMIT, the server deletes extra backup versions based on the VEREXISTS parameter (when the file still exists on the client file system) or the VERDELETED parameter (when the file no longer exists on the client file system).

RETOOnly

Specifies the number of days to retain the last backup version of a file that has been deleted from the client file system. This parameter is optional. Possible values are:

days

Specifies the number of days to retain the last remaining inactive copy of a file. You can specify an integer from 0 to 9999.

NOLimit

Specifies that you want to keep the last remaining inactive version of a file indefinitely.

If you specify NOLIMIT, the server retains the last remaining backup version forever, unless a user or administrator deletes the file from server storage.

MODE

Specifies whether the server backs up a file only if the file has changed since the last backup, or whenever a client requests a backup. This parameter is optional. Possible values are:

MODified

Specifies that the file is backed up only if it has changed since the last backup. A file is considered changed if any of the following is true:

- The date last modified is different
- The file size is different
- The file owner is different
- The file permissions are different

ABSolute

Specifies that the file is backed up regardless of whether it has been changed.

The MODE value is used only for full incremental backup. This value is ignored during partial incremental backup or selective backup.

SERialization

Specifies how the server processes files or directories when they are modified during backup processing. This parameter is optional. Possible values are:

#### SHRStatic

Specifies that the server backs up a file or directory only if it is not being modified during backup. The server attempts to perform a backup as many as four times, depending on the value specified for the CHANGINGRETRIES client option. If the file or directory is modified during each backup attempt, the server does not back it up.

#### Static

Specifies that the server backs up a file or directory only if it is not being modified during backup. The server attempts to perform the backup only once.

Platforms that do not support the STATIC option default to SHRSTATIC.

#### SHRDynamic

Specifies that if the file or directory is being modified during a backup attempt, the server backs up the file or directory during the last attempt even though the file or directory is being modified. The server attempts to perform a backup as many as four times, depending on the value specified for the CHANGINGRETRIES client option.

#### Dynamic

Specifies that the server backs up a file or directory on the first attempt, regardless of whether the file or directory is being modified during backup processing.

**Important:** Be careful about using the SHR DYNAMIC and DYNAMIC values. IBM Spectrum Protect™ uses these values to determine if it backs up a file or directory while modifications are occurring. As a result, the backup version might be a fuzzy backup. A fuzzy backup does not accurately reflect what is currently in the file or directory because it contains some, but not all, modifications. If a file that contains a fuzzy backup is restored, the file may or may not be usable, depending on the application that uses the file. If a fuzzy backup is not acceptable, set SERIALIZATION to SHRSTATIC or STATIC so that IBM Spectrum Protect creates a backup version only if the file or directory is not being modified.

#### TOCDestination

Specifies the primary storage pool in which a table of contents (TOC) will initially be stored for any NDMP backup or backup set operation for which a TOC is generated. This parameter is optional. You cannot specify a copy storage pool as the destination. The storage pool specified for the destination must have NATIVE or NONBLOCK data format. To avoid mount delays, it is recommended that the storage pool have a device class of DISK or DEVTYPE=FILE. TOC generation is an option for NDMP backup operations, but is not supported for other image-backup operations.

To remove an existing TOC destination from the copy group, specify a null string ("" ) for this value.

If TOC creation is requested for a backup operation that uses NDMP and the image is bound to a management class whose backup copy group does not specify a TOC destination, the outcome will depend on the TOC parameter for the backup operation.

- If TOC=PREFERRED (the default), the backup proceeds without creation of a TOC.
- If TOC=YES, the entire backup fails because no TOC can be created.

## Example: Update a backup copy group

---

Update the backup copy group (STANDARD) in the EMPLOYEE\_RECORDS policy domain, VACATION policy set, ACTIVEFILES management class. Change the destination to DISKPOOL, with a minimum interval of seven days between backups, regardless of whether the files have been modified. Retain up to three backup versions while a file still exists on a client file system.

```
update copygroup employee_records vacation
activefiles type=backup destination=diskpool
frequency=7 verexists=3 mode=absolute
```

## UPDATE COPYGROUP (Update a defined archive copy group)

---

Use this command to update a defined archive copy group.

### Privilege class

---

To issue this command, you must have system privilege, unrestricted policy privilege, or restricted policy privilege for the policy domain to which the copy group belongs.

### Syntax

---

```
>>-UPDate COpYgroup--domain_name--policy_set_name--class_name-->
```



```

>---+-----+---Type---+---Archive----->
    '-STANDARD-'
>---+-----+-----+-----+----->
    '-DESTINATION---+pool_name-' '-FREQUENCY---+Cmd-'
>---+-----+-----+-----+----->
    '-RETVer---+days---+' '-MODE---+ABSolute-'
        '-NOLimit-'
>---+-----+----->
    '-RETMIn---+days---'
>---+-----+-----><
    '-SERialization---+SHRStatic---+'
        '+STatic-----+'
        '+SHRDYnamic---+'
        '-DYnamic-----+'

```

## Parameters

domain\_name (Required)

Specifies the policy domain to which the copy group belongs.

policy\_set\_name (Required)

Specifies the policy set to which the copy group belongs. You cannot update a copy group in the ACTIVE policy set.

class\_name (Required)

Specifies the management class to which the copy group belongs.

STANDARD

Specifies the copy group, which must be STANDARD. This parameter is optional.

Type=Archive (Required)

Specifies that you want to update an archive copy group. This parameter is required.

DESTINATION

Specifies the primary storage pool where the server initially stores the archive copy. This parameter is optional. You cannot specify a copy storage pool as the destination.

FREQUENCY=Cmd

Specifies the copy frequency, which must be CMD. This parameter is optional.

RETVer

Specifies the number of days to keep an archive copy. This parameter is optional. Possible values are:

days

Specifies the number of days to keep an archive copy. You can specify an integer from 0 to 30000.

NOLimit

Specifies that you want to keep an archive copy indefinitely.

If you specify NOLIMIT, the server retains archive copies forever, unless a user or administrator deletes the file from server storage.

The value of the RETVER parameter can affect the management class to which the server binds an archived directory. If the client does not use the ARCHMC option, the server binds directories that are archived to the default management class. If the default management class has no archive copy group, the server binds directories that are archived to the management class with the shortest retention period.

MODE=ABSolute

Specifies that a file is always archived when the client requests it. The MODE must be ABSOLUTE. This parameter is optional.

RETMIn

Specifies the minimum number of days to keep an archive copy after it has been archived. This parameter is optional. The default value is 365.

SERialization

Specifies how the server processes files that are modified during archive. This parameter is optional. Possible values are:

SHRStatic

Specifies that the server does not archive a file that is being modified. The server attempts to perform an archive as many as four times, depending on the value specified for the CHANGINGRETRIES client option. If the file is modified

during the archive attempt, the server does not archive the file.

#### Static

Specifies that the server does not archive a file that is being modified. If a file is modified during the archive attempt, the server does not archive the file.

Platforms that do not support the STATIC option default to SHRSTATIC.

#### SHRDynamic

Specifies that if the file is being modified during an archive attempt, the server archives the file during its last attempt even though the file is being modified. The server attempts to archive the file as many as four times, depending on the value specified for the CHANGINGRETRIES client option.

#### Dynamic

Specifies that the server archives a file on the first attempt, regardless of whether the file is being modified during archive processing.

Important: Be careful about using the SHRDYNAMIC and DYNAMIC values. IBM Spectrum Protect™ uses them to determine if it archives a file while modifications are occurring. As a result, the archive copy might be a fuzzy backup. A fuzzy backup does not accurately reflect what is currently in the file because it contains some, but not all, modifications. If a file that contains a fuzzy backup is retrieved, the file may or may not be usable, depending on the application that uses the file. If a fuzzy backup is not acceptable, set SERIALIZATION to SHRSTATIC or STATIC so that IBM Spectrum Protect creates an archive copy only if the file is not being modified.

Tip: Be cautious when selecting retention values for primary storage pools that are of type RECLAMATIONTYPE=SNAPLOCK. Volumes in these types of storage pools cannot be deleted until after their retention dates have passed.

## Example: Update multiple elements of a copy group

---

Update the archive copy group (STANDARD) in the EMPLOYEE\_RECORDS policy domain, VACATION policy set, ACTIVEFILES management class. Change the destination to TAPEPOOL. Keep archive copies for 190 days.

```
update copygroup employee_records vacation
activefiles standard type=archive
destination=tapepool retver=190
```

## UPDATE DATAMOVER (Update a data mover)

---

Use this command to update the definition for a data mover or set a data mover off-line when the hardware is being maintained.

### Privilege class

---

To issue this command, you must have system privilege or unrestricted storage privilege.

### Syntax

---

```
>>-UPDate DATAMover--data_mover_name----->
>--+-----+--+-----+----->
  '-HLAddress----address-'  '-LLAddress----tcp_port-'
>--+-----+--+-----+----->
  '-USERid----userid-'  '-PASsword----password-'
>--+-----+-----><
  '-ONLine----+Yes-+-'
                   '-No--'
```

### Parameters

---

data\_mover\_name (Required)  
Specifies the name of the data mover.

HLAddress

Specifies either the new numerical IP address or the new domain name, which is used to access the NAS file server. This parameter is optional.

**LLAddress**

Specifies the new TCP port number to access the NAS file server for Network Data Management Protocol (NDMP) sessions. This parameter is optional.

**USERid**

Specifies the user ID for a user that is authorized to initiate an NDMP session with the NAS file server. For example, enter the administrative ID for a NetApp file server. This parameter is optional.

**PASsword**

Specifies the new password for the user ID to log onto the NAS file server. This parameter is optional.

**ONLine**

Specifies whether the data mover is available for use. This parameter is optional.

**Yes**

Specifies that the data mover is available for use.

**No**

Specifies that the data mover is not available for use.

Attention: If a library is controlled using a path from a data mover to the library, and the data mover is offline, the server will not be able to access the library. If the server is halted and restarted while the data mover is offline, the library will not be initialized.

## Example: Update a data mover IP address

Update the data mover for the node named NAS1. Change the numerical IP address from 9.67.97.103 to 9.67.97.109.

```
update datamover nas1 hladdress=9.67.97.109
```

## Example: Update a data mover domain name

Update the data mover for the node named NAS1. Change the numerical IP address from 9.67.97.109 to the domain name of NETAPP2.TUCSON.IBM.COM.

```
update datamover nas1 hladdress=netapp2.tucson.ibm.com
```

## Related commands

Table 1. Commands related to UPDATE DATAMOVER

Command	Description
DEFINE DATAMOVER	Defines a data mover to the IBM Spectrum Protect server.
DEFINE PATH	Defines a path from a source to a destination.
DELETE DATAMOVER	Deletes a data mover.
QUERY DATAMOVER	Displays data mover definitions.
REGISTER NODE	Defines a client node to the server and sets options for that user.
UPDATE NODE	Changes the attributes that are associated with a client node.

## UPDATE DEVCLASS (Update the attributes of a device class)

Use this command to update a defined device class.

Note: The DISK device class is predefined by IBM Spectrum Protect™ and cannot be modified with the UPDATE DEVCLASS command.

**AIX** | **Linux** If you are updating a device class for devices that are to be accessed through a z/OS® media server, see UPDATE DEVCLASS - z/OS media server (Update device class for z/OS media server).

The syntax and parameter descriptions are provided according to the device type. The syntax and parameter information is presented in the following order.

- UPDATE DEVCLASS (Update a 3590 device class)
- UPDATE DEVCLASS (Update a 3592 device class)
- UPDATE DEVCLASS (Update a 4MM device class)
- UPDATE DEVCLASS (Update an 8MM device class)
- UPDATE DEVCLASS (Update a CENTERA device class)
- UPDATE DEVCLASS (Update a DLT device class)
- UPDATE DEVCLASS (Update an ECARTRIDGE device class)
- UPDATE DEVCLASS (Update a FILE device class)
- **AIX** | **Windows** UPDATE DEVCLASS (Update a GENERICTAPE device class)
- UPDATE DEVCLASS (Update an LTO device class)
- UPDATE DEVCLASS (Update a NAS device class)
- UPDATE DEVCLASS (Update a REMOVABLEFILE device class)
- UPDATE DEVCLASS (Update a SERVER device class)
- UPDATE DEVCLASS (Update a VOLSAFE device class)

Table 1. Commands related to UPDATE DEVCLASS

Command	Description
BACKUP DEVCONFIG	Backs up IBM Spectrum Protect device information to a file.
DEFINE DEVCLASS	Defines a device class.
DEFINE LIBRARY	Defines an automated or manual library.
DELETE DEVCLASS	Deletes a device class.
QUERY DEVCLASS	Displays information about device classes.
QUERY DIRSPACE	Displays information about FILE directories.
UPDATE LIBRARY	Changes the attributes of a library.

## UPDATE DEVCLASS (Update a 3590 device class)

Use the 3590 device class when you are using 3590 tape devices.

**AIX** | **Linux** If you are defining a device class for devices that are to be accessed through a z/OS® media server, see UPDATE DEVCLASS (Update a 3590 device class for z/OS media server).

### Privilege class

To issue this command, you must have system privilege or unrestricted storage privilege.

### Syntax

```
>>-UPDate DEVclass--device_class_name----->
>--+-----+--+-----+----->
  '-LIBRARY---library_name-' '-FORMAT---+DRIVE---+'
                                     +-3590B---+
                                     +-3590C---+
                                     +-3590E-B-+
                                     +-3590E-C-+
                                     +-3590H-B-+
                                     '-3590H-C-'
>--+-----+----->
  '-ESTCAPacity---size-'
>--+-----+----->
  '-PREFIX---+ADSM-----+'
                '-tape_volume_prefix-'
>--+-----+--+-----+----->
  '-MOUNTRetention---minutes-' '-MOUNTWait---minutes-'
>--+-----+-----<<
```

```
'-MOUNTLimit-----DRIVES-+-'
      +-number-+
      '-0-----'
```

## Parameters

**device\_class\_name** (Required)

Specifies the name of the device class to be defined.

**LIBRARY**

Specifies the name of the defined library object that contains the tape drives that can be used by this device class.

This parameter is optional.

For information about defining a library object, see the DEFINE LIBRARY command.

**FORMAT**

Specifies the recording format to be used when data is written to sequential access media. This parameter is optional.

If the drives are in a library that includes drives of different tape technology, do not use the DRIVE value. Use the specific format that the drives use.

The following tables list the recording formats, estimated capacities, and recording format options for 3590 devices:

Table 1. Recording formats and default estimated capacities for 3590

Format	Estimated Capacity	Description
DRIVE	–	The server selects the highest format that is supported by the drive on which a volume is mounted. Attention: Avoid specifying DRIVE when a mixture of drives is used within the same library. For example, do not use this option for a library that contains some drives that support recording formats superior to other drives.
3590B	10.0 GB	Uncompressed (basic) format
3590C	See note 20.0 GB	Compressed format
3590E-B	10.0 GB	Uncompressed (basic) format, similar to the 3590B format
3590E-C	See note 20.0 GB	Compressed format, similar to the 3590C format
3590H-B	30.0 GB (J cartridge- standard length) 60.0 GB (K cartridge- extended length)	Uncompressed (basic) format, similar to the 3590B format
3590H-C	See note 60.0 GB (J cartridge- standard length) 120.0 GB (K cartridge- extended length)	Compressed format, similar to the 3590C format

Note: If this format uses the tape drive hardware compression feature, depending on the effectiveness of compression, the actual capacity might be greater than the listed value.

Table 2. 3590 device recording format selections

Device	Format					
	3590B	3590C	3590E-B	3590E-C	3590H-B	3590H-C

Device	Format					
	3590B	3590C	3590E-B	3590E-C	3590H-B	3590H-C
3590	Read/Write	Read/Write	–	–	–	–
Ultra-SCSI	Read/Write	Read/Write	–	–	–	–
3590E	Read	Read	Read/Write	Read/Write	–	–
3590H	Read	Read	Read	Read	Read/Write	Read/Write

#### ESTCAPacity

Specifies the estimated capacity for the sequential access volumes that are categorized by this device class. This parameter is optional.

You can specify this parameter if the default estimated capacity for the device class is inaccurate due to compression of data.

You must specify this value as an integer followed by one of the following unit indicators: **K** (kilobytes), **M** (megabytes), **G** (gigabytes), or **T** (terabytes). The smallest value that is accepted is 1 MB (ESTCAPACITY=1M).

For example, specify that the estimated capacity is 9 GB with the parameter ESTCAPACITY=9G.

To force the IBM Spectrum Protect™ server to determine the estimated capacity for the volumes that are assigned to this device class, specify ESTCAPACITY="".

#### PREFIX

Specifies the high-level qualifier of the data set name that the server writes into the sequential access media labels. For each sequential access volume assigned to this device class, the server uses this prefix to create the data set name. This parameter is optional. The maximum length of this prefix is 8 characters.

If you have a naming convention for media labels to support your current management system, use a volume prefix that conforms to your naming conventions.

Values that are specified for this parameter must meet the following conditions:

- The value is to be made up of qualifiers, which can be a maximum of eight characters including periods. For example, the following value is acceptable:

AB.CD2.E

- The qualifiers must be separated by a single period.
- The first letter of each qualifier must be alphabetic or national (@,#,\$), followed by alphabetic, national, hyphen, or numeric characters.

An example of a tape volume data set name using the default prefix is ADSM.BFS.

#### MOUNTRetention

Specifies the number of minutes that an idle sequential access volume is retained before it is dismounted. This parameter is optional. You can specify a number 0 - 9999.

This parameter can improve response time for sequential access media mounts by leaving previously mounted volumes online.

However, for EXTERNAL library types, setting this parameter to a low value (for example, two minutes) enhances device sharing between applications.

Note: For environments in which devices are shared across storage applications, the MOUNTRETENTION setting must be carefully considered. This parameter determines how long an idle volume remains in a drive. Some media managers do not dismount an allocated drive to satisfy pending requests. You might need to tune this parameter to satisfy competing mount requests while maintaining optimal system performance. Typically, problems arise more frequently when the MOUNTRETENTION parameter is set to a value that is too small, for example, zero.

#### MOUNTWait

Specifies the maximum number of minutes the server waits for an operator to respond to a request to either mount a volume in a drive in a manual library or check in a volume to be mounted in an automated library. This parameter is optional. If the mount request is not satisfied within the specified amount of time, the mount request is canceled. You can specify a number 0 - 9999.

Restriction: If the library that is associated with this device class is external (LIBTYPE=EXTERNAL), do not specify the MOUNTWAIT parameter.

#### MOUNTLimit

Specifies the maximum number of sequential access volumes that can be simultaneously mounted for the device class. This parameter is optional. You can specify a number 0 - 4096.

If you plan to use the simultaneous-write function, ensure that sufficient drives are available for the write operation. If the number of drives needed for a simultaneous-write operation is greater than the value of the MOUNTLIMIT parameter for a device class, the transaction fails.

The following are possible values:

#### DRIVES

Specifies that every time a mount point is allocated, the number of drives that are defined and online in the library is used to calculate the true value.

Note: For EXTERNAL library types, do not specify DRIVES for the MOUNTLIMIT value. Specify the number of drives for the library as the MOUNTLIMIT value.

#### number

Specifies the maximum number of drives in this device class that are used concurrently by the server. This value must never exceed the number of drives that are defined and online in the library that services this device class.

#### 0 (zero)

Specifies that no new transactions can gain access to the storage pool. Any current transactions continue and complete, but new transactions are terminated.

## UPDATE DEVCLASS (Update a 3592 device class)

**AIX** | **Linux** If you are defining a device class for devices that are to be accessed through a z/OS® media server, see UPDATE DEVCLASS (Update a 3592 device class for z/OS media server).

### Privilege class

To issue this command, you must have system privilege or unrestricted storage privilege.

### Syntax

```
>>-UPDate DEVclass--device_class_name----->
>--+-----+----->
  '-LIBRARY---library_name-'
>--+-----+----->
  '-LBProtect---+READWrite+-'
                    +-WRITEOnly+
                    '-No-----'
>--+-----+-----+----->
  '-SCALECAPacity---+100+-'  '-FORMAT---+DRIVE---+'
                    +-90---+          +-3592----+
                    '-20--'          +-3592C---+
                                   +-3592-2---+
                                   +-3592-2C-+
                                   +-3592-3---+
                                   +-3592-3C-+
                                   +-3592-4---+
                                   '-3592-4C-'
>--+-----+----->
  '-ESTCAPacity---size-'
>--+-----+----->
  '-PREFIX---+ADSM-----+'
                    '-tape_volume_prefix-'
>--+-----+-----+----->
  '-MOUNTRetention---minutes-'  '-MOUNTWait---minutes-'
```

```

>-----+----->
'-MOUNTLimit-----+DRIVES-+-'
      +-number-+
      '-0-----'

>-----+-----<<
| (1) (2) |
|-----DRIVEEncryption-----+ON-----+|
      +-ALLOW-----+
      +-EXTERNAL-+
      '-OFF-----'

```

#### Notes:

1. You cannot specify both WORM=Yes and DRIVEENCRYPTION=ON.
2. Drive encryption is supported only for 3592 Generation 2 or later drives.

## Parameters

---

#### device\_class\_name (Required)

Specifies the name of the device class to be updated. The maximum length of the device class name is 30 characters.

#### LIBRARY

Specifies the name of the defined library object that contains the tape drives that can be used by this device class.

This parameter is optional.

For information about defining a library object, see the DEFINE LIBRARY command.

#### LBProtect

Specifies whether logical block protection is used to ensure the integrity of data stored on tape. When LBPROTECT is set to READWRITE or to WRITEONLY, the server uses this feature of the tape drive for logical block protection and generates cyclic redundancy check (CRC) protection information for each data block written on tape. The server also validates the CRC protection information when data is read from the tape.

The following values are possible:

##### READWrite

Specifies that logical block protection is enabled in the server and the tape drive for both read and write operations. Data is stored with CRC information in each block. This mode affects performance because additional processor usage is required for IBM Spectrum Protect™ and the tape drive to calculate and compare CRC values. The READWRITE value does not affect backup sets and data that is generated by the BACKUP DB command.

When the LBPROTECT parameter is set to READWRITE, you do not have to specify the CRCDATA parameter in a storage pool definition because logical block protection provides better protection against data corruption.

##### WRITEOnly

Specifies that logical block protection is enabled in the server and the tape drive for write operations only. Data is stored containing CRC information in each block. For read operations, the server and the tape drive do not validate the CRC. This mode affects performance because additional processor usage is required for IBM Spectrum Protect to generate the CRC and for the tape drive to calculate and compare CRC values for write operations. The WRITEONLY value does not affect backup sets and data that are generated by the BACKUP DB command.

##### No

Specifies that logical block protection is not enabled in the server and the tape drive for read and write operations. However, the server enables logical block protection on write operations for a filling volume that already has data with logical block protection.

**Restriction:** Logical block protection is supported only on IBM® 3592 Generation 3 drives and later with 3592 Generation 2 media and later.

See Technote 1634851, Additional information on the Tivoli Storage Manager LBProtect option, for an explanation about when to use the LBProtect parameter.

#### SCALECAPacity



Specifies the percentage of the media capacity that can be used to store data. This parameter is optional. Possible values are 20, 90, or 100.

Setting the scale capacity percentage to 100 provides maximum storage capacity. Setting it to 20 provides fastest access time.

Note: The scale capacity value takes effect when data is first written to a volume. Any updates to the device class for scale capacity do not affect volumes that already have data that is written to them until the volume is returned to scratch status.

#### FORMAT

Specifies the recording format to be used when data is written to sequential access media. This parameter is optional.

If the drives are in a library that includes drives of different tape technology, do not use the DRIVE value. Use the specific format that the drives use.

The following table lists the recording formats, estimated capacities, and recording format options for 3592 devices:

**Table 1. Recording formats and default estimated capacities for 3592**

<b>Format</b>	<b>Estimated Capacity</b>	<b>Description</b>
DRIVE	–	The server selects the highest format that is supported by the drive on which a volume is mounted. Attention: Avoid specifying DRIVE when a mixture of drives is used within the same library. For example, do not use this option for a library that contains some drives that support recording formats superior to other drives.
3592	300 GB	Uncompressed (basic) format
3592C	See note 900 GB	Compressed format
3592-2	500 GB 700 GB	Uncompressed (basic) format JA tapes Uncompressed (basic) format JB tapes
3592-2C	1.5 TB 2.1 TB	Compressed format JA tapes Compressed format JB tapes
3592-3	640 GB 1 TB	Uncompressed (basic) format JA tapes Uncompressed (basic) format JB tapes
3592-3C	1.9 TB 3 TB	Compressed format JA tapes Compressed format JB tapes
3592-4	400 GB 1.5 TB 3.1 TB	Uncompressed (basic) format JK tapes Uncompressed (basic) format JB tapes Uncompressed (basic) format JC tape
3592-4C	1.2 TB 4.4 TB 9.4 TB	Compressed format JK tapes Compressed format JB tapes Compressed format JC tapes
Note: If this format uses the tape-drive hardware-compression feature, depending on the effectiveness of compression, the actual capacity might be different from the listed value.		

Important: For optimal performance, avoid mixing different generations of drives in a single SCSI library.

Special configurations are also required for mixing different generations of 3592 drives in 349x and ACSLS libraries.

#### ESTCAPacity

Specifies the estimated capacity for the volumes that are assigned to this device class. This parameter is optional.

You can specify this parameter if the default estimated capacity for the device class is inaccurate due to compression of data.

You must specify this value as an integer followed by one of the following unit indicators: **K** (kilobytes), **M** (megabytes), **G** (gigabytes), or **T** (terabytes). The smallest value that is accepted is 1 MB (ESTCAPACITY=1M).

For example, specify that the estimated capacity is 9 GB with the parameter ESTCAPACITY=9G.

To force the IBM Spectrum Protect server to determine the estimated capacity for the volumes that are assigned to this device class, specify ESTCAPACITY="".

#### PREFIX

Specifies the high-level qualifier of the data set name that the server writes into the sequential access media labels. For each sequential access volume assigned to this device class, the server uses this prefix to create the data set name. This parameter is optional. The maximum length of this prefix is 8 characters.

If you have a naming convention for media labels to support your current management system, use a volume prefix that conforms to your naming conventions.

Values that are specified for this parameter must meet the following conditions:

- The value is to be made up of qualifiers, which can be a maximum of eight characters including periods. For example, the following value is acceptable:

AB.CD2.E

- The qualifiers must be separated by a single period.
- The first letter of each qualifier must be alphabetic or national (@,#,\$), followed by alphabetic, national, hyphen, or numeric characters.

An example of a tape volume data set name using the default prefix is ADSM.BFS.

#### MOUNTRetention

Specifies the number of minutes that an idle sequential access volume is retained before it is dismounted. This parameter is optional. You can specify a number 0 - 9999.

This parameter can improve response time for sequential access media mounts by leaving previously mounted volumes online.

However, for EXTERNAL library types, setting this parameter to a low value (for example, two minutes) enhances device sharing between applications.

**Note:** For environments in which devices are shared across storage applications, the MOUNTRETENTION setting must be carefully considered. This parameter determines how long an idle volume remains in a drive. Some media managers do not dismount an allocated drive to satisfy pending requests. You might need to tune this parameter to satisfy competing mount requests while maintaining optimal system performance. Typically, problems arise more frequently when the MOUNTRETENTION parameter is set to a value that is too small, for example, zero.

#### MOUNTWait

Specifies the maximum number of minutes the server waits for an operator to respond to a request to either mount a volume in a drive in a manual library or check in a volume to be mounted in an automated library. This parameter is optional. If the mount request is not satisfied within the specified amount of time, the mount request is canceled. You can specify a number 0 - 9999.

**Restriction:** If the library that is associated with this device class is external (LIBTYPE=EXTERNAL), do not specify the MOUNTWAIT parameter.

#### MOUNTLimit

Specifies the maximum number of sequential access volumes that can be simultaneously mounted for the device class. This parameter is optional. You can specify a number 0 - 4096.

If you plan to use the simultaneous-write function, ensure that sufficient drives are available for the write operation. If the number of drives needed for a simultaneous-write operation is greater than the value of the MOUNTLIMIT parameter for a device class, the transaction fails.

The following are possible values:

#### DRIVES

Specifies that every time a mount point is allocated, the number of drives that are defined and online in the library is used to calculate the true value.

**Note:** For EXTERNAL library types, do not specify DRIVES for the MOUNTLIMIT value. Specify the number of drives for the library as the MOUNTLIMIT value.

number

Specifies the maximum number of drives in this device class that are used concurrently by the server. This value must never exceed the number of drives that are defined and online in the library that services this device class.

0 (zero)

Specifies that no new transactions can gain access to the storage pool. Any current transactions continue and complete, but new transactions are terminated.

DRIVEEncryption

Specifies whether drive encryption is allowed. This parameter is optional.

Updating this parameter affects empty volumes only. If a filling volume was previously encrypted or is unencrypted, and you update the DRIVEENCRYPTION parameter, the volume maintains its original encrypted or unencrypted status. The filling volume also maintains its original key-management status.

ON

Specifies that IBM Spectrum Protect is the key manager for drive encryption and allows drive encryption for empty storage pool volumes only if the application method is enabled. (Other types of volumes—for example, back up sets, export volumes, and database backup volumes—will not be encrypted.) If you specify ON and you enable either the library or system method of encryption, drive encryption is not allowed and backup operations fail.

ALLOW

Specifies that IBM Spectrum Protect does not manage the keys for drive encryption. However, drive encryption for empty volumes is allowed if either the library or system method of encryption is enabled.

EXTERNAL

Specifies that IBM Spectrum Protect does not manage the keys for drive encryption. Use this setting with an encryption methodology that is provided by another vendor and that is used with Application Method Encryption (AME) enabled on the drive.

When you specify EXTERNAL and IBM Spectrum Protect detects that AME encryption is enabled, IBM Spectrum Protect does not turn off encryption.

By contrast, when you specify ALLOW and IBM Spectrum Protect detects that AME encryption is enabled, IBM Spectrum Protect turns off encryption.

OFF

Specifies that drive encryption is not allowed. If you enable either the library or system method of encryption, backups fail. If you enable the application method, IBM Spectrum Protect disables encryption and backups are attempted.

## UPDATE DEVCLASS (Update a 4MM device class)

---

Use the 4MM device class when you are using 4 mm tape devices.

### Privilege class

---

To issue this command, you must have system privilege or unrestricted storage privilege.

### Syntax

---

```
>>-UPDate DEVclass--device_class_name----->
>--+-----+-----+-----+-----+----->
  '-LIBRARY----library_name-'  '-FORMAT-----+--DRIVE-+-'
                                     +-DDS1--+
                                     +-DDS1C-+
                                     +-DDS2--+
                                     +-DDS2C-+
                                     +-DDS3--+
                                     +-DDS3C-+
                                     +-DDS4--+
                                     +-DDS4C-+
                                     +-DDS5--+
                                     +-DDS5C-+
                                     +-DDS6--+
                                     '-DDS6C-'
>--+-----+-----+-----+-----+----->
  '-ESTCAPacity----size-'
```

```

>-----+-----+----->
'-PREFIX-----+ADSM-----+-'
      '-tape_volume_prefix-'

>-----+-----+----->
'-MOUNTWait-----minutes-' '-MOUNTRetention-----minutes-'

>-----+-----+-----><
'-MOUNTLimit-----+DRIVES--+-'
      '+-number-+'
      '-0-----'

```

## Parameters

device\_class\_name (Required)

Specifies the name of the device class to be defined.

LIBRARY

Specifies the name of the defined library object that contains the 4 mm tape drives used by this device class. This parameter is optional. For information about defining a library object, see the DEFINE LIBRARY command.

FORMAT

Specifies the recording format to be used when data is written to sequential access media. This parameter is optional.

If the drives are in a library that includes drives of different tape technology, do not use the DRIVE value. Use the specific format that the drives use.

The following table lists the recording formats and estimated capacities for 4 mm devices:

Table 1. Recording formats and default estimated capacities for 4 mm tapes

Format	Estimated Capacity	Description
DRIVE	–	The server selects the highest format that is supported by the drive on which a volume is mounted. Attention: Avoid specifying DRIVE when a mixture of drives is used within the same library. For example, do not use this option for a library that contains some drives that support recording formats superior to other drives.
DDS1	1.3 GB (60 meter) 2.0 GB (90 meter)	Uncompressed format, applies only to 60-meter and 90-meter tapes
DDS1C	See note 1.3 GB (60 meter) 2.0 GB (90 meter)	Compressed format, applies only to 60-meter and 90-meter tapes
DDS2	4.0 GB	Uncompressed format, applies only to 120-meter tapes
DDS2C	See note 8.0 GB	Compressed format, applies only to 120-meter tapes
DDS3	12.0 GB	Uncompressed format, applies only to 125-meter tapes
DDS3C	See note 24.0 GB	Compressed format, applies only to 125-meter tapes
DDS4	20.0 GB	Uncompressed format, applies only to 150-meter tapes
DDS4C	See note 40.0 GB	Compressed format, applies only to 150-meter tapes
DDS5	36 GB	Uncompressed format, when using DAT 72 media
DDS5C	See note 72 GB	Compressed format, when using DAT 72 media

Format	Estimated Capacity	Description
DDS6	80 GB	Uncompressed format, when using DAT 160 media
DDS6C	See note 160 GB	Compressed format, when using DAT 160 media
Note: If this format uses the tape drive hardware compression feature, depending on the effectiveness of compression, the actual capacity might be greater than the listed value.		

#### ESTCAPacity

Specifies the estimated capacity for the sequential access volumes that are categorized by this device class. This parameter is optional.

You can specify this parameter if the default estimated capacity for the device class is inaccurate due to compression of data.

You must specify this value as an integer followed by one of the following unit indicators: **K** (kilobytes), **M** (megabytes), **G** (gigabytes), or **T** (terabytes). The smallest value that is accepted is 1 MB (ESTCAPACITY=1M).

For example, specify that the estimated capacity is 9 GB with the parameter ESTCAPACITY=9G.

To force the IBM Spectrum Protect™ server to determine the estimated capacity for the volumes that are assigned to this device class, specify ESTCAPACITY="".

For more information about the default estimated capacity for 4 mm tapes, see Table 1.

#### PREFIX

Specifies the high-level qualifier of the file name that the server writes into the sequential access media labels. For each sequential access volume assigned to this device class, the server uses this prefix to create the data set name. This parameter is optional. The maximum length of this prefix is 8 characters.

If you have a naming convention for media labels to support your current management system, use a volume prefix that conforms to your naming conventions.

Values that are specified for this parameter must meet the following conditions:

- The value is to be made up of qualifiers, which can be a maximum of eight characters including periods. For example, the following value is acceptable:

AB.CD2.E

- The qualifiers must be separated by a single period.
- The first letter of each qualifier must be alphabetic or national (@,#,\$), followed by alphabetic, national, hyphen, or numeric characters.

An example of a tape volume data set name using the default prefix is ADSM.BFS.

#### MOUNTRetention

Specifies the number of minutes that an idle sequential access volume is retained before it is dismounted. This parameter is optional. You can specify a number 0 - 9999.

This parameter can improve response time for sequential access media mounts by leaving previously mounted volumes online.

However, for EXTERNAL library types (that is, a library that is managed by an external media management system), set this parameter to a low value (for example, two minutes) to enhance device sharing between applications.

Note: For environments in which devices are shared across storage applications, the MOUNTRETENTION setting must be carefully considered. This parameter determines how long an idle volume remains in a drive. Some media managers do not dismount an allocated drive to satisfy pending requests. You might need to tune this parameter to satisfy competing mount requests while maintaining optimal system performance. Typically, problems arise more frequently when the MOUNTRETENTION parameter is set to a value that is too small, for example, zero.

#### MOUNTWait

Specifies the maximum number of minutes the server waits for an operator to respond to a request to either mount a volume in a drive in a manual library or check in a volume to be mounted in an automated library. This parameter is

optional. If the mount request is not satisfied within the specified amount of time, the mount request is canceled. You can specify a number 0 - 9999.

Restriction: If the library that is associated with this device class is external (LIBTYPE=EXTERNAL), do not specify the MOUNTWAIT parameter.

#### MOUNTLimit

Specifies the maximum number of sequential access volumes that can be simultaneously mounted for the device class. This parameter is optional. You can specify a number 0 - 4096.

If you plan to use the simultaneous-write function, ensure that sufficient drives are available for the write operation. If the number of drives needed for a simultaneous-write operation is greater than the value of the MOUNTLIMIT parameter for a device class, the transaction fails.

The following are possible values:

#### DRIVES

Specifies that every time a mount point is allocated, the number of drives that are defined and online in the library is used to calculate the true value.

Note: For EXTERNAL library types, do not specify DRIVES for the MOUNTLIMIT value. Specify the number of drives for the library as the MOUNTLIMIT value.

#### number

Specifies the maximum number of drives in this device class that are used concurrently by the server. This value must never exceed the number of drives that are defined and online in the library that services this device class.

#### 0 (zero)

Specifies that no new transactions can gain access to the storage pool. Any current transactions continue and complete, but new transactions are terminated.

## UPDATE DEVCLASS (Update an 8MM device class)

---

Use the 8MM device class when you are using 8 mm tape devices.

### Privilege class

---

To issue this command, you must have system privilege or unrestricted storage privilege.

### Syntax

---

```
>>-UPDate DEVclass--device_class_name----->
>--+-----+--+-----+----->
  '-LIBRARY---library_name-' '-FORMAT---+-DRIVE-+-'
                                     +-8200--+
                                     +-8200C+
                                     +-8500--+
                                     +-8500C+
                                     +-8900--+
                                     +-AIT---+
                                     +-AITC--+
                                     +-M2----+
                                     +-M2C---+
                                     +-SAIT--+
                                     +-SAITC+
                                     +-VXA2--+
                                     +-VXA2C+
                                     +-VXA3--+
                                     '-VXA3C-'
>--+-----+----->
  '-ESTCAPacity---size-'
>--+-----+----->
  '-PREFIX---+ADSM-----+-'
                '-tape_volume_prefix-'
>--+-----+--+-----+----->
  '-MOUNTRetention---minutes-' '-MOUNTWait---minutes-'
```

```

>-----+-----<
'-MOUNTLimit-----+DRIVES-+-'
  +-number-+
  '-0-----'

```

## Parameters

device\_class\_name (Required)

Specifies the name of the device class to be updated.

LIBRARY

Specifies the name of the defined library object that contains the 8 mm tape drives that can be used by this device class.

For more information about defining a library object, see the DEFINE LIBRARY command.

FORMAT

Specifies the recording format to be used when data is written to sequential access media. This parameter is optional.

If the drives are in a library that includes drives of different tape technology, do not use the DRIVE value. Use the specific format that the drives use.

The following table lists the recording formats and estimated capacities for 8 mm devices:

Table 1. Recording format and default estimated capacity for 8 mm tape

Format	Estimated Capacity	Description
DRIVE	–	The server selects the highest format that is supported by the drive on which a volume is mounted. Attention: Avoid specifying DRIVE when a mixture of drives is used within the same library. For example, do not use this option for a library that contains some drives that support recording formats superior to other drives.
8200	2.3 GB	Uncompressed (standard) format, using standard 112-meter tape cartridges
8200C	See note 3.5 GB 4.6 GB	Compressed format, using standard 112-meter tape cartridges
8500	See note	Drives (Read Write)
15m	600 MB	Eliant 820 (RW)
15m	600 MB	Exabyte 8500/8500C (RW)
15m	600 MB	Exabyte 8505 (RW)
54m	2.35 GB	Eliant 820 (RW)
54m	2.35 GB	Exabyte 8500/8500C (RW)
54m	2.35 GB	Exabyte 8505 (RW)
112m	5 GB or 10.0 GB	Eliant 820 (RW)
112m	5 GB or 10.0 GB	Exabyte 8500/8500C (RW)
112m	5 GB or 10.0 GB	Exabyte 8505 (RW)
160m XL	7 GB	Eliant 820 (RW)

<b>Format</b>		<b>Description</b>
<b>Medium Type</b>	<b>Estimated Capacity</b>	
8500C	See note	Drives (Read Write)
15m	1.2 GB	Eliant 820 (RW)
15m	1.2 GB	Exabyte 8500/8500C (RW)
15m	1.2 GB	Exabyte 8505 (RW)
54m	4.7 GB	Eliant 820 (RW)
54m	4.7 GB	Exabyte 8500/8500C (RW)
54m	4.7 GB	Exabyte 8505 (RW)
112m	5 GB or 10.0 GB	Eliant 820 (RW)
112m	5 GB or 10.0 GB	Exabyte 8500/8500C (RW)
112m	5 GB or 10.0 GB	Exabyte 8505 (RW)
160m XL	7 GB	Eliant 820 (RW)
8900	See note	Drive (Read Write)
15m	–	Mammoth 8900 (R)
54m	–	Mammoth 8900 (R)
112m	–	Mammoth 8900 (R)
160m XL	–	Mammoth 8900 (R)
22m	2.5 GB	Mammoth 8900 (RW)
125m	–	Mammoth 8900 (RW with upgrade)
170m	40 GB	Mammoth 8900 (RW)
AIT	See note	Drive
SDX1–25C	25 GB	AIT, AIT2 and AIT3 drives
SDX1–35C	35 GB	AIT, AIT2 and AIT3 drives
SDX2–36C	36 GB	AIT2 and AIT3 drives
SDX2–50C	50 GB	AIT2 and AIT3 drives
SDX3–100C	100 GB	AIT3, AIT4, and AIT5 drives
SDX3X-150C	150 GB	AIT3-Ex, AIT4, and AIT5 drives
SDX4–200C	200 GB	AIT4 and AIT5 drives
SDX5-400C	400 GB	AIT5 drive
AITC	See note	Drive
SDX1–25C	50 GB	AIT, AIT2 and AIT3 drives
SDX1–35C	91 GB	AIT, AIT2 and AIT3 drives
SDX2–36C	72 GB	AIT2 and AIT3 drives
SDX2–50C	130 GB	AIT2 and AIT3 drives
SDX3–100C	260 GB	AIT3, AIT4, and AIT5 drives
SDX3X-150C	390 GB	AIT3-Ex, AIT4, and AIT5 drives
SDX4–200C	520 GB	AIT4 and AIT5 drives
SDX5-400C	1040 GB	AIT5 drive
M2	See note	Drive (Read Write)
75m	20.0 GB	Mammoth II (RW)
150m	40.0 GB	Mammoth II (RW)
225m	60.0 GB	Mammoth II (RW)
M2C	See note	Drive (Read Write)
75m	50.0 GB	Mammoth II (RW)
150m	100.0 GB	Mammoth II (RW)
225m	150.0 GB	Mammoth II (RW)
SAIT	See note	Drive (Read Write)
	500 GB	Sony SAIT1–500(RW)
SAITC	See note	Drive (Read Write)
	1300 GB (1.3 TB)	Sony SAIT1–500(RW)



<b>Format</b>		<b>Description</b>
<b>Medium Type</b>	<b>Estimated Capacity</b>	
VXA2	See note	Drive (Read Write)
V6 (62m)	20 GB	VXA-2
V10 (124m)	40 GB	
V17 (170m)	60 GB	
VXA2C	See note	Drive (Read Write)
V6 (62m)	40 GB	VXA-2
V10 (124m)	80 GB	
V17 (170m)	120 GB	
VXA3	See note	Drive (Read Write)
X6 (62m)	40 GB	VXA-3
X10 (124m)	86 GB	
X23 (230m)	160 GB	
VXA3C	See note	Drive (Read Write)
X6 (62m)	80 GB	VXA-3
X10 (124m)	172 GB	
X23 (230m)	320 GB	
<p>Note: The actual capacities might vary depending on which cartridges and drives are used.</p> <ul style="list-style-type: none"> <li>• For the AITC and SAITC formats, the normal compression ratio is 2.6:1.</li> <li>• For the M2C format, the normal compression ratio is 2.5:1.</li> </ul>		

#### ESTCAPacity

Specifies the estimated capacity for the volumes that are assigned to this device class. This parameter is optional.

You can specify this parameter if the default estimated capacity for the device class is inaccurate due to compression of data.

You must specify this value as an integer followed by one of the following unit indicators: **K** (kilobytes), **M** (megabytes), **G** (gigabytes), or **T** (terabytes). The smallest value that is accepted is 1 MB (ESTCAPACITY=1M).

For example, specify that the estimated capacity is 9 GB with the parameter ESTCAPACITY=9G.

To force the IBM Spectrum Protect™ server to determine the estimated capacity for the volumes that are assigned to this device class, specify ESTCAPACITY="".

For more information about the default estimated capacity for 8 mm tapes, see Table 1.

#### PREFIX

Specifies the high-level qualifier of the data set name that the server writes into the sequential access media labels. For each sequential access volume assigned to this device class, the server uses this prefix to create the data set name. This parameter is optional. The maximum length of this prefix is 8 characters.

If you have a naming convention for media labels to support your current management system, use a volume prefix that conforms to your naming conventions.

Values that are specified for this parameter must meet the following conditions:

- The value is to be made up of qualifiers, which can be a maximum of eight characters including periods. For example, the following value is acceptable:

AB.CD2.E

- The qualifiers must be separated by a single period.
- The first letter of each qualifier must be alphabetic or national (@,#,\$), followed by alphabetic, national, hyphen, or numeric characters.

An example of a tape volume data set name using the default prefix is ADSM.BFS.

#### MOUNTRetention

Specifies the number of minutes that an idle sequential access volume is retained before it is dismounted. This parameter is optional. You can specify a number 0 - 9999.

This parameter can improve response time for sequential access media mounts by leaving previously mounted volumes online.

However, for EXTERNAL library types (that is, a library that is managed by an external media management system), set this parameter to a low value (for example, two minutes) to enhance device sharing between applications.

Note: For environments in which devices are shared across storage applications, the MOUNTRETENTION setting must be carefully considered. This parameter determines how long an idle volume remains in a drive. Some media managers do not dismount an allocated drive to satisfy pending requests. You might need to tune this parameter to satisfy competing mount requests while maintaining optimal system performance. Typically, problems arise more frequently when the MOUNTRETENTION parameter is set to a value that is too small, for example, zero.

#### MOUNTWait

Specifies the maximum number of minutes the server waits for an operator to respond to a request to either mount a volume in a drive in a manual library or check in a volume to be mounted in an automated library. This parameter is optional. If the mount request is not satisfied within the specified amount of time, the mount request is canceled. You can specify a number 0 - 9999.

Restriction: If the library that is associated with this device class is external (LIBTYPE=EXTERNAL), do not specify the MOUNTWAIT parameter.

#### MOUNTLimit

Specifies the maximum number of sequential access volumes that can be simultaneously mounted for the device class. This parameter is optional. You can specify a number 0 - 4096.

If you plan to use the simultaneous-write function, ensure that sufficient drives are available for the write operation. If the number of drives needed for a simultaneous-write operation is greater than the value of the MOUNTLIMIT parameter for a device class, the transaction fails.

The following are possible values:

#### DRIVES

Specifies that every time a mount point is allocated, the number of drives that are defined and online in the library is used to calculate the true value.

Note: For EXTERNAL library types, do not specify DRIVES for the MOUNTLIMIT value. Specify the number of drives for the library as the MOUNTLIMIT value.

#### number

Specifies the maximum number of drives in this device class that are used concurrently by the server. This value must never exceed the number of drives that are defined and online in the library that services this device class.

#### 0 (zero)

Specifies that no new transactions can gain access to the storage pool. Any current transactions continue and complete, but new transactions are terminated.

## Example: Update the mount limit and capacity of an 8 mm device class

---

Update a device class named 8MMTAPE. Change the mount limit to 3 and the estimated capacity to 10 GB.

```
update devclass 8mmtape mountlimit=3 estcapacity=10G
```

## Example: Update the mount retention period of an 8 mm device class

---

Update an 8 mm device class that is named 8MMTAPE to a 15-minute mount retention.

```
update devclass 8mmtape mountretention=15
```

## UPDATE DEVCLASS (Update a CENTERA device class)

---

Use the CENTERA device class when you are using EMC Centera storage devices. The CENTERA device type uses files as volumes to store data sequentially. It is similar to the FILE device class.

## Privilege class

---

To issue this command, you must have system privilege or unrestricted storage privilege.

## Syntax

---

```
>>-UPDate DEVclass--device_class_name----->
                                     (1)
>--HLAddress---ip_address?PEA_file----->
>--+-----+----->
  '-MINCAPacity-----size---'
>--+-----+----->>
  '-MOUNTLimit-----number---'
```

### Notes:

1. For each Centera device class, you must specify an IP address. However, a Pool Entry Authorization (PEA) file name and path are optional, and the PEA file specification must follow the IP address. Use the "?" character to separate the PEA file name and path from the IP address.

## Parameters

---

### device\_class\_name (Required)

Specifies the name of the device class to be updated. The maximum length of the device class name is 30 characters.

### HLAddress

Specifies an IP address for the Centera storage device and, optionally, the name and path of one Pool Entry Authorization (PEA) file. Specify the IP address with the dotted decimal format (for example, 9.10.111.222). A Centera device might have multiple IP addresses. However, you must specify one of them as a value for this parameter.

**AIX** The PEA file name and path name are case-sensitive.

If you append the name and path of a PEA file, ensure that the file is stored in a directory on the system that runs the IBM Spectrum Protect™ server. Separate the PEA file name and path from the IP address or addresses with the "?" character, for example: **Windows**

```
HLADDRESS=9.10.111.222?c:\controlFiles\TSM.PEA
```

**AIX**

```
HLADDRESS=9.10.111.222?/user/ControlFiles/TSM.PEA
```

Specify only one PEA file name and path for each device class definition. If you specify two different Centera device classes that point to the same Centera storage device and if the device class definitions contain different PEA file names and paths, the server uses the PEA file that is specified in the device class HLADDRESS parameter that was first used to open the Centera storage device.

### Note:

1. The server does not include a PEA file during installation. If you do not create a PEA file, the server uses the Centera default profile, which can allow applications to read, write, delete, purge, and query data on a Centera storage device. To provide tighter control, create a PEA file with the command-line interface that is provided by EMC Centera. For details about Centera authentication and authorization, refer to the EMC Centera *Programmer's Guide*.
2. You can also specify the PEA file name and path in an environment variable by using the syntax `CENTERA_PEA_LOCATION=filePath_fileName`. The PEA file name and path that is specified with this environment variable apply to all Centera clusters. If you use this variable, you do not need to specify the PEA file name and path using the HLADDRESS parameter.
3. Updating the device class with a new or changed PEA file name and location might require a server restart if the Centera storage device identified by the IP address has already been accessed in the current instance of the server.

### MINCAPacity

Specifies the new minimum size for Centera volumes that are assigned to a storage pool in this device class. This value represents the minimum amount of data that is stored on a Centera volume before the server marks it full. Centera volumes

continue to accept data until the minimum amount of data is stored. This parameter is optional.

size

Specify this value as an integer followed by **K** (kilobytes), **M** (megabytes), **G** (gigabytes), or **T** (terabytes). The minimum value that is allowed is 1 MB (MINCAPACITY=1M). The maximum value that is allowed is 128 GB (MINCAPacity=128G).

MOUNTLimit

Specifies the new maximum number of sessions that access the Centera device. This parameter is optional. You can specify any number from 0 or greater; however, the sum of all mount limit values for all device classes that are assigned to the same Centera device must not exceed the maximum number of sessions that are allowed by Centera.

## UPDATE DEVCLASS (Update a DLT device class)

---

Use the DLT device class when you are using DLT tape devices.

### Privilege class

---

To issue this command, you must have system privilege or unrestricted storage privilege.

### Syntax

---

```
>>-UPDate DEVclass--device_class_name----->
>--+-----+--+-----+----->
  '-LIBRARY---library_name-' '-FORMAT---+DRIVE---+'
                                     +-DLT1-----+
                                     +-DLT1C-----+
                                     +-DLT10-----+
                                     +-DLT10C-----+
                                     +-DLT15-----+
                                     +-DLT15C-----+
                                     +-DLT20-----+
                                     +-DLT20C-----+
                                     +-DLT35-----+
                                     +-DLT35C-----+
                                     +-DLT40-----+
                                     +-DLT40C-----+
                                     +-DLT2-----+
                                     +-DLT2C-----+
                                     +-DLT4-----+
                                     +-DLT4C-----+
                                     +-SDLT-----+
                                     +-SDLTC-----+
                                     +-SDLT320---+
                                     +-SDLT320C--+
                                     +-SDLT600---+
                                     +-SDLT600C--+
                                     +-DLTS4-----+
                                     '-DLTS4C---'

>--+-----+----->
  '-ESTCAPacity---size-'

>--+-----+----->
  '-PREFIX---+ADSM-----+'
    '-tape_volume_prefix-'

>--+-----+--+-----+----->
  '-MOUNTRetention---minutes-' '-MOUNTWait---minutes-'

>--+-----+-----><
  '-MOUNTLimit---+DRIVES---+'
    +-number-+
    '-0-----'
```

### Parameters

---

device\_class\_name (Required)

Specifies the name of the device class to be updated.

LIBRARY

Specifies the name of the defined library object that contains the DLT tape drives that can be used by this device class. For information about defining a library object, see the DEFINE LIBRARY command.

FORMAT

Specifies the recording format to be used when data is written to sequential access media. This parameter is optional.

If the drives are in a library that includes drives of different tape technology, do not use the DRIVE value. Use the specific format that the drives use.

The following table lists the recording formats and estimated capacities for DLT devices:

Table 1. Recording format and default estimated capacity for DLT

Format	Estimated Capacity	Description
DRIVE	–	The server selects the highest format that is supported by the drive on which a volume is mounted. Attention: Avoid specifying DRIVE when a mixture of drives is used within the same library. For example, do not use this option for a library that contains some drives that support recording formats superior to other drives.
DLT1	40.0 GB	Uncompressed format, using only CompacTape III or CompacTape IV cartridges
DLT1C	See note 1. 80.0 GB	Compressed format, using only CompacTape III and CompacTape IV cartridges
DLT10	10.0 GB	Uncompressed format, using only CompacTape III or CompacTape IV cartridges
DLT10C	See note 1. 20.0 GB	Compressed format, using only CompacTape III and CompacTape IV cartridges
DLT15	15.0 GB	Uncompressed format, using only CompacTape IIIxt or CompacTape IV cartridges (not CompacTape III) Note: Valid with DLT2000XT, DLT4000, and DLT7000 drives
DLT15C	See note 1. 30.0 GB	Compressed format, using only CompacTape IIIxt or CompacTape IV cartridges (not CompacTape III) Valid with DLT2000XT, DLT4000, and DLT7000 drives
DLT20	20.0 GB	Uncompressed format, using only CompacTape IV cartridges Valid with DLT4000, DLT7000, and DLT8000 drives
DLT20C	See note 1. 40.0 GB	Compressed format, using only CompacTape IV cartridges Valid with DLT4000, DLT7000, and DLT8000 drives
DLT35	35.0 GB	Uncompressed format, using only CompacTape IV cartridges Valid with DLT7000 and DLT8000 drives
DLT35C	See note 1. 70.0 GB	Compressed format, using only CompacTape IV cartridges Valid with DLT7000 and DLT8000 drives
DLT40	40.0 GB	Uncompressed format, using CompacTape IV cartridges Valid with a DLT8000 drive
DLT40C	See note 1. 80.0 GB	Compressed format, using CompacTape IV cartridges Valid with a DLT8000 drive
DLT2	80.0 GB	Uncompressed format, using Quantum DLT tape VS1 media

Format	Estimated Capacity	Description
DLT2C	See note 1. 160.0 GB	Compressed format, using Quantum DLT tape VS1 media
DLT4	160.0 GB	Uncompressed format, using Quantum DLTtape VS1 cartridges. Valid with Quantum DLT-V4 drive
DLT4C	See note 1. 320.0 GB	Compressed format, using Quantum DLTtape VS1 cartridges. Valid with Quantum DLT-V4 drive
SDLT See note 2.	100.0 GB	Uncompressed format, using Super DLT Tape 1 cartridges Valid with a Super DLT drive
SDLTC See note 2.	See note 1. 200.0 GB	Compressed format, using Super DLT Tape 1 cartridges Valid with a Super DLT drive
SDLT320 See note 2.	160.0 GB	Uncompressed format, using Quantum SDLT I media Valid with a Super DLT drive
SDLT320C See note 2.	See note 1. 320.0 GB	Compressed format, using Quantum SDLT I media Valid with a Super DLT drive
SDLT600	300.0 GB	Uncompressed format, using SuperDLTtape-II media Valid with a Super DLT drive
SDLT600C	See note 1. 600.0 GB	Compressed format, using SuperDLTtape-II media Valid with a Super DLT drive
DLTS4	800 GB	Uncompressed format, using Quantum DLT S4 media. Valid with a DLT-S4 drive
DLTS4C	See note 1. 1.6 TB	Compressed format, using Quantum DLT S4 media. Valid with a DLT-S4 drive
<p>Note:</p> <ol style="list-style-type: none"> <li>Depending on the effectiveness of compression, the actual capacity might be greater than the listed value.</li> <li>IBM Spectrum Protect™ does not support a library that contains both Backward Read Compatible (BRC) SDLT and Non-Backward Read Compatible (NBRC) SDLT drives.</li> </ol>		

#### ESTCAPacity

Specifies the estimated capacity for the volumes that are assigned to this device class. This parameter is optional.

You can specify this parameter if the default estimated capacity for the device class is inaccurate due to compression of data.

You must specify this value as an integer followed by one of the following unit indicators: K (kilobytes), M (megabytes), G (gigabytes), or T (terabytes). The smallest value that is accepted is 1 MB (ESTCAPACITY=1M).

For example, specify that the estimated capacity is 9 GB with the parameter ESTCAPACITY=9G.

To force the IBM Spectrum Protect server to determine the estimated capacity for the volumes that are assigned to this device class, specify ESTCAPACITY="".

For more information about estimated capacities, see Table 1.

#### PREFIX

Specifies the high-level qualifier of the data set name that the server writes into the sequential access media labels. For each sequential access volume assigned to this device class, the server uses this prefix to create the data set name. This

parameter is optional. The maximum length of this prefix is 8 characters.

If you have a naming convention for media labels to support your current management system, use a volume prefix that conforms to your naming conventions.

Values that are specified for this parameter must meet the following conditions:

- The value is to be made up of qualifiers, which can be a maximum of eight characters including periods. For example, the following value is acceptable:

AB.CD2.E

- The qualifiers must be separated by a single period.
- The first letter of each qualifier must be alphabetic or national (@,#,\$), followed by alphabetic, national, hyphen, or numeric characters.

An example of a tape volume data set name using the default prefix is ADSM.BFS.

#### MOUNTRetention

Specifies the number of minutes that an idle sequential access volume is retained before it is dismounted. This parameter is optional. You can specify a number 0 - 9999.

This parameter can improve response time for sequential access media mounts by leaving previously mounted volumes online.

However, for EXTERNAL library types (that is, a library that is managed by an external media management system), set this parameter to a low value (for example, two minutes) to enhance device sharing between applications.

Note: For environments in which devices are shared across storage applications, the MOUNTRETENTION setting must be carefully considered. This parameter determines how long an idle volume remains in a drive. Some media managers do not dismount an allocated drive to satisfy pending requests. You might need to tune this parameter to satisfy competing mount requests while maintaining optimal system performance. Typically, problems arise more frequently when the MOUNTRETENTION parameter is set to a value that is too small, for example, zero.

#### MOUNTWait

Specifies the maximum number of minutes the server waits for an operator to respond to a request to either mount a volume in a drive in a manual library or check in a volume to be mounted in an automated library. This parameter is optional. If the mount request is not satisfied within the specified amount of time, the mount request is canceled. You can specify a number 0 - 9999.

Restriction: If the library that is associated with this device class is external (LIBTYPE=EXTERNAL), do not specify the MOUNTWAIT parameter.

#### MOUNTLimit

Specifies the maximum number of sequential access volumes that can be simultaneously mounted for the device class. This parameter is optional. You can specify a number 0 - 4096.

If you plan to use the simultaneous-write function, ensure that sufficient drives are available for the write operation. If the number of drives needed for a simultaneous-write operation is greater than the value of the MOUNTLIMIT parameter for a device class, the transaction fails.

The following are possible values:

#### DRIVES

Specifies that every time a mount point is allocated, the number of drives that are defined and online in the library is used to calculate the true value.

Note: For EXTERNAL library types, do not specify DRIVES for the MOUNTLIMIT value. Specify the number of drives for the library as the MOUNTLIMIT value.

#### number

Specifies the maximum number of drives in this device class that are used concurrently by the server. This value must never exceed the number of drives that are defined and online in the library that services this device class.

#### 0 (zero)

Specifies that no new transactions can gain access to the storage pool. Any current transactions continue and complete, but new transactions are terminated.

## UPDATE DEVCLASS (Update an ECARTRIDGE device class)

---

Use the ECARTRIDGE device class when you are using StorageTek drives such as the StorageTek T9840 or T10000.

## Privilege class

To issue this command, you must have system privilege or unrestricted storage privilege.

## Syntax

```
>>-UPDate DEVclass--device_class_name----->
>--+-----+----->
  '-LIBRARY---library_name-'
>--+-----+----->
  '-LBProtect---+READWrite+-'
                    +-WRITEOnly+
                    '-No-----'
>--+-----+-----+----->
  '-FORMAT---+DRIVE---+'  '-ESTCAPacity---size-'
                    +-T9840C---+
                    +-T9840C-C--+
                    +-T9840D---+
                    +-T9840D-C--+
                    +-T10000A---+
                    +-T10000A-C+
                    +-T10000B---+
                    +-T10000B-C+
                    +-T10000C---+
                    +-T10000C-C+
                    +-T10000D---+
                    '-T10000D-C-'
>--+-----+----->
  '-PREFIX---+ADSM-----+'
                    '-tape_volume_prefix-'
>--+-----+-----+----->
  '-MOUNTRetention---minutes-'  '-MOUNTWait---minutes-'
>--+-----+----->
  '-MOUNTLimit---+DRIVES-+-'
                    +-number+
                    '-0-----'
>--+-----+-----+----->>
  | (1) (2) |
  '------DRIVEEncryption---+ON-----+'
                    +-ALLOW-----+
                    +-EXTERNAL-+
                    '-OFF-----'
```

### Notes:

1. You can use drive encryption only for Oracle StorageTek T10000B drives with a format value of DRIVE, T10000B, or T10000B-C, for Oracle StorageTek T10000C drives with a format value of DRIVE, T10000C or T10000C-C, and for Oracle StorageTek T10000D drives with a format value of DRIVE, T10000D and T10000D-C.
2. You cannot specify both WORM=YES and DRIVEENCRYPTION=ON.

## Parameters

device\_class\_name (Required)

Specifies the name of the device class to be updated.

LIBRARY

Specifies the name of the defined library object with the ECARTRIDGE tape drives that can be used by this device class. For information about defining a library object, see the DEFINE LIBRARY command.



## LBProtect

Specifies whether logical block protection is used to ensure the integrity of data stored on tape. When LBPROTECT is set to READWRITE or to WRITEONLY, the server uses this feature of the tape drive for logical block protection and generates cyclic redundancy check (CRC) protection information for each data block written on tape. The server also validates the CRC protection information when data is read from the tape.

The following values are possible:

### READWrite

Specifies that logical block protection is enabled in the server and the tape drive for both read and write operations. Data is stored with CRC information in each block. This mode affects performance because additional processor usage is required for IBM Spectrum Protect™ and the tape drive to calculate and compare CRC values. The READWRITE value does not affect backup sets and data that is generated by the BACKUP DB command.

When the LBPROTECT parameter is set to READWRITE, you do not have to specify the CRCDATA parameter in a storage pool definition because logical block protection provides better protection against data corruption.

### WRITEOnly

Specifies that logical block protection is enabled in the server and the tape drive for write operations only. Data is stored containing CRC information in each block. For read operations, the server and the tape drive do not validate the CRC. This mode affects performance because additional processor usage is required for IBM Spectrum Protect to generate the CRC and for the tape drive to calculate and compare CRC values for write operations. The WRITEONLY value does not affect backup sets and data that are generated by the BACKUP DB command.

### No

Specifies that logical block protection is not enabled in the server and the tape drive for read and write operations. However, the server enables logical block protection on write operations for a filling volume that already has data with logical block protection.

Restriction: Logical block protection is supported only on Oracle StorageTek T10000C and Oracle StorageTek T10000D drives.

## FORMAT

Specifies the recording format to be used when data is written to sequential access media. This parameter is optional.

If the drives are in a library that includes drives of different tape technology, do not use the DRIVE value. Use the specific format that the drives use.

Important: If you specify DRIVE for a device class that has non-compatible sequential access devices, then you must mount volumes on devices that are capable of reading or writing the format that is established when the volume was first mounted. This can cause delays if the only sequential access device that can access the volume is already in use. The following table lists the recording formats and estimated capacities for ECARTRIDGE devices:

Table 1. Recording formats and default estimated capacities for ECARTRIDGE tapes

Format	Estimated Capacity	Description
DRIVE	–	The server selects the highest format that is supported by the drive on which a volume is mounted. Attention: Avoid specifying DRIVE when a mixture of drives is used within the same library. For example, do not use this option for a library that contains some drives that support recording formats superior to other drives.
T9840C	40 GB	Uncompressed T9840C format, using a StorageTek 9840 cartridge
T9840C-C	80 GB	Compressed T9840C format, using a StorageTek 9840 cartridge
T9840D	75 GB	Uncompressed T9840D format, using a StorageTek 9840 cartridge
T9840D-C	150 GB	Compressed T9840D format, using a StorageTek 9840 cartridge
T10000A	500 GB	Uncompressed T10000A format, using a StorageTek T10000 cartridge
T10000A-C	1 TB	Compressed T10000A format, using a StorageTek T10000 cartridge
T10000B	1 TB	Uncompressed T10000B format, using an Oracle StorageTek T10000 cartridge
T10000B-C	2 TB	Compressed T10000B format, using an Oracle StorageTek T10000 cartridge

Format	Estimated Capacity	Description
T10000C	5 TB	Uncompressed T10000C format, using an Oracle StorageTek T10000 T2 cartridge
T10000C-C	10 TB	Compressed T10000C format, using an Oracle StorageTek T10000 T2 cartridge
T10000D	8 TB	Uncompressed T10000D format, using an Oracle StorageTek T10000 T2 cartridge
T10000D-C	15 TB	Compressed T10000D format, using an Oracle StorageTek T10000 T2 cartridge
<p>Notes:</p> <ul style="list-style-type: none"> <li>• Some formats use a tape drive hardware compression feature. Depending on the effectiveness of compression, the actual capacity might be double or more than the listed value.</li> <li>• T10000A drives can read and write the T10000A format only. T10000B drives can read, but cannot write, the T10000A format. T10000C drives can read, but cannot write, the T10000A and T10000B formats. T10000D drives can read, but cannot write, the T10000A, T10000B, and T10000C formats.</li> </ul>		

#### ESTCAPacity

Specifies the estimated capacity for the volumes that are assigned to this device class. This parameter is optional.

You can specify this parameter if the default estimated capacity for the device class is inaccurate due to compression of data.

You must specify this value as an integer followed by one of the following unit indicators: **K** (kilobytes), **M** (megabytes), **G** (gigabytes), or **T** (terabytes). The smallest value that is accepted is 1 MB (ESTCAPACITY=1M).

For example, specify that the estimated capacity is 9 GB with the parameter ESTCAPACITY=9G.

To force the IBM Spectrum Protect server to determine the estimated capacity for the volumes that are assigned to this device class, specify ESTCAPACITY="".

For more information about the default estimated capacity for cartridge tapes, see Table 1.

#### PREFIX

Specifies the high-level qualifier of the data set name that the server writes into the sequential access media labels. For each sequential access volume assigned to this device class, the server uses this prefix to create the data set name. This parameter is optional. The maximum length of this prefix is 8 characters.

If you have a naming convention for media labels to support your current management system, use a volume prefix that conforms to your naming conventions.

Values that are specified for this parameter must meet the following conditions:

- The value is to be made up of qualifiers, which can be a maximum of eight characters including periods. For example, the following value is acceptable:

AB.CD2.E

- The qualifiers must be separated by a single period.
- The first letter of each qualifier must be alphabetic or national (@,#,\$), followed by alphabetic, national, hyphen, or numeric characters.

An example of a tape volume data set name using the default prefix is ADSM.BFS.

#### MOUNTRetention

Specifies the number of minutes that an idle sequential access volume is retained before it is dismounted. This parameter is optional. You can specify a number 0 - 9999.

This parameter can improve response time for sequential access media mounts by leaving previously mounted volumes online.

However, for EXTERNAL library types (that is, a library that is managed by an external media management system), set this parameter to a low value (for example, two minutes) to enhance device sharing between applications.

Note: For environments in which devices are shared across storage applications, the MOUNTRETENTION setting must be carefully considered. This parameter determines how long an idle volume remains in a drive. Some media managers do not dismount an allocated drive to satisfy pending requests. You might need to tune this parameter to satisfy competing mount requests while maintaining optimal system performance. Typically, problems arise more frequently when the MOUNTRETENTION parameter is set to a value that is too small, for example, zero.

#### MOUNTWait

Specifies the maximum number of minutes the server waits for an operator to respond to a request to either mount a volume in a drive in a manual library or check in a volume to be mounted in an automated library. This parameter is optional. If the mount request is not satisfied within the specified amount of time, the mount request is canceled. You can specify a number 0 - 9999.

Restriction: If the library that is associated with this device class is external (LIBTYPE=EXTERNAL), do not specify the MOUNTWAIT parameter.

#### MOUNTLimit

Specifies the maximum number of sequential access volumes that can be simultaneously mounted for the device class. This parameter is optional. You can specify a number 0 - 4096.

If you plan to use the simultaneous-write function, ensure that sufficient drives are available for the write operation. If the number of drives needed for a simultaneous-write operation is greater than the value of the MOUNTLIMIT parameter for a device class, the transaction fails.

The following are possible values:

#### DRIVES

Specifies that every time a mount point is allocated, the number of drives that are defined and online in the library is used to calculate the true value.

Note: For EXTERNAL library types, do not specify DRIVES for the MOUNTLIMIT value. Specify the number of drives for the library as the MOUNTLIMIT value.

#### number

Specifies the maximum number of drives in this device class that are used concurrently by the server. This value must never exceed the number of drives that are defined and online in the library that services this device class.

#### 0 (zero)

Specifies that no new transactions can gain access to the storage pool. Any current transactions continue and complete, but new transactions are terminated.

#### DRIVEEncryption

Specifies whether drive encryption is allowed. This parameter is optional.

Restriction:

1. You can use drive encryption only for the following drives:
  - o Oracle StorageTek T10000B drives that have a format value of DRIVE, T10000B, or T10000B-C
  - o Oracle StorageTek T10000C drives that have a format value of DRIVE, T10000C, or T10000C-C
  - o Oracle StorageTek T10000D drives that have a format value of DRIVE, T10000D, or T10000D-C
2. You cannot specify IBM Spectrum Protect as the key manager for drive encryption of WORM (write once, read many) media. (Specifying both WORM=YES and DRIVEENCRYPTION=ON is not supported.)
3. If encryption is enabled for a device class, and the device class is associated with a storage pool, the storage pool should not share a scratch pool with other device classes that cannot be encrypted. If a tape is encrypted, and you plan to use it on a drive that cannot be encrypted, you must manually relabel the tape before it can be used on that drive.

#### ON

Specifies that IBM Spectrum Protect is the key manager for drive encryption and allows drive encryption for empty storage pool volumes only if the application method is enabled. (Other types of volumes are not encrypted. For example, back up sets, export volumes, and database backup volumes are not encrypted.) If you specify ON and you enable another method of encryption, drive encryption is not allowed and backup operations fail.

#### ALLOW

Specifies that IBM Spectrum Protect does not manage the keys for drive encryption. However, drive encryption for empty volumes is allowed if another method of encryption is enabled.

#### EXTERNAL

Specifies that IBM Spectrum Protect does not manage the keys for drive encryption. Use this setting with an encryption methodology that is provided by another vendor and that is used with Application Method Encryption (AME) enabled on the drive. When you specify EXTERNAL and IBM Spectrum Protect detects that AME encryption is enabled, IBM Spectrum Protect does not turn off encryption. By contrast, when you specify ALLOW and IBM Spectrum Protect detects that AME encryption is enabled, IBM Spectrum Protect turns off encryption.

OFF

Specifies that drive encryption is not allowed. If you enable another method of encryption, backups fail. If you enable the application method, IBM Spectrum Protect disables encryption and backups are attempted.

## UPDATE DEVCLASS (Update a FILE device class)

Use the FILE device class when you are using files on magnetic disk storage as volumes that store data sequentially (as on tape).

**AIX** | **Linux** The FILE device class does not support EXTERNAL libraries.

**Windows** The FILE device class does not support EXTERNAL libraries.

**AIX** | **Linux** If you are defining a device class for devices that are to be accessed through a z/OS® media server, see UPDATE DEVCLASS (Update a FILE device class for z/OS media server).

### Privilege class

To issue this command, you must have system privilege or unrestricted storage privilege.

### Syntax

```
>>-UPDate DEVclass--device_class_name----->
>--+-----+-----+-----+----->
  '-MOUNTLimit----number-' '-MAXCAPacity----size-'
>--+-----+-----+-----+----->
  |           .-,'-----'. |
  |           v             | |
  '-DIRectory-----directory_name-+-'
>--+-----+-----+-----+-----><
  '-SHAREd-----+No--+-'
                   '-Yes-'
```

### Parameters

device\_class\_name (Required)

Specifies the name of the device class to be updated.

MOUNTLimit

Specifies the maximum number of files that can be simultaneously open for input and output. This parameter is optional. You can specify a number from 0 to 4096.

**Windows** If the device class is shared with a storage agent (by specifying the SHARED=YES parameter), drives are defined or deleted to match the MOUNTLIMIT value.

If you plan to use the simultaneous-write function, ensure that sufficient drives are available for the write operation. If the number of drives needed for a simultaneous-write operation is greater than the value of the MOUNTLIMIT parameter for a device class, the transaction fails.

MAXCAPacity

Specifies the maximum size of any data storage files that are categorized by this device class. This parameter is optional.

Specify this value as an integer followed by K (kilobytes), M (megabytes), G (gigabytes), or T (terabytes). The minimum size is 1 MB (MAXCAPACITY=1M). If you are defining a FILE device class for database-backup volumes, specify a value for MAXCAPACITY that is appropriate for the size of the database and that minimizes the number of database volumes.

For example, MAXCAPACITY=5G specifies that the maximum capacity for a volume in this device class is 5 gigabytes. The value that is specified must be less than or equal to the maximum supported size of a file on the target file system.

**AIX** | **Linux** Do not define a MAXCAPACITY value greater than 640M when this file is for REMOVABLEFILE CD support. A value less than a CD's usable space (650 MB) allows for a one-to-one match between files from the FILE device class and copies that are on CD.

## DIRectory

Specifies the directory location or locations of the files that are used in this device class. Enclose the entire list of directories within quotation marks, by using commas to separate individual directory names. Special characters (for example, blank spaces) are allowed within directory names. For example, the directory list "abc def,xyz" contains two directories: abc def and xyz. This parameter is optional.

By specifying a directory name or names, you identify the locations where the server places the files that represent storage volumes for this device class.

**AIX** | **Linux** While the command is processed, the server expands the specified directory name or names into their fully qualified forms, starting from the root directory.

**Important:** If you are using storage agents for shared access to FILE volumes, you must use the DEFINE PATH command to define a path for each storage agent. The path definition includes the directory names that are used by the storage agent to access each directory.

Later, if the server must allocate a scratch volume, it creates a new file in one of these directories. (The server can choose any of the directories in which to create new scratch volumes.) For scratch volumes used to store client data, the file that is created by the server has a file name extension of .bfs. For scratch volumes used to store export data, a file name extension of .exp is used.

**AIX** | **Linux** For example, if you define a device class with a directory of tsmstor and the server needs a scratch volume in this device class to store export data, the file that the server creates might be named tsmstor\00566497.exp.

**Windows** For example, if you define a device class with a directory of c:\server and the server needs a scratch volume in this device class to store export data, the file that the server creates might be named c:\server\00566497.exp.

**Tip:** If you specify multiple directories for a device class, ensure that the directories are associated with separate file systems. Space trigger functions and storage pool space calculations take into account the space that remains in each directory. If you specify multiple directories for a device class and the directories are in the same file system, the server calculates space by adding values that represent the space that remains in each directory. These space calculations are inaccurate. Rather than choosing a storage pool with sufficient space for an operation, the server might choose the wrong storage pool and run out of space prematurely. For space triggers, an inaccurate calculation might result in a failure to expand the space available in a storage pool. Failure to expand space in a storage pool is one of the conditions that can cause a trigger to become disabled. If a trigger is disabled because the space in a storage pool was not expanded, you can re-enable the trigger by issuing the following command: `update spacetrigger stg`. No further changes are required to the space trigger.

**Restriction:** To modify a list of directories, you must replace the entire list.

## SHARED

Specifies that this FILE device class is shared between the server and one or more storage agents. To prepare for sharing, a library is automatically defined along with a number of drives corresponding to the MOUNTLIMIT associated with the device class. If the library and drives exist and the MOUNTLIMIT is changed, drives can either be created to reach a new higher MOUNTLIMIT value or deleted to reach a new lower value.

## Storage agents using FILE volumes

---

You must ensure that storage agents can access newly created FILE volumes. To access FILE volumes, storage agents replace names from the directory list in the device-class definition with the names in the directory list for the associated path definition. The following illustrates the importance of matching device classes and paths to ensure that storage agents can access newly created FILE volumes.

Suppose you want to use these three directories for a FILE library:

### Windows

- c:\server
- d:\server
- e:\server

### AIX

- /usr/tivoli1
- /usr/tivoli2
- /usr/tivoli3

### Linux

- /opt/tivoli1
- /opt/tivoli2
- /opt/tivoli3

1. You use the following command to set up a FILE library named CLASSA with one drive named CLASSA1 on SERVER1:

**Windows**

```
define devclass classa devtype=file
directory="c:\server,d:\server,e:\server"
shared=yes mountlimit=1
```

**AIX**

```
define devclass classa devtype=file
directory="/usr/tivoli1,/usr/tivoli2,/usr/tivoli3"
shared=yes mountlimit=1
```

**Linux**

```
define devclass classa devtype=file
directory="/opt/tivoli1,/opt/tivoli2,/opt/tivoli3"
shared=yes mountlimit=1
```

2. You want the storage agent STA1 to be able to use the FILE library, so you define the following path for storage agent STA1:

o **Windows**

```
define path server1 stal srctype=server desttype=drive device=file
directory="\\192.168.1.10\c\server,\\192.168.1.10\d\server,
\\192.168.1.10\e\server" library=classa
```

In this scenario, the storage agent, STA1, replaces the directory name c:\server with the directory name \\192.168.1.10\c\server to access FILE volumes that are in the c:\server directory on the server.

o **AIX**

```
define path server1 stal srctype=server desttype=drive device=file
directory="/usr/ibm1,/usr/ibm2,/usr/ibm3" library=classa
```

In this scenario, the storage agent, STA1, replaces the directory name /usr/tivoli1 with the directory name /usr/ibm1 to access FILE volumes that are in the /usr/tivoli1 directory on the server.

o **Linux**

```
define path server1 stal srctype=server desttype=drive device=file
directory="/opt/ibm1,/opt/ibm2,/opt/ibm3" library=classa
```

In this scenario, the storage agent, STA1, replaces the directory name /opt/tivoli1 with the directory name /opt/ibm1/ to access FILE volumes that are in the /opt/tivoli1 directory on the server.

The following results occur:

- **Windows** File volume c:\server\file1.dsm is created by SERVER1. If you later change the first directory for the device class with the following command:

```
update devclass classa directory="c:\otherdir,d:\server,e:\server"
```

SERVER1 is still able to access file volume c:\server\file1.dsm, but the storage agent STA1 is not able to access it because a matching directory name in the PATH directory list no longer exists. If a directory name is not available in the directory list that is associated with the device class, the storage agent can lose access to a FILE volume in that directory. Although the volume is still accessible from the server for reading, failure of the storage agent to access the FILE volume can cause operations to be retried on a LAN-only path or to fail.

- **AIX** If file volume /usr/tivoli1/file1.dsm is created on SERVER1, and if the following command is issued,

```
update devclass classa directory="/usr/otherdir,/usr/tivoli2,
/usr/tivoli3"
```

SERVER1 is still able to access file volume /usr/tivoli1/file1.dsm, but the storage agent STA1 is not able to access it because a matching directory name in the PATH directory list no longer exists. If a directory name is not available in the directory list that is associated with the device class, the storage agent can lose access to a FILE volume in that directory.

Although the volume is still accessible from the server for reading, failure of the storage agent to access the FILE volume can cause operations to be retried on a LAN-only path or to fail.

- **Linux** If file volume /opt/tivoli1/file1.dsm is created on SERVER1, and if the following command is issued,

```
update devclass classa directory="/opt/otherdir,/opt/tivoli2,  
/opt/tivoli3"
```

SERVER1 is still able to access file volume /opt/tivoli1/file1.dsm, but the storage agent STA1 is not able to access it because a matching directory name in the PATH directory list no longer exists. If a directory name is not available in the directory list that is associated with the device class, the storage agent can lose access to a FILE volume in that directory. Although the volume is still accessible from the server for reading, failure of the storage agent to access the FILE volume can cause operations to be retried on a LAN-only path or to fail.

## Example: Update a FILE device class for sharing

---

Prepare a FILE device class (named PLAINFILES) for sharing with an IBM Spectrum Protect™ storage agent.

```
update devclass plainfiles shared=yes
```

## Example: Update the capacity of a FILE device class

---

Update a file device class named STORFILES to a maximum capacity of 25 MB.

```
update devclass storfiles maxcap=25m
```

**AIX**

## Example: Add a directory to a FILE device class

---

Update the FILE device class, CLASSA, by adding a directory, /usr/otherdir, to the directory list. The directories /opt/tivoli2 and /opt/tivoli3 were specified when the device class was first defined.

```
update devclass classa  
directory="/opt/tivoli2,/opt/tivoli3,/usr/otherdir"
```

**Linux**

## Example: Add a directory to a FILE device class

---

Update the FILE device class, CLASSA, by adding a directory, /usr/otherdir, to the directory list. The directories /usr/tivoli2 and /usr/tivoli3 were specified when the device class was first defined.

```
update devclass classa  
directory="/usr/tivoli2,/usr/tivoli3,/usr/otherdir"
```

**Windows**

## Example: Add a directory to a FILE device class

---

Update the FILE device class, CLASSA, by adding a directory, c:\otherdir, to the directory list. The directories d:\server and e:\server were specified when the device class was first defined.

```
update devclass classa  
directory="d:\server,e:\server,c:\otherdir"
```

**AIX**

**Windows**

## UPDATE DEVCLASS (Update a GENERICTAPE device class)

---

Use the GENERICTAPE device class for tape drives that are supported by operating system device drivers.

When this device type is used, the server does not recognize either the type of device or the cartridge recording format. Because the server does not recognize the type of device, if an I/O error occurs, error information is less detailed compared to error information for a specific device type (for example, 8MM). When you define devices to the server, do not mix various types of devices within the same device type.

## Privilege class

---

To issue this command, you must have system privilege or unrestricted storage privilege.

## Syntax

---

```
>>-UPDate DEVclass--device_class_name----->
>--+-----+--+-----+----->
  '-LIBRARY---library_name-' '-ESTCAPacity---size-'
>--+-----+--+-----+----->
  '-MOUNTRetention---minutes-' '-MOUNTWait---minutes-'
>--+-----+--+-----+----->>
  '-MOUNTLimit---+DRIVES-+-'
                    +-number-+
                    '-0-----'
```

## Parameters

---

**device\_class\_name** (Required)

Specifies the name of the device class to be updated.

**LIBRARY**

Specifies the name of the defined library object that contains the tape drives that can be used by this device class.

This parameter is optional.

For information about defining a library object, see the DEFINE LIBRARY command.

**ESTCAPacity**

Specifies the estimated capacity for the volumes that are assigned to this device class. This parameter is optional.

You can specify this parameter if the default estimated capacity for the device class is inaccurate due to compression of data.

Specify a capacity appropriate to the particular tape drive that is being used.

You must specify this value as an integer followed by one of the following unit indicators: **K** (kilobytes), **M** (megabytes), **G** (gigabytes), or **T** (terabytes). The smallest value that is accepted is 1 MB (ESTCAPACITY=1M).

For example, specify that the estimated capacity is 9 GB with the parameter ESTCAPACITY=9G.

To force the IBM Spectrum Protect™ server to determine the estimated capacity for the volumes that are assigned to this device class, specify ESTCAPACITY="".

**MOUNTRetention**

Specifies the number of minutes that an idle sequential access volume is retained before it is dismounted. This parameter is optional. You can specify a number 0 - 9999.

This parameter can improve response time for sequential access media mounts by leaving previously mounted volumes online.

However, for EXTERNAL library types, setting this parameter to a low value (for example, two minutes) enhances device sharing between applications.

**Note:** For environments in which devices are shared across storage applications, the MOUNTRETENTION setting must be carefully considered. This parameter determines how long an idle volume remains in a drive. Some media managers do not dismount an allocated drive to satisfy pending requests. You might need to tune this parameter to satisfy competing mount requests while maintaining optimal system performance. Typically, problems arise more frequently when the MOUNTRETENTION parameter is set to a value that is too small, for example, zero.

**MOUNTWait**

Specifies the maximum number of minutes the server waits for an operator to respond to a request to either mount a volume in a drive in a manual library or check in a volume to be mounted in an automated library. This parameter is



optional. If the mount request is not satisfied within the specified amount of time, the mount request is canceled. You can specify a number 0 - 9999.

Restriction: If the library that is associated with this device class is external (LIBTYPE=EXTERNAL), do not specify the MOUNTWAIT parameter.

#### MOUNTLimit

Specifies the maximum number of sequential access volumes that can be simultaneously mounted for the device class. This parameter is optional. You can specify a number 0 - 4096.

If you plan to use the simultaneous-write function, ensure that sufficient drives are available for the write operation. If the number of drives needed for a simultaneous-write operation is greater than the value of the MOUNTLIMIT parameter for a device class, the transaction fails.

The following are possible values:

#### DRIVES

Specifies that every time a mount point is allocated, the number of drives that are defined and online in the library is used to calculate the true value.

Note: For EXTERNAL library types, do not specify DRIVES for the MOUNTLIMIT value. Specify the number of drives for the library as the MOUNTLIMIT value.

#### number

Specifies the maximum number of drives in this device class that are used concurrently by the server. This value must never exceed the number of drives that are defined and online in the library that services this device class.

#### 0 (zero)

Specifies that no new transactions can gain access to the storage pool. Any current transactions continue and complete, but new transactions are terminated.

## UPDATE DEVCLASS (Update an LTO device class)

---

Use the LTO device class when you are using LTO tape devices.

### Privilege class

---

To issue this command, you must have system privilege or unrestricted storage privilege.

### Syntax

---

```
>>-UPDate DEVclass--device_class_name----->
>--+-----+----->
  '-LIBRARY---library_name-'
>--+-----+----->
  '-LBProtect---+READWrite+-'
                    +-WRITEOnly+
                    '-No-----'
>--+-----+----->
  '-FORMAT---+DRIVE---+'  '-ESTCAPacity---size-'
                    +-ULTRIUM---+
                    +-ULTRIUMC--+
                    +-ULTRIUM2--+
                    +-ULTRIUM2C--+
                    +-ULTRIUM3--+
                    +-ULTRIUM3C--+
                    +-ULTRIUM4--+
                    +-ULTRIUM4C--+
                    +-ULTRIUM5--+
                    +-ULTRIUM5C--+
                    +-ULTRIUM6--+
                    '-ULTRIUM6C-'
>--+-----+----->
  '-PREFIX---+ADSM-----+'
                    '-tape_volume_prefix-'
>--+-----+----->
```



If you are considering mixing different generations of LTO media and drives, be aware of the following restrictions.

Table 1. Read - write capabilities for different generations of LTO drives

Drives	Generation 1 media	Generation 2 media	Generation 3 media	Generation 4 media	Generation 5 media	Generation 6 media
Generation 1	Read and write	n/a	n/a	n/a	n/a	n/a
Generation 2	Read and write	Read and write	n/a	n/a	n/a	n/a
Generation 3 <sup>1</sup>	Read only	Read and write	Read and write	n/a	n/a	n/a
Generation 4 <sup>2</sup>	n/a	Read only	Read and write	Read and write	n/a	n/a
Generation 5 <sup>3</sup>	n/a	n/a	Read only	Read and write	Read and write	n/a
Generation 6 <sup>4</sup>	n/a	n/a	n/a	Read only	Read and write	Read and write

<sup>1</sup> In a library with a Generation 3 drive, all Generation 1 scratch volumes must be checked out, and all Generation 1 storage pool volumes must be updated to read-only.

<sup>2</sup> In a library with a Generation 4 drive, all Generation 2 scratch volumes must be checked out, and all Generation 2 storage pool volumes must be updated to read-only.

<sup>3</sup> In a library with a Generation 5 drive, all Generation 3 scratch volumes must be checked out, and all Generation 3 storage pool volumes must be updated to read-only.

<sup>4</sup> In a library with a Generation 6 drive, all Generation 4 scratch volumes must be checked out, and all Generation 4 storage pool volumes must be updated to read-only.

The following table lists the recording formats and estimated capacities for LTO devices:

Table 2. Recording format and default estimated capacity for LTO

Format	Estimated capacity	Description
DRIVE	-	The server selects the highest format that is supported by the drive on which a volume is mounted. Attention: Avoid specifying DRIVE when a mixture of drives is used within the same library. For example, do not use this option for a library that contains some drives that support recording formats superior to other drives.
ULTRIUM	100 GB	Uncompressed format, using Ultrium cartridges
ULTRIUMC	See note 200 GB	Compressed format, using Ultrium cartridges
ULTRIUM2	200 GB	Uncompressed (standard) format, using Ultrium 2 cartridges
ULTRIUM2C	See note 400 GB	Compressed format, using Ultrium 2 cartridges
ULTRIUM3	400 GB	Uncompressed (standard) format, using Ultrium 3 cartridges
ULTRIUM3C	See note 800 GB	Compressed format, using Ultrium 3 cartridges
ULTRIUM4	800 GB	Uncompressed (standard) format, using Ultrium 4 cartridges
ULTRIUM4C	See note 1.6 TB	Compressed format, using Ultrium 4 cartridges
ULTRIUM5	1.5 TB	Uncompressed (standard) format, using Ultrium 5 cartridges
ULTRIUM5C	See note 3.0 TB	Compressed format, using Ultrium 5 cartridges
ULTRIUM6	2.5 TB	Uncompressed (standard) format, using Ultrium 6 cartridges

Format	Estimated capacity	Description
ULTRIUM6C	See note 6.25 TB	Compressed format, using Ultrium 6 cartridges
Note: If this format uses the tape drive hardware compression feature, depending on the effectiveness of compression, the actual capacity might be greater than the listed value.		

#### ESTCAPacity

Specifies the estimated capacity for the sequential access volumes that are categorized by this device class. This parameter is optional.

You can specify this parameter if the default estimated capacity for the device class is inaccurate due to compression of data.

You must specify this value as an integer followed by one of the following unit indicators: **K** (kilobytes), **M** (megabytes), **G** (gigabytes), or **T** (terabytes). The smallest value that is accepted is 1 MB (ESTCAPACITY=1M).

For example, specify that the estimated capacity is 9 GB with the parameter ESTCAPACITY=9G.

To force the IBM Spectrum Protect server to determine the estimated capacity for the volumes that are assigned to this device class, specify ESTCAPACITY="".

For more information about estimated capacities, see Table 2.

#### PREFIX

Specifies the high-level qualifier of the data set name that the server writes into the sequential access media labels. For each sequential access volume assigned to this device class, the server uses this prefix to create the data set name. This parameter is optional. The maximum length of this prefix is 8 characters.

If you have a naming convention for media labels to support your current management system, use a volume prefix that conforms to your naming conventions.

Values that are specified for this parameter must meet the following conditions:

- The value is to be made up of qualifiers, which can be a maximum of eight characters including periods. For example, the following value is acceptable:

AB.CD2.E

- The qualifiers must be separated by a single period.
- The first letter of each qualifier must be alphabetic or national (@,#,\$), followed by alphabetic, national, hyphen, or numeric characters.

An example of a tape volume data set name using the default prefix is ADSM.BFS.

#### MOUNTRetention

Specifies the number of minutes that an idle sequential access volume is retained before it is dismounted. This parameter is optional. You can specify a number 0 - 9999.

This parameter can improve response time for sequential access media mounts by leaving previously mounted volumes online.

However, for EXTERNAL library types, setting this parameter to a low value (for example, two minutes) enhances device sharing between applications.

**Note:** For environments in which devices are shared across storage applications, the MOUNTRETENTION setting must be carefully considered. This parameter determines how long an idle volume remains in a drive. Some media managers do not dismount an allocated drive to satisfy pending requests. You might need to tune this parameter to satisfy competing mount requests while maintaining optimal system performance. Typically, problems arise more frequently when the MOUNTRETENTION parameter is set to a value that is too small, for example, zero.

#### MOUNTWait

Specifies the maximum number of minutes the server waits for an operator to respond to a request to either mount a volume in a drive in a manual library or check in a volume to be mounted in an automated library. This parameter is optional. If the mount request is not satisfied within the specified amount of time, the mount request is canceled. You can specify a number 0 - 9999.

Restriction: If the library that is associated with this device class is external (LIBTYPE=EXTERNAL), do not specify the MOUNTWAIT parameter.

#### MOUNTLimit

Specifies the maximum number of sequential access volumes that can be simultaneously mounted for the device class. This parameter is optional. You can specify a number 0 - 4096.

If you plan to use the simultaneous-write function, ensure that sufficient drives are available for the write operation. If the number of drives needed for a simultaneous-write operation is greater than the value of the MOUNTLIMIT parameter for a device class, the transaction fails.

The following are possible values:

#### DRIVES

Specifies that every time a mount point is allocated, the number of drives that are defined and online in the library is used to calculate the true value.

Note: For EXTERNAL library types, do not specify DRIVES for the MOUNTLIMIT value. Specify the number of drives for the library as the MOUNTLIMIT value.

#### number

Specifies the maximum number of drives in this device class that are used concurrently by the server. This value must never exceed the number of drives that are defined and online in the library that services this device class.

#### 0 (zero)

Specifies that no new transactions can gain access to the storage pool. Any current transactions continue and complete, but new transactions are terminated.

#### DRIVEEncryption

Specifies whether drive encryption is allowed. This parameter is optional. Drive encryption is supported only for Ultrium 4, Ultrium 5, and Ultrium 6 drives and media.

Restriction: If encryption is enabled for a device class, and the device class is associated with a storage pool, the storage pool should not share a scratch pool with other device classes that cannot be encrypted. If a tape is encrypted, and you plan to use it on a drive that cannot be encrypted, you must manually relabel the tape before it can be used on that drive.

#### ON

Specifies that IBM Spectrum Protect is the key manager for drive encryption and allows drive encryption for empty storage pool volumes only if the application method is enabled. (Other types of volumes are not encrypted. For example, back up sets, export volumes, and database backup volumes are not encrypted.) If you specify ON and you enable another method of encryption, drive encryption is not allowed and backup operations fail.

Note: You cannot specify IBM Spectrum Protect as the key manager for drive encryption of WORM (write once, read many) media. (If you are using WORM media, you cannot specify DRIVEENCRYPTION=ON.)

#### ALLOW

Specifies that IBM Spectrum Protect does not manage the keys for drive encryption. However, drive encryption for empty volumes is allowed if another method of encryption is enabled.

#### EXTERNAL

Specifies that IBM Spectrum Protect does not manage the keys for drive encryption. Use this setting with an encryption methodology that is provided by another vendor and that is used with Application Method Encryption (AME) enabled on the drive. When you specify EXTERNAL and IBM Spectrum Protect detects that AME encryption is enabled, IBM Spectrum Protect does not turn off encryption. By contrast, when you specify ALLOW and IBM Spectrum Protect detects that AME encryption is enabled, IBM Spectrum Protect turns off encryption.

#### OFF

Specifies that drive encryption is not allowed. If you enable another method of encryption, backups fail. If you enable the application method, IBM Spectrum Protect disables encryption and backups are attempted.

## Example: Update the mount limit for an LTO device class

---

Update a device class named LTOTAPE. Change the mount limit to 2.

```
update devclass ltotape mountlimit=2
```

## UPDATE DEVCLASS (Update a NAS device class)

---

Use the NAS device class when you are using NDMP (Network Data Management Protocol) operations to back up network-attached storage (NAS) file servers. The device class is for drives that are supported by the NAS file server for backups.

**AIX** | **Linux** The NAS device class does not support EXTERNAL libraries.

## Privilege class

---

To issue this command, you must have system privilege or unrestricted storage privilege.

## Syntax

---

```
>>-UPDate DEVclass--device_class_name----->
>--+-----+--+-----+----->
  '-LIBRARY---library_name-' '-MOUNTRetention---0-'
>--+-----+--+-----+----->
  '-MOUNTWait---minutes-' '-MOUNTLimit---+DRIVES+-'
                                     +-number+
                                     '-0-----'
>--+-----+----->
  '-ESTCAPacity---size-'
>--+-----+-----<<
  '-PREFIX---tape_volume_prefix-'
```

## Parameters

---

**device\_class\_name** (Required)

Specifies the name of the device class to be defined. The maximum length of the device class name is 30 characters.

**LIBRARY**

Specifies the name of the defined library object that contains the SCSI tape drives used by this device class. For information about defining a library object, see the DEFINE LIBRARY command.

**MOUNTRetention=0**

Specifies the number of minutes that an idle sequential access volume is retained before it is dismounted. Zero (0) is the only supported value for device classes with DEVType=NAS.

**MOUNTWait**

Specifies the maximum number of minutes the server waits for an operator to respond to a request to either mount a volume in a drive in a manual library or check in a volume to be mounted in an automated library. This parameter is optional. If the mount request is not satisfied within the specified amount of time, the mount request is canceled. You can specify a number 0 - 9999.

Restriction: If the library that is associated with this device class is external (LIBTYPE=EXTERNAL), do not specify the MOUNTWAIT parameter.

**MOUNTLimit**

Specifies the maximum number of sequential access volumes that can be simultaneously mounted for the device class. This parameter is optional. You can specify a number 0 - 4096.

If you plan to use the simultaneous-write function, ensure that sufficient drives are available for the write operation. If the number of drives needed for a simultaneous-write operation is greater than the value of the MOUNTLIMIT parameter for a device class, the transaction fails.

The following are possible values:

**DRIVES**

Specifies that every time a mount point is allocated, the number of drives that are defined and online in the library is used to calculate the true value.

Note: For EXTERNAL library types, do not specify DRIVES for the MOUNTLIMIT value. Specify the number of drives for the library as the MOUNTLIMIT value.

**number**

Specifies the maximum number of drives in this device class that are used concurrently by the server. This value must never exceed the number of drives that are defined and online in the library that services this device class.

**0 (zero)**

Specifies that no new transactions can gain access to the storage pool. Any current transactions continue and complete, but new transactions are terminated.

## ESTCAPacity

Specifies the estimated capacity for the volumes that are assigned to this device class. This parameter is optional.

You must specify this value as an integer followed by one of the following unit indicators: **K** (kilobytes), **M** (megabytes), **G** (gigabytes), or **T** (terabytes). The smallest value that is accepted is 1 MB (ESTCAPACITY=1M).

For example, specify that the estimated capacity is 9 GB with the parameter ESTCAPACITY=9G.

To force the IBM Spectrum Protect™ server to determine the estimated capacity for the volumes that are assigned to this device class, specify ESTCAPACITY="".

## PREFIX

Specifies the high-level qualifier of the data set name that the server writes into the sequential access media labels. For each sequential access volume assigned to this device class, the server uses this prefix to create the data set name. This parameter is optional. The maximum length of this prefix is 8 characters.

If you have a naming convention for media labels to support your current management system, use a volume prefix that conforms to your naming conventions.

Values that are specified for this parameter must meet the following conditions:

- The value is to be made up of qualifiers, which can be a maximum of eight characters including periods. For example, the following value is acceptable:

```
AB.CD2.E
```

- The qualifiers must be separated by a single period.
- The first letter of each qualifier must be alphabetic or national (@,#,\$), followed by alphabetic, national, hyphen, or numeric characters.

An example of a tape volume data set name using the default prefix is ADSM.BFS.

## Example: Update the estimated capacity for a NAS device class

---

Update a device class named NASTAPE. Change the estimated capacity to 200 GB.

```
update devclass nastape library=naslib estcapacity=200G
```

## UPDATE DEVCLASS (Update a REMOVABLEFILE device class)

---

Use the REMOVABLEFILE device class for removable media devices that are attached as local, removable file systems.

## Privilege class

---

To issue this command, you must have system privilege or unrestricted storage privilege.

## Syntax

---

```
>>-UPDate DEVclass--device_class_name----->
>--+-----+--+-----+----->
  '-LIBRARY----library_name-' '-MAXCAPacity----size-'
>--+-----+--+-----+----->
  '-MOUNTRetention----minutes-' '-MOUNTWait----minutes-'
>--+-----+--+-----+-----><
  '-MOUNTLimit-----+DRIVES-+-'
                        +-number-+
                        '-0-----'
```

## Parameters

---

device\_class\_name (Required)

Specifies the name of the device class to be updated.

LIBRARY

Specifies the name of the defined library object that contains the removable media drives used by this device class. This parameter is optional. For information about defining a library object, see the DEFINE LIBRARY command.

MAXCAPACITY

Specifies the maximum size of any volumes that are defined to a storage pool categorized by this device class. This parameter is optional.

**AIX** | **Windows** Because the server opens only one file per physical removable medium, specify a capacity that enables one file to make full use of your media capacity.

You must specify this value as an integer followed by **K** (kilobytes), **M** (megabytes), **G** (gigabytes), or **T** (terabytes).

For example, MAXCAPACITY=5M specifies that the maximum capacity for a volume in this device class is 5 MB. The smallest value that is allowed is 1 MB (that is, MAXCAPACITY=1M).

MOUNTRETENTION

Specifies the number of minutes that an idle sequential access volume is retained before it is dismounted. This parameter is optional. You can specify a number 0 - 9999.

This parameter can improve response time for sequential access media mounts by leaving previously mounted volumes online.

Note: For environments in which devices are shared across storage applications, the MOUNTRETENTION setting must be carefully considered. This parameter determines how long an idle volume remains in a drive. Some media managers do not dismount an allocated drive to satisfy pending requests. You might need to tune this parameter to satisfy competing mount requests while maintaining optimal system performance. Typically, problems arise more frequently when the MOUNTRETENTION parameter is set to a value that is too small, for example, zero.

MOUNTWAIT

Specifies the maximum number of minutes the server waits for an operator to respond to a request to either mount a volume in a drive in a manual library or check in a volume to be mounted in an automated library. This parameter is optional. If the mount request is not satisfied within the specified amount of time, the mount request is canceled. You can specify a number 0 - 9999.

Restriction: If the library that is associated with this device class is external (LIBTYPE=EXTERNAL), do not specify the MOUNTWAIT parameter.

MOUNTLIMIT

Specifies the maximum number of sequential access volumes that can be simultaneously mounted for the device class. This parameter is optional. You can specify a number 0 - 4096.

If you plan to use the simultaneous-write function, ensure that sufficient drives are available for the write operation. If the number of drives needed for a simultaneous-write operation is greater than the value of the MOUNTLIMIT parameter for a device class, the transaction fails.

The following are possible values:

DRIVES

Specifies that every time a mount point is allocated, the number of drives that are defined and online in the library is used to calculate the true value.

Note: For EXTERNAL library types, do not specify DRIVES for the MOUNTLIMIT value. Specify the number of drives for the library as the MOUNTLIMIT value.

number

Specifies the maximum number of drives in this device class that are used concurrently by the server. This value must never exceed the number of drives that are defined and online in the library that services this device class.

0 (zero)

Specifies that no new transactions can gain access to the storage pool. Any current transactions continue and complete, but new transactions are terminated.

## UPDATE DEVCLASS (Update a SERVER device class)

---

Use the SERVER device class to use storage volumes or files that are archived in another IBM Spectrum Protect™ server.

### Privilege class

---



To issue this command, you must have system privilege or unrestricted storage privilege.

## Syntax

---

```
>>-UPDdate DEVclass--device_class_name----->
>--+-----+--+-----+----->
  '-SERVERName----server_name-'  '-MAXCAPacity----size-'
>--+-----+--+-----+----->
  '-PREFIX----+ADSM-----+-'
      '-tape_volume_prefix-'
>--+-----+--+-----+----->
  '-RETRYPeriod-----minutes---'
>--+-----+--+-----+----->
  '-RETRYInterval-----seconds---'
>--+-----+--+-----+----->
  '-MOUNTRetention-----minutes-'
>--+-----+--+-----+-----><
  '-MOUNTLimit-----+number-+-'
      '-1-----'
```

## Parameters

---

device\_class\_name (Required)

Specifies the name of the device class to be updated.

SERVERName

Specifies the name of the server. The SERVERNAME parameter must match a defined server.

Note: If you change the SERVERNAME of an existing server to a new name, data on the volumes under the old SERVERNAME is no longer accessible with this device class.

MAXCAPacity

Specifies the maximum size that objects can be when created on the target server. This parameter is optional.

Specify this value as an integer followed by K (kilobytes), M (megabytes), G (gigabytes), or T (terabytes). The minimum value that is allowed is 1 MB (MAXCAPACITY=1M).

PREFIX

Specifies the beginning portion of the high-level archive file name on the target server. This parameter is optional. The maximum length of this prefix is 8 characters.

If you have a naming convention for media labels to support your current management system, use a volume prefix that conforms to your naming conventions.

Values that are specified for this parameter must meet the following conditions:

- The value is to be made up of qualifiers, which can be a maximum of eight characters including periods. For example, the following value is acceptable:

AB.CD2.E

- The qualifiers must be separated by a single period.
- The first letter of each qualifier must be alphabetic or national (@,#,\$), followed by alphabetic, national, hyphen, or numeric characters.

An example of a high-level archive file name that uses the default prefix is ADSM.volume1.

RETRYPeriod

Specifies the retry period in minutes. The retry period is the interval during which the server attempts to contact a target server if there is a suspected communications failure. This parameter is optional. You can specify a number 0 - 9999.

RETRYInterval

Specifies the retry interval in seconds. The retry interval is how often retries are done within a specific time period. This parameter is optional. You can specify a number 1 - 9999.

## MOUNTRetention

Specifies the number of minutes to retain an idle connection with the target server before the connection is closed. This parameter is optional. You can specify a number 0 - 9999.

Note: For environments in which devices are shared across storage applications, the MOUNTRETENTION setting must be carefully considered. This parameter determines how long an idle volume remains in a drive. Some media managers do not dismount an allocated drive to satisfy pending requests. You might need to tune this parameter to satisfy competing mount requests while maintaining optimal system performance. Typically, problems arise more frequently when the MOUNTRETENTION parameter is set to a value that is too small, for example, zero.

## MOUNTLimit

Specifies the maximum number of simultaneous sessions between the source server and the target server. Any attempts to access more sessions than indicated by the mount limit cause the requester to wait. This parameter is optional. You can specify a number 1 - 4096.

The following are possible values:

### number

Specifies the maximum number of simultaneous sessions between the source server and the target server.

1

Specifies the number of simultaneous sessions between the source server and the target server.

## UPDATE DEVCLASS (Update a VOLSAFE device class)

---

Use the VOLSAFE device type to work with StorageTek VolSafe brand media and drives. This technology uses media that cannot be overwritten. Therefore, do not use these media for short-term backups of client files, the server database, or export tapes.

### Privilege class

---

To issue this command, you must have system privilege or unrestricted storage privilege.

### Syntax

---

```
>>-UPDate DEVclass--device_class_name----->
>--+-----+--+-----+-----+-----+-----+----->
  '-LIBRARY---library_name-'  '-FORMAT---+--DRIVE-----+'
                                     +-9840-----+
                                     +-9840-C----+
                                     +-T9840C----+
                                     +-T9840C-C--+
                                     +-T9840D----+
                                     +-T9840D-C--+
                                     +-T10000A---+
                                     +-T10000A-C-+
                                     +-T10000B---+
                                     +-T10000B-C-+
                                     +-T10000C---+
                                     +-T10000C-C-+
                                     +-T10000D---+
                                     '-T10000D-C-'
>--+-----+--+-----+-----+-----+-----+----->
  '-ESTCAPacity---size-'
>--+-----+--+-----+-----+-----+-----+----->
  '-PREFIX---+--ADSM-----+-'
                '-tape_volume_prefix-'
>--+-----+--+-----+-----+-----+-----+----->
  '-MOUNTRetention---minutes-'  '-MOUNTWait---minutes-'
>--+-----+--+-----+-----+-----+-----+-----><
  '-MOUNTLimit---+--DRIVES--+-'
                    +-number-+
                    '-0-----'
```

### Parameters

---

device\_class\_name (Required)

Specifies the name of the device class to be updated. The maximum length of the device class name is 30 characters.

LIBRARY

Specifies the name of the defined library object that contains the VolSafe drives that can be used by this device class. If any drives in a library are VolSafe-enabled, all drives in the library must be VolSafe-enabled. For more information about the VolSafe device type, see DEFINE DEVCLASS (Define a VOLSAFE device class).

FORMAT

Specifies the recording format to be used when data is written to sequential access media. This parameter is optional. The default value is DRIVE.

Attention: If you specify DRIVE for a device class that has non-compatible sequential access devices, then you must mount volumes on devices that are capable of reading or writing the format that is established when the volume was first mounted. This can cause delays if the only sequential access device that can access the volume is already in use.

The following table lists the recording formats and estimated capacities for VolSafe devices:

Table 1. Recording formats and default estimated capacities for volsafe tapes

Format	Estimated Capacity	Description
DRIVE	–	The server selects the highest format that is supported by the drive on which a volume is mounted. Attention: Avoid specifying DRIVE when a mixture of drives is used within the same library. For example, do not use this option for a library that contains some drives that support recording formats superior to other drives.
9840	20 GB	Uncompressed (standard) format, using a 20 GB cartridge with 270 meters (885 feet) of tape
9840-C	80 GB	LZ-1 Enhanced (4:1) compressed format, using an 80 GB cartridge with 270 meters (885 feet) of tape
T9840C	40 GB	Uncompressed T9840C format, using a StorageTek 9840 cartridge
T9840C-C	80 GB	Compressed T9840C format, using a StorageTek 9840 cartridge
T9840D	75 GB	Uncompressed T9840D format, using a StorageTek 9840 cartridge
T9840D-C	150 GB	Compressed T9840D format, using a StorageTek 9840 cartridge
T10000A	500 GB	Uncompressed T10000A format, using a StorageTek T10000 cartridge
T10000A-C	1 TB	Compressed T10000A format, using a StorageTek T10000 cartridge
T10000B	1 TB	Uncompressed T10000B format, using an Oracle StorageTek T10000 cartridge
T10000B-C	2 TB	Compressed T10000B format, using an Oracle StorageTek T10000 cartridge
T10000C	5 TB	Uncompressed T10000C format, using an Oracle StorageTek T10000 T2 cartridge
T10000C-C	10 TB	Compressed T10000C format, using an Oracle StorageTek T10000 T2 cartridge
T10000D	8 TB	Uncompressed T10000D format, using an Oracle StorageTek T10000 T2 cartridge
T10000D-C	15 TB	Compressed T10000D format, using an Oracle StorageTek T10000 T2 cartridge

ESTCAPACITY

Specifies the estimated capacity for the volumes that are assigned to this device class. This parameter is optional.

You can specify this parameter if the default estimated capacity for the device class is inaccurate due to compression of data.

You must specify this value as an integer followed by one of the following unit indicators: K (kilobytes), M (megabytes), G (gigabytes), or T (terabytes). The smallest value that is accepted is 1 MB (ESTCAPACITY=1M).

For example, specify that the estimated capacity is 9 GB with the parameter ESTCAPACITY=9G.

To force the IBM Spectrum Protect™ server to determine the estimated capacity for the volumes that are assigned to this device class, specify ESTCAPACITY="".

For more information about the default estimated capacity for cartridge tapes, see Table 1.

#### PREFIX

Specifies the beginning portion of the high-level archive file name on the target server. This parameter is optional. The maximum length of this prefix is 8 characters.

If you have a naming convention for media labels to support your current management system, use a volume prefix that conforms to your naming conventions.

Values that are specified for this parameter must meet the following conditions:

- The value is to be made up of qualifiers, which can be a maximum of eight characters including periods. For example, the following value is acceptable:

AB.CD2.E

- The qualifiers must be separated by a single period.
- The first letter of each qualifier must be alphabetic or national (@,#,\$), followed by alphabetic, national, hyphen, or numeric characters.

An example of a high-level archive file name that uses the default prefix is ADSM.volume1.

#### MOUNTRetention

Specifies the number of minutes that an idle sequential access volume is retained before it is dismounted. This parameter is optional. You can specify a number 0 - 9999.

This parameter can improve response time for sequential access media mounts by leaving previously mounted volumes online.

However, for EXTERNAL library types (that is, a library that is managed by an external media management system), set this parameter to a low value (for example, two minutes) to enhance device sharing between applications.

Note: For environments in which devices are shared across storage applications, the MOUNTRETENTION setting must be carefully considered. This parameter determines how long an idle volume remains in a drive. Some media managers do not dismount an allocated drive to satisfy pending requests. You might need to tune this parameter to satisfy competing mount requests while maintaining optimal system performance. Typically, problems arise more frequently when the MOUNTRETENTION parameter is set to a value that is too small, for example, zero.

#### MOUNTWait

Specifies the maximum number of minutes the server waits for an operator to respond to a request to either mount a volume in a drive in a manual library or check in a volume to be mounted in an automated library. This parameter is optional. If the mount request is not satisfied within the specified amount of time, the mount request is canceled. You can specify a number 0 - 9999.

Restriction: If the library that is associated with this device class is external (LIBTYPE=EXTERNAL), do not specify the MOUNTWAIT parameter.

#### MOUNTLimit

Specifies the maximum number of sequential access volumes that can be simultaneously mounted for the device class. This parameter is optional. You can specify a number 0 - 4096.

If you plan to use the simultaneous-write function, ensure that sufficient drives are available for the write operation. If the number of drives needed for a simultaneous-write operation is greater than the value of the MOUNTLIMIT parameter for a device class, the transaction fails.

The following are possible values:

#### DRIVES

Specifies that every time a mount point is allocated, the number of drives that are defined and online in the library is used to calculate the true value.

Note: For EXTERNAL library types, do not specify DRIVES for the MOUNTLIMIT value. Specify the number of drives for the library as the MOUNTLIMIT value.

number

Specifies the maximum number of drives in this device class that are used concurrently by the server. This value must never exceed the number of drives that are defined and online in the library that services this device class.

0 (zero)

Specifies that no new transactions can gain access to the storage pool. Any current transactions continue and complete, but new transactions are terminated.

AIX Linux

## UPDATE DEVCLASS - z/OS media server (Update device class for z/OS media server)

Use this command to update a device class. A limited set of device class types is available for devices that are accessed through a z/OS® media server.

- UPDATE DEVCLASS (Update a 3590 device class for z/OS media server)
- UPDATE DEVCLASS (Update a 3592 device class for z/OS media server)
- UPDATE DEVCLASS (Update an ECARTRIDGE device class for z/OS media server)
- UPDATE DEVCLASS (Update a FILE device class for z/OS media server)

Table 1. Commands related to UPDATE DEVCLASS

Command	Description
BACKUP DEVCONFIG	Backs up IBM Spectrum Protect device information to a file.
DEFINE DEVCLASS (z/OS media server)	Defines a device class to use storage managed by a z/OS media server.
DEFINE LIBRARY	Defines an automated or manual library.
DELETE DEVCLASS	Deletes a device class.
QUERY DEVCLASS	Displays information about device classes.
UPDATE LIBRARY	Changes the attributes of a library.

AIX Linux

## UPDATE DEVCLASS (Update a 3590 device class for z/OS media server)

Use this command to update a device class that you defined to use a z/OS® media server to access 3590 devices. The device class that targets storage for the z/OS media server requires a library definition of type ZOSMEDIA.

### Privilege class

To issue this command, you must have system privilege or unrestricted storage privilege.

### Syntax

```

(1) (2)
>>-UPDate DEVclass--device_class_name----->
>--+-----+-----+-----+----->
  '-LIBRARY---library_name-' '-FORMAT---+DRIVE---+'
                                     +-3590B---+
                                     +-3590C---+
                                     +-3590E-B-+
                                     +-3590E-C-+
                                     +-3590H-B-+
                                     '-3590H-C-'
>--+-----+-----+-----+----->
  '-ESTCAPacity---size-' '-COMpression---+Yes-+-'
                                     '-No--'
>--+-----+-----+-----+----->
  '-MOUNTRetention---minutes-' '-MOUNTWait---minutes-'
>--+-----+-----+-----+----->
  '-MOUNTLimit---+DRIVES-+-' '-EXPIration---yyyyddd-'
                                     +-number-+

```

```

      '-0-----'
>---+-----+-----+-----+-----+-----+-----+----->
  '-REtention-----days-'  '-PROtection-----+No-----+-'
                               +-Yes-----+
                               '-Automatic-'
>---+-----+-----+-----+-----+-----+-----+-----><
  '-UNIT-----unit_name-'

```

**Notes:**

1. You must specify at least one optional parameter on this command.
2. You cannot update the PREFIX parameter with this command. You must create a device class with the value that you require for the PREFIX parameter.

## Parameters

**device\_class\_name** (Required)

Specifies the name of the device class to be updated.

**LIBRARY**

Specifies the name of a library that was defined with the LIBTYPE=ZOSMEDIA parameter. The library and the tape drives that can be used by this device class are controlled by the z/OS media server.

This parameter is optional.

For information about defining a library, see the DEFINE LIBRARY command.

**FORMAT**

Specifies the recording format to be used when data is written to sequential access media. This parameter is optional. The following table lists the recording format options for 3590 devices:

Table 1. Recording formats for 3590

Format	Description
3590B	Uncompressed (basic) format
3590C	Compressed format
3590E-B	Uncompressed (basic) format, similar to the 3590B format
3590E-C	Compressed format, similar to the 3590C format
3590H-B	Uncompressed (basic) format, similar to the 3590B format
3590H-C	Compressed format, similar to the 3590C format
Note: If the format uses the tape drive hardware compression feature the actual capacity can increase, depending on the effectiveness of compression.	

**ESTCAPacity**

Specifies the estimated capacity for the sequential access volumes that are categorized by this device class. This parameter is optional.

You can specify this parameter if the default estimated capacity for the device class is inaccurate because of compression of data. The value does not determine the amount of data stored on the volume. The server uses the value to estimate the usage before a volume is filled. After a volume is full, the actual amount of data stored on the tape is used for the usage calculation.

Specify the value as an integer with one of the following unit indicators: K (KB), M (MB), G (GB), or T (TB). For example, specify that the estimated capacity is 9 GB with the parameter ESTCAPACITY=9G. The smallest value that is accepted is 100 KB (ESTCAPACITY=100K).

**COMPression**

Specifies whether file compression is used for this device class. This parameter is optional.

You can specify one of the following values:

Yes

Specifies that the data for each tape volume is compressed.

No

Specifies that the data for each tape volume is not compressed.

#### MOUNTRetention

Specifies the number of minutes that an idle tape volume is retained before it is dismounted. The time span for mount retention begins after the idle timeout period has expired. This parameter is optional. Specify a number, 0 - 9999.

This parameter can improve response time for sequential access media mounts by leaving previously mounted volumes online.

#### MOUNTWait

Specifies the maximum number of minutes that the z/OS media server waits for a volume mount. If the mount request is not satisfied within the specified time, the mount request fails. If a device is successfully allocated and the device-open request does not complete within the specified time, the device-open request ends and the mount request fails.

This parameter is optional. Specify a number, 1 - 9999.

Restriction: If the library that is associated with this device class is external (LIBTYPE=EXTERNAL), do not specify the MOUNTWAIT parameter.

#### MOUNTLimit

Specifies the maximum number of sequential access volumes that can be simultaneously mounted for the device class. This parameter is optional.

If you plan to use the simultaneous-write function, ensure that sufficient drives are available for the write operation. If the number of drives needed for a simultaneous-write operation is greater than the value of the MOUNTLIMIT parameter for a device class, the transaction fails.

You can specify one of the following values:

#### DRIVES

Specifies that every time a mount point is allocated, the number of drives that are defined and online in the library is used to calculate the true value.

#### number

Specifies the maximum number of drives in this device class that are used concurrently by the server. This value must never exceed the number of drives that are defined and online in the library that services this device class. You can specify a number, 0 - 4096.

#### 0 (zero)

Specifies that no new transactions can gain access to the storage pool.

#### EXPIration

Specifies the expiration date that is placed on the tape labels for this device class. This parameter is optional.

Specify the date when the server no longer requires the tape. The server does not use this information, but this information is passed to the z/OS media server for use by z/OS or tape management systems.

Specify the expiration date using the format, *yyyyddd* (four digits for the year and three digits for the day). For example, January 7, 2014 is specified as 2014007 (the seventh day of year 2014).

If you specify the EXPIRATION parameter, you cannot specify the RETENTION parameter.

#### RETention

Specifies the number of days to retain the tape. This parameter is optional.

Specify the number of days (1 - 9999) that the server is expected to use the tape. The server does not use this information, but this information is passed to the z/OS media server for use by z/OS or tape management systems.

If you specify the RETENTION parameter, you cannot specify the EXPIRATION parameter.

Tip: You can specify a value of zero for this parameter. However, do so only if you also want to specify a value for the EXPIRATION parameter. You cannot specify a value for the EXPIRATION parameter if you specify a non-zero value for the RETENTION parameter.

#### PROtection

Specifies whether the RACF® program, if installed, protects volumes that are assigned to this device class. If protection is provided, RACF profiles are created when volumes are first used. This parameter is optional. You can specify one of the following values:

No

Specifies that the RACF program does not protect volumes that are assigned to this device class.

Yes

Specifies that the RACF program protects volumes that are assigned to this device class. RACF profiles are created for volumes when the server first uses the volumes, but the profiles are not deleted when volumes are deleted from the server. Profiles must be manually deleted.

Tip: If sensitive data is stored on volumes that are assigned to this device class, use PROTECTION=YES and manually delete RACF profiles only after tape volumes have been erased.

The profiles that are created for volumes depend on the system RACF settings. The protection that is provided is the same as using PROTECT=YES in JCL. If the RACF program is active and both TAPEVOL and TAPEDSN are inactive, allocation of tapes fails.

Automatic

Specifies that the RACF program protects volumes that are assigned to this device class. RACF profiles are created for volumes when the server first uses the volumes. RACF profiles are deleted when volumes are deleted from the server.

The profiles that are created for volumes depend on the system RACF settings. The protection that is provided is the same as using PROTECT=YES in JCL. If the RACF program is active and both TAPEVOL and TAPEDSN are inactive, allocation of tapes fails.

Important: If you specify PROTECTION=AUTOMATIC, when a volume is deleted, its RACF profile is deleted. The volume therefore is no longer protected by the RACF program. The data on these volumes can be accessed by other users.

If you specify PROTECTION=AUTOMATIC, the z/OS media server issues RACROUTE commands to delete profiles when a volume is deleted from the server. The deletion commands that are issued depend on the current system settings for TAPEVOL and TAPEDSN. If the system settings are changed, the z/OS media server might not delete existing profiles.

Do not change the setting to PROTECTION=AUTOMATIC for a device class that was set to PROTECTION=NO. Volumes without profiles might exist and error messages are generated when such volumes are deleted. If a different value for PROTECTION is required, define a new device class.

Profile creation and deletion occur based on the protection setting when the volume is first used and when it is deleted. The server does not attempt to create profiles for volumes that it has already used. If protection is set to AUTOMATIC, the server attempts to delete profiles when volumes are deleted.

See the documentation for the RACF program for details about the TAPEVOL and TAPEDSN settings and the profiles that are created when these settings are active.

UNIT

Specifies an esoteric unit name to specify a group of tape devices that support 3590 tape. This parameter is optional. The unit name can be up to 8 characters.

AIX

Linux

## UPDATE DEVCLASS (Update a 3592 device class for z/OS media server)

Use this command to update a device class that you defined to use a z/OS® media server to access 3592 devices. The device class that targets storage for the z/OS media server requires a library definition of type ZOSMEDIA.

### Privilege class

To issue this command, you must have system privilege or unrestricted storage privilege.

### Syntax

```
                (1) (2)
>>-UPDate DEVclass--device_class_name----->
>--+-----+----->
    '-LIBRARY----zos_media_library-'
```



```

>---+-----+-----+-----+-----+----->
  '-FORMAT-----+DRIVE---+'  '-ESTCAPacity---size-'
      +-3592-----+
      +-3592C---+
      +-3592-2---+
      +-3592-2C--+
      +-3592-3---+
      +-3592-3C--+
      +-3592-4---+
      +'-3592-4C-'

>---+-----+-----+-----+-----+----->
  '-COMPression-----+Yes-+-'
      +'-No--'

>---+-----+-----+-----+-----+----->
  '-MOUNTRetention---minutes-'  '-MOUNTWait---minutes-'

>---+-----+-----+-----+-----+----->
  '-MOUNTLimit-----+DRIVES-+-'  '-EXPIration---yyyyddd-'
      +-number-+
      +'-0-----'

>---+-----+-----+-----+-----+----->
  '-RETention---days-'  '-PROtection---+No-----+-'
      +'-Yes-----+
      +'-Automatic-'

>---+-----+-----+-----+-----+----->>
  '-UNIT-----unit_name-'

```

**Notes:**

1. You must specify at least one optional parameter on this command.
2. You cannot update the PREFIX parameter with this command. You must create a device class with the value that you require for the PREFIX parameter.

## Parameters

device\_class\_name (Required)

Specifies the name of the device class to be updated. The maximum length of the device class name is 30 characters.

LIBRARY

Specifies the name of a library that was defined with the LIBTYPE=ZOSMEDIA parameter. The library and the tape drives that can be used by this device class are controlled by the z/OS media server.

This parameter is optional.

For information about defining a library, see the DEFINE LIBRARY command.

FORMAT

Specifies the recording format to be used when data is written to sequential access media. This parameter is optional. The default value is DRIVE.

See the following table for the recording formats.

Table 1. Recording formats for 3592

Format	Description
3592	Uncompressed (basic) format
3592C	Compressed format
3592-2	Uncompressed (basic) format, similar to the 3592 format
3592-C	Compressed format, similar to the 3592C format
3592-3	Uncompressed (basic) format, similar to the 3592 format
3592-3C	Compressed format, similar to the 3592C format

Format	Description
3592-4	Uncompressed (basic) format, similar to the 3592 format
3592-4C	Compressed format, similar to the 3592C format
DRIVE	The server selects the highest format that is supported by the drive on which a volume is mounted. Attention: Avoid specifying DRIVE when a mixture of drives is used within the same library. For example, do not use this option for a library containing some drives that support recording formats superior to other drives.
Note: If this format uses the tape drive hardware compression feature, depending on the effectiveness of compression, the actual capacity might be different from the listed value.	

If the drives are in a library that includes drives of different tape technology, do not use the DRIVE value. Use the specific format that the drives use. For optimal results, do not mix generations of drives in the same library. If a library contains mixed generations, media problems can result. For example, generation 1 and generation 2 drives cannot read generation 3 media. If possible, upgrade all drives to 3592 generation 3. If you cannot upgrade all drives to 3592 generation 3, you must use a special configuration.

#### ESTCAPacity

Specifies the estimated capacity for the volumes that are assigned to this device class. This parameter is optional.

You can specify this parameter if the default estimated capacity for the device class is inaccurate because of compression of data. The value does not determine the amount of data stored on the volume. The server uses the value to estimate the usage before a volume is filled. After a volume is full, the actual amount of data stored on the tape is used for the usage calculation.

Specify the value as an integer with one of the following unit indicators: **K** (KB), **M** (MB), **G** (GB), or **T** (TB). For example, specify that the estimated capacity is 9 GB with the parameter ESTCAPACITY=9G. The smallest value that is accepted is 100 KB (ESTCAPACITY=100K).

#### COMPression

Specifies whether file compression is used for this device class. This parameter is optional. The default value is YES. You can specify one of the following values:

Yes

Specifies that the data for each tape volume is compressed.

No

Specifies that the data for each tape volume is not compressed.

#### MOUNTRetention

Specifies the number of minutes that an idle tape volume is retained before it is dismounted. The time span for mount retention begins after the idle timeout period has expired. This parameter is optional. Specify a number, 0 - 9999.

This parameter can improve response time for sequential access media mounts by leaving previously mounted volumes online.

#### MOUNTWait

Specifies the maximum number of minutes that the z/OS media server waits for a volume mount. If the mount request is not satisfied within the specified time, the mount request fails. If a device is successfully allocated and the device-open request does not complete within the specified time, the device-open request ends and the mount request fails.

This parameter is optional. Specify a number, 1 - 9999.

Restriction: If the library that is associated with this device class is external (LIBTYPE=EXTERNAL), do not specify the MOUNTWAIT parameter.

#### MOUNTLimit

Specifies the maximum number of sequential access volumes that can be simultaneously mounted for the device class. This parameter is optional.

If you plan to use the simultaneous-write function, ensure that sufficient drives are available for the write operation. If the number of drives needed for a simultaneous-write operation is greater than the value of the MOUNTLIMIT parameter for a device class, the transaction fails.

You can specify one of the following values:

#### DRIVES

Specifies that every time a mount point is allocated, the number of drives that are defined and online in the library is used to calculate the true value.

#### number

Specifies the maximum number of drives in this device class that are used concurrently by the server. This value must never exceed the number of drives that are defined and online in the library that services this device class. You can specify a number, 0 - 4096.

#### 0 (zero)

Specifies that no new transactions can gain access to the storage pool.

#### EXPIration

Specifies the expiration date that is placed on the tape labels for this device class. This parameter is optional.

Specify the date when the server no longer requires the tape. The server does not use this information, but this information is passed to the z/OS media server for use by z/OS or tape management systems.

Specify the expiration date using the format, *yyyymmdd* (four digits for the year and three digits for the day). For example, January 7, 2014 is specified as *2014007* (the seventh day of year 2014).

If you specify the EXPIRATION parameter, you cannot specify the RETENTION parameter.

#### RETention

Specifies the number of days to retain the tape. This parameter is optional.

Specify the number of days (1 - 9999) that the server is expected to use the tape. The server does not use this information, but this information is passed to the z/OS media server for use by z/OS or tape management systems.

If you specify the RETENTION parameter, you cannot specify the EXPIRATION parameter.

Tip: You can specify a value of zero for this parameter. However, do so only if you also want to specify a value for the EXPIRATION parameter. You cannot specify a value for the EXPIRATION parameter if you specify a non-zero value for the RETENTION parameter.

#### PROtection

Specifies whether the RACF® program, if installed, protects volumes that are assigned to this device class. If protection is provided, RACF profiles are created when volumes are first used. This parameter is optional. You can specify one of the following values:

#### No

Specifies that the RACF program does not protect volumes that are assigned to this device class.

#### Yes

Specifies that the RACF program protects volumes that are assigned to this device class. RACF profiles are created for volumes when the server first uses the volumes, but the profiles are not deleted when volumes are deleted from the server. Profiles must be manually deleted.

Tip: If sensitive data is stored on volumes that are assigned to this device class, use PROTECTION=YES and manually delete RACF profiles only after tape volumes have been erased.

The profiles that are created for volumes depend on the system RACF settings. The protection that is provided is the same as using PROTECT=YES in JCL. If the RACF program is active and both TAPEVOL and TAPEDSN are inactive, allocation of tapes fails.

#### Automatic

Specifies that the RACF program protects volumes that are assigned to this device class. RACF profiles are created for volumes when the server first uses the volumes. RACF profiles are deleted when volumes are deleted from the server.

The profiles that are created for volumes depend on the system RACF settings. The protection that is provided is the same as using PROTECT=YES in JCL. If the RACF program is active and both TAPEVOL and TAPEDSN are inactive, allocation of tapes fails.

Important: If you specify PROTECTION=AUTOMATIC, when a volume is deleted, its RACF profile is deleted. The volume therefore is no longer protected by the RACF program. The data on these volumes can be accessed by other users.

If you specify PROTECTION=AUTOMATIC, the z/OS media server issues RACROUTE commands to delete profiles when a volume is deleted from the server. The deletion commands that are issued depend on the current system settings for TAPEVOL and TAPEDSN. If the system settings are changed, the z/OS media server might not delete existing profiles.

Do not change the setting to PROTECTION=AUTOMATIC for a device class that was set to PROTECTION=NO. Volumes without profiles might exist and error messages are generated when such volumes are deleted. If a different value for PROTECTION is required, define a new device class.

Profile creation and deletion occur based on the protection setting when the volume is first used and when it is deleted. The server does not attempt to create profiles for volumes that it has already used. If protection is set to AUTOMATIC, the server attempts to delete profiles when volumes are deleted.

See the documentation for the RACF program for details about the TAPEVOL and TAPEDSN settings and the profiles that are created when these settings are active.

#### UNIT

Specifies an esoteric unit name to specify a group of tape devices that support 3592 tape. This parameter is optional. This name can be as many as 8 characters.

AIX Linux

## UPDATE DEVCLASS (Update an ECARTRIDGE device class for z/OS media server)

Use this command to update a device class that you defined to use a z/OS® media server to access StorageTek drives such as the StorageTek T9840 or T10000. The device class that targets storage for the z/OS media server requires a library definition of type ZOSMEDIA.

### Privilege class

To issue this command, you must have system privilege or unrestricted storage privilege.

### Syntax

```

(1) (2)
>>-UPDate DEVclass--device_class_name----->
>--+-----+----->
  '-LIBRARY----zos_media_library-'
>--+-----+----->
  '-FORMAT----+DRIVE----+' '-ESTCAPacity----size-'
      +-T9840C----+
      +-T9840C-C--+
      +-T9840D----+
      +-T9840D-C--+
      +-T10000A----+
      +-T10000A-C--+
      +-T10000B----+
      +-T10000B-C--+
      +-T10000C----+
      +-T10000C-C--+
      +-T10000D----+
      +-T10000D-C-'
>--+-----+----->
  '-MOUNTRetention----minutes-' '-MOUNTWait----minutes-'
>--+-----+----->
  '-MOUNTLimit----+DRIVES--++' '-COMPRESSion----+Yes--++'
      +-number+          '-No--'
      '-0-----'
>--+-----+----->
  '-EXPIration----yyyymmdd-' '-RETention----days-'

```

```
>-----+-----+-----+-----<<
'-PROtection-----+No-----+-' '-UNIT-----unit_name-'
      +-Yes-----+
      '-Automatic-'
```

Notes:

1. You must specify at least one optional parameter on this command.
2. You cannot update the PREFIX parameter with this command. You must create a device class with the value that you require for the PREFIX parameter.

## Parameters

device\_class\_name (Required)

Specifies the name of the device class to be updated.

LIBRARY

Specifies the name of a library that was defined with the LIBTYPE=ZOSMEDIA parameter. The library and the tape drives that can be used by this device class are controlled by the z/OS media server.

This parameter is optional.

For information about defining a library, see the DEFINE LIBRARY command.

FORMAT

Specifies the recording format to be used when data is written to sequential access media. This parameter is optional. See the following table for the recording formats.

Table 1. Recording formats for ECARTRIDGE tapes

Format	Estimated Capacity	Description
DRIVE	-	The server selects the highest format that is supported by the drive on which a volume is mounted. DRIVE is the default value. Attention: Avoid specifying DRIVE when a mixture of drives is used within the same library. For example, do not use this option for a library containing some drives that support recording formats superior to other drives.
T9840C	40 GB	Uncompressed T9840C format, using a StorageTek 9840 cartridge
T9840C-C	80 GB	Compressed T9840C format, using a StorageTek 9840 cartridge
T9840D	75 GB	Uncompressed T9840D format, using a StorageTek 9840 cartridge
T9840D-C	150 GB	Compressed T9840D format, using a StorageTek 9840 cartridge
T10000A	500 GB	Uncompressed T10000A format, using a StorageTek T10000 cartridge
T10000A-C	1 TB	Compressed T10000A format, using a StorageTek T10000 cartridge
T10000B	1 TB	Uncompressed T10000B format, using an Oracle StorageTek T10000 cartridge
T10000B-C	2 TB	Compressed T10000B format, using an Oracle StorageTek T10000 cartridge
T10000C	5 TB	Uncompressed T10000C format, using an Oracle StorageTek T10000 T2 cartridge
T10000C-C	10 TB	Compressed T10000C format, using an Oracle StorageTek T10000 T2 cartridge
T10000D	8 TB	Uncompressed T10000D format, using an Oracle StorageTek T10000 T2 cartridge
T10000D-C	15 TB	Compressed T10000D format, using an Oracle StorageTek T10000 T2 cartridge

Format	Estimated Capacity	Description
<p>Note:</p> <ul style="list-style-type: none"> <li>Some formats use a compression feature of the tape drive hardware. Depending on the effectiveness of compression, the actual capacity might be double or more than the listed value.</li> <li>T10000A drives can read and write the T10000A format only. T10000B drives can read, but cannot write, the T10000A format. T10000C drives can read, but cannot write, the T10000A and T10000B formats. T10000D drives can read, but cannot write, the T10000A, T10000B, and T10000C formats.</li> </ul>		

#### ESTCAPacity

Specifies the estimated capacity for the sequential access volumes that are assigned to this device class. This parameter is optional.

You can specify this parameter if the default estimated capacity for the device class is inaccurate because of compression of data. The value does not determine the amount of data stored on the volume. The server uses the value to estimate the usage before a volume is filled. After a volume is full, the actual amount of data stored on the tape is used for the usage calculation.

Specify the value as an integer with one of the following unit indicators: **K** (KB), **M** (MB), **G** (GB), or **T** (TB). For example, specify that the estimated capacity is 9 GB with the parameter `ESTCAPACITY=9G`. The smallest value that is accepted is 100 KB (`ESTCAPACITY=100K`).

#### MOUNTRetention

Specifies the number of minutes that an idle tape volume is retained before it is dismounted. The time span for mount retention begins after the idle timeout period has expired. This parameter is optional. Specify a number, 0 - 9999.

This parameter can improve response time for sequential access media mounts by leaving previously mounted volumes online.

#### MOUNTWait

Specifies the maximum number of minutes that the z/OS media server waits for a volume mount. If the mount request is not satisfied within the specified time, the mount request fails. If a device is successfully allocated and the device-open request does not complete within the specified time, the device-open request ends and the mount request fails.

This parameter is optional. Specify a number, 1 - 9999.

Restriction: If the library that is associated with this device class is external (`LIBTYPE=EXTERNAL`), do not specify the `MOUNTWAIT` parameter.

#### MOUNTLimit

Specifies the maximum number of sequential access volumes that can be simultaneously mounted for the device class. This parameter is optional.

If you plan to use the simultaneous-write function, ensure that sufficient drives are available for the write operation. If the number of drives needed for a simultaneous-write operation is greater than the value of the `MOUNTLIMIT` parameter for a device class, the transaction fails.

You can specify one of the following values:

##### DRIVES

Specifies that every time a mount point is allocated, the number of drives that are defined and online in the library is used to calculate the true value.

##### number

Specifies the maximum number of drives in this device class that are used concurrently by the server. This value must never exceed the number of drives that are defined and online in the library that services this device class. You can specify a number, 0 - 4096.

##### 0 (zero)

Specifies that no new transactions can gain access to the storage pool.

#### COMPression

Specifies whether file compression is used for this device class. This parameter is optional.

You can specify one of the following values:

##### Yes

Specifies that the data for each tape volume is compressed.

No

Specifies that the data for each tape volume is not compressed.

#### EXPIration

Specifies the expiration date that is placed on the tape labels for this device class. This parameter is optional.

Specify the date when the server no longer requires the tape. The server does not use this information, but this information is passed to the z/OS media server for use by z/OS or tape management systems.

Specify the expiration date using the format, *yyyyddd* (four digits for the year and three digits for the day). For example, January 7, 2014 is specified as *2014007* (the seventh day of year 2014).

If you specify the EXPIRATION parameter, you cannot specify the RETENTION parameter.

#### RETention

Specifies the number of days to retain the tape. This parameter is optional.

Specify the number of days (1 - 9999) that the server is expected to use the tape. The server does not use this information, but this information is passed to the z/OS media server for use by z/OS or tape management systems.

If you specify the RETENTION parameter, you cannot specify the EXPIRATION parameter.

Tip: You can specify a value of zero for this parameter. However, do so only if you also want to specify a value for the EXPIRATION parameter. You cannot specify a value for the EXPIRATION parameter if you specify a non-zero value for the RETENTION parameter.

#### PROtection

Specifies whether the RACF® program, if installed, protects volumes that are assigned to this device class. If protection is provided, RACF profiles are created when volumes are first used. This parameter is optional. You can specify one of the following values:

No

Specifies that the RACF program does not protect volumes that are assigned to this device class.

Yes

Specifies that the RACF program protects volumes that are assigned to this device class. RACF profiles are created for volumes when the server first uses the volumes, but the profiles are not deleted when volumes are deleted from the server. Profiles must be manually deleted.

Tip: If sensitive data is stored on volumes that are assigned to this device class, use PROTECTION=YES and manually delete RACF profiles only after tape volumes have been erased.

The profiles that are created for volumes depend on the system RACF settings. The protection that is provided is the same as using PROTECT=YES in JCL. If the RACF program is active and both TAPEVOL and TAPEDSN are inactive, allocation of tapes fails.

#### Automatic

Specifies that the RACF program protects volumes that are assigned to this device class. RACF profiles are created for volumes when the server first uses the volumes. RACF profiles are deleted when volumes are deleted from the server.

The profiles that are created for volumes depend on the system RACF settings. The protection that is provided is the same as using PROTECT=YES in JCL. If the RACF program is active and both TAPEVOL and TAPEDSN are inactive, allocation of tapes fails.

Important: If you specify PROTECTION=AUTOMATIC, when a volume is deleted, its RACF profile is deleted. The volume therefore is no longer protected by the RACF program. The data on these volumes can be accessed by other users.

If you specify PROTECTION=AUTOMATIC, the z/OS media server issues RACROUTE commands to delete profiles when a volume is deleted from the server. The deletion commands that are issued depend on the current system settings for TAPEVOL and TAPEDSN. If the system settings are changed, the z/OS media server might not delete existing profiles.

Do not change the setting to PROTECTION=AUTOMATIC for a device class that was set to PROTECTION=NO. Volumes without profiles might exist and error messages are generated when such volumes are deleted. If a different value for PROTECTION is required, define a new device class.

Profile creation and deletion occur based on the protection setting when the volume is first used and when it is deleted. The server does not attempt to create profiles for volumes that it has already used. If protection is set to AUTOMATIC, the server attempts to delete profiles when volumes are deleted.

See the documentation for the RACF program for details about the TAPEVOL and TAPEDSN settings and the profiles that are created when these settings are active.

#### UNIT

Specifies an esoteric unit name to specify a group of tape devices that support ECARTRIDGE tapes. Use the unit name that represents the subset of drives in the library that are attached to the z/OS system. This parameter is optional. The unit name can be up to 8 characters.

AIX

Linux

## UPDATE DEVCLASS (Update a FILE device class for z/OS media server)

Use this command to update a device class that you defined to use a z/OS® media server to access files on magnetic disk storage as sequential-access volumes (like tape). The device class that targets storage for the z/OS media server requires a library definition of type ZOSMEDIA.

A volume in this device class is a Virtual Storage Access Method (VSAM) linear data set that is accessed by the z/OS media server. SCRATCH volumes can be used with a device class and the z/OS media server dynamically allocates the VSAM LDS. It is not necessary to define volumes for the server to use the device class. If you define volumes, set the high-level qualifier (HLQ) so that SMS recognizes the allocation request by the z/OS media server. If you are using defined volumes, the format volume function is not supported for the server when you use this device class. The z/OS media server uses a FormatWrite feature of DFSMS Media Manager when filling FILE volumes.

You can define volumes for the FILE device class by using the DEFINE VOLUME command. However, the z/OS media server does not allocate space for a defined volume until the volume is opened for its first use.

### Privilege class

To issue this command, you must have system privilege or unrestricted storage privilege.

### Syntax

```
>>-UPDate DEVclass--device_class_name----->
>--+-----+-----+-----+----->
>+-----+-----+-----+----->
>+-----+-----+-----+----->
>+-----+-----+-----+----->
>+-----+-----+-----+-----><
>+-----+-----+-----+-----><
'-MAXCAPacity----size-' '-PRIMARYalloc----size-'
'-SECONDARYalloc----size-'
'-PREFIX----file_volume_prefix-'
'-MOUNTLimit----number-'
```

### Parameters

device\_class\_name (Required)

Specifies the name of the device class to be defined. The maximum length of the device class name is 30 characters.

MAXCAPacity

Specifies the maximum size of file volumes that are defined to a storage pool in this device class. This parameter is optional.

Specify this value as an integer followed by K (KB), M (MB), G (GB), or T (TB). The minimum size is 1 MB (MAXCAPACITY=1M). The maximum size is 16384 GB (MAXCAPACITY=16384G).

PRIMARYalloc



Specifies the initial amount of space that is dynamically allocated when a new volume is opened. Enough space must be available to satisfy the primary allocation amount. Storage Management Subsystem (SMS) policy determines whether multiple physical volumes can be used to satisfy the primary allocation request.

This parameter is optional. Specify this value as an integer followed by **K** (KB), **M** (MB), **G** (GB), or **T** (TB). The minimum size is 100 KB (PRIMARYALLOC=100K). The maximum size is 16384 GB (MAXCAPACITY=16384G). All values are rounded to the next higher multiple of 256 KB.

To avoid wasted space, the dynamic allocation operation uses the smaller of the values that are specified in the two parameters, PRIMARYALLOC and MAXCAPACITY.

SMS automatic class selection (ACS) routines can affect whether the PRIMARYALLOC and SECONDARYALLOC parameter values are used.

#### SECONDARYAlloc

Specifies the amount of space by which a file volume is extended when space that is already allocated to the file volume is used up. The data set for a file volume is extended up to the size set by the MAXCAPACITY parameter, then the volume is marked full.

Because secondary allocation of a linear data set cannot span a physical volume, consider the size of the physical volume when selecting a secondary allocation size. For example, physical volumes for a 3390 Model 3 are approximately 2.8 GB. To ensure that each extend request occupies nearly an entire physical volume but not more, use a secondary allocation size that is just less than 2.8 GB. A secondary allocation amount of 2600 MB allots enough space for the VSAM volume data set (VVDS), the volume label, and the volume table of contents (VTOC).

This parameter is optional. Specify this value as an integer followed by **K** (KB), **M** (MB), **G** (GB), or **T** (TB). The minimum value is 0 KB (SECONDARYALLOC=0K). The maximum value is 16384 GB. Except for 0, all values are rounded to the next higher multiple of 256 KB.

If you specify 0 (SECONDARYALLOC=0), the file volume cannot be extended beyond the primary allocation amount.

SMS automatic class selection (ACS) routines can affect whether the PRIMARYALLOC and SECONDARYALLOC parameter values are used.

If you specify a value for the SECONDARYALLOCATION parameter that is not 0, or if you allow the value to default to 2600M, the SMS DATACLAS associated with the PREFIX identifier (for example, High Level Qualifier) must have the Extended Addressability (EA) attribute specified. Without the EA attribute, the SMS DATACLAS limits the allocation of the VSAM LDS FILE volume to the primary extent. (See the description of the PRIMARYALLOCATION parameter). With the data set limited to primary allocation size, the data set cannot be extended by the z/OS media server, and the volume is marked FULL before the maximum capacity is reached.

**Restriction:** Ensure that the values that you specify for the PRIMARYALLOC and SECONDARYALLOC parameters are within practical limits for the storage device. The server cannot check whether the values exceed practical device limits, and does not check whether the two values together exceed the current MAXCAPACITY setting.

**Tip:** To fill volumes when you specify a large value for the MAXCAPACITY parameter, specify large values for the PRIMARYALLOC and SECONDARYALLOC parameters. Use larger MVS™ volume sizes to reduce the chance of extend failure.

#### PREFIX

Specifies the high-level qualifier of the data set name that is used to allocate scratch volume data sets. For all scratch file volumes created in this device class, the server uses this prefix to create the data set name. This parameter is optional. The maximum length of the prefix, including periods, is 32 characters.

Values that are specified for this parameter must meet the following conditions:

- The value is to be made up of qualifiers, which can be a maximum of eight characters including periods. For example, the following value is acceptable:

AB.CD2.E

- The qualifiers must be separated by a single period.
- The first letter of each qualifier must be alphabetic or national (@,#,\$), followed by alphabetic, national, hyphen, or numeric characters.

An example of a file volume data set name using the default prefix is ADSM.B0000021.BFS.

If you have a data set naming convention, use a prefix that conforms to your naming conventions. For example, the following value is acceptable: TSM.SERVER2.VSAMFILE.

If you are running multiple server instances for either IBM Spectrum Protect™ or Tivoli® Storage Manager for z/OS Media you must use a unique value for the PREFIX parameter for each device class that you update.

#### MOUNTLimit

Specifies the maximum number of FILE volumes that can be open concurrently for this device class. This parameter is optional. For 3995 devices emulating 3390 devices, the value must not be set higher than the numbers of concurrent input and output streams possible on the media storing the volumes.

The value that you specify in this parameter is important if there is a significant penalty switching from one volume to another. For example, switching can take place when using IBM® 3995 devices to emulate 3390 devices. The value that you specify must be no higher than the number of physical drives available on the device.

If you plan to use the simultaneous-write function, ensure that sufficient drives are available for the write operation. If the number of drives needed for a simultaneous-write operation is greater than the value of the MOUNTLIMIT parameter for a device class, the transaction fails.

## UPDATE DOMAIN (Update a policy domain)

---

Use this command to change a policy domain.

### Privilege class

---

To issue this command, you must have system privilege, unrestricted policy privilege, or restricted policy privilege for the specified policy domain.

### Syntax

---

```
>>-UPDate Domain--domain_name----->
>--+-----+----->
  '-DESCRiption----description-'
>--+-----+-----+----->
  '-BACKRETention----days-'  '-ARCHRETention----days-'
>--+-----+-----><
  |                                     .-,----- . |
  |                                     V           | |
  '-ACTIVEDESTination-----active-data_pool_name---+'
```

### Parameters

---

domain\_name (Required)

Specifies the name of the policy domain.

DESCRiption

Describes the policy domain by using a text string. This parameter is optional. The maximum length of the description is 255 characters. Enclose the description in quotation marks if it contains any blank characters. To remove a previously defined description, specify a null string ("").

BACKRETention

Specifies the number of days (from the date the backup versions became inactive) to retain backup versions that are no longer on the client file system. This parameter is optional. You can specify an integer in the range 0 - 9999. The server uses the backup retention value to manage inactive versions of files when any of the following conditions occur:

- A file is rebound to a new management class, but the new management class and the default management class do not contain a backup copy group.
- The management class to which a file is bound no longer exists. The default management class does not contain a backup copy group.
- The backup copy group is deleted from the management class to which a file is bound. The default management class does not contain a backup copy group.

ARCHRETention

Specifies the number of days (from the date of archive) to retain archive copies. This parameter is optional. You can specify an integer in the range 0 - 30000. The server uses the archive retention value to manage archive copies of files when either of the following conditions occur:

- The management class to which a file is bound, no longer exists. The default management class does not contain an archive copy group.
- The archive copy group is deleted from the management class to which a file is bound. The default management class does not contain an archive copy group.

#### ACTIVEDESTINATION

Specifies the names of active-data pools that store active versions of backup data for nodes that are assigned to the domain. This parameter is optional. Spaces between the names of the active-data pools are not permitted. You cannot specify more than 10 active-data pools for a domain.

Before the IBM Spectrum Protect™ server writes data to an active-data pool, it verifies that the node that owns the data is assigned to a domain that has the active-data pool that is listed in the ACTIVEDESTINATION list. If the server verifies that the node meets this criteria, the data is stored in the active-data pool. If the node does not meet the criteria, then the data is not stored in the active-data pool. If the simultaneous-write function is used to write data to an active-data pool, the server completes the verification during backup operations by IBM Spectrum Protect backup-archive clients or by application clients by using the IBM Spectrum Protect API. The verification is also done when active-data is being copied by using the COPY ACTIVE DATA command.

### Example: Update the backup retention period for a policy domain

Update the policy domain ENGPOLDOM so that the backup retention grace period is extended to 90 days and the archive retention grace period is extended to two years. Specify an active-data pool as the destination for active versions of backup data belonging to nodes that are assigned to the domain. Use *engactivedata* as the name of the active-data pool. Issue the following command:

```
update domain engpoldom description='Engineering Policy Domain'  
backretention=90 archretention=730 activedestination=engactivedata
```

### Related commands

Table 1. Commands related to UPDATE DOMAIN

Command	Description
COPY DOMAIN	Creates a copy of a policy domain.
DEFINE DOMAIN	Defines a policy domain that clients can be assigned to.
DEFINE POLICYSET	Defines a policy set within the specified policy domain.
DELETE DOMAIN	Deletes a policy domain along with any policy objects in the policy domain.
QUERY DOMAIN	Displays information about policy domains.

## UPDATE DRIVE (Update a drive)

Use this command to update a drive.

### Privilege class

For detailed and current drive support information, see the Supported Devices website for your operating system:

- **AIX** | **Windows** Supported devices for AIX and Windows
- **Linux** Supported devices for Linux

To issue this command, you must have system privilege or unrestricted storage privilege.

### Syntax

```
>>-UPDate DRive--library_name--drive_name----->
```

```

>----->
'-SERial-----+serial_number+-' '-ONLine-----+Yes+-'
          '-AUTODetect----'          '-No--'

>----->
'-ELEMeNt-----+address-----+'
          '-AUTODetect-'

>----->
|                                     (1) |
'-ACSDRVID-----drive_id-----'

>-----<
|                                     (2) |
'-CLEANFREQuency-----+NONE-----+'
|                                     (3) |
+--ASNEEDED-----+
'-gigabytes-----'

```

#### Notes:

1. The ACSDRVID parameter is valid only for drives in ACSLS libraries.
2. The CLEANFREQUENCY parameter is valid only for drives in SCSI libraries.
3. The CLEANFREQUENCY=ASNEEDED parameter value does not work for all tape drives. For more information, see the parameter description.

## Parameters

#### library\_name (Required)

Specifies the name of the library to which the drive is assigned.

#### drive\_name (Required)

Specifies the name that is assigned to the drive.

#### SERial

Specifies the serial number for the drives that are being updated. This parameter is valid only for drives in a SCSI or virtual tape library (VTL). This parameter is optional. The possible values are:

#### serial\_number

Specifies the serial number for the drive that is being updated.

Note: If a path to this drive is already defined, then the number you enter here is compared to the number detected by IBM Spectrum Protect™. If the numbers do not match, the command fails.

#### AUTODETECT

Specifies that the serial number is automatically detected and used by IBM Spectrum Protect if a path is already defined to this drive.

If a path to this drive is not defined, then the serial number is not detected.

#### ONLine

Specifies whether the drive is available for use. This parameter specifies whether drives can be taken offline and used for another activity, such as maintenance. This parameter is optional.

You can issue this command when the drive is involved in an active process or session, but it is not advised. If you issue a command to take the drive offline while it is in use, an error message is issued. The mounted volume completes its current process. If this volume was part of a series of volumes for a specific transaction, the drive is not available to complete mounting the series. If no other drives are available, the process fails.

Attention: When a drive is in use, do not specify the ELEMENT parameter with the ONLINE parameter. The drive is not updated, and the command fails.

The drive state is not changed even if the server is halted and restarted. If a drive is offline when the server is restarted, a warning message is issued stating that the drive must be manually brought online. If all of the drives in a library are updated to be offline, processes that need a library mount point fail, rather than queue up for a mount point.

#### YES

Specifies that the drive is available for use (online).

#### No

Specifies that the drive is not available for use (offline).

## ELEMent

Specifies the element address of the drive within a SCSI or VTL library. The server uses the element address to connect the physical location of the drive to the SCSI address of the drive. This parameter is valid only for a drive in a SCSI or VTL library when the command is issued from an IBM Spectrum Protect library manager server. The possible values are:

### address

Specifies the element address for the drive that is being updated.

To find the element address for your library configuration, consult the information from the manufacturer.

Remember: If a path to this drive is already defined, then the number you enter here is compared to the number previously detected by IBM Spectrum Protect. If the numbers do not match, then this command fails.

### AUTODETECT

Specifies that the element number is automatically detected and used by IBM Spectrum Protect if a path is already defined to this drive.

If a path to this drive is not defined, then the element number is not detected.

Restriction: If the library in which the drive is located does not support the Read Element Status SCSI command, and ELEMENT=AUTODETECT, the command fails with an IBM Spectrum Protect error message.

## ACSDRVID

Specifies the ID of the drive that is being accessed in an ACSLS library. The drive ID is a set of numbers that indicates the physical location of a drive within an ACSLS library. This drive ID must be specified as *a,l,p,d*, where *a* is the ACSID, *l* is the LSM (library storage module), *p* is the panel number, and *d* is the drive ID. The server needs the drive ID to connect the physical location of the drive to the drive's SCSI address. See your StorageTek documentation for details.

## CLEANFREQuency

Specifies how often the server activates drive cleaning. This parameter is optional. For the most complete automation of cleaning for an automated library, you must have a cleaner cartridge checked into the volume inventory for the library. If you are using library based cleaning, NONE is advised when your library type supports this function. This parameter is valid only for drives in SCSI libraries, and not valid for externally managed libraries, such as 3494 libraries or StorageTek libraries that are managed under ACSLS.

Important: There are special considerations if you plan to use server-activated drive cleaning with a SCSI library that provides automatic drive cleaning support in its device hardware.

### NONE

Specifies that the server does not track cleaning for this drive. Use this parameter for libraries that have their own automatic cleaning.

### ASNEEDED

Specifies that the server loads the drive with a checked-in cleaner cartridge only when a drive reports to the device driver that it needs cleaning.

The CLEANFREQUENCY=ASNEEDED parameter value does not work for all tape drives. Visit the Supported Devices website for your operating system to view detailed drive information. If ASNEEDED is not supported, you can use the gigabytes value for automatic cleaning.

For IBM 3592 and LTO drives, library based cleaning is advised. If library based cleaning is not supported, then ASNEEDED must be used. Gigabytes is not recommended.

Restriction: IBM Spectrum Protect does not control the drives that are connected to the NAS file server. If a drive is attached only to a NAS file server (no connection to a storage agent or server), do not specify ASNEEDED for the cleaning frequency.

### gigabytes

Specifies, in gigabytes, how much data is processed on the drive before the server loads the drive with a cleaner cartridge. The server resets the gigabytes-processed counter each time it loads a cleaner cartridge in the drive. Important: When CLEANFREQUENCY=gigabyte, drive cleaning can occur before the gigabyte setting is reached, if the drive notifies the device driver that a cleaning is necessary.

Consult the information from the drive manufacturer for cleaning recommendations. If the information gives recommendations for cleaning frequency in terms of hours of use, convert to a gigabytes value by doing the following:

1. Use the bytes-per-second rating for the drive to determine a gigabytes-per-hour value.
2. Multiply the gigabytes-per-hour value by the recommended hours of use between cleanings.
3. Use the result as the cleaning frequency value.

Tip: For IBM 3590, specify a value for the cleaning frequency to ensure that the drives receive adequate cleaning. Consult the information from the drive manufacturer for cleaning recommendations. Using the cleaning frequency that is recommended by IBM does not over clean the drives.

## Example: Update the element address for a drive

Update DRIVE3, in the library named AUTO, by changing the element address to 119.

```
update drive auto drive3 element=119
```

## Example: Take a drive offline

Update DRIVE3, in the library named MANLIB, to take it offline.

```
update drive manlib drive3 online=no
```

## Related commands

Table 1. Commands related to UPDATE DRIVE

Command	Description
CLEAN DRIVE	Marks a drive for cleaning.
DEFINE DRIVE	Assigns a drive to a library.
DEFINE PATH	Defines a path from a source to a destination.
DELETE DRIVE	Deletes a drive from a library.
QUERY DRIVE	Displays information about drives.
QUERY LIBRARY	Displays information about one or more libraries.
UPDATE PATH	Changes the attributes associated with a path.

## UPDATE FILESPACE (Update file-space node-replication rules)

Use this command to update file-space replication rules. You can also enable or disable replication of data to which a file space rule applies.

Issue this command on the server that acts as a source for replicated data.

## Privilege class

To issue this command, you must have system privilege, unrestricted policy privilege, or restricted policy privilege for the policy domain to which the client node with the file space to be updated belongs.

## Syntax

```
>>-Update Filespace--node_name--file_space_name----->
. -NAMEType----SERVER-----
>--+-----+-----+-----+-----+-----+----->
' -NAMEType----+SERVER----+'
      +-UNICODE--+
      |      (1) |
      '-FSID-----'

. -CODEType----BOTH-----
>--+-----+-----+-----+-----+-----+----->
' -CODEType----+UNICODE----+'
      +-NONUNICODE+
      '-BOTH-----'

. -DATAType-----+BACKUP-----+-----+-----+-----+-----
V      |      (2) |
>--+-----+-----+-----+-----+-----+----->
```

```

+-ARCHive-----+
'-SPACEManaged-'

>----->
|          (3)          |
'-REPLRule-----+ALL_DATA-----+'
|          (4)          |
+-ACTIVE_DATA-----+
+-ALL_DATA_HIGH_PRIORITY-----+
|          (4)          |
+-ACTIVE_DATA_HIGH_PRIORITY-----+
+-DEFAULT-----+
'-NONE-----+'

>-----<<
|          (3)          |
'-REPLState-----+Enabled-----+'
+-Disabled--+
'-PURGEdata-'

```

**Notes:**

1. You cannot specify a file space identifier (FSID) if you use wildcard characters for the client node name.
2. You can specify each rule only once.
3. You must specify either the REPLRULE or the REPLSTATE parameter on this command.
4. The ACTIVE\_DATA and ACTIVE\_DATA\_HIGH\_PRIORITY rules are valid only if you specify DATATYPE=BACKUP.

## Parameters

---

**node\_name (Required)**

Specifies the client node to which the file space belongs. You can use wildcard characters to specify this name. However, file space identifiers can be different among client nodes for the same file space. Therefore, you cannot specify wildcard characters for the client node name and FSID as the value for the NAMETYPE parameter.

**file\_space\_name (Required)**

Specifies the name of the file space to be updated. You can use wildcard characters or a comma-delineated list to specify names.

For a server that has clients with Unicode-enabled file spaces, you might have to make the server convert the file space name that you enter. For example, you might have to make the server convert a name from the server code page to Unicode. For details, see the NAMETYPE parameter. If you specify only a single wildcard character for the name, you can use the CODETYPE parameter to limit the operation to Unicode file spaces or to non-Unicode file spaces.

File space names are case-sensitive. To determine the correct capitalization for the file space to be updated, use the QUERY FILESPACE command.

**NAMETYPE**

Specifies how you want the server to interpret the file space names that you enter. You can use this parameter for IBM Spectrum Protect™ clients that Unicode-enabled and that have Windows, Macintosh OS X, or NetWare operating systems. Use this parameter only when you enter a partly-qualified or fully-qualified file space name. The default value is SERVER. You can specify one of the following values:

**SERVER**

The server uses the server code page to interpret file space names.

**UNICODE**

The server converts file space names from the server code page to the UTF-8 code page. The success of the conversion depends on the operating system, on the characters in the name, and the server code page. Conversion can fail if the string includes characters that are not available in the server code page or if the server cannot access system conversion routines. If the conversion fails, the name can contain question marks, blanks, or ellipses (...).

**FSID**

The server interprets file space names as file space identifiers.

**CODETYPE**

Specifies the type of file spaces to be included in node replication processing. The default value is BOTH, meaning that file spaces are included regardless of code page type. Use this parameter only when you enter a single wildcard character for the file space name. You can specify one of the following values:

#### UNICODE

Specifies only file spaces that are in Unicode.

#### NONUNICODE

Specifies only file spaces that are not in Unicode.

#### BOTH

Specifies all file spaces regardless of code page type.

#### DATATYPE (Required)

Specifies the data type to which a replication rule applies. To specify multiple data types, separate the names with commas and no intervening spaces. You can specify the following values:

##### BACKUP

Specifies the backup data type.

##### ARCHIVE

Specifies the archive data type.

##### SPACEMANAGED

Specifies the space-managed data type.

#### REPLRULE

Specifies the replication rule that applies to a data type. You cannot use wildcards. If you specify multiple data types, the replication rule applies to each data type. For example, if you specify `DATATYPE=BACKUP, ARCHIVE`, the replication rule applies to backup data and to archive data.

Restriction: The `REPLRULE` parameter is optional. However, if you do not specify it, you must specify the `REPLSTATE` parameter.

You can specify normal-priority replication or high-priority replication rules. In a replication process that includes both normal and high-priority data, high-priority data is replicated first. Before you specify a rule, consider the order in which you want the data to be replicated.

For example, suppose that a file space contains active backup data and archive data. Replication of the active backup data is a higher priority than the archive data. To prioritize the active backup data, specify `DATATYPE=BACKUP REPLRULE=ACTIVE_DATA_HIGH_PRIORITY`. To assign a normal priority to archive data, issue the `UPDATE FILESPACE` command again, and specify `DATATYPE=ARCHIVE REPLRULE=ALL_DATA`.

You can specify the following rules:

##### ALL\_DATA

Replicates backup, archive, or space-managed data. The data is replicated with a normal priority.

##### ACTIVE\_DATA

Replicates only the active backup data in a file space. The data is replicated with a normal priority.

Attention: If you specify `ACTIVE_DATA` and one or more of the following conditions are true, inactive backup data on the target replication server is deleted, and inactive backup data on the source replication server is not replicated.

- When a server version earlier than Version 7.1.1 is installed on either the source or target replication servers.
- When you are using the `REPLICATE NODE` command with the `FORCERECONCILE=YES` parameter.
- When you are running the initial replication of a file space after you configure replication, restore the database, or upgrade both the source and target replication servers from a server version earlier than V7.1.1.

If the previous conditions are not true, all new and changed files since the last replication are replicated, including inactive files, and files are deleted when they expire.

##### ALL\_DATA\_HIGH\_PRIORITY

Replicates backup, archive, or space-managed data. The data is replicated with a high priority.

##### ACTIVE\_DATA\_HIGH\_PRIORITY

This rule is the same as the `ACTIVE_DATA` replication rule except data is replicated with a high priority.

#### DEFAULT

Data is replicated according to the client node rule for the data type.

For example, suppose that you want to replicate the archive data in all the file spaces that belong to a client node. Replication of the archive data is a high priority. One method to accomplish this task is to specify `DATATYPE=ARCHIVE REPLRULE=DEFAULT` for each file space. Ensure that the client replication rule for archive data is set to `ALL_DATA_HIGH_PRIORITY` or to `DEFAULT`. If the client replication rule is `DEFAULT`, the server replication rule for archive data must be set to `ALL_DATA_HIGH_PRIORITY`.



## NONE

Data is not replicated. For example, if you do not want to replicate the space-managed data in a file space, specify `DATATYPE=SPACEMANAGED REPLRULE=NONE`.

## REPLState

Specifies the replication state for a data type. If you specified multiple data types, the state applies to all the data types. For example, if you specified `DATATYPE=BACKUP, ARCHIVE`, the state applies to backup data and archive data.

The `REPLSTATE` parameter is optional. However, if you do not specify it, you must specify the `REPLRULE` parameter. You can specify one of the following values for the `REPLSTATE` parameter:

### ENabled

Specifies that the data type is ready for replication.

### DISabled

Specifies that replication does not occur until you enable it.

### PURGEdata

Specifies that data is deleted from the target replication server. The type of data deleted is the type of data specified by the `DATATYPE` parameter. For example, if you specify `DATATYPE=BACKUP, ARCHIVE` and `REPLSTATE=PURGEDATA`, backup data and archive data are deleted from the file space on the target replication server.

After the data is deleted, the `REPLSTATE` parameter is set to `DISABLED`, preventing future replication of the data type or types. The replication rule for the data type is set to `DEFAULT`.

Remember: `PURGEDATA` processing does not delete file spaces. Only data is deleted. The file space shows as empty in the output of the `QUERY OCCUPANCY` command.

## Example: Update replication rules for two data types

`NODE1` has three file spaces: `/a`, `/b`, and `/c`. The replication rules for all file spaces are set to `ALL_DATA`. However, you want to replicate the backup and archive data in file space `/a` before the data in other file spaces is replicated.

```
update filesystem node1 /a datatype=backup,archive replrule=
all_data_high_priority
```

## Example: Update replication rules for two data types

`NODE2` has two file spaces: `/a` and `/b`. You want to temporarily suspend replication of all data in file space `/b`.

```
update filesystem node2 /b datatype=backup,archive,spacemanaged
replstate=disabled
```

## Related commands

Table 1. Commands related to `UPDATE FILESPACE`

Command	Description
<code>QUERY FILESPACE</code>	Displays information about data in file spaces that belong to a client.
<code>QUERY NODE</code>	Displays partial or complete information about one or more clients.
<code>QUERY REPLICATION</code>	Displays information about node replication processes.
<code>QUERY STATUS</code>	Displays the settings of server parameters, such as those selected by the <code>SET</code> commands.
<code>REPLICATE NODE</code>	Replicates data in file spaces that belong to a client node.
<code>SET REPLRETENTION</code>	Specifies the retention period for replication history records.
<code>UPDATE NODE</code>	Changes the attributes that are associated with a client node.
<code>UPDATE REPLRULE</code>	Enables or disables replication rules.
<code>VALIDATE REPLICATION</code>	Verifies replication for file spaces and data types.

## UPDATE LIBRARY (Update a library)

Use this command to update a library definition.

**AIX** | **Windows** To update the device name, the ACS number, or the external manager path name of a library, you must use the UPDATE PATH command.

**Linux** To update the device name or the external manager path name of a library, you must use the UPDATE PATH command.

Syntax and parameter descriptions are available for the following library types.

- UPDATE LIBRARY (Update a 349X library)
- UPDATE LIBRARY (Update an ACSLS library)
- UPDATE LIBRARY (Update an EXTERNAL library)
- UPDATE LIBRARY (Update a FILE library)
- UPDATE LIBRARY (Update a manual library)
- UPDATE LIBRARY (Update a SCSI library)
- UPDATE LIBRARY (Update a shared library)
- UPDATE LIBRARY (Update a VTL library)

For detailed and current library support information, see the Supported Devices website for your operating system:

- **AIX** | **Windows** Supported devices for AIX and Windows
- **Linux** Supported devices for Linux

### **Windows**

To automatically label tape volumes in SCSI-type libraries, use the AUTOLABEL parameter on the DEFINE LIBRARY and UPDATE LIBRARY commands. Using this parameter eliminates the need to pre-label a set of tapes. It is also more efficient than using the LABEL LIBVOLUME command, which requires you to mount volumes separately. If you use the AUTOLABEL parameter, you must check in tapes by specifying CHECKLABEL=BARCODE on the CHECKIN LIBVOLUME command.

A label cannot include embedded blanks or periods and must be valid when used as a file name on the media.

You must label CD-ROM, Zip, or Jaz volumes with the device utilities from the manufacturer or the Windows utilities because IBM Spectrum Protect™ does not provide utilities to format or label these media types. The operating system utilities include the Disk Administrator program (a graphical user interface) and the label command.

## Related commands

Table 1. Commands related to UPDATE LIBRARY

Command	Description
AUDIT LIBRARY	Ensures that an automated library is in a consistent state.
CHECKIN LIBVOLUME	Checks a storage volume into an automated library.
CHECKOUT LIBVOLUME	Checks a storage volume out of an automated library.
DEFINE DRIVE	Assigns a drive to a library.
DEFINE LIBRARY	Defines an automated or manual library.
DEFINE PATH	Defines a path from a source to a destination.
DELETE DRIVE	Deletes a drive from a library.
DELETE LIBRARY	Deletes a library.
DELETE PATH	Deletes a path from a source to a destination.
LABEL LIBVOLUME	Labels volumes in manual or automated libraries.
QUERY DRIVE	Displays information about drives.
QUERY LIBRARY	Displays information about one or more libraries.
QUERY PATH	Displays information about the path from a source to a destination.

Command	Description
UPDATE DRIVE	Changes the attributes of a drive.
UPDATE LIBVOLUME	Changes the status of a storage volume.
UPDATE PATH	Changes the attributes associated with a path.

## UPDATE LIBRARY (Update a 349X library)

Use this syntax to update a 349X library.

### Privilege class

To issue this command, you must have system privilege or unrestricted storage privilege.

### Syntax

```
>>-UPDate LIBRary--library_name--+-----+----->
                                     '-SHARed-----Yes----'

>--+-----+----->
  '-RESEtDrives-----+Yes-+-'
                                     '-No--'

>--+-----+----->
  '-AUTOLabel-----+No-----+-'
                                     +-Yes-----+
                                     '-OVERWRITE-'

>--+-----+----->>
  '-WORMSCRatchcategory-----number-'
```

### Parameters

#### library\_name (Required)

Specifies the name of the library to be updated.

#### SHARed

Specifies that this library is shared with other servers in a storage area network (SAN). You must issue this command from the server defined as the primary library manager for the shared library. This parameter is required for libraries defined to a library manager and for libraries used for NDMP operations. Specify SHARed=YES to update a library that is not currently shared.

Important: If a library has a path from a data mover (such as a NAS file server) but no connection to the server, the library cannot be shared with another server.

#### AUTOLabel

Specifies whether the server attempts to automatically label tape volumes. This parameter is optional.

To use this option, you must check in the tapes with CHECKLABEL=BARCODE on the CHECKIN LIBVOLUME command.

#### No

Specifies that the server does not attempt to label any volumes.

#### Yes

Specifies that the server only labels unlabeled volumes.

#### OVERWRITE

Specifies that the server attempts to overwrite an existing label. The server overwrites existing labels *only* if both the existing label and the bar code label are not already defined in any server storage pool or volume history list.

#### WORMSCRatchcategory

Specifies the category number to be used for WORM scratch volumes in the library. This parameter is required if you use WORM volumes. You can specify a number from 1 to 65279. This number must be unique. It cannot be shared with other applications or defined libraries, and it must be different from the other category numbers in this library. This parameter is only valid when 3592 WORM volumes are used.

Restriction: This parameter can only be updated if the device class WORM parameter is set to YES and the WORMSCRATCHCATEGORY currently has no defined value.

#### RESETDrives

Specifies whether the server preempts a drive reservation with persistent reserve when the server is restarted or when a library client or storage agent reconnection is established.

**AIX** | **Windows** If persistent reserve is not supported, the server completes a reset of the path to the target device.

**Linux** If persistent reserve is not supported, the server is not able to reset the path to the target device.

Support for persistent reservation has the following limitations:

- If you are using the IBM Spectrum Protect™ device driver, persistent reserve is only supported on some tape drives. See Technote 1470319 for details.
- If you are using the IBM® device driver, persistent reserve must be enabled at the device driver level. See the *IBM Tape Device Drivers Installation and User's Guide* for information about driver configuration.
- If you are using a virtual tape library that is emulating a supported drive, it might not support persistent reserve.

The following table describes the three possible configurations for drives that are attached to NAS devices.

Table 1. Configurations for drives that are attached to NAS devices.

Library device configuration	The behavior for persistent reserve
The library device is attached to the IBM Spectrum Protect server, and the tape drives are shared by the server and the NAS device.	Drive reservation preemption is supported when the NAS device supports persistent reserve and it is enabled. For more information about setting persistent reserve, see the documentation for your NAS device.
The library device is attached to the IBM Spectrum Protect server and the tape drives are accessed only from the NAS device.	Drive reservation preemption is not supported. If you enable persistent reserve on the NAS device for these drives and a reservation is set by the NAS device but never cleared, you must use another method to clear the reservation.

**AIX** | **Windows**

Yes

Specifies that drive preemption through persistent reserve or target reset are used.

No

Specifies that drive preemption through persistent reserve or target reset are not used. The RESETDRIVES parameter must be set to YES in a clustered environment when SHARED=NO.

**Linux**

Yes

Specifies that drive preemption through persistent reserve is used.

No

Specifies that drive preemption through persistent preserve is not used.

Note: A library manager will not be able to break a drive reservation if the system that has the drive reservation is not configured to use persistent reservation.

## Example: Add new devices to a shared library

Update a 3494 shared library named 3494LIB2 with new device names. **AIX** | **Linux**

```
update library 3494lib2 device=/dev/lmcp1,/dev/lmcp2,/dev/lmcp3
```

**Windows**

```
update library 3494lib device=lb3.0.0.0,lb4.0.0.0,lb5.0.0.0
```

## UPDATE LIBRARY (Update an ACSLS library)

Use this syntax to update an ACSLS library.

### Privilege class

**Windows** In order to use ACSLS functions, the installation of StorageTek Library Attach software is required.

To issue this command, you must have system privilege or unrestricted storage privilege.

## Syntax

```
>>-UPDate LIBRARY--library_name--+-----+----->
                               '-SHARED--====Yes---'

>--+-----+----->
  '-RESETDrives-----+Yes--+'
                               '-No--'

>--+-----+-----+----->>
  '-AUTOLabel-----+No-----+'  '-ACSID-----number-'
                               +-Yes-----+
                               '-OVERWRITE-'
```

## Parameters

library\_name (Required)

Specifies the name of the library to be updated.

SHARED

Specifies that this library is shared with other servers in a storage area network (SAN). You must issue this command from the server defined as the primary library manager for the shared library. This parameter is required for libraries defined to a library manager and for libraries used for NDMP operations. Specify SHARED=YES to update a library that is not currently shared.

Important: If a library has a path from a data mover (such as a NAS file server) but no connection to the server, the library cannot be shared with another server.

RESETDrives

Specifies whether the server preempts a drive reservation with persistent reserve when the server is restarted or when a library client or storage agent reconnection is established.

**AIX** | **Windows** If persistent reserve is not supported, the server completes a reset of the path to the target device.

**Linux** If persistent reserve is not supported, the server is not able to reset the path to the target device.

Support for persistent reservation has the following limitations:

- If you are using the IBM Spectrum Protect™ device driver, persistent reserve is only supported on some tape drives. See Technote 1470319 for details.
- If you are using the IBM® device driver, persistent reserve must be enabled at the device driver level. See the *IBM Tape Device Drivers Installation and User's Guide* for information about driver configuration.
- If you are using a virtual tape library that is emulating a supported drive, it might not support persistent reserve.

The following table describes the three possible configurations for drives that are attached to NAS devices.

Table 1. Configurations for drives that are attached to NAS devices.

Library device configuration	The behavior for persistent reserve
The library device is attached to the IBM Spectrum Protect server, and the tape drives are shared by the server and the NAS device.	Drive reservation preemption is supported when the NAS device supports persistent reserve and it is enabled. For more information about setting persistent reserve, see the documentation for your NAS device.
The library device is attached to the IBM Spectrum Protect server and the tape drives are accessed only from the NAS device.	Drive reservation preemption is not supported. If you enable persistent reserve on the NAS device for these drives and a reservation is set by the NAS device but never cleared, you must use another method to clear the reservation.

**AIX** | **Windows**

Yes

Specifies that drive preemption through persistent reserve or target reset are used.

No

Specifies that drive preemption through persistent reserve or target reset are not used. The RESETDRIVES parameter must be set to YES in a clustered environment when SHARED=NO.

**Linux**

Yes

Specifies that drive preemption through persistent reserve is used.

No

Specifies that drive preemption through persistent preserve is not used.

Note: A library manager will not be able to break a drive reservation if the system that has the drive reservation is not configured to use persistent reservation.

AUTOLabel

Specifies whether the server attempts to automatically label tape volumes. This parameter is optional.

To use this option, you must check in the tapes with CHECKLABEL=BARCODE on the CHECKIN LIBVOLUME command.

No

Specifies that the server does not attempt to label any volumes.

Yes

Specifies that the server only labels unlabeled volumes.

OVERWRITE

Specifies that the server attempts to overwrite an existing label. The server overwrites existing labels *only* if both the existing label and the bar code label are not already defined in any server storage pool or volume history list.

ACSID (Required)

Specifies the number of this StorageTek library assigned by the ACSSA (Automatic Cartridge System System Administrator). This can be a number from 0 to 126. Issue QUERY ACS on your system to get the number for your library ID. This parameter is required.

See your StorageTek documentation for more information.

## Example: Update an ID number for an ACSLS library

---

Update an ACSLS library named ACSLSLIB with a new ID number.

```
update library acslslib acsid=1
```

## UPDATE LIBRARY (Update an EXTERNAL library)

---

Use this syntax to update an external library.

### Privilege class

---

To issue this command, you must have system privilege or unrestricted storage privilege.

### Syntax

---

```
>>-UPDate LIBRary--library_name----->
>--+-----+-----><
  '-AUTOLabel---+No-----+'
                    +-Yes-----+
                    '-OVERWRITE-'
```

### Parameters

---

library\_name (Required)

Specifies the name of the library to be updated.

AUTOLabel

Specifies whether the server attempts to automatically label tape volumes. This parameter is optional.

To use this option, you must check in the tapes with CHECKLABEL=BARCODE on the CHECKIN LIBVOLUME command.

No

Specifies that the server does not attempt to label any volumes.

Yes

Specifies that the server only labels unlabeled volumes.

OVERWRITE

Specifies that the server attempts to overwrite an existing label. The server overwrites existing labels *only* if both the existing label and the bar code label are not already defined in any server storage pool or volume history list.

## Example: Update the path name for an external library

---

Update an external library named EXTLIB with a new path name for the media manager.

AIX

Linux

```
update library extlib externalmanager=/v/server/mediamanager
```

Windows

```
update library extlib externalmanager=c:\server\mediamanager
```

## UPDATE LIBRARY (Update a FILE library)

---

Use this syntax to update a FILE library

### Privilege class

---

To issue this command, you must have system privilege or unrestricted storage privilege.

### Syntax

---

```
>>-UPDate LIBRARY--library_name--+-----+-----><  
      '-SHAREd-----Yes----'
```

### Parameters

---

library\_name (Required)

Specifies the name of the library to be updated.

SHAREd

Specifies that this library is shared with other servers in a storage area network (SAN). You must issue this command from the server defined as the primary library manager for the shared library. This parameter is required for libraries defined to a library manager and for libraries used for NDMP operations. Specify SHAREd=YES to update a library that is not currently shared.

Important: If a library has a path from a data mover (such as a NAS file server) but no connection to the server, the library cannot be shared with another server.

## Example: Update a FILE library to be shared

---

Update a file library named FILE2, so that it is shared:

```
update library file2 shared=yes
```

## UPDATE LIBRARY (Update a manual library)

---

Use this syntax to update a manual library.

### Privilege class

---

To issue this command, you must have system privilege or unrestricted storage privilege.

### Syntax

---

```
>>-UPDate LIBRARY--library_name--+-----+----->
                                     '-RESETDrives-----+Yes+-'
                                     '-No--'

>--+-----+----->>
  '-AUTOLabel-----+No-----+'
    +-Yes-----+
    '-OVERWRITE-'
```

## Parameters

library\_name (Required)

Specifies the name of the library to be updated.

RESETDrives

Specifies whether the server preempts a drive reservation with persistent reserve when the server is restarted or when a library client or storage agent reconnection is established.

**AIX** | **Windows** If persistent reserve is not supported, the server completes a reset of the path to the target device.

**Linux** If persistent reserve is not supported, the server is not able to reset the path to the target device.

Support for persistent reservation has the following limitations:

- If you are using the IBM Spectrum Protect™ device driver, persistent reserve is only supported on some tape drives. See Technote 1470319 for details.
- If you are using the IBM® device driver, persistent reserve must be enabled at the device driver level. See the *IBM Tape Device Drivers Installation and User's Guide* for information about driver configuration.
- If you are using a virtual tape library that is emulating a supported drive, it might not support persistent reserve.

**AIX** | **Windows**

Yes

Specifies that drive preemption through persistent reserve or target reset are used.

No

Specifies that drive preemption through persistent reserve or target reset are not used. The RESETDRIVES parameter must be set to YES in a clustered environment when SHARED=NO.

**Linux**

Yes

Specifies that drive preemption through persistent reserve is used.

No

Specifies that drive preemption through persistent preserve is not used.

Note: A library manager will not be able to break a drive reservation if the system that has the drive reservation is not configured to use persistent reservation.

AUTOLabel

Specifies whether the server attempts to automatically label tape volumes. This parameter is optional.

To use this option, you must check in the tapes with CHECKLABEL=BARCODE on the CHECKIN LIBVOLUME command.

No

Specifies that the server does not attempt to label any volumes.

Yes

Specifies that the server labels only unlabeled volumes.

OVERWRITE

Specifies that the server attempts to overwrite an existing label. The server overwrites existing labels *only* if both the existing label and the bar code label are not already defined in any server storage pool or volume history list.

## UPDATE LIBRARY (Update a SCSI library)

Use this syntax to update a SCSI library.

### Privilege class



To issue this command, you must have system privilege or unrestricted storage privilege.

## Syntax

```
>>-UPDate LIBRARY--library_name----LIBType-----+--SCSI-+----->
                                     '-VTL--'
>--+-----+--+-----+----->
  '-SHARED-----Yes---'   '-RESETDrives-----+--Yes-+-'
                                     '-No--'
>--+-----+----->
  '-AUTOLabel-----+--No-----+-'
                                     +-Yes-----+
                                     '-OVERWRITE-'
>--+-----+----->
  '-RELABELSCRatch-----+--No-+-'
                                     '-Yes-'
>--+-----+-----><
  '-SERial-----+--serial_number-+-'
                                     '-AUTODetect----'
```

## Parameters

### library\_name (Required)

Specifies the name of the library to be updated.

### LIBType (Required)

Specifies the library type that you want to update to. Possible values are:

#### VTL

Specifies that the library has a SCSI-controlled media changer device that is represented by a Virtual Tape Library. To mount volumes on drives in this type of library, IBM Spectrum Protect™ uses the media changer device. This value is effective when specified for libraries with a current library type of SCSI.

Note: Selecting the VTL library type assumes that the following conditions are true:

- Your environment does not include mixed-media
- Paths are defined between all drives in the library and all defined servers, including storage agents, that use the library

If both conditions are not met, performance can degrade to the same levels as the SCSI library type especially during times of high stress when most drives are in use concurrently.

#### SCSI

Specifies that the library has a SCSI-controlled media changer device. To mount volumes on drives in this type of library, IBM Spectrum Protect uses the media changer device. This value is effective when specified for libraries with a current library type of VTL.

### SHARED

Specifies that this library is shared with other servers in a storage area network (SAN). You must issue this command from the server defined as the primary library manager for the shared library. This parameter is required for libraries defined to a library manager and for libraries used for NDMP operations. Specify SHARED=YES to update a library that is not currently shared.

Important: If a library has a path from a data mover (such as a NAS file server) but no connection to the server, the library cannot be shared with another server.

### RESETDrives

Specifies whether the server preempts a drive reservation with persistent reserve when the server is restarted or when a library client or storage agent reconnection is established.

**AIX** | **Windows** If persistent reserve is not supported, the server completes a reset of the path to the target device.

**Linux** If persistent reserve is not supported, the server is not able to reset the path to the target device.

Support for persistent reservation has the following limitations:

- If you are using the IBM Spectrum Protect device driver, persistent reserve is only supported on some tape drives. See Technote 1470319 for details.
- If you are using the IBM® device driver, persistent reserve must be enabled at the device driver level. See the *IBM Tape Device Drivers Installation and User's Guide* for information about driver configuration.
- If you are using a virtual tape library that is emulating a supported drive, it might not support persistent reserve.

The following table describes the three possible configurations for drives that are attached to NAS devices.

Table 1. Configurations for drives that are attached to NAS devices.

Library device configuration	The behavior for persistent reserve
The library device is attached to the IBM Spectrum Protect server, and the tape drives are shared by the server and the NAS device.	Drive reservation preemption is supported when the NAS device supports persistent reserve and it is enabled. For more information about setting persistent reserve, see the documentation for your NAS device.
The library device is attached to the IBM Spectrum Protect server and the tape drives are accessed only from the NAS device.	Drive reservation preemption is not supported. If you enable persistent reserve on the NAS device for these drives and a reservation is set by the NAS device but never cleared, you must use another method to clear the reservation.
The library device is attached to the NAS device and accessed indirectly by NDMP (network data management protocol), and the tape drives are accessed only from the NAS device.	Drive reservation preemption is not supported. If you enable persistent reserve on the NAS device for these drives and a reservation is set by the NAS device but never cleared, you must use another method to clear the reservation.

**AIX** | **Windows**

Yes

Specifies that drive preemption through persistent reserve or target reset are used.

No

Specifies that drive preemption through persistent reserve or target reset are not used. The RESETDRIVES parameter must be set to YES in a clustered environment when SHARED=NO.

**Linux**

Yes

Specifies that drive preemption through persistent reserve is used.

No

Specifies that drive preemption through persistent preserve is not used.

Note: A library manager will not be able to break a drive reservation if the system that has the drive reservation is not configured to use persistent reservation.

**AUTOLabel**

Specifies whether the server attempts to automatically label tape volumes.

To use this option, you must check in the tapes with CHECKLABEL=BARCODE on the CHECKIN LIBVOLUME command.

No

Specifies that the server does not attempt to label any volumes.

Yes

Specifies that the server only labels unlabeled volumes.

**OVERWRITE**

Specifies that the server attempts to overwrite an existing label. The server overwrites existing labels *only* if both the existing label and the bar code label are not already defined in any server storage pool or volume history list.

**SERial**

Specifies the serial number for the library being updated. This parameter is optional. The possible values are:

**serial\_number**

Specifies the serial number for the library being updated.

If a path to this library has already been defined, then the number you enter here is compared to the number detected by IBM Spectrum Protect. If the numbers do not match, the command fails. If a path has not been defined, this serial number is verified when a path is defined.

**AUTODetect**

Specifies that the serial number is automatically detected and used by IBM Spectrum Protect if a path has already been defined to this library.

If a path to this library has not been defined, then the serial number is not detected.

#### RELABELSCRatch

Specifies whether the server relabels volumes that have been deleted and returned to scratch. When this parameter is set to YES, a LABEL LIBVOLUME operation is started and the existing volume label is overwritten. This parameter is optional and intended for use with a Virtual Tape Library (VTL).

Note: If you have both virtual and real volumes in your VTL, both types are relabeled when this parameter is enabled. If the VTL includes real volumes, specifying this option might affect performance.

No

Specifies that the server does not relabel volumes that are deleted and returned to scratch.

Yes

Specifies that the server relabels volumes that are deleted and returned to scratch.

## UPDATE LIBRARY (Update a shared library)

---

Use this syntax to update a shared library.

### Privilege class

---

To issue this command, you must have system privilege or unrestricted storage privilege.

### Syntax

---

```
>>-UPDate LIBRary--library_name----->
```

```
>--PRIMarylibmanager---server_name-----<
```

### Parameters

---

library\_name (Required)

Specifies the name of the library to be defined. The maximum length of this name is 30 characters.

PRIMarylibmanager

Specifies the name of the server that is responsible for controlling access to library resources. You must define this server with the DEFINE SERVER command before you can use it as a library manager.

### Example: Change the library manager server for a library

---

For a library client server, change the name of the library manager server to CASTOR.

```
update library ltolib primarylibmanager=castor
```

## UPDATE LIBRARY (Update a VTL library)

---

Use this syntax to update a library that is defined as VTL.

### Privilege class

---

To issue this command, you must have system privilege or unrestricted storage privilege.

### Syntax

---

```
>>-UPDate LIBRary--library_name---LIBType---+VTL--+----->  
                                         '-SCSI-'
```

```
>--+-----+--+-----+----->  
  '-SHAREd-----Yes---' '-RESEThives-----+Yes-+-'
```

```

                                '-No--'
>--+-----+----->
  '-AUTOLabel-----+No-----+'
                                +-Yes-----+
                                '-OVERWRITE-'
>--+-----+----->
  '-RELABELSCRatch-----+No---+'
                                '-Yes-'
>--+-----+----->>
  '-SERial-----+serial_number---+'
                                '-AUTODetect----'

```

## Parameters

### library\_name (Required)

Specifies the name of the library to be defined. The maximum length of this name is 30 characters.

### LIBType (Required)

Specifies the type of library that is being defined. Possible values are:

#### SCSI

Specifies that the library has a SCSI-controlled media changer device. To mount volumes on drives in this type of library, IBM Spectrum Protect™ uses the media changer device. This value is effective when specified for libraries with a current library type of VTL.

#### VTL

Specifies that the library has a SCSI-controlled media changer device that is represented by a Virtual Tape Library. To mount volumes on drives in this type of library, IBM Spectrum Protect uses the media changer device. This value is effective when specified for libraries with a current library type of SCSI.

Note: Select the VTL library type only if the following conditions are true:

- Your environment does not include mixed-media
- Paths are defined between all drives in the library and all defined servers, including storage agents, that use the library

If both conditions are not met, performance can degrade to the same levels as the SCSI library type especially during times of high stress when most drives are in use concurrently.

#### SHARED

Specifies that this library is shared with other servers in a storage area network (SAN). You must issue this command from the server defined as the primary library manager for the shared library. This parameter is required for libraries defined to a library manager and for libraries used for NDMP operations. Specify SHARED=YES to update a library that is not currently shared.

Important: If a library has a path from a data mover (such as a NAS file server) but no connection to the server, the library cannot be shared with another server.

#### RESETDrives

Specifies whether the server preempts a drive reservation with persistent reserve when the server is restarted or when a library client or storage agent reconnection is established.

**AIX** | **Windows** If persistent reserve is not supported, the server completes a reset of the path to the target device.

**Linux** If persistent reserve is not supported, the server is not able to reset the path to the target device.

Support for persistent reservation has the following limitations:

- If you are using the IBM Spectrum Protect device driver, persistent reserve is only supported on some tape drives. See Technote 1470319 for details.
- If you are using the IBM® device driver, persistent reserve must be enabled at the device driver level. See the *IBM Tape Device Drivers Installation and User's Guide* for information about driver configuration.
- If you are using a virtual tape library that is emulating a supported drive, it might not support persistent reserve.

**AIX** | **Windows**

#### Yes

Specifies that drive preemption through persistent reserve or target reset are used.

No

Specifies that drive preemption through persistent reserve or target reset are not used. The RESETDRIVES parameter must be set to YES in a clustered environment when SHARED=NO.

#### Linux

Yes

Specifies that drive preemption through persistent reserve is used.

No

Specifies that drive preemption through persistent preserve is not used.

Note: A library manager will not be able to break a drive reservation if the system that has the drive reservation is not configured to use persistent reservation.

#### AUTOLabel

Specifies whether the server attempts to automatically label tape volumes. This parameter is optional.

To use this option, you must check in the tapes with CHECKLABEL=BARCODE on the CHECKIN LIBVOLUME command.

No

Specifies that the server does not attempt to label any volumes.

Yes

Specifies that the server only labels unlabeled volumes.

#### OVERWRITE

Specifies that the server attempts to overwrite an existing label. The server overwrites existing labels *only* if both the existing label and the bar code label are not already defined in any server storage pool or volume history list.

#### RELABELSCRatch

Specifies whether the server relabels volumes that have been deleted and returned to scratch. When this parameter is set to YES, a LABEL LIBVOLUME operation is started and the existing volume label is overwritten.

Note: If you have both virtual and real volumes in your VTL, both types are relabeled when this parameter is enabled. If the VTL includes real volumes, specifying this option might affect performance.

Yes

Specifies that the server relabels volumes that are deleted and returned to scratch.

No

Specifies that the server does not relabel volumes that are deleted and returned to scratch.

#### SERial

Specifies the serial number for the library being updated. This parameter is optional. The possible values are:

##### serial\_number

Specifies the serial number for the library being updated.

If a path to this library has already been defined, then the number you enter here is compared to the number detected by IBM Spectrum Protect. If the numbers do not match, then the command fails. If a path has not been defined, this serial number is verified when a path is defined.

##### AUTODetect

Specifies that the serial number is automatically detected and used by IBM Spectrum Protect if a path has already been defined to this library.

If a path to this library has not been defined, then the serial number is not detected.

## UPDATE LIBVOLUME (Change the status of a storage volume)

---

Use this command to change the status of a sequential access storage volume in a library.

### Privilege class

---

To issue this command, you must have system privilege or unrestricted storage privilege.

### Syntax

---

```
>>-UPDate LIBVolume--library_name--volume_name--STaTus-----+PRIVate+--->
                                     '-SCRatch-'
>--+-----+----->>
    '-OWNer-----server_name-'
```

## Parameters

library\_name (Required)

Specifies the name of the library.

volume\_name (Required)

Specifies the volume name of the storage volume.

STaTus (Required)

Specifies a change to the status of a storage volume. Possible values are as follows:

PRIVate

Specifies that the server updates the storage volume to a private volume.

SCRatch

Specifies that the server updates the storage volume to a scratch volume.

Restriction: You cannot change the status of a volume from private to scratch if the volume belongs to a storage pool or is defined in the volume history file. You can change the status if you make a mistake when you check in volumes to the library and assign the volumes the wrong status.

**AIX** | **Linux** | **Windows** | **OWNer**

**AIX** | **Linux** | **Windows**

Specifies which server owns a private volume in a shared library that is shared across a SAN.

You can change the owner of a private volume in a shared library (SAN) when you issue the command from the library manager server. If you do not specify this parameter, the library manager server owns the private volume.

Important: Do not use OWNER as a value for scratch volumes. However, you can use OWNER when you change a scratch volume to private.

## Example: Update a volume's status

Update the volume that is named WPDV00 in the library that is named AUTO to reflect a status of PRIVATE.

```
update libvolume auto wpdv00 status=private
```

## Related commands

Table 1. Commands related to UPDATE LIBVOLUME

Command	Description
AUDIT LIBRARY	Ensures that an automated library is in a consistent state.
CHECKIN LIBVOLUME	Checks a storage volume into an automated library.
CHECKOUT LIBVOLUME	Checks a storage volume out of an automated library.
DEFINE VOLUME	Assigns a volume to be used for storage within a specified storage pool.
<b>AIX</b>   <b>Linux</b>   <b>Windows</b> LABEL LIBVOLUME	<b>AIX</b>   <b>Linux</b>   <b>Windows</b> Labels volumes in manual or automated libraries.
QUERY LIBRARY	Displays information about one or more libraries.
QUERY LIBVOLUME	Displays information about a library volume.

## UPDATE MACHINE (Update machine information)

Use this command to update machine information. This information will be included in the plan file to help you to recover the client machines.

## Privilege class

To issue this command, you must have system privilege.

## Syntax

```
>>-UPDate MACHine--machine_name----->>
>--+-----+--+-----+----->
  '-DESCRiption---description-' '-BUilding---building-'
>--+-----+--+-----+----->
  '-FLoor---floor-' '-ROom---room-'
>--+-----+--+-----+----->>
  '-PRIority---number-' '-ADSMServer---+Yes+-'
                                     '-No--'
```

## Parameters

machine\_name (Required)

Specifies the name of the machine to be updated.

DESCRiption

Specifies a description of the machine. This parameter is optional. The text can be up to 255 characters. Enclose the text in quotation marks if it contains any blank characters. To remove existing text, specify a null string ("").

BUilding

Specifies the name or number of the building that this machine is in. This parameter is optional. The text can be up to 16 characters. Enclose the text in quotation marks if it contains any blank characters. To remove existing text, specify a null string ("").

FLoor

Specifies the name or number of the floor that this machine is on. This parameter is optional. The text can be up to 16 characters. Enclose the text in quotation marks if it contains any blank characters. To remove existing text, specify a null string ("").

ROom

Specifies the name or number of the room that this machine is in. This parameter is optional. The text can be up to 16 characters. Enclose the text in quotation marks if it contains any blank characters. To remove existing text, specify a null string ("").

PRIority

Specifies the restore priority for the machine as an integer from 1 to 99. The highest priority is 1. This parameter is optional. Use this value to prioritize client machine recovery.

ADSMServer

Specifies whether the machine contains an IBM Spectrum Protect™ server. This parameter is optional. Possible values are:

No

This machine does not contain an IBM Spectrum Protect server.

Yes

This machine contains an IBM Spectrum Protect server. Only one machine can be defined as containing an IBM Spectrum Protect server.

## Example: Update information for a specific machine

Update the DISTRICT5 machine information to reflect that it contains the server.

```
update machine district5 admsserver=yes
```

## Related commands

Table 1. Commands related to UPDATE MACHINE

Command	Description
DEFINE MACHINE	Defines a machine for DRM.
DELETE MACHINE	Deletes a machine.

Command	Description
INSERT MACHINE	Inserts machine characteristics or recovery instructions into the IBM Spectrum Protect database.
QUERY MACHINE	Displays information about machines.

## UPDATE MGMTCLASS (Update a management class)

Use this command to change a management class. To allow clients to use the updated management class, you must activate the policy set that contains the management class.

Important: The UPDATE MGMTCLASS command fails if a copy storage pool is specified as the destination for files that were migrated by an IBM Spectrum Protect™ for Space Management client.

### Privilege class

To issue this command, you must have system privilege, unrestricted policy privilege, or restricted policy privilege for the policy domain to which the policy set belongs.

### Syntax

```
>>-UPDate MGmtclass--domain_name--policy_set_name--class_name--->
>--+-----+----->
  '-SPACEMGTEchnique-----+AUTOMATIC+-'
                                +-SElective+-
                                '-NONE-----'
>--+-----+----->
  '-AUTOMIGNonuse-----days-'
>--+-----+----->
  '-MIGREQUIRESBkup-----+Yes+-'
                                '-No--'
>--+-----+----->
  '-MIGDESTination-----pool_name-'
>--+-----+----->>
  '-DESCRiption-----description-'
```

### Parameters

domain\_name (Required)

Specifies the policy domain to which the management class belongs.

policy\_set\_name (Required)

Specifies the policy set to which the management class belongs. You cannot update a management class that belongs to the ACTIVE policy set.

class\_name (Required)

Specifies the management class to update.

SPACEMGTEchnique

Specifies whether a file using this management class is eligible for migration. This parameter is optional. This parameter is effective only for IBM Spectrum Protect for Space Management clients, not for backup-archive clients or application clients. Possible values are:

AUTOMATIC

Specifies that the file is eligible for both automatic migration and selective migration.

SElective

Specifies that the file is eligible for selective migration only.

NONE

Specifies that the file is not eligible for migration.



#### AUTOMIGNonuse

Specifies the number of days that must elapse since a file was last used before it is eligible for automatic migration. This parameter is optional. If SPACEMGTECHNIQUE is not AUTOMATIC, the server ignores this attribute. You can specify an integer from 0 to 9999.

This parameter is effective only for IBM Spectrum Protect for Space Management clients, not for backup-archive clients or application clients.

#### MIGREQUIRESBkup

Specifies whether a backup version of a file must exist before a file can be migrated. This parameter is optional. This parameter is effective only for IBM Spectrum Protect for Space Management clients, not for backup-archive clients or application clients. Possible values are:

Yes

Specifies that a backup version must exist.

No

Specifies that a backup version is optional.

#### MIGDESTination

Specifies the primary storage pool where the server initially stores files migrated by IBM Spectrum Protect for Space Management clients. This parameter is effective only for IBM Spectrum Protect for Space Management clients, not for backup-archive clients or application clients.

The command fails if you specify a copy storage pool as the destination.

#### DESCription

Specifies a description of the management class. This parameter is optional. The maximum length of the description is 255 characters. Enclose the description in quotation marks if it contains any blank characters. To remove a previously defined description, specify a null string ("").

## Example: Update the policy domain and storage pool of a specific management class

For the management class ACTIVEFILES, in policy set VACATION in the EMPLOYEE\_RECORDS policy domain, change the storage pool where migrated files are stored.

```
update mgmtclass employee_records vacation
activefiles migdestination=diskpool2
```

## Related commands

Table 1. Commands related to UPDATE MGMTCLASS

Command	Description
ASSIGN DEFMGMTCLASS	Assigns a management class as the default for a specified policy set.
COPY MGMTCLASS	Creates a copy of a management class.
DEFINE COPYGROUP	Defines a copy group for backup or archive processing within a specified management class.
DEFINE MGMTCLASS	Defines a management class.
DEFINE POLICYSET	Defines a policy set within the specified policy domain.
DELETE MGMTCLASS	Deletes a management class and its copy groups from a policy domain and policy set.
QUERY COPYGROUP	Displays the attributes of a copy group.
QUERY MGMTCLASS	Displays information about management classes.
QUERY POLICYSET	Displays information about policy sets.
UPDATE COPYGROUP	Changes one or more attributes of a copy group.

## UPDATE NODE (Update node attributes)

Use this command to modify the attributes of a registered node.

You must use the RENAME NODE command to change the name of a registered node.

If you update the node authentication method or the node SSLREQUIRED setting and there is a same-named administrator, those administrator ID settings change.

You must have system level authority to update the node authentication method or the node SSLREQUIRED setting and also update a same-named administrator ID. If the same-named administrator ID has client owner authority over the node that is being updated, then system level authority is not required. You must have either unrestricted policy privilege or restricted policy privilege for the policy domain to which the client node belongs.

For users of Lightweight Directory Access Protocol (LDAP) servers:

- The information in this documentation applies to the LDAP authentication method that is preferred for IBM Spectrum Protect™ V7.1.7 or later servers. For instructions about using the previous LDAP authentication method, see Managing passwords and logon procedures.
- If you change the authentication mode to LDAP, and the node name matches an administrative user ID, you might see unexpected behavior when an automatic password change occurs because the password might be updated twice. As a result, the password might become unknown to the administrative user ID. Alternatively, the password update operation might fail.

When you register or update a node, you can specify whether damaged files on the node can be recovered from a target replication server. Files can be recovered only if all the following conditions are met:

- Version 7.1.1 or later, is installed on the source and target replication servers.
- The REPLRECOVERDAMAGED system parameter is set to ON. The system parameter can be set by using the SET REPLRECOVERDAMAGED command.
- The source server includes at least one file that is marked as damaged in the node that is being replicated.
- The node data was replicated before the damage occurred.

The following table describes how parameter settings affect the recovery of damaged, replicated files.

**Table 1. Settings that affect the recovery of damaged files**

<b>Setting for the REPLRECOVERDAMAGED system parameter</b>	<b>Value of the RECOVERDAMAGED parameter on the REPLICATE NODE command</b>	<b>Value of the RECOVERDAMAGED parameter on the REGISTER NODE and UPDATE NODE commands</b>	<b>Result</b>
OFF	YES, NO, or not specified	YES or NO	During node replication, standard replication occurs and damaged files are not recovered from the target replication server.
OFF	ONLY	YES or NO	An error message is displayed because files cannot be recovered when the REPLRECOVERDAMAGED system parameter is set to OFF.
ON	YES	YES or NO	During node replication, standard replication occurs and damaged files are recovered from the target replication server.
ON	NO	YES or NO	During node replication, standard replication occurs and damaged files are not recovered from the target replication server.
ON	ONLY	YES or NO	Damaged files are recovered from the target replication server, but standard node replication does not occur.

Setting for the REPLRECOVERDAMAGED system parameter	Value of the RECOVERDAMAGED parameter on the REPLICATE NODE command	Value of the RECOVERDAMAGED parameter on the REGISTER NODE and UPDATE NODE commands	Result
ON	Not specified	YES	During node replication, standard replication occurs and damaged files are recovered from the target replication server.
ON	Not specified	NO	During node replication, standard replication occurs and damaged files are not recovered from the target replication server.

## Privilege class

To issue this command, you must have system privilege, unrestricted policy privilege, or restricted policy privilege for the policy domain to which the client node belongs.

## Syntax

```

(1)
>>-UPDate Node-----node_name----->
>--+-----+----->
| (2) |
+-----password-----+
|          '-FORCEPwreset-----+No--+-' |
|          '-Yes-' |
'-FORCEPwreset-----Yes-----'
>--+-----+----->
'-PASSExp-----days-' '-CLOptset-----option_set_name-'
>--+-----+----->
'-CONTACT-----text-' '-DOMAIN-----domain_name-'
>--+-----+-----+----->
'-COMPRESSION-----+Client+-' '-ARCHDElete-----+Yes+-'
          +-Yes-----+          '-No--'
          '-No-----'
>--+-----+----->
'-BACKDElete-----+No--+-'
          '-Yes-'
>--+-----+----->
'-WHEREDomain-----domain_name-'
>--+-----+----->
'-WHEREPlatform-----client_platform_name-'
>--+-----+-----+----->
'-MAXNUMMP-----number-' '-KEEPPMP-----+No--+-'
          '-Yes-'
>--+-----+-----+----->
'-URL-----url_address-' '-UTILITYUrl-----utility_url-'
(3)
>--+-----+----->
'-AUTOFSRename-----+Yes-----+'
          +-No-----+
          '-Client-'
>--+-----+----->
'-VALIDateprotocol-----+No-----+'

```

```

+-Dataonly+
'-All-----'

>----->
'-TXNGroupmax---+0-----+'
      '-number-'

.-DATAWritepath---ANY-----
>----->
'-DATAWritepath---+ANY-----+'
      +-LAN-----+
      '-LANFree-'

.-DATAReadpath---ANY-----
>----->
'-DATAReadpath---+ANY-----+'
      +-LAN-----+
      '-LANFree-'

>----->
'-TARGETLevel---V.R.M.F-'

.-SESSIONINITiation---Clientorserver-----
>----->
'-SESSIONINITiation---+Clientorserver-----+'
      |
      '-SERVEROnly--HLAddress---ip_address--LLAddress---tcp_port-----'
                                     (4) |

>----->
'-HLAddress---ip_address-'

>----->
|
|                                     (4) |
'-LLAddress---tcp_port-----'

>----->
'-EMAILAddress---userID@node-'

>----->
'-DEDUPLICATION---+SERVEROnly-----+'
      '-Clientorserver-'

>----->
|
|                                     (5) |
'-BACKUPINITiation---+All-----+'
      '-ROOT-'

>----->
'-BKREPLRuledefault---+ALL_DATA-----+'
      +-ACTIVE_DATA-----+
      +-ALL_DATA_HIGH_PRIORITY---+
      +-ACTIVE_DATA_HIGH_PRIORITY+
      +-DEFAULT-----+
      '-NONE-----+'

>----->
'-ARREPLRuledefault---+ALL_DATA-----+'
      +-ALL_DATA_HIGH_PRIORITY+
      +-DEFAULT-----+
      '-NONE-----+'

>----->
'-SPREPLRuledefault---+ALL_DATA-----+'
      +-ALL_DATA_HIGH_PRIORITY+
      +-DEFAULT-----+
      '-NONE-----+'

>----->
|
|                                     (6)
'-REPLState---+ENabled-----+'
      '-DISabled-' |
                  |                                     (7)
                  '-REPLMode-----+SYNCEnd-----+'
                  '-SYNCRECeive-'

```

```

>----->
'-RECOVERDamaged-----+Yes+-'
                        '-No--'

>----->
'-ROLEOVERRIDE-----+Client-----+'
                        +-Server-----+
                        +-Other-----+
                        '-Userreported-'

>----->
|                                     (8) |
|                                     .-SYNCLdapdelete-----+No-- |
'-AUTHentication-----+Local-----+-----+-----+'
                        '-LDap--'   '-SYNCLdapdelete-----+Yes+-'
                                                '-No--'

(9)
>----->
'-SSLrequired-----+Yes-----+'
                        +-No-----+
                        +-Default-----+
                        '-SERVERonly-'

.-SESSIONSECurity-----TRANSitional-----
>----->
'-SESSIONSECurity-----+STRict-----+'
                        '-TRANSitional-'

.-SPLITLARGEObjects-----Yes-----
>-----<
'-SPLITLARGEObjects-----+Yes+-'
                        '-No--'

```

#### Notes:

1. You must specify at least one optional parameter on this command.
2. Passwords are optional for this command, except when you change the authentication method from LDAP to LOCAL.
3. The VALIDATEPROTOCOL parameter is deprecated.
4. HLADDRESS and LLADDRESS must be previously set or specified in the UPDATE NODE or REGISTER NODE commands to use SESSIONINITIATION=SERVERONLY.
5. The BACKUPINITIATION parameter is ignored if the client node operating system is not supported.
6. If you specify the REPLSTATE parameter and you do not specify the REPLMODE parameter, the replication mode of the node is set to SEND.
7. If you specify the REPLMODE parameter, you must also specify the REPLSTATE parameter.
8. The SYNCLDAPDELETE parameter applies only if a node that authenticates to a Lightweight Directory Access Protocol (LDAP) server reverts to local authentication.
9. The SSLREQUIRED parameter is deprecated.

## Parameters

#### node\_name (Required)

Specifies the name of the client node to be updated. You can use wildcard characters to specify this name.

Restriction: When you update a password with the UPDATE NODE command, you cannot use a wildcard character with the node\_name parameter.

#### password

Specifies the new password for the client node. This parameter is optional in most cases. If the node authentication method is changed from LDAP to LOCAL, a password is required. If the node authentication method is LDAP, do not specify a password by using the UPDATE NODE command. The maximum length of the password is 64 characters. Passwords remain current for a period that is determined by the password expiration period.

#### FORCEPwreset

Specifies whether to force a client to change or reset the password. This parameter is optional. You can specify one of the following values:

No

Specifies that the password expiration period is set by the SET PASSEXP command. Do not force a client to change or reset the password while it attempts to log on to the server.

Yes

Specifies that the client node or administrator password will expire at the next logon. The client must change or reset the password at the next logon.

Restrictions:

- For nodes that authenticate with an LDAP server, password expiration is set by using LDAP server utilities. For this reason, do not specify FORCEPWRESET=YES if you plan to specify AUTHENTICATION=LDAP.
- If you plan to update a node to authenticate with an LDAP server, and you specified FORCEPWRESET=YES, you must change the password before you can specify FORCEPWRESET=NO and AUTHENTICATION=LDAP.

#### PASSExp

Specifies the number of days the password remains valid. You can set the password expiration period in the range 0 - 9999 days. A value of 0 means that the password never expires. This parameter is optional. If you do not specify this parameter, the password expiration period is unchanged.

You can change the password expiration period by using the UPDATE NODE or SET PASSEXP commands. To set a common expiration period for all administrators and client nodes, issue the SET PASSEXP command. You can also use the SET PASSEXP command to selectively set password expiration periods. If you selectively set a password expiration period by using the REGISTER NODE command, the UPDATE NODE command, or the SET PASSEXP command, the expiration period is excluded from common password expiration periods that were created by using the SET PASSEXP command.

You can use the RESET PASSEXP command to reset the password expiration period to the common expiration period. This parameter does not apply to passwords that authenticate with an LDAP directory server.

#### CLOptset

Specifies the name of the option set to be used by the client. This parameter is optional. To remove a client option set, specify the CLOPTSET parameter with a null string ("").

#### CONtact

Specifies a text string of information that identifies the client node. This parameter is optional. The maximum length of the text string is 255 characters. Enclose the contact information in quotation marks if it contains any blanks. To remove previously defined contact information, specify a null string ("").

#### DOmain

Specifies the name of the policy domain to which you want to register the client node. This parameter is optional.

Restriction: For servers with data retention protection enabled, an archived registered node cannot be reassigned to a different policy domain.

#### COMPression

Specifies whether the client node compresses its files before it sends them to the server for backup and archive. This parameter is optional.

Restriction: This parameter cannot be specified for a NAS node.

You can specify one of the following values:

#### Client

Specifies that the client determines whether files are to be compressed.

Yes

Specifies that the client node compresses its files before it sends them to the server for backup and archive.

No

Specifies that the client node does not compress its files before it sends them to the server for backup and archive.

#### ARCHDElete

Specifies whether the client node can delete its own archived files from the server. This parameter is optional. You can specify one of the following values:

Yes

Specifies that the client node can delete its own archive files from the server.

No

Specifies that the client node cannot delete its own archive files from the server.

#### BACKDElete

Specifies whether the client node can delete its own backup files from the server. This parameter is optional. You can specify one of the following values:

No

Specifies that the client node cannot delete its own backup files from the server.

Yes

Specifies that the client node can delete its own backup files from the server.

#### WHEREDomain

Specifies the name of the policy domain to be used as a filter in combination with the node name to select nodes to update.

This parameter is optional.

#### WHEREPlatform

Specifies the name of the client platform to be used as a filter in combination with the node name to select nodes to update. This parameter is optional.

#### MAXNUMMP

Specifies the maximum number of mount points a node can use on the server or storage agent only for operations such as backup, archive, and IBM Spectrum Protect for Space Management migration. The parameter is optional and does not apply to nodes with a type of NAS or SERVER. The default value is 1. You can specify an integer in the range 0 - 999. A value of 0 specifies that a node cannot acquire any mount point for a client data store operation. The MAXNUMMP value is not evaluated or enforced during client data read operations such as restore, retrieve, and IBM Spectrum Protect for Space Management recall. However, mount points in use for data read operations are evaluated against attempted concurrent data store operations for the same client node and might prevent the data store operations from being able to acquire mount points.

For volumes in a storage pool that is associated with the FILE or CENTERA device type, the server can have multiple sessions to read and one process to write to the same volume concurrently. To increase concurrency and provide efficient access for nodes with data in FILE or CENTERA storage pools, increase the value of the MAXNUMMP parameter.

For nodes that store data into primary storage pools with the simultaneous-write function that is enabled, you must adjust the value of the MAXNUMMP parameter to specify the correct number of mount points for each client session. A client session requires one mount point for the primary storage pool and one mount point for each copy storage pool and each active-data pool.

#### URL

Specifies the URL of the IBM Spectrum Protect web client that is configured on the client system. You can use the URL in a web browser and in the Operations Center to remotely manage the client node.

This parameter is optional. The URL must include the DNS name or IP address of the client system, and the port number that is defined on the client system for the IBM Spectrum Protect web client. For example,  
`http://client.mycorp.com:1581`

If you want to remove the value from this parameter, specify empty single quotation marks or empty double quotation marks with no spaces (" for single quotation marks, or "" for double quotation marks).

#### UTILITYUrl

Specifies the address of the IBM Spectrum Protect client management services that are configured on the client system. This URL is used by the Operations Center to access client log files so that you can remotely diagnose client issues from the Operations Center.

This parameter is optional. You can specify a URL of up to 200 characters in length. The URL must start with `https`. It includes the DNS name or IP address of the client system, and the port number that is defined on the client system for the IBM Spectrum Protect client management services. For example, `https://client.mycorp.com:9028`

If you omit the port number, the Operations Center uses the port number 9028, which is the default port number when you install the client management services on the client system.

#### KEEPMP

Specifies whether the client node keeps the mount point for the entire session. The parameter is optional. You can specify one of the following values:

No

Specifies that the client node releases the mount point during the session. If policy definitions cause data to be stored to a disk storage pool after data is stored to a sequential access storage pool, any mount points that are held by the session will be released.

Yes

Specifies that the client node must retain the mount point during the entire session. If policy definitions cause data to be stored to a disk storage pool after data is stored to a sequential access storage pool, any mount points that are held by the session will not be released.

#### AUTOFSRename

Specifies whether the client is prompted for renaming file spaces when the client system upgrades to a client that supports Unicode. The prompting and renaming, if allowed, occur only when the client runs one of the following operations: archive, selective backup, full incremental backup, or partial incremental backup. The renaming changes the names of existing backed-up file spaces that are not in Unicode in server storage. Then, the file spaces are backed up in Unicode. You can use this parameter for Unicode-enabled IBM Spectrum Protect clients by using Windows, Macintosh OS X, and NetWare operating systems.

Important: After the client with support for Unicode is installed, any new file spaces that the client backs up are stored in server storage by using the UTF-8 code page. UTF-8 is a byte-oriented encoding form that is specified by the Unicode Standard.

You can specify one of the following values:

#### Yes

The server automatically renames existing file spaces when the client system upgrades to a client that supports Unicode, and the client runs one of the following operations: archive, selective backup, full incremental backup, or partial incremental backup. The renaming occurs whether the client uses the graphical user interface, the command line, or the client scheduler.

For example, the server renames a drive as follows:

- Original name: D\_DRIVE
- New name: D\_DRIVE\_OLD

The new name indicates that the file space is stored on the server in format that is not Unicode.

#### No

The server does not rename file spaces automatically when the client system upgrades to a client that supports Unicode, and the client runs one of the following operations: archive, selective backup, full incremental backup, or partial incremental backup.

#### Client

The option AUTOFSRENAME in the client option file determines whether file spaces are renamed.

By default, the client option is set to PROMPT. When the client system upgrades to a client that supports Unicode and the client runs an IBM Spectrum Protect operation with the graphical user interface or the command line, the program displays a one-time prompt to the user about whether to rename file spaces.

When the client scheduler runs an operation, the program does not prompt for a choice about renaming, and does not rename file spaces. Backups of existing file spaces are sent as before (not in Unicode).

#### VALIDateprotocol (deprecated)

Specifies whether IBM Spectrum Protect performs a cyclic redundancy check to validate the data that is sent between the client and the server. The parameter is optional.

Important: Beginning with IBM Spectrum Protect Version 8.1.2, this parameter is deprecated. The validation that was enabled by this parameter is replaced by the TLS 1.2 protocol, which is enforced by the SESSIONSECURITY parameter. The VALIDATEPROTOCOL parameter is ignored. Update your configuration to use the SESSIONSECURITY parameter.

#### TXNGroupmax

Specifies the number of files that are transferred as a group between a client and a server between transaction commit points. Client performance might be improved by using a larger value for this option.

Specifying 0 indicates that the node uses the server global value that is set in the server options file. To use a value other than the server global value, specify a value of 4 through 65,000 for this parameter. The node value takes precedence over the server value.

Tip: Increasing the TXNGROUPMAX value increases recovery log utilization. Higher recovery log utilization might increase the risk of running out of log space. Evaluate the performance of each node before you change the parameter.

#### DATAWritepath

Specifies the transfer path that is used when the client sends data to the server, storage agent, or both, during storage operations such as backup or archive. The parameter is optional.



Remember: If a path is unavailable, the node cannot send any data. For example, if you select the LAN-free option but a LAN-free path is not defined, the operation fails.

You can specify one of the following values:

ANY

Specifies that data is sent to the server, storage agent, or both, using any available path. A LAN-free path is used if one is available. If a LAN-free path is unavailable, the data is moved over the LAN.

LAN

Specifies that data is sent over the LAN.

LANFree

Specifies that data is sent over a LAN-free path.

#### DATAReadpath

Specifies the transfer path that is used when the server, storage agent, or both read data for a client, during operations such as restore or retrieve. The parameter is optional.

Remember: If a path is unavailable, data cannot be read. For example, if you select the LAN-free option but a LAN-free path is not defined, the operation fails. The value for the transfer path also applies to failover connections. If the value is set to LANFree, failover cannot occur for the node on the secondary server.

You can specify one of the following values:

ANY

Specifies that the server, storage agent, or both use any available path to read data. A LAN-free path is used if one is available. If a LAN-free path is unavailable, the data is read over the LAN.

LAN

Specifies that data is read over the LAN.

LANFree

Specifies that data is read by using a LAN-free path.

#### SESSIONInitiation

Controls whether the server or the client initiates sessions. The parameter is optional.

Clientorserver

Specifies that the client might initiate sessions with the server by communicating on the TCP/IP port that is defined with the server option TCPPORT. Server-prompted scheduling might also be used to prompt the client to connect to the server.

SERVEROnly

Specifies that the server does not accept client requests for sessions. All sessions must be initiated by server-prompted scheduling on the port that is defined for the client with the REGISTER or UPDATE NODE commands. You cannot use the client acceptor, dsmcad, to start the scheduler when SESSIONINITIATION is set to SERVERONLY.

HLAddress

Specifies the client IP address that the server contacts to initiate scheduled events. This parameter must be used when SESSIONINITIATION is set to SERVERONLY, regardless of any addresses that are previously used by the client to contact the server.

The address can be specified either in numeric or host name format. If a numeric address is used, it is saved without verification by a domain name server. If the address is not correct, it can cause failures when the server attempts to contact the client. Host name format addresses are verified with a domain name server. Verified names are saved and resolved with Domain Name Services when the server contacts the client.

LLAddress

Specifies the client port number on which the client listens for sessions from the server. This parameter must be used when SESSIONINITIATION is set to SERVERONLY, regardless of any addresses that are previously used by the client to contact the server.

The value for this parameter must match the value of client option TCPCLIENTPORT. The default value is 1501.

HLAddress

Specifies the client IP address that the server contacts to initiate scheduled events. This optional parameter is used only when SESSIONINITIATION is set to SERVERONLY, regardless of any addresses that were previously used by the client to contact the server. If SESSIONINITIATION SERVERONLY is not in use, this option has no effect.

The address can be specified either in numeric or host name format. If a numeric address is used, it is saved without verification by a domain name server. If the address is not correct, it can cause failures when the server attempts to contact the client. Host name format addresses are verified with a domain name server. Verified names are saved and resolved with Domain Name Services when the server contacts the client.

#### LLAddress

Specifies the client port number on which the client listens for sessions from the server. This optional parameter is used only when SESSIONINITIATION is set to SERVERONLY, regardless of any addresses that were previously used by the client to contact the server. If SESSIONINITIATION SERVERONLY is not in use, this option has no effect.

The value for this parameter must match the value of client option TCPCLIENTPORT. The default value is 1501.

#### EMAILAddress

This parameter is used for more contact information. The information that is specified by this parameter is not acted upon by IBM Spectrum Protect.

#### DEDUPlication

Specifies where data deduplication can occur for this node. You can specify one of the following values:

##### SERVEROnly

Specifies that data that is stored by this node can be deduplicated on the server only.

##### Clientorserver

Specifies that data that is stored by this node can be deduplicated on either the client or the server. For data deduplication to take place on the client, you must also specify a value of YES for the DEDUPLICATION client option. You can specify this option in the client option file or in the client option set on the IBM Spectrum Protect server.

#### TARGETLevel

Specifies the client deployment package that is targeted for this node. You can substitute an applicable release package for V.R.M.F (Version.Release.Modification.Fix) Level. For example: TARGETLevel=6.2.0.0.

You must specify each segment with a number that is applicable to a deployment package. You cannot use an asterisk in any field as a substitution for a valid number. To remove an existing value, specify a null string (" "). The parameter is optional.

Restriction: The TARGETLEVEL parameter does not apply to nodes with a type of NAS or SERVER.

#### BACKUPINITiation

Specifies whether the non-root user ID on the client node can back up files to the server. The parameter is optional. The default value is ALL, indicating that non-root user IDs can back up data to the server. You can select one of the following values:

##### All

Specifies that non-root user IDs can back up files to the server. ALL is the default if BACKUPINITIATION is not specified.

##### ROOT

Specifies that only the root user ID can back up files to the server.

Restriction: The attribute is ignored by the server if the backup-archive client connects from an operating system other than AIX®, Linux, Solaris, or Mac OS.

#### BKREPLRuledefault, ARREPLRuledefault, and SPREPLRuledefault

Specifies the replication rule that applies to a data type if the file space rules for the data type are set to DEFAULT:

##### BKREPLRuledefault

Specifies the replication rule for backup data.

##### ARREPLRuledefault

Specifies the replication rule for archive data.

##### SPREPLRuledefault

Specifies the replication rule for space-managed data.

You can specify normal-priority replication or high-priority replication rules. In a replication process that includes both normal and high-priority data, high-priority data is replicated first. Before you specify a rule, consider the order in which you want the data to be replicated.

For example, suppose that a client node contains active backup data and archive data. Replication of the active backup data is a higher priority than the archive data. To prioritize both types of data, specify `BKREPLRULEDEFAULT=ACTIVE_DATA_HIGH_PRIORITY ARREPLRULEDEFAULT=ALL_DATA`.

You can specify the following rules:

#### ALL\_DATA

Replicates active and inactive backup data, archive data, or space-managed data. The data is replicated with a normal priority.

#### ACTIVE\_DATA

Replicates only active backup data. The data is replicated with a normal priority. This rule is valid only for `BKREPLRULEDEFAULT`.

Attention:

If you specify `ACTIVE_DATA` and one or more of the following conditions are true, inactive backup data on the target replication server is deleted, and inactive backup data on the source replication server is not replicated.

- When a release version earlier than Version 7.1.1 is installed on either the source or target replication servers.
- When you are using the `REPLICATE NODE` command with the `FORCERECONCILE=YES` parameter.
- When you are running the initial replication of a file space after you configure replication, restore the database, or upgrade both the source and target replication servers from a release version earlier than V7.1.1.

If the previous conditions are not true, all new and changed files since the last replication are replicated, including inactive files, and files are deleted when they expire.

#### ALL\_DATA\_HIGH\_PRIORITY

Replicates active and inactive backup data, archive data, or space-managed data. Data is replicated with a high priority.

#### ACTIVE\_DATA\_HIGH\_PRIORITY

This rule is the same as the `ACTIVE_DATA` replication rule except data is replicated with a high priority. This rule is valid only for `BKREPLRULEDEFAULT`.

#### DEFAULT

Replicates data according to the server replication rule for backup data.

For example, suppose that you want to replicate the archive data in all the file spaces that belongs to a client node. Replication of the archive data is a high priority. One method to accomplish this task is to specify `ARREPLRULEDEFAULT=DEFAULT`. Ensure that the file space rules for archive data are also set to `DEFAULT` and that the server rule for archive data is set to `ALL_DATA_HIGH_PRIORITY`.

Restriction: If a node is configured for replication, the file space rules are set to `DEFAULT` after the node stores data on the source replication server.

#### NONE

Data of the specified type is not replicated.

For example, if you do not want to replicate space-managed data that belongs to a client node, specify `SPREPLRULEDEFAULT=NONE`

#### REPLState

Specifies whether data that belongs to the client node is ready to be replicated. This parameter is optional. You can specify one of the following values:

##### Enabled

Specifies that the client node is ready for replication.

##### DISabled

Specifies that replication does not occur until you enable it.

The system response to these settings depends on the following factors:

Whether the client node definition exists only on the source replication server and you are configuring the client node for replication for the first time

If you set the replication state to `ENABLED` or `DISABLED`, the replication mode of the node on the source replication server is automatically set to `SEND` after the `UPDATE NODE` command is issued. When replication first occurs, a

client node definition on the target server is automatically created. The replication state of the client node on the target server is automatically set to ENABLED. The replication mode is set to RECEIVE.

Whether the client node definition exists on the source and the target replication servers, and the node data was previously replicated

For replication to occur, the replication state of the client node on both the source and the target servers must be set to ENABLED. For example, if the replication state of a client node on the source server is ENABLED and the replication state on the target server is DISABLED, replication does not occur.

Whether the client node definition exists on the source and the target replication servers, and the node data was previously exported from the source replication server and imported to the target replication server

In this case, you are configuring the client nodes to synchronize the data between the two servers. When replication first occurs, the replication state of the client node on the target server is automatically set to ENABLED. Data on the source and target servers is synchronized.

Restriction: To synchronize data, you must specify the REPLMODE parameter in addition to the REPLSTATE parameter.

You can specify the REPLMODE parameter only if the client node has never been replicated:

- If the client node definition exists only on the source replication server, the replication mode of the node on the source replication server is automatically set to SEND when the UPDATE NODE command is issued. The replication mode of the node on the target replication server is automatically set to RECEIVE.
- If data that belongs to the node was previously replicated, the replication mode of the node on the source replication server is SEND. The replication mode of the node on the target replication server is RECEIVE.

#### REPLMode

Specifies whether to synchronize the data that belongs to this client node. Specify this parameter only if data that belongs to the client node was exported from the source replication server and imported to the target replication server. Synchronization occurs during replication.

To synchronize data, you must issue the UPDATE NODE command on both the source and target replication servers and specify the REPLMODE and REPLSTATE parameters. The value that you specify for the REPLMODE parameter depends on whether the server is a source of or a target for replicated data.

You can specify one of the following values:

#### SYNCSEnd

Specifies that data that belongs to this client node is synchronized with data on a target server during replication. Specify this value only on the server that exported the data. When the synchronization is complete, the replication mode for the client node on the source server is automatically set to SEND. The replication mode remains SEND unless you remove the node by issuing the REMOVE REPLNODE command.

#### SYNCRECeive

Specifies that data that belongs to this client node is synchronized with data on a source server during replication. Specify this value only on the server that imported the data. When the synchronization is complete, the replication mode for the client node on the target server is automatically set to RECEIVE. The replication mode remains RECEIVE unless you remove the node by issuing the REMOVE REPLNODE command.

#### Restrictions:

- You can set the REPLMODE parameter only if the initial replication state is NONE. To synchronize data, you change the replication state to ENABLED or DISABLED and specify a value for the REPLMODE parameter.
- Data can be synchronized only if you specified DATES=ABSOLUTE on the IMPORT NODE command. If you specified DATES=RELATIVE to import data, you must rename the node or delete its data before replication. If you do not take one of these steps, you can lose data.
- If the REPLMODE parameter was set incorrectly, you must issue the REMOVE REPLNODE command before you update the client node definition. For example, suppose that you updated the definition of a client node whose data you wanted to replicate. The data that belongs to the node was previously exported to the target replication server. You specified ENABLED as the setting of the REPLSTATE parameter. However, you did not specify SYNCSEND on the source replication server. As a result, the REPLMODE parameter was automatically set to SEND, and data that belongs to the node could not be synchronized or replicated.

Issuing REMOVE REPLNODE sets the replication state and the replication mode to NONE. After the REMOVE REPLNODE command is completed, reissue the UPDATE NODE command with the correct parameters and values.

#### RECOVERDamaged

Specifies whether damaged files can be recovered for this node from a target replication server. The parameter is optional. The default value is YES. You can specify one of the following values:

Yes

Specifies that recovery of damaged files from a target replication server is enabled for this node.

No

Specifies that recovery of damaged files from a target replication server is not enabled for this node.

Tip: The value of the RECOVERDAMAGED parameter is only one of several settings that determine whether damaged files are recovered. For information about how to specify the settings, see [Settings that affect the recovery of damaged files](#).

## ROLEOVERRIDE

Specifies whether to override the reported role of the client for processor value unit (PVU) estimation reporting. The default is USERREPORTED.

The role reported by the client is either client-device (for example, a workstation) or server-device (for example, file/print server, application server, database). By default, the client reports its role that is based on the client type and the operating system. All clients initially report their role as server-device, except for IBM Spectrum Protect backup-archive clients that are running Microsoft Windows workstation distributions (Windows Vista) and Macintosh OS X.

Specify one of the following values:

Client

Specifies a client-device.

Server

Specifies a server-device.

Other

Specifies that this node is not to be used for PVU estimation reporting. The Other value is useful when multiple nodes are deployed for a physical system (for example, virtual environments, test nodes, retired nodes, and nodes not in production or clustering).

Usereported

Use the reported role that is provided by the client.

## AUTHentication

This parameter determines the password authentication method that you use; either LDAP or LOCAL.

Local

Specifies that the node uses the local IBM Spectrum Protect server database to store passwords.

LDap

Specifies that the node uses an LDAP directory server to authenticate passwords. Passwords are not stored in the IBM Spectrum Protect database.

## SYNCLdapdelete

This parameter applies only if you want a node that authenticates with a Lightweight Directory Access Protocol (LDAP) server to change to authenticate with the IBM Spectrum Protect server. The parameter specifies whether to remove the node from the LDAP server.

Yes

Specifies that the node is removed.

Restriction: Do not specify a value of YES. (The value of YES is appropriate only for users of the previous LDAP authentication method, which is described in [Managing passwords and logon procedures](#).)

No

Specifies that the node is not removed. This is the default value.

## SSLrequired (deprecated)

Specifies whether the node must use the Secure Sockets Layer (SSL) protocol to communicate with the IBM Spectrum Protect server. The parameter is optional. When you authenticate passwords with an LDAP directory server, you must protect the sessions by using SSL or another network security method.

Important: Beginning with V8.1.2, this parameter is deprecated. The validation that was enabled by this parameter is replaced by the TLS 1.2 protocol, which is enforced by the SESSIONSECURITY parameter. The SSLREQUIRED parameter is ignored. Update your configuration to use the SESSIONSECURITY parameter.

## SESSIONSECurity

Specifies whether the node must use the most secure settings to communicate with an IBM Spectrum Protect server. This parameter is optional.

You can specify one of the following values:

#### STRICT

Specifies that the strictest security settings are enforced for the node. The STRICT value uses the most secure communication protocol available, which is currently TLS 1.2. The TLS 1.2 protocol is used for SSL sessions between the server and the node. To specify whether the server uses TLS 1.2 for the entire session or only for authentication, see the SSL client option.

To use the STRICT value, the following requirements must be met to ensure that the node can authenticate with the server:

- Both the node and server must be using IBM Spectrum Protect software that supports the SESSIONSECURITY parameter.
- The node must be configured to use the TLS 1.2 protocol for SSL sessions between the server and the node.

Nodes set to STRICT that do not meet these requirements are unable to authenticate with the server.

#### TRANSITIONAL

Specifies that the existing security settings are enforced for the node. This is the default value. This value is intended to be used temporarily while you update your security settings to meet the requirements for the STRICT value.

If SESSIONSECURITY=TRANSITIONAL and the node has never met the requirements for the STRICT value, the node will continue to authenticate by using the TRANSITIONAL value. However, after a node meets the requirements for the STRICT value, the SESSIONSECURITY parameter value automatically updates from TRANSITIONAL to STRICT. Then, the node can no longer authenticate by using a version of the client or an SSL/TLS protocol that does not meet the requirements for STRICT. In addition, after a node successfully authenticates by using a more secure communication protocol, the node can no longer authenticate by using a less secure protocol. For example, if a node that is not using SSL is updated and successfully authenticates by using TLS 1.2, the node can no longer authenticate by using no SSL protocol or by using TLS 1.1. This restriction also applies when you use functions such as virtual volumes, when the node authenticates to the IBM Spectrum Protect server as a node from another server.

#### SPLITLARGEObjects

Specifies whether large objects that are stored by this node are automatically split into smaller pieces, by the server, to optimize server processing. Specifying Yes causes the server to split large objects (over 10 GB) into smaller pieces when stored by a client node. Specifying No bypasses this process. Specify No only if your primary concern is maximizing throughput of backups directly to tape. The default value is Yes.

## Example: Update node SIMON to authenticate with an LDAP directory server and connect using SSL

---

```
update node simon authentication=ldap sslrequired=yes
```

When you specify the SSLREQUIRED parameter, the server is not automatically configured for SSL. You must follow the instructions for connecting with SSL in order for the example to work.

## Example: Update all nodes to communicate with a server by using strict session security

---

Update all nodes to use the strictest security settings to authenticate with the server.

```
update node * sessionsecurity=strict
```

## Example: Update a node with software release information for a future deployment

---

The client deployment feature helps you update a backup-archive client to a newer release. The information that is generated from the UPDATE NODE command can help you when you plan a deployment. The information is stored for a future deployment and can be viewed by issuing the QUERY NODE command. After a deployment, you can issue the QUERY NODE command to see the current level and the target level. For example, to update node LARRY to backup-archive client Version 6.3.0.0.

```
update node LARRY targetlevel=6.3.0.0
```

## Example: Update a node backup to compress data and keep the client from deleting archived files

---

Update node `LARRY` so that the data on node `LARRY` is compressed when it is backed up or archived by IBM Spectrum Protect and so that the client cannot delete archived files.

```
update node larry compression=yes archdelete=no
```

## Example: Update a node's number of files that can be transferred as a group

---

Update node `LARRY` and increase the `TXNGroupmax` value to 1,000.

```
update node larry txngroupmax=1000
```

## Example: Update a node and allow it to deduplicate on the client

---

Update a node `BOB` so that it can deduplicate on the client.

```
update node bob deduplication=clientorserver
```

## Example: Update the role of node `BOB` to a server-device for PVU estimation reporting

---

If you want to accumulate PVU values, only server device roles are recorded. You can update a node from client-device to server-device by issuing the `UPDATE NODE` command. For this example, node `BOB` is updated to a server-device.

```
update node bob role=server
```

## Example: Update a node definition on a source replication server

---

`NODE1` is defined to a source replication server. The data that belongs to `NODE1` was previously exported to a target replication server. Update the replication rule for backup data that belongs to `NODE1` so that active backup data is replicated with a high priority. Enable replication for the node. Set up data synchronization with the target replication server.

```
update node node1 bkreplruledefault=active_data_high_priority  
replstate=enabled replmode=syncsend
```

## Example: Update a node definition to enable recovery of damaged files

---

Update the `PAYROLL` node to enable the recovery of damaged files from a target replication server.

```
update node payroll recoverdamaged=yes
```

## Related commands

---

Table 2. Commands related to `UPDATE NODE`

Command	Description
<code>QUERY FILESPACE</code>	Displays information about data in file spaces that belong to a client.
<code>QUERY NODE</code>	Displays partial or complete information about one or more clients.
<code>QUERY PVUESTIMATE</code>	Displays an estimate of the client-devices and server-devices being managed.
<code>QUERY REPLNODE</code>	Displays information about the replication status of a client node.
<code>REGISTER ADMIN</code>	Defines a new administrator without granting administrative authority.
<code>REGISTER NODE</code>	Defines a client node to the server and sets options for that user.
<code>REMOVE NODE</code>	Removes a client from the list of registered nodes for a specific policy domain.
<code>REMOVE REPLNODE</code>	Removes a node from replication.
<code>RENAME NODE</code>	Changes the name for a client node.

Command	Description
REPLICATE NODE	Replicates data in file spaces that belong to a client node.
RESET PASSEXP	Resets the password expiration for nodes or administrators.
SET DEDUPVERIFICATIONLEVEL	Specifies the percentage of extents verified by the server during client-side deduplication.
SET PASSEXP	Specifies the number of days after which a password is expired and must be changed.
SET REPLRECOVERDAMAGED	Specifies whether node replication is enabled to recover damaged files from a target replication server.
UPDATE ADMIN	Changes the password or contact information associated with any administrator.
UPDATE FILESPACE	Changes file-space node-replication rules.

**Related information:**

Ssl client option

## UPDATE NODEGROUP (Update a node group)

Use this command to modify the description of a node group.

### Privilege class

To issue this command, you must have system or unrestricted policy privilege.

### Syntax

```
>>-UPDate NODEGroup--group_name--DESCription-----description---<<
```

### Parameters

group\_name

Specifies the name of the node group whose description you want to update.

DESCription (Required)

Specifies a description of the node group. This parameter is required. The maximum length of the description is 255 characters. If the description contains any blanks, enclose the entire description in quotation marks.

### Example: Update a node group's description

Update the node group, `group1`, with a new description.

```
update nodegroup group1 description="Human Resources"
```

### Related commands

Table 1. Commands related to UPDATE NODEGROUP

Command	Description
DEFINE BACKUPSET	Defines a previously generated backup set to a server.
DEFINE NODEGROUP	Defines a group of nodes.
DEFINE NODEGROUPMEMBER	Adds a client node to a node group.
DELETE BACKUPSET	Deletes a backup set.
DELETE NODEGROUP	Deletes a node group.
DELETE NODEGROUPMEMBER	Deletes a client node from a node group.



Command	Description
GENERATE BACKUPSET	Generates a backup set of a client's data.
QUERY BACKUPSET	Displays backup sets.
QUERY NODEGROUP	Displays information about node groups.
UPDATE BACKUPSET	Updates a retention value associated with a backup set.

## UPDATE PATH (Change a path)

Use this command to update a path definition.

Syntax and parameter descriptions are available for the following path types.

- UPDATE PATH (Change a path when the destination is a drive)
- UPDATE PATH (Change a path when the destination is a library)
- **AIX** | **Linux** UPDATE PATH (Update a path when the destination is a ZOSMEDIA library)

For detailed and current device support information, see the Supported Devices website for your operating system:

- **AIX** | **Windows** Supported devices for AIX and Windows
- **Linux** Supported devices for Linux

### Related commands

Table 1. Commands related to UPDATE PATH

Command	Description
DEFINE DATAMOVER	Defines a data mover to the IBM Spectrum Protect server.
DEFINE DRIVE	Assigns a drive to a library.
DEFINE LIBRARY	Defines an automated or manual library.
DEFINE PATH	Defines a path from a source to a destination.
DELETE PATH	Deletes a path from a source to a destination.
QUERY PATH	Displays information about the path from a source to a destination.
UPDATE DATAMOVER	Changes the definition for a data mover.

## UPDATE PATH (Change a path when the destination is a drive)

Use this syntax when updating a path definition to a drive.

### Privilege class

To issue this command you must have system privilege or unrestricted storage privilege.

### Syntax

```
>>-UPDate PATH--source_name--destination_name----->
>--SRCType-----+DATAMover+-----+----->
      '-SERVer----'  '-AUTODetect-----+No--+-'
                          '-Yes-'
>--DESTType-----DRive--LIBRARY-----library_name----->
>--+-----+-----+-----+----->
      '-DEvIce-----device_name-'  '-ONLine-----+Yes+-'
                          '-No--'
```



Table 2. Examples of device names

Source to destination	Example
Server to a drive (not a FILE drive)	/dev/tsm SCSI/mt3
Storage agent to a drive (not a FILE drive)	/dev/tsm SCSI/mt3
Storage agent to a drive when the drive is a logical drive in a FILE library	FILE
NAS data mover to a drive	NetApp NAS file server: rst01 EMC Celerra NAS file server: c436t011 IBM System Storage N Series: rst01

**Windows** The source uses the device name to access the drive. See Table 3 for examples.

Table 3. Examples of device names

Source to destination	Example
Server to a drive (not a FILE drive)	<b>Windows</b> mt3
Server to a drive (REMOVABLEFILE drive)	e:
Storage agent to a drive (not a FILE drive)	mt3
Storage agent to a drive when the drive is a logical drive in a FILE library	FILE
NAS data mover to a drive	NetApp NAS file server: rst01 EMC Celerra NAS file server: c436t011 IBM System Storage N Series: rst01

Important:

- For 349X libraries, the alias name is a symbolic name that is specified in the /etc/ibmatl.conf file. For more information, see *IBM Tape Device Drivers Installation and User's Guide*, which can be downloaded from the IBM Systems support site at <http://www.ibm.com/support/docview.wss?uid=ssg1S7002972>.
- For information about how to obtain names for devices that are connected to a NAS file server, consult the product information for the file server. For example, for a NetApp file server, connect to the file server using Telnet and issue the SYSCONFIG command. Use this command to determine device names for drives:

```
sysconfig -t
```

#### ONLine

Specifies whether the path is available for use. This parameter is optional. Possible values are:

Yes

Specifies that the path is available for use.

No

Specifies that the path is not available for use.

The source and the destination must both be available to use the path.

For example, if the path from a data mover to a drive is online, but either the data mover or the drive is offline, you cannot use the path.

#### DIRECTORY

Specifies the directory location or locations for a storage agent to access the files in a FILE library. The DIRECTORY parameter is also used for devices of type REMOVABLEFILE. For REMOVABLEFILE devices, the DIRECTORY parameter provides information for the server (not a storage agent) along with the DRIVE parameter to describe access to the device. This parameter is optional.

On storage agents, this parameter is only valid when *all* of the following conditions are true:

- The source type is SERVER (meaning a storage agent that has been defined as a server to this server).
- The source name is the name of a storage agent, *not* the server.
- The destination is a logical drive that is part of a FILE library.
- If multiple directories were specified for the device class associated with the FILE library, the same number of directories must be specified with the DIRECTORY parameter of the DEFINE PATH command, for each drive in the FILE

library. Storage agent directories are not validated on the server. Specifying incorrect directories can cause a run-time failure.

The directory name or names identify the locations where the storage agent reads and writes the files that represent storage volumes for the FILE device class that is associated with the FILE library. The default value for DIRECTORY is the directory of the server at the time the command is issued.

Use a naming convention that you can use to associate the directory with a particular physical drive. This can help ensure that your configuration is valid for sharing the FILE library between the server and storage agent. If the storage agent is on a Windows system, use a universal naming convention (UNC) name. When the storage agent lacks permission to access remote storage, the storage agent will experience mount failures.

**Windows** The account associated with the storage agent service must be either an account within the local administrator's group or an account within the domain administrator's group. If the account is in the local administrator's group, the user ID and password must match that of an account with permissions to access storage as provided by the machine which administers the remote share. For example, if a SAMBA server is providing access to remote storage, the user ID and password in the SAMBA configuration must match that of the local administrator user ID and password associated with the storage agent service.

```
define devclass file devtype=file shared=yes mountlimit=1
directory=d:\filedir\dir1
define path stal file1 srctype=server desttype=drive
library=file1 device=file directory=\\192.168.1.10\filedir\dir1
```

In the previous example, the DEFINE DEVCLASS command establishes the shared file system in the directory accessed by the server as D:\FILEDIR\DIR1. The storage agent, however, is using UNC name \\192.168.1.10\FILEDIR\DIR1. This means that the machine with TCP/IP address 192.168.1.10 is sharing the same directory using FILEDIR as the shared name. Also, the storage agent service has an account which can access this storage. It can access it either because it is associated with a local account with the same user ID and password as 192.168.1.10 or it is associated with a domain account which is available on both the storage agent and on 192.168.1.10. If appropriate to the installation, you can replace the 192.168.1.10 with a symbolic name such as:

example.yourcompany.com

Important:

- IBM Spectrum Protect does not create shares or permissions, or mount the target file system. You must perform these actions before starting the storage agent.
- You can modify a list of directories only by replacing the entire list.
- You must ensure that storage agents can access newly created FILE volumes. To access FILE volumes, storage agents replace names from the directory list in the device-class definition with the names in the directory list for the associated path definition. The following illustrates the importance of matching device classes and paths to ensure that storage agents can access newly created FILE volumes.

Suppose you want to use these three directories for a FILE library: **Windows**

- c:\server
- d:\server
- e:\server

- | AIX            | Linux |
|----------------|-------|
| ◦ /opt/tivoli1 |       |
| ◦ /opt/tivoli2 |       |
| ◦ /opt/tivoli3 |       |

1. You use the following command to set up a FILE library named CLASSA with one drive named CLASSA1 on SERVER1: **Windows**

```
define devclass classa devtype=file
directory="c:\server,d:\server,e:\server"
shared=yes mountlimit=1
```

AIX	Linux
-----	-------

```
define devclass classa devtype=file
directory="/opt/tivoli1,/opt/tivoli2,/opt/tivoli3"
shared=yes mountlimit=1
```

2. You want the storage agent STAL to be able to use the FILE library, so you define the following path for storage agent STAL: **Windows**

```
define path server1 st1 srctype=server desttype=drive device=file
directory="\\192.168.1.10\c\server,\\192.168.1.10\d\server,
\\192.168.1.10\e\server" library=classa
```

**Windows** In this scenario, the storage agent, STA1, will replace the directory name c:\server with the directory name \\192.168.1.10\c\server to access FILE volumes that are in the c:\server directory on the server.

**AIX | Linux**

```
define path server1 st1 srctype=server desttype=drive device=file
directory="/opt/ibm1,/opt/ibm2,/opt/ibm3" library=classa
```

**AIX | Linux** In this scenario, the storage agent, STA1, will replace the directory name /opt/tivoli1 with the directory name /opt/ibm1/ to access FILE volumes that are in the /opt/tivoli1 directory on the server.

- Windows** File volume c:\server\file1.dsm is created by SERVER1. If you later change the first directory for the device class with the following command:

```
update devclass classa directory="c:\otherdir,d:\server,e:\server"
```

SERVER1 will still be able to access file volume c:\server\file1.dsm, but the storage agent STA1 will not be able to access it because a matching directory name in the PATH directory list no longer exists. If a directory name is not available in the directory list associated with the device class, the storage agent can lose access to a FILE volume in that directory. Although the volume will still be accessible from the server for reading, failure of the storage agent to access the FILE volume can cause operations to be retried on a LAN-only path or to fail.

- AIX | Linux** If file volume /opt/tivoli1/file1.dsm is created on SERVER1, and if the following command is issued,

```
update devclass classa directory="/opt/otherdir,/opt/tivoli2,
/opt/tivoli3"
```

SERVER1 will still be able to access file volume /opt/tivoli1/file1.dsm, but the storage agent STA1 will not be able to access it because a matching directory name in the PATH directory list no longer exists. If a directory name is not available in the directory list associated with the device class, the storage agent can lose access to a FILE volume in that directory. Although the volume will still be accessible from the server for reading, failure of the storage agent to access the FILE volume can cause operations to be retried on a LAN-only path or to fail.

## Example: Update a path from a data mover NAS file server to a tape drive

Update a path from a data mover that is a NAS file server to the drive TAPEDRV2 that the data mover uses for backup and restore operations. In this example, the NAS data mover is NAS1, the library is NASLIB, and the device name for the drive is rst01.

```
update path nas1 tapedrv2 srctype=datamover desttype=drive library=naslib
device=rst01
```

## UPDATE PATH (Change a path when the destination is a library)

Use this syntax when updating a path definition to a library.

### Privilege class

To issue this command you must have system privilege or unrestricted storage privilege.

### Syntax

```
>>-UPDate PATH--source_name--destination_name----->
>>-SRCType-----+DATAMover+----->
' -SERVER----' ' -AUTODetect-----+No--+ '
' -Yes- '
>>-DESTType-----LIBRARY------->
+-DEVICE-----device_name-----+
```

```

'-EXTERNALManager---path_name-'
>-----<
'-ONLine---Yes-+-'
'-No--'

```

## Parameters

source\_name (Required)

Specifies the name of source for the path. This parameter is required.

destination\_name (Required)

Specifies the name of the destination. This parameter is required.

Important: To define a path from a NAS data mover to a library, the library must have LIBTYPE of SCSI, 349X, or Automated Cartridge System Library Software (ACSL).

SRCType (Required)

Specifies the type of the source. This parameter is required. Possible values are:

DATAMover

Specifies that a data mover is the source.

SERVer

Specifies that a server or a storage agent is the source.

AUTODetect

Specifies whether the serial number for a drive or library is automatically detected, reported, and updated in IBM Spectrum Protect™. This parameter is optional. This parameter is only valid for paths defined from the local server to a library.

Possible values are:

No

Specifies that the serial number is not automatically updated.

Yes

Specifies that the serial number is automatically updated to reflect the same serial number that the drive reports to IBM Spectrum Protect.

Important:

1. If you have not previously entered a serial number, then AUTODETECT defaults to YES. If you have previously entered a serial number, then AUTODETECT defaults to NO.
2. AUTODETECT=YES in this command overrides the serial number set in the DEFINE DRIVE command.
3. Depending on the capabilities of the device, the AUTODETECT parameter may not be supported.

DESTType=LIBRARY (Required)

Specifies that a library is the destination.. This parameter is required.

DEVIce

Specifies the name of the device as known to the source, or FILE if the device is a logical drive in a FILE library.

**AIX** The source uses the device name to access the drive or library. See Table 1 for examples.

Table 1. Examples of device names

Source to destination	Example
Server to a library	<b>AIX</b> /dev/lb4 <b>Linux</b> /dev/tsm SCSI/lb4
NAS data mover to a library	mc0

**Linux** The source uses the device name to access the drive or library. See Table 2 for examples.

Table 2. Examples of device names

Source to destination	Example
Server to a library	/dev/tsm SCSI/lb4
NAS data mover to a library	mc0

**Windows** The source uses the device name to access the drive or library. See Table 3 for examples.

Table 3. Examples of device names

Source to destination	Example
Server to a library	<b>Windows</b> lb4.1

Source to destination	Example
NAS data mover to a library	mc0

Important:

- For 349X libraries, the alias name is a symbolic name that is specified in the /etc/ibmatl.conf file. For more information, see *IBM Tape Device Drivers Installation and User's Guide*, which can be downloaded from the IBM® Systems support site at <http://www.ibm.com/support/docview.wss?uid=ssg1S7002972>.
- For information about how to obtain names for devices that are connected to a NAS file server, consult the product information for the file server. For example, for a NetApp file server, connect to the file server using Telnet and issue the SYSCONFIG command. Use this command to determine the device name for a library:

```
sysconfig -m
```

#### EXTERNALManager

Specifies the location of the external library manager where IBM Spectrum Protect can send media access requests. Use single quotation marks around the value of this parameter. For example, enter: **AIX**

```
/usr/lpp/GESedt-acsls/bin/elmdt
```

**Linux**

```
/opt/GESedt-acsls/bin/elmdt
```

**Windows**

```
C:\Program Files\GES\EDT-ACSLs\bin\elmdt.exe
```

This parameter is required when the library name is an external library.

#### ONLine

Specifies whether the path is available for use. This parameter is optional. Possible values are:

Yes

Specifies that the path is available for use.

No

Specifies that the path is not available for use.

The source and the destination must both be available to use the path.

Important: If the path to a library is offline, the server will not be able to access the library. If the server is halted and restarted while the path to the library is offline, the library will not be initialized.

**AIX**

**Linux**

## UPDATE PATH (Update a path when the destination is a ZOSMEDIA library)

Use this syntax when you update a path to a ZOSMEDIA library.

### Privilege class

To issue this command, you must have system privilege or unrestricted storage privilege.

### Syntax

```
>>-UPDate PATH--source_name--destination_name----->>
>--SRCType-----SERVer--DESTType-----LIBRARY----->
>--ZOSMEDIASERVER-----server_name--+-----+-----<<
                                '-ONLine-----+Yes+-'
                                '-No--'
```

## Parameters

---

source\_name (Required)

Specifies the name of source for the path.

destination\_name (Required)

Specifies the name of the destination.

SRCType=SERVER (Required)

Specifies that the IBM Spectrum Protect™ server or a storage agent is the source.

DESTType=LIBRARY (Required)

Specifies that a library is the destination.

ZOSMEDIAServer (Required)

Specifies the server name that represents a Tivoli® Storage Manager for z/OS® Media server.

ONLine

Specifies whether the path is available for use. This parameter is optional. Possible values are:

Yes

Specifies that the path is available for use.

No

Specifies that the path is not available for use.

The source and the destination must both be available to use the path.

Important: If the path to a library is offline, the server cannot access the library. If the server is halted and restarted while the path to the library is offline, the library is not initialized during server initialization. The path must be updated to ONLINE=YES to access the library.

## UPDATE POLICYSET (Update a policy set description)

---

Use this command to change the description of a policy set. You cannot change the description of the ACTIVE policy set.

### Privilege class

---

To issue this command, you must have system privilege, unrestricted policy privilege, or restricted policy privilege for the policy domain to which the policy set belongs.

### Syntax

---

```
>>-UPDate Policyset--domain_name--policy_set_name----->  
>--DEScRiption---description-----<<
```

## Parameters

---

domain\_name (Required)

Specifies the policy domain to which the policy set belongs.

policy\_set\_name (Required)

Specifies the policy set to update. You cannot change the ACTIVE policy set.

DEScRiption (Required)

Specifies text that describes the policy set. The maximum length of the description is 255 characters. Enclose the description in quotation marks if it contains any blank characters. To remove a previously defined description, specify a null string ("").

### Example: Update a policy set

---

Update a policy set called VACATION for the EMPLOYEE\_RECORDS policy domain with a description of "Schedule Planning Information."

```
update policyset employee_records vacation  
description="schedule planning information"
```



## Related commands

Table 1. Commands related to UPDATE POLICYSET

Command	Description
ACTIVATE POLICYSET	Validates and activates a policy set.
COPY MGMTCLASS	Creates a copy of a management class.
DEFINE DOMAIN	Defines a policy domain that clients can be assigned to.
DEFINE MGMTCLASS	Defines a management class.
DEFINE POLICYSET	Defines a policy set within the specified policy domain.
DELETE POLICYSET	Deletes a policy set, including its management classes and copy groups, from a policy domain.
QUERY POLICYSET	Displays information about policy sets.
VALIDATE POLICYSET	Verifies and reports on conditions the administrator must consider before activating the policy set.

## UPDATE PROFILE (Update a profile description)

Use this command on a configuration manager to update a profile description.

### Privilege class

To issue this command, you must have system privilege.

### Syntax

```
>>-UPDate PROFIle--profile_name--DESCription--===description---><
```

### Parameters

profile\_name (Required)

Specifies the profile to update.

DESCription (Required)

Specifies a description for the profile. The maximum length of the description is 255 characters. Enclose the description in quotation marks if it contains any blank characters. To remove a description, specify a null string ("").

### Example: Update a profile's description

Update the description for profile DELTA.

```
update profile delta description="PAYROLL domain"
```

## Related commands

Table 1. Commands related to UPDATE PROFILE

Command	Description
COPY PROFILE	Creates a copy of a profile.
DEFINE PROFASSOCIATION	Associates objects with a profile.
DEFINE PROFILE	Defines a profile for distributing information to managed servers.
DELETE PROFASSOCIATION	Deletes the association of an object with a profile.
DELETE PROFILE	Deletes a profile from a configuration manager.

Command	Description
LOCK PROFILE	Prevents distribution of a configuration profile.
QUERY PROFILE	Displays information about configuration profiles.
SET CONFIGMANAGER	Specifies whether a server is a configuration manager.
UNLOCK PROFILE	Enables a locked profile to be distributed to managed servers.

## UPDATE RECOVERYMEDIA (Update recovery media)

Use this command to update information about recovery media.

### Privilege class

To issue this command, you must have system privilege.

### Syntax

```
>>-UPDate RECOVERYMedia--media_name----->
>--+-----+----->
|          .-,-----.|
|          V          ||
|'-VOLumenames-----volume_name+-'
>--+-----+-----+----->
|'-DESCRiption-----description-'  '-LOcation-----location-'
>--+-----+-----+----->
|'-Type-----+BOot--+-'  '-PROduct-----product_name-'
|          '-Other-'
>--+-----+-----><
|'-PRODUCTInfo-----product_information-'
```

### Parameters

**media\_name** (Required)

Specifies the name of the recovery media to be updated.

**VOLumenames**

Specifies the names of volumes that contain the recoverable data (for example, operating system image copies). If you specify a TYPE=BOOT, you must specify the boot media volume names in the order in which they are to be loaded at recovery time. The volume names list can be up to 255 characters. Enclose the list in quotation marks if it contains any blank characters. To remove all volume names, specify a null string ("").

**DESCRiption**

Specifies the description of the recovery media. This parameter is optional. You can use up to 255 characters. Enclose the text in quotation marks if it contains any blank characters.

**LOcation**

Describes the location of the recovery media. This parameter is optional. You can use up to 255 characters. Enclose the text in quotation marks if it contains any blank characters. To remove a location description, specify a null string ("") for the value.

**Type**

Specifies the type of recovery media. This parameter is optional. Possible values are:

**BOot**

Specifies that this is boot media. You must specify volume names if the type is BOOT.

**OTHer**

Specifies that this is not boot media. For example, a CD that contains operating system manuals.

**PROduct**

Specifies the name of the product that wrote to this media. This parameter is optional. You can use up to 16 characters. Enclose the text in quotation marks if it contains any blank characters. To remove a product name, specify a null string ("").

for the value.

#### PRODUCTInfo

Specifies any information about the product that wrote to the media that you may need to restore the machine. This parameter is optional. You can use up to 255 characters. Enclose the text in quotation marks if it contains any blank characters. To remove previously defined product information, specify a null string ("") for the value.

## Example: Update a recovery media's location description

---

Update the location description for recovery media DIST5RM to "Corporate Headquarters Data Vault."

```
update recoverymedia dist5rm
location="Corporate Headquarters Data Vault"
```

## Related commands

---

Table 1. Commands related to UPDATE RECOVERYMEDIA

Command	Description
DEFINE RECOVERYMEDIA	Defines the media required to recover a machine.
DELETE RECOVERYMEDIA	Deletes recovery media.
QUERY RECOVERYMEDIA	Displays media available for machine recovery.

## UPDATE REPLRULE (Update replication rules)

---

Use this command to enable or disable a replication rule.

Issue this command on the server that acts as a source for replicated data.

## Privilege class

---

To issue this command, you must have system privilege.

## Syntax

---

```
>>-UPDate REPLRule--rule_name----STate-----+ENabled--+------><
                                     '-DISabled-'
```

## Parameters

---

rule\_name (Required)

Specifies the name of the replication rule to be updated. You can use wildcard characters to specify one or more rules. You can specify one of the following rules:

- ALL\_DATA
- ACTIVE\_DATA
- ALL\_DATA\_HIGH\_PRIORITY
- ACTIVE\_DATA\_HIGH\_PRIORITY

STate (Required)

Specifies whether replication is allowed for the rule. You can specify one of the following values:

ENabled

Specifies that the data to which the rule applies is ready to be replicated

DISabled

Specifies that replication does not occur until you enable it.

## Example: Disable replication for backup data

---

Disable replication of normal-priority, active-backup data for all file spaces in all client nodes that are configured for replication:

## Related commands

Table 1. Commands related to UPDATE REPLRULE

Command	Description
QUERY FILESPACE	Displays information about data in file spaces that belong to a client.
QUERY NODE	Displays partial or complete information about one or more clients.
QUERY REPLICATION	Displays information about node replication processes.
QUERY REPLRULE	Displays information about node replication rules.
SET ARREPLRULEDEFAULT	Specifies the server node-replication rule for archive data.
SET BKREPLRULEDEFAULT	Specifies the server node-replication rule for backup data.
SET SPREPLRULEDEFAULT	Specifies the server node-replication rule for space-managed data.
UPDATE FILESPACE	Changes file-space node-replication rules.
UPDATE NODE	Changes the attributes that are associated with a client node.
VALIDATE REPLICATION	Verifies replication for file spaces and data types.

## UPDATE SCHEDULE (Update a schedule)

Use this command to update a client or administrative command schedule.

The UPDATE SCHEDULE command takes two forms, depending on whether the schedule applies to client operations or administrative commands. Within these two forms, you can select either classic or enhanced style schedules. The syntax and parameters for each form are defined separately.

Table 1. Commands related to UPDATE SCHEDULE

Command	Description
COPY SCHEDULE	Creates a copy of a schedule.
DEFINE SCHEDULE	Defines a schedule for a client operation or an administrative command.
DELETE SCHEDULE	Deletes a schedule from the database.
QUERY EVENT	Displays information about scheduled and completed events for selected clients.
QUERY SCHEDULE	Displays information about schedules.
SET MAXCMDRETRIES	Specifies the maximum number of retries after a failed attempt to execute a scheduled command.
SET MAXSCHEDESESSIONS	Specifies the maximum number of client/server sessions available for processing scheduled work.
SET RETRYPERIOD	Specifies the time between retry attempts by the client scheduler.

- UPDATE SCHEDULE (Update a client schedule)  
Use the UPDATE SCHEDULE to update selected parameters for a client schedule.
- UPDATE SCHEDULE (Update an administrative schedule)  
Use this command to update selected parameters for an administrative command schedule.

## UPDATE SCHEDULE (Update a client schedule)

Use the UPDATE SCHEDULE to update selected parameters for a client schedule.

This command does not change the client associations that have been made to this schedule. Any clients that are associated with the original schedule, process the modified schedule.

Not all clients can run all scheduled operations, even though you can define the schedule on the server and associate it with the client. For example, a Macintosh client cannot run a schedule when the action is to restore or retrieve files, or run an executable script. An executable script is also known as a command file, a batch file, or a script on different client operating systems.

## Privilege class

To update a client schedule, you must have system privilege, unrestricted policy privilege, or restricted policy privilege for the policy domain to which the schedule belongs.

## Syntax for a classic client schedule

```
(1)
>>-UPDate SChedule-----domain_name--schedule_name----->
>--+-----+-----+-----+----->
  '-Type----Client-' '-DEscription----description-'
>--+-----+-----+-----+----->
  '-ACTion----+Incremental-----+-'
      +-Selective-----+
      +-Archive--+-----+
      |           |           .-"-----' | |
      |           '-SUBACTion--++-----+' | |
      |           |           '-FASTBack-' | |
      +-Backup--+-----+
      |           |           .-"-----' | |
      |           '-SUBACTion--++-----+' | |
      |           |           +-FASTBack----+ |
      |           |           +-SYSTEMState+ |
      |           |           '-VM-----' |
      +-REStore-----+
      +-RETRieve-----+
      +-IMAGEBACKup-----+
      +-IMAGERESTore-----+
      +-Command-----+
      +-Macro-----+
      '-Deploy-----'
>--+-----+-----+-----+----->
  '-OPTions----+option_string-'
>--+-----+-----+-----+----->
  '-OBJects----+object_string-' '-PRIority----+number-'
>--+-----+-----+-----+----->
  '-STARTDate----+date-' '-STARTTime----+time-'
>--+-----+-----+-----+----->
  '-DURation----+number-' '-DURUnits----+Minutes--+-'
                          +-Hours-----+
                          +-Days-----+
                          '-INDefinite-'
>--+-----+-----+-----+----->
  '-MAXRUNTime----+number-' '-SCHEDStyle----+Classic-'
>--+-----+-----+-----+----->
  '-PERiod----+number-' '-PERUnits----+Hours--+-'
                          +-Days----+
                          +-Weeks---+
                          +-Months---+
                          +-Years---+
                          '-Onetime-'
>--+-----+-----+-----+----->
```

```

'-DAYofweek--==--+ANY-----+'
      +-WEEKDay---+
      +-WEEKEnd---+
      +-Sunday----+
      +-Monday----+
      +-Tuesday---+
      +-Wednesday--+
      +-Thursday--+
      +-Friday----+
      '-Saturday--'

>--+-----+----->>
'-EXPIration--==--+Never--+'
      '-date--'

```

Notes:

1. You must specify at least one optional parameter on this command.

## Syntax for an enhanced client schedule

```

(1)
>>-UPDate SCHEDULE-----domain_name--schedule_name----->
>--+-----+----->
'-Type-----Client-' '-DESCRiption-----description-'
>--+-----+----->
'-ACTion--==--+Incremental-----+'
      +-Selective-----+
      +-Archive--+-----+
      |           '-SUBACTion--==--+-----+' |
      |                                     '-FASTBack-' |
      +-Backup--+-----+
      |           '-SUBACTion--==--+-----+' |
      |                                     +-FASTBack----+ |
      |                                     +-SYSTEMState++ |
      |                                     +-VApp-----+ |
      |                                     '-VM-----+' |
      +-REStore-----+
      +-RETRieve-----+
      +-IMAGEBACKup-----+
      +-IMAGERESTore-----+
      +-Command-----+
      '-Macro-----+'
>--+-----+----->
'-OPTions--==--+option_string-'
>--+-----+----->
'-OBJects--==--+object_string-' '-PRIority--==--+number-'
>--+-----+----->
'-STARTDate--==--+date-' '-STARTTime--==--+time-'
>--+-----+----->
'-DURation--==--+number-' '-DURUnits--==--+Minutes--+
                                     +-Hours---+
                                     '-Days----+'
>--+-----+----->
'-MAXRUNTime--==--+number-' '-SCHEDStyle--==--+Enhanced-'
>--+-----+----->
'-MONth--==--+ANY-----+' '-DAYOFMonth--==--+ANY--+
      +-JANuary---+
      +-February--+
      +-MARch-----+
      +-APRil-----+
      +-May-----+
      +-JUNE-----+

```

```

+-JULy-----+
+-AUGust----+
+-September--+
+-October---+
+-November--+
+'-December--'

```

```

>--+-----+----->
'-WEEKofmonth-----+ANY-----+'
      +-First--+
      +-Second+
      +-Third--+
      +-FOurth+
      '-Last---'

>--+-----+----->
'-DAYofweek-----+ANY-----+'
      +-WEEKDay---+
      +-WEEKEnd----+
      +-SUnday-----+
      +-Monday-----+
      +-TUESday----+
      +-WednesDay--+
      +-THurSday---+
      +-Friday-----+
      '-SATurday--'

>--+-----+-----><
'-EXPIration-----+Never--+-'
      '-date--'

```

**Notes:**

1. You must specify at least one optional parameter on this command.

## Parameters

---

**domain\_name** (Required)

Specifies the name of the policy domain to which this schedule belongs.

**schedule\_name** (Required)

Specifies the name of the schedule to be updated.

**Type=Client**

Specifies that a client schedule is updated. This parameter is optional. The default is CLIENT.

**DEscription**

Specifies a description of the schedule. This parameter is optional. You can specify up to 255 characters for the description. Enclose the description in quotation marks if it contains blank characters. To remove a previously defined description, specify a null string ("") for this value.

**ACTion**

Specifies the action that occurs when this schedule is processed. Possible values are:

**Incremental**

Specifies that the schedule backs up all files that are new or that have changed since the last incremental backup. Incremental also backs up any file for which all existing backups might have expired.

**Selective**

Specifies that the schedule backs up only files that are specified with the OBJECTS parameter.

**Archive**

Specifies that the schedule archives files that are specified with the OBJECTS parameter.

**Backup**

Specifies that the schedule backs up files that are specified with the OBJECTS parameter.

**REStore**

Specifies that the schedule restores files that are specified with the OBJECTS parameter.

When you specify ACTION=RESTORE for a scheduled operation, and the REPLACE option is set to PROMPT, no prompting occurs. If you set the option to PROMPT, the files are skipped.

If you specify a second file specification, this second file specification acts as the restore destination. If you need to restore multiple groups of files, schedule one for each file specification that you need to restore.

## RETRieve

Indicates that the schedule retrieves files that are specified with the OBJECTS parameter.

Remember: A second file that is specified acts as the retrieve destination. If you need to retrieve multiple groups of files, create a separate schedule for each group of files.

## IMAGEBACKup

Specifies that the schedule backs up logical volumes that are specified with the OBJECTS parameter.

## IMAGERESTore

Specifies that the schedule restores logical volumes that are specified with the OBJECTS parameter.

## Command

Specifies that the schedule processes a client operating system command or script that is specified with the OBJECTS parameter.

## Macro

Specifies that a client processes a macro whose file name is specified with the OBJECTS parameter.

## SUBACTion

You can specify one of the following values:

""

When a null string (two double quotes) is specified with ACTION=BACKUP the backup is an incremental.

## FASTBACK

Specifies that a FastBack client operation that is identified by the ACTION parameter is to be scheduled for processing. The ACTION parameter must be either ARCHIVE or BACKUP.

## SYSTEMSTATE

Specifies that a client Systemstate backup is scheduled.

## VApp

Specifies that a client vApp backup is scheduled. A vApp is a collection of pre-deployed virtual machines.

## VM

Specifies that a client VMware backup operation is scheduled.

## Deploy

Specifies whether to update client workstations with deployment packages that are specified with the OBJECTS parameter. The OBJECTS parameter must contain two specifications, the package files to retrieve and the location from which to retrieve them. Ensure that the objects are in the order *files location*. For example:

```
define schedule standard deploy_1 action=DEPLOY objects=  
"\\IBM_ANR_WIN\c$\tsm\maintenance\client\v6r2\Windows\X32\v620\v6200\  
..\IBM_ANR_WIN"
```

Values for the following options are restricted when you specify ACTION=DEPLOY:

## PERUNITS

Specify PERUNITS=ONETIME. If you specify PERUNITS=PERIOD, the parameter is ignored.

## DURUNITS

Specify MINUTES, HOURS, or DAYS for the DURUNITS parameter. Do not specify INDEFINITE.

## SCHEDSTYLE

Specify the default style, CLASSIC.

The SCHEDULE command fails if the parameters do not conform to the required parameter values, such as the V.R.M.F.

## OPTions

Specifies the client options that you specify to the scheduled command at the time the schedule is processed. This parameter is optional.

Only those options that are valid on the scheduled command can be specified for this parameter. Refer to the appropriate client manual for information about options that are valid from the command line. All options described there as valid only on the initial command line result in an error or are ignored when running the schedule from the server. For example, do not include the following options because they have no effect when the client processes the scheduled command:

- MAXCMDRETRIES
- OPTFILE
- QUERYSCHEDPERIOD
- RETRYPERIOD
- SCHEDLOGNAME
- SCHEDMODE
- SERVERNAME



- TCPCLIENTADDRESS
- TCPCLIENTPORT

**Windows** When you define a scheduler service by using the DSMCUTIL command or the backup-archive client GUI wizard, you specify an options file. You cannot override the options in that options file by issuing the scheduled command. You must modify the options in your scheduler service.

If the option string contains multiple options or options with embedded spaces, surround the entire option string with one pair of apostrophes. Enclose individual options that contain spaces in quotation marks. A leading minus sign is required in front of the option. Errors can occur if the option string contains spaces that are not quoted correctly.

The following examples show how to specify some client options:

- To specify `subdir=yes` and domain `all-local -systemobject`, enter:
  - `options='-subdir=yes -domain="all-local -c: -systemobject"'`
- To specify domain `all-local -c: -d:`, enter:
  - `options='-domain="all-local -c: -d:"'`

**Windows** Tip:

For Windows clients running in batch mode, if the use of quotation marks is necessary, use interactive mode or operating system escape characters. For additional information, see the following topics:

- Processing a series of commands from the administrative client
- Processing individual commands from the administrative client

## OBJECTS

Specifies the objects for which the specified action is performed. Use a single space between each object. This parameter is required except when ACTION=INCREMENTAL. If the action is a backup, archive, retrieve, or restore operation, the objects are file spaces, directories, or logical volumes. If the action is to run a command or macro, the object is the name of the command or macro to run.

When you specify ACTION=INCREMENTAL without specifying a value for this parameter, the scheduled command is invoked without specified objects and attempts to process the objects as defined in the client option file. To select all file spaces or directories for an action, explicitly list them in the object string. Entering only an asterisk in the object string causes the backup to occur only for the directory where the scheduler was started.

Important:

- If you specify a second file specification, and it is not a valid destination, you receive this error:

```
ANS1082E Invalid destination file specification <filespec> entered.
```

- If you specify more than two file specifications, you receive this error:

```
ANS1102E Excessive number of command line arguments passed to the program!
```

When you specify ACTION=ARCHIVE, INCREMENTAL, or SELECTIVE for this parameter, you can list a maximum of twenty (20) file specifications.

Enclose the object string in double quotes if it contains blank characters (spaces), and then surround the double quotes with single quotes. If the object string contains multiple file names, enclose each file name with its own pair of double quotes, then surround the entire string with one pair of single quotes. Errors can occur if file names contain a space that is not quoted correctly.

**Windows** If you are using characters that have a special meaning for Windows users, such as commas, surround the entire argument in two pairs of double quotes, then surround the entire string with single quotes. The following examples show you how to specify some file names:

- To specify `C:\FILE 2`, `D:\GIF FILES`, and `E:\MY TEST FILE`, enter:
  - `OBJECTS='"C:\FILE 2" "D:\GIF FILES" "E:\MY TEST FILE"'`
- To specify `D:\TEST FILE`, enter:
  - `OBJECTS='"D:\TEST FILE"'`
- To specify `D:TEST,FILE`:
  - `OBJECTS='""D:\TEST,FILE""'`

The following examples show how to specify some file names:

- To specify /home/file 2, /home/gif files, and /home/my test file, enter:
  - OBJECTS="/home/file 2" "/home/gif files" "/home/my test file"
- To specify /home/test file, enter:
  - OBJECTS="/home/test file"

#### Windows Tip:

For Windows clients running in batch mode, if the use of double quotes is necessary, use interactive mode or operating system escape characters. For additional information, see the following topics:

- Processing a series of commands from the administrative client
- Processing individual commands from the administrative client

#### PRIority

Specifies the priority value for a schedule. This parameter is optional. You can specify an integer from 1 to 10, with 1 being the highest priority and 10 being the lowest. The default is 5.

If two or more schedules have the same window start time, the value you specify determines when IBM Spectrum Protect™ processes the schedule. The schedule with the highest priority starts first. For example, a schedule with PRIORITY=3 starts before a schedule with PRIORITY=5.

#### STARTDate

Specifies the date for the beginning of the window in which the schedule is first processed. This parameter is optional. The default is the current date. Use this parameter with the STARTTIME parameter to specify when the initial startup window of the schedule starts.

You can specify the date using one of the values below:

Value	Description	Example
MM/DD/YYYY	A specific date	09/15/1998
TODAY	The current date	TODAY
TODAY+days <b>or</b> +days	The current date plus days specified. The maximum number of days you can specify is 9999.	TODAY +3 <b>or</b> +3.
EOLM (End Of Last Month)	The last day of the previous month.	EOLM
EOLM-days	The last day of the previous month minus days specified.	EOLM-1  To include files that were active a day before the last day of the previous month.
BOTM (Beginning Of This Month)	The first day of the current month.	BOTM
BOTM+days	The first day of the current month, plus days specified.	BOTM+9  To include files that were active on the 10th day of the current month.

#### STARTTime

Specifies the time for the beginning of the window in which the schedule is first processed. This parameter is optional. The default is the current time. This parameter is used in conjunction with the STARTDATE parameter to specify when the initial startup window begins.

You can specify the time using one of the values below:

Value	Description	Example
HH:MM:SS	A specific time	10:30:08
NOW	The current time	NOW

Value	Description	Example
NOW+HH:MM <b>or</b> +HH:MM	The current time plus hours and minutes specified	NOW+02:00 <b>or</b> +02:00.  If you issue this command at 5:00 with STARTTIME=NOW+02:00 or STARTTIME=+02:00, the beginning of the startup window is at 7:00.
NOW-HH:MM <b>or</b> - HH:MM	The current time minus hours and minutes specified	NOW-02:00 <b>or</b> -02:00.  If you issue this command at 5:00 with STARTTIME=NOW-02:00 or STARTTIME=-02:00, the beginning of the startup window is at 3:00.

#### DURation

Specifies the number of units that define the length of the startup window of the scheduled operation. This parameter is optional. This value must be from 1 to 999. The default is 1.

Use this parameter with the DURUNITS parameter to specify the length of the startup window. For example, if you specify DURATION=20 and DURUNITS=MINUTES, the schedule must be started within 20 minutes of the start date and start time. The default length of the startup window is 1 hour. The duration of the window must be shorter than the period between windows.

This value is ignored if you specify DURUNITS=INDEFINITE.

Tip: Define schedules with durations longer than 10 minutes. Doing this will give the IBM Spectrum Protect scheduler enough time to process the schedule and prompt the client.

#### DURUnits

Specifies the time units used to determine the duration of the window in which the schedule can start. This parameter is optional. The default is HOURS.

Use this parameter with the DURATION parameter to specify how long the startup window remains open to process the schedule. For example, if DURATION=20 and DURUNITS=MINUTES, the schedule must be started within 20 minutes of the start date and start time. The schedule may not necessarily complete processing within this window. If the schedule needs to be retried for any reason, the retry attempts must begin before the startup window elapses, or the operation does not restart.

The default value for the length of the startup window is 1 hour. You can specify one of the following values:

##### Minutes

Specifies that the duration of the window is defined in minutes.

##### Hours

Specifies that the duration of the window is defined in hours.

##### Days

Specifies that the duration of the window is defined in days.

##### INDefinite

Specifies that the startup window of the scheduled operation has an indefinite duration. The schedule can run any time after the scheduled start time, until the schedule expires. You cannot specify DURUNITS=INDEFINITE, unless you specify PERUNITS=ONETIME. The INDEFINITE value is not allowed with enhanced schedules.

#### MAXRUNtime

Specifies the maximum run time, which is the number of minutes during which all client sessions that are started by the scheduled operation should be completed. If sessions are still running after the maximum run time, the server issues a warning message, but the sessions continue to run.

Tip: The maximum run time is calculated from the beginning of the startup window and not from the time that sessions start within the startup window.

Restrictions:

- The value of the parameter is not distributed to servers that are managed by an enterprise configuration manager.
- The value of the parameter is not exported by the EXPORT command.

The parameter is optional. You can specify a number in the range 0-1440. A value of 0 means that the maximum run time is indefinite, and no warning message is issued. The maximum run time must be greater than the startup window duration, which is defined by the DURATION and DURUNITS parameters.

For example, if the start time of a scheduled operation is 9:00 PM, and the duration of the startup window is 2 hours, the startup window is 9:00 PM - 11:00 PM. If the maximum run time is 240 minutes, that is, 4 hours, all client sessions for this operation should be completed by 1:00 AM. If one or more sessions are still running after 1:00 AM, the server issues a warning message.

Tip: Alternatively, you can specify a *run time alert* value of 1:00 AM in the IBM Spectrum Protect Operations Center.

#### SCHEDStyle

This parameter is optional. SCHEDSTYLE defines either the interval between times when a schedule can run, or the days on which it can run. The style can be either classic or enhanced. This parameter must be specified when you change a schedule from classic to enhanced or back to classic. Otherwise, the value for the existing schedule is used.

For classic schedules, these parameters are allowed: PERIOD, PERUNITS, and DAYOFWEEK. These parameters are not allowed: MONTH, DAYOFMONTH, and WEEKOFMONTH. If the previous schedule style was enhanced, the MONTH, DAYOFMONTH, WEEKOFMONTH, and DAYOFWEEK parameters are reset. DAYOFWEEK, PERIOD, and PERUNITS are set to default values unless they are specified with the update command.

For enhanced schedules, these parameters are allowed: MONTH, DAYOFMONTH, WEEKOFMONTH, and DAYOFWEEK. These parameters are not allowed: PERIOD and PERUNITS. If the previous schedule style was classic, the DAYOFWEEK, PERIOD, and PERUNITS parameters are reset. MONTH, DAYOFMONTH, WEEKOFMONTH, and DAYOFWEEK are set to default values unless they are specified with the update command.

#### PERiod

Specifies the length of time between startup windows for this schedule. This parameter is optional. This parameter is used only with classic schedules. You can specify an integer from 1 to 999. The default is 1.

Use this parameter with the PERUNITS parameter to specify the period between startup windows. For example, if you specify PERIOD=5 and PERUNITS=DAYS (assuming that DAYOFWEEK=ANY), the operation is scheduled every five days after the initial start date and start time. The period between startup windows must exceed the duration of each window. The default is 1 day.

This value is ignored if you specify PERUNITS=ONETIME.

#### PERUnits

Specifies the time units used to determine the period between startup windows for this schedule. This parameter is optional. This parameter is used only with classic schedules. The default is DAYS.

Use this parameter with the PERIOD parameter to specify the period between startup windows. For example, if you specify PERIOD=5 and PERUNITS=DAYS (assuming that DAYOFWEEK=ANY), the operation is scheduled every 5 days after the initial start date and start time. The default is 1 day. You can specify one of the following values:

##### Hours

Specifies that the time between startup windows is in hours.

##### Days

Specifies that the time between startup windows is in days.

##### Weeks

Specifies that the time between startup windows is in weeks.

##### Months

Specifies that the time between startup windows is in months.

When you specify PERUNITS=MONTHS, the scheduled operation will be processed each month on the same date. For example, if the start date for the scheduled operation is 02/04/1998, the schedule will process on the 4th of every month thereafter. However, if the date is not valid for the next month, then the scheduled operation will be processed on the last valid date in the month. Thereafter, subsequent operations are based on this new date. For example, if the start date is 03/31/1998, the next month's operation will be scheduled for 04/30/1998. Thereafter, all subsequent operations will be on the 30th of the month until February. Because February has only 28 days, the operation will be scheduled for 02/28/1999. Subsequent operations will be processed on the 28th of the month.

##### Years

Specifies that the time between startup windows for the schedule is in years.

When you specify PERUNITS=YEARS, the scheduled operation will be processed on the same month and date of each year. For example, if the start date for the scheduled operation is 02/29/2004, the next year's scheduled operation will be 02/28/2005 because February only has 28 days. Thereafter, subsequent operations will be scheduled for February 28th.

##### Onetime

Specifies that the schedule processes once. This value overrides the value you specified for the PERIOD parameter.

#### DAYofweek

Specifies the day of the week on which the startup window for the schedule begins. This parameter is optional. You can specify different options for the DAYofweek parameter, depending on whether the schedule style was defined as Classic or Enhanced:

##### Classic Schedule

Specifies the day of the week on which the startup window for the schedule begins. This parameter is optional. You can either specify one day of the week, or WEEKDAY, WEEKEND, or ANY. If the start date and start time fall on a day that does not correspond to a day you specify, the start date and start time will be shifted forward in 24-hour increments until the DAYOFWEEK parameter is satisfied.

If you select a value for DAYOFWEEK other than ANY, and depending on the values for PERIOD and PERUNITS, schedules may not be processed when you would expect. The default is ANY.

##### Enhanced Schedule

Specifies the days of the week on which to run the schedule. You can either specify multiple days separated by commas and no intervening blanks, or WEEKDAY, WEEKEND, or ANY. If you specify multiple days, the schedule will run on each of the specified days. If you specify WEEKDAY or WEEKEND, you must also specify either WEEKOFMONTH=FIRST or WEEKOFMONTH=LAST, and the schedule will run just once per month.

The default value is ANY, meaning the schedule will run every day of the week or on the day or days determined by other enhanced schedule parameters. DAYOFWEEK must have a value of ANY (either by default or specified with the command) when used with the DAYOFMONTH parameter.

Possible values for the DAYofweek parameter are:

##### ANY

Specifies that the startup window can begin on any day of the week.

##### WEEKDay

Specifies that the startup window can begin on Monday, Tuesday, Wednesday, Thursday, or Friday.

##### WEEKEnd

Specifies that the startup window can begin on Saturday or Sunday.

##### SUnday

Specifies that the startup window begins on Sunday.

##### Monday

Specifies that the startup window begins on Monday.

##### TUesday

Specifies that the startup window begins on Tuesday.

##### Wednesday

Specifies that the startup window begins on Wednesday.

##### THursday

Specifies that the startup window begins on Thursday.

##### Friday

Specifies that the startup window begins on Friday.

##### SAturday

Specifies that the startup window begins on Saturday.

#### MONth

Specifies the months of the year during which to run the schedule. This parameter is used only with enhanced schedules. Specify multiple values by using commas and no intervening blanks. The default value is ANY, which means that the schedule runs during every month of the year.

#### DAYOFMonth

Specifies the day of the month to run the schedule. This parameter is used only with enhanced schedules. You can either specify ANY or a number from -31 through 31, excluding zero. Negative values are a day from the end of the month, counting backwards. For example, the last day of the month is -1, the next-to-the-last day of the month is -2. You can specify multiple values separated by commas and no intervening blanks. If you specify multiple values, the schedule runs on each of the specified days of the month. If multiple values resolve to the same day, the schedule runs only once that day.

The default value is ANY, which means that the schedule runs on every day of the month or on the days determined by other enhanced schedule parameters. DAYOFMONTH must have a value of ANY (either by default or specified with the

command) when used with the DAYOFWEEK or WEEKOFMONTH parameters.

If an existing schedule specifies a value other than ANY for DAYOFWEEK and WEEKOFMONTH, and DAYOFMONTH is updated, DAYOFWEEK and WEEKOFMONTH are reset to ANY.

#### WEEKofmonth

Specifies the week of the month in which to run the schedule. This parameter is used only with enhanced schedules. A week is considered any seven-day period which does not start on a particular day of the week. You can specify FIRST, SECOND, THIRD, FOURTH, LAST, or ANY. You can specify multiple values separated by commas and no intervening blanks. If you specify multiple values, the schedule runs during each of the specified weeks of the month. If multiple values resolve to the same week, the schedule runs only once during that week.

The default value is ANY. ANY means that the schedule runs during every week of the month or on the day or days determined by other enhanced schedule parameters. WEEKOFMONTH must have a value of ANY (either by default or specified with the command) when used with the DAYOFMONTH parameter.

#### EXpiration

Specifies the date after which this schedule is no longer used. This parameter is optional. The default is NEVER. You can specify one of the following values:

##### Never

Specifies that the schedule never expires.

##### expiration\_date

Specifies the date on which this schedule expires, in MM/DD/YYYY format. If you specify an expiration date, the schedule expires at 23:59:59 on the date you specify.

### Example: Update the priority of a schedule

---

Update the MONTHLY\_BACKUP schedule that belongs to the STANDARD policy domain by setting its priority value to 1.

```
update schedule standard monthly_backup priority=1
```

### Example: Update the expiration date of a schedule

---

Update the WEEKLY\_BACKUP schedule that belongs to the EMPLOYEE\_RECORDS policy domain to expire on March 29, 1999 (03/29/1999).

```
update schedule employee_records weekly_backup expiration=03/29/1999
```

### Example: Update a schedule to archive on the last Friday of a month

---

Update a schedule from archiving files quarterly on the last Friday of the month to archiving on the last day of the specified months.

```
update schedule employee_records quarterly_archive dayofmonth=-1
```

WEEKOFMONTH and DAYOFWEEK are reset to ANY.

## UPDATE SCHEDULE (Update an administrative schedule)

---

Use this command to update selected parameters for an administrative command schedule.

You cannot schedule MACRO or QUERY ACTLOG commands.

A managed administrative schedule that is updated by a configuration manager is set to an inactive state on the managed servers during configuration refresh processing. It remains in an inactive state until it is updated to an active state on those servers.

### Privilege class

---

To update an administrative schedule, you must have system privilege.

### Syntax

---

Classic administrative schedule

```
(1)
>>-UPDate SChedule-----schedule_name----->
>--+-----+-----+-----+----->
  '-Type-----Administrative-' '-CMD-----command-'
>--+-----+-----+-----+----->
  '-ACTIVE-----+Yes-+' '-DESCription-----description-'
                    '-No--'
>--+-----+-----+-----+----->
  '-PRIority-----number-' '-STARTDate-----date-'
>--+-----+-----+-----+----->
  '-STARTTime-----time-' '-DURation-----number-'
>--+-----+-----+-----+----->
  '-DURUnits-----+Minutes-----+' '-MAXRUNtime-----number-'
                    +-Hours-----+
                    +-Days-----+
                    '-INDefinite-'
>--+-----+-----+-----+----->
  '-SCHEdStyle-----Classic-' '-PERiod-----number-'
>--+-----+-----+-----+----->
  '-PERUnits-----+Hours-----+'
                    +-Days-----+
                    +-Weeks-----+
                    +-Months-----+
                    +-Years-----+
                    '-Onetime-'
>--+-----+-----+-----+----->
  '-DAYofweek-----+ANY-----+'
                    +-WEEKDay-----+
                    +-WEEKEnd-----+
                    +-SUnDay-----+
                    +-Monday-----+
                    +-TUESday-----+
                    +-WednesDay-----+
                    +-THURsday-----+
                    +-FRIday-----+
                    '-SATurday--'
>--+-----+-----+-----+-----><
  '-EXPIration-----+Never-----+'
                    '-date--'
```

Notes:

1. You must specify at least one optional parameter on this command.

## Syntax

---

Enhanced administrative schedule

```
(1)
>>-UPDate SChedule-----schedule_name----->
>--+-----+-----+-----+----->
  '-Type-----Administrative-' '-CMD-----command-'
>--+-----+-----+-----+----->
  '-ACTIVE-----+Yes-+' '-DESCription-----description-'
                    '-No--'
>--+-----+-----+-----+----->
```

```

'-PRIority-----number-' '-STARTDate-----date-'
>--+-----+-----+-----+-----+-----+-----+-----+-----+-----+----->
'-STARTTime-----time-' '-DURation-----number-'
>--+-----+-----+-----+-----+-----+-----+-----+-----+-----+----->
'-DURUnits-----+Minutes-+-' '-MAXRUNtime-----number-'
      +-Hours----+
      '-Days----'
>--+-----+-----+-----+-----+-----+-----+-----+-----+-----+----->
'-SCHEDStyle-----Enhanced-' '-MONth-----+ANY-----+'
      +-JAnuary---+
      +-February---+
      +-MARch-----+
      +-April-----+
      +-May-----+
      +-JUNe-----+
      +-JULy-----+
      +-AUGust-----+
      +-September-+
      +-October---+
      +-November---+
      '-December--'
>--+-----+-----+-----+-----+-----+-----+-----+-----+-----+----->
'-DAYOFMonth-----+ANY-+-' '-WEEKofmonth-----+ANY-----+'
      '-Day-'
      +-First--+
      +-Second-+
      +-Third--+
      +-FOurth-+
      '-Last---'
>--+-----+-----+-----+-----+-----+-----+-----+-----+-----+----->
'-DAYofweek-----+ANY-----+'
      +-WEEKDay---+
      +-WEEKEnd---+
      +-Sunday----+
      +-Monday----+
      +-Tuesday---+
      +-Wednesday-+
      +-THursday--+
      +-Friday----+
      '-Saturday--'
>--+-----+-----+-----+-----+-----+-----+-----+-----+-----+-----><
'-EXPIration-----Never-+-'
      '-date--'

```

Notes:

1. You must specify at least one optional parameter on this command.

## Parameters

---

**schedule\_name** (Required)

Specifies the name of the schedule to be updated.

**Type=Administrative** (Required)

Specifies that an administrative command schedule is updated.

**CMD**

Specifies the administrative command to be scheduled for processing. This parameter is optional. The command you specify can contain up to 512 characters. Enclose the command in quotation marks if it contains blanks.

You cannot specify redirection characters with this parameter.

**ACTIVE**

Specifies whether the administrative command is eligible for processing. This parameter is optional. An administrative command schedule will not be processed unless it is set to the active state. Possible values are:

YES



Specifies that the administrative command is eligible for processing.

NO

Specifies that the administrative command is not eligible for processing.

#### DEscription

Specifies a description of the schedule. This parameter is optional. You can specify up to 255 characters for the description. Enclose the description in quotation marks if it contains blanks. To remove a previously defined description, specify a null string ("" ) for this value.

#### PRiority

Specifies the priority value for a schedule. This parameter is optional. You can specify an integer from 1 to 10, with 1 being the highest priority and 10 being the lowest. The default is 5.

If two or more schedules have the same window start time, the value you specify determines when IBM Spectrum Protect™ processes the schedule. The schedule with the highest priority starts first. For example, a schedule with PRIORITY=3 starts before a schedule with PRIORITY=5.

#### STARTDate

Specifies the date for the beginning of the window in which the schedule is first processed. This parameter is optional. The default is the current date. Use this parameter with the STARTTIME parameter to specify when the initial startup window of the schedule starts.

You can specify the date using one of the values below:

Value	Description	Example
MM/DD/YYYY	A specific date	09/15/1998
TODAY	The current date	TODAY
TODAY+days or +days	The current date plus days specified. The maximum number of days you can specify is 9999.	TODAY +3 or +3.
EOLM (End Of Last Month)	The last day of the previous month.	EOLM
EOLM-days	The last day of the previous month minus days specified.	EOLM-1 To include files that were active a day before the last day of the previous month.
BOTM (Beginning Of This Month)	The first day of the current month.	BOTM
BOTM+days	The first day of the current month, plus days specified.	BOTM+9 To include files that were active on the 10th day of the current month.

#### STARTTime

Specifies the time for the beginning of the window in which the schedule is first processed. This parameter is optional. The default is the current time. This parameter is used in conjunction with the STARTDATE parameter to specify when the initial startup window begins.

You can specify the time using one of the values below:

Value	Description	Example
HH:MM:SS	A specific time	10:30:08
NOW	The current time	NOW
NOW+HH:MM or +HH:MM	The current time plus hours and minutes specified	NOW+02:00 or +02:00. If you issue this command at 5:00 with STARTTIME=NOW+02:00 or STARTTIME=+02:00, the beginning of the startup window is at 7:00.
NOW-HH:MM or -HH:MM	The current time minus hours and minutes specified	NOW-02:00 or -02:00. If you issue this command at 5:00 with STARTTIME=NOW-02:00 or STARTTIME=-02:00, the beginning of the startup window is at 3:00.

## DURation

Specifies the number of units that define the length of the startup window of the scheduled operation. This parameter is optional. This value must be from 1 to 999. The default is 1.

Use this parameter with the DURUNITS parameter to specify the length of the startup window. For example, if you specify DURATION=20 and DURUNITS=MINUTES, the schedule must be started within 20 minutes of the start date and start time. The default length of the startup window is 1 hour. The duration of the window must be shorter than the period between windows.

This value is ignored if you specify DURUNITS=INDEFINITE.

## DURUnits

Specifies the time units used to determine the duration of the window in which the schedule can start. This parameter is optional. The default is HOURS.

Use this parameter with the DURATION parameter to specify how long the startup window remains open to process the schedule. For example, if DURATION=20 and DURUNITS=MINUTES, the schedule must be started within 20 minutes of the start date and start time. The schedule may not necessarily complete processing within this window. If the schedule needs to be retried for any reason, the retry attempts must begin before the startup window elapses, or the operation does not restart.

The default value for the length of the startup window is 1 hour. You can specify one of the following values:

### Minutes

Specifies that the duration of the window is defined in minutes.

### Hours

Specifies that the duration of the window is defined in hours.

### Days

Specifies that the duration of the window is defined in days.

### INDefinite

Specifies that the startup window of the scheduled operation has an indefinite duration. The schedule can run any time after the scheduled start time, until the schedule expires. You cannot specify DURUNITS=INDEFINITE, unless you specify PERUNITS=ONETIME. The INDEFINITE value is not allowed with enhanced schedules.

## MAXRUNtime

Specifies the maximum run time, which is the number of minutes during which server processes that are started by the scheduled commands must be completed. If processes are still running after the maximum run time, the central scheduler cancels the processes.

### Tips:

- The processes might not end immediately when the central scheduler cancels them; they end when they register the cancellation notification from the central scheduler.
- The maximum run time is calculated beginning from when the server process starts. If the schedule command starts more than one process, each process maximum run time is calculated from when the process starts.
- This parameter does not apply to some processes, such as duplicate-identification processes, which can continue to run after the maximum run time.
- This parameter does not apply if the scheduled command does not start a server process.
- Another cancel time might be associated with some commands. For example, the MIGRATE STGPOOL command can include a parameter that specifies the length of time that the storage pool migration runs before the migration is automatically canceled. If you schedule a command for which a cancel time is defined, and you also define a maximum run time for the schedule, the processes are canceled at whichever cancel time is reached first.

### Restrictions:

- The value of the parameter is not distributed to servers that are managed by an enterprise configuration manager.
- The value of the parameter is not exported by the EXPORT command.

This parameter is optional. You can specify a number in the range 0-1440. A value of 0 means that the maximum run time is indefinite, and the central scheduler does not cancel processes. The maximum run time must be greater than the startup window duration, which is defined by the DURATION and DURUNITS parameters.

For example, if the start time of a scheduled command is 9:00 PM, and the duration of the startup window is 2 hours, the startup window is 9:00 PM - 11:00 PM. If the maximum run time is 240 minutes, that is, 4 hours, all applicable server processes that are started by the command must be completed by 1:00 AM. If one or more applicable processes are still running after 1:00 AM, the central scheduler cancels the processes.

Tip: Alternatively, you can specify an *end time* of 1:00 AM in the IBM Spectrum Protect Operations Center.

#### SCHEDStyle

This parameter is optional. SCHEDSTYLE defines either the interval between times when a schedule should run, or the days on which it should run. The style can be either classic or enhanced. This parameter must be specified when you change a schedule from classic to enhanced or back to classic. Otherwise, the value for the existing schedule is used.

For classic schedules, these parameters are allowed: PERIOD, PERUNITS, and DAYOFWEEK. These parameters are not allowed: MONTH, DAYOFMONTH, and WEEKOFMONTH. If the previous schedule style was enhanced, the MONTH, DAYOFMONTH, WEEKOFMONTH, and DAYOFWEEK parameters will be reset. DAYOFWEEK, PERIOD, and PERUNITS will be set to default values unless they are specified with the update command.

For enhanced schedules, these parameters are allowed: MONTH, DAYOFMONTH, WEEKOFMONTH, and DAYOFWEEK. These parameters are not allowed: PERIOD and PERUNITS. If the previous schedule style was classic, the DAYOFWEEK, PERIOD, and PERUNITS parameters will be reset. MONTH, DAYOFMONTH, WEEKOFMONTH, and DAYOFWEEK will be set to default values unless they are specified with the update command.

#### PERiod

Specifies the length of time between startup windows for this schedule. This parameter is optional. This parameter is used only with classic schedules. You can specify an integer from 1 to 999. The default is 1.

Use this parameter with the PERUNITS parameter to specify the period between startup windows. For example, if you specify PERIOD=5 and PERUNITS=DAYS (assuming that DAYOFWEEK=ANY), the operation is scheduled every five days after the initial start date and start time. The period between startup windows must exceed the duration of each window. The default is 1 day.

This value is ignored if you specify PERUNITS=ONETIME.

#### PERUnits

Specifies the time units used to determine the period between startup windows for this schedule. This parameter is optional. This parameter is used only with classic schedules. The default is DAYS.

Use this parameter with the PERIOD parameter to specify the period between startup windows. For example, if you specify PERIOD=5 and PERUNITS=DAYS (assuming that DAYOFWEEK=ANY), the operation is scheduled every 5 days after the initial start date and start time. The default is 1 day. You can specify one of the following values:

##### Hours

Specifies that the time between startup windows is in hours.

##### Days

Specifies that the time between startup windows is in days.

##### Weeks

Specifies that the time between startup windows is in weeks.

##### Months

Specifies that the time between startup windows is in months.

When you specify PERUNITS=MONTHS, the scheduled operation will be processed each month on the same date. For example, if the start date for the scheduled operation is 02/04/1998, the schedule will process on the 4th of every month thereafter. However, if the date is not valid for the next month, then the scheduled operation will be processed on the last valid date in the month. Thereafter, subsequent operations are based on this new date. For example, if the start date is 03/31/1998, the next month's operation will be scheduled for 04/30/1998. Thereafter, all subsequent operations will be on the 30th of the month until February. Because February has only 28 days, the operation will be scheduled for 02/28/1999. Subsequent operations will be processed on the 28th of the month.

##### Years

Specifies that the time between startup windows for the schedule is in years.

When you specify PERUNITS=YEARS, the scheduled operation will be processed on the same month and date of each year. For example, if the start date for the scheduled operation is 02/29/2004, the next year's scheduled operation will be 02/28/2005 because February only has 28 days. Thereafter, subsequent operations will be scheduled for February 28th.

##### Onetime

Specifies that the schedule processes once. This value overrides the value you specified for the PERIOD parameter.

#### DAYofweek

Specifies the day of the week on which the startup window for the schedule begins. This parameter is optional. You can specify different options for the DAYofweek parameter, depending on whether the schedule style was defined as Classic or

Enhanced:

#### Classic Schedule

Specifies the day of the week on which the startup window for the schedule begins. This parameter is optional. You can either specify one day of the week, or WEEKDAY, WEEKEND, or ANY. If the start date and start time fall on a day that does not correspond to a day you specify, the start date and start time will be shifted forward in 24-hour increments until the DAYOFWEEK parameter is satisfied.

If you select a value for DAYOFWEEK other than ANY, and depending on the values for PERIOD and PERUNITS, schedules may not be processed when you would expect. The default is ANY.

#### Enhanced Schedule

Specifies the days of the week on which to run the schedule. You can either specify multiple days separated by commas and no intervening blanks, or WEEKDAY, WEEKEND, or ANY. If you specify multiple days, the schedule will run on each of the specified days. If you specify WEEKDAY or WEEKEND, you must also specify either WEEKOFMONTH=FIRST or WEEKOFMONTH=LAST, and the schedule will run just once per month.

The default value is ANY, meaning the schedule will run every day of the week or on the day or days determined by other enhanced schedule parameters. DAYOFWEEK must have a value of ANY (either by default or specified with the command) when used with the DAYOFMONTH parameter.

Possible values for the DAYofweek parameter are:

#### ANY

Specifies that the startup window can begin on any day of the week.

#### WEEKDay

Specifies that the startup window can begin on Monday, Tuesday, Wednesday, Thursday, or Friday.

#### WEEKEnd

Specifies that the startup window can begin on Saturday or Sunday.

#### SUnday

Specifies that the startup window begins on Sunday.

#### Monday

Specifies that the startup window begins on Monday.

#### TUesday

Specifies that the startup window begins on Tuesday.

#### Wednesday

Specifies that the startup window begins on Wednesday.

#### THursday

Specifies that the startup window begins on Thursday.

#### Friday

Specifies that the startup window begins on Friday.

#### SAturday

Specifies that the startup window begins on Saturday.

#### MONth

Specifies the months of the year during which to run the schedule. This parameter is used only with enhanced schedules. Specify multiple values by using commas and no intervening blanks. The default value is ANY. This means the schedule will run during every month of the year.

#### DAYOFMonth

Specifies the day of the month to run the schedule. This parameter can only be specified with enhanced schedules. You can either specify ANY or a number from -31 through 31, excluding zero. Negative values are a day from the end of the month, counting backwards. For example, the last day of the month is -1, the next-to-the-last day of the month is -2, etc. You can specify multiple values separated by commas and no intervening blanks. If you specify multiple values, the schedule will run on each of the specified days of the month. If multiple values resolve to the same day, the schedule will run only once that day.

The default value is ANY. This means the schedule will run on every day of the month or on the days determined by other enhanced schedule parameters. DAYOFMONTH must have a value of ANY (either by default or specified with the command) when used with the DAYOFWEEK or WEEKOFMONTH parameters.

#### WEEKofmonth

Specifies the week of the month in which to run the schedule. This parameter can only be specified with enhanced schedules. A week is considered any seven-day period which does not start on a particular day of the week. You can specify FIRST, SECOND, THIRD, FOURTH, LAST, or ANY. You can specify multiple values separated by commas and no intervening

blanks. If you specify multiple values, the schedule will run during each of the specified weeks of the month. If multiple values resolve to the same week, the schedule will run only once during that week.

The default value is ANY, meaning the schedule will run during every week of the month or on the day or days determined by other enhanced schedule parameters. WEEKOFMONTH must have a value of ANY (either by default or specified with the command) when used with the DAYOFMONTH parameter.

#### EXpiration

Specifies the date after which this schedule is no longer used. This parameter is optional. The default is NEVER. You can specify one of the following values:

##### Never

Specifies that the schedule never expires.

##### expiration\_date

Specifies the date on which this schedule expires, in MM/DD/YYYY format. If you specify an expiration date, the schedule expires at 23:59:59 on the date you specify.

## Example: Update a backup schedule to every three days

---

Update existing administrative schedule named BACKUP\_BACKUPPOOL so that starting today, the BACKUPPOOL primary storage pool is backed up to the COPYSTG copy storage pool every three days at 10:00 p.m.

```
update schedule backup_backuppool type=administrative cmd="backup stgpool
  backuppool copystg" active=yes starttime=22:00 period=3
```

## Example: Update a backup schedule to every first and third Friday

---

Update a schedule named BACKUP\_ARCHIVEPOOL that backs up the primary storage pool ARCHIVEPOOL to the copy storage pool RECOVERYPOOL. The existing schedule runs on the first and tenth day of every month. Update it to run the first and third Friday of every month.

```
update schedule backup_archivepool
  dayofweek=friday weekofmonth=first,third
```

DAYOFMONTH will be reset to ANY.

## UPDATE SCRATCHPADENTRY (Update a scratch pad entry)

---

Use this command to update data on a line in the scratch pad.

### Privilege class

---

To issue this command, you must have system privilege.

### Syntax

---

```
>>-UPDate SCRATCHPadentry--major_category--minor_category----->
>--subject--Line-----number--Data--==--data-----><
```

### Parameters

---

major\_category (Required)

Specifies the major category in which data is to be updated. This parameter is case sensitive.

minor\_category (Required)

Specifies the minor category in which data is to be updated. This parameter is case sensitive.

subject (Required)

Specifies the subject under which data is to be updated. This parameter is case sensitive.

Line (Required)

Specifies the number of the line on which data is to be updated.

Data (Required)

Specifies the new data to be stored on the line. Previous data is deleted. You can enter up to 1000 characters. Enclose the data in quotation marks if the data contains one or more blanks. The data is case sensitive.

## Example: Update a scratch pad entry

Update the vacation contact details of an administrator, Jane, in a database that stores information about the location of all administrators:

```
update scratchpadentry admin_info location jane line=2 data="Out of the office until 18 Nov."
```

## Related commands

Table 1. Commands related to UPDATE SCRATCHPADENTRY

Command	Description
DEFINE SCRATCHPADENTRY	Creates a line of data in the scratch pad.
DELETE SCRATCHPADENTRY	Deletes a line of data from the scratch pad.
QUERY SCRATCHPADENTRY	Displays information that is contained in the scratch pad.
SET SCRATCHPADRETENTION	Specifies the amount of time for which scratch pad entries are retained.

## UPDATE SCRIPT (Update an IBM Spectrum Protect script)

Use this command to change a command line or to add a new command line to an IBM Spectrum Protect™ script.

Restriction: You cannot redirect the output of a command within an IBM Spectrum Protect script. Instead, run the script and then specify command redirection. For example, to direct the output of script1 to the c:\temp\test.out directory, run the script and specify command redirection as in the following example:

```
run script1 > c:\temp\test.out
```

## Privilege class

To issue this command, the administrator must have previously defined the script or must have system privilege.

## Syntax

```
>>-UPDate SCript--script_name----->
>--+-----+----->
  '-command_line--+-----+'
                        '-Line----number-'
>--+-----+-----><
  '-DESCription----description-'
```

## Parameters

script\_name (Required)

Specifies the name of the script to be updated.

command\_line

Specifies a new or updated command to be processed in a script. You must update a command, a description, or both when you issue this command.

Command can contain substitution variables and may be continued across multiple lines if you specify a continuation character (-) as the last character in the command. You can specify up to 1200 characters for the command. Enclose the command in quotation marks if it contains blanks. If you specify this parameter, you can optionally specify the following parameter.

You have the options of running commands serially, in parallel, or serially and in parallel by specifying the SERIAL or PARALLEL script commands for this parameter. You can run multiple commands in parallel and wait for them to complete before proceeding to the next command. Commands will run serially until the parallel command is encountered.

Conditional logic flow statements can be used. These statements include IF, EXIT, and GOTO.

#### Line

Specifies the line number for the command. If you do not specify a line number, the command line is appended to the existing series of command lines. The appended command line is assigned a line number of five greater than the last command line number in the sequence. For example, if the last line in your script is 015, the appended command line is assigned a line number of 020.

If you specify a line number, the command will replace an existing line (if the number is the same as an existing line). Or the command will insert the specified line (if the line number does not correspond to an existing line number for the command line sequence).

#### DESCription

Specifies a description for the script. You can specify up to 255 characters for the description. Enclose the description in quotation marks if it contains blank characters.

### Example: Add a command to the end of a script

---

Assume that you have defined the following three line script, named QSAMPLE, and that you want to add the QUERY SESSION command to the end of the script.

```
001 /* This is a sample script */
005 QUERY STATUS
010 QUERY PROCESS
```

```
update script qsample "query session"
```

After the command processes, the script now consists of the following lines:

```
001 /* This is a sample script */
005 QUERY STATUS
010 QUERY PROCESS
015 QUERY SESSION
```

### Example: Update a specific line a script

---

Using the script from the prior example, change line 010 so that it processes the QUERY STGPOOL command instead of the QUERY PROCESS command:

```
update script qsample "query stgpool" line=010
```

After the command processes, the script now consists of the following lines:

```
001 /* This is a sample script */
005 QUERY STATUS
010 QUERY STGPOOL
015 QUERY SESSION
```

### Example: Insert a command in the middle of a script

---

Using the script from the prior example, insert a new command line (QUERY NODE) after the QUERY STATUS command line in the QSAMPLE script:

```
update script qsample "query node"
line=007
```

After the command processes, the script now consists of the following lines:

```
001 /* This is a sample script */
005 QUERY STATUS
007 QUERY NODE
```

## Related commands

Table 1. Commands related to UPDATE SCRIPT

Command	Description
COPY SCRIPT	Creates a copy of a script.
DEFINE SCRIPT	Defines a script to the IBM Spectrum Protect server.
DELETE SCRIPT	Deletes the script or individual lines from the script.
QUERY SCRIPT	Displays information about scripts.
RENAME SCRIPT	Renames a script to a new name.
RUN	Runs a script.

### Related tasks:

Running commands in parallel or serially  
 Including logic flow statements in a script  
 Performing tasks concurrently on multiple servers  
 Defining a server script

### Related reference:

Return codes for use in IBM Spectrum Protect scripts

## UPDATE SERVER (Update a server defined for server-to-server communications)

Use this command to update a server definition.

Restriction: If this server is a source server for a virtual volume operation, changing any of these values can affect the ability of the source server to access and manage the data that is stored on the corresponding target server. Changing the server name by using the SET SERVERNAME command might have additional implications, varying by operating system. The following are some examples:

- Passwords might be invalidated
- Device information might be affected
- Registry information about Windows operating systems might change

## Privilege class

To issue this command, you must have system privilege.

## Syntax for:

- Enterprise configuration
- Enterprise event logging
- Command routing
- Storage agent
- Node replication source and target servers
- **AIX** **Linux** **z/OS®** media server

```
>>-UPDate--SERver--server_name----->
>--+-----+----->
  '-SERVERPAssword---password-'
>--+-----+--+----->
  '-HLAddress----ip_address-' '-LLAddress----tcp_port-'
>--+-----+--+----->
  '-COMMmethod----TCPiP-' '-URL----url-'
```



```

>--+-----+----->
'-ALLOWReplace--++-Yes-+-'
          '-No--'

>--+-----+----->
'-DEscription--++-description-' '-FORCESync--++-Yes-+-'
          '-No--'

>--+-----+----->
| (1) |
'-VALIDateprotocol--++-No-+-'
          '-All-'

>--+-----+----->
'-SSL--++-No-+-'
          '-Yes-'

.-SESSIONSECurity--++-TRANSitional----.
>--+-----+----->
'-SESSIONSECurity--++-STRict-----+-'
          '-TRANSitional-'

.-TRANSFERMethod--++-Tcpi-----.
>--+-----+----->
'-TRANSFERMethod--++-Tcpi-----+-'
          | (2) |
          '-Fasp-----'

```

#### Notes:

1. The VALIDATEPROTOCOL parameter is deprecated and applies only to storage agent definitions.
2. **Linux** The TRANSFERMETHOD parameter is available only on Linux x86\_64 operating systems.

## Syntax for virtual volumes

```

>>-UPDate--SERver--server_name-+-----+----->
          '-PAssword--++-password-'

>--+-----+----->
'-HLAddress--++-ip_address-' '-LLAddress--++-tcp_port-'

>--+-----+----->
'-COMMmethod--++-TCPIP-' '-URL--++-url-'

>--+-----+----->
'-DELgraceperiod--++-days-' '-NODEName--++-node_name-'

.-SESSIONSECurity--++-TRANSitional----.
>--+-----+----->
'-SSL--++-Yes-' '-SESSIONSECurity--++-STRict-----+-'
          '-TRANSitional-'

>--+-----+----->
'-FORCESync--++-Yes-+-' '-DEscription--++-description-'
          '-No--'

```

## Parameters

### server\_name (Required)

Specifies the name of the server to be updated. This parameter is required.

### PAssword

Specifies the password that is used to sign on to the target server for virtual volumes. This parameter is optional.

### SERVERPAssword

Specifies the server password, which is used for enterprise configuration, command routing, and server-to-server event logging functions. The password must match the server password set by the SET SERVERPASSWORD command. This parameter is optional.

### HLAddress

Specifies the IP address (in dotted decimal format) of the server. This parameter is optional.

#### LLAddress

Specifies the low-level address of the server. This address is usually the same as the address in the TCP/PORT server option of the target server. When SSL=YES, the port must already be designated for SSL communications on the target server.

#### COMMmethod

Specifies the communication method that is used to connect to the server. This parameter is optional.

#### URL

Specifies the URL address that is used to access this server from the Administration Center. The parameter is optional.

#### DELgraceperiod

Specifies a number of days that an object remains on the target server after it was marked for deletion. You can specify a value 0 - 9999. The default is 5. This parameter is optional.

#### NODENAME

Specifies a node name to be used by the server to connect to the target server. This parameter is optional.

#### DESCRIPTION

Specifies a description of the server. This parameter is optional. The description can be up to 255 characters. Enclose the description in quotation marks if it contains blank characters. To remove an existing description, specify a null string (").

#### FORCESync

Specifies whether to reset the server verification key when the source server next signs on to the target server. A valid verification key enables a source server to put objects on the target server, manage the grace deletion period value, and update the password, if the current password is known and the verification key matches. The parameter is optional. You can specify one of the following values:

#### Yes

Specifies that a new verification key will be sent to and accepted by the target server if a valid password is received.

#### No

Specifies that a new verification key will not be sent to the target server.

#### VALIDATEprotocol (deprecated)

Specifies whether a cyclic redundancy check validates the data sent between the storage agent and the IBM Spectrum Protect™ server. The parameter is optional. The default is NO.

Important: Beginning with IBM Spectrum Protect Version 8.1.2, validation that is enabled by this parameter is replaced by the TLS 1.2 protocol, which is enforced by the SESSIONSECURITY parameter. The VALIDATEPROTOCOL parameter is ignored. Update your configuration to use the SESSIONSECURITY parameter.

#### ALLOWReplace

Specifies whether a server definition that was defined by a managed server can be replaced with a definition from the configuration manager. This parameter is optional. You can specify one of the following values:

#### Yes

Specifies that a server definition can be replaced by a definition from the configuration manager.

#### No

Specifies that a server definition cannot be replaced by the definition from the configuration manager.

#### SSL

Specifies the communication mode of the server.

Important: Beginning with V8.1.2, SSL is used to encrypt some communication with the specified server even when you specify NO.

The following conditions and considerations apply when you specify the SSL parameter:

- Before starting the servers, self-signed certificates of the partner servers must be in the key database file (cert.kdb) of each of the servers.
- You can define multiple server names with different parameters for the same target server.

You can specify one of the following values:

#### No

Specifies an SSL session for all communication with the specified server, except when the server is sending or receiving object data. Object data is sent and received by using TCP/IP. By choosing not to encrypt the object data, server performance is similar to communication over a TCP/IP session and the session is secure.

#### Yes

Specifies an SSL session for all communication with the specified server, even when the server is sending and receiving object data.

#### SESSIONSECURITY

Specifies whether the server that you are defining must use the most secure settings to communicate with an IBM Spectrum Protect server. This parameter is optional.

You can specify one of the following values:

#### STRICT

Specifies that the strictest security settings are enforced for the server that you are defining. The STRICT value uses the most secure communication protocol available, which is currently TLS 1.2. The TLS 1.2 protocol is used for SSL sessions between the specified server and an IBM Spectrum Protect server.

To use the STRICT value, the following requirements must be met to ensure that the specified server can authenticate with the IBM Spectrum Protect server:

- Both the server that you are defining and the IBM Spectrum Protect server must be using IBM Spectrum Protect software that supports the SESSIONSECURITY parameter.
- The server that you are defining must be configured to use the TLS 1.2 protocol for SSL sessions between itself and the IBM Spectrum Protect server.

Servers set to STRICT that do not meet these requirements are unable to authenticate with the IBM Spectrum Protect server.

#### TRANSITIONAL

Specifies that the existing security settings are enforced for the server. This is the default value. This value is intended to be used temporarily while you update your security settings to meet the requirements for the STRICT value.

If SESSIONSECURITY=TRANSITIONAL and the server has never met the requirements for the STRICT value, the server will continue to authenticate by using the TRANSITIONAL value. However, after a server meets the requirements for the STRICT value, the SESSIONSECURITY parameter value automatically updates from TRANSITIONAL to STRICT. Then, the server can no longer authenticate by using a version of the client or an SSL/TLS protocol that does not meet the requirements for STRICT. In addition, after a server successfully authenticates by using a more secure communication protocol, the server can no longer authenticate by using a less secure protocol. For example, if a server that is not using SSL is updated and successfully authenticates by using TLS 1.2, the server can no longer authenticate by using no SSL protocol or TLS 1.1. This restriction also applies when you use functions such as virtual volumes, command routing, or server-to-server export, when a node or administrator authenticates to the IBM Spectrum Protect server as a node or administrator from another server.

#### Linux TRANSFERMethod

Specifies the method that is used for server-to-server data transfer. This parameter is optional. You can specify one of the following values:

#### Tcpip

Specifies that TCP/IP is used to transfer data. This is the default.

#### Fasp

Specifies that Aspera® Fast Adaptive Secure Protocol (FASP®) technology is used to transfer data. Aspera FASP technology can help you optimize data transfer in a wide area network (WAN).

Restrictions:

- Before you enable Aspera FASP technology, determine whether the technology is appropriate for your system environment and install the appropriate licenses. For instructions, see Determining whether Aspera FASP technology can optimize data transfer in your system environment. If the licenses are missing or expired, data transfer operations fail.
- If WAN performance meets your business needs, do not enable Aspera FASP technology.
- If you specify TRANSFERMETHOD=FASP on the PROTECT STGPOOL or REPLICATE NODE command, that value overrides the TRANSFERMETHOD parameter on the DEFINE SERVER and UPDATE SERVER commands.

## Example: Update a deletion grace period for a server

---

Update the definition of SERVER2 to specify that objects remain on the target server for 10 days after they were marked for deletion.

```
update server server2 delgraceperiod=10
```

## Example: Update the URL for a server

---

Update the definition of NEWSERVER to specify its URL address to be http://newserver:1580/.

```
update server newserver url=http://newserver:1580/
```

## Example: Update all servers to communicate with an IBM Spectrum Protect server by using strict session security

Update the definition of all servers to use the strictest security settings to authenticate with the IBM Spectrum Protect server.

```
update server * sessionsecurity=strict
```

## Related commands

Table 1. Commands related to UPDATE SERVER

Command	Description
DEFINE DEVCLASS	Defines a device class.
DEFINE SERVER	Defines a server for server-to-server communications.
DELETE DEVCLASS	Deletes a device class.
DELETE FILESPACE	Deletes data associated with client file spaces. If a file space is part of a collocation group and you remove the file space from a node, the file space is removed from the collocation group.
DELETE SERVER	Deletes the definition of a server.
QUERY NODE	Displays partial or complete information about one or more clients.
QUERY SERVER	Displays information about servers.
RECONCILE VOLUMES	Reconciles source server virtual volume definitions and target server archive objects.
REGISTER NODE	Defines a client node to the server and sets options for that user.
REMOVE NODE	Removes a client from the list of registered nodes for a specific policy domain.
UPDATE DEVCLASS	Changes the attributes of a device class.
UPDATE NODE	Changes the attributes that are associated with a client node.

## UPDATE SERVERGROUP (Update a server group description)

Use this command to update the description of a server group.

### Privilege class

To issue this command, you must have system privilege.

### Syntax

```
>>-UPDate SERVERGroup--group_name----->  
>>-DESCRiption---description-----<
```

### Parameters

group\_name (Required)

Specifies the server group to update.

DESCRiption (Required)

Specifies a description of the server group. The maximum length of the description is 255 characters. Enclose the description in quotation marks if it contains blank characters.

## Example: Update the description of a server group

---

Update the description of the server group named WEST\_COMPLEX to "Western Region Complex".

```
update servergroup west_complex
description="western region complex"
```

## Related commands

---

Table 1. Commands related to UPDATE SERVERGROUP

Command	Description
COPY SERVERGROUP	Creates a copy of a server group.
DEFINE SERVERGROUP	Defines a new server group.
DELETE SERVERGROUP	Deletes a server group.
QUERY SERVERGROUP	Displays information about server groups.
RENAME SERVERGROUP	Renames a server group.

## UPDATE SPACETRIGGER (Update the space triggers)

---

Use this command to update settings for triggers that determine when and how the server resolves space shortages in storage pools that use sequential-access FILE and random-access DISK device classes.

For storage pools with a parameter RECLAMATIONTYPE=SNAPLOCK, space triggers are not enabled.

Important: Space trigger functions and storage pool space calculations take into account the space remaining in each directory. Ideally, you associate each directory with a separate file system. If you specify multiple directories for a device class and the directories reside in the same file system, the server calculates space by adding values representing the space remaining in each directory. These space calculations will be inaccurate. Rather than choosing a storage pool with sufficient space for an operation, the server might choose the wrong storage pool and run out of space prematurely. For space triggers, an inaccurate calculation might result in a failure to expand the space available in a storage pool. Failure to expand space in a storage pool is one of the conditions that can cause a trigger to become disabled. If a trigger is disabled because the space in a storage pool could not be expanded, you can re-enable the trigger by specifying the following command: `update spacetrigger stg`. No further changes are required to the space trigger.

See the DEFINE SPACETRIGGER command for more information.

## Privilege class

---

To issue this command, you must have system privilege or unrestricted storage privilege.

## Syntax

---

```
>>-UPDate SPACETriGger--STG--+-----+----->
                               '-Fullpct--==--percent-'
>--+-----+----->
  '-SPACExpansion--==--percent-'
>--+-----+----->
  '-EXPansionprefix--==--prefix-'
>--+-----+-----><
  '-STGPOOL--==--storage_pool_name-'
```

## Parameters

---

STG (Required)  
Specifies a storage pool space trigger

Fullpct

This parameter specifies the utilization percentage of the storage pool.

When this value is exceeded, the space trigger creates new volumes.

You can determine storage pool utilization by issuing the QUERY STGPOOL command with FORMAT=DETAILED. The percentage of storage pool utilization for the storage pool is displayed in the field "Space Trigger Util." The calculation for this percentage does not include potential scratch volumes. The calculation for the percentage utilization used for migration and reclamation, however, does include potential scratch volumes.

#### SPACExpansion

For space triggers for sequential-access FILE-type storage pools, this parameter is used in determining the number of additional volumes that are created in the storage pool. Volumes are created using the MAXCAPACITY value from the storage pool's device class. For space triggers for random-access DISK storage pools, the space trigger creates a single volume using the EXPANSIONPREFIX.

#### EXPansionprefix

This specifies the prefix that the server uses to create new storage pool files. This parameter is optional and applies only to random-access DISK device classes. The default prefix is the server installation path.

The prefix can include one or more directory separator characters, for example:

AIX | Linux

```
/opt/tivoli/tsm/server/bin/
```

Windows

```
c:\program files\tivoli\tsm\
```

AIX | Linux

You can specify up to 250 characters. If you specify a prefix that is not valid, automatic expansion can fail.

Windows

You can specify up to 200 characters. If the server is running as a Windows service, the default prefix is the c:\wnnt\system32 directory. If you specify a prefix that is not valid, automatic expansion can fail.

This parameter is not valid for space triggers for sequential-access FILE storage pools. Prefixes are obtained from the directories specified with the associated device class.

#### STGPOOL

Specifies the storage pool associated with this space trigger. If the STGPOOL parameter is not specified, the default storage pool space trigger is updated.

This parameter does not apply to storage pools with the parameter RECLAMATIONTYPE=SNAPLOCK.

## Example: Increase the amount of space for a storage pool

Increase the amount of space in a storage pool by 50 percent when it is filled to 80 percent utilization of existing volumes. Space will be created in the directories associated with the device class.

```
update spacetrigger stg spaceexpansion=50 stgpool=file
```

## Related commands

Table 1. Commands related to UPDATE SPACETRIGGER

Command	Description
DEFINE SPACETRIGGER	Defines a space trigger to expand the space for a storage pool.
DELETE SPACETRIGGER	Deletes the storage pool space trigger.
QUERY SPACETRIGGER	Displays information about a storage pool space trigger.

## UPDATE STATUSTHRESHOLD (Update a status monitoring threshold)

Use this command to update an existing status monitoring threshold.

Status monitoring thresholds compare the defined conditions to the status monitoring server queries and inserts the results in the status monitoring table.

Multiple thresholds can be defined for an activity. For example, you can create a threshold that provides a warning status if storage pool capacity utilization is greater than 80%. You can then create another threshold that provides error status if storage pool capacity utilization is greater than 90%.

Note: If a threshold is already defined for an EXISTS condition, you cannot define another threshold with one of the other condition types.

## Syntax

```
>>-UPdate STAtusthreshold--threshold_name--+-----+-->
                                     '-Activity-----activity_name-'

>--+-----+--+-----+----->
  '-Condition-----+EXists-+-'  '-Value-----value-'
      +-GT-----+
      +-GE-----+
      +-LT-----+
      +-LE-----+
      '-Equal--'

>--+-----+-----<<
  '-Status-----+Normal---+'
      +-Warning-+
      '-Error---'
```

## Parameters

threshold\_name (Required)

Specifies the threshold name that you want to update. The name cannot exceed 48 characters in length.

activity

Specify this value to change the activity for an existing threshold. This parameter is optional. Specify one of the following values:

PROCESSSUMMARY

Specifies the number of processes that are currently active.

SESSIONSUMMARY

Specifies the number of sessions that are currently active.

CLIENTSESSIONSUMMARY

Specifies the number of client sessions that are currently active.

SCHEDCLIENTSESSIONSUMMARY

Specifies the number of scheduled client sessions.

DBUTIL

Specifies the database utilization percentage. The default warning threshold value is 80%, and the default error threshold value is 90%.

DBFREESPACE

Specifies the free space available in the database in gigabytes.

DBUSEDSPACE

Specifies the amount of database space that is used, in gigabytes.

ARCHIVELOGFREESPACE

Specifies the free space that is available in the archive log, in gigabytes.

STGPOOLUTIL

Specifies the storage pool utilization percentage. The default warning threshold value is 80%, and the default error threshold value is 90%.

STGPOOLCAPACITY

Specifies the storage pool capacity in gigabytes.

AVGSTGPOOLUTIL

Specifies the average storage pool utilization percentage across all storage pools. The default warning threshold value is 80%, and the default error threshold value is 90%.

TOTSTGPOOLCAPACITY

Specifies the total storage pool capacity in gigabytes for all available storage pools.

TOTSTGPOOLS

Specifies the number of defined storage pools.

TOTRWSTGPOOLS

Specifies the number of defined storage pools that are readable or writeable.  
**TOTNOTRWSTGPOLS**

Specifies the number of defined storage pools that are not readable or writeable.  
**STGPOLINUSEANDDEFINED**

Specifies the total number of defined volumes that are in use.  
**ACTIVELOGUTIL**

Specifies the current percent utilization of the active log. The default warning threshold value is 80%, and the default error threshold value is 90%.  
**ARCHLOGUTIL**

Specifies the current utilization of the archive log. The default warning threshold value is 80%, and the default error threshold value is 90%.  
**CPYSTGPPOOLUTIL**

Specifies the percent utilization for a copy storage pool. The default warning threshold value is 80%, and the default error threshold value is 90%.  
**PMRYSTGPPOOLUTIL**

Specifies the percent utilization for a primary storage pool. The default warning threshold value is 80%, and the default error threshold value is 90%.  
**DEVCLASSPCTDRVOffline**

Specifies the percent utilization of drives that are offline, by device class. The default warning threshold value is 25%, and the default error threshold value is 50%.  
**DEVCLASSPCTDRVPOLLING**

Specifies the drives polling, by device class. The default warning threshold value is 25%, and the default error threshold value is 50%.  
**DEVCLASSPCTLIBPATHSOFFLINE**

Specifies the library paths that are offline, by device class. The default warning threshold value is 25%, and the default error threshold value is 50%.  
**DEVCLASSPCTPATHSOFFLINE**

Specifies the percentage of device class paths that are offline, by device class. The default warning threshold value is 25%, and the default error threshold value is 50%.  
**DEVCLASSPCTDISKSNOTRW**

Specifies the percentage of disks that are not writable for the disk device class. The default warning threshold value is 25%, and the default error threshold value is 50%.  
**DEVCLASSPCTDISKSUNAVAILABLE**

Specifies the percentage of the disk volumes that are unavailable, by device class. The default warning threshold value is 25%, and the default error threshold value is 50%.  
**FILEDEVCLASSPCTSCRUNALLOCATABLE**

Specifies the percentage of scratch volumes that the server cannot allocate for a given non-shared file device class. The default warning threshold value is 25%, and the default error threshold value is 50%.

#### Condition

Specify this value to change the condition of an existing threshold. This parameter is optional. Specify one of the following values:

#### EXists

Creates a status monitoring indicator if the activity exists.

#### GT

Creates a status monitoring indicator if the activity outcome is greater than the specified value.

#### GE

Creates a status monitoring indicator if the activity outcome is greater than or equal to the specified value.

#### LT

Creates a status monitoring indicator if the activity outcome is less than the specified value.

#### LE

Creates a status monitoring indicator if the activity outcome is less than or equal to the specified value.

#### EQual

Creates a status monitoring indicator if the activity outcome is equal to the specified value.

#### Value

Specify this parameter to change the value that is compared with the activity output for the specified condition. You can specify an integer in the range 0 - 9999999999999999.

#### Status

Specify this value to change the status of the indicator that is created in status monitoring if the condition that is being evaluated passes. This parameter is optional. Specify one of the following values:



- Normal  
Specifies that the status indicator has a normal status value.
- Warning  
Specifies that the status indicator has a warning status value.
- Error  
Specifies that the status indicator has an error status value.

## Update an existing status threshold

Update a status threshold for average storage pool utility percentage by issuing the following command:

```
update statusthreshold avgstgpl "AVGSTGPOOLUTIL" value=90 condition=gt status=error
```

## Related commands

Table 1. Commands related to UPDATE STATUSTHRESHOLD

Command	Description
DELETE STATUSTHRESHOLD (Delete a status monitoring threshold)	Deletes a status monitoring threshold.
QUERY MONITORSTATUS (Query the monitoring status)	Displays information about monitoring alerts and server status settings.
QUERY MONITORSETTINGS (Query the configuration settings for monitoring alerts and server status)	Displays information about monitoring alerts and server status settings.
QUERY STATUSTHRESHOLD (Query status monitoring thresholds)	Displays information about a status monitoring thresholds.
SET STATUSMONITOR (Specifies whether to enable status monitoring)	Specifies whether to enable status monitoring.
SET STATUSATRISKINTERVAL (Specifies whether to enable client at-risk activity interval evaluation)	Specifies whether to enable client at-risk activity interval evaluation
SET STATUSREFRESHINTERVAL (Set refresh interval for status monitoring)	Specifies the refresh interval for status monitoring.
SET STATUSSKIPASFAILURE (Specifies whether to use client at-risk skipped files as failure evaluation)	Specifies whether to use client at-risk skipped files as failure evaluation
UPDATE STATUSTHRESHOLD (Update a status monitoring threshold)	Changes the attributes of an existing status monitoring threshold.

## UPDATE STGPOOL (Update a storage pool)

Use this command to change a storage pool.

Restriction: If a client is using the simultaneous-write function and data deduplication, the data deduplication feature is disabled during backups to a storage pool.

The UPDATE STGPOOL command takes seven forms. The syntax and parameters for each form are defined separately.

Table 1. Commands related to UPDATE STGPOOL

Command	Description
BACKUP STGPOOL	Backs up a primary storage pool to a copy storage pool.
COPY ACTIVE DATA	Copies active backup data.
DEFINE COLLOC GROUP	Defines a collocation group.
DEFINE COLLOC MEMBER	Adds a client node or file space to a collocation group.
DEFINE STGPOOL	Defines a storage pool as a named collection of server storage media.

Command	Description
DELETE COLLOGROUP	Deletes a collocation group.
DELETE COLLOCMEMBER	Deletes a client node or file space from a collocation group.
DELETE STGPOOL	Deletes a storage pool from server storage.
MOVE DRMEDIA	Moves DRM media onsite and offsite.
MOVE MEDIA	Moves storage pool volumes that are managed by an automated library.
QUERY COLLOGROUP	Displays information about collocation groups.
QUERY DRMEDIA	Displays information about disaster recovery volumes.
QUERY NODEDATA	Displays information about the location and size of data for a client node.
QUERY SHREDSTATUS	Displays information about data waiting to be shredded.
QUERY STGPOOL	Displays information about storage pools.
RESTORE STGPOOL	Restores files to a primary storage pool from copy storage pools.
RESTORE VOLUME	Restores files stored on specified volumes in a primary storage pool from copy storage pools.
SET DRMDBBACKUPEXPIREDDAYS	Specifies criteria for database backup series expiration.
SHRED DATA	Manually starts the process of shredding deleted data.
UPDATE COLLOGROUP	Updates the description of a collocation group.

- UPDATE STGPOOL (Update a cloud-container storage pool)  
Use this command to update a container storage pool in a cloud environment. Cloud storage pools are not supported on Linux on System z®.
- UPDATE STGPOOL (Update a directory-container storage pool)  
Use this command to update a directory-container storage pool.
- UPDATE STGPOOL (Update a container-copy storage pool)  
Use this command to update a container-copy storage pool.
- UPDATE STGPOOL (Update a primary random access storage pool)  
Use this command to update a random access storage pool.
- UPDATE STGPOOL (Update a primary sequential access pool)  
Use this command to update a primary sequential access storage pool.
- UPDATE STGPOOL (Update a copy sequential access storage pool)  
Use this command to update a copy sequential access storage pool.
- UPDATE STGPOOL (Update an active-data sequential access)  
Use this command to update an active-data pool.

## UPDATE STGPOOL (Update a cloud-container storage pool)

Use this command to update a container storage pool in a cloud environment. Cloud storage pools are not supported on Linux on System z®.

The preferred way to define and configure a cloud-container storage pool is to use the Operations Center. For instructions and tips for the Operations Center and the command-line interface, see [Configuring a cloud-container storage pool for data storage](#).

### Privilege class

To issue this command, you must have system privilege, unrestricted storage privilege, or restricted storage privilege.

### Syntax

```
>>-UPDate STGpool--pool_name--+-----+---->
                               '-DEscription-----description-'
```

```

>----->
'-CLOUDType----+Swift-----+'
      +-Softlayer+
      '-V1Swift---'

>----->
'-CLOUDUrl----cloud_url-'

>----->
|                                     (1) |
'-IDentity----cloud_identity-----'

>----->
'-PAssword----password-'

>----->
'-CLOUDLocation----+Offpremise+++'
      '-ONpremise--'

>----->
|                                     (2) |
'-BUCKETName----bucket_name-----'

>----->
'-ACcEss----+READWrite---+'
      +-READOnly-----+
      +-UNAVailable+
      '-DESTroyed---'

>----->
'-MAXWriters----+NOLimit-----+'
      '-maximum_writers-'

>----->
'-REUsedelay----days-'

>-----><
|                                     .-COMPReSSion----Yes----- |
'-ENCRypt----+Yes-+-----+-----+'
      '-No--'   '-COMPReSSion----+Yes-+'
                                     '-No--'

```

Notes:

1. If you specified CLOUDTYPE=AZURE, do not specify the IDENTITY parameter.
2. This parameter is valid only if you specify CLOUDTYPE=S3.

## Parameters

---

**pool\_name** (Required)

Specifies the storage pool to update. This parameter is required.

**DEscription**

Specifies a description of the storage pool. This parameter is optional. The maximum length of the description is 255 characters. Enclose the description in quotation marks if it contains blank characters. To remove an existing description, specify a null string ("").

**CLOUDType**

Specifies the type of cloud environment where you are configuring a storage pool. This parameter is optional. Specify one of the following values:

**SOftlayer**

Specifies that the storage pool uses an IBM® SoftLayer® (IBM Bluemix) cloud computing system with an OpenStack Swift cloud computing system.

**SWift**

Specifies that the storage pool uses an OpenStack Swift cloud computing system. This value also specifies that the storage pool uses Version 2 of the protocol for authentication to the cloud. The URL of the cloud usually contains the version number of the protocol it is using.

**V1Swift**

Specifies that the storage pool uses an OpenStack Swift cloud computing system. This value also specifies that the storage pool uses Version 1 of the protocol for authentication to the cloud. The URL of the cloud usually contains the version number of the protocol it is using.

**Restriction:** If you used the DEFINE STGPOOL command to define a storage pool with CLOUDTYPE=S3 (Simple Storage Service), you cannot change to a different cloud type by using the UPDATE STGPOOL command. Additionally, you cannot change the cloud type of a non-S3 storage pool to S3 by using the UPDATE STGPOOL command.

#### CLOUDURL

Specifies the URL of the cloud environment where you are configuring the storage pool. Based on your cloud provider, you can use a region endpoint URL, an accessor IP address, a public authentication endpoint, or a similar value for this parameter. Be sure to include the protocol, such as `https://` or `http://`, at the beginning of the URL. The maximum length of the web address is 870 characters. The CLOUDURL parameter is not validated until the first backup begins. For more information about how to locate these values, select your cloud service provider from the list on the Configuring a cloud-container storage pool for data storage page.

**Tip:** To use more than one IBM Cloud Object Storage accessor, list the accessor IP addresses separated by a vertical bar (|), with no spaces, such as in the following example:

```
CLOUDURL=<accesser_URL1>|<accesser_URL2>|<accesser_URL3>
```

Use multiple accessers to improve performance. If you are using the IBM SoftLayer Cloud Object Store S3 solution, only one accessor is needed.

#### IDENTITY

Specifies the user ID for the cloud that is specified in the STGTYPE=CLOUD parameter. This parameter is required for all supported cloud computing systems except Azure. If you specified CLOUDTYPE=AZURE, do not specify the IDENTITY parameter. Based on your cloud provider, you can use an access key ID, a user name, a tenant name and user name, or a similar value for this parameter. The maximum length of the user ID is 255 characters.

#### PASSWORD (Required)

Specifies the password for the cloud that is specified in the STGTYPE=CLOUD parameter. Based on your cloud provider, you can use a shared access signature (SAS) token, secret access key, an API key, a password, or a similar value for this parameter. This parameter is required. The maximum length of the password is 255 characters. The IDENTITY and PASSWORD parameters are not validated until the first backup begins.

#### CLOUDLOCATION

Specifies the physical location of the cloud that is specified in the CLOUD parameter. This parameter is optional. You can specify one of the following values:

- Offpremise
- ONpremise

#### BUCKETName

Specifies the name for an Amazon Web Services (AWS) bucket or IBM Cloud Object Storage vault to use with this storage pool. AWS buckets and IBM Cloud Object Storage vaults are used in the same manner as containers in a cloud-container storage pool. This parameter is optional, and is valid only if this storage pool has a cloud type of S3. If the name that you specify does not exist, the server creates a bucket or vault with the specified name before using the bucket or vault. Follow the naming restrictions for your cloud provider when specifying this parameter. Review the permissions for the bucket or vault and ensure that the credentials for this storage pool have permission to read, write, list, and delete objects in this bucket or vault.

**Restriction:** You cannot change the bucket or vault if any cloud containers exist in this storage pool.

#### ACCESS

Specifies how client nodes and server processes access the storage pool. This parameter is optional. You can specify one of the following values:

##### READWrite

Specifies that client nodes and server processes can read and write to the storage pool.

##### READOnly

Specifies that client nodes and server processes can read only from the storage pool.

##### UNAVailable

Specifies that client nodes and server processes cannot access the storage pool. As a result, backups and restore fail for this storage pool. You can use this value to specify that the cloud service provider is temporarily unavailable.

##### DESTroyed

Specifies that client nodes and server processes cannot access the storage pool because the cloud service provider is permanently unavailable. Backups and restores fail for this storage pool, but any attempts to delete objects and containers from this storage pool finish successfully.

#### MAXWriters

Specifies the maximum number of writing sessions that can run concurrently on the storage pool. Specify a maximum number of writing sessions to control the performance of the cloud storage pool from negatively impacting other system resources. This parameter is optional. You can specify one of the following values:

NOLimit

Specifies that no maximum size limit exists for the number of writers that you can use. This value is the default.

maximum\_writers

Limits the maximum number of writers that you can use. Specify an integer in the range 1 - 99999.

REUsedelay

Specifies the number of days that must elapse after all deduplicated extents are removed from a cloud storage pool. This parameter controls the duration that deduplicated extents are associated with a cloud storage pool. When the value that is specified for the parameter expires, the deduplicated extents are deleted from the cloud storage pool. This parameter is optional. You can specify one of the following values:

1

Specifies that deduplicated extents are deleted from a cloud storage pool after one day.

days

You can specify an integer in the range 0 - 9999.

Tip: Set this parameter to a value that is greater than the number specified for the SET DRMDBBACKUPEXPIREDDAYS command. By setting this parameter to a higher value, you can ensure that when you restore the database to an earlier level, the references to files in the storage pool are still valid.

ENCRypt

Specifies whether the server encrypts client data before it writes it to the storage pool. You can specify the following values:

Yes

Specifies that client data is encrypted by the server.

No

Specifies that client data is not encrypted by the server.

This parameter is optional. The default depends on the physical location of the cloud, which is specified by the CLOUDLOCATION parameter. If the cloud is off premise, the server encrypts data by default. If the cloud is on premises, the server does not encrypt data by default.

COMPReSSion

Specifies whether data is compressed in the storage pool. This parameter is optional. You can specify one of the following values:

No

Specifies that data is not compressed in the storage pool.

Yes

Specifies that data is compressed in the storage pool. This is the default.

## Example 1: Update a cloud storage pool to specify a maximum number of data sessions

---

Update a cloud storage pool that is named STGPOOL1 and specify a maximum of 10 data sessions.

```
update stgpool stgpool1 maxwriters=10
```

## Example 2: Update the description of a cloud-container storage pool

---

Update a cloud-container storage pool that is named STGPOOL2. Remove the existing description from the storage pool.

```
update stgpool stgpool2 cloudurl=http://123.234.123.234:5000/v2.0  
identity=admin:admin password=protect8991 description=""
```

### Related tasks:

Configuring a cloud-container storage pool for data storage

AIX

Linux

Windows

## UPDATE STGPOOL (Update a directory-container storage pool)

---

Use this command to update a directory-container storage pool.

## Privilege class

---

To issue this command, you must have system privilege, unrestricted storage privilege, or restricted storage privilege.

## Syntax

---

```
>>-UPDate STGpool--pool_name--+-----+----->
                                     '-DESCRiption--description-'
                                     .
.-ACCess---READWrite-----
>--+-----+----->
  '-ACCess---+READWrite--+
                    +READOnly----+
                    '-UNAVailable-'

.-MAXSize---NOLimit-----
>--+-----+----->
  '-MAXSize---+maximum_file_size+-'
                    '-NOLimit-----'

.-MAXWriters---NOLimit-----
>--+-----+----->
  '-MAXWriters---+maximum_writers+-'
                    '-NOLimit-----'

>--+-----+----->
  '-NEXTstgpool---pool_name-'

>--+-----+----->
  '-PROTECTstgpool---target_stgpool-'

>--+-----+----->
  |                                     .,----- . |
  |                                     V             | |
  '-PROTECTLOCALstgpools---local_target_stgpool+-'

.-REUsedelay---1----
>--+-----+----->
  '-REUsedelay---days-' '-ENCRypt---+Yes+-'
                                     '-No--'

.-COMPRession---Yes-----
>--+-----+-----><
  '-COMPRession---+Yes+-'
                    '-No--'
```

## Parameters

---

### pool\_name (Required)

Specifies the storage pool to update. This parameter is required. The maximum length of the name is 30 characters.

### DESCRiption

Specifies a description of the storage pool. This parameter is optional. The maximum length of the description is 255 characters. Enclose the description in quotation marks if it contains any blank characters. To remove an existing description, specify a null string ("").

### ACCess

Specifies how client nodes and server processes access files in the storage pool. This parameter is optional. You can specify one of the following values:

#### READWrite

Specifies that client nodes and server processes can read and write to the storage pool. This is the default.

#### READOnly

Specifies that client nodes and server processes can only read from the storage pool.

#### UNAVailable

Specifies that client nodes and server processes cannot access the storage pool.

## MAXSize

Specifies the maximum size for a physical file that the server can store in the storage pool. This parameter is optional. The default value is NOLIMIT. Specify one of the following values:

### NOLimit

Specifies that there is no maximum size limit for physical files that are stored in the storage pool.

### maximum\_file\_size

Limits the maximum physical file size. Specify an integer in the range 1 - 999999, followed by a scale factor. For example, MAXSIZE=5G specifies that the maximum file size for this storage pool is 5 GB. Use one of the following scale factors:

Table 1. Scale factor  
for the maximum file  
size

Scale factor	Meaning
K	kilobyte
M	megabyte
G	gigabyte
T	terabyte

Tip: If you do not specify a unit of measurement for the maximum file size, the value is specified in bytes.

When the physical size of the storage pool exceeds the MAXSIZE parameter, the following table shows where files are typically stored.

Table 2. The location of a file according to the file size and the pool that is specified

Pool that is specified	Result
No pool is specified as the next storage pool in the hierarchy.	The server does not store the file.
A pool is specified as the next storage pool in the hierarchy.	The server stores the file in the storage pool that you specified.

Tip: If you also specify the NEXTstgpool parameter, update one storage pool in your hierarchy to have no limit on the maximum file size by specifying the MAXSIZE=NOLimit parameter. When you have at least one pool with no size limit, you ensure that no matter what its size, the server can store the file.

For multiple files that are sent during data deduplication processing, the server considers the size of the data deduplication process to be the file size. If the total size of all files in the process is larger than the maximum size limit, the server does not store the files in the storage pool.

## MAXWriters

Specifies the maximum number of I/O threads that can run concurrently on the storage pool. Specify a maximum number of I/O threads to control the number of I/O threads that are written simultaneously to the directory-container storage pool. This parameter is optional. As a best practice, use the default value of NOLIMIT. You can specify one of the following values:

### NOLimit

Specifies that no maximum number of I/O threads are written to the storage pool.

### maximum\_writers

Limits the maximum number of I/O threads that you can use. Specify an integer in the range 1 - 99999.

## NEXTstgpool

Specifies the name of a random-access or primary sequential storage pool to which files are stored when the directory-container storage pool is full. This parameter is optional.

Restrictions:

- To ensure that you do not create a chain of storage pools that leads to an endless loop, specify at least one storage pool in the hierarchy with no value.
- If you specify a sequential-access pool as the next storage pool, the pool must be in either NATIVE or NONBLOCK data format.
- Do not specify a directory-container or cloud-container storage pool.
- Do not use this parameter to specify a storage pool for data migration.

#### PROTECTstgpool

Specifies the name of the directory-container storage pool on the target server where the data is backed up when you use the PROTECT STGPOOL command for this storage pool. This parameter is optional.

#### PROTECTLOCALstgpools

Specifies the name of the container-copy storage pool on a local device where the data is backed up. This container-copy storage pool will be a local target storage pool when you use the PROTECT STGPOOL command. You can specify a maximum of two container-copy storage pool names to update. Separate multiple names with commas and no intervening spaces. The maximum length of each name is 30 characters. This parameter is optional.

To add or remove container-copy storage pools, specify the container-copy storage pool names to include. For example, if the existing container-copy storage pool includes COPY1 and you want to add COPY2, specify PROTECTLOCALSTGPOOLS=COPY1,COPY2. To remove all existing container-copy storage pools that are associated with the primary storage pool, specify a null string (""). For example, COPYSTGPOOLS="".

#### REUsedelay

Specifies the number of days that must elapse before all deduplicated extents are removed from a directory-container storage pool. This parameter controls the duration that deduplicated extents are associated with a directory-container storage pool. When the value that is specified for the parameter expires, the deduplicated extents are deleted from the directory-container storage pool. The default is 1. Specify one of the following values:

days

Specify an integer in the range 0 - 9999.

1

Specifies that deduplicated extents are deleted from a directory-container storage pool after one day.

Tip: Set this parameter to a value greater than the number that is specified as your database backup period to ensure that data extents are still valid when you restore the database to another level.

#### ENCRypt

Specifies whether the server encrypts client data before the server writes the data to the storage pool. You can specify the following values:

Yes

Specifies that client data is encrypted by the server.

No

Specifies that client data is not encrypted by the server.

#### COMPRession

Specifies whether data is compressed in the storage pool. This parameter is optional. You can specify one of the following values:

No

Specifies that data is not compressed in the storage pool.

Yes

Specifies that data is compressed in the storage pool. This is the default.

## Example: Update a storage pool to specify a maximum number of data sessions

---

Update a storage pool that is named STGPOOL1 and specify a maximum of 10 data sessions.

```
update stgpool stgpool1 maxwriters=10
```

## Example: Update a storage pool to specify the maximum size

---

Update a storage pool that is named STGPOOL2. The storage pool specifies the maximum file size that the server can store in the storage pool as 100 megabytes.

```
update stgpool stgpool2 maxsize=100M
```

## Example: Update the description of a storage pool

---



Update a storage pool that is named STGPOOL3. Remove the existing description from the storage pool.

```
update stgpool stgpool3 description=""
```

Table 3. Commands related to UPDATE STGPOOL

Command	Description
---------	-------------



Command	Description
DEFINE STGPOOL	Defines a storage pool as a named collection of server storage media.
DEFINE STGPOOLDIRECTORY	Defines a storage pool directory to a directory-container or cloud-container storage pool.
PROTECT STGPOOL	Protects a directory-container storage pool.
QUERY CONTAINER	Displays information about a container.
QUERY STGPOOL	Displays information about storage pools.
REPAIR STGPOOL	Repairs a directory-container storage pool.
 UPDATE STGPOOLDIRECTORY	Changes the attributes of a storage pool directory.
	

## UPDATE STGPOOL (Update a container-copy storage pool)

Use this command to update a container-copy storage pool.

### Privilege class

To issue this command, you must have system privilege, unrestricted storage privilege, or restricted storage privilege for the storage pool to be updated.

### Syntax

```
>>-UPDate STGpool--pool_name--+-+-----+----->
                                     '-MAXSCRatch---number-'
>--+-+-----+----->
    '-DESCription---description-'
>--+-+-----+----->
    '-ACCess---+-READWrite---+'
                +-READOnly---+
                '-UNAVailable-'
>--+-+-----+-----+----->
    '-PROTECTPProcess---number-' '-REClaim---percent-'
>--+-+-----+----->
    '-RECLAIMLIMit---+-NOLimit---+'
                '-vol_limit-'
>--+-+-----+-----><
    '-REUsedelay---days-'
```

### Parameters

**pool\_name** (Required)

Specifies the name of the storage pool to be updated.

**MAXSCRatch**

Specifies the maximum number of scratch volumes that the server can request for this storage pool. You can specify an integer in the range 0 - 100000000. If the server can request scratch volumes as needed, you do not have to define each volume to be used.

The value of this parameter is used to estimate the total number of volumes that are available in the storage pool and the corresponding estimated capacity for the storage pool.

**DESCription**

Specifies a description of the storage pool. This parameter is optional. The maximum length of the description is 255 characters. Enclose the description in quotation marks if it contains any blank characters. To remove an existing

description, specify a null string ("").

#### ACCess

Specifies how server processes such as storage-pool protection and repair can access data in the storage pool. This parameter is optional. You can specify one of the following values:

##### READWrite

Specifies that the server can read and write to volumes in the storage pool.

##### READOnly

Specifies that the server can only read volumes in the storage pool. The server can use data in the storage pool to restore extents to directory-container storage pools. No operations that write to the container-copy storage pool are allowed.

##### UNAVailable

Specifies that the server cannot access data that is stored on volumes in the storage pool.

#### PROTECTPRocess

Specifies the maximum number of parallel processes that are used when you issue the PROTECT STGPOOL command to copy data to this pool from a directory-container storage pool. This parameter is optional. Enter a value in the range 1 - 20.

The time that is required to complete the copy operation might be decreased by using multiple, parallel processes. However, in some cases when multiple processes are running, one or more of the processes must wait to use a volume that is already in use by a different process.

When you select this value, consider the number of logical and physical drives that can be dedicated to this operation. To access a tape volume, the server uses a mount point and a drive. The number of available mount points and drives depends on the mount limit of the device class for the storage pool, and on other server and system activity.

If you use the preview option on the PROTECT STGPOOL command, only one process is used and no mount points or drives are needed.

#### REClaim

Specifies when a volume becomes eligible for reclamation and reuse. Specify eligibility as the percentage of a volume's space that is occupied by extents that are no longer stored in the associated directory-container storage pool. Reclamation moves any extents that are still stored in the associated directory-container storage pool from eligible volumes to other volumes. Reclamation occurs only when a PROTECT STGPOOL command stores data into this storage pool.

This parameter is optional. You can specify an integer in the range 1 - 100. The value 100 specifies that volumes in this storage pool are not reclaimed.

The server determines that the volume is a candidate for reclamation if the percentage of reclaimable space on a volume is greater than the reclamation threshold of the storage pool.

By setting the reclaim value to 50 percent or greater, data that is moved from two reclaimed volumes uses no more than the equivalent of one new volume.

Use caution when you use reclamation with container-copy storage pools that have offsite volumes. When an offsite volume becomes eligible for reclamation, in effect the server moves the extents on the volume back to the onsite location. If a disaster occurs onsite, the server can obtain extents from the offsite volume if the restored database refers to extents on the offsite volume. Therefore, for disaster recovery purposes, ensure that you schedule database backups to run after storage pool protection schedules and DRM move schedules have run, and ensure that all database backup volumes are taken offsite along with the DRM volumes.

Tip: Set different reclamation values for offsite container-copy storage pools and onsite container-copy storage pools. Because container-copy storage pools store deduplicated data, the data extents are spread across multiple tape volumes. When you choose a reclamation threshold for an offsite copy, carefully consider the number of available mount points and the number of tape volumes that you must retrieve if a disaster occurs. Setting a higher threshold means that you must retrieve more volumes than you would if your reclamation value was lower. Using a lower threshold reduces the number of mount points that are required in a disaster. The preferred method is to set the reclamation value for offsite copies to 60, and for onsite copies, in the range 90 - 100.

#### RECLAIMLIMit

Specifies the maximum number of volumes that the server reclaims when you issue the PROTECT STGPOOL command and specify the RECLAIM=YESLIMITED or RECLAIM=ONLYLIMITED option. This parameter is valid only for container-copy storage pools. This parameter is optional. You can specify one of the following values:

##### NOLimit

Specifies that all volumes in the container-copy storage pool are processed for reclamation.

vol\_limit

Specifies the maximum number of volumes in the container-copy storage pool that are reclaimed. The value that you specify determines how many new scratch tapes are available after reclamation processing completes. You can specify a number in the range 1 - 100000.

REUsedelay

Specifies the number of days that must elapse after all extents are deleted from a volume before the volume can be rewritten or returned to scratch status. This parameter is optional. You can specify an integer in the range 0 - 9999. A value of 0 means that a volume can be rewritten or returned to scratch status as soon as all the extents are deleted from the volume.

Tip: Use this parameter to ensure that when you restore the database to an earlier level, database references to extents in the storage pool are still valid. You must set this parameter to a value greater than the number of days you plan to retain the oldest database backup. If you use disaster recovery manager, the number of days that are specified for this parameter must be the same as the number specified for the SET DRMDBBACKUPEXPIREDDAYS command.

## Example: Update a container-copy storage pool to delay volume reuse for 30 days

Update the storage pool that is named CONTAINER1\_COPY2 to change the delay for volume reuse to 30 days.

```
update stgpool container1_copy2 reusedelay=30
```

## Example: Update a container-copy storage pool to limit the number of reclaimed tape volumes to 10

Update the storage pool that is named CONTAINER1\_COPY2 to change the reclaim limit to 10 volumes.

```
update stgpool container1_copy2 reclaimlimit=10
```

Table 1. Commands related to UPDATE STGPOOL (Update a container-copy storage pool)

Command	Description
DEFINE STGPOOL (container-copy)	Define a container-copy storage pool that stores copies of data from a directory-container storage pool.
PROTECT STGPOOL	Protects a directory-container storage pool.
QUERY STGPOOL	Displays information about storage pools.
REPAIR STGPOOL	Repairs a directory-container storage pool.
UPDATE STGPOOL (directory-container)	Update a directory-container storage pool.

## UPDATE STGPOOL (Update a primary random access storage pool)

Use this command to update a random access storage pool.

### Privilege class

To issue this command, you must have system privilege, unrestricted storage privilege, or restricted storage privilege for the storage pool to be updated.

### Syntax

```
>>-UPDate STGpool--pool_name---+-----+---->
                                '-DESCRiption----description-'
>--+-----+----->
  '-ACCess----+READWrite----+'
                    +-READOnly----+
                    '-UNAVailable-'
>--+-----+----->
  '-MAXSize----+maximum_file_size--+'
                    '-NOLimit-----'
```

```

>----->
'-CRCData---+Yes-+-' '-NEXTstgpool---pool_name-'
      '-No--'

>----->
'-Highmig---percent-' '-Lowmig---percent-'

>----->
'-CAche---+Yes-+-' '-MIGProcess---number-'
      '-No--'

>----->
'-MIGDelay---days-' '-MIGContinue---+Yes-+-'
                        '-No--'

>----->
'-AUTOCopy---+None-----+'
      +-Client----+
      +-MIGRation+
      '-All-----'

>----->
|           .-,----- . |
|           v          | |
'-COPYSTGpools---copypoolname-+-'

>----->
'-COPYContinue---+Yes-+-'
      '-No--'

>----->
|           .-,----- . |
|           v          | |
'-ACTIVEDATApools---active-data_pool_name-+-'

.-SHRED---0-----
>----->>
'-SHRED---overwrite_count-'

```

## Parameters

pool\_name (Required)

Specifies the storage pool to update. This parameter is required.

DEscription

Specifies a description of the storage pool. This parameter is optional. The maximum length of the description is 255 characters. Enclose the description in quotation marks if it contains any blank characters. To remove an existing description, specify a null string ("").

ACCess

Specifies how client nodes and server processes (such as migration and reclamation) can access files in the storage pool. This parameter is optional. You can specify the following values:

READWrite

Specifies that client nodes and server processes can read and write to files stored on volumes in the storage pool.

READOnly

Specifies that client nodes can only read files from the volumes in the storage pool.

Server processes can move files within the volumes in the storage pool. However, no new writes are permitted to volumes in the storage pool from volumes outside the storage pool.

If this storage pool was specified as a subordinate storage pool (with the NEXTSTGPOOL parameter) and is defined as *readonly*, the storage pool is skipped when server processes attempt to write files to the storage pool.

UNAvailable

Specifies that client nodes cannot access files stored on volumes in the storage pool.

Server processes can move files within the volumes in the storage pool and can also move or copy files from this storage pool to another storage pool. However, no new writes are permitted to volumes in the storage pool from volumes outside the storage pool.

If this storage pool was specified as a subordinate storage pool (with the NEXTSTGPOOL parameter) and is defined as *unavailable*, the storage pool is skipped when server processes attempt to write files to the storage pool.

#### MAXSize

Specifies the maximum size for a physical file that the server can store in the storage pool. This parameter is optional. You can specify the following values:

#### NOLimit

Specifies that there is no maximum size limit for physical files stored in the storage pool.

#### maximum\_file\_size

Limits the maximum physical file size. Specify an integer from 1 to 999999 terabytes, followed by a scale factor. For example, MAXSIZE=5G specifies that the maximum file size for this storage pool is 5 gigabytes. Scale factors are:

Scale factor	Meaning
K	kilobyte
M	megabyte
G	gigabyte
T	terabyte

The client estimates the size of files that are sent to the server. The client estimate is used rather than the actual amount of data that is sent to the server. Client options, such as deduplication, compression, and encryption, can cause the actual amount of data that is sent to the server to be larger or smaller than the size estimate. For example, the compression of a file might be smaller in size than the estimate, thus sending less data than the estimate. Furthermore, a binary file might be larger in size after the compression processing, thus sending more data than the estimate.

See the following table for information about where a file is stored when its size exceeds the MAXSIZE parameter.

Table 1. Where a file is stored according to the file size and the pool that is specified

File size	Pool specified	Result
Exceeds the maximum size	No pool is specified as the next storage pool in the hierarchy	The server does not store the file
	A pool is specified as the next storage pool in the hierarchy	The server stores the file in the next storage pool that can accept the file size

If you specify the next storage pool parameter, define one storage pool in your hierarchy to have no limit on the maximum file size. By having no limit on the size for at least one pool, you ensure that no matter what its size, the server can store the file.

For multiple files that are sent in a single transaction, the server considers the size of the transaction to be the file size. If the total size of all files in the transaction is larger than the maximum size limit, the server does not store the files in the storage pool.

#### CRCDATA

Specifies whether a cyclic redundancy check (CRC) validates storage pool data when audit volume processing occurs on the server. This parameter is optional. The default value is NO. By setting CRCDATA to YES and scheduling an AUDIT VOLUME command, you can continually ensure the integrity of data that is stored in your storage hierarchy. You can specify the following values:

#### Yes

Specifies that data is stored containing CRC information, allowing for audit volume processing to validate storage pool data. This mode impacts performance because more expenditure is required to calculate and compare CRC values between the storage pool and the server.

#### No

Specifies that data is stored without CRC information.

#### NEXTstgpool

Specifies a primary storage pool to which files are migrated. This parameter is optional.

To remove an existing storage pool from the storage hierarchy, specify a null string ("") for this value.

If you do not specify a next storage pool, the following actions occur:

- The server cannot migrate files from this storage pool
- The server cannot store files that exceed the maximum size for this storage pool in another storage pool

Restrictions:

- To ensure that you do not create a chain of storage pools that leads to an endless loop, specify at least one storage pool in the hierarchy with no value.
- If you specify a sequential-access pool as the next storage pool, the pool must be in either NATIVE or NONBLOCK data format.
- Do not specify a directory-container or cloud-container storage pool.
- Do not use this parameter to specify a storage pool for data migration.

HIghmig

Specifies that the server starts migration for this storage pool when the amount of data in the pool reaches this percentage of the pool's estimated capacity. This parameter is optional. You can specify an integer 0 - 100.

When the storage pool exceeds the high migration threshold, the server can start migration of files by node to the next storage pool, as defined with the NEXTSTGPOOL parameter. You can specify HIGHMIG=100 to prevent migration for this storage pool.

LOWmig

Specifies that the server stops migration for this storage pool when the amount of data in the pool reaches this percentage of the pool's estimated capacity. You can specify an integer 0 - 99 for this optional parameter.

When migration is by node or file space, depending upon collocation, the level of the storage pool can fall below the value that you specified for this parameter. To empty the storage pool, set LOWMIG=0.

CAChe

Specifies whether the migration process leaves a cached copy of a file in this storage pool after you migrate the file to the next storage pool. This parameter is optional. You can specify the following values:

Yes

Specifies that caching is enabled.

No

Specifies that caching is disabled.

Using cache might improve your ability to retrieve files, but might affect the performance of other processes.

MIGPRocess

Specifies the number of processes that are used for migrating files from this storage pool. This parameter is optional. You can specify an integer 1 - 999.

During migration, these processes are run in parallel to provide the potential for improved migration rates.

Tips:

- The number of migration processes is dependent upon the following settings:
  - The setting of the MIGPROCESS parameter
  - The collocation setting of the next pool
  - The number of nodes or the number of collocation groups with data in the storage pool that is being migrated

For this example, `MIGPROCESS =6`, the next pool `COLLOCATE` parameter is `NODE`, but there are only two nodes with data on the storage pool. Migration processing consists of only two processes, not six. If the `COLLOCATE` parameter is `GROUP` group and both nodes are in the same group, migration processing consists of only one process. If the `COLLOCATE` parameter is `NO` or `FILESPACE` group, and each node has two file spaces with backup data, then migration processing consists of only four processes.
- When you specify this parameter, consider whether the simultaneous-write function is enabled for server data migration. Each migration process requires a mount point and a drive for each copy storage pool and active-data pool that is defined to the target storage pool.

MIGDelay

Specifies the minimum number of days a file must remain in a storage pool before it becomes eligible for migration. To calculate a value to compare to the specified MIGDELAY value, the server counts the following items:

- The number of days that the file was in the storage pool
- The number of days, if any, since the file was retrieved by a client

The lesser of the two values are compared to the specified MIGDELAY value. For example, if all the following conditions are true, a file is not migrated:

- A file was in a storage pool for five days.
- The file was accessed by a client within the past three days.
- The value that is specified for the MIGDELAY parameter is four days.

This parameter is optional. You can specify an integer 0 - 9999. The default is 0, which means that you do not want to delay migration.

If you want the server to count the number of days that are based on when a file was stored and not when it was retrieved, use the NORETRIEVEDATE server option.

#### MIGContinue

Specifies whether you allow the server to migrate files that do not satisfy the migration delay time. This parameter is optional.

Because you can require that files remain in the storage pool for a minimum number of days, the server may migrate all eligible files to the next storage pool yet not meet the low migration threshold. This parameter allows you to specify whether the server is allowed to continue the migration process by migrating files that do not satisfy the migration delay time.

You can specify one of the following values:

#### Yes

Specifies that, when necessary to meet the low migration threshold, the server continues to migrate files that do not satisfy the migration delay time.

If you allow more than one migration process for the storage pool, some files that do not satisfy the migration delay time may be migrated unnecessarily. As one process migrates files that satisfy the migration delay time, a second process could begin migrating files that do not satisfy the migration delay time to meet the low migration threshold. The first process that is still migrating files that satisfy the migration delay time might have, by itself, caused the low migration threshold to be met.

#### No

Specifies that the server stops migration when no eligible files remain to be migrated, even before reaching the low migration threshold. The server does not migrate files unless the files satisfy the migration delay time.

#### AUTOCopy

Specifies when IBM Spectrum Protect™ runs simultaneous-write operations to copy storage pools and active-data pools. This parameter affects the following operations:

- Client store sessions
- Server import processes
- Server data-migration processes

If an error occurs while data is being simultaneously written to a copy storage pool or active-data pool during a migration process, the server stops writing to the failing storage pools for the remainder of the process. However, the server continues to store files into the primary storage pool and any remaining copy storage pools or active-data pools. These pools remain active for the duration of the migration process. Copy storage pools are specified using the COPYSTGPOOLS parameter. Active-data pools are specified using the ACTIVEDATAPOOLS parameter.

You can specify one of the following values:

#### None

Specifies that the simultaneous-write function is disabled.

#### CLient

Specifies that data is written simultaneously to copy storage pools and active-data pools during client store sessions or server import processes. During server import processes, data is written simultaneously to only copy storage pools. Data is not written to active-data pools during server import processes.

#### MIGRation

Specifies that data is written simultaneously to copy storage pools and active-data pools only during migration to this storage pool. During server data-migration processes, data is written simultaneously to copy storage pools and active-data pools only if the data does not exist in those pools. Nodes whose data is being migrated must be in a

domain associated with an active-data pool. If the nodes are not in a domain associated with an active pool, the data cannot be written to the pool.

All

Specifies that data is written simultaneously to copy storage pools and active-data pools during client store sessions, server import processes, or server data-migration processes. Specifying this value ensures that data is written simultaneously whenever this pool is a target for any of the eligible operations.

#### COPYSTGPools

Specifies the names of copy storage pools where the server simultaneously writes data. You can specify a maximum of three copy pool names that are separated by commas. Spaces between the names of the copy pools are not allowed. To add or remove one or more copy storage pools, specify the pool name or names that you want to include in the updated list. For example, if the existing copy pool list includes COPY1 and COPY2 and you want to add COPY3, specify COPYSTGPools=COPY1,COPY2,COPY3. To remove all existing copy storage pools that are associated with the primary storage pool, specify a null string ("" ) for the value (for example, COPYSTGPools="").

When you specify a value for the COPYSTGPools parameter, you can also specify a value for the COPYCONTINUE parameter. For more information, see the COPYCONTINUE parameter.

The combined total number of storage pools that are specified in the COPYSGTPOOLS and ACTIVEDATAPOOLS parameters cannot exceed three.

When a data storage operation switches from a primary storage pool to a next storage pool, the next storage pool inherits the list of copy storage pools and the COPYCONTINUE value from the primary storage pool. The primary storage pool is specified by the copy group of the management class that is bound to the data.

The server can write data simultaneously to copy storage pools for the following operations:

- Back up and archive operations by IBM Spectrum Protect backup-archive clients or application clients that are using the IBM Spectrum Protect API
- Migration operations by IBM Spectrum Protect for Space Management clients
- Import operations that involve copying exported file data from external media to a primary storage pool associated with a copy storage pool list

Restrictions: The simultaneous-write function is not supported for the following store operations:

- When the operation is using LAN-free data movement. Simultaneous-write operations take precedence over LAN-free data movement, causing the operations to go over the LAN. However, the simultaneous-write configuration is accepted.
- NAS backup operations. If the primary storage pool specified in the DESTINATION or TOCDESTINATION in the copy group of the management class has copy storage pools that are defined:
  - The copy storage pools are ignored
  - The data is stored into the primary storage pool only

Attention: The function that is provided by the COPYSTGPools parameter is not intended to replace the BACKUP STGPPOOL command. If you use the COPYSTGPools parameter, continue to use the BACKUP STGPPOOL command to ensure that the copy storage pools are complete copies of the primary storage pool. There are cases when a copy might not be created. For more information, see the COPYCONTINUE parameter description.

#### COPYContinue

Specifies how the server reacts to a copy storage pool write failure for any of the copy storage pools that are listed in the COPYSTGPools parameter. This parameter is optional. When you specify the COPYCONTINUE parameter, either a COPYSTGPools list must exist or the COPYSTGPools parameter must also be specified.

You can specify the following values:

Yes

If the COPYCONTINUE parameter is set to YES, the server will stop writing to the failing copy pools for the remainder of the session, but continue storing files into the primary pool and any remaining copy pools. The copy storage pool list is active only for the life of the client session and applies to all the primary storage pools in a particular storage pool hierarchy.

No

If the COPYCONTINUE parameter is set to NO, the server will fail the current transaction and discontinue the store operation.

Restrictions:



- The setting of the COPYCONTINUE parameter does not affect active-data pools. If a write failure occurs for any of the active-data pools, the server stops writing to the failing active-data pool for the remainder of the session, but continues storing files into the primary pool and any remaining active-data pools and copy storage pools. The active-data pool list is active only for the life of the session and applies to all the primary storage pools in a particular storage pool hierarchy.
- The setting of the COPYCONTINUE parameter does not affect the simultaneous-write function during server import. If data is being written simultaneously and a write failure occurs to the primary storage pool or any copy storage pool, the server import process fails.
- The setting of the COPYCONTINUE parameter does not affect the simultaneous-write function during server data migration. If data is being written simultaneously and a write failure occurs to any copy storage pool or active-data pool, the failing storage pool is removed and the data migration process continues. Write failures to the primary storage pool cause the migration process to fail.

#### ACTIVEDATApools

Specifies the names of active-data pools where the server simultaneously writes data during a client backup operation. The ACTIVEDATAPOOLS parameter is optional. Spaces between the names of the active-data pools are not allowed.

The combined total number of storage pools that are specified in the COPYSSTPOOLS and ACTIVEDATAPOOLS parameters cannot exceed three.

When a data storage operation switches from a primary storage pool to a next storage pool, the next storage pool inherits the list of active-data pools from the destination storage pool that is specified in the copy group. The primary storage pool is specified by the copy group of the management class that is bound to the data.

The server can write data simultaneously to active-data pools only during backup operations by IBM Spectrum Protect backup-archive clients or application clients that use the IBM Spectrum Protect API.

Restrictions:

1. This parameter is available only to primary storage pools that use "NATIVE" or "NONBLOCK" data format. This parameter is not available for storage pools that use the following data formats:
  - NETAPPDUMP
  - CELERRADUMP
  - NDMPDUMP
2. Writing data simultaneously to active-data pools is not supported when you use LAN-free data movement. Simultaneous-write operations take precedence over LAN-free data movement, causing the operations to go over the LAN. However, the simultaneous-write configuration is followed.
3. The simultaneous-write function is not supported when a NAS backup operation is writing a TOC file. If the primary storage pool specified in the TOCDESTINATION in the copy group of the management class has active-data pools that are defined:
  - The active-data pools are ignored
  - The data is stored into the primary storage pool only
4. You cannot use the simultaneous-write function with CENTERA storage devices.
5. Data that is being imported is not stored in active-data pools. After an import operation, use the COPY ACTIVEDATA command to store the imported data in an active-data pool.

Attention: The function that is provided by the ACTIVEDATAPOOLS parameter is not intended to replace the COPY ACTIVEDATA command. If you use the ACTIVEDATAPOOLS parameter, use the COPY ACTIVEDATA command to ensure that the active-data pools contain all active data of the primary storage pool.

#### SHRED

Specifies whether data is physically overwritten when it is deleted. This parameter is optional. You can specify an integer 0 - 10.

If you specify a value of zero, the server deletes the data from the database. However, the storage that is used to contain the data is not overwritten, and the data exists in storage until that storage is reused for other data. It might be possible to discover and reconstruct the data after it is deleted. Changing the value (for example, resetting it to 0) does not affect data that was deleted and is waiting to be overwritten.

If you specify a value greater than 0, the server deletes the data both logically and physically. The server overwrites the storage that is used to contain the data the specified number of times. This overwriting increases the difficulty of discovering and reconstructing the data after it is deleted.

To ensure that all copies of the data are shredded, specify a SHRED value greater than zero for the storage pool that is specified in the NEXTSTGPPOOL parameter. Do not specify either the COPYSTGPPOOLS or ACTIVEDATAPOOLS. Specifying

relatively high values for the overwrite count generally improves the level of security, but might affect performance adversely.

Overwriting of deleted data is done asynchronously after the delete operation is complete. Therefore, the space that is occupied by the deleted data remains occupied for some time. The space is not available as free space for new data.

A SHRED value greater than zero cannot be used if the value of the CACHE parameter is YES. If you want to enable shredding for an existing storage pool for which caching is already enabled, you must change the value of the CACHE parameter to NO. Existing cached files remain in storage so that subsequent retrieval requests can be satisfied quickly. If space is needed to store new data, the existing cached files are erased so that the space they occupied can be used for the new data. The existing cached files are not shredded when they are erased.

Important: After an export operation finishes and identifies files for export, any change to the storage pool SHRED value is ignored. An export operation that is suspended retains the original SHRED value throughout the operation. You might want to consider canceling your export operation if changes to the storage pool SHRED value jeopardize the operation. You can reissue the export command after any needed cleanup.

## Example: Update a random access storage pool to allow caching

---

Update the random access storage pool that is named BACKUPPOOL to allow caching when the server migrates files to the next storage pool.

```
update stgpool backuppool cache=yes
```

## UPDATE STGPOOL (Update a primary sequential access pool)

---

Use this command to update a primary sequential access storage pool.

Restrictions:

1. You cannot use this command to change the data format for the storage pool.
2. If the value for DATAFORMAT is NETAPPDUMP, CELERRADUMP, or NDMPDUMP, you can modify only the following attributes:
  - o DESCRIPTION
  - o ACCESS
  - o COLLOCATE
  - o MAXSCRATCH
  - o REUSEDELAY

## Privilege class

---

To issue this command, you must have system privilege, unrestricted storage privilege, or restricted storage privilege for the storage pool to be updated.

## Syntax

---

```
>>-UPDate STGpool--pool_name--+-----+----->
                                   '-DESCRiption--description-'
>--+-----+----->
  '-ACCess---+READWrite---+'
      +-READOnly----+
      '-UNAVailable-'
>--+-----+----->
  |                                     (1) (2) |
  '-MAXSIZe---+maximum_file_size+-----+'
      '-NOLimit-----'
>--+-----+----->
  |                                     (1) |
  '-CRCData---+Yes+-----+'
      '-No--'
>--+-----+----->
  |                                     (1) (2) |
```

```

'-NEXTstgpool-----pool_name-----'
>-----+----->
|           (1) (2) |
|'-HIGHmig-----percent-----'
>-----+----->
|           (1) (2) |
|'-LOWmig-----percent-----'
>-----+----->
|           (1) (2) |
|'-REclaim-----percent-----'
>-----+----->
|           (1) (2) |
|'-RECLAIMPRocess-----number-----'
>-----+----->
|           (1) (2) |
|'-RECLAIMSTGpool-----pool_name-----'
>-----+----->
|           (2) |
|'-COLlocate-----+No-----+-----'
|           +-GRoup-----+
|           +-NODE-----+
|           '-Filespace-'
>-----+-----+-----+----->
|           (2) | |           (2) |
|'-MAXSCRatch-----number-----' |'-REUsedelay-----days-----'
>-----+-----+----->
|           (1) (2) |
|'-OVFLocation-----location-----'
>-----+-----+----->
|           (1) (2) |
|'-MIGDelay-----days-----'
>-----+-----+----->
|           (1) (2) |
|'-MIGContinue-----+Yes-----+-----'
|           '-No--'
>-----+-----+----->
|           (1) (2) |
|'-MIGPRocess-----number-----'
>-----+-----+----->
|'-AUTOCopy-----+None-----+-----'
|           +-Client-----+
|           +-MIGRation+
|           '-All-----'
>-----+-----+-----+----->
|           .,----- . |
|           v           (1) (2) | |
|'-COPYSTGpools-----coppoolname-----+-----'
>-----+-----+----->
|           (1) (2) |
|'-COPYContinue-----+Yes-----+-----'
|           '-No--'
>-----+-----+-----+----->
|           .,----- . |
|           v           | |
|'-ACTIVEDATApools-----active-data_pool_name+-----'
>-----+-----+----->
|'-DEDUPlicate-----+No-----+-----'
|           |           (3) |

```

'-Yes-----'

```
>-----<
|                                     (4) |
|'-IDENTIFYPRocess-----number-----'|
```

#### Notes:

1. This parameter is not available for storage pools that use the data formats NETAPPDUMP, CELERRADUMP, or NDMPDUMP.
2. This parameter is not available for CENTERA storage pools.
3. This parameter is valid only for storage pools that are defined with a FILE-type device class.
4. This parameter is only available if the value of the DEDUPLICATE parameter is YES.

## Parameters

---

### pool\_name (Required)

Specifies the name of the storage pool to be updated.

### DEscription

Specifies a description of the storage pool. This parameter is optional. The maximum length of the description is 255 characters. Enclose the description in quotation marks if it contains any blank characters. To remove an existing description, specify a null string ("").

### ACcess

Specifies how client nodes and server processes (such as migration and reclamation) can access files in the storage pool. This parameter is optional. You can specify the following values:

#### READWrite

Specifies that client nodes and server processes can read and write to files stored on volumes in the storage pool.

#### READOnly

Specifies that client nodes can only read files from the volumes in the storage pool.

Server processes can move files within the volumes in the storage pool. However, no new writes are permitted to volumes in the storage pool from volumes outside the storage pool.

If this storage pool was specified as a subordinate storage pool (with the NEXTSTGPOOL parameter) and is defined as *readonly*, the storage pool is skipped when server processes attempt to write files to the storage pool.

#### UNAVailable

Specifies that client nodes cannot access files stored on volumes in the storage pool.

Server processes can move files within the volumes in the storage pool and can also move or copy files from this storage pool to another storage pool. However, no new writes are permitted to volumes in the storage pool from volumes outside the storage pool.

If this storage pool was specified as a subordinate storage pool (with the NEXTSTGPOOL parameter) and is defined as *unavailable*, the storage pool is skipped when server processes attempt to write files to the storage pool.

### MAXSize

Specifies the maximum size for a physical file that the server can store in the storage pool. This parameter is optional. You can specify the following values:

#### NOLimit

Specifies that there is no maximum size limit for physical files stored in the storage pool.

#### maximum\_file\_size

Limits the maximum physical file size. Specify an integer from 1 to 999999 terabytes, followed by a scale factor. For example, MAXSIZE=5G specifies that the maximum file size for this storage pool is 5 gigabytes. Scale factors are:

Scale factor	Meaning
K	kilobyte
M	megabyte
G	gigabyte
T	terabyte

The client estimates the size of files that are sent to the server. The client estimate is used rather than the actual amount of data that is sent to the server. Client options, such as deduplication, compression, and encryption, can cause the actual amount of data that is sent to the server to be larger or smaller than the size estimate. For example, the compression of a file might be smaller in size than the estimate, thus sending less data than the estimate. Furthermore, a binary file might be larger in size after the compression processing, thus sending more data than the estimate.

When the physical size of the storage pool exceeds the MAXSIZE parameter, the following table shows where files are typically stored.

Table 1. The location of a file according to the file size and the pool that is specified

File size	Pool specified	Result
Exceeds the maximum size	No pool is specified as the next storage pool in the hierarchy	The server does not store the file
	A pool is specified as the next storage pool in the hierarchy	The server stores the file in the next storage pool that can accept the file size

Tip: If you also specify the NEXTstgpool parameter, define one storage pool in your hierarchy to have no limit on the maximum file size by specifying the MAXSize=NOLimit parameter. When you have at least one pool with no size limit, you ensure that no matter what its size, the server can store the file.

For multiple files that are sent in a single transaction, the server considers the size of the transaction to be the file size. If the total size of all files in the transaction is larger than the maximum size limit, the server does not store the files in the storage pool.

Restriction: This parameter is not available for storage pools that use the following data formats:

- NETAPPDUMP
- CELERRADUMP
- NDMPDUMP

#### CRCDATA

Specifies whether a cyclic redundancy check (CRC) validates storage pool data when audit volume processing occurs on the server. This parameter is only valid for NATIVE data format storage pools. This parameter is optional. The default value is NO. By setting CRCDATA to YES and scheduling an AUDIT VOLUME command, you can continually ensure the integrity of data that is stored in your storage hierarchy. You can specify the following values:

Yes

Specifies that data is stored containing CRC information, allowing for audit volume processing to validate storage pool data. This mode impacts performance because more processing is required to calculate and compare CRC values between the storage pool and the server.

No

Specifies that data is stored without CRC information.

Tip:

For storage pools that are associated with the 3592, LTO, or ECARTRIDGE device type, logical block protection provides better protection against data corruption than CRC validation for a storage pool. If you specify CRC validation for a storage pool, data is validated only during volume auditing operations. Errors are identified after data is written to tape.

To enable logical block protection, specify a value of READWRITE for the LBPROTECT parameter on the DEFINE DEVCLASS and UPDATE DEVCLASS commands for the 3592, LTO, or ECARTRIDGE device types. Logical block protection is supported only on the following types of drives and media:

- IBM® LTO5 and later.
- IBM 3592 Generation 3 drives and later with 3592 Generation 2 media and later.
- Oracle StorageTek T10000C and T10000D drives.

#### NEXTstgpool

Specifies a primary storage pool to which files are migrated. You cannot migrate data from a sequential access storage pool to a random access storage pool. This parameter is optional. The next storage pool must be a primary storage pool.

To remove an existing value, specify a null string ("").

If this storage pool does not have a next storage pool, the server cannot migrate files from this storage pool and cannot store files that exceed the maximum size for this storage pool in another storage pool.

When there is insufficient space available in the current storage pool, the NEXTSTGPOOL parameter for sequential access storage pools does not allow data to be stored into the next pool. In this case, the server issues a message and the transaction fails.

For next storage pools with a device type of FILE, the server completes a preliminary check to determine whether sufficient space is available. If space is not available, the server skips to the next storage pool in the hierarchy. If space is available, the server attempts to store data in that pool. However, it is possible that the storage operation might fail because, at the time the actual storage operation is attempted, the space is no longer available.

Restrictions:

- To ensure that you do not create a chain of storage pools that leads to an endless loop, specify at least one storage pool in the hierarchy with no value.
- If you specify a sequential-access pool as the next storage pool, the pool must be in either NATIVE or NONBLOCK data format.
- Do not specify a directory-container or cloud-container storage pool.
- Do not use this parameter to specify a storage pool for data migration.
- This parameter is not available for storage pools that use the following data formats:
  - NETAPPDUMP
  - CELERRADUMP
  - NDMPDUMP

#### HIghmig

Specifies that the server starts migration when storage pool utilization reaches this percentage. For sequential-access disk (FILE) storage pools, utilization is the ratio of data in a storage pool to the pool's total estimated data capacity, including the capacity of all scratch volumes specified for the pool. For storage pools that use tape media, utilization is the ratio of volumes that contain data to the total number of volumes in the storage pool. The total number of volumes includes the maximum number of scratch volumes. This parameter is optional. You can specify an integer 0 - 100.

When the storage pool exceeds the high migration threshold, the server can start migration of files by volume to the next storage pool defined for the storage pool. You can set the high migration threshold to 100 to prevent migration for the storage pool.

Restriction: This parameter is not available for storage pools that use the following data formats:

- NETAPPDUMP
- CELERRADUMP
- NDMPDUMP

#### LOwmig

Specifies that the server stops migration when storage pool utilization is at or below this percentage. For sequential-access disk (FILE) storage pools, utilization is the ratio of data in a storage pool to the pool's total estimated data capacity, including the capacity of all scratch volumes specified for the pool. For storage pools that use tape media, utilization is the ratio of volumes that contain data to the total number of volumes in the storage pool. The total number of volumes includes the maximum number of scratch volumes. This parameter is optional. You can specify an integer 0 - 99.

When the storage pool reaches the low migration threshold, the server does not start migration of files from another volume. You can set the low migration threshold to 0 to allow migration to empty the storage pool.

Restriction: This parameter is not available for storage pools that use the following data formats:

- NETAPPDUMP
- CELERRADUMP
- NDMPDUMP

#### REClaim

Specifies when the server reclaims a volume, which is based on the percentage of reclaimable space on a volume. Reclaimable space is the amount of space that is occupied by files that are expired or deleted from the IBM Spectrum Protect™ database.

Reclamation makes the fragmented space on volumes usable again by moving any remaining unexpired files from one volume to another volume, thus making the original volume available for reuse. This parameter is optional. You can specify an integer 1 - 100.

The server determines that the volume is a candidate for reclamation if the percentage of reclaimable space on a volume is greater than the reclamation threshold of the storage pool.

Specify a value of 50 percent or greater for this parameter so that files stored on two volumes can be combined onto a single output volume.

**AIX** | **Windows** For storage pools that use a WORM device class, you can lower the value from the default of 100. Lowering the value allows the server to consolidate data onto fewer volumes when needed. Volumes that are emptied by reclamation can be checked out of the library, freeing slots for new volumes. Because the volumes are write-once, the volumes cannot be reused.

Restriction: This parameter is not available for storage pools that use the following data formats:

- NETAPPDUMP
- CELERRADUMP
- NDMPDUMP

#### RECLAIMPRocess

Specifies the number of parallel processes to use for reclaiming the volumes in this storage pool. This parameter is optional. Enter a value 1 - 999. You can specify one or more reclamation processes for each primary sequential-access storage pool.

When you calculate the value for this parameter, consider the following resources that are required for reclamation processing:

- The number of sequential storage pools.
- The number of logical and physical drives that can be dedicated to the operation.

To access sequential volumes, IBM Spectrum Protect uses a mount point and, if the device type is not FILE, a physical drive.

For example, suppose that you want to reclaim the volumes from two sequential storage pools simultaneously and that you want to specify four processes for each of the storage pools. The storage pools have the same device class. Assuming that the RECLAIMSTGPOOL parameter is not specified or that the reclaim storage pool has the same device class as the storage pool that is being reclaimed, each process requires two mount points and, if the device type is not FILE, two drives. (One of the drives is for the input volume, and the other drive is for the output volume.) To run eight reclamation processes simultaneously, you need a total of at least 16 mount points and 16 drives. The device class for the two storage pools must have a mount limit of at least 16.

Restriction: This parameter is not available for storage pools that use the following data formats:

- NETAPPDUMP
- CELERRADUMP
- NDMPDUMP

#### RECLAIMSTGpool

Specifies another primary storage pool as a target for reclaimed data from this storage pool. This parameter is optional. When the server reclaims volumes for the storage pool, unexpired data is moved from the volumes that are being reclaimed to the storage pool named with this parameter.

To remove an existing value, specify a null string ("").

A reclaim storage pool is most useful for a storage pool that has only one drive in its library. When you specify this parameter, the server moves all data from reclaimed volumes to the reclaim storage pool regardless of the number of drives in the library.

To move data from the reclaim storage pool back to the original storage pool, use the storage pool hierarchy. Specify the original storage pool as the next storage pool for the reclaim storage pool.

Restriction: This parameter is not available for storage pools that use the following data formats:

- NETAPPDUMP
- CELERRADUMP
- NDMPDUMP

#### COLlocate

Specifies whether the server attempts to keep data, which is stored on as few volumes as possible, that belong to one of the following candidates:

- A single client node
- A group of file spaces
- A group of client nodes
- A client file space

This parameter is optional.

Collocation reduces the number of sequential access media mounts for restore, retrieve, and recall operations. However, collocation increases both the amount of server time that is needed to collocate files for storing and the number of volumes required. Collocation can also impact the number of processes that are migrating disks to sequential pool.

You can specify one of the following options:

No

Specifies that collocation is disabled. During migration from disk, processes are created at a file space level.

GRoup

Specifies that collocation is enabled at the group level for client nodes or file spaces. For collocation groups, the server attempts to put data for nodes or file spaces that belong to the same collocation group on as few volumes as possible.

If you specify COLLOCATE=GROUP but do not define any collocation groups, or if you do not add nodes or file spaces to a collocation group, data is collocated by node. Consider tape usage when you organize client nodes or file spaces into collocation groups.

For example, if a tape-based storage pool consists of data from nodes and you specify COLLOCATE=GROUP, the server completes the following actions:

- Collocates the data by group for grouped nodes. Whenever possible, the server collocates data that belongs to a group of nodes on a single tape or on as few tapes as possible. Data for a single node can also be spread across several tapes that are associated with a group.
- Collocates the data by node for ungrouped nodes. Whenever possible, the server stores the data for a single node on a single tape. All available tapes that already have data for the node are used before available space on any other tape is used.
- During migration from disk, the server creates migration processes at the collocation group level for grouped nodes, and at the node level for ungrouped nodes.

If a tape-based storage pool consists of data from grouped file spaces and you specify COLLOCATE=GROUP, the server completes the following actions:

- Collocates by group, the data for grouped file spaces only. Whenever possible, the server collocates data that belongs to a group of file spaces on a single tape or on as few tapes as possible. Data for a single file space can also be spread across several tapes that are associated with a group.
- Collocates the data by node (for file spaces that are not explicitly defined to a file space collocation group). For example, node1 has file spaces that are named A, B, C, D, and E. File spaces A and B belong to a file space collocation group but C, D, and E do not. File spaces A and B are collocated by file space collocation group, while C, D, and E are collocated by node.
- During migration from disk, the server creates migration processes at the collocation group level for grouped file spaces.

Data is collocated on the least number of sequential access volumes.

NODe

Specifies that collocation is enabled at the client node level. For collocation groups, the server attempts to put data for one node on as few volumes as possible. If the node has multiple file spaces, the server does not try to collocate those file spaces. For compatibility with an earlier version, COLLOCATE=YES is still accepted by the server to specify collocation at the client node level.

If a storage pool contains data for a node that is a member of a collocation group and you specify COLLOCATE=NODE, the data is collocated by node.

For COLLOCATE=NODE, the server creates processes at the node level when you migrate data from disk.

FIlespace



Specifies that collocation is enabled at the file space level for client nodes. The server attempts to place data for one node and file space on as few volumes as possible. If a node has multiple file spaces, the server attempts to place data for different file spaces on different volumes.

For COLLOCATE=FILESPEC, the server creates processes at the file space level when you migrate data from disk.

#### MAXSCRatch

Specifies the maximum number of scratch volumes that the server can request. This parameter is optional. You can specify an integer 0 - 100000000. By allowing the server to request scratch volumes, you avoid having to define each volume to be used.

The value that is specified for this parameter is used to estimate the total number of volumes available in the storage pool and the corresponding estimated capacity for the storage pool.

Scratch volumes are automatically deleted from the storage pool when they become empty. When scratch volumes with the device type of FILE are deleted, the space that the volumes occupied is freed by the server and returned to the file system.

Tip: For server-to-server operations that use virtual volumes and that store a small amount of data, consider specifying a value for the MAXSCRATCH parameter that is higher than the value you typically specify for write operations to other types of volumes. After a write operation to a virtual volume, IBM Spectrum Protect marks the volume as FULL, even if the value of the MAXCAPACITY parameter on the device-class definition is not reached. The server does not keep virtual volumes in FILLING status and does not append to them. If the value of the MAXSCRATCH parameter is too low, server-to-server operations can fail.

#### REUsedelay

Specifies the number of days that must elapse after all files are deleted from a volume before the volume can be rewritten or returned to the scratch pool. This parameter is optional. You can specify an integer 0 - 9999. The value 0 means that a volume can be rewritten or returned to the scratch pool as soon as all files are deleted from the volume.

By specifying this parameter, you can ensure that the database can be restored to an earlier level and database references to files in the storage pool would still be valid.

#### OVFLOcation

Specifies the overflow location for the storage pool. The server assigns this location name to a volume that is ejected from the library by the MOVE MEDIA command. This parameter is optional. The location name can be a maximum length of 255 characters. Enclose the location name in quotation marks if the location name contains any blank characters.

To remove an existing value, specify a null string ("").

Restriction: This parameter is not available for storage pools that use the following data formats:

- NETAPPDUMP
- CELERRADUMP
- NDMPDUMP

#### MIGDelay

Specifies the minimum number of days a file must remain in a storage pool before it becomes eligible for migration. All files on a volume must be eligible for migration before the server selects the volume for migration. To calculate a value to compare to the specified MIGDELAY, the server counts the number of days that the file has been in the storage pool.

This parameter is optional. You can specify an integer 0 - 9999.

If you want the server to count the number of days that are based only on when a file was stored and not when it was retrieved, use the NORETRIEVEDATE server option.

Restriction: This parameter is not available for storage pools that use the following data formats:

- NETAPPDUMP
- CELERRADUMP
- NDMPDUMP

#### MIGContinue

Specifies whether you allow the server to migrate files that do not satisfy the migration delay time. This parameter is optional.

Because you can require that files remain in the storage pool for a minimum number of days, the server may migrate all eligible files to the next storage pool yet not meet the low migration threshold. This parameter allows you to specify whether the server is allowed to continue migration by migrating files that do not satisfy the migration delay time.

You can specify one of the following values:

Yes

Specifies that, when necessary to meet the low migration threshold, the server continues to migrate files that have not been stored in the storage pool for the number of days specified by the migration delay period.

No

Specifies that the server stops migration when no eligible files remain to be migrated, even before reaching the low migration threshold. The server does not migrate files unless the files have been stored in the storage pool for the number of days specified by the migration delay period.

Restriction: This parameter is not available for storage pools that use the following data formats:

- NETAPPDUMP
- CELERRADUMP
- NDMPDUMP

#### MIGPPROCESS

Specifies the number of parallel processes to use for migrating the files from the volumes in this storage pool. This parameter is optional. Enter a value 1 - 999.

When calculating the value for this parameter, consider the number of sequential storage pools that will be involved with the migration, and the number of logical and physical drives that can be dedicated to the operation. To access a sequential-access volume, IBM Spectrum Protect uses a mount point and, if the device type is not FILE, a physical drive. The number of available mount points and drives depends on other IBM Spectrum Protect and system activity and on the mount limits of the device classes for the sequential access storage pools that are involved in the migration.

For example, suppose you want to simultaneously migrate the files from volumes in two primary sequential storage pools and that you want to specify three processes for each of the storage pools. The storage pools have the same device class. Assuming that the storage pool to which files are being migrated has the same device class as the storage pool from which files are being migrated, each process requires two mount points and, if the device type is not FILE, two drives. (One drive is for the input volume, and the other drive is for the output volume.) To run six migration processes simultaneously, you need a total of at least 12 mount points and 12 drives. The device class for the storage pools must have a mount limit of at least 12.

If the number of migration processes you specify is more than the number of available mount points or drives, the processes that do not obtain mount points or drives will wait for mount points or drives to become available. If mount points or drives do not become available within the MOUNTWAIT time, the migration processes will end. For information about specifying the MOUNTWAIT time, see DEFINE DEVCLASS (Define a device class).

The IBM Spectrum Protect server will start the specified number of migration processes regardless of the number of volumes that are eligible for migration. For example, if you specify ten migration processes and only six volumes are eligible for migration, the server will start ten processes and four of them will complete without processing a volume.

Note: When you specify this parameter, consider whether the simultaneous-write function is enabled for server data migration. Each migration process requires a mount point and a drive for each copy storage pool and active-data pool that is defined to the target storage pool.

#### AUTOCOPY

Specifies when IBM Spectrum Protect completes simultaneous-write operations. This parameter affects the following operations:

- Client store sessions
- Server import processes
- Server data-migration processes

If the AUTOCOPY option is set to ALL or CLIENT, and there is at least one storage pool that is listed in the COPYSTGPOOLS or ACTIVEDATAPOOLS options, any client-side deduplication is disabled.

If an error occurs while data is being simultaneously written to a copy storage pool or active-data pool during a migration process, the server stops writing to the failing storage pools for the remainder of the process. However, the server continues to store files into the primary storage pool and any remaining copy storage pools or active-data pools. These

pools remain active for the duration of the migration process. Copy storage pools are specified using the `COPYSTGPOOLS` parameter. Active-data pools are specified using the `ACTIVEDATAPOOLS` parameter.

You can specify one of the following values:

None

Specifies that the simultaneous-write function is disabled.

Client

Specifies that data is written simultaneously to copy storage pools and active-data pools during client store sessions or server import processes. During server import processes, data is written simultaneously to only copy storage pools. Data is not written to active-data pools during server import processes.

MIGRation

Specifies that data is written simultaneously to copy storage pools and active-data pools only during migration to this storage pool. During server data-migration processes, data is written simultaneously to copy storage pools and active-data pools only if the data does not exist in those pools. Nodes whose data is being migrated must be in a domain associated with an active-data pool. If the nodes are not in a domain associated with an active pool, the data cannot be written to the pool.

All

Specifies that data is written simultaneously to copy storage pools and active-data pools during client store sessions, server import processes, or server data-migration processes. Specifying this value ensures that data is written simultaneously whenever this pool is a target for any of the eligible operations.

`COPYSTGpools`

Specifies the names of copy storage pools where the server simultaneously writes data. You can specify a maximum of three copy pool names that are separated by commas. Spaces between the names of the copy pools are not allowed. To add or remove one or more copy storage pools, specify the pool name or names that you want to include in the updated list. For example, if the existing copy pool list includes `COPY1` and `COPY2` and you want to add `COPY3`, specify `COPYSTGPOOLS=COPY1,COPY2,COPY3`. To remove all existing copy storage pools that are associated with the primary storage pool, specify a null string (""), for the value (for example, `COPYSTGPOOLS=""`).

When you specify a value for the `COPYSTGPOOLS` parameter, you can also specify a value for the `COPYCONTINUE` parameter. For more information, see the `COPYCONTINUE` parameter.

The combined total number of storage pools that are specified in the `COPYSGTPOOLS` and `ACTIVEDATAPOOLS` parameters cannot exceed three.

When a data storage operation switches from a primary storage pool to a next storage pool, the next storage pool inherits the list of copy storage pools and the `COPYCONTINUE` value from the primary storage pool. The primary storage pool is specified by the copy group of the management class that is bound to the data.

The server can write data simultaneously to copy storage pools during the following operations:

- Back up and archive operations by IBM Spectrum Protect backup-archive clients or application clients that use the IBM Spectrum Protect API
- Migration operations by IBM Spectrum Protect for Space Management clients
- Import operations that involve copying exported file data from external media to a primary storage pool associated with a copy storage pool list

Restrictions:

1. This parameter is available only to primary storage pools that use `NATIVE` or `NONBLOCK` data format. This parameter is not available for storage pools that use the following data formats:
  - `NETAPPDUMP`
  - `CELERRADUMP`
  - `NDMPDUMP`
2. Simultaneous-write operations takes precedence over LAN-free data movement, causing the operations to go over the LAN. However, the simultaneous-write configuration is accepted.
3. The simultaneous-write function is not supported for NAS backup operations. If the primary storage pool specified in the `DESTINATION` or `TOCDESTINATION` in the copy group of the management class has copy storage pools defined, the copy storage pools are ignored and the data is stored into the primary storage pool only.
4. You cannot use the simultaneous-write function with `CENTERA` storage devices.

Attention: The function that is provided by the `COPYSTGPOOLS` parameter is not intended to replace the `BACKUP STGPOOL` command. If you use the `COPYSTGPOOLS` parameter, continue to use the `BACKUP STGPOOL` command to ensure that the

copy storage pools are complete copies of the primary storage pool. There are cases when a copy might not be created. For more information, see the COPYCONTINUE parameter description.

#### COPYContinue

Specifies how the server reacts to a copy storage pool write failure for any of the copy storage pools that are listed in the COPYSTGPOOLS parameter. This parameter is optional. The default is YES. When you specify the COPYCONTINUE parameter, either a COPYSTGPOOLS list must exist or the COPYSTGPOOLS parameter must also be specified.

The COPYCONTINUE parameter has no effect on the simultaneous-write function during migration.

You can specify the following values:

#### Yes

If the COPYCONTINUE parameter is set to YES, the server will stop writing to the failing copy pools for the remainder of the session, but continue storing files into the primary pool and any remaining copy pools. The copy storage pool list is active only for the life of the client session and applies to all the primary storage pools in a particular storage pool hierarchy.

#### No

If the COPYCONTINUE parameter is set to NO, the server will fail the current transaction and discontinue the store operation.

Restrictions:

- The setting of the COPYCONTINUE parameter does not affect active-data pools. If a write failure occurs for any of the active-data pools, the server stops writing to the failing active-data pool for the remainder of the session, but continues storing files into the primary pool and any remaining active-data pools and copy storage pools. The active-data pool list is active only for the life of the session and applies to all the primary storage pools in a particular storage pool hierarchy.
- The setting of the COPYCONTINUE parameter does not affect the simultaneous-write function during server import. If data is being written simultaneously and a write failure occurs to the primary storage pool or any copy storage pool, the server import process fails.
- The setting of the COPYCONTINUE parameter does not affect the simultaneous-write function during server data migration. If data is being written simultaneously and a write failure occurs to any copy storage pool or active-data pool, the failing storage pool is removed and the data migration process continues. Write failures to the primary storage pool cause the migration process to fail.

#### ACTIVEDATApools

Specifies the names of active-data pools where the server simultaneously writes data during a client backup operation. The ACTIVEDATAPOOLS parameter is optional. Spaces between the names of the active-data pools are not allowed.

The combined total number of storage pools that are specified in the COPYSSTGPOOLS and ACTIVEDATAPOOLS parameters cannot exceed three.

When a data storage operation switches from a primary storage pool to a next storage pool, the next storage pool inherits the list of active-data pools from the destination storage pool specified in the copy group. The primary storage pool is specified by the copy group of the management class that is bound to the data.

The server can write data simultaneously to active-data pools only during backup operations by IBM Spectrum Protect backup-archive clients or application clients that use the IBM Spectrum Protect API.

Restrictions:

1. This parameter is available only to primary storage pools that use NATIVE or NONBLOCK data format. This parameter is not available for storage pools that use the following data formats:
  - NETAPPDUMP
  - CELERRADUMP
  - NDMPDUMP
2. Writing data simultaneously to active-data pools is not supported when the operation is using LAN-free data movement. Simultaneous-write operations take precedence over LAN-free data movement, causing the operations to go over the LAN. However, the simultaneous-write configuration is accepted.
3. The simultaneous-write function is not supported when a NAS backup operation is writing a TOC file. If the primary storage pool specified in the TOCDESTINATION in the copy group of the management class has active-data pools defined, the active-data pools are ignored and the data is stored into the primary storage pool only.
4. You cannot use the simultaneous-write function with CENTERA storage devices.
5. Data being imported cannot be stored in active-data pools. After an import operation, use the COPY ACTIVEDATA command to store the imported data in an active-data pool.

Attention: The function that is provided by the `ACTIVEDATAPOOLS` parameter is not intended to replace the `COPY ACTIVE DATA` command. If you use the `ACTIVEDATAPOOLS` parameter, use the `COPY ACTIVE DATA` command to ensure that the active-data pools contain all active data of the primary storage pool.

#### DEDuplicate

Specifies whether the data that is stored in this storage pool is deduplicated. This parameter is optional and is valid only for storage pools that are defined with a `FILE` device class.

#### IDENTIFYProcess

Specifies the number of parallel processes to use for server-side data deduplication. This parameter is optional and is valid only for storage pools that are defined with a device class associated with the `FILE` device type. Enter a value 1 - 50. Remember: Data deduplication processes can be either active or idle. Processes that are working on files are active. Processes that are waiting for files to work on are idle. Processes remain idle until volumes with data to be deduplicated become available. The output of the `QUERY PROCESS` command for data deduplication includes the total number of bytes and files that have been processed since the process first started. For example, if a data deduplication process processes four files, becomes idle, and then processes five more files, then the total number of files processed is nine. Processes end only when canceled or when the number of data-deduplication processes for the storage pool is changed to a value less than the number currently specified.

## Example: Update the primary sequential storage pool's mountable scratch volumes

Update the primary sequential storage pool that is named `TAPEPOOL1` to allow as many as 10 scratch volumes to be mounted.

```
update stgpool tapepool1 maxscratch=10
```

## UPDATE STGPOOL (Update a copy sequential access storage pool)

Use this command to update a copy sequential access storage pool.

### Privilege class

To issue this command, you must have system privilege, unrestricted storage privilege, or restricted storage privilege for the storage pool to be updated.

### Syntax

```
>>-UPDate STGpool--pool_name--+-----+----->
                                     '-DESCRiption---description-'
>--+-----+----->
  '-ACCess---+READWrite---+'
      +-READOnly---+
      '-UNAVailable-'
>--+-----+-----+-----+----->
  '-COLlocate---+No-----+' '-REClaim---percent-'
      +-GRoup-----+
      +-NODE-----+
      '-Filespace-'
>--+-----+----->
  '-RECLAIMPRocess---number-'
>--+-----+----->
  '-OFFSITERECLAIMLimit---+NOLimit---+'
                                     '-number--'
>--+-----+-----+-----+----->
  '-MAXSCRatch---number-' '-REUsedelay---days-'
>--+-----+-----+-----+----->
  '-OVFLocation---location-' '-CRCDATA---+Yes-+-'
                                     '-No--'
>--+-----+-----+-----+----->
  '-DEDUPlicate---+No-----+'
      | (1) |
      '-Yes-----'
```

```
>-----+-----+-----<<
|                                     |
|                                     | (2) |
|-----+-----+-----|
'-IDENTIFYPRocess-----number-----'
```

#### Notes:

1. This parameter is valid only for storage pools that are defined with a FILE-type device class.
2. This parameter is only available if the value of the DEDUPLICATE parameter is YES.

## Parameters

---

### pool\_name (Required)

Specifies the name of the copy storage pool to be updated.

### DEscription

Specifies a description of the copy storage pool. This parameter is optional. The maximum length of the description is 255 characters. Enclose the description in quotation marks if it contains any blank characters. To remove an existing description, specify a null string ("").

### ACcess

Specifies how client nodes and server processes (such as reclamation) can access files in the copy storage pool. This parameter is optional. You can specify the following values:

#### READWrite

Specifies that files can be read from and written to the volumes in the copy storage pool.

#### READOnly

Specifies that client nodes can read only files that are stored on the volumes in the copy storage pool.

Server processes can move files within the volumes in the storage pool. The server can use files in the copy storage pool to restore files to primary storage pools. However, no new writes are allowed to volumes in the copy storage pool from volumes outside the storage pool. A storage pool cannot be backed up to the copy storage pool.

#### UNAVailable

Specifies that client nodes cannot access files that are stored on volumes in the copy storage pool.

Server processes can move files within the volumes in the storage pool. The server can use files in the copy storage pool to restore files to primary storage pools. However, no new writes are allowed to volumes in the copy storage pool from volumes outside the storage pool. A storage pool cannot be backed up to the copy storage pool.

### COLlocate

Specifies whether the server attempts to keep data, which is stored on as few volumes as possible, that belong to one of the following candidates:

- A single client node
- A group of file spaces
- A group of client nodes
- A client file space

This parameter is optional.

Collocation reduces the number of sequential access media mounts for restore, retrieve, and recall operations. However, collocation increases both the amount of server time that is needed to collocate files for storing and the number of volumes required.

You can specify one of the following options:

#### No

Specifies that collocation is disabled.

#### GRoup

Specifies that collocation is enabled at the group level for client nodes or file spaces. For collocation groups, the server attempts to put data for nodes or file spaces that belong to the same collocation group on as few volumes as possible.

If you specify COLLOCATE=GROUP but do not define any collocation groups, or if you do not add nodes or file spaces to a collocation group, data is collocated by node. Consider tape usage when you organize client nodes or file spaces into collocation groups.

For example, if a tape-based storage pool consists of data from nodes and you specify COLLOCATE=GROUP, the server completes the following actions:

- Collocates the data by group for grouped nodes. Whenever possible, the server collocates data that belongs to a group of nodes on a single tape or on as few tapes as possible. Data for a single node can also be spread across several tapes that are associated with a group.
- Collocates the data by node for ungrouped nodes. Whenever possible, the server stores the data for a single node on a single tape. All available tapes that already have data for the node are used before available space on any other tape is used.

If a tape-based storage pool consists of data from grouped file spaces and you specify COLLOCATE=GROUP, the server completes the following actions:

- Collocates by group, the data for grouped file spaces only. Whenever possible, the server collocates data that belongs to a group of file spaces on a single tape or on as few tapes as possible. Data for a single file space can also be spread across several tapes that are associated with a group.
- Collocates the data by node (for file spaces that are not explicitly defined to a file space collocation group). For example, node1 has file spaces named A, B, C, D, and E. File spaces A and B belong to a file space collocation group but C, D, and E do not. File spaces A and B are collocated by file space collocation group, while C, D, and E are collocated by node.

Data is collocated on the least amount of sequential access volumes.

#### NODE

Specifies that collocation is enabled at the client node level. For collocation groups, the server attempts to put data for one node on as few volumes as possible. If the node has multiple file spaces, the server does not try to collocate those file spaces. For compatibility with an earlier version, COLLOCATE=YES is still accepted by the server to specify collocation at the client node level.

If a storage pool contains data for a node that is a member of a collocation group and you specify COLLOCATE=NODE, the data is collocated by node.

#### FILESPACE

Specifies that collocation is enabled at the file space level for client nodes. The server attempts to place data for one node and file space on as few volumes as possible. If a node has multiple file spaces, the server attempts to place data for different file spaces on different volumes.

#### RECLAIM

Specifies when the server reclaims a volume, which is based on the percentage of reclaimable space on a volume. Reclaimable space is the amount of space that is occupied by files that are expired or deleted from the IBM Spectrum Protect™ database.

Reclamation makes the fragmented space on volumes usable again by moving any remaining active files from one volume to another volume, thus making the original volume available for reuse. This parameter is optional. You can specify an integer 1 - 100. The value 100 means that reclamation is not completed.

The server determines that the volume is a candidate for reclamation if the percentage of reclaimable space on a volume is greater than the reclamation threshold of the storage pool.

If you change the value from the default of 100, specify a value of 50 percent or greater so that files stored on two volumes can be combined onto a single output volume.

When a copy pool volume that is offsite becomes eligible for reclamation, the reclamation process attempts to obtain the active files on the reclaimable volume from a primary or copy storage pool that is onsite. The process then writes these files to an available volume in the original copy storage pool. Effectively, these files are moved back to the onsite location. However, the files can be obtained from the offsite volume after a disaster if a database backup is used that references the files on the offsite volume. Because of the way reclamation works with offsite volumes, use it carefully with copy storage pools.

#### RECLAIMPROCESS

Specifies the number of parallel processes to use for reclaiming the volumes in this storage pool. This parameter is optional. Enter a value 1 - 999.

When you calculate the value for this parameter, consider the following resources that are required for reclamation processing:

- The number of sequential storage pools.
- The number of logical and physical drives that can be dedicated to the operation.

To access sequential volumes, IBM Spectrum Protect uses a mount point and, if the device type is not FILE, a physical drive.

For example, suppose that you want to reclaim the volumes from two sequential storage pools simultaneously and that you want to specify four processes for each of the storage pools. The storage pools have the same device class. Each process requires two mount points and, if the device type is not FILE, two drives. (One of the drives is for the input volume, and the other drive is for the output volume.) To run eight reclamation processes simultaneously, you need a total of at least 16 mount points and 16 drives. The device class for each storage pool must have a mount limit of at least eight.

You can specify one or more reclamation processes for each copy storage pool. You can specify multiple concurrent reclamation processes for a single copy storage pool, which makes better use of your available tape drives or FILE volumes. If multiple concurrent processing is not necessary, specify a value of 1 for the RECLAIMPROCESS parameter.

#### OFFSITERECLAIMLimit

Specifies the number of offsite volumes that space is reclaimed from during reclamation for this storage pool. This parameter is optional. You can specify the following values:

##### NOLimit

Specifies that you want to reclaim the space in all of your offsite volumes.

##### number

Specifies the number of offsite volumes to reclaim space from. You can specify an integer 0 - 99999. A value of zero means that none of the offsite volumes are reclaimed.

##### Tip:

To determine the value for the OFFSITERECLAIMLIMIT, use the statistical information in the message that is issued at the end of the offsite volume reclamation operation. The statistical information includes the following items:

- The number of offsite volumes that were processed
- The number of parallel processes that were used
- The total amount of time required for the processing

The order in which offsite volumes are reclaimed is based on the amount of unused space in a volume. (Unused space includes both space that has never been used on the volume and space that has become empty because of file deletion.) Volumes with the largest amount of unused space are reclaimed first.

For example, suppose a copy storage pool contains three volumes: VOL1, VOL2, and VOL3. VOL1 has the largest amount of unused space, and VOL3 has the least amount of unused space. Suppose further that the percentage of unused space in each of the three volumes is greater than the value of the RECLAIM parameter. If you do not specify a value for the OFFSITERECLAIMLIMIT parameter, all three volumes will be reclaimed when the reclamation runs. If you specify a value of 2, only VOL1 and VOL2 will be reclaimed when the reclamation runs. If you specify a value of 1, only VOL1 will be reclaimed.

#### MAXSCRatch

Specifies the maximum number of scratch volumes that the server can request for this storage pool. This parameter is optional. You can specify an integer 0 - 100000000. By allowing the server to request scratch volumes as needed, you avoid having to define each volume to be used.

The value that is specified for this parameter is used to estimate the total number of volumes available in the copy storage pool and the corresponding estimated capacity for the copy storage pool.

Scratch volumes are automatically deleted from the storage pool when they become empty. However, if the access mode for a scratch volume is OFFSITE, the volume is not deleted from the copy storage pool until the access mode is changed. An administrator can query the server for empty, offsite scratch volumes and return them to the onsite location.

When scratch volumes with the device type of FILE become empty and are deleted, the space that the volumes occupied is freed by the server and returned to the file system.

Tip: For server-to-server operations that use virtual volumes and that store a small amount of data, consider specifying a value for the MAXSCRATCH parameter that is higher than the value you typically specify for write operations to other types of volumes. After a write operation to a virtual volume, IBM Spectrum Protect marks the volume as FULL, even if the value of the MAXCAPACITY parameter on the device-class definition is not reached. The IBM Spectrum Protect server does not



keep virtual volumes in FILLING status and does not append to them. If the value of the MAXSCRATCH parameter is too low, server-to-server operations can fail.

#### REUsedelay

Specifies the number of days that must elapse after all files are deleted from a volume before the volume can be rewritten or returned to the scratch pool. This parameter is optional. You can specify an integer 0 - 9999. A value of 0 means that a volume can be rewritten or returned to the scratch pool as soon as all files are deleted from the volume.

Tip: Use this parameter to ensure that when you restore the database to an earlier level, database references to files in the copy storage pool are still valid. You must set this parameter to a value greater than the number of days you plan to retain the oldest database backup. The number of days that are specified for this parameter must be the same as the number specified for the SET DRMDBBACKUPEXPIREDAYS command.

#### OVFLocation

Specifies the overflow location for the storage pool. The server assigns this location name to a volume that is ejected from the library by the MOVE MEDIA command. This parameter is optional. The location name can be a maximum length of 255 characters. Enclose the location name in quotation marks if the location name contains any blank characters.

To remove an existing value, specify a null string ("").

#### CRCDATA

Specifies whether a cyclic redundancy check (CRC) validates storage pool data when audit volume processing occurs on the server. This parameter is only valid for NATIVE data format storage pools. This parameter is optional. The default value is NO. By setting CRCDATA to YES and scheduling an AUDIT VOLUME command, you can continually ensure the integrity of data that is stored in your storage hierarchy. You can specify the following values:

##### Yes

Specifies that data is stored containing CRC information, allowing for audit volume processing to validate storage pool data. This mode impacts performance because more processing is required to calculate and compare CRC values between the storage pool and the server.

##### No

Specifies that data is stored without CRC information.

##### Tip:

For storage pools that are associated with the 3592, LTO, or ECARTRIDGE device type, logical block protection provides better protection against data corruption than CRC validation for a storage pool. If you specify CRC validation for a storage pool, data is validated only during volume auditing operations. Errors are identified after data is written to tape.

To enable logical block protection, specify a value of READWRITE for the LBPROTECT parameter on the DEFINE DEVCLASS and UPDATE DEVCLASS commands for the 3592, LTO, or ECARTRIDGE device types. Logical block protection is supported only on the following types of drives and media:

- IBM® LTO5 and later.
- IBM 3592 Generation 3 drives and later with 3592 Generation 2 media and later.
- Oracle StorageTek T10000C and T10000D drives.

#### DEDuplicate

Specifies whether the data that is stored in this storage pool is deduplicated. This parameter is optional and is valid only for storage pools that are defined with a FILE-type device class.

#### IDENTIFYProcess

Specifies the number of parallel processes to use for server-side data deduplication. This parameter is optional and is valid only for storage pools that are defined with a FILE device class. Enter a value 1 - 50.

Remember: Data deduplication processes can be either active or idle. Processes that are working on files are active.

Processes that are waiting for files to work on are idle. Processes remain idle until volumes with data to be deduplicated become available. The output of the QUERY PROCESS command for data deduplication includes the total number of bytes and files that have been processed since the process first started. For example, if a data deduplication process processes four files, becomes idle, and then processes five more files, then the total number of files processed is nine. Processes end only when canceled or when the number of data-deduplication processes for the storage pool is changed to a value less than the number currently specified.

## Example: Update a copy storage pool to a 30-day volume reuse and to collocate files by client node

---

Update the copy storage pool that is named TAPEPOOL2 to change the delay for volume reuse to 30 days and to collocate files by client node.

```
update stgpool tapepool2 reusedelay=30 collocate=node
```

**Related reference:**

SET DRMDBBACKUPEXPIREDDAYS (Specify DB backup series expiration)

## UPDATE STGPOOL (Update an active-data sequential access)

---

Use this command to update an active-data pool.

### Privilege class

---

To issue this command, you must have system privilege, unrestricted storage privilege, or restricted storage privilege for the storage pool to be updated.

### Syntax

---

```
>>-UPDate STGpool--pool_name--+-+-----+-----+-----+----->
                                     '-DESCRiption-----description-'
>--+-----+-----+-----+----->
  '-ACCess---+READWrite---+'
      +-READOnly---+
      '-UNAVailable-'
>--+-----+-----+-----+----->
  '-COLlocate---+No-----+'  '-REClaim---percent-'
      +-GRoup-----+
      +-NODE-----+
      '-Filespace-'
>--+-----+-----+-----+----->
  '-RECLAIMPRocess---number-'
>--+-----+-----+-----+----->
  '-OFFSITERECLAIMLimit---+NOLimit-+-'
                                     '-number--'
>--+-----+-----+-----+----->
  '-MAXSCRatch---number-'  '-REUsedelay---days-'
>--+-----+-----+-----+----->
  '-OVFLocation---location-'  '-CRCDATA---+Yes-+-'
                                     '-No--'
>--+-----+-----+-----+----->
  '-DEDUPlicate---+No-----+'
      |          (1) |
      '-Yes-----'
>--+-----+-----+-----+-----><
  |          (2) |
  '-IDENTIFYPRocess---number-----'
```

**Notes:**

1. This parameter is valid only for storage pools that are defined with a FILE-type device class.
2. This parameter is only available if the value of the DEDUPLICATE parameter is YES.

### Parameters

---

pool\_name (Required)

Specifies the name of the active-data pool to be updated.

DESCRIPTION

Specifies a description of the active-data pool. This parameter is optional. The maximum length of the description is 255 characters. Enclose the description in quotation marks if it contains any blank characters. To remove an existing description, specify a null string ("").

## ACCess

Specifies how client nodes and server processes (such as reclamation) can access files in the active-data pool. This parameter is optional. You can specify the following values:

### READWrite

Specifies that files can be read from and written to the volumes in the active-data pool.

### READOnly

Specifies that client nodes can read only files that are stored on the volumes in the active-data pool.

Server processes can move files within the volumes in the storage pool. The server can use files in the active-data pool to restore active versions of backup files to primary storage pools. However, no new writes are allowed to volumes in the active-data pool from volumes outside the storage pool. A storage pool cannot be copied to the active-data pool.

### UNAVailable

Specifies that client nodes cannot access files that are stored on volumes in the active-data pool.

Server processes can move files within the volumes in the storage pool. The server can use files in the active-data pool to restore active versions of backup files to primary storage pools. However, no new writes are allowed to volumes in the active-data pool from volumes outside the storage pool. A storage pool cannot be copied to the active-data pool.

## COLlocate

Specifies whether the server attempts to keep data, which is stored on as few volumes as possible, that belong to one of the following candidates:

- A single client node
- A group of file spaces
- A group of client nodes
- A client file space

This parameter is optional.

Collocation reduces the number of sequential access media mounts for restore, retrieve, and recall operations. However, collocation increases both the amount of server time that is needed to collocate files for storing and the number of volumes required.

You can specify one of the following options:

### No

Specifies that collocation is disabled.

### GRoup

Specifies that collocation is enabled at the group level for client nodes or file spaces. For collocation groups, the server attempts to put data for nodes or file spaces that belong to the same collocation group on as few volumes as possible.

If you specify COLLOCATE=GROUP but do not define any collocation groups, or if you do not add nodes or file spaces to a collocation group, data is collocated by node. Consider tape usage when you organize client nodes or file spaces into collocation groups.

For example, if a tape-based storage pool consists of data from nodes and you specify COLLOCATE=GROUP, the server completes the following actions:

- Collocates the data by group for grouped nodes. Whenever possible, the server collocates data that belongs to a group of nodes on a single tape or on as few tapes as possible. Data for a single node can also be spread across several tapes that are associated with a group.
- Collocates the data by node for ungrouped nodes. Whenever possible, the server stores the data for a single node on a single tape. All available tapes that already have data for the node are used before available space on any other tape is used.

If a tape-based storage pool consists of data from grouped file spaces and you specify COLLOCATE=GROUP, the server completes the following actions:

- Collocates by group, the data for grouped file spaces only. Whenever possible, the server collocates data that belongs to a group of file spaces on a single tape or on as few tapes as possible. Data for a single file space can also be spread across several tapes that are associated with a group.

- Collocates the data by node (for file spaces that are not explicitly defined to a file space collocation group). For example, node1 has file spaces named A, B, C, D, and E. File spaces A and B belong to a filespace collocation group but C, D, and E do not. File spaces A and B are collocated by filespace collocation group, while C, D, and E are collocated by node.

Data is collocated on the least amount of sequential access volumes.

#### NODE

Specifies that collocation is enabled at the client node level. For collocation groups, the server attempts to put data for one node on as few volumes as possible. If the node has multiple file spaces, the server does not try to collocate those file spaces. For compatibility with an earlier version, COLLOCATE=YES is still accepted by the server to specify collocation at the client node level.

If a storage pool contains data for a node that is a member of a collocation group and you specify COLLOCATE=NODE, the data is collocated by node.

#### FILESPACE

Specifies that collocation is enabled at the file space level for client nodes. The server attempts to place data for one node and file space on as few volumes as possible. If a node has multiple file spaces, the server attempts to place data for different file spaces on different volumes.

#### RECLAIM

Specifies when the server reclaims a volume, which is based on the percentage of reclaimable space on a volume. Reclaimable space is the amount of space that is occupied by files that are expired or deleted from the IBM Spectrum Protect™ database.

Reclamation makes the fragmented space and space occupied by inactive backup files on volumes usable again by moving any remaining unexpired files and active backup files from one volume to another volume. This action makes the original volume available for reuse. This parameter is optional. You can specify an integer 1 - 100. The value 100 means that reclamation is not completed.

The server determines that the volume is a candidate for reclamation if the percentage of reclaimable space on a volume is greater than the reclamation threshold of the storage pool.

If you change the value from the default of 60, specify a value of 50 percent or greater so that files stored on two volumes can be combined onto a single output volume.

When an active-data pool volume that is offsite becomes eligible for reclamation, the reclamation process attempts to obtain the active files on the reclaimable volume from a primary or active-data pool that is onsite. The process then writes these files to an available volume in the original active-data pool. Effectively, these files are moved back to the onsite location. However, the files can be obtained from the offsite volume after a disaster if a database backup is used that references the files on the offsite volume. Because of the way reclamation works with offsite volumes, use it carefully with active-data pools.

#### RECLAIMPROCESS

Specifies the number of parallel processes to use for reclaiming the volumes in this storage pool. This parameter is optional. Enter a value 1 - 999.

When you calculate the value for this parameter, consider the following resources that are required for reclamation processing:

- The number of sequential storage pools.
- The number of logical and physical drives that can be dedicated to the operation.

To access sequential volumes, IBM Spectrum Protect uses a mount point and, if the device type is not FILE, a physical drive.

For example, suppose that you want to reclaim the volumes from two sequential storage pools simultaneously and that you want to specify four processes for each of the storage pools. The storage pools have the same device class. Each process requires two mount points and, if the device type is not FILE, two drives. (One of the drives is for the input volume, and the other drive is for the output volume.) To run eight reclamation processes simultaneously, you need a total of at least 16 mount points and 16 drives. The device class for each storage pool must have a mount limit of at least eight.

You can specify one or more reclamation processes for each active-data pool. You can specify multiple concurrent reclamation processes for a single active-data pool, which makes better use of your available tape drives or FILE volumes. If multiple concurrent processing is not necessary, specify a value of 1 for the RECLAIMPROCESS parameter.

#### OFFSITERECLAIMLimit

Specifies the number of offsite volumes that space is reclaimed from during reclamation for this storage pool. This parameter is optional. You can specify the following values:

#### NOLimit

Specifies that you want to reclaim the space in all of your offsite volumes.

#### number

Specifies the number of offsite volumes to reclaim space from. You can specify an integer 0 - 99999. A value of zero means that none of the offsite volumes are reclaimed.

Tip:

To determine the value for the OFFSITERECLAIMLIMIT, use the statistical information in the message that is issued at the end of the offsite volume reclamation operation. The statistical information includes the following items:

- The number of offsite volumes that were processed
- The number of parallel processes that were used
- The total amount of time required for the processing

The order in which offsite volumes are reclaimed is based on the amount of unused space in a volume. (Unused space includes both space that has never been used on the volume and space that has become empty because of file deletion.) Volumes with the largest amount of unused space are reclaimed first.

For example, suppose an active-data pool contains three volumes: VOL1, VOL2, and VOL3. VOL1 has the largest amount of unused space, and VOL3 has the least amount of unused space. Suppose further that the percentage of unused space in each of the three volumes is greater than the value of the RECLAIM parameter. If you do not specify a value for the OFFSITERECLAIMLIMIT parameter, all three volumes are reclaimed when the reclamation runs. If you specify a value of 2, only VOL1 and VOL2 are reclaimed when the reclamation runs. If you specify a value of 1, only VOL1 is reclaimed.

#### MAXSCRatch

Specifies the maximum number of scratch volumes that the server can request for this storage pool. This parameter is optional. You can specify an integer 0 - 100000000. By allowing the server to request scratch volumes as needed, you avoid having to define each volume to be used.

The value that is specified for this parameter is used to estimate the total number of volumes available in the active-data pool and the corresponding estimated capacity for the active-data pool.

Scratch volumes are automatically deleted from the storage pool when they become empty. However, if the access mode for a scratch volume is OFFSITE, the volume is not deleted from the active-data pool until the access mode is changed. An administrator can query the server for empty, offsite scratch volumes and return them to the onsite location.

When scratch volumes with the device type of FILE become empty and are deleted, the space that the volumes occupied is freed by the server and returned to the file system.

Tip: For server-to-server operations that use virtual volumes and that store a small amount of data, consider specifying a value for the MAXSCRATCH parameter that is higher than the value you typically specify for write operations to other types of volumes. After a write operation to a virtual volume, IBM Spectrum Protect marks the volume as FULL, even if the value of the MAXCAPACITY parameter on the device-class definition is not reached. The IBM Spectrum Protect server does not keep virtual volumes in FILLING status and does not append to them. If the value of the MAXSCRATCH parameter is too low, server-to-server operations can fail.

#### REUsedelay

Specifies the number of days that must elapse after all files are deleted from a volume before the volume can be rewritten or returned to the scratch pool. This parameter is optional. You can specify an integer 0 - 9999. A value of 0 means that a volume can be rewritten or returned to the scratch pool as soon as all files are deleted from the volume.

Tip: Use this parameter to ensure that when you restore the database to an earlier level, database references to files in the active-data pool are still valid. You must set this parameter to a value greater than the number of days you plan to retain the oldest database backup. The number of days that are specified for this parameter must be the same as the number specified for the SET DRMDBBACKUPEXPIREDAYS command.

#### OVFLocation

Specifies the overflow location for the storage pool. The server assigns this location name to a volume that is ejected from the library by the MOVE MEDIA command. This parameter is optional. The location name can be a maximum length of 255 characters. Enclose the location name in quotation marks if the location name contains any blank characters.

To remove an existing value, specify a null string ("").

#### CRCData

Specifies whether a cyclic redundancy check (CRC) validates storage pool data when audit volume processing occurs on the server. This parameter is only valid for NATIVE data format storage pools. This parameter is optional. The default value is NO. By setting CRCDATA to YES and scheduling an AUDIT VOLUME command, you can continually ensure the integrity of data that is stored in your storage hierarchy. You can specify the following values:

Yes

Specifies that data is stored containing CRC information, allowing for audit volume processing to validate storage pool data. This mode impacts performance because more processing is required to calculate and compare CRC values between the storage pool and the server.

No

Specifies that data is stored without CRC information.

Tip:

For storage pools that are associated with the 3592, LTO, or ECARTRIDGE device type, logical block protection provides better protection against data corruption than CRC validation for a storage pool. If you specify CRC validation for a storage pool, data is validated only during volume auditing operations. Errors are identified after data is written to tape.

To enable logical block protection, specify a value of READWRITE for the LBPROTECT parameter on the DEFINE DEVCLASS and UPDATE DEVCLASS commands for the 3592, LTO, or ECARTRIDGE device types. Logical block protection is supported only on the following types of drives and media:

- IBM® LTO5 and later.
- IBM 3592 Generation 3 drives and later with 3592 Generation 2 media and later.
- Oracle StorageTek T10000C and T10000D drives.

DEDuplicate

Specifies whether the data that is stored in this storage pool is deduplicated. This parameter is optional and is valid only for storage pools that are defined with a FILE-type device class.

IDENTIFYProcess

Specifies the number of parallel processes to use for server-side data deduplication. This parameter is optional and is valid only for storage pools that are defined with a FILE device class. Enter a value 1 - 50.

Remember: Data deduplication processes can be either active or idle. Processes that are working on files are active.

Processes that are waiting for files to work on are idle. Processes remain idle until volumes with data to be deduplicated become available. The output of the QUERY PROCESS command for data deduplication includes the total number of bytes and files that have been processed since the process first started. For example, if a data deduplication process processes four files, becomes idle, and then processes five more files, then the total number of files processed is nine. Processes end only when canceled or when the number of data-deduplication processes for the storage pool is changed to a value less than the number currently specified.

## Example: Update an active data pool

---

Update the active-data pool that is named TAPEPOOL2 to change the delay for volume reuse to 30 days and to collocate files by client node.

```
update stgpool tapepool3 reusedelay=30 collocate=node
```

**Related reference:**

SET DRMDBBACKUPEXPIREDAYS (Specify DB backup series expiration)

AIX | Linux | Windows

## UPDATE STGPOOLDIRECTORY (Update a storage pool directory)

---

Use this command to update a storage pool directory.

### Privilege class

---

To issue this command, you must have system privilege, unrestricted storage privilege, or restricted storage privilege.

### Syntax

---

```
>>-UPDate STGPOOLDIRectory--pool_name--directory----->
```

```

      .-MAXPRocess-----4-----.
>---ACCess---+---READWrite---+-----+-----+----->
      +-READOnly-----+   '-MAXProcess-----number-'
      +-DEStroyed-----+
      '-UNAVailable-'

.-Wait-----No-----.
>---+-----+-----+-----><
      '-Wait-----+No---+'
      '-Yes-'

```

## Parameters

---

### pool\_name (Required)

Specifies the storage pool that contains the directory to update. This parameter is required.

### directory (Required)

Specifies a file system directory of the storage pool. This parameter is required.

### ACCess (Required)

Specifies how client nodes and server processes can access files in the storage pool directory. This parameter is required. The following values are possible:

#### READWrite

Specifies that files can be read from and written to the storage pool directory.

#### READOnly

Specifies that files can be read from the storage pool directory.

#### DEStroyed

Specifies that files are permanently damaged and must be destroyed in the storage pool directory. Use this access mode to indicate that an entire storage pool directory must be recovered.

#### Tips:

- Mark storage pool directories as `DESTROYED` before you complete data recovery. When the storage pool directory is marked as destroyed, you can recover data extents on the target replication server.
- Use the `MAXPROCESS` parameter to specify the number of parallel processes that you can use to update a storage pool directory.

#### UNAVailable

Specifies that files cannot be accessed on the storage pool directory in the storage pool.

### MAXPRocess

Specifies the maximum number of parallel processes to use for updating a storage pool directory. This parameter is optional. You can enter a value in the range 1 - 99. The default value is 4.

Restriction: You can use this parameter only when you specify the `ACCESS=DESTROYED` parameter.

When you specify the `ACCESS=DESTROYED` parameter, each container in the storage pool directory is updated by one process. If the maximum number of parallel processes is larger than or equal to the number of containers that must be updated, only one process is created for each container. If the number of containers exceeds the value of the `MAXPROCESS` parameter, the command waits for the child processes to finish before any new processes can begin.

### Wait

This optional parameter specifies whether to wait for the IBM Spectrum Protect™ server to complete processing this command in the foreground. The default is `NO`. You can specify the following values:

#### No

The server processes this command in the background and you can continue with other tasks while the command is processing. Messages that are related to the background process are shown either in the activity log file or the server console, depending on where the messages are logged.

#### Yes

The server processes this command in the foreground. The operation must complete processing before you can continue with other tasks. Messages are shown either in the activity log file or the server console, or both, depending on where the messages are logged.

Restriction: You cannot specify `WAIT=YES` from the server console.

## Example: Update a storage pool directory to destroy it

---

Update a storage pool directory that is named DIR1 in storage pool POOL1 to mark it as destroyed.

```
update stgpooldirectory pool1 dir1 access=destroyed
```

## Example: Update a storage pool directory to destroy it in a cloud-container storage pool

Update a storage pool directory that is named DIR3 in cloud-container storage pool CLOUDLOCALDISK1 to mark it as destroyed.

```
update stgpooldirectory cloudlocaldisk1 dir3 access=destroyed
```

## Example: Update a storage pool directory to make it unavailable

When the storage pool directory is unavailable, the server does not read or write data to the directory. To update the access mode to unavailable for a storage pool directory, `dir1`, in a storage pool that is named `pool1`, issue the following command:

```
update stgpooldirectory pool1 dir1 access=unavailable
```

Table 1. Commands related to UPDATE STGPOOLDIRECTORY

Command	Description
DEFINE STGPOOL	Defines a storage pool as a named collection of server storage media.
DEFINE STGPOOLDIRECTORY	Defines a storage pool directory to a directory-container or cloud-container storage pool.
DELETE STGPOOLDIRECTORY	Deletes a storage pool directory from a directory-container or cloud-container storage pool.
QUERY STGPOOLDIRECTORY	Displays information about storage pool directories.

## UPDATE VIRTUALFSMAPPING (Update a virtual file space mapping)

Use this command to update a virtual file space mapping definition.

Restriction: You cannot use the UPDATE VIRTUALFSMAPPING command to update a virtual file space mapping for an EMC Celerra or EMC VNX NAS device. You must use the DEFINE VIRTUALFSMAPPING command.

The NAS device needs an associated data mover definition because when the server updates a virtual file space mapping, the server contacts the NAS device to validate the virtual file system and file system name.

### Privilege class

To issue this command, you must have one of the following privilege classes:

- System privilege
- Unrestricted policy privilege
- Restricted policy privilege for the domain to which the NAS node is assigned

### Syntax

```
>>-UPDate VIRTUALFSMapping--node_name--virtual_filespace_name--->
>>+-----+----->
  '-FILESystem----new_file_system_name-'
>>+-----+-----><
  |                                     .-NAMEType-----SERVER-----|
  '-PATH----new_path_name--+-----+-----+-'
                                     '-NAMEType-----+SERVER-----+-'
                                     '-HEXadecimal-'
```

### Parameters



node\_name (Required)

Specifies the NAS node on which the file system and path reside. You cannot use wildcard characters or specify a list of names.

virtual\_filespace\_name (Required)

Specifies the virtual file space mapping to update. You cannot use wildcard characters or specify a list of names.

FILESystem

Specifies the new name of the file system in which the path is located. The file system name must exist on the specified NAS node. The file system name cannot contain wildcard characters. The file system name should only be modified when the file system name is modified on the NAS device or, for example, the directory is moved to a different file system. This parameter is optional.

PATH

Specifies the new path from the root of the file system to the directory. The path can only reference a directory. This should only be modified when the path on the NAS device has changed; for example, the directory is moved to a different path. The maximum length of the path is 1024 characters. The path name is case sensitive. This parameter is optional.

NAMEType

Specifies how the server should interpret the path name specified. Specify this parameter only if you specify a path. This parameter is useful when a path contains characters that are not part of the code page on which the server is running. The default value is SERVER.

Possible values are:

SERVER

The code page in which the server is running is used to interpret the path.

HEXadecimal

The server interprets the path that you enter as the hexadecimal representation of the path. This option should be used when a path contains characters that cannot be entered. For example, this could occur if the NAS file system is set to a language different from the one in which the server is running.

## Example: Modify the path of a virtual file space mapping

---

Update the virtual file space mapping named /mikeshomedir for the NAS node NAS1 by modifying the path.

```
update virtualfsmapping nas1 /mikeshomedir path=/new/home/mike
```

## Related commands

---

Table 1. Commands related to UPDATE VIRTUALFSMAPPING

Command	Description
DEFINE VIRTUALFSMAPPING	Define a virtual file space mapping.
DELETE VIRTUALFSMAPPING	Delete a virtual file space mapping.
QUERY VIRTUALFSMAPPING	Query a virtual file space mapping.

## UPDATE VOLHISTORY (Update sequential volume history information)

---

Use this command to update volume history information for a volume produced by a database backup or an export operation. This command does not apply to storage pool volumes.

Use the UPDATE BACKUPSET command to update specified backup set volume information in the volume history file. Do not use this UPDATE VOLHISTORY command to update backup set volume information in the volume history file.

## Privilege class

---

You must have system privilege or unrestricted storage privilege to issue this command.

## Syntax

```
>>-UPDate VOLHistory--volume_name----->
>>-DEVclass----device_class_name--+-----+----->
                                '-LLocation----location-'
>+-----+-----><
  '-ORMStAte--++MOUNTable-----+'
                    +-NOTMOUNTable----+
                    +-COUrier-----+
                    +-VAult-----+
                    '-COURIERRetrieve-'
```

## Parameters

volume\_name (Required)

Specifies the volume name. The volume must have been used for a database backup or an export operation.

DEVclass (Required)

Specifies the name of the device class for the volume.

LOcation

Specifies the volume location. This parameter is required if the ORMSTATE parameter is not specified. The maximum text length is 255 characters. Enclose the text in quotation marks if it contains any blank characters.

Tip: The UPDATE VOLHISTORY command supports updates to the location information and ORMSTATE for snapshot database backup volumes.

ORMStAte

Specifies a change to the state of a database backup volume. This parameter is required if the LOCATION parameter is not specified. This parameter is only supported for systems licensed with Disaster Recovery Manager. Possible states are:

MOUNTable

The volume contains valid data and is accessible for on-site processing.

NOTMOUNTable

The volume is on-site, contains valid data, and is not accessible for on-site processing.

COUrier

The volume is being moved off-site.

VAult

The volume is off-site, contains valid data, and is not accessible for on-site processing.

COURIERRetrieve

The volume is being moved on-site.

## Example: Update the location of a volume used for database backup

Update the location of a volume used for database backup, BACKUP1, to show that it has been moved to an off-site location.

```
update volhistory backup1 devclass=tapebkup
location="700 w. magee rd."
```

## Related commands

Table 1. Commands related to UPDATE VOLHISTORY

Command	Description
BACKUP VOLHISTORY	Records volume history information in external files.
DELETE VOLHISTORY	Removes sequential volume history information from the volume history file.
MOVE DRMEDIA	Moves DRM media onsite and offsite.
PREPARE	Creates a recovery plan file.
QUERY DRMEDIA	Displays information about disaster recovery volumes.
QUERY VOLHISTORY	Displays sequential volume history information that has been collected by the server.

## UPDATE VOLUME (Change a storage pool volume)

Use this command to change the access mode for one or more volumes in storage pools.

You can correct an error condition associated with a volume by updating the volume to an access mode of READWRITE. You can also use this command to change the location information for one or more volumes in sequential access storage pools.

### Privilege class

To issue this command, you must have system privilege or operator privilege.

### Syntax

```
(1)
>>-UPDate Volume-----volume_name----->
>--+-----+-----+-----+----->
  '-ACcEss---+---+READWrite-----+-'
      +---+READOnly-----+
      +---+UNAVailable---+
      |           (2) |
      +---+DEStroyed-----+
      |           (3) |
      '-OFFsite-----'
>--+-----+-----+-----+----->
  |           (4) |
  '-LOcAtion-----location-'
  .-WHERESTGpool---*-----
>--+-----+-----+-----+----->
  '-WHERESTGpool---pool_name-'
  .-WHEREDEVclass---*-----
>--+-----+-----+-----+----->
  '-WHEREDEVclass---device_class_name-'
>--+-----+-----+-----+----->
  |           .-,'-----' |
  |           V           | |
  '-WHEREACcEss-----+---+READWrite---+---+'
      +---+READOnly-----+
      +---+UNAVailable---+
      +---+OFFsite-----+
      '-DEStroyed---'
>--+-----+-----+-----+----->
  |           .-,'-----' |
  |           V           | |
  '-WHEREStAtus-----+---+ONline---+---+'
      +---+OFFline---+
      +---+EMPTy---+
      +---+PENding---+
      +---+FILLing---+
      '-FULL----'
  .-Preview---No-----
>--+-----+-----+-----+----->>
  '-PREview---+---+No---+'
      '-Yes-'
```

#### Notes:

1. You must update at least one attribute (ACCESS or LOCATION).
2. This value is valid only for volumes in primary storage pools.
3. This value is valid only for volumes in copy storage pools.
4. This parameter is valid only for volumes in sequential access storage pools.

## Parameters

---

### volume\_name (Required)

Specifies the storage pool volume to update. You can use wildcard characters to specify names.

### ACCess

Specifies how client nodes and server processes (such as migration) can access files in the storage pool volume. This parameter is optional. Possible values are:

#### READWrite

Specifies that client nodes and server processes can read from and write to files stored on the volume.

If the volume being updated is an empty scratch volume that had an access mode of offsite, the server deletes the volume from the database.

#### READOnly

Specifies that client nodes and server processes can only read files stored on the volume.

If the volume being updated is an empty scratch volume that had an access mode of offsite, the server deletes the volume from the database.

#### UNAVailable

Specifies that neither client nodes nor server processes can access files stored on the volume.

Before making a random access volume unavailable, you must vary the volume offline. After you make a random access volume unavailable, you cannot vary the volume online.

If you make a sequential access volume unavailable, the server does not attempt to mount the volume.

If the volume being updated is an empty scratch volume that had an access mode of offsite, the server deletes the volume from the database.

#### DESTroyed

Specifies that a primary storage pool volume has been permanently damaged. Neither client nodes nor server processes can access files stored on the volume. Use this access mode to indicate an entire volume that needs to be restored by using the RESTORE STGPOOL command. After all files on a destroyed volume have been restored to other volumes, the server automatically deletes the destroyed volume from the database.

Only volumes in primary storage pools can be updated to DESTROYED.

Before updating a random access volume to DESTROYED access, you must vary the volume offline. After you update a random access volume to DESTROYED, you cannot vary the volume online.

If you update a sequential access volume to DESTROYED, the server does not attempt to mount the volume.

If a volume contains no files and you change the access mode to DESTROYED, the server deletes the volume from the database.

#### OFFsite

Specifies that a copy or active-data storage pool volume is at an offsite location from which it cannot be mounted. Only volumes in copy or active-data storage pools can have the access mode of OFFSITE.

If you specify values for both the ACCESS and LOCATION parameters but the access mode cannot be updated for a particular volume, the location attribute is also not updated for that volume. For example, if you specify ACCESS=OFFSITE and a LOCATION value for a primary storage pool volume, neither the access nor location values are updated because a primary storage pool volume cannot be given an access mode of OFFSITE.

### LOCation

Specifies the location of the volume. This parameter is optional. It can be specified only for volumes in sequential access storage pools. The maximum length of the location is 255 characters. Enclose the location in quotation marks if it contains any blank characters. To remove a previously defined location, specify the null string ("").

### WHERESTGpool

Specifies the name of the storage pool for volumes to be updated. Use this parameter to restrict the update by storage pool. This parameter is optional. You can use wildcard characters to specify names. If you do not specify a storage pool name, volumes belonging to any storage pool are updated.

### WHEREDEVclass

Specifies the name of the device class for volumes to be updated. Use this parameter to restrict the update by device class. This parameter is optional. You can use wildcard characters to specify names. If you do not specify a device class name, volumes with any device class are updated.

#### WHEREACcESS

Specifies the current access mode of volumes to be updated. Use this parameter to restrict the update to volumes that currently have the specified access mode. This parameter is optional. You can specify multiple access modes by separating the modes with commas and no intervening spaces. If you do not specify a value for this parameter, the update is not restricted by the current access mode of a volume. Possible values are:

##### READWrite

Update volumes with an access mode of READWRITE.

##### READOnly

Update volumes with an access mode of READONLY.

##### UNAVailable

Update volumes with an access mode of UNAVAILABLE.

##### OFFsite

Update volumes with an access mode of OFFSITE.

##### DESTROYed

Update volumes with an access mode of DESTROYED.

#### WHEREStatus

Specifies the status of volumes to be updated. Use this parameter to restrict the update to volumes that have a specified status. This parameter is optional. You can specify multiple status values by separating the values with commas and no intervening spaces. If you do not specify a value for this parameter, the update is not restricted by volume status. Possible values are:

##### ONline

Update volumes with a status of ONLINE.

##### OFFline

Update volumes with a status of OFFLINE.

##### EMPTy

Update volumes with a status of EMPTY.

##### PENding

Update volumes with a status of PENDING. These are volumes from which all files have been deleted, but the time specified by the REUSEDELAY parameter has not elapsed.

##### FILLing

Update volumes with a status of FILLING.

##### FULL

Update volumes with a status of FULL.

#### Preview

Specifies whether you want to preview the update operation without actually updating volumes. This parameter is optional. The default value is NO. Possible values are:

##### No

Specifies that volumes are actually updated.

##### Yes

Specifies that you want only to preview the update operation. This option displays the volumes that will be updated if you actually perform the update operation.

## Example: Make a tape volume unavailable

---

Update a tape volume named DSMT20 to make it unavailable to client nodes and server processes.

```
update volume dsmt20 access=unavailable
```

## Example: Update the access mode of all offsite volumes in a specific storage pool

---

Update all empty, offsite volumes in the TAPEPOOL2 storage pool. Set the access mode to READWRITE and delete the location information for the updated volumes.

```
update volume * access=readwrite location="" wherestgpool=tapepool2
  whereaccess=offsite wherestatus=empty
```

## Related commands

Table 1. Commands related to UPDATE VOLUME

Command	Description
DEFINE VOLUME	Assigns a volume to be used for storage within a specified storage pool.
DELETE VOLUME	Deletes a volume from a storage pool.
QUERY VOLUME	Displays information about storage pool volumes.
VARY	Specifies whether a disk volume is available to the server for use.

## VALIDATE commands

Use the VALIDATE command to verify that an object is complete or valid for IBM Spectrum Protect™.

- **Linux** VALIDATE ASPERA (Validate an Aspera FASP configuration)
- **AIX** **Linux** **Windows** VALIDATE CLOUD (Validate cloud credentials)
- VALIDATE LANFREE (Validate LAN-Free paths)
- VALIDATE POLICYSET (Verify a policy set)
- VALIDATE REPLICATION (Validate replication for a client node)
- VALIDATE REPLPOLICY (Verify the policies on the target replication server)

**Linux**

## VALIDATE ASPERA (Validate an Aspera FASP configuration)

Use this command to determine whether Aspera® Fast Adaptive Secure Protocol (FASP®) technology can be used to optimize data transfer in your system environment. Specifically, you can determine whether Aspera FASP technology would result in better network throughput than TCP/IP technology.

This command verifies the following additional items:

- Whether the system environment is correctly configured to use Aspera FASP technology
- Whether the required licenses for enabling Aspera FASP technology are installed

Aspera FASP technology is used to optimize data transfer for node replication or storage pool protection in a wide area network (WAN). However, you are not required to configure your system for node replication or storage pool protection to run the VALIDATE ASPERA command. If your system is configured for node replication or storage pool protection in a local environment, you can issue the command to evaluate whether the data can be successfully replicated to a remote server.

This command is available only on Linux x86\_64 operating systems.

Before you issue the command, complete the following tasks:

1. Ensure that at least one server is defined in your system environment. Issue the PING SERVER command to ensure that you have connectivity to the defined server. For example, if the server is named VMRH6T, issue the following command:

```
ping server vmrh6t
```

2. To use the VALIDATE ASPERA command to determine the speed of network throughput, install 30-day evaluation licenses or full, unlimited licenses on the source and target servers. For example, install licenses on the source and target servers, VMRH6 and VMRH6T. For instructions about obtaining and installing licenses, see Determining whether Aspera FASP technology can optimize data transfer in your system environment.

To simulate an environment that uses multiple sessions, you can run several instances of the VALIDATE ASPERA command simultaneously. If you plan to run multiple sessions, you might want to limit the bandwidth of each network connection to ensure that sufficient bandwidth is available for all network connections. To limit the bandwidth, specify the FASPTARGETRATE server option as described in FASPTARGETRATE.

You can query the current transferred amount by issuing the QUERY PROCESS command:

query process

You can obtain the process number from the output of the QUERY PROCESS command. You can cancel the process by issuing the CANCEL PROCESS command and specifying the process number, for example:

```
cancel process 3
```

## Privilege class

---

Any administrator can issue this command.

## Syntax

---

```
>>-VALidate ASPera---+-----+----->
                        '---target_server_name---'
                        .-Wait---No-----
>--+-----+-----+----->>
  '-DURation---seconds-' '-Wait---No---+'
                        '-Yes-'
```

## Parameters

---

**target\_server\_name**

Specifies a previously defined server. This parameter is optional. To specify this parameter, follow the guidelines:

- To determine whether Aspera FASP can optimize a node replication process, specify a target server that is configured for node replication.
- To determine whether Aspera FASP can optimize a storage pool protection process, specify a target server that is configured for storage pool protection.
- To determine whether Aspera FASP can optimize data transfer to a remote server that is defined but not configured for storage pool protection or node replication, specify that target server.
- If you do not specify a target server, the command output indicates whether the source server is correctly configured for Aspera FASP data transmission. The output also indicates whether a valid license for Aspera FASP is installed on the source server.

**DURation**

Specifies the allotted time, in seconds, for transferring data across the network to evaluate throughput. This parameter is optional. The default value is 120 seconds. You can specify a value in the range 120 - 3600000 seconds. The allotted time is divided between the Aspera FASP and TCPIP data transfers.

**Wait**

Specifies whether to wait for the server to complete the command processing. This parameter is optional. The default value is NO. You can specify one of the following values:

**No**

Specifies that the server processes the command in the background. You can continue with other tasks while the command is being processed. If you specify NO, the output messages are displayed in the activity log.

**Yes**

Specifies that the server processes the command in the foreground. The operation must complete processing before you can continue with other tasks. If you specify YES, the output messages are displayed in the administrative command-line client.

Restriction: You cannot specify WAIT=YES from the server console.

## Example: Display information about the status of an Aspera FASP configuration

---

On the source server, run the VALIDATE ASPERA command. To ensure that messages are displayed in the administrative command-line client, specify WAIT=YES. See Field descriptions for field descriptions.

```
validate aspera wait=yes
```

```
ANR3836I Validation of the Aspera FASP connection from VMRH6 to localhost.
Amount transferred using FASP: 0 MB per second. Amount transferred using
TCP/IP: 0 MB per second. Latency: 0 microseconds. Status: OK. Days until
```

license expires: Never.

## Example: Verify whether the required licenses are installed

On the source server, run the `VALIDATE ASPERA` command and specify the target replication server. To ensure that messages are displayed in the administrative command-line client, specify `WAIT=YES`. See Field descriptions for field descriptions.

```
validate aspera vmrh6t wait=yes
```

```
ANR0984I Process 8 for VALIDATE ASPERA started in the FOREGROUND at 09:35:21 AM.  
ANR3672E The license file that is required to enable Aspera Fast Adaptive  
Secure Protocol (FASP) technology was not found on the VMRH6 server.  
ANR3836I Validation of the Aspera FASP connection from VMRH6 to localhost.  
Amount transferred using FASP: 0 MB per second. Amount transferred using  
TCP/IP: 0 MB per second. Latency: 0 microseconds. Status: Invalid  
configuration. Days until license expires: Expired.  
ANR0985I Process 8 for VALIDATE ASPERA running in the FOREGROUND completed with  
completion state FAILURE at 09:35:21 AM.  
ANR1893E Process 8 for VALIDATE ASPERA completed with a completion state of  
FAILURE.
```

## Field descriptions

### Status

The status of the configuration. The following values are possible:

- `OK` indicates that no issues are detected.
- `Invalid configuration` indicates that a configuration file, license file, or Aspera FASP library file is missing.
- `License issue` indicates that a license is missing, invalid, or expired.
- `Server failure` indicates that all ports are in use, a network read/write error occurred, or the Aspera FASP log file is unwritable.
- `Invalid target configuration` indicates that a configuration file, license file, or Aspera FASP library file is missing on the target server.
- `Failure on target server` indicates that all ports are in use, a network read/write error occurred, or the Aspera FASP log file is unwritable.
- `License issue on target server` indicates that a license is invalid or expired on the target server.
- `Unsupported operating system` indicates that an operating system other than Linux x86\_64 is installed on one or both servers.
- `Unknown` indicates that an unexpected error occurred. To identify the error, review the log messages.

### Days until license expires

The following values are possible:

- `Never` indicates that a full, unlimited license is installed.
- `Today` indicates that a 30-day evaluation license is installed and it expires today.
- `Expired` indicates that a 30-day evaluation license is installed, but has expired.
- `Number` indicates that a 30-day evaluation license is installed and will expire in the specified number of days.
- `License not found` indicates that no license was found.

### Amount transferred using TCP/IP

The speed of data transfer, in megabytes per second, using TCP/IP technology.

### Amount transferred using FASP

The speed of data transfer, in megabytes per second, using Aspera FASP technology.

### Latency

The latency of data transfer in microseconds.

## Related commands

Table 1. Commands related to VALIDATE ASPERA

Command	Description
CANCEL SESSION	Cancels active sessions with the server.



Command	Description
DEFINE SERVER	Defines a server for server-to-server communications.
PING SERVER	Tests the connections between servers.
<b>AIX</b>   <b>Linux</b>   <b>Windows</b> PROTECT STGPOOL	<b>AIX</b>   <b>Linux</b>   <b>Windows</b> Protects a directory-container storage pool.
REPLICATE NODE	Replicates data in file spaces that belong to a client node.

## VALIDATE CLOUD (Validate cloud credentials)

Before you define a storage pool, use this command to ensure that the credentials for a cloud-container storage pool are valid and that the necessary permissions are granted to the user.

### Privilege class

Any administrator can issue this command.

### Syntax

```

      .-CLOUDType-----Swift-----
>>-VALidate CLOud--+-+-----+----->
      '-CLOUDType-----+AZure-----+'
                        +-S3-----+
                        +-SOftlayer-+
                        +-SWift-----+
                        '-V1Swift---'
                                     (1)
>--CLOUDUrL-----cloud_url--IDentity-----cloud_identity----->
>--PAssword-----password--+-+-----+----->>
      |                                     (2) |
      '-BUCKETName-----bucket_name-----'

```

Notes:

1. If you specify CLOUDTYPE=AZURE, do not specify the IDENTITY parameter.
2. The BUCKETNAME parameter is valid only if you specify CLOUDTYPE=S3.

### Parameters

#### CLOUDType

Specifies the type of cloud environment where you are configuring the storage pool. You can specify one of the following values:

#### Azure

Specifies that the storage pool uses a Microsoft Azure cloud computing system.

#### S3

Specifies that the storage pool uses a cloud computing system with the Simple Storage Service (S3) protocol, such as IBM® Cloud Object Storage or Amazon Web Services (AWS) S3.

#### Softlayer

Specifies that the storage pool uses an IBM SoftLayer® (IBM Bluemix) cloud computing system with an OpenStack Swift cloud computing system.

#### Swift

Specifies that the storage pool uses an OpenStack Swift cloud computing system. This value also specifies that the storage pool uses Version 2 of the protocol for authentication to the cloud. The URL of the cloud usually contains the version number of the protocol that it is using.

#### V1Swift

Specifies that the storage pool uses an OpenStack Swift cloud computing system. This value also specifies that the storage pool uses Version 1 of the protocol for authentication to the cloud. The URL of the cloud usually contains the version number of the protocol that it is using.

This parameter is optional. If you do not specify the parameter, the default value, SWIFT, is used.

**CLOUDUrl (Required)**

Specifies the URL of the cloud environment where you configure the storage pool. Based on your cloud provider, you can use a blob service endpoint, region endpoint URL, an accesser IP address, a public authentication endpoint, or a similar value for this parameter. Ensure that you include the protocol, such as `https://` or `http://`, at the beginning of the URL. The maximum length of the web address is 870 characters. The CLOUDURL parameter is validated when the first backup begins.

**IDentity (Required)**

Specifies the user ID for the cloud. This parameter is required for all supported cloud computing systems except Azure. If you specify CLOUDTYPE=AZURE, do not specify the IDENTITY parameter. Based on your cloud provider, you can use an access key ID, a user name, a tenant name and user name, or a similar value for this parameter. The maximum length of the user ID is 255 characters.

**PAssword (Required)**

Specifies the password for the cloud. Based on your cloud provider, you can use a shared access signature (SAS) token, secret access key, an API key, a password, or a similar value for this parameter. This parameter is required. The maximum length of the password is 255 characters.

**BUCKETName**

Specifies the name for an AWS S3 bucket or a IBM Cloud Object Storage vault to use with this storage pool, instead of using the default bucket name or vault name. This parameter is optional, and is valid only if you specify CLOUDTYPE=S3. If a bucket or vault exists with the name that you specify, that bucket or vault is tested to ensure that the proper permissions are set. If the bucket or vault does not exist, the parameter verifies only that a bucket or vault with that name does not exist. Follow the naming restrictions for your cloud provider when you specify this parameter. Review the permissions for the bucket or vault and make sure that the credentials have permission to read, write, list, and delete objects in this bucket or vault.

Tip: If you do not specify the BUCKETNAME parameter, the Replication Globally Unique ID is used as the default bucket name. The default is

`ibmsp guid`

where *guid* is the REPLICATION GLOBALLY UNIQUE ID value, minus the periods, in the output of the QUERY REPLSERVER command. For example, if the Replication Globally Unique ID is 52.82.39.20.64.d0.11.e6.9d.77.0a.00.27.00.00.00, the default bucket name is `ibmsp.5282392064d011e69d770a0027000000`.

## Example: Verify the credentials of an S3 cloud-container storage pool

---

Validate the credentials of the cloud-container storage pool.

```
validate cloud
cloudtype=s3 cloudurl=http://123.234.123.234:5000/v2.0
password=protect8991 bucketname=ibmsp.5282392064d011e69d770a0027000000
```

## Related commands

---

Table 1. Commands related to VALIDATE CLOUD

Command	Description
DEFINE STGPOOL (cloud-container)	Define a cloud-container storage pool.
QUERY REPLSERVER	Displays information about replicating servers.
UPDATE STGPOOL (cloud-container)	Update a cloud-container storage pool.

## VALIDATE LANFREE (Validate LAN-Free paths)

---

Use this command to determine which destinations for a given node using a specific storage agent are capable of LAN-Free data movement.

## Privilege class

---

To issue this command, you must have system privilege.

## Syntax

---

```
>>-VALidate LANfree--node_name--stgagent_name-----><
```

## Parameters

node\_name (Required)

The name of the node to evaluate.

stgagent\_name (Required)

The name of the storage agent to evaluate.

## Example: Validate a current LAN-Free configuration

Validate the current server definitions and configuration for node TIGER to use storage agent AIX\_STA1 for LAN-free data operations.

```
validate lanfree tiger aix_sta1
```

Node Name	Storage Agent	Operation	Mgmt Class Name	Destination Name	LAN-Free capable?	Explanation
TIGER	AIX_STA1	BACKUP	STANDARD	OUTPOOL	NO	No available online paths.
TIGER	AIX_STA1	BACKUP	STANDARD	PRIMARY	NO	Destination storage pool is configured for simultaneous write.
TIGER	AIX_STA1	BACKUP	STANDARD	SHRPOOL	YES	
TIGER	AIX_STA1	BACKUP	NOARCH	LFFILE	NO	Storage pool contains data deduplicated by clients, and is not accessible by storage agents V6.1 or earlier.
TIGER	AIX_STA1	ARCHIVE	STANDARD	OUTPOOL	NO	No available online paths.
TIGER	AIX_STA1	ARCHIVE	STANDARD	PRIMARY	NO	Destination storage pool is configured for simultaneous write.
TIGER	AIX_STA1	ARCHIVE	STANDARD	SHRPOOL	YES	

## Related commands

Table 1. Commands related to VALIDATE LANFREE

Command	Description
QUERY COPYGROUP	Displays the attributes of a copy group.
QUERY DEVCLASS	Displays information about device classes.
QUERY DOMAIN	Displays information about policy domains.
QUERY DRIVE	Displays information about drives.
QUERY LIBRARY	Displays information about one or more libraries.
QUERY MGMTCLASS	Displays information about management classes.
QUERY NODE	Displays partial or complete information about one or more clients.
QUERY PATH	Displays information about the path from a source to a destination.
QUERY POLICYSET	Displays information about policy sets.

Command	Description
QUERY SERVER	Displays information about servers.
QUERY STATUS	Displays the settings of server parameters, such as those selected by the SET commands.
QUERY STGPOOL	Displays information about storage pools.

## VALIDATE POLICYSET (Verify a policy set)

Use this command to verify that a policy set is complete and valid before you activate it. The command examines the management class and copy group definitions in the policy set and reports on conditions that you need to consider before activating the policy set.

The VALIDATE POLICYSET command fails if any of the following conditions exist:

- The policy set has no default management class.
- A copy group within the policy set specifies a copy storage pool as a destination.
- A management class specifies a copy storage pool as the destination for files that were migrated by an IBM Spectrum Protect™ for Space Management client.
- A TOCDESTINATION parameter is specified, and the storage pool is either a copy pool or has a data format other than NATIVE or NONBLOCK.

The server issues warning messages for the following conditions:

- A copy group specifies a storage pool that does not exist as a destination for backed-up or archived files.

If you activate a policy set with copy groups that specify nonexistent storage pools, the client backup or archive operations fail.

- A management class specifies a storage pool that does not exist as a destination for files migrated by IBM Spectrum Protect for Space Management clients.
- The policy set does not have one or more management classes that exist in the current ACTIVE policy set.

If you activate the policy set, backup files bound to the deleted management classes are rebound to the default management class in the new active policy set.

- The policy set does not have one or more copy groups that exist in the current ACTIVE policy set.

If you activate the policy set, files bound to the management classes with deleted copy groups are no longer archived or backed up.

- The default management class for the policy set does not contain a backup or archive copy group.

If you activate the policy set with this default management class, clients using the default cannot back up or archive files.

- A management class specifies that a backup version must exist before a file can be migrated from a client node (MIGREQUIRESBKUP=YES), but the management class does not contain a backup copy group.

If the server has data retention protection enabled, the following conditions must exist:

- All management classes in the policy set to be validated must contain an archive copy group.
- If a management class exists in the active policy set, a management class with the same name must exist in the policy set to be validated.
- If an archive copy group exists in the active policy set, the corresponding copy group in the policy set to be validated must have a RETVER value at least as large as the corresponding values in the active copy group.

### Privilege class

To issue this command, you must have system privilege, unrestricted policy privilege, or restricted policy privilege for the policy domain to which the policy set belongs.

### Syntax

```
>>-VALidate POLicysset--domain_name--policy_set_name-----><
```

## Parameters

domain\_name (Required)  
Specifies the name of the policy domain to which the policy set is assigned.

policy\_set\_name (Required)  
Specifies the name of the policy set to be validated.

## Example: Validate a specific policy set

Validate the policy set `VACATION` located in the `EMPLOYEE_RECORDS` policy domain.

```
validate policyset employee_records vacation
```

## Related commands

Table 1. Commands related to VALIDATE POLICYSET

Command	Description
ACTIVATE POLICYSET	Validates and activates a policy set.
COPY POLICYSET	Creates a copy of a policy set.
DEFINE COPYGROUP	Defines a copy group for backup or archive processing within a specified management class.
DEFINE MGMTCLASS	Defines a management class.
DELETE POLICYSET	Deletes a policy set, including its management classes and copy groups, from a policy domain.
QUERY POLICYSET	Displays information about policy sets.
UPDATE COPYGROUP	Changes one or more attributes of a copy group.
UPDATE POLICYSET	Changes the description of a policy set.

## VALIDATE REPLICATION (Validate replication for a client node)

Use this command to identify the replication rules that apply to file spaces in client nodes that are configured for replication. You can also use this command to verify that the source replication server can communicate with the target replication server.

Before you begin replication processing, use the `VALIDATE REPLICATION` command to determine whether your replication configuration is correct.

Issue this command on the server that acts as a source for replicated data.

## Privilege class

To issue this command, you must have system privilege.

## Syntax

```
          .-|-----|
          v          |
>>-VALidate REPLication-----node_name---+----->

.-VERIFYconnection-----No-----
>--+-----+-----><
'-VERIFYconnection-----+No--+-'
          '-Yes-'
```

## Parameters

---

### node\_name (Required)

Specifies the name of the client node whose file spaces you want to display. To specify multiple client node names, separate the names with commas and no intervening spaces. You can use wildcard characters to specify names.

Information is displayed only for client nodes that are either enabled or disabled for replication. The replication mode must be SEND. To determine whether a client node is enabled or disabled for replication and its mode, issue the QUERY NODE command. Look for values in the Replication State and Replication Mode fields.

### VERIFYconnection

Specifies whether to check the connection to a target replication server. The version of the target replication server is also checked to verify that it is Version 6.3 or later. This parameter is optional. The default is NO. You can specify one of the following values:

#### No

The connection and version of the target replication server are not checked.

#### Yes

The connection and version of the target replication server are checked.

## Example: Validate replication for a client node

---

The name of the client node is NODE1. Verify the connection status between the source and the target replication servers.

```
validate replication node1 verifyconnection=yes
```

```
      Node Name: NODE1
      Filespace Name: \\node1\c$
      FSID: 1
      Type: Bkup
Controlling Replication Rule: ACTIVE_DATA
      Replication Rule Level: System Level
      Server Name: DRSRV
      Connection Status: Valid Connection

      Node Name: NODE1
      Filespace Name: \\node1\c$
      FSID: 1
      Type: Arch
Controlling Replication Rule: ALL_DATA_HIGH_PRIORITY
      Replication Rule Level: Node Level
      Server Name: DRSRV
      Connection Status: Valid Connection

      Node Name: NODE1
      Filespace Name: \\node1\c$
      FSID: 1
      Type: SpMg
Controlling Replication Rule: ALL_DATA
      Replication Rule Level: System Level
      Server Name: DRSRV
      Connection Status: Valid Connection
```

Output is displayed for all data types regardless of whether a file space contains the data types. For example, if a file space contains only backup and archive data, the output of the VALIDATE REPLICATION command also contains information that would be relevant to space-managed data.

## Field descriptions

---

### Node Name

The node that owns the replicated data.

### Filespace Name

The name of the file space that belongs to the node.

File space names can be in a different code page or locale than the server. If they are, the names in the Operations Center and the administrative command-line interface might not be displayed correctly. Data is backed up and can be restored normally, but the file space name or file name might be displayed with a combination of invalid characters or blank spaces.

If the file space name is Unicode-enabled, the name is converted to the server code page for display. The success of the conversion depends on the operating system, the characters in the name, and the server code page. Conversion can be incomplete if the string includes characters that are not available in the server code page or if the server cannot access system conversion routines. If the conversion is incomplete, the name might contain question marks, blanks, unprintable characters, or ellipses (...).

#### FSID

The file space identifier for the file space. The server assigns a unique FSID when a file space is first stored on the server.

#### Type

The type of data. The following values are possible:

##### Arch

Archive data

##### Bkup

Backup data

##### SpMg

Data that was migrated by an IBM Spectrum Protect™ for Space Management client.

#### Controlling Replication Rule

The name of the replication rule that controls replication for a data type in a file space. To determine whether the controlling rule is a file space rule, a client rule, or a server rule, check the Replication Rule Level field.

#### Replication Rule Level

The level of the controlling rule in the replication-rule hierarchy. The following values are possible:

##### Filespace

The controlling rule is assigned to a data type in the file space.

##### Node

The controlling rule is assigned to a data type for a client node.

##### Server

The controlling rule is assigned to a data type for all file spaces in all client nodes that are configured for replication.

#### Server Name

The name of the target replication server to be queried.

#### Connection Status

The connection status between the source and the target replication server. The following values are possible:

##### Valid Connection

Communication with the target replication server was successful, and the target replication server is a V6.3 server.

##### Target Server Not Set

The target replication server is not set. To set the target replication server, issue the SET REPLSERVER command.

##### Communication Failure

The source replication server was unable to contact the target replication server. Examine the activity log for error messages about failed communications. Consider the following possible causes:

- The replication configuration on the source replication server is not valid. One or more of the following problems might exist:
  - The server definition for the target replication server is incorrect.
  - If the target replication-server definition was deleted and redefined, issue the PING SERVER command to test the connection between the source and the target replication server. If the PING SERVER command is successful, issue the UPDATE SERVER command and specify FORCESYNC=YES to reset the server verification keys.
  - The server name, server low-level address, server high-level address, and server password do not match the values that are specified in the server definition on the target replication server.
- The replication configuration on the target replication server is not valid. One or more of the following problems might exist:
  - The version of the target replication server is earlier than V6.3.
  - The server definition for the source replication server is incorrect.
  - The server name, server low-level address, server high-level address, and server password do not match the values that are specified in the server definition on the source replication server.
- Network communications are unavailable. To test the connection between the source and target server, issue the PING SERVER command.
- The target replication server is unavailable.
- Sessions between the source and the target replication servers are disabled. To verify the status of sessions, issue the QUERY STATUS command.

## Replication Suspended

Replication processing is suspended when you restore the database on the source replication server or you disable replication processing on this server by issuing the DISABLE REPLICATION command.

## Related commands

Table 1. Commands related to VALIDATE REPLICATION

Command	Description
DISABLE REPLICATION	Prevents outbound replication processing on a server.
ENABLE REPLICATION	Allows outbound replication processing on a server.
ENABLE SESSIONS	Resumes server activity following the DISABLE command or the ACCEPT DATE command.
QUERY FILESPACE	Displays information about data in file spaces that belong to a client.
QUERY NODE	Displays partial or complete information about one or more clients.
QUERY REPLRULE	Displays information about node replication rules.
QUERY SERVER	Displays information about servers.
QUERY STATUS	Displays the settings of server parameters, such as those selected by the SET commands.
REPLICATE NODE	Replicates data in file spaces that belong to a client node.
SET ARREPLRULEDEFAULT	Specifies the server node-replication rule for archive data.
SET BKREPLRULEDEFAULT	Specifies the server node-replication rule for backup data.
SET REPLSERVER	Specifies a target replication server.
SET SPREPLRULEDEFAULT	Specifies the server node-replication rule for space-managed data.
UPDATE FILESPACE	Changes file-space node-replication rules.
UPDATE NODE	Changes the attributes that are associated with a client node.
UPDATE REPLRULE	Enables or disables replication rules.
UPDATE SERVER	Updates information about a server.

## VALIDATE REPLPOLICY (Verify the policies on the target replication server)

Use this command to compare the policies for client nodes on the source replication server with the same policies on the target replication server where the client node data is being replicated.

The command displays the differences between these policies so that you can verify that any differences between the policies on the source and target replication servers are intended or you can modify the policies on the target replication server.

Ensure that IBM Spectrum Protect™, Version 7.1.1 or later, is installed on the source and target replication servers before you issue this command. Issue this command on the source replication server.

## Privilege class

Any administrator can issue this command.

## Syntax

```
>>-VALidate REPLPolicy--+-+-----+-----<<
```



'-server\_name-'

## Parameters

---

### server\_name

Specifies the name of the target replication server that has policies you want to verify. This parameter is optional. If you do not specify this parameter, the command sets the default replication server as the target replication server.

## Example: Display the differences between the replication policies on a source and target replication server

---

To display the differences between the policies on the source replication server and the policies on the target replication server, CVTCVS\_LXS\_SRV2, where the client data is replicated, issue the following command on the source replication server:

```
VALIDATE REPLPOLICY CVTCVS_LXS_SRV2
```

Policy domain name on this server	Policy domain name on target server	Target server name
STANDARD	STANDARD	CVTCVS_LXS_SRV2
Differences in policy set:		
Change detected	Source server value	Target server value
Mgmt class only on target	Not applicable	STANDARD2
Mgmt Class only on source	STANDARD1	Not applicable
Differences in backup copy group		
Change detected	STANDARD in management class	STANDARD
	Source server value	Target server value
Versions data exists	2	20

Affected nodes

```
-----  
NODE1,NODE2,NODE3,NODE4,NODE5
```

## Field descriptions

---

### Policy domain name on this server

Specifies the policy domain name on the source replication server where the command is issued.

### Policy domain name on target server

Specifies the policy domain name on the target replication server.

### Target server name

Specifies the name of the target replication server.

### Differences in policy set:

Specifies the differences between the policies that are defined on the source and target replication servers. The differences between the policies are listed under the following fields:

#### Change detected

Specifies the list of policy items that are different between the source and target replication servers.

#### Source server value

Specifies the value for the policy item on the source replication server.

#### Target server value

Specifies the value for the policy item on the target replication server.

### Differences in backup copy group <backup\_copy\_group\_name> in default management class OR Differences in archive copy group <archive\_copy\_group\_name> in default management class

Specifies the differences between the backup copy group or the archive copy group in the management class. The differences are listed under the following fields:

#### Change Detected

Specifies the list of copy group fields that are different.

#### Source server value

Specifies the value in the copy group field on the source replication server.  
 Target server value  
 Specifies the value in the copy group field on the target replication server.

Affected nodes

Specifies the names of all the client nodes that are affected by the changes that are shown in this output.

## Related commands

Table 1. Commands related to VALIDATE REPLPOLICY

Command	Description
VALIDATE REPLICATION	Verifies replication for file spaces and data types.
QUERY REPLSERVER	Displays information about replicating servers.
SET DISSIMILARPOLICIES	Enable the policies on the target replication server to manage replicated data.
QUERY DOMAIN	Displays information about policy domains.
QUERY POLICYSET	Displays information about policy sets.
QUERY COPYGROUP	Displays the attributes of a copy group.
QUERY MGMTCLASS	Displays information about management classes.

## VARY (Bring a random access volume online or offline)

Use this command to make a random access storage pool volume online or offline to the server.

### Privilege class

This command is valid only for volumes on random access devices. For example, use this command during maintenance or corrective action of a random access volume. You cannot vary a random access volume online that is defined as unavailable.

To issue this command, you must have system privilege or operator privilege.

### Syntax

```
>>-VARY--+-ONline---+--volume_name--+-+-----+-----><
      '-Offline-'          '-Wait-----+No--+'
                               '-Yes-'
```

### Parameters

ONline

Specifies that the server can use the random access volume.

OFFline

Specifies that the server cannot use the volume.

volume\_name (Required)

Specifies the volume identifier. Volume names cannot contain embedded blanks or equal signs.

Wait

Specifies whether to wait for the server to complete processing this command in the foreground. This parameter is optional. The default is NO. Possible values are:

No

Specifies that the server processes this command in the background, while other tasks run. The server displays messages created from the background process either in the activity log or the server console, depending on where messages are logged.

Yes

Specifies that the server processes this command in the foreground. Wait for the command to complete before you continue with other tasks. The server displays the output messages to the administrative client when the command completes.

**AIX** | **Linux** | **Windows** You cannot specify WAIT=YES from the server console.

## Example: Bring volume online

**AIX** | **Linux** Make volume /adsm/stgvol/1 available to the server for use as a storage pool volume. **AIX** | **Linux**

```
vary online /adsm/stgvol/1
```

**Windows** Make volume j:\storage\pool001 available to the server for use as a storage pool volume. **Windows**

```
vary online j:\storage\pool001
```

## Related commands

Table 1. Commands related to VARY

Command	Description
CANCEL PROCESS	Cancel a background server process.
DEFINE VOLUME	Assigns a volume to be used for storage within a specified storage pool.
DELETE VOLUME	Deletes a volume from a storage pool.
QUERY PROCESS	Displays information about background processes.
QUERY VOLUME	Displays information about storage pool volumes.

## Server options

At installation, IBM Spectrum Protect™ provides a server options file that contains a set of default options to start the server.

The file is:

- dsmserv.opt in the server instance directory

Server options let you customize the following:

- Communication
- Server storage
- Client-server
- Date, number, time, and language
- Database and recovery log
- Data transfer
- Message
- Event logging
- Security and licensing

Several other options are available for miscellaneous purposes. These undocumented options are intended to be used only by IBM® support.

To display the current option settings, enter:

```
query option
```

- Modifying server options  
The server reads the server options file at server initialization. When you update a server option by editing the file, you must stop and start the server to activate the updated server options file.
- Types of server options  
Server options let you customize how some functions and processes work.
- 3494SHARED  
The 3494SHARED option specifies whether an IBM 3494 library can share applications other than IBM Spectrum Protect.

- ACSACCESSID  
The ACSACCESSID option specifies the ID for the ACS access control for an ACSLS library.
- ACSLOCKDRIVE  
The ACSLOCKDRIVE option specifies if the drives within the ACSLS libraries are locked. Drive locking ensures the exclusive use of the drive in the ACSLS library in a shared environment. However, there is some performance gain if libraries are not locked. When other applications do not share the IBM Spectrum Protect drives, drive locking is not required.
- ACSQUICKINIT  
The ACSQUICKINIT option specifies whether, at server startup, the initialization of the ACSLS library is a quick or full initialization. The default is Yes. A quick initialization avoids the overhead associated with synchronizing the IBM Spectrum Protect server inventory with the ACSLS library inventory (through an audit of the library).
- ACSTIMEOUTX  
The ACSTIMEOUTX option specifies the multiple for the built-in timeout value for ACSLS APIs. The built-in timeout value for the ENTER, EJECT, and AUDIT ACS API is 1800 seconds; for all other ACSLS APIs it is 600 seconds. For example, if the multiple value specified is 5, the timeout value for audit API becomes 9000 seconds, and all other APIs become 3000 seconds.
- ACTIVELOGDIRECTORY  
The ACTIVELOGDIRECTORY option specifies the name of the directory where all active logs are stored.
- ACTIVELOGSIZE  
The ACTIVELOGSIZE option sets the total log size.
- ADMINCOMMTIMEOUT  
The ADMINCOMMTIMEOUT option specifies how long the server waits for an expected administrative client message during an operation that causes a database update.
- ADMINIDLETIMEOUT  
The ADMINIDLETIMEOUT option specifies the amount of time, in minutes, that an administrative client session can be idle before the server cancels the session.
- ADMINONCLIENTPORT  
The ADMINONCLIENTPORT option specifies whether the TCPPOINT can be used by administrative sessions. The default is YES.
-  ADMSGROUPNAME  
The ADMSGROUPNAME option specifies the name of a Windows group. A client node must be a member of this group to use the IBM Spectrum Protect server through NT Unified Logon. The client node must also be a registered IBM Spectrum Protect client node.
- ALIASHALT  
The ALIASHALT option allows administrators to give the IBM Spectrum Protect **HALT** command a different name.
- ALLOWDESAUTH  
The ALLOWDESAUTH option specifies whether to allow use of the Data Encryption Standard (DES) algorithm for authentication between a server and a backup-archive client.
- ALLOWREORGINDEX  
The ALLOWREORGINDEX option specifies whether server-initiated index reorganization is enabled or disabled.
- ALLOWREORGTABLE  
The ALLOWREORGTABLE option specifies whether server-initiated table reorganization is enabled or disabled.
- ARCHFAILOVERLOGDIRECTORY  
The ARCHFAILOVERLOGDIRECTORY option specifies the directory which the server uses to store archive log files that cannot be stored in the archive log directory.
- ARCHLOGCOMPRESS  
You can enable or disable compression of archive logs on the IBM Spectrum Protect server. By compressing the archive logs, you reduce the amount of space that is required for storage.
- ARCHLOGDIRECTORY  
The ARCHLOGDIRECTORY option specifies a directory that the database manager can archive a log file into after all the transactions represented in that log file are completed.
- ARCHLOGUSEDTHRESHOLD  
The ARCHLOGUSEDTHRESHOLD option specifies when to start an automatic database backup in relation to the percentage of archive log file space used. The default is 80 percent.
- ASSISTVCRRECOVERY  
The ASSISTVCRRECOVERY option specifies whether IBM Spectrum Protect assists an IBM 3590 drive in recovering from a lost or corrupted Vital Cartridge Records (VCR) condition. If you specify YES (the default) and if IBM Spectrum Protect detects an error during the mount processing, it locates to the end-of-data during the dismount processing to allow the drives to restore the VCR. During the tape operation, there might be some small effect on performance because the drive cannot complete a fast locate with a lost or corrupted VCR. However, there is no loss of data.
- AUDITSTORAGE  
As part of a license audit operation, the server calculates, by node, the amount of server storage used for backup, archive, and space-managed files. For servers managing large amounts of data, this calculation can take a great deal of CPU time

and can stall other server activity. You can use the AUDITSTORAGE option to specify that storage is not to be calculated as part of a license audit.

- **BACKUPINITIATIONROOT**  
The BACKUPINITIATIONROOT option specifies whether the server overrides node parameter values for users who are not IBM Spectrum Protect authorized users.
- **CHECKTAPEPOS**  
The CHECKTAPEPOS option specifies whether the IBM Spectrum Protect server validates the position of data blocks on tape.
- **CLIENTDEDUPTXNLIMIT**  
The CLIENTDEDUPTXNLIMIT option specifies the maximum size of a transaction when client-side deduplicated data is backed up or archived.
- **COMMMETHOD**  
The COMMMETHOD option specifies a communication method to be used by the server.
- **COMMTIMEOUT**  
The COMMTIMEOUT option specifies how long the server waits for an expected client message during an operation that causes a database update. If the length of time exceeds this time-out, the server ends the session with the client. You may want to increase the time-out value to prevent clients from timing out. Clients may time out if there is a heavy network load in your environment or they are backing up large files.
- **CONTAINERRESOURCESTIMEOUT**  
The CONTAINERRESOURCESTIMEOUT option specifies how long the server waits to complete a data store operation to a container storage pool.
- **Windows DATEFORMAT**  
The DATEFORMAT option specifies the format in which dates are displayed by the server.
- **DBDIAGLOGSIZE**  
This option helps to control the amount of space that is used by diagnostic log files.
- **DBDIAGPATHFSTHRESHOLD**  
The DBDIAGPATHFSTHRESHOLD option specifies the threshold for free space on the file system or disk that contains the db2diag.log file.
- **DBMEMPERCENT**  
Use this option to specify the percentage of the virtual address space that is dedicated to the database manager processes.
- **DBMTCPPORT**  
The DBMTCPPORT option specifies the port number on which the TCP/IP communication driver for the database manager waits for requests for client sessions.
- **DEDUPREQUIRESBACKUP**  
The DEDUPREQUIRESBACKUP option specifies whether volumes in primary sequential-access storage pools that are set up for data deduplication can be reclaimed and whether duplicate data can be discarded before the storage pools are backed up.
- **DEDUPTIER2FILESIZE**  
The DEDUPTIER2FILESIZE option specifies at what file size IBM Spectrum Protect begins to use Tier 2 data deduplication.
- **DEDUPTIER3FILESIZE**  
The DEDUPTIER3FILESIZE option specifies at what file size IBM Spectrum Protect begins to use Tier 3 data deduplication.
- **DEVCONFIG**  
The DEVCONFIG option specifies the name of a file in which you want IBM Spectrum Protect to store a backup copy of device configuration information.
- **DISABLEREORGTABLE**  
The DISABLEREORGTABLE option specifies whether online table reorganization is disabled for table names that are specified in the tables list.
- **DISABLESCHEDS**  
The DISABLESCHEDS option specifies whether administrative and client schedules are disabled during IBM Spectrum Protect server recovery.
- **DISPLAYLFINFO**  
The DISPLAYLFINFO option specifies how the accounting records and summary table entries report the node name.
- **DNSLOOKUP**  
The DNSLOOKUP option specifies whether the server uses system API calls to determine the domain name server (DNS) names of systems that contact the server.
- **DRIVEACQUIRERETRY**  
The DRIVEACQUIRERETRY option lets you specify how many times the server retries the acquisition of a drive in an IBM 349x library. If the library is shared among multiple applications, its drives may appear to be available to the server (through the use of a background polling process) when they are not.
- **ENABLENASDEDUP**  
The ENABLENASDEDUP server option specifies whether the server deduplicates data that is stored by a network-attached storage (NAS) file server. This option applies only to NetApp file servers.

- **EVENTSERVER**  
The **EVENTSERVER** option specifies whether at startup the server should try to contact the event server.
- **EXPINTERVAL**  
The **EXPINTERVAL** option specifies the interval, in hours, between automatic inventory expiration processes by IBM Spectrum Protect. Inventory expiration removes client backup and archive file copies from the server as specified by the management classes to which the client files are bound. If expiration is not run periodically, storage pool space is not reclaimed from expired client files, and the server requires more storage space than required by policy.
- **EXPQUIET**  
The **EXPQUIET** option specifies whether IBM Spectrum Protect sends detailed messages during expiration processing.
- **Linux | Windows** **FASPBEGPORT**  
The **FASPBEGPORT** option specifies the starting number in the range of port numbers that are used for network communications with Aspera® Fast Adaptive Secure Protocol (FASP®) technology.
- **Linux | Windows** **FASPENDPORT**  
The **FASPENDPORT** option specifies the ending number in the range of port numbers that are used for network communications with Aspera Fast Adaptive Secure Protocol (FASP) technology.
- **Linux | Windows** **FASPTARGETRATE**  
The **FASPTARGETRATE** option specifies the target rate for data transfer with Aspera Fast Adaptive Secure Protocol (FASP) technology. By specifying the target rate, you limit the bandwidth of each network connection that uses Aspera FASP technology. In this way, you can ensure that sufficient bandwidth is available for all network connections.
- **FFDCLOGLEVEL**  
The **FFDCLOGLEVEL** option specifies the type of general server messages that are displayed in the first failure data capture (FFDC) log.
- **FFDCLOGNAME**  
The **FFDCLOGNAME** option specifies a name for the first failure data capture (FFDC) log.
- **FFDCMAXLOGSIZE**  
The **FFDCMAXLOGSIZE** option specifies the size for the first failure data capture (FFDC) log file.
- **FFDCNUMLOGS**  
The **FFDCNUMLOGS** option specifies the number of log files that can be used for circular logging. The default value is 10.
- **FILEEXIT**  
The **FILEEXIT** option specifies a file to which enabled events are routed. Each logged event is a record in the file.
- **FILETEXTEXIT**  
The **FILETEXTEXIT** option specifies a file to which enabled events are routed. Each logged event is a fixed-size, readable line.
- **FSUSEDTHRESHOLD**  
The **FSUSEDTHRESHOLD** option specifies what percentage of the file system can be filled up by the database before an alert message is issued.
- **IDLETIMEOUT**  
The **IDLETIMEOUT** option specifies the amount of time, in minutes, that a client session can be idle before the server cancels the session. You may want to increase the time-out value to prevent clients from timing out if there is a heavy network load in your environment. Note, however, that a large number of idle sessions could prevent other users from connecting to the server.
- **KEEPALIVE**  
The **KEEPALIVE** option specifies whether the Transmission Control Protocol (TCP) keepalive function is enabled for outbound TCP sockets. The TCP keepalive function sends a transmission from one device to another to check that the link between the two devices is operating.
- **KEEPALIVETIME**  
The **KEEPALIVETIME** option specifies how often TCP sends a keepalive transmission when it receives a response. This option applies only if you set the **KEEPALIVE** option to **YES**.
- **KEEPALIVEINTERVAL**  
The **KEEPALIVEINTERVAL** option specifies how often a keepalive transmission is sent if no response is received. This option applies only if you set the **KEEPALIVE** option to **YES**.
- **LANGUAGE**  
The **LANGUAGE** option controls the initialization of locales. A locale includes the language and the date, time, and number formats to be used for the console and server.
- **LDAPCACHEDURATION**  
The **LDAPCACHEDURATION** option determines the amount of time that the IBM Spectrum Protect server caches LDAP password authentication information.
- **LDAPURL**  
The **LDAPURL** option specifies the location of a Lightweight Directory Access Protocol (LDAP) server. Set the **LDAPURL** option after you configure the LDAP server.
- **MAXSESSIONS**  
The **MAXSESSIONS** option specifies the maximum number of simultaneous client sessions that can connect with the

- server.
- MESSAGEFORMAT  
The MESSAGEFORMAT option specifies whether a message number is displayed in all lines of a multi-line message.
- MIRRORLOGDIRECTORY  
The MIRRORLOGDIRECTORY option specifies the directory for mirroring the active log path.
- MOVEBATCHSIZE  
The MOVEBATCHSIZE option specifies the number of client files that are to be moved and grouped together in a batch, within the same server transaction. This data movement results from storage pool backups and restores, migration, reclamation, and MOVE DATA operations. This option works with the MOVESIZETHRESH option.
- MOVESIZETHRESH  
The MOVESIZETHRESH option specifies, in megabytes, a threshold for the amount of data moved as a batch, within the same server transaction. When this threshold is reached, no more files are added to the current batch, and a new transaction is started after the current batch is moved.
- MSGINTERVAL  
The MSGINTERVAL option specifies the time, in minutes, between messages prompting an operator to mount a tape for the server.
- **Windows** NAMEDPIPENAME  
The NAMEDPIPENAME option specifies a communication method that allows processes to communicate with one another without having to know where the sender and receiver processes are located. The name acts like an alias, connecting the two processes regardless of whether they are on the same computer or across connected domains.
- NDMPCONNECTIONTIMEOUT  
The NDMPCONNECTIONTIMEOUT server option specifies the time in hours that IBM Spectrum Protect server waits to receive status updates during NDMP restore operations across the LAN. NDMP restore operations of large NAS file systems can have long periods of inactivity. The default is 6 hours.
- NDMPCONTROLPORT  
The NDMPCONTROLPORT option specifies the port number to be used for internal communications for certain Network Data Management Protocol (NDMP) operations. The IBM Spectrum Protect server does not function as a general purpose NDMP tape server.
- NDMPENABLEKEEPALIVE  
The NDMPENABLEKEEPALIVE server option specifies whether the IBM Spectrum Protect server enables Transmission Control Protocol (TCP) keepalive on network data-management protocol (NDMP) control connections to network-attached storage (NAS) devices. The default is NO.
- **AIX** **Linux** **Windows** NDMPKEEPIDLEMINUTES  
The NDMPKEEPIDLEMINUTES server option specifies the amount of time, in minutes, before the operating system transmits the first Transmission Control Protocol (TCP) keepalive packet on a network data-management protocol (NDMP) control connection. The default is 120 minutes.
- NDMPPORTRANGE  
The NDMPPORTRANGE option specifies the range of port numbers through which IBM Spectrum Protect cycles to obtain a port number for accepting a session from a network-attached storage (NAS) device for data transfer. The default is 0,0 which means that IBM Spectrum Protect lets the operating system provide a port (ephemeral port).
- NDMPREFDATAINTERFACE  
This option specifies the IP address that is associated with the interface in which you want the server to receive all Network Data Management Protocol (NDMP) backup data.
- NOPREEMPT  
The server allows certain operations to preempt other operations for access to volumes and devices. You can specify the NOPREEMPT option to disable preemption. When preemption is disabled, no operation can preempt another for access to a volume, and only a database backup operation can preempt another operation for access to a device.
- NORETRIEVEDATE  
The NORETRIEVEDATE option specifies that the server does not update the retrieve date of a file in a disk storage pool when a client restores or retrieves the file. This option and the MIGDELAY storage pool parameter control when the server migrates files.
- **Windows** NPAUDITFAILURE  
The NPAUDITFAILURE option specifies whether an event is sent to the event log when a node logs in to the server using a name that is in the Windows group but does not match the Windows account login name. To ensure that a node can access only its own data, the node name and the Windows account name must match.
- **Windows** NPAUDITSUCCESS  
The NPAUDITSUCCESS option specifies that an event is sent to the event log when a client node user is authenticated for access to the server through SECUREPIPE.
- **Windows** NPBUFFERSIZE  
The NPBUFFERSIZE option specifies the size of the Named Pipes communication buffer.
- **Windows** NUMBERFORMAT  
The NUMBERFORMAT option specifies the format in which the server displays numbers.



- **NUMOPENVOLSALLOWED**  
The NUMOPENVOLSALLOWED option specifies the number of input FILE volumes in a deduplicated storage pool that can be open at one time.
- **PUSHSTATUS**  
The PUSHSTATUS option is used on spoke servers to ensure that status information is sent to the hub server. Do not update this option unless you must restore the Operations Center configuration to the preconfigured state where the IBM Spectrum Protect servers are not defined as hub or spoke servers.
- **QUERYAUTH**  
The QUERYAUTH option specifies the administrative authority level required to issue QUERY or SQL SELECT commands. By default any administrator can issue QUERY and SELECT commands. You can use this option to restrict the use of these commands.
- **RECLAIMDELAY**  
This option delays the reclamation of a SnapLock volume, allowing remaining data to expire so that there is no need to reclaim the volume.
- **RECLAIMPERIOD**  
This option allows you to set the number of days for the reclamation period of a SnapLock volume.
- **REORGBEGINTIME**  
The REORGBEGINTIME option specifies the earliest time that the IBM Spectrum Protect server can start a table or index reorganization.
- **REORGDURATION**  
The REORGDURATION option specifies an interval during which server-initiated table or index reorganization can start.
- **REPORTRETRIEVE**  
The REPORTRETRIEVE option reports on restore or retrieve operations that are performed by client nodes or administrators. The default is NO.
- **REPLBATCHSIZE**  
The REPLBATCHSIZE option specifies the number of client files that are to be replicated in a batch, within the same server transaction. This option affects only the node replication processes and works with the REPLSIZETHRESH option to improve node replication processing.
- **REPLSIZETHRESH**  
The REPLSIZETHRESH option specifies, in megabytes, a threshold for the amount of data replicated, within the same server transaction.
- **REQSYSAUTHOUTFILE**  
The REQSYSAUTHOUTFILE option specifies if system authority is required for administrative commands that cause IBM Spectrum Protect to write to an external file.
- **RESOURCE TIMEOUT**  
The RESOURCE TIMEOUT option specifies how long the server waits for a resource before canceling the pending acquisition of a resource. When a timeout occurs the request for the resource will be canceled.
- **RESTOREINTERVAL**  
The RESTOREINTERVAL option specifies how long a restartable restore session can be saved in the server database. As long as the restore session is saved in the database, it can be restarted from the point at which it stopped.
- **RETENTIONEXTENSION**  
The RETENTIONEXTENSION option specifies the number of days to extend the retention date of a SnapLock volume. This option allows the server to extend the retention date of a SnapLock volume in order to avoid excessive reclamation.
- |     |       |         |
|-----|-------|---------|
| AIX | Linux | Windows |
|-----|-------|---------|

**SANDISCOVERY**  
The SANDISCOVERY option specifies whether the IBM Spectrum Protect SAN discovery function is enabled.
- |     |       |         |
|-----|-------|---------|
| AIX | Linux | Windows |
|-----|-------|---------|

**SANDISCOVERYTIMEOUT**  
The SANDISCOVERYTIMEOUT option specifies the amount of time allowed for host bus adapters to respond when they are queried by the SAN discovery process. Once the time specified for the SANDISCOVERYTIMEOUT is reached, the process times out.
- |     |       |         |
|-----|-------|---------|
| AIX | Linux | Windows |
|-----|-------|---------|

**SANREFRESHTIME**  
The SANREFRESHTIME option specifies the amount of time that elapses before the cached SAN discovery information is refreshed. The SANREFRESHTIME option has a default value of 0, which means that there is no SAN discovery cache. The information is obtained directly from the host bus adapter (HBA) every time the server performs a SAN discovery operation.
- **SEARCHMPQUEUE**  
The SEARCHMPQUEUE option specifies the order in which the server satisfies requests in the mount queue. If the option is specified, the server first tries to satisfy requests for volumes that are already mounted. These requests may be satisfied before other requests, even if the others have been waiting longer for the mount point. If this option is not specified, the server satisfies requests in the order in which they are received.
- |         |
|---------|
| Windows |
|---------|

**SECUREPIPES**  
When using the named pipes protocol, enabling SECUREPIPES forces the server to check the Windows group designated by ADSMGROUPNAME in order to authenticate a client node/user.



- **SERVERDEDUPTXNLIMIT**  
The SERVERDEDUPTXNLIMIT option specifies the maximum size of objects that can be deduplicated on the server.
- **SHMPORT**  

AIX	Linux
-----	-------

 The SHMPORT option specifies the TCP/IP port address of a server when using shared memory. All shared memory communications start with a TCP/IP connection.
 

Windows
---------

 The SHMPORT option specifies the port that the server listens on for shared memory connections.
- **SHREDDING**  
The SHREDDING option specifies whether shredding of deleted sensitive data is performed automatically or manually. Shredding applies only to data in storage pools that have been explicitly configured to support shredding.
- **SNMPHEARTBEATINTERVAL**  
The SNMPHEARTBEATINTERVAL option specifies the interval in minutes between queries of the IBM Spectrum Protect server.
- **SNMPMESSAGECATEGORY**  
The SNMPMESSAGECATEGORY option specifies the trap types used when messages are forwarded from the server, through the Simple Network Management Protocol (SNMP) subagent, to the SNMP manager.
- **SNMPSUBAGENT**  
The SNMPSUBAGENT option specifies the parameters needed for the IBM Spectrum Protect subagent to communicate with the Simple Network Management Protocol (SNMP) daemon. This option is only to configure the SNMP subagent for communicating with the SNMP agent; it is ignored by the server.
- **SNMPSUBAGENTHOST**  
The SNMPSUBAGENTHOST option specifies the location of the IBM Spectrum Protect Simple Network Management Protocol (SNMP) subagent. The default for this option is 127.0.0.1.
- **SNMPSUBAGENTPORT**  
The SNMPSUBAGENTPORT option specifies the port number of the IBM Spectrum Protect Simple Network Management Protocol (SNMP) subagent.
- **SSLFIPSMODE**  
The SSLFIPSMODE option specifies whether the Federal Information Processing Standards (FIPS) mode is in effect for Secure Sockets Layer (SSL). The default is NO.
- **SSLINITTIMEOUT**  
The SSLINITTIMEOUT option specifies the time, in minutes, that the server waits for a Secure Sockets Layer (SSL) session to complete initialization before the server cancels the session.
- **SSLTCPADMINPORT**  
The SSLTCPADMINPORT option specifies the port address on which the server TCP/IP communication driver waits for requests for SSL-enabled sessions only. The sessions are for the command-line administrative client.
- **SSLTCPPOINT**  
The SSLTCPPOINT option specifies the Secure Sockets Layer (SSL) port number for SSL-enabled sessions only. The server TCP/IP communication driver waits for requests on this port for SSL-enabled sessions from the client.
- **TCPADMINPORT**  
The TCPADMINPORT option specifies the port number on which the server TCP/IP communication driver waits for requests for TCP/IP and SSL-enabled sessions other than client sessions. This includes administrative sessions, server-to-server sessions, storage agent sessions, library client sessions, managed server sessions, and event server sessions.
- |     |       |
|-----|-------|
| AIX | Linux |
|-----|-------|

**TCPBUFSIZE**  
 The TCPBUFSIZE option specifies the size of the buffer used for TCP/IP send requests. During a restore, client data moves from the IBM Spectrum Protect session component to a TCP communication driver. The TCPBUFSIZE option determines if the server sends the data directly from the session buffer or copies the data to the TCP buffer. A 32 KB buffer size forces the server to copy data to its communication buffer and flush the buffer when it fills.
- **TCPNODELAY**  
The TCPNODELAY option specifies whether the server disables the delay of sending successive small packets on the network.
- **TCPPORT**  
The TCPPORT option specifies the port number on which the server TCP/IP communication driver waits for requests for client sessions. The server TCP/IP communication driver listens on this port for both TCP/IP and SSL-enabled sessions from the client.
- **TCPWINDOWSIZE**  
The TCPWINDOWSIZE option specifies, in kilobytes, the amount of receive data that can be buffered at one time on a TCP/IP connection. The sending host cannot send more data until it receives an acknowledgment and a TCP receive window update. Each TCP packet contains the advertised TCP receive window on the connection. A larger window lets the sender continue sending data, and may improve communication performance, especially on fast networks with high latency.
- **TECBEGINEVENTLOGGING**  
The TECBEGINEVENTLOGGING option specifies whether event logging for the Tivoli® receiver should begin when the server starts up. If the TECHOST option is specified, TECBEGINEVENTLOGGING defaults to YES.

- **TECHOST**  
The TECHOST option specifies the host name or IP address for the Tivoli event server.
- **TECPORT**  
The TECPORT option specifies the TCP/IP port address on which the Tivoli event server is listening. This option is only required if the Tivoli event server is on a system that does not have a Port Mapper service running.
- **TECUTF8EVENT**  
The TECUTF8EVENT option allows the IBM Spectrum Protect administrator to send information to the Tivoli Enterprise Console® (TEC) server in UTF-8 data format. The default is No. You can display whether or not this option is enabled by issuing the QUERY OPTION command.
- **THROUGHPUTDATATHRESHOLD**  
The THROUGHPUTDATATHRESHOLD option specifies a throughput threshold that a client session must reach to prevent being canceled after the time threshold is reached.
- **THROUGHPUTTIMETHRESHOLD**  
The THROUGHPUTTIMETHRESHOLD option specifies the time threshold for a session after which it may be canceled for low throughput.
- **Windows** **TIMEFORMAT**  
The TIMEFORMAT option specifies the format in which time is displayed by the server.
- **TXNGROUPMAX**  
The TXNGROUPMAX option specifies the number of objects that are transferred as a group between a client and the server between transaction commit points. The minimum value is 4 objects and the maximum value is 65000 objects. The default value is 4096 objects. The objects transferred are actual files, directories, or both. The server counts each file or directory as one object.
- **UNIQUETDPTEEVENTS**  
The UNIQUETDPTEEVENTS option generates a unique Tivoli Enterprise Console (TEC) event class for each individual IBM Spectrum Protect message, including client, server, and IBM Spectrum Protect Data Protection client messages. The default is No.
- **UNIQUETECEVENTS**  
The UNIQUETECEVENTS option generates a unique Tivoli Enterprise Console (TEC) event class for each individual IBM Spectrum Protect message. The default is No.
- **USEREXIT**  
The USEREXIT option specifies a user-defined exit that will be given control to manage an event.
- **VERBCHECK**  
The VERBCHECK option specifies that the server will do additional error checking on the structure of commands sent by the client. This option should only be enabled when the client sends incorrectly formed requests to the server, causing the server to crash. When this option is enabled, you will get a protocol error instead of a server crash.
- **VOLUMEHISTORY**  
The VOLUMEHISTORY option specifies the name of files to be automatically updated whenever server sequential volume history information is changed. There is no default for this option.

## Modifying server options

---

The server reads the server options file at server initialization. When you update a server option by editing the file, you must stop and start the server to activate the updated server options file.

### About this task

---

You can change some options dynamically without stopping and starting the server, by using the SETOPT command. See SETOPT (Set a server option for dynamic update) for details.

**AIX** | **Linux** The dsmserv.opt.smp file (also provided at installation) contains the format of the options file and all the default settings. You can change any options in the dsmserv.opt.smp file. To have the server use the changed options, you must rename the file to dsmserv.opt. To activate an option within the server options file, remove the \*>>> that precedes the option. The server ignores any options preceded by \*>>>.

**Windows** You can modify server options by using the options file editor included in the IBM Spectrum Protect™ Console. This editor provides communications parameter detection, value validation, and help for all options. The options file editor is the preferred way to change server options, but you can also use a text editor.

## Types of server options

---

Server options let you customize how some functions and processes work.

- Server communication options  
You can use server options to specify server communication methods and their characteristics.
- Server storage options  
IBM Spectrum Protect provides a number of options that you can specify to configure certain device and server storage operations.
- Client-server options  
You can use server options to control client-server processing.
- Date, number, time, and language options  
You can use server options to specify display formats for the dates, times, numbers, and national language.
- Database options  
You can use server options to control some aspects of database processing.
- Data transfer options  
You can use server options to control how IBM Spectrum Protect groups and transfers data.
- Message options  
You can use server options to give you more flexibility in the way IBM Spectrum Protect issues messages.
- Event logging options  
Options can help you manage event logging receivers.
- Security options and licensing options  
You can use server options to customize server security and license audits.
- Miscellaneous options  
You can use a variety of miscellaneous server options to customize IBM Spectrum Protect.

## Server communication options

You can use server options to specify server communication methods and their characteristics.

Table 1. Communication options

Option	Description
ADMINCOMMTIMEOUT	The amount of time that the server waits for an administrative client message during an operation that causes a database update
ADMINIDLETIMEOUT	The amount of time an administrative client session can be idle
ADMINONCLIENTPORT	The port that determines whether administrative sessions can use the port specified in the TCPPORT option
COMMMETHOD	The server communication method
DBMTCPPOINT	The port number on which the TCP/IP communication driver for the database manager waits for client session requests
DNSLOOKUP	Control of use of Domain Name Services to lookup names of systems contacting the server
LDAPCACHEDURATION	Determines the amount of time that authentication sessions, to the same node or administrator, are skipped. You might see a slight performance boost when skipping sessions.
LDAPURL	Specifies the LDAP directory server. Each setting must have the LDAP directory server name, a port number, and the base distinguished name of the namespace or suffix that the server maintains.
<b>Windows</b> NAMEDPIPENAME	<b>Windows</b> The named pipes communication method







Option	Description
NDMPCONTROLPORT	The internal communications port used for certain Network Data Management Protocol (NDMP) operations
NDMPENABLEKEEPALIVE	The TCP keepalive mechanism
<b>AIX</b>   <b>Linux</b>   <b>Windows</b> NDMPKEEPIDLEMINUTES	<b>AIX</b>   <b>Linux</b>   <b>Windows</b> The amount of idle time before the first TCP keepalive packet is sent
<b>Windows</b> NPBUFFERSIZE	<b>Windows</b> The size of the Named Pipes communication buffer
SHMPORT	<b>AIX</b>   <b>Linux</b> The TCP/IP port address of a server when using shared memory  <b>Windows</b> The port that the server listens on for shared memory connections
SNMPHEARTBEATINTERVAL	The interval in minutes between queries of the IBM Spectrum Protect server
SNMPMESSAGECATEGORY	The trap types used when messages are forwarded from the server
SNMPSUBAGENT	The parameters needed for the IBM Spectrum Protect subagent to communicate with the SNMP daemon
SNMPSUBAGENTHOST	The location of the IBM Spectrum Protect SNMP subagent
SNMPSUBAGENTPORT	The port address of the IBM Spectrum Protect SNMP subagent
SSLFIPSMODE	Specifies whether the Federal Information Processing Standards (FIPS) mode is in effect for Secure Sockets Layer (SSL)
SSLTCPADMINPORT	The port address on which the server's TCP/IP communication driver waits for requests for SSL-enabled sessions for the command-line administrative client
SSLTCPPOINT	The SSL-only port number on which the server's TCP/IP communication driver waits for requests for SSL-enabled sessions from the following sources: <ul style="list-style-type: none"> <li>• Command line backup-archive client</li> <li>• Backup-archive GUI</li> <li>• Administrative client</li> <li>• Application programming interface (API)</li> </ul>
TCPADMINPORT	The TCP/IP port number for administrative sessions
<b>AIX</b>   <b>Linux</b> TCPBUFSIZE	<b>AIX</b>   <b>Linux</b> The size of the buffer used for TCP/IP send requests
TCPPORT	The TCP/IP port number for client sessions

Option	Description
TCPWINDOWSIZE	The client node TCP/IP sliding window

## Server storage options

IBM Spectrum Protect™ provides a number of options that you can specify to configure certain device and server storage operations.

Table 1. Server storage options

Option	Description
3494SHARED	Enables sharing of a 3494 library with applications other than IBM Spectrum Protect.
ACSACCESSID	The ID for the ACS access control.
ACSLCKDRIVE	Allows the drives within the ACSLS libraries to be locked.
ACSQUICKINIT	Allows a quick or full initialization of the ACSLS library.
ACSTIMEOUTX	The multiple for the built-in timeout value for the ACSLS API.
ASSISTVCRRECOVERY	Specifies whether the server assists an IBM 3590 drive in recovering from a lost or corrupted Vital Cartridge Records (VCR) condition.
CHECKTAPEPOS	Specifies whether the server validates data position on tape.
CLIENTDEDUPTXNLIMIT	Specifies the maximum size of a transaction when client-side deduplicated data is backed up or archived.
DEDUPREQUIRESBACKUP	Specifies whether volumes in primary sequential-access storage pools that are set up for data deduplication can be reclaimed and whether duplicate data can be discarded before the storage pools are backed up.
DEDUPTIER2FILESIZE	File size at which Tier 2 processing is used for data deduplication.
DEDUPTIER3FILESIZE	File size at which Tier 3 processing is used for data deduplication.
DEVCONFIG	The name of the file that store backup copies of device configuration information.
DRIVEACQUIRERETRY	The number of times that the server retries the acquisition of a drive in an IBM 349x library that is shared among multiple applications.
ENABLENASDEDUP	Specifies whether the server deduplicates data that is stored by a NetApp network-attached storage (NAS) file server.
NUMOPENVOLSALLOWED	The number of input FILE volumes in a deduplicated storage pool that can be open at one time.
RECLAIMDELAY	The number of days that the reclamation of a SnapLock volume is delayed.
RECLAIMPERIOD	The number of days for the reclamation period of a SnapLock volume
RESOURCETIMEOUT	The length of time that the server waits for a resource before canceling the pending acquisition of the resource.
RETENTIONEXTENSION	The number of days to extend the retention date of a SnapLock volume.
 SANDISCOVERY	 Whether the IBM Spectrum Protect SAN discovery function is enabled.
 SANDISCOVERYTIMEOUT	 Amount of time before the SAN discovery process times out.
 SANREFRESHTIME	 Amount of time before cached SAN discovery information is refreshed.
SEARCHMPQUEUE	The order in which the server satisfies requests in the mount queue.
SERVERDEDUPTXNLIMIT	Specifies the maximum size of objects that can be deduplicated on the server.

## Client-server options

You can use server options to control client-server processing.

Table 1. Client-Server options

Option	Description
COMMTIMEOUT	The number of seconds the server waits for a response from a client before timing out the client session
DISABLESCHEDS	Whether administrative and client schedules are disabled during the IBM Spectrum Protect server recovery scenario
IDLETIMEOUT	The number of minutes the server allows a client session to remain idle before timing out the client session
MAXSESSIONS	The maximum number of simultaneous client sessions with the server
THROUGHPUTDATATHRESHOLD	The throughput threshold that a client session must reach to prevent being canceled after the time threshold is reached
THROUGHPUTTIMETHRESHOLD	The time threshold for a session after which it may be canceled for low throughput
VERBCHECK	Whether additional error checking is done for commands sent by the client

## Date, number, time, and language options

You can use server options to specify display formats for the dates, times, numbers, and national language.

Table 1. Date, number, time, and language options

Option	Description
<b>Windows</b> DATEFORMAT	<b>Windows</b> The format by which dates are displayed
LANGUAGE	The national language is used to present client messages
<b>Windows</b> NUMBERFORMAT	<b>Windows</b> The format for displaying numbers
<b>Windows</b> TIMEFORMAT	<b>Windows</b> The format displaying times

## Database options

You can use server options to control some aspects of database processing.

Table 1. Database options

Option	Description
ACTIVELOGDIRECTORY	The new directory for the location where the active log is stored. Use this option to change the location of the active log.
ACTIVELOGSIZE	The maximum size of the active log.
ALLOWREORGINDEX	Server-initiated index reorganization.
ALLOWREORGTABLE	Server-initiated table reorganization.
ARCHLOGDIRECTORY	The directory that the database manager can archive a log file into after all the transactions represented in that log file are completed.
ARCHFAILOVERLOGDIRECTORY	The directory in which the server tries to store archive log files that cannot be stored in the archive log directory.
DBDIAGLOGSIZE	The maximum size of the database manager diagnostic log files.
DBDIAGPATHFSTHRESHOLD	The threshold for free space on the file system or disk that contains the database manager diagnostic log files.
DBMEMPERCENT	The percentage of system memory that is dedicated to the database.
DISABLEREORGTABLE	Disables table reorganization for specific tables.

Option	Description
FSUSEDTHRESHOLD	The percentage of the file system that can be used by the database before an alert message is issued.
MIRRORLOGDIRECTORY	The directory for mirroring the active log path.
REORGBEGINTIME	The earliest time that the IBM Spectrum Protect server can start a table or index reorganization.
REORGDURATION	The interval during which server-initiated table or index reorganization can start.

## Data transfer options

You can use server options to control how IBM Spectrum Protect™ groups and transfers data.

Table 1. Group options

Option	Description
MOVEBATCHSIZE	The number of files that are to be moved and grouped in a batch, within a transaction
MOVESIZETHRESH	The threshold for the amount of data moved as a batch, within the same server transaction
NDMPPORTRANGE	The IP address associated with the interface in which the server receives all Network Data Management Protocol (NDMP) backup data
NDMPREFDATAINTERFACE	The IP address associated with the interface in which the server receives all Network Data Management Protocol (NDMP) backup data
REPLBATCHSIZE	The number of files that are to be replicated in a batch, within the same server transaction
REPLSIZETHRESH	The threshold for the amount of data replicated as a batch, within the same server transaction
TXNGROUPMAX	The number of files that are transferred as a group between a client and the server between transaction commit points

## Message options

You can use server options to give you more flexibility in the way IBM Spectrum Protect™ issues messages.

Table 1. Message options

Option	Description
EXPQUIET	Whether IBM Spectrum Protect sends detailed informational messages during expiration processing
MESSAGEFORMAT	Whether a message number is displayed in all lines of a multi-line message
MSGINTERVAL	The time, in minutes, between messages prompting an operator to mount a tape for IBM Spectrum Protect

## Event logging options

Options can help you manage event logging receivers.

Table 1. Event logging options

Option	Description
EVENTSERVER	Whether the server should try to contact the event server when the server starts up
FILEEXIT	A file to which enabled events are routed (binary format)
FILETEXTEXIT	A file to which enabled events are routed (readable format)

Option	Description
REPORTRETRIEVE	Record client restore and retrieve operations
TECBEGINEVENTLOGGING	Whether event logging for the TIVOLI receiver should begin when the server starts up
TECHOST	The host name or IP address for the Tivoli Enterprise Console (TEC) event server
TECPORT	The TCP/IP port address on which the Tivoli Enterprise Console event server is listening
TECUTF8EVENT	A Tivoli Enterprise Console event sent from the IBM Spectrum Protect server in UTF8 format
UNIQUETDPTCEVENTS	Events from an IBM Spectrum Protect Data Protection client that are sent to the Tivoli Enterprise Console as unique events
UNIQUETECEVENTS	Events sent to the Tivoli Enterprise Console as unique
USEREXIT	A user-defined exit that will be given control to manage an event

## Security options and licensing options

You can use server options to customize server security and license audits.

Table 1. Security and licensing options

Option	Description
<b>Windows</b> ADMSGROUPNAME	<b>Windows</b> The name of a Windows group
AUDITSTORAGE	Specifies that during a license audit operation, the server calculates, by node, the amount of backup, archive, and space management storage in use
BACKUPINITIATIONROOT	Specifies whether the server overrides node parameter values for users who are not IBM Spectrum Protect authorized users
LDAPURL	Specifies the LDAP directory server. Each setting must have the LDAP directory server name, a port number, and the base distinguished name of the namespace or suffix that the server maintains.
<b>Windows</b> NPAUDITFAILURE	<b>Windows</b> Specifies that a node can access only its own data
<b>Windows</b> NPAUDITSUCCESS	<b>Windows</b> Specifies that an event is sent to the event log when a client node user is authenticated for access to the server through SECUREPIPE
QUERYAUTH	The administrative authority level required to issue QUERY or SQL SELECT commands
REQSYSAUTHOUTFILE	Specifies if system authority is required for administrative commands that cause IBM Spectrum Protect to write to an external file
<b>Windows</b> SECUREPIPES	<b>Windows</b> With named pipes protocol, specifies that the server checks the Windows group to authenticate a client
SHREDDING	Specifies whether shredding of deleted sensitive data is done automatically or manually

**Related reference:**

Server communication options

## Miscellaneous options

You can use a variety of miscellaneous server options to customize IBM Spectrum Protect™.

Table 1. Miscellaneous options

Option	Description
--------	-------------



Option	Description
ALIASHALT	Allows administrators to give the IBM Spectrum Protect HALT command a different name
DISPLAYLFINFO	Specifies whether accounting records and summary table entries report the storage agent name
EXPINTERVAL	The interval between automatic inventory expiration processes
FFDCLOGNAME	The name for the first failure data capture (FFDC) log
FFDCMAXLOGSIZE	The maximum size of the first failure data capture (FFDC) log
NOPREEMPT	Specifies that no operation can preempt another for access to a volume and that only a database backup operation can preempt another operation for access to a device
NORETRIEVEDATE	Specifies that the server does not update the retrieve date of a file in a disk storage pool when a client restores or retrieves the file
RESTOREINTERVAL	The length of time that a restartable restore session can be saved in the server database
VOLUMEHISTORY	The name of the file to be automatically updated whenever server sequential volume history information is changed

## 3494SHARED

The 3494SHARED option specifies whether an IBM® 3494 library can share applications other than IBM Spectrum Protect™.

The default is NO, meaning that no application other than IBM Spectrum Protect can share the 3494. When you set this option to YES, for every mount request, IBM Spectrum Protect determines if each drive is in use. After the query completes, IBM Spectrum Protect selects an available drive that is not in use by another application. Enable sharing only if you have more than two drives in your library. If you are currently sharing an IBM 3494 library with other applications, you must specify this option.

### Syntax

```
>>-3494SHARED--+-Yes-+-----<<
          '-No--'
```

### Parameters

- Yes  
Specifies that other applications can share the 3494 library.
- No  
Specifies that no other applications can share the 3494 library.

### Examples

Enable sharing of a 3494 library:

```
3494shared yes
```

## ACSACCESSID

---

The ACSACCESSID option specifies the ID for the ACS access control for an ACSLS library.

### Syntax

---

```
>>-ACSACCESSID--name-----<<
```

### Parameters

---

name

Specifies a 1 to 64 character ID. The default ID is your local host name.

### Examples

---

```
acsaccessid region
```

## ACSLOCKDRIVE

---

The ACSLOCKDRIVE option specifies if the drives within the ACSLS libraries are locked. Drive locking ensures the exclusive use of the drive in the ACSLS library in a shared environment. However, there is some performance gain if libraries are not locked. When other applications do not share the IBM Spectrum Protect™ drives, drive locking is not required.

### Syntax

---

```
>>-ACSLOCKDRIVE--+-Yes-+-----<<  
                '-No--'
```

### Parameters

---

Yes

Specifies that drives are locked.

No

Specifies that drives are not locked.

### Examples

---

```
acslockdrive yes
```

## ACSQUICKINIT

---

The ACSQUICKINIT option specifies whether, at server startup, the initialization of the ACSLS library is a quick or full initialization. The default is Yes. A quick initialization avoids the overhead associated with synchronizing the IBM Spectrum Protect™ server inventory with the ACSLS library inventory (through an audit of the library).

### Syntax

---

```
>>-ACSQUICKINIT--+-Yes-+-----<<  
                '-No--'
```

### Parameters

---

Yes

Specifies that a quick initialization of the ACSLS library is performed. When the option is set to Yes, IBM Spectrum Protect bypasses library inventory verification, initializing the library quickly, and making it available to IBM Spectrum Protect sooner than if a full initialization is done.

This option should be set to Yes when it is known that the physical library inventory and the IBM Spectrum Protect library inventory have not changed and an audit is not needed.

No

Specifies that a full initialization of the ACSLS library and library inventory is performed. When the option is set to No, IBM Spectrum Protect synchronizes its library volume inventory with what is reported by the ACSLS library manager.

## Examples

---

```
acsquickinit yes
```

## ACSTIMEOUTX

---

The ACSTIMEOUTX option specifies the multiple for the built-in timeout value for ACSLS APIs. The built-in timeout value for the ENTER, EJECT, and AUDIT ACS API is 1800 seconds; for all other ACSLS APIs it is 600 seconds. For example, if the multiple value specified is 5, the timeout value for audit API becomes 9000 seconds, and all other APIs become 3000 seconds.

## Syntax

---

```
>>-ACSTIMEOUTX--value-----<<
```

## Parameters

---

value

Specifies the multiple for the built-in timeout value for ACSLS API. The range is from 1 to 100. The default is 1.

## Examples

---

```
acstimeoutx 1
```

## ACTIVELOGDIRECTORY

---

The ACTIVELOGDIRECTORY option specifies the name of the directory where all active logs are stored.

This option is appended to the options file when the DSMSEV FORMAT command is run. Under normal operating conditions, the option does not need to be changed. See DSMSEV FORMAT (Format the database and log) for guidance on this option.

## Syntax

---

```
>>-ACTIVELOGDirectory--dir_name-----<<
```

## Parameters

---

dir\_name

Specifies a fully qualified directory name. The directory must exist, it must be empty, and it must be accessible by the user ID of the database manager. If you change the active log directory, IBM Spectrum Protect™ moves the existing active logs to the location that is specified by this directory. The maximum number of characters is 175.

## Examples

---

```
  
activelogdirectory /tsm/activelogdir
```

```
activelogdirectory c:\tsmserv1\activelogdir
```

## ACTIVELOGSIZE

The ACTIVELOGSIZE option sets the total log size.

This option is appended to the options file when the DSMSERV FORMAT command is run. Under normal operating conditions the option does not need to be changed. See DSMSERV FORMAT (Format the database and log) for guidance on this option.

### Syntax

```
.-16GB-----.  
>>-ACTIVELOGSize--+-megabytes-+-----<<
```

### Parameters

megabytes

Specifies the size of the active log file in megabytes. The minimum value is 2048 MB (2 GB); the maximum is 524,288 MB (512 GB). If an odd number is specified, the value is rounded up to the next even number. The default is 16,384 MB (16 GB).

The size of an active log file is based on the value of the ACTIVELOGSIZE option. Guidelines for space requirements are in the following table:

Table 1. How to estimate volume and file space requirements

ACTIVELOGSize option value	Reserve this much free space in the active log directory, in addition to the ACTIVELOGSize space
16 GB - 128 GB	5120 MB
129 GB - 256 GB	10240 MB
257 GB - 512 GB	20480 MB

### Examples

```
activelogsize 8192
```

## ADMINCOMMTIMEOUT

The ADMINCOMMTIMEOUT option specifies how long the server waits for an expected administrative client message during an operation that causes a database update.

If the length of time exceeds this time-out period, the server ends the session with the administrative client. You may want to increase the time-out value to prevent administrative client sessions from timing out.

You can update this server option without stopping and restarting the server by using the SETOPT command. See SETOPT (Set a server option for dynamic update).

### Syntax

```
.-60-----.  
>>-ADMINCOMMTimeout--+-seconds-+-----<<
```

### Parameters

seconds

Specifies the maximum number of seconds that a server waits for an administrative client response. The default value is 60. The minimum value is 1.

## Examples

---

```
admincommtimeout 60
```

## ADMINIDLETIMEOUT

---

The ADMINIDLETIMEOUT option specifies the amount of time, in minutes, that an administrative client session can be idle before the server cancels the session.

If there is a heavy network load in your environment, you might want to increase the time-out value to prevent administrative clients from timing out. However, a large number of idle sessions could prevent other users from connecting to the server.

You can update this server option without stopping and restarting the server by using the SETOPT command. See SETOPT (Set a server option for dynamic update).

## Syntax

---

```
                .-15-----.  
>>-ADMINIDLETIMEOUT--+-minutes+-----<<
```

## Parameters

---

minutes

Specifies the maximum number of minutes that a server waits for an idle administrative client. The default value is 15 minutes. The minimum value is 1 minute.

## Examples

---

```
adminidletimeout 20
```

## ADMINONCLIENTPORT

---

The ADMINONCLIENTPORT option specifies whether the TCPPOINT can be used by administrative sessions. The default is YES.

## Syntax

---

```
>>-ADMINONCLIENTPORT--+-YES+-----<<  
                        '-NO--'
```

## Parameters

---

YES

If the option is set to YES, or if the TCPPOINT and TCPADMINPORT are the same value (the default), administrative sessions can use the TCPPOINT.

NO

If the option is set to NO, and if the TCPADMINPORT value is different than the TCPPOINT value, administrative sessions cannot use the TCPPOINT.

## Examples

---

Specify that the TCPPOINT can be used by administrative sessions.

```
adminonclientport yes
```

**Windows**

## ADSMGROUPNAME

---

The ADMSGROUPNAME option specifies the name of a Windows group. A client node must be a member of this group to use the IBM Spectrum Protect™ server through NT Unified Logon. The client node must also be a registered IBM Spectrum Protect client node.

## Syntax

---

```
>>-ADMSGROUPname--group_name-----><
```

## Parameters

---

group\_name  
Specifies a Windows group name.

## Examples

---

Specify IDD as a Windows group:

```
adsmgroup idd
```

## ALIASHALT

---

The ALIASHALT option allows administrators to give the IBM Spectrum Protect™ **HALT** command a different name.

The administrative client recognizes an alias for the HALT command when the client is started with the CHECKALIASHALT option specified. See Administrative client options for details.

## Syntax

---

```
>>-ALIASHALT--newname-----><
```

## Parameters

---

newname  
Specifies the alias of the HALT command for shutting down the IBM Spectrum Protect server. Minimum length of *newname* is 1; maximum length is 16.

## Examples

---

```
aliashalt tsmhalt
```

## ALLOWDESAUTH

---

The ALLOWDESAUTH option specifies whether to allow use of the Data Encryption Standard (DES) algorithm for authentication between a server and a backup-archive client.

To prevent the use of DES, specify a value of NO for the ALLOWDESAUTH option.

To configure the IBM Spectrum Protect™ server to be in compliance with the NIST SP800-131A standard, set this option to NO. Restrictions:

- The backup-archive client must be running Version 6.3 or later if you authenticate to a server with the ALLOWDESAUTH option set to NO.
- Automatic deployment of the backup-archive client fails if this option is set to NO.

## Syntax

---

```
.-ALLOWDESAUTH--Yes-----.  
>>+-----+-----><  
'-ALLOWDESAUTH---+No---+'
```

'-Yes-'

## Parameters

---

Yes

Specifies that the server allows authentication with any backup-archive clients that use DES-based encryption. The default is YES.

No

Specifies that the server rejects any backup-archive clients that attempt to authenticate with DES-based encryption.

## Examples

---

Specify that the server rejects any backup-archive clients that attempt to authenticate with DES encryption:

```
allowdesauth no
```

Specify that the server allows authentication with any backup-archive clients that use DES encryption:

```
allowdesauth yes
```

## ALLOWREORGINDEX

---

The ALLOWREORGINDEX option specifies whether server-initiated index reorganization is enabled or disabled.

The default is YES.

## Syntax

---

```
>>-ALLOWREORGINDEX---+-Yes-+-----<<  
                        '-No--'
```

## Parameters

---

Yes

Specifies that server-initiated index reorganization is enabled.

No

Specifies that server-initiated index reorganization is disabled.

## Example

---

Specify that server-initiated index reorganization is enabled.

```
allowreorgindex yes
```

## ALLOWREORGTABLE

---

The ALLOWREORGTABLE option specifies whether server-initiated table reorganization is enabled or disabled.

The default is YES.

## Syntax

---

```
>>-ALLOWREORGTABLE---+-Yes-+-----<<  
                        '-No--'
```

## Parameters

---

Yes

- Yes Specifies that server-initiated table reorganization is enabled.
- No Specifies that server-initiated table reorganization is disabled.

## Examples

---

Specify that server-initiated table reorganization is disabled.

```
allowreorgtable no
```

## ARCHFAILOVERLOGDIRECTORY

---

The ARCHFAILOVERLOGDIRECTORY option specifies the directory which the server uses to store archive log files that cannot be stored in the archive log directory.

This option is appended to the options file when the DSMSEV FORMAT command is run. Typically the directory does not need to be changed.

## Syntax

---

```
>>-ARCHFailoverlogdirectory--dir_name-----<<
```

## Parameters

---

dir\_name

Specifies a fully qualified directory name. The maximum number of characters is 175.

## Examples

---

AIX	Linux
archfailoverlogdirectory /tsm/archfailoverlog	
Windows	
archfailoverlogdirectory c:\tmserv1\archfailoverlog	

## ARCHLOGCOMPRESS

---

You can enable or disable compression of archive logs on the IBM Spectrum Protect™ server. By compressing the archive logs, you reduce the amount of space that is required for storage.

The ARCHLOGCOMPRESS server option specifies whether log files that are written to the archive directory for logs are compressed.

## Syntax

---

```
>>-ARCHLOGCOMPRESS--+-No--
                    +-Yes-'
```

## Parameters

---

No

Specifies that log files that are written to the archive log directory are not compressed. The default is No.

Yes

Specifies that log files that are written to the archive log directory are compressed.

Restriction: Use caution when you enable the ARCHLOGCOMPRESS server option on systems with sustained high volume usage and heavy workloads. Enabling this option in this system environment can cause delays in archiving log files from the active log



file system to the archive log file system. This delay can cause the active log file system to run out of space. Be sure to monitor the available space in the active log file system after archive log compression is enabled. If the active log directory file system usage nears out of space conditions, the ARCHLOGCOMPRESS server option must be disabled. You can use the SETOPT command to disable archive log compression immediately without halting the server.

## Example

---

To enable compression of log files that are written to the archive log directory, specify the following option:

```
archlogcompress yes
```

## ARCHLOGDIRECTORY

---

The ARCHLOGDIRECTORY option specifies a directory that the database manager can archive a log file into after all the transactions represented in that log file are completed.

This option is appended to the options file when the DSMSEV FORMAT command is run.

## Syntax

---

```
>>-ARCHLOGDirectory--dir_name-----<<
```

## Parameters

---

dir\_name

Specifies a fully qualified directory name. The maximum number of characters is 175.

## Examples

---

AIX Linux

```
archlogdirectory /tsm/archlog
```

Windows

```
archlogdirectory d:\tmserv1\archlog
```

## ARCHLOGUSEDTHRESHOLD

---

The ARCHLOGUSEDTHRESHOLD option specifies when to start an automatic database backup in relation to the percentage of archive log file space used. The default is 80 percent.

The ARCHLOGUSEDTHRESHOLD option prevents frequent automatic backups. For example, if the archive log file directory resides on a file system or drive that is 400 GB, a database backup is triggered if there is less than 80 GB of free space. Repeated database backups might cause the server to use an excessive amount of scratch tapes.

## Syntax

---

```
.-80----.  
>>-ARCHLOGUSEDTHRESHOLD--+-value+-----<<
```

## Parameters

---

value

The percentage of archive log file space used before an automatic backup starts.

Specify to start an automatic backup when 90 percent of archive log file space is used.

```
archlogusedthreshold 90
```

## ASSISTVCRRECOVERY

---

The ASSISTVCRRECOVERY option specifies whether IBM Spectrum Protect™ assists an IBM® 3590 drive in recovering from a lost or corrupted Vital Cartridge Records (VCR) condition. If you specify YES (the default) and if IBM Spectrum Protect detects an error during the mount processing, it locates to the end-of-data during the dismount processing to allow the drives to restore the VCR. During the tape operation, there might be some small effect on performance because the drive cannot complete a fast locate with a lost or corrupted VCR. However, there is no loss of data.

### Syntax

---

```
>>-ASSISTVCRREcovery---+-Yes-+-----><
      '-No--'
```

### Parameters

---

- Yes  
Specifies server assistance in recovery.
- No  
Specifies no server assistance in recovery.

### Examples

---

Turn off recovery assistance:

```
assistvcrrecovery no
```

## AUDITSTORAGE

---

As part of a license audit operation, the server calculates, by node, the amount of server storage used for backup, archive, and space-managed files. For servers managing large amounts of data, this calculation can take a great deal of CPU time and can stall other server activity. You can use the AUDITSTORAGE option to specify that storage is not to be calculated as part of a license audit.

Note: This option was previously called NOAUDITSTORAGE.

### Syntax

---

```
>>-AUDITStorage---+-Yes-+-----><
      '-No--'
```

### Parameters

---

- Yes  
Specifies that storage is to be calculated as part of a license audit. The default is Yes.
- No  
Specifies that storage is not to be calculated as part of a license audit.

### Examples

---

```
auditstorage yes
```

## BACKUPINITIATIONROOT

---

The BACKUPINITIATIONROOT option specifies whether the server overrides node parameter values for users who are not IBM Spectrum Protect™ authorized users.

You can update this server option without stopping and restarting the server by using the SETOPT command. See SETOPT (Set a server option for dynamic update).

## Syntax

---

```
>>-BACKUPINITIATIONROOT---ON---+-----><
      '-Off-'
```

## Parameters

---

ON

Specifies that sessions from clients on AIX®, Linux, Mac OS X, and Solaris operating systems, where the users are not IBM Spectrum Protect authorized users, are prevented from initiating backup operations. This is the default. The server overrides the value for the BACKUPINITIATION parameter that is specified in the REGISTER NODE and UPDATE NODE commands.

Tip: For an overview of IBM Spectrum Protect authorized users, see UNIX and Linux client root and authorized user tasks.

OFF

Specifies that the node value for the BACKUPINITIATION parameter is used. The BACKUPINITIATION parameter is specified in the REGISTER NODE and UPDATE NODE commands.

## Example

---

Specify that the node value for the BACKUPINITIATION parameter is used.

```
backupinitiationroot off
```

## CHECKTAPEPOS

---

The CHECKTAPEPOS option specifies whether the IBM Spectrum Protect™ server validates the position of data blocks on tape.

The CHECKTAPEPOS option applies only to operations that use tape drives. It does not apply to non-tape, sequential-access device classes such as FILE. If the server information about position does not match the position that is detected by the drive, an error message is displayed, the transaction is rolled back, and the data is not committed to the database.

Using the CHECKTAPEPOS option, you can enable append-only mode for IBM LTO Generation 5 and later drives, and for any drives that support this feature. When it is enabled, the drive issues an error after it receives instructions to overwrite any data on the currently mounted volume. The IBM Spectrum Protect server repositions the tape to the correct block and continues writing data. Append-only mode provides added protection by preventing most data overwrite situations. If you are using a drive that supports this feature, you can validate data position on tape by using both IBM Spectrum Protect and the drive or you can enable one or the other.

Note: When you use SAN Tape acceleration functions in the fabric, set CHECKTAPEPOS to DRIVEonly or No to avoid false positive positioning errors. The IBM Spectrum Protect CHECKTAPEPOS server option does not require an append-only capable drive.

Changes to the CHECKTAPEPOS option affect mounts only after the update to the drive is complete.

The default is YES.

## Syntax

---

```
>>-CHECKTAPEPOS---Yes-----+-----><
      +-No-----+
      +-TSMonly---+
      '-DRIVEonly-'
```

## Parameters

---

Yes

Specifies that the IBM Spectrum Protect server validates data position on tape. For drives that support append-only mode, this parameter specifies that IBM Spectrum Protect enables the drive to also validate the data position during each WRITE

- operation to prevent data overwrite. Yes is the default.
- No Specifies that all data position validation is turned off.
- TSMonly Specifies that the IBM Spectrum Protect server validates data position on tape. The server does not use append-only mode even if the drive supports the feature
- DRIVEonly Specifies that the IBM Spectrum Protect server enables append-only mode for drives that support this feature. The server does not validate the data position on tape.

## Example

---

Validate data position on tape and enable append-only mode for a supported drive:

```
checktapepos yes
```

## CLIENTDEDUPTXNLIMIT

---

The CLIENTDEDUPTXNLIMIT option specifies the maximum size of a transaction when client-side deduplicated data is backed up or archived.

When you use client-side deduplication for large objects, intensive database activity can result from long-running transactions that are required to update the database. High levels of database activity can produce the following symptoms:

- Reduced throughput for client backup and archive operations
- Resource contention resulting from concurrent server operations
- Excessive recovery log activity

The extent to which these symptoms occur depends on the number and size of objects being stored using client-side data deduplication, the intensity and type of concurrent operations taking place on the IBM Spectrum Protect™ server, and the IBM Spectrum Protect server configuration.

With the CLIENTDEDUPTXNLIMIT server option, you can specify a maximum size, in gigabytes, for transactions when client-side deduplicated data is backed up or archived. If an object or set of objects in a single transaction exceeds the limit specified by CLIENTDEDUPTXNLIMIT, the objects are not deduplicated by the client, and the transaction can fail. You can specify a value 32 - 102400 GB. The default value is 5120 GB.

If an object or set of objects in a single transaction exceeds the limit specified by CLIENTDEDUPTXNLIMIT, the objects or set of objects is not deduplicated by the client. However, the objects are sent to the server. These objects can be deduplicated on the server, depending on whether the destination storage pool is configured for data deduplication and on the value of the SERVERDEDUPTXNLIMIT option. Objects in a deduplication-enabled storage pool that are less than the value of the SERVERDEDUPTXNLIMIT are deduplicated by a server duplicate-identification process.

The appropriate value for this option depends on the IBM Spectrum Protect server configuration and concurrent server activity. You can specify a high value for this option if you minimize resource contention. To minimize resource contention, perform operations, such as backup, archive, duplicate identification (the IDENTIFY DUPLICATES command), and reclamation, at different times.

To update this server option without stopping and restarting the server, use the SETOPT command.

## Syntax

---

```

                .-5120-----.
>>-CLIENTDEDUPTXNlimit---+gigabytes+-----<<

```

## Parameters

---

- gigabytes**  
Specifies the maximum size, in gigabytes, of objects that can be backed up or archived using client-side data deduplication. You can specify a value 32 - 102400. The default value is 5120.

## Examples

---

Disable client-side data deduplication for all objects over 80 GB:

```
clientdeduptxnlimit 80
```

## COMMMETHOD

---

The COMMMETHOD option specifies a communication method to be used by the server.

You can configure the server to use multiple communication methods. The more commonly used are the TCPIP, V6TCPIP, and SHAREDMEM communication methods. To specify multiple communication methods, enable each method by adding a COMMMETHOD stanza to the dsmserv.opt options file.

**Important:** When you enable a communication method, you must also add the options that are specific to the communication method to the options file.

## Syntax

---

```
      .-TCPIP-----.  
>>-COMMMethod--+-NAMEDPIPE+-----><  
      +-NONE-----+  
      +-SHAREDMEM--+  
      +-SNMP-----+  
      +-TCPIP-----+  
      '-V6TCPIP---'
```

## Parameters

---

You can choose one of the following communication methods:

**Windows** NAMEDPIPES

**Windows** Specifies the named pipes communication method option.

NONE

Specifies that no communication method is used. This option does not allow users to connect to the server and is useful for experimenting with policy commands.

SHAREDMEM

Specifies the shared memory communication method option. This method uses the same area of memory to send data between several applications at the same time. Both the server and the backup-archive client must be configured to support the shared memory communication method, and they must be installed on the same computer.

SNMP

Specifies the SNMP communication method option.

TCPIP

Specifies the TCP/IP communication method option. This option is the default. When TCPIP is specified, TCP/IP Version 4 is used exclusively.

V6TCPIP

Specifies the TCP/IP communication method option. If TCP/IP Version 4 and Version 6 are both configured, IBM Spectrum Protect™ uses both protocols simultaneously. If both COMMMETHOD TCPIP and COMMMETHOD V6TCPIP are specified, V6TCPIP overrides the specification of TCPIP. A valid domain name server (DNS) environment must be present to use either TCP/IP V4 or TCP/IP V6 if this option is specified.

## Examples

---

Example of specifying multiple communication methods to be used by the server (TCP/IP and TCP/IP Version 6):

```
commmethod tcpip  
commmethod v6tcpip
```

## COMMTIMEOUT

---

The COMMTIMEOUT option specifies how long the server waits for an expected client message during an operation that causes a database update. If the length of time exceeds this time-out, the server ends the session with the client. You may want to increase the time-out value to prevent clients from timing out. Clients may time out if there is a heavy network load in your environment or they are backing up large files.

The COMMTIMEOUT server option is used for non-administrative sessions. See the ADMINCOMMTIMEOUT option for administrative client sessions.

You can update this server option without stopping and restarting the server by using the SETOPT command.

## Syntax

---

```
                .-60-----.  
>>-COMMTIMEOUT--+-seconds+-----><
```

## Parameters

---

seconds

Specifies the maximum number of seconds that a server waits for a client response. The default value is 60. The minimum value is 1.

## Examples

---

```
comtimeout 60
```

AIX

Linux

Windows

# CONTAINERRESOURCETIMEOUT

---

The CONTAINERRESOURCETIMEOUT option specifies how long the server waits to complete a data store operation to a container storage pool.

## Syntax

---

When a timeout occurs, any data that was stored in the container storage pool remains there. The data store operation ends, and the request for the container resource is canceled.

```
                .-180-----.  
>>-CONTAINERRESOURCETIMEOUT--+-minutes+-----><
```

## Parameters

---

minutes

Specifies the maximum number of minutes that a server waits before an operation is canceled. The default value is 180 minutes. The minimum value is 1 minute.

## Example

---

Specify that the server waits for 4 hours before a data store operation to a container storage pool is canceled.

```
containerresourcetimeout 240
```

Windows

# DATEFORMAT

---

The DATEFORMAT option specifies the format in which dates are displayed by the server.

The DATEFORMAT value is overridden by the locale format if the locale is initialized at server startup. The locale is specified in the LANGUAGE option.

## Syntax

---

```
>>-DATEformat--n-----><
```

## Parameters

---

n

Select a number from 1 to 5 to identify the date format used by the server. The default value is 1.

1	MM/DD/YYYY
2	DD-MM-YYYY
3	YYYY-MM-DD
4	DD.MM.YYYY
5	YYYY.MM.DD

## Examples

---

```
dateformat 4
```

## DBDIAGLOGSIZE

---

This option helps to control the amount of space that is used by diagnostic log files.

The database manager uses diagnostic log files to log messages. You must control the size of the log files so that they do not fill the file system. Use the DBDIAGLOGSIZE option to set the amount of space that is used by the log files.

If you set a value in the range 2 - 9999, a maximum of 10 rotating diagnostic log files are retained. Each file name indicates the order in which the file was created. After a file is full, the next file is created. When the 10th file is full, the oldest file is deleted, and a new file is created. The following example shows how the rotating log files might look:

```
db2diag.14.log, db2diag.15.log, ... , db2diag.22.log, db2diag.23.log
```

When db2diag.23.log is full, db2diag.14.log is deleted, and db2diag.24.log is created.

The server checks the file space that contains the diagnostic log files every hour. Messages are displayed every 12 hours if either of the following conditions occur:

- The available space in the file system where the diagnostic log files are located is less than 20% of the total file system space.
- The available space in the file system where the server instance directory is located is less than 1 GB.

If you specify a value of 0, only one log file, db2diag.log, is used for all diagnostic messages. No limits are imposed on the size of the log file.

Restriction: You must monitor the size of the diagnostic log files to ensure that they do not use all the available space in the file system. If there is not enough available space, the server might fail to respond.

## Syntax

---

```
.-1024-----.  
>>-DBDIAGLOGSize--+-megabytes+-----><
```

## Parameters

---

megabytes

Specifies the amount of space that is used by diagnostic log files in megabytes. Specify a value in the range 2 - 9999, or a value of 0. The default value is 1024.

If you specify a value in the range 2 - 9999, rotating log files are used, and the value specifies the total size in megabytes of all 10 log files. The value is reset to 1024 whenever the server is restarted.

If you specify a value of 0, one log file is used, and no limits are imposed on the size of the log file.

If you want to archive messages, specify a value of 0 to ensure that the db2diag.log file can use all the available space without using rotating log files.

After you set the value of the megabytes parameter to 0 by using the DBDIAGLOGSIZE option, messages are initially written to rotating log files. After the server is restarted, messages are written to the db2diag.log file.

Tip: If you specify a value in the range 2 - 9999 by using the server options file, dsmserv.opt, the value is not reset automatically at server startup. The value remains the same until it is changed or removed from the dsmserv.opt file, by using the SETOPT command.

## Example: Specify a maximum size of 5120 megabytes

---

Specify the size of the diagnostic log files as 5120 megabytes (5 GB):

```
dbdiaglogsize 5120
```

## Example: Archive messages in a single log file

---

Archive messages by specifying that the messages are written to the db2diag.log file:

```
dbdiaglogsize 0
```

### Related information:

[DB2 V10.5 product information](#)

## DBDIAGPATHFSTHRESHOLD

---

The DBDIAGPATHFSTHRESHOLD option specifies the threshold for free space on the file system or disk that contains the db2diag.log file.

When the amount of free space is equal to or less than the specified threshold, the ANR1545W error message is shown. By default, the message is shown when the file system or disk has 20% or less of free disk space.

You can update this server option without stopping and restarting the server by using the SETOPT command. See SETOPT (Set a server option for dynamic update).

## Syntax

---

```
>>-DBDIAGPATHFSTHreshold--percent-----<<
```

## Parameter

---

percent

Specifies the percentage of available space in the file system. Valid values are in the range 0 - 100. The default is 20.

Tip: For best results, do not set a low or high value for the percent parameter. A low value might cause the file system to become full before you can correct the issue. A full file system might corrupt the server database. A high value might result in many ANR1545W messages in the server activity log.

## Example

---

Set the threshold value to 10%.

```
setopt DBDIAGPATHFSTH 10
```

## DBMEMPERCENT

---



Use this option to specify the percentage of the virtual address space that is dedicated to the database manager processes.

If applications other than IBM Spectrum Protect™ server are running on the system, ensure that the value allows adequate memory for the other applications.

## Syntax

---

```
>>-DBMEMPERCENT--+-percent+-----><
                    '-AUTO-----'
```

## Parameters

---

percent

Set a value from 10 to 99.

AUTO

The database manager sets the percentage automatically to a value that is between 75 percent and 95 percent of system RAM. The default value is AUTO.

## Examples

---

```
dbmempercent 50
```

## DBMTCPPORT

---

The DBMTCPPORT option specifies the port number on which the TCP/IP communication driver for the database manager waits for requests for client sessions.

The specified port number must be reserved for use by the database manager.

By default, the IBM Spectrum Protect™ server uses interprocess communications (IPC) to establish connections for the first two connection pools, with a maximum of 480 connections for each pool. After the first 960 connections are established, the IBM Spectrum Protect server uses TCP/IP for any additional connections.

## Syntax

---

```
>>-DBMTCPPort--port_number-----><
```

## Parameters

---

port\_number

Specifies the number of the TCP/IP port on which the database manager waits for communications from the server. Valid values are integers from 1024 to 65535.

The default port number is the value of the server TCPSPORT option plus 50,000. For example, if the server TCPSPORT option is 1500, the default DBMTCPPORT port number would be 51500.

If the TCPSPORT server option is greater than 9999, add the last four digits of its value to 50000. For example, if the TCPSPORT option is 11500, 1550 is added to 50000, resulting in a DBMTCPPORT port number of 51500.

## Example

---

```
dbmtcport 51500
```

## DEDUPREQUIRESBACKUP

---

The DEDUPREQUIRESBACKUP option specifies whether volumes in primary sequential-access storage pools that are set up for data deduplication can be reclaimed and whether duplicate data can be discarded before the storage pools are backed up.

If the value of this option is YES (the default), you must back up data to copy storage pools that are not set up for data deduplication. Use the BACKUP STGPOOL command to back up data to copy storage pools.

Be aware that reclamation of a volume in a storage pool that is set up for data deduplication might not occur when the volume first becomes eligible. The server makes additional checks to ensure that data from a storage pool that is set up for data deduplication has been backed up to a copy storage pool. These checks require more than one BACKUP STGPOOL instance before the server reclaims a volume. After the server verifies that the data was backed up, the volume is reclaimed.

You can change this option dynamically using the SETOPT command.

Attention: To minimize the possibility of data loss, do not change the default setting for this server option. Specify a value of NO only if you do not have any copy storage pools and are not performing storage pool backups.

## Syntax

---

```
>>-DEDUPREQUIRESBACKUP---+-Yes-+-----><
                               '-No--'
```

## Parameters

---

Yes

Specifies that the storage pool must be backed up before volumes can be reclaimed and before duplicate data can be discarded. This is the default.

No

Specifies that volumes in primary sequential-access storage pools that are set up for data deduplication can be reclaimed and duplicate data can be discarded if the storage pools are not backed up.

## Examples

---

Specify that primary sequential-access storage pools that are set up for data deduplication do not have to be backed up.

```
deduprequiresbackup no
```

## DEDUPTIER2FILESIZE

---

The DEDUPTIER2FILESIZE option specifies at what file size IBM Spectrum Protect™ begins to use Tier 2 data deduplication.

## Syntax

---

```
>>-DEDUPTIER2FILESIZE---nnn-----><
```

## Parameters

---

nnn

Specifies the file size, in gigabytes, at which point the IBM Spectrum Protect server begins to use Tier 2 processing for data deduplication. You can specify a value 20 - 9999. The default is 100.

Note: If the value specified or defaulted to for this option is greater than the value for the SERVERDEDUPTXNLIMIT option, then this option is ignored for server data deduplication. If the value specified or defaulted to for this option is greater than the value for CLIENTDEDUPTXNLIMIT, then this option is ignored for client data deduplication.

## Examples

---

```
deduptier2filesize 550
```

## DEDUPTIER3FILESIZE

---

The DEDUPTIER3FILESIZE option specifies at what file size IBM Spectrum Protect™ begins to use Tier 3 data deduplication.

## Syntax

---

```
>>-DEDUPTIER3FILESIZE--nnn-----><
```

## Parameters

---

*nnn*

Specifies the file size, in gigabytes, at which point the IBM Spectrum Protect server begins to use Tier 3 processing for data deduplication. You can specify a value 90 - 9999. The default is 400.

- If the value specified or defaulted to for this option is greater than the value for the SERVERDEDUPTXNLIMIT option, then this option is ignored for server data deduplication.
- If the value specified or defaulted to for this option is greater than the value for CLIENTDEDUPTXNLIMIT, then this option is ignored for client data deduplication.
- If the value specified or defaulted to for this option is less than the value specified or defaulted to for DEDUPTIER2FILESIZE, then the value of DEDUPTIER2FILESIZE is used for this option.

## Examples

---

```
deduptier3filesize 1150
```

## DEVCONFIG

---

The DEVCONFIG option specifies the name of a file in which you want IBM Spectrum Protect™ to store a backup copy of device configuration information.

IBM Spectrum Protect stores the following information in the device configuration file:

- Device class definitions created by using the DEFINE DEVCLASS command
- Drive definitions created by using the DEFINE DRIVE command
- Library definitions created by using the DEFINE LIBRARY command
- Library inventory information for the LIBTYPE=SCSI automated libraries
- Path definitions created by using the DEFINE PATH command
- Server definitions created with the DEFINE SERVER command
- Server name created with the SET SERVERNAME command
- Server password created with the SET SERVERPASSWORD command

Note:

- Only path definitions with SRCTYPE=SERVER are backed up to the device configuration file. Paths of SRCTYPE=DATAMOVER are not written to the file.
- Library volume location information is stored as comments (*/\*...\*/*) in the device configuration file whenever CHECKIN LIBVOLUME, CHECKOUT LIBVOLUME, and AUDIT LIBRARY commands are issued for SCSI libraries.

Attention: To restore the database after a disaster, you must have a copy of the current device configuration file. The device configuration file cannot be recreated.

You can include one or more DEVCONFIG options in the server options file. When you use multiple DEVCONFIG options, IBM Spectrum Protect automatically updates and stores a backup copy of device configuration information in each file you specify.

## Syntax

---

```
>>-DEVCONFig--file_name-----><
```

## Parameters

---

*file\_name*

Specifies the name of a file in which to store a backup copy of device configuration information.

## Examples

---

```
devconfig devices.sav
```

## DISABLEREORGTABLE

---

The DISABLEREORGTABLE option specifies whether online table reorganization is disabled for table names that are specified in the tables list.

To use the DISABLEREORGTABLE option, you must halt the server, update the options file, and then restart the server.

## Syntax

---

```
>>-DISABLEREORGTTable----tablelist-----<<
```

## Parameters

---

tablelist

Specifies a list of table names for which table reorganization is disabled. If you do not specify any table names with the option, or if the option is not in the options file, no tables are disabled.

Restriction: The following tables are already excluded from table reorganization processing and cannot be specified for this option:

- STAGED\_EXPIRING\_OBJECTS
- STAGED\_OBJECT\_IDS
- BF\_DEREFERENCED\_CHUNKS
- BF\_QUEUED\_CHUNKS

## Example

---

```
DISABLEREORGTABLE BF_BITFILE_EXTENTS,REPLICATING_OBJECTS
```

## DISABLESCHEDS

---

The DISABLESCHEDS option specifies whether administrative and client schedules are disabled during IBM Spectrum Protect™ server recovery.

## Syntax

---

```
>>-DISABLESCheds---Yes-----<<  
                '-No--'
```

## Parameters

---

Yes

Specifies that administrative and client schedules are disabled.

No

Specifies that administrative and client schedules are enabled.

## Examples

---

```
disablescheds no
```

## DISPLAYLFINFO

---

The DISPLAYLFINFO option specifies how the accounting records and summary table entries report the node name.

When this option is enabled, the accounting records and summary table entries report node\_name(storage\_agent\_name) for the node name. If the option is not enabled, the accounting records and summary table entries simply report node\_name for the node name. The default is No.

## Syntax

---

```
>>-DISPLAYLFINFO--+-Yes+-----><
      '-No--'
```

## Parameters

---

Yes

Specifies that the accounting records and summary table entries will report the storage agent name.

No

Specifies that the accounting records and summary table entries will not report the storage agent name. This is the default.

## Examples

---

```
displaylfinfo yes
```

The result shows the following accounting record with the storage agent name displayed (STA53):

```
5,0,ADSM,07/13/2004,15:35:14,COLIND-TUC (STA53),,WinNT,1,Tcp/Ip,1,0,0,0,
0,223,4063,0,0,222,7,8,3,1,4,0,0,0,0,3,0
```

The corresponding summary table also displays the storage agent name:

```
START_TIME: 2004-07-13 15:35:07.000000
END_TIME: 2004-07-13 15:35:14.000000
ACTIVITY: BACKUP
NUMBER: 8
ENTITY: COLIND-TUC (STA53)
COMMMETH: Tcp/Ip
ADDRESS: colind-tuc:2229
SCHEDULE_NAME:
EXAMINED: 0
AFFECTED: 223
FAILED: 0
BYTES: 4160875
IDLE: 8
MEDIWA: 1
PROCESSES: 1
SUCCESSFUL: YES
VOLUME_NAME:
DRIVE_NAME:
LIBRARY_NAME:
LAST_USE:
COMM_WAIT: 3
NUM_OFFSITE_VOLS:
```

## DNSLOOKUP

---

The DNSLOOKUP option specifies whether the server uses system API calls to determine the domain name server (DNS) names of systems that contact the server.

## Syntax

---

```
>>-DNSLOOKUP--+-Yes+-----><
      '-No--'
```

## Parameters

---

Yes

Specifies that the server obtains the DNS names of contacting systems. Yes is the default.

No

Specifies that the server does not obtain the DNS names of contacting systems.

## Examples

---

```
dnslookup yes
```

## DRIVEACQUIRERETRY

---

The DRIVEACQUIRERETRY option lets you specify how many times the server retries the acquisition of a drive in an IBM® 349x library. If the library is shared among multiple applications, its drives may appear to be available to the server (through the use of a background polling process) when they are not.

This option is only valid if you specified 3494SHARED YES in the dsmserv.opt file. If you specified DRIVEACQUIRERETRY NEVER, you need to monitor how long jobs have been waiting for drives and how long the server has been polling the drives. You may also need to check the status of these drives in the other IBM Spectrum Protect™ servers. There may be cartridges stuck in the drives, and the other IBM Spectrum Protect servers may have marked the drives as *offline*. If this is the case, you need to mark the drives *offline* in the IBM Spectrum Protect server that is polling the drives. If necessary, also cancel any waiting jobs.

## Syntax

---

```
>>-DRIVEACquireretry--+-Forever-----+-----><
                        +-Never-----+
                        '-number_of_retries-'
```

## Parameters

---

Forever

The acquisition of a drive is retried until one is successfully acquired. This is the default.

Never

The server does not retry the acquisition of a drive and fails the operation.

number\_of\_retries

Specifies the maximum number of times, from 1 to 9999, that the server retries the acquisition of a drive.

## Examples

---

Specify that the server should attempt no more than 10 times to acquire the drive:

```
driveacquireretry 10
```

## ENABLENASDEDUP

---

The ENABLENASDEDUP server option specifies whether the server deduplicates data that is stored by a network-attached storage (NAS) file server. This option applies only to NetApp file servers.

If the value of this option is NO, the data stored by the file server is skipped during duplicate-identification processing. If the value of this option is YES, the value of the DEDUPLICATE parameter in the storage pool definition must be YES.

## Syntax

---

```
>>-ENABLENASDEDUP--+-No-----><
                    '-Yes-'
```

## Parameters

---

Yes

Specifies that IBM Spectrum Protect™ server deduplicates data stored by a NetApp file server.

No

Specifies that the server does not deduplicate data stored by a NetApp file server.

## Example

---

Specify that the server deduplicates data stored by a NetApp file server.

```
enablenasdedup yes
```

## EVENTSERVER

---

The EVENTSERVER option specifies whether at startup the server should try to contact the event server.

### Syntax

---

```
>>-EVENTSERVer--+-Yes-+-----><  
      '-No--'
```

### Parameters

---

Yes

Specifies that, at startup, the server tries to contact the event server. Contact occurs only if a DEFINE EVENTSERVER command has already been issued. This is the default.

No

Specifies that, at startup, the server does not try to contact the event server.

### Examples

---

```
eventserver yes
```

## EXPINTERVAL

---

The EXPINTERVAL option specifies the interval, in hours, between automatic inventory expiration processes by IBM Spectrum Protect™. Inventory expiration removes client backup and archive file copies from the server as specified by the management classes to which the client files are bound. If expiration is not run periodically, storage pool space is not reclaimed from expired client files, and the server requires more storage space than required by policy.

You can also use the EXPIRE INVENTORY command to start inventory expiration. Expiration can make space available in your storage pools for additional client backup or archive files.

You can update this server option without stopping and restarting the server by using the SETOPT command. See SETOPT (Set a server option for dynamic update).

### Syntax

---

```
>>-EXPINterval--+-hours-+-----><  
      .-24----
```

### Parameters

---

hours

Specifies the time, in hours, between automatic inventory expiration processes. You can specify from 0 to 336 (14 days). A value of 0 means that expiration must be started with the EXPIRE INVENTORY command. The default is 24.

### Examples

---

```
expinterval 5
```

## EXPQUIET

---

The EXPQUIET option specifies whether IBM Spectrum Protect™ sends detailed messages during expiration processing.

You can update this server option without stopping and restarting the server by using the SETOPT command. See SETOPT (Set a server option for dynamic update).

### Syntax

---

```
>>-EXPQUIet---+- --No---+-----><
      '- --Yes-'
```

### Parameters

---

No

Specifies that the server sends detailed messages. This is the default.

Yes

Specifies that the server sends only minimal messages. These messages are sent only for files that have expired based on the copy group in the default management class or retention grace period for the domain.

### Examples

---

```
expquiet no
```

Linux

## FASPBEGPORT

---

The FASPBEGPORT option specifies the starting number in the range of port numbers that are used for network communications with Aspera® Fast Adaptive Secure Protocol (FASP®) technology.

To define the range of port numbers, specify both the FASPBEGPORT and FASPENDPORT options.

### Syntax

---

```
      .-15100-----.
>>-FASPBEGPort---+starting_port_number+-----><
```

### Parameters

---

starting\_port\_number

Specifies the starting port number for network communications that use Aspera FASP technology. The default value is 15100.

Ask your network administrator to help you define the range of port numbers:

- If you did not enable the Secure Sockets Layer (SSL) protocol for the server pair, ensure that the ports can be used for Transmission Control Protocol (TCP) sockets.
- Ensure that the ports can be used for User Datagram Protocol (UDP) connections.
- Ensure that the ports are compatible with firewall rules.

### Example

---

If firewall rules require port numbers to be greater than 1800, you would specify a minimum port number of 1801:

```
faspbegport 1801
```

**Related reference:**

FASPENDPORT

Linux



# FASPENDPOR

---

The FASPENDPOR option specifies the ending number in the range of port numbers that are used for network communications with Aspera® Fast Adaptive Secure Protocol (FASP®) technology.

To define the range of port numbers, specify both the FASPBEGPOR and FASPENDPOR options.

## Syntax

---

```
.-15199-----.  
>>-FASPENDPOR---+ending_port_number+-----<<
```

## Parameters

---

ending\_port\_number

Specifies the ending port number for network communications that use Aspera FASP technology. The default value is 15199.

Ask your network administrator to help you define the range of port numbers:

- If you did not enable the Secure Sockets Layer (SSL) protocol for the server pair, ensure that the ports can be used for Transmission Control Protocol (TCP) sockets.
- Ensure that the ports can be used for User Datagram Protocol (UDP) connections.
- Ensure that the ports are compatible with firewall rules.

## Example

---

If firewall rules require port numbers to be less than 1900, you would specify a maximum port number of 1899:

```
faspendport 1899
```

### Related reference:

FASPBEGPOR

Linux

# FASPTARGETRATE

---

The FASPTARGETRATE option specifies the target rate for data transfer with Aspera® Fast Adaptive Secure Protocol (FASP®) technology. By specifying the target rate, you limit the bandwidth of each network connection that uses Aspera FASP technology. In this way, you can ensure that sufficient bandwidth is available for all network connections.

## Syntax

---

```
.-250000-----.  
>>-FaspTargetRate---+target_rate+-----<<
```

## Parameters

---

target\_rate

Specifies the maximum rate, in kilobits per second, for data transfer during a session. The default value is 250000. You can specify values in the range 100 - 100000000.

For example, if you issue the PROTECT STGPOOL command to run two parallel operations at the default target rate, the aggregated throughput does not exceed 500,000 kbps. If your file system can support two operations to protect storage pools at much higher rates than 500,000 kbps of aggregated throughput, and sufficient network bandwidth is available, you can increase the target rate.

To determine the appropriate target rate, consult your network administrator.

## Examples

---

If the allotted network bandwidth is 150,000 kbps, you can set the target rate to 75,000 and use the default number of sessions (two) for the PROTECT STGPOOL command.

```
fasptargetrate 75000
```

In a large blueprint configuration, if the allotted network bandwidth is 6,000,000 kbps, you can set the target rate to 750,000 and use eight sessions for the PROTECT STGPOOL command.

```
fasptargetrate 750000
```

## FFDCLOGLEVEL

---

The FFDCLOGLEVEL option specifies the type of general server messages that are displayed in the first failure data capture (FFDC) log.

The FFDC log contains three categories of general server messages. Setting the FFDCLOGLEVEL option affects the following categories:

- FFDC\_GENERAL\_SERVER\_INFO
- FFDC\_GENERAL\_SERVER\_WARNING
- FFDC\_GENERAL\_SERVER\_ERROR

### Syntax

---

```
.-FFDCLOGLevel-----ALL-----.  
>>-+-FFDCLOGLevel-----+--ALL--+-----><  
                               +-WARN--+  
                               '-ERRor-'
```

### Parameters

---

ALL

Specifies that all FFDC general server log messages are in the log. This value is the default.

WARN

Specifies that the FFDC\_GENERAL\_SERVER\_WARNING and FFDC\_GENERAL\_SERVER\_ERROR messages appear in the log.

ERRor

Specifies that only the FFDC\_GENERAL\_SERVER\_ERROR messages appear in the log.

### Example

---

```
ffdcloglevel warn
```

## FFDCLOGNAME

---

The FFDCLOGNAME option specifies a name for the first failure data capture (FFDC) log.

The FFDC log file is used to gather diagnostic information about the server. When an error occurs, data about the error is written to the FFDC log file. This information can be provided to IBM Support to help diagnose problems. The FFDC log file is in the server instance directory.

### Syntax

---

```
.-dsmffdc.log-  
>>-FFDCLOGNAME---+file_name-----><
```

### Parameters

---

file\_name

Specifies a file name for the FFDC log file. The file name can be a fully qualified file name or a file name relative to the server instance directory. The default value is dsmffdc.log.

## Examples

---

```
ffdclogname /tsminst1/tsmffdc.log
ffdclogname tsmffdc.log
ffdclogname c:\tsmserv1\tsmffdc.log
```

**Related reference:**

FFDCMAXLOGSIZE  
FFDCNUMLOGS

## FFDCMAXLOGSIZE

---

The FFDCMAXLOGSIZE option specifies the size for the first failure data capture (FFDC) log file.

The FFDC log file is used to gather diagnostic information about the server. When an error occurs, data about the error is written to the FFDC log file. This information can be provided to IBM Support to help diagnose problems.

## Syntax

---

```
                .-1024-----.
>>-FFDCMAXLOGSIZE--+-kilobytes+-----><
```

## Parameters

---

kilobytes

Specifies the size to which the FFDC log file can grow before wrapping. The minimum value is 500. The maximum value is 2097151. The default value is 1024.

To allow the size of the log file to grow indefinitely, specify a value of -1. To disable the log, specify 0.

## Examples

---

```
ffdcmaxlogsize 2000
```

**Related reference:**

FFDCLOGNAME  
FFDCNUMLOGS

## FFDCNUMLOGS

---

The FFDCNUMLOGS option specifies the number of log files that can be used for circular logging. The default value is 10.

Circular logging uses a ring of log files to provide recovery from transaction failures and system crashes. For example, when the dsmffdc.log file is full, it is renamed to dsmffdc.log.1. If a dsmffdc.log.1 file exists, the dsmffdc.log.1 file is renamed to dsmffdc.log.2. If a dsmffdc.log.2 exists, the dsmffdc.log.2 file is renamed to dsmffdc.log.3, and so on, until the FFDCNUMLOGS value is reached. If there is a log file that is renamed as the FFDCNUMLOGS value is reached, that log file is deleted.

The minimum value is 1. The maximum value is 100. The default value is 10.

## Syntax

---

```
                .-10----.
>>-FFDCNUMLOGS--+-value+-----><
```

## Parameters

---

value

Specifies the number of log files that are used for circular logging.

If you specify a value of 1 and the log file size reaches the FFDCMAXLOGSIZE, the server continues to write to the log file. Any logging information is overwritten and the server continues to write to the log file.

## Examples

---

```
ffdcnumlogs 20
```

## FILEEXIT

---

The FILEEXIT option specifies a file to which enabled events are routed. Each logged event is a record in the file.

### Syntax

---

```
>>-FILEEXIT---No---file_name---REPLACE---<-----<
      '-Yes-'                +-APPEND---+
                              '-PRESERVE-'
```

### Parameters

---

Yes

Specifies that event logging to the file exit receiver begins automatically at server startup.

No

Specifies that event logging to the file exit receiver does not begin automatically at server startup. When this parameter has been specified, you must begin event logging manually by issuing the BEGIN EVENTLOGGING command.

file\_name

Specifies the name of the file in which the events are stored.

REPLACE

Specifies that if the file already exists, it will be overwritten.

APPEND

Specifies that if the file already exists, data is appended to it.

PRESERVE

Specifies that if the file already exists, it will not be overwritten.

## Examples

---

Windows

```
fileexit yes \tsm\server\data replace
```

AIX

Linux

```
fileexit yes /tsm/server/data replace
```

## FILETEXTXIT

---

The FILETEXTXIT option specifies a file to which enabled events are routed. Each logged event is a fixed-size, readable line.

### Syntax

---

```
>>-FILETEXTXIT---No---file_name---REPLACE---<-----<
      '-Yes-'                +-APPEND---+
                              '-PRESERVE-'
```

### Parameters

---

Yes

Specifies that event logging to the file exit receiver begins automatically at server startup.

No

Specifies that event logging to the file exit receiver does not begin automatically at server startup. When this parameter has been specified, you must begin event logging manually by issuing the BEGIN EVENTLOGGING command.

file\_name

Specifies the name of the file in which the events are stored.

REPLACE

Specifies that if the file already exists, it will be overwritten.

APPEND

Specifies that if the file already exists, data will be appended to it.

PRESERVE

Specifies that if the file already exists, it will not be overwritten.

## Examples

---

Windows

```
filetextexit yes \tsm\server\data replace
```

AIX

Linux

```
filetextexit yes /tsm/server/data replace
```

## FSUSEDTHRESHOLD

---

The FSUSEDTHRESHOLD option specifies what percentage of the file system can be filled up by the database before an alert message is issued.

You can update this server option without stopping and restarting the server by using the SETOPT command.

If this value is set to a low number, the activity log might be flooded with messages about the database space being filled, even if there is still space available. If the value is set too high, the database space might be filled before you can add more space to the file system.

## Syntax

---

```
>>-FSUSEDThreshhold--percent-----><
```

## Parameters

---

percent

Specifies the value of used space in the database. You can specify a value from 0 to 100. The default is 90.

## Examples

---

```
fsusedthreshold 70
```

## IDLETIMEOUT

---

The IDLETIMEOUT option specifies the amount of time, in minutes, that a client session can be idle before the server cancels the session. You may want to increase the time-out value to prevent clients from timing out if there is a heavy network load in your environment. Note, however, that a large number of idle sessions could prevent other users from connecting to the server.

The IDLETIMEOUT server option is used for non-administrative sessions. See the ADMINIDLETIMEOUT option for administrative client sessions.

You can update this server option without stopping and restarting the server by using the SETOPT command.

## Syntax

---

```
.-15-----.  
>>-IDLETimeout--+-minutes+-----><
```

## Parameters

---

### minutes

Specifies the maximum number of minutes that a server waits for an idle client. The default value is 15 minutes. The minimum value is 1 minute.

## Examples

---

```
idletimeout 15
```

## KEEPALIVE

---

The KEEPALIVE option specifies whether the Transmission Control Protocol (TCP) keepalive function is enabled for outbound TCP sockets. The TCP keepalive function sends a transmission from one device to another to check that the link between the two devices is operating.

If you are using node replication, you can use the KEEPALIVE option on the source replication server to enable the TCP keepalive function. The KEEPALIVE option is not required on the target replication server unless you specify bidirectional replication, in which case the target server becomes the source replication server.

## Syntax

---

```
.-Yes-.  
>>-KEEPALIVE--+-No--+------><
```

## Parameters

---

### Yes

Specifies that the TCP keepalive function is enabled for outbound TCP sockets. This value is the default. If the KEEPALIVE option is enabled, default values are used for the KEEPALIVETIME and KEEPALIVEINTERVAL options.

### No

Specifies that the TCP keepalive function is not enabled for outbound TCP sockets. If you specify a value of NO, it does not affect current TCP socket connections that originated from outbound connection requests while the KEEPALIVE option was set to YES. The YES value applies to those sockets until the related session ends and the socket is closed.

## Example

---

Use the SETOPT command to enable the keepalive function without disabling or halting the server:

```
setopt keepalive yes
```

### Related reference:

KEEPALIVEINTERVAL  
KEEPALIVETIME

## KEEPALIVETIME

---

The KEEPALIVETIME option specifies how often TCP sends a keepalive transmission when it receives a response. This option applies only if you set the KEEPALIVE option to YES.

## Syntax

---

```
.-300-----.
```

```
>>-KEEPALIVETIME--+-seconds+-----<<
```

## Parameters

---

seconds

Specifies how often TCP sends keepalive transmissions to verify that an idle connection is still active. The value is specified in seconds.

You can specify a value in the range 1 - 4294967. The default is 300 (5 minutes).

## Example

---

Set the KEEPALIVETIME option to 120 seconds:

```
keepalivetime 120
```

**Related reference:**

KEEPALIVE

KEEPALIVEINTERVAL

## KEEPALIVEINTERVAL

---

The KEEPALIVEINTERVAL option specifies how often a keepalive transmission is sent if no response is received. This option applies only if you set the KEEPALIVE option to YES.

## Syntax

---

```
                .-30-----.  
>>-KEEPALIVEINTERVAL--+-seconds+-----<<
```

## Parameters

---

seconds

Specifies the length of time, in seconds, between keepalive transmissions when no response is received. The value is specified in seconds.

You can specify a value in the range 1 - 4294967. The default is 30 seconds.

## Example

---

Set the KEEPALIVEINTERVAL option to 45 seconds:

```
keepaliveinterval 45
```

**Related reference:**

KEEPALIVE

KEEPALIVETIME

## LANGUAGE

---

The LANGUAGE option controls the initialization of locales. A locale includes the language and the date, time, and number formats to be used for the console and server.

If your client and server are running different languages, the messages that are generated might not be understandable when messages are issued from the client to the server or if the server sends output to the client.

**AIX** | **Linux** If initialization of the locale fails, the server defaults to American English.

**Windows** If the initialization of the locale fails, the server defaults to American English and uses the date, time, and number formats that are set by the DATEFORMAT, TIMEFORMAT, and NUMBERFORMAT server options.

## Syntax

---

```

>>-LANGUage---+--AMENG-----+-----><
      |                (2) |
+-en_US-----+
      |                (3) |
      '-locale-----'

```

Notes:

1. AMENG is available only on HP-UX, Solaris, Windows.
2. en\_US is available only on AIX and Linux.
3. locale is available only on AIX, HP-UX, Solaris, Linux, and Windows.

## Parameters

**Windows** AMENG

**Windows** Specifies that American English is used as the default language for the server.

**AIX** | **Linux** en\_US

**AIX** | **Linux** Specifies that American English is used as the default language for the server.

locale

Specifies the name of the locale that is supported by the server. See the following tables for information on supported locales by operating system.

Note: IBM Spectrum Protect™ runs in any locale, but defaults to American English. For the locales listed, language support is available.

**AIX**

Table 1. Server languages for AIX®

Language	LANGUAGE option value
Chinese, Simplified	zh_CN
Chinese, Simplified	Zh_CN
Chinese, Simplified (UTF-8)	ZH_CN
Chinese, Traditional (Big5)	Zh_TW
Chinese, Traditional (UTF-8)	ZH_TW
Chinese, Traditional (euc_tw)	zh_TW
English	en_US
English (UTF-8)	EN_US
French	fr_FR
French (UTF-8)	FR_FR
German	de_DE
German (UTF-8)	DE_DE
Italian	it_IT
Italian (UTF-8)	IT_IT
Japanese, EUC	ja_JP
Japanese, PC	Ja_JP
Japanese, UTF8	JA_JP
Korean	ko_KR
Korean (UTF-8)	KO_KR
Portuguese, Brazilian	pt_BR
Portuguese, Brazilian (UTF-8)	PT_BR
Russian	ru_RU



Language	LANGUAGE option value
Russian (UTF-8)	RU_RU
Spanish	es_ES
Spanish (UTF-8)	ES_ES

Table note: The system must have en\_US environment support installed.

**Linux**

Table 2. Server languages for Linux

LANGUAGE	LANGUAGE option value
Chinese, Simplified	zh_CN
	zh_CN.gb18030
	zh_CN.utf8
Chinese, Traditional	Big5 / Zh_TW
	zh_TW
	zh_TW.utf8
English, United States	en_US
	en_US.utf8
French	fr_FR
	fr_FR.utf8
German	de_DE
	de_DE.utf8
Italian	it_IT
	it_IT.utf8
Japanese	ja_JP
	ja_JP.utf8
Korean	ko_KR
	ko_KR.utf8
Portuguese, Brazilian	pt_BR
	pt_BR.utf8
Russian	ru_RU
	ru_RU.utf8
Spanish	es_ES
	es_ES.utf8

**Windows**

Table 3. Server languages for Windows

Language	LANGUAGE option value
Chinese, Simplified	chs
Chinese, Traditional	cht
English	ameng
French	fra
German	deu
Italian	ita
Japanese	jpn

Language	LANGUAGE option value
Korean	kor
Portuguese, Brazilian	ptb
Russian	rus
Spanish	esp

## Examples

**AIX** | **Linux**

```
lang ja_JP
```

**Windows**

```
lang jpn
```

## LDAPCACHEDURATION

The LDAPCACHEDURATION option determines the amount of time that the IBM Spectrum Protect™ server caches LDAP password authentication information.

After a successful LDAP bind, the value that you enter determines the amount of time that information about the LDAP directory server is kept available. The higher the number, the better the performance of the LDAP directory server. During the cache period, though, changes on the LDAP directory server do not take immediate effect on the node. For example, old passwords might be available for some time, even after they were changed or locked on the LDAP server.

Include the LDAPCACHEDURATION option in a SETOPT command to have the option take effect immediately.

Restriction: The LDAPCACHEDURATION option does not apply to storage agents.

## Syntax

```
>>-LDAPCACHEDURATION--minutes-----><
```

## Parameters

minutes

Specifies the maximum amount of time after a successful LDAP bind, that subsequent sessions to the same node or administrator skip secondary LDAP bind operations. Values range from zero to 360 minutes.

### Example: Set the LDAPCACHEDURATION value to 6 hours (maximum)

In the dsmserv.opt file, specify the following value:

```
ldapcacheduration 360
```

After a node or administrator authenticates with an external directory server, the LDAP bind is skipped for 360 minutes on all sessions.

## LDAPURL

The LDAPURL option specifies the location of a Lightweight Directory Access Protocol (LDAP) server. Set the LDAPURL option after you configure the LDAP server.

Tip: The information in this documentation applies to the LDAP authentication method that is preferred for IBM Spectrum Protect™ V7.1.7 or later servers. For instructions about using the previous LDAP authentication method, see Managing passwords and logon procedures.

The following restrictions apply:

- The LDAPURL option cannot be used in combination with the SETOPT command.
- The LDAPURL option does not apply to storage agents.

## Syntax

---

```
>>-LDAPURL--ldap_url_value-----><
```

## Parameters

---

### ldap\_url\_value

Specifies the URL of one LDAP server, or the URLs of multiple LDAP servers. You can enter multiple values, with each URL value up to 1024 characters. The port number is optional and defaults to 389. Each URL value must contain an LDAP server name. For example, the format of the server name is `server1.storage.us.ibm.com` and the LDAP port is 341. The value of the LDAPURL option must conform to the following specifications:

- If you specify multiple URLs, each URL must be on a separate line.
- If you specify multiple URLs, each URL must point to a different external directory, and all external directories must contain the same data.
- Each URL must begin with `ldap://`.  
Restriction: The URL that you designate cannot begin with `ldaps://`.

IBM Spectrum Protect supports LDAP connections that are secured with the standard LDAPv3 StartTLS operation, which establishes a secure Transport Layer Security (TLS) exchange on an existing LDAP connection. The LDAP Simple Bind operation that IBM Spectrum Protect uses does not protect the password when it is sent. A secure TLS connection is required to protect the password.

## Example: Set the port value for an LDAP server

---

In the `dsmserv.opt` file, specify the port value as 341 for an LDAP server:

```
ldapurl ldap://server1.storage.us.ibm.com:341/dc=storage,dc=us,dc=ibm,dc=com
```

## MAXSESSIONS

---

The MAXSESSIONS option specifies the maximum number of simultaneous client sessions that can connect with the server.

You can update this server option without stopping and restarting the server by using the SETOPT command. See SETOPT (Set a server option for dynamic update).

## Syntax

---

```
.-25-----.  
>>-MAXSessions--+-number_of_sessions-+-----><
```

## Parameters

---

### number\_of\_sessions

Specifies the maximum number of simultaneous client sessions. The default value is 25 client sessions. The minimum value is 2 client sessions. The maximum value is limited only by available virtual storage size or communication resources.

## Examples

---

```
maxsessions 25
```

## MESSAGEFORMAT

---

The MESSAGEFORMAT option specifies whether a message number is displayed in all lines of a multi-line message.

## Syntax

---

```
>>-MESSageformat--number-----<<
```

## Parameters

---

number

Select a number to specify if a message number is to be displayed only on the first line of a multi-line message or is to be displayed on all lines.

1

The message number for a message is displayed only in the first line of the message. This is the default.

2

The message number for a message is displayed in all lines of a message.

## Examples

---

```
messageformat 2
```

## MIRRORLOGDIRECTORY

---

The MIRRORLOGDIRECTORY option specifies the directory for mirroring the active log path.

All changes made to the active log directory are also written to this mirror directory. This option is appended to the options file when the DSMSEV FORMAT command is run. Typically, the directory does not need to be changed.

## Syntax

---

```
>>-MIRRorlogdirectory--dir_name-----<<
```

## Parameters

---

dir\_name

Specifies a fully qualified directory name for the active log mirror. The maximum number of characters is 175.

## Examples

---

AIX Linux

```
mirrorlogdirectory /tsm/mirrorlog
```

Windows

```
mirrorlogdirectory c:\tsmserv1\mirrorlog
```

## MOVEBATCHSIZE

---

The MOVEBATCHSIZE option specifies the number of client files that are to be moved and grouped together in a batch, within the same server transaction. This data movement results from storage pool backups and restores, migration, reclamation, and MOVE DATA operations. This option works with the MOVESIZETHRESH option.

## Syntax

---

```
                  .-1000-----.  
>>-MOVEBatchsize--+-number_of_files-+-----<<
```

## Parameters

---

number\_of\_files

Specifies a number of files between 1 and 1000. The default is 1000.

## Examples

---

```
movebatchsize 100
```

## MOVESIZETHRESH

---

The MOVESIZETHRESH option specifies, in megabytes, a threshold for the amount of data moved as a batch, within the same server transaction. When this threshold is reached, no more files are added to the current batch, and a new transaction is started after the current batch is moved.

## Syntax

---

```
                .-4096-----.  
>>-MOVESizethresh--+- megabytes+-----><
```

## Parameters

---

megabytes

Specifies the number of megabytes as an integer from 1 to 32768. The default value is 4096. This option is used with the MOVEBATCHSIZE option.

## Examples

---

```
movesizethresh 500
```

## MSGINTERVAL

---

The MSGINTERVAL option specifies the time, in minutes, between messages prompting an operator to mount a tape for the server.

## Syntax

---

```
                .-1-----.  
>>-MSGINTerval--+-minutes+-----><
```

## Parameters

---

minutes

Specifies the time interval at which the operator is prompted by the server to mount a tape. The default value is 1 minute. The minimum value is 1 minute.

## Examples

---

```
msginterval 2
```

Windows

## NAMEDPIPENAME

---

The NAMEDPIPENAME option specifies a communication method that allows processes to communicate with one another without having to know where the sender and receiver processes are located. The name acts like an alias, connecting the two processes regardless of whether they are on the same computer or across connected domains.

## Syntax

---

```
>>-NAMEDpipename--name-----><
```

## Parameters

---

name

Specifies the named pipes name for the server to use. Named pipes are ideal for running in an environment where client and server are on the same machine. No communication software is required and no setup is required.

## Examples

---

```
namedpipename    \\.\\PIPE\\TSMPIPE
```

AIX

Linux

Windows

## NDMPCONNECTIONTIMEOUT

---

The NDMPCONNECTIONTIMEOUT server option specifies the time in hours that IBM Spectrum Protect™ server waits to receive status updates during NDMP restore operations across the LAN. NDMP restore operations of large NAS file systems can have long periods of inactivity. The default is 6 hours.

## Syntax

---

```
>>-NDMPCONNECTIONTIMEOUT--+-6-----><
```

## Parameters

---

hours

The number of hours that the IBM Spectrum Protect server waits to receive status updates during an NDMP restore operation over the LAN. The default value is 6. The minimum is 1 hour. The maximum is 48 hours.

## Example

---

Specify a timeout of 10 hours before the NDMP connection times out:

```
ndmpconnectiontimeout 10
```

## NDMPCONTROLPORT

---

The NDMPCONTROLPORT option specifies the port number to be used for internal communications for certain Network Data Management Protocol (NDMP) operations. The IBM Spectrum Protect™ server does not function as a general purpose NDMP tape server.

## Syntax

---

```
>>-NDMPControlport--+-10000-----><
```

## Parameters

---

port\_number

The port number to be used for internal communications for certain NDMP operations. The port number must be from 1024 to 32767. The default is 10000.

## Examples

---

```
ndmpcontrolport 9999
```

## NDMPENABLEKEEPALIVE

---

The NDMPENABLEKEEPALIVE server option specifies whether the IBM Spectrum Protect™ server enables Transmission Control Protocol (TCP) keepalive on network data-management protocol (NDMP) control connections to network-attached storage (NAS) devices. The default is NO.

TCP keepalive is implemented within the network support of an operating system. TCP keepalive prevents a long-running, inactive connection from being closed by firewall software that detects and closes inactive connections.

Restriction: To prevent errors, do not enable TCP keepalive in certain types of environments. One example is environments that do not have firewalls between the IBM Spectrum Protect server and a NAS device. Another example is environments with firewalls that tolerate long-running, inactive connections. Enabling TCP keepalive in this type of environment can cause an idle connection to be inadvertently closed if the connection partner temporarily fails to respond to TCP keepalive packets.

### Syntax

---

```
>>-NDMPENABLEKEEPALIVES---NO---+-----><
      '-YES-'
```

### Parameters

---

NO

Disable TCP keepalive on all NDMP control connections. NO is the default.

YES

Enable TCP keepalive on all NDMP control connections. The default idle time before the first TCP keepalive packet is sent is 120 minutes.

**AIX** | **Linux** | **Windows** To change the idle time, use the NDMPKEEPIDLEMINUTES server option.

### Example

---

Enable TCP keepalive on all NDMP control connections so that inactive NDMP connections are not closed:

```
ndmpenablekeepalive yes
```

**AIX** | **Linux** | **Windows**

## NDMPKEEPIDLEMINUTES

---

The NDMPKEEPIDLEMINUTES server option specifies the amount of time, in minutes, before the operating system transmits the first Transmission Control Protocol (TCP) keepalive packet on a network data-management protocol (NDMP) control connection. The default is 120 minutes.

Prerequisite: Use this option only after you set the value of the NDMPENABLEKEEPALIVES server option to YES.

### Syntax

---

```
      .-120-----.
>>-NDMPKEEPIDLEMINUTES---+minutes+-----><
```

### Parameters

---

minutes

The number of minutes of inactivity on NDMP control connections before TCP keepalive packets are transmitted. The default value is 120. The minimum is 1 minute. The maximum is 600 minutes.

### Example

---

Specify an idle time of 15 minutes before the first TCP keepalive packet is sent:

## NDMPPORTRANGE

---

The NDMPPORTRANGE option specifies the range of port numbers through which IBM Spectrum Protect™ cycles to obtain a port number for accepting a session from a network-attached storage (NAS) device for data transfer. The default is 0,0 which means that IBM Spectrum Protect lets the operating system provide a port (ephemeral port).

If all ports specified are in use when a NAS device attempts to connect to the server, the operation fails. If a single port number is chosen (no comma and no port number for the high value), the default for the high port number is the low port number plus 100.

When Network Data Management Protocol (NDMP) data is directed to an IBM Spectrum Protect native pool, communication can be initiated from either the NDMP systems or the IBM Spectrum Protect server. If a firewall separates the server and NAS devices, it may be necessary to specify port numbers in firewall rules to allow traffic to pass to and from the NAS devices. NAS devices communicate to the IBM Spectrum Protect server the port numbers that they will use when contacting the server. The port numbers of the server are controlled with the NDMPPortrange options. Port number control for NAS devices is specific to vendors. Consult your vendor documentation.

### Syntax

---

```
>>-NDMPPortrange--port_number_low+-----+-----<<
                        ',port_number_high'
```

### Parameters

---

`port_number_low`

The low port number from which IBM Spectrum Protect starts to cycle when needing a port number for accepting session from a NAS device for data transfer. The minimum port number value is 1024.

`port_number_high`

The high port number to which IBM Spectrum Protect can cycle when needing a port number for accepting session from a NAS device for data transfer. The maximum port number value is 32767. The high port number must be the same or larger than the low port number.

### Examples

---

Specify that IBM Spectrum Protect can cycle from port numbers 1024 - 2024.

```
ndmpportrange 1024,2024
```

## NDMPREFDATAINTERFACE

---

This option specifies the IP address that is associated with the interface in which you want the server to receive all Network Data Management Protocol (NDMP) backup data.

This option affects all subsequent NDMP filer-to-server operations, but does not affect NDMP control connections, which use the system's default network interface. The value for this option is a host name or IPV4 address that is associated with one of the active network interfaces of the system on which the IBM Spectrum Protect™ server is running. This interface must be IPV4 enabled.

You can update this server option without stopping and restarting the server by using the SETOPT command.

### Syntax

---

```
>>-NDMPREFDATAINTERFACE--ip_address-----<<
```

### Parameters

---

`ip_address`



Specify an address in either dotted decimal or host name format. If you specify a dotted decimal address, it is not verified with a domain name server. If the address is not correct, it can cause failures when the server attempts to open a socket at the start of an NDMP filer-to-server backup.

Host name format addresses are verified with a domain name server. There is no default value. If a value is not set, all NDMP operations use the IBM Spectrum Protect server's network interface for receiving backup data during NDMP filer-to-server backup operations.

To clear the option value, specify the SETOPT command with a null value, "".

## Examples:

---

```
ndmpprefdatainterface net1.tucson.ibm.com
```

```
ndmpprefdatainterface 9.11.152.89
```

## NOPREEMPT

---

The server allows certain operations to preempt other operations for access to volumes and devices. You can specify the NOPREEMPT option to disable preemption. When preemption is disabled, no operation can preempt another for access to a volume, and only a database backup operation can preempt another operation for access to a device.

For example, a client data restore operation preempts a client data backup for use of a specific device or access to a specific volume.

## Syntax

---

```
>>-NOPREEMPT-----<<
```

## Parameters

---

None

## Examples

---

Disable preemption among server operations:

```
nopreempt
```

## NORETRIEVEDATE

---

The NORETRIEVEDATE option specifies that the server does not update the retrieve date of a file in a disk storage pool when a client restores or retrieves the file. This option and the MIGDELAY storage pool parameter control when the server migrates files.

If you do not specify NORETRIEVEDATE, the server migrates files after they have been in the storage pool for the number of days specified by the MIGDELAY parameter. The number of days is counted from the day that the file was stored in the storage pool or retrieved by a client, whichever is more recent. If you specify NORETRIEVEDATE, the server does not update the retrieve date of a file, and the number of days is counted from the day the file entered the disk storage pool.

If you specify this option and caching is enabled for a disk storage pool, reclamation of cached space is affected. When space is needed in a disk storage pool that contains cached files, the server gets the space by selectively erasing cached copies. Files that have the oldest retrieve dates and occupy the largest amount of space are selected for removal. When you specify NORETRIEVEDATE, the server does not update the retrieve date when a file is retrieved. This may cause cached copies to be removed even though they have recently been retrieved by a client.

## Syntax

---

```
>>-NORETRIEVEDATE-----<<
```

## Parameters

---

None.

## Examples

---

Specify that the retrieve dates of files in disk storage pools are not updated when clients restore and retrieve the files:

```
noretrievedate
```

Windows

## NPAUDITFAILURE

---

The NPAUDITFAILURE option specifies whether an event is sent to the event log when a node logs in to the server using a name that is in the Windows group but does not match the Windows account login name. To ensure that a node can access only its own data, the node name and the Windows account name must match.

## Syntax

---

```
>>-NPAUDITFailure--+Yes+-----><
                          '-No--'
```

## Parameters

---

Yes

Specifies that an event is sent to the event log when a node logs in to the server using a name that is in the Windows group. But, this name does not match the Windows account login name.

No

Specifies that an audit failure event is not sent to the event log.

## Examples

---

Specify that an event is sent to the event log when a node logs in to the server using a name that is in the Windows group. But, this name does not match the Windows account login name.

```
npauditfailure yes
```

Windows

## NPAUDITSUCCESS

---

The NPAUDITSUCCESS option specifies that an event is sent to the event log when a client node user is authenticated for access to the server through SECUREPIPE.

## Syntax

---

```
>>-NPAUDITSuccess--+Yes+-----><
                          '-No--'
```

## Parameters

---

Yes

Specifies that an event is sent to the event log when a client node user is authenticated for access to the server through SECUREPIPES.

No

Specifies that an event is not sent to the Windows log.

## Examples

---

Specify that an event is sent to the event log when a client node is authenticated for access to the server.

```
npauditsuccess yes
```

Windows

## NPBUFFERSIZE

---

The NPBUFFERSIZE option specifies the size of the Named Pipes communication buffer.

### Syntax

---

```
>>-NPBUffersize--+-kilobytes-+-----><
```

### Parameters

---

kilobytes

Specifies the size, in kilobytes, of the Named Pipes communication buffer. The default is 8.

### Examples

---

Specify a 16 KB Named Pipes communication buffer:

```
npbuffersize 16
```

Windows

## NUMBERFORMAT

---

The NUMBERFORMAT option specifies the format in which the server displays numbers.

The value of NUMBERFORMAT is overridden by the number formatting definition of the locale if the locale is successfully initialized at server startup. The locale is specified in the LANGUAGE option.

### Syntax

---

```
>>-NUMberformat--number-----><
```

### Parameters

---

number

Select a number from 1 to 6 to identify the number format used by the server. The default is 1.

- |   |          |
|---|----------|
| 1 | 1,000.00 |
| 2 | 1,000,00 |
| 3 | 1 000,00 |
| 4 | 1 000.00 |
| 5 | 1.000,00 |
| 6 | 1'000,00 |

## Examples

---

numberformat 4

## NUMOPENVOLSALLOWED

---

The NUMOPENVOLSALLOWED option specifies the number of input FILE volumes in a deduplicated storage pool that can be open at one time.

Input volumes contain data to be read during client-restore operations and server processes, such as reclamation and migration. Use this option to improve performance by reducing the frequency with which volumes are opened and closed.

Each session within a client operation or server process can have as many open FILE volumes as specified by this option. A session is initiated by a client operation or by a server process. Multiple sessions can be started within each.

During a client restore operation, volumes can remain open for the duration of a client restore operation and as long a client session is active. During a no-query restore operation, the volumes remain open until the no-query restore completes. At that time, all volumes are closed and released. However, for a classic restore operation started in interactive mode, the volumes might remain open at the end of the restore operation. The volumes are closed and released when the next classic restore operation is requested.

Set this value in the server options file or use the SETOPT command.

Tip: This option can significantly increase the number of volumes and mount points in use at any one time. To optimize performance, follow these steps:

- To set NUMOPENVOLSALLOWED, select a beginning value (the default is recommended). Monitor client sessions and server processes. Note the highest number of volumes open for a single session or process. Increase the setting of NUMOPENVOLSALLOWED if the highest number of open volumes is equal to the value specified by NUMOPENVOLSALLOWED.
- To prevent sessions or processes from having to wait for a mount point, increase the value of the MOUNTLIMIT parameter in the device-class definition. Set the value of the MOUNTLIMIT parameter high enough to allow all client sessions and server processes using deduplicated storage pools to open the number of volume specified by the NUMOPENVOLSALLOWED option. For client sessions, check the destination in the copy group definition to determine how many nodes are storing data in the deduplicated storage pool. For server processes, check the number of processes allowed for each process for the storage pool.
- A situation might occur in which a node backs up and restores or archives and retrieves concurrently to and from a deduplicated storage pool. All the mount points required for these operations increase the total number of mount points required by the node.

As a result, the node might not be able to start additional backup sessions if it already has more mount points open than what the MAXNUMMP parameter in the client-node definition allows. This can occur even though the MOUNTLIMIT for the device class was not exceeded.

To prevent backup and retrieve operations from failing, set the value of the MAXNUMMP parameter in the client-node definition to a value at least as high as the NUMOPENVOLSALLOWED option. Increase this value if you notice that the node is failing backup or retrieve operations because the MAXNUMMP value is being exceeded.

## Syntax

---

```
>>-NUMOPENVOLsallowed--number_of_open_volumes-----<<
```

## Parameters

---

number\_of\_open\_volumes

Specifies the number of input FILE volumes in a deduplicated storage pool that can be open at one time. The default is 10. The minimum value is 3. The maximum value is 999.

## Examples

---

Specify that up to 5 volumes in a deduplicated storage pool can be open at one time.

## PUSHSTATUS

---

The PUSHSTATUS option is used on spoke servers to ensure that status information is sent to the hub server. Do not update this option unless you must restore the Operations Center configuration to the preconfigured state where the IBM Spectrum Protect™ servers are not defined as hub or spoke servers.

If you must restore the Operations Center configuration to the preconfigured state, you must issue the following command on each spoke server:

```
SETOPT PUSHSTATUS NO
```

## QUERYAUTH

---

The QUERYAUTH option specifies the administrative authority level required to issue QUERY or SQL SELECT commands. By default any administrator can issue QUERY and SELECT commands. You can use this option to restrict the use of these commands.

### Syntax

---

```
>>-QUERYAuth--+-None-----+-----><
                +-System---+
                +-Policy---+
                +-Storage---+
                '-Operator-'
```

### Parameters

---

#### NOne

Any administrator can issue QUERY or SELECT commands without requiring any administrative authority.

#### SYstem

Administrators must have SYSTEM authority to issue QUERY or SELECT commands.

#### POlicy

Administrators must have POLICY authority over one or more policy domains or SYSTEM authority to issue QUERY or SELECT commands.

#### STorage

Administrators must have STORAGE authority over one or more storage pools or SYSTEM authority to issue QUERY or SELECT commands.

#### OPerator

Administrators must have OPERATOR or SYSTEM authority to issue QUERY or SELECT commands.

### Examples

---

To restrict the use of QUERY and SELECT commands to administrators with system or storage authority, enter:

```
queryauth storage
```

## RECLAIMDELAY

---

This option delays the reclamation of a SnapLock volume, allowing remaining data to expire so that there is no need to reclaim the volume.

### Syntax

---

```
>>-RECLAIMDELAY--+-number_of_days+-----><
                .-4-----.
```

## Parameters

---

number\_of\_days

Specifies the number of days to delay the reclamation of a SnapLock volume.

Before a SnapLock volume is reclaimed, the IBM Spectrum Protect™ server allows the specified number of days to pass, so that any files remaining on the volume have a chance to expire. The default reclaim delay period is 4 days and can be set anywhere from 1 to 120 days.

## Examples

---

Specify that the number of days to delay reclamation is 30 days:

```
reclaimdelay 30
```

## RECLAIMPERIOD

---

This option allows you to set the number of days for the reclamation period of a SnapLock volume.

## Syntax

---

```
                .-30-----.  
>>-RECLAIMPERIOD--+-number_of_days-+-----><
```

## Parameters

---

number\_of\_days

Specifies the number of days that are allowed for the reclamation period of a SnapLock volume.

After the retention of a SnapLock volume has expired, the IBM Spectrum Protect™ server will reclaim the volume within the specified number of days if there is still data remaining on the volume. The default reclaim period is 30 days and can be set anywhere from 7 to 365 days.

The reclamation period does not begin until the RECLAIMDELAY period has expired.

## Examples

---

Specify that the reclaim period is 45 days:

```
reclaimperiod 45
```

## REORGBEGINTIME

---

The REORGBEGINTIME option specifies the earliest time that the IBM Spectrum Protect™ server can start a table or index reorganization.

Schedule server-initiated reorganizations to start during periods when server activity is low. Use this option together with the REORGDURATION option. The REORGDURATION specifies an interval during which reorganization can start.

## Syntax

---

```
>>-REORGBEGINTime--hh:mm-----><
```

## Parameters

---

hh:mm

Specifies the time that the server can start a reorganization: The default start time 6:00 a.m. Use a 24-hour format to specify the time.

Time	Description	Values
------	-------------	--------

Time	Description	Values
hh	The hour of the day	Specify a number 00 - 23.
mm	The minute of the hour	Specify a number 00 - 59.

## Examples

---

Specify 6:00 a.m. as the earliest time that a reorganization can start.

```
reorgbegintime 06:00
```

Specify 8:30 p.m. as the earliest time that a reorganization can start.

```
reorgbegintime 20:30
```

Specify noon as the earliest time that a reorganization can start.

```
reorgbegintime 12:00
```

Specify 3:30 p.m. as the earliest time that a reorganization can start.

```
reorgbegintime 15:30
```

Specify midnight as the earliest time that a reorganization can start.

```
reorgbegintime 00:00
```

## REORGDURATION

---

The REORGDURATION option specifies an interval during which server-initiated table or index reorganization can start.

Schedule server-initiated reorganizations to start during periods when server activity is low. Use this option together with the REORGBEGINTIME option. The REORGBEGINTIME option specifies the earliest time that the server can start a reorganization.

## Syntax

---

```
>>-REORGDUration--nn-----<<
```

## Parameters

---

nn

Specifies the number of hours during which a reorganization can start. The minimum value is 1, the maximum value is 24. The default value is 24.

## Example

---

Specify an interval of four hours during which a reorganization can start.

```
reorgduration 4
```

## REPORTRETRIEVE

---

The REPORTRETRIEVE option reports on restore or retrieve operations that are performed by client nodes or administrators. The default is NO.

## Syntax

---

```
>>-REPORTRETRIEVE---YES+-----<<
      '-NO--'
```

## Parameters

---

YES

Specifies that messages will be issued to the server console and stored in the activity log whenever files are restored or retrieved from the IBM Spectrum Protect™ server. The messages will specify the name of the objects being restored or retrieved and identify the client node or administrator performing the operation.

NO

Specifies that messages will not be issued.

## Examples

---

Specify that messages will be issued and stored in the activity log whenever files are restored or retrieved from the IBM Spectrum Protect server:

```
reportretrieve yes
```

The following message is issued for an administrator client session:

```
ANR0411I Session 8 for administrator COLIND-TUC logged in as node  
COLIND-TUC restored or retrieved Backup object: node COLIND-TUC,  
fileSpace \\colind-tuc\c$, object\CODE\TESTDATA\ XXX.OUT
```

## REPLBATCHSIZE

---

The REPLBATCHSIZE option specifies the number of client files that are to be replicated in a batch, within the same server transaction. This option affects only the node replication processes and works with the REPLSIZETHRESH option to improve node replication processing.

The REPLBATCHSIZE option limits the number of files in a transaction and the REPLSIZETHRESH option limits the number of bytes in a transaction. The transaction ends when either the REPLBATCHSIZE threshold or the REPLSIZETHRESH threshold is reached.

## Syntax

---

```
.-4096-----.  
>>-REPLBatchsize---+number_of_files-+-----<<
```

## Parameters

---

number\_of\_files

Specifies a number of files between 1 - 32768. The default is 4096.

## Examples

---

```
replbatchsize 25000
```

## REPLSIZETHRESH

---

The REPLSIZETHRESH option specifies, in megabytes, a threshold for the amount of data replicated, within the same server transaction.

The amount of data is based on the non-deduplicated size of the file, which is the original size of the file. The amount of data that is replicated is controlled by the threshold. When the amount of data exceeds the threshold, the server ends the transaction and no more files are added to the current batch. A new transaction is started after the current batch is replicated. This option is used with the REPLBATCHSIZE option.

For example, suppose that a file is 10 MB and is stored in a data-deduplication-enabled storage pool and only 2 MB of the file is transferred during replication. The amount of data replicated includes the 10 MB size of the file, and excludes the 2 MB transferred. When the amount of data replicated exceeds the value specified for the REPLSIZETHRESH threshold, the transaction ends.



Tip: If you are replicating data from a source server in the cloud and frequently get an ANR1880W server message on the target server, lower the value of the REPLSIZETHRESH option on the source server.

## Syntax

---

```
                .-4096-----.  
>>-REPLSizethresh--+-megabytes+-----><
```

## Parameters

---

megabytes

Specifies the number of megabytes as an integer from 1 - 32768. The default value is 4096.

## Examples

---

```
replsizethresh 2000
```

## REQSYSAUTHOUTFILE

---

The REQSYSAUTHOUTFILE option specifies if system authority is required for administrative commands that cause IBM Spectrum Protect™ to write to an external file.

This option applies to the following commands:

- BACKUP DEVCONFIG with the FILENAMES parameter
- BACKUP VOLHISTORY with the FILENAMES parameter
- DEFINE BACKUPSET
- DELETE BACKUPSET
- GENERATE BACKUPSET
- MOVE DRMEDIA with the CMD parameter
- MOVE MEDIA with the CMD parameter
- QUERY DRMEDIA with the CMD parameter
- QUERY MEDIA with the CMD parameter
- QUERY SCRIPT with the OUTPUTFILE parameter

## Syntax

---

```
>>-REQSYSauthoutfile--+-Yes+-----><  
                        '-No--'
```

## Parameters

---

Yes

System authority is required for administrative commands that cause IBM Spectrum Protect to write to an external file.

No

System authority is not required for administrative commands that cause IBM Spectrum Protect to write to an external file. That is, there is no change to the authority level that is required to issue the command.

## Examples

---

```
reqsysauthoutfile no
```

## RESOURCETIMEOUT

---

The RESOURCETIMEOUT option specifies how long the server waits for a resource before canceling the pending acquisition of a resource. When a timeout occurs the request for the resource will be canceled.

Note: When managing a set of shared library resources, such as servers designated as library managers and clients, consider setting this option at the same time limit for all participants in the shared configuration. In any case of error recovery, IBM Spectrum Protect™ will always defer to the longest time limit.

## Syntax

---

```
                .-60-----.  
>>-RESOURCETimeout--+-minutes+-----<<
```

## Parameters

---

minutes

Specifies the maximum number of minutes that the server waits for a resource. The default value is 60 minutes. The minimum value is 1 minute.

## Examples

---

Specify that the server will wait 15 minutes for a server resource:

```
resourcetimeout 15
```

## RESTOREINTERVAL

---

The RESTOREINTERVAL option specifies how long a restartable restore session can be saved in the server database. As long as the restore session is saved in the database, it can be restarted from the point at which it stopped.

You can update this server option without stopping and restarting the server by using the SETOPT command. See SETOPT (Set a server option for dynamic update).

## Syntax

---

```
                .-1440----.  
>>-RESTOREINTERVAL--+-minutes+-----<<
```

## Parameters

---

minutes

Specifies how long, in minutes, that a restartable restore session can be in the database before it can be expired. The minimum value is 0. The maximum is 10080 (one week). The default is 1440 minutes (24 hours). If the value is set to 0 and the restore is interrupted or fails, the restore is still put in the restartable state. However, it is immediately eligible to be expired.

## Examples

---

```
restoreinterval 1440
```

## RETENTIONEXTENSION

---

The RETENTIONEXTENSION option specifies the number of days to extend the retention date of a SnapLock volume. This option allows the server to extend the retention date of a SnapLock volume in order to avoid excessive reclamation.

## Syntax

---

```
>>-RETENTIONEXTENSION--number_of_days-----<<
```

## Parameters

---

number\_of\_days

Specifies the number of days to extend the retention date of a SnapLock volume. The minimum value is 30 days; the maximum value is 9999 days; the default is 365.

If you specify a value of 0 (zero) for the RETVER parameter of an archive copy group, the actual value that is used for RETVER is the value of the option RETENTIONEXTENSION, if one of the following conditions is also true:

- The destination storage pool for the archive copy group is a SnapLock storage pool.
- The storage pool that is the target for a storage pool migration or of a MOVE DATA or MOVE NODEDATA command is a SnapLock storage pool.

If a SnapLock volume is the target volume for data from another SnapLock volume and if the remaining retention of the data on the volume is less than the value specified, then the retention date is set using the value specified. Otherwise, the remaining retention of the data is used to set the retention of the volume.

If a SnapLock volume has entered the reclamation period but the percentage of reclaimable space of the volume has not exceeded the reclamation threshold of the storage pool or the value specified on the THRESHOLD parameter of a RECLAIM STGPOOL command, then the retention date of the SnapLock volume is extended by the amount specified in the RETENTIONEXTENSION option.

## Examples

---

Specify that the retention date is extended by 60 days:

```
retentionextension 60
```

AIX

Linux

Windows

## SANDISCOVERY

---

The SANDISCOVERY option specifies whether the IBM Spectrum Protect™ SAN discovery function is enabled.

To use SAN discovery, all devices on the SAN must have a unique device serial number. When set to ON, the server completes SAN discovery in the following instances:

- When the device path is changed
- When the QUERY SAN command is issued

Using SAN discovery, the server can automatically correct the special file name for a device if it is changed for a specified tape device.

The IBM Spectrum Protect server does not require persistent binding with the SAN discovery function enabled. To display a list of devices that are seen by the server, you can issue the QUERY SAN command.

## Syntax

---

```
.-SANDISCOVERY-----OFF-----  
>>+-----+----->>  
'-SANDISCOVERY-----+ON-----+'  
      '-UNSCANNEDPATHOFF-'
```

## Parameters

---

ON

Specifies that the server completes SAN discovery when the device path is changed, or when the QUERY SAN command is issued.

OFF

Specifies that the server does not complete SAN discovery when the device path is changed, or when the QUERY SAN command is issued. If the IBM Spectrum Protect server is not able to open a device, a message is issued but the path that is associated with the device is not taken offline. This value is the default.

UNSCANNEDPATHOFF

Specifies that the server does not complete SAN discovery when the device path is changed, or when the QUERY SAN command is issued. If the IBM Spectrum Protect server is not able to open a device, a message is issued and the path to the device is taken offline.

## Examples

---

sandiscovery on

## Related commands

---

Table 1. Commands related to SANDISCOVERY

Command	Description
PERFORM LIBACTION	Defines all drives and paths for a library.

AIX | Linux | Windows

## SANDISCOVERYTIMEOUT

---

The SANDISCOVERYTIMEOUT option specifies the amount of time allowed for host bus adapters to respond when they are queried by the SAN discovery process. Once the time specified for the SANDISCOVERYTIMEOUT is reached, the process times out.

### Syntax

---

```
>>-SANDISCOVERYTIMEOUT--value-----<<
```

### Parameters

---

value

Specifies the amount of time to elapse before the SAN discovery process times out. The range is from 15 to 1800 seconds. The default is 15 seconds.

### Examples

---

```
sandiscoverytimeout 45
```

AIX | Linux | Windows

## SANREFRESHTIME

---

The SANREFRESHTIME option specifies the amount of time that elapses before the cached SAN discovery information is refreshed. The SANREFRESHTIME option has a default value of 0, which means that there is no SAN discovery cache. The information is obtained directly from the host bus adapter (HBA) every time the server performs a SAN discovery operation.

Note: The QUERY SAN server command always receives SAN information at the time that the command is issued and ignores any value specified for SANREFRESHTIME.

### Syntax

---

```
>>-SANREFRESHTIME--+-time-----<<
```

### Parameters

---

time

The length of time, in seconds, before the cached SAN discovery information is refreshed. The default value is 0 and specifies that SAN discovery information is not cached. If a value other than 0 is specified, for example, 100 seconds, then the SAN discovery information is refreshed 100 seconds after the prior SAN discovery operation.

### Examples

---

Refresh SAN discovery information after 100 seconds.

```
sanrefreshtime 100
```

Turn off the caching of SAN discovery information.

```
sanrefreshtime 0
```

## SEARCHMPQUEUE

---

The SEARCHMPQUEUE option specifies the order in which the server satisfies requests in the mount queue. If the option is specified, the server first tries to satisfy requests for volumes that are already mounted. These requests may be satisfied before other requests, even if the others have been waiting longer for the mount point. If this option is not specified, the server satisfies requests in the order in which they are received.

### Syntax

---

```
>>-SEARCHMPQUEUE-----<<
```

### Parameters

---

None

### Examples

---

Specify that the server tries to first satisfy a request for a volume that is already mounted:

```
searchmpqueue
```

**Windows**

## SECUREPIPES

---

When using the named pipes protocol, enabling SECUREPIPES forces the server to check the Windows group designated by ADMSGROUPNAME in order to authenticate a client node/user.

The user name and password defined in the Windows group are used to authenticate the node/user for access to the server data. The node/user must also be a registered IBM Spectrum Protect™ client node. However, the IBM Spectrum Protect client node password is ignored, and the Windows password associated with the user is used.

### Syntax

---

```
>>-SECUREPipes--+-Yes-+-----<<  
                '-No--'
```

### Parameters

---

Yes

Specifies that IBM Spectrum Protect checks the Windows group designated by ADMSGROUPNAME in order to authenticate a client node/user.

No

Specifies that IBM Spectrum Protect does not check the Windows group designated by ADMSGROUPNAME in order to authenticate a client node/user.

### Examples

---

Specify that IBM Spectrum Protect checks the Windows group to authenticate client nodes.

```
securepipes yes
```

## SERVERDEDUPTXNLIMIT

---

---

The SERVERDEDUPTXNLIMIT option specifies the maximum size of objects that can be deduplicated on the server.

When you use duplicate-identification processes (the IDENTIFY DUPLICATES command) for large objects, intensive database activity can result from long-running transactions that are required to update the database. High levels of database activity can produce following symptoms:

- Reduced throughput for client backup and archive operations
- Resource contention resulting from concurrent server operations
- Excessive recovery log activity

The extent to which these symptoms occur depends on the number and size of objects being processed, the intensity and type of concurrent operations taking place on the IBM Spectrum Protect™ server, and the IBM Spectrum Protect server configuration.

With the SERVERDEDUPTXNLIMIT server option, you can specify a maximum size, in gigabytes, for objects that can be deduplicated on the server. If an object or set of objects in a single transaction exceeds the limit specified by SERVERDEDUPTXNLIMIT, the objects are not deduplicated by the server. You can specify a value 32 - 102400 GB. The default value is 5120 GB.

Increasing the value of this option causes the IBM Spectrum Protect server to search for objects previously deferred whose size falls below the new transaction limit.

Remember: The search for objects previously deferred can take time. Use care when increasing the value of SERVERDEDUPTXNLIMIT. Reducing the value of this option does not cause IBM Spectrum Protect to search for deferred objects.

The appropriate value for this option depends on the IBM Spectrum Protect server configuration and concurrent server activity. You can specify a high value for this option if you minimize resource contention. To minimize resource contention, perform operations, such as backup, archive, duplicate identification, and reclamation, at different times.

To update this server option without stopping and restarting the server, use the SETOPT command.

## Syntax

---

```
                .-5120-----.  
>>-SERVERDEDUPTXNlimit--+-gigabytes-+-----><
```

## Parameters

---

gigabytes

Specifies the maximum size, in gigabytes, of objects that can be duplicated on the server. You can specify a value 32 - 102400. The default value is 5120.

## Examples

---

Disable server-side deduplication for all objects over 120 GB:

```
serverdeduptxnlimit 120
```

## SHMPORT

---

**AIX** | **Linux** The SHMPORT option specifies the TCP/IP port address of a server when using shared memory. All shared memory communications start with a TCP/IP connection. **Windows** The SHMPORT option specifies the port that the server listens on for shared memory connections.

## Syntax

---

```
>>-SHMPort--port_number-----><
```

## Parameters

---

port\_number

Specifies the port number. **AIX** | **Linux** You can specify a value from 1024 to 32767. The default value is 1510.

**Windows** You can specify a value from 1 to 32767. The default value is 1.

## Examples

---

**AIX** | **Linux**  
shmport 1580

**Windows**  
shmport 1

## SHREDDING

---

The SHREDDING option specifies whether shredding of deleted sensitive data is performed automatically or manually. Shredding applies only to data in storage pools that have been explicitly configured to support shredding.

### Syntax

---

```
>>-SHREDDing---+AUTOMATIC+-----<<  
      '-MANual----'
```

### Parameters

---

**AUTOMATIC**

Specifies that shredding occurs automatically as sensitive data is deleted. Use this option to shred sensitive data as soon as possible after it is deleted. If the SHREDDING option is not specified, this is the default behavior. If there is an I/O error during automatic shredding, an error is reported, and shredding of the current object halts. If the I/O error cannot be corrected, you might need to run shredding manually and use the IOERROR keyword.

**MANual**

Specifies that shredding occurs manually, only when the SHRED DATA command is invoked. Use this option to control when shredding takes place, in order to ensure that it does not interfere with other server activities.

Tip: If you specify manual shredding, run the SHRED DATA command regularly, at least as often as you perform other routine server-maintenance tasks (for example, expiration, reclamation, and so on). Doing so can prevent performance degradation of certain server processes (in particular, migration). For best results, run SHRED DATA after any operation (for example, expiration and migration) that deletes files from a shred pool.

## Examples

---

Specify that IBM Spectrum Protect™ automatically shreds data in a storage pool configured for shredding after that data is deleted:

```
shredding automatic
```

## SNMPHEARTBEATINTERVAL

---

The SNMPHEARTBEATINTERVAL option specifies the interval in minutes between queries of the IBM Spectrum Protect™ server.

### Syntax

---

```
..-5-----.  
>>-SNMPHEARTBEATINTERVAL---+minutes+-----<<
```

### Parameters

---

**minutes**

Specifies the heartbeat interval in minutes. Valid values are from 0 to 1440 (one day). The default is 5 minutes.

## Examples

---

```
snmpheartbeatinterval 20
```

## SNMPMESSAGECATEGORY

---

The SNMPMESSAGECATEGORY option specifies the trap types used when messages are forwarded from the server, through the Simple Network Management Protocol (SNMP) subagent, to the SNMP manager.

### Syntax

---

```
>>-SNMPMESSAGECATEGORY---+SEVERITY---+----->>  
    '-INDIVIDUAL-'
```

### Parameters

---

#### SEVERITY

Specifies that there are four trap types based on message severity level:

- 1        Severe
- 2        Error
- 3        Warning
- 4        Information

This is the default.

#### INDIVIDUAL

Specifies that a separate trap type is used for each message. The numeric part of the message identifier indicates the trap type.

## Examples

---

```
snmpmessagecategory individual
```

## SNMPSUBAGENT

---

The SNMPSUBAGENT option specifies the parameters needed for the IBM Spectrum Protect™ subagent to communicate with the Simple Network Management Protocol (SNMP) daemon. This option is only to configure the SNMP subagent for communicating with the SNMP agent; it is ignored by the server.

### Syntax

---

```
>>-SNMPSUBAGENT---+----->  
    '-HOSTname--host_name-'  
  
>---+-----><  
    '-COMMunityname--community_name-' '-TIMEOUT--seconds-'
```

### Parameters

---

#### HOSTname host\_name

Specifies the TCP/IP name or number of the host running the SNMP agent that the IBM Spectrum Protect SNMP subagent connects to. This parameter is optional. The default name is *localhost*.

#### COMMunityname community\_name



Specifies the configured community name on the system running the SNMP agent. This parameter is optional. The default name is *public*.

TIMEOUT seconds

Specifies the time, in seconds, in which a request must be received. This parameter is optional. The default value is 600.

## Examples

---

```
snmpsubagent hostname jimbo communityname public timeout 2600
```

## SNMPSUBAGENTHOST

---

The SNMPSUBAGENTHOST option specifies the location of the IBM Spectrum Protect™ Simple Network Management Protocol (SNMP) subagent. The default for this option is 127.0.0.1.

## Syntax

---

```
>>-SNMPSUBAGENTHOST--host_name-----<<
```

## Parameters

---

host\_name

Specifies the TCP/IP host name or number on which the IBM Spectrum Protect SNMP subagent is located. The subagent and server must be on the same node.

## Examples

---

```
snmpsubagenthost 9.116.23.450
```

## SNMPSUBAGENTPORT

---

The SNMPSUBAGENTPORT option specifies the port number of the IBM Spectrum Protect™ Simple Network Management Protocol (SNMP) subagent.

## Syntax

---

```
>>-SNMPSUBAGENTPORT--port_number-----<<
```

## Parameters

---

port\_number

Specifies the port number of the IBM Spectrum Protect SNMP subagent. Valid values are 1000 - 32767. The default is 1521.

## Examples

---

```
snmpsubagentport 1525
```

## SSLFIPSMODE

---

The SSLFIPSMODE option specifies whether the Federal Information Processing Standards (FIPS) mode is in effect for Secure Sockets Layer (SSL). The default is NO.

Because SSLv3 is not supported by FIPS mode, when you are using SSL with Version 6.1 or V5.5 clients, you must turn off FIPS mode.

## Syntax

---

```

.-SSLFIPSMODE-----No-----
>>+-----+-----><
'-SSLFIPSMODE-----+No--+-'
      '-Yes-'

```

## Parameters

---

### No

Specifies that SSL FIPS mode is not active on the server. This setting is required when Backup-Archive Client versions previous to IBM Spectrum Protect™ 6.3 are to connect to the server with SSL.

### Yes

A value of YES indicates that SSL FIPS mode is active on the server. This setting restricts SSL session negotiation to use FIPS-approved cipher suites. Specifying YES is suggested when SSL communication is activated and all Backup-Archive Clients are at V6.3 or later.

To disable SSL FIPS mode on the server:

```
SSLFIPSMODE no
```

## SSLINITTIMEOUT

---

The SSLINITTIMEOUT option specifies the time, in minutes, that the server waits for a Secure Sockets Layer (SSL) session to complete initialization before the server cancels the session.

When you specify this option, an SSL session is canceled if a client, server, or storage agent is not configured for SSL and tries to start an SSL session. Similarly, an SSL session is canceled if a client SSL session and a server are not configured with the same Transport Layer Security (TLS) version. In these situations, the SSL session might fail to completely initialize. The server cancels the session when the specified timeout is reached.

## Syntax

---

```

.-2-----
>>-SSLINITTIMEout--+minutes-+-----><

```

## Parameters

---

### minutes

Specifies the maximum number of minutes that a server waits for an SSL session to complete initialization. The default value is 2 minutes. The minimum value is 1 minute.

## Example

---

```
sslinittimeout 1
```

## SSLTCPADMINPORT

---

The SSLTCPADMINPORT option specifies the port address on which the server TCP/IP communication driver waits for requests for SSL-enabled sessions only. The sessions are for the command-line administrative client.

Note: Beginning with IBM Spectrum Protect™ Version 8.1.2, you are no longer required to use the SSLTCPADMINPORT or SSLTCPADMINPORT option to allow SSL-enabled sessions from the client. The port number that is specified in the TCPADMINPORT or TCPADMINPORT option listens for both TCP/IP and SSL-enabled client sessions.

The following types of sessions do not use the Secure Sockets Layer (SSL) protocol:

- Network Data Management Protocol (NDMP)
- Automated Cartridge System Library Software (ACSL)
- Database restore operations

If the ADMINONCLIENTPORT option is set to NO, SSL-enabled sessions for the administrative client require that different port numbers are set for the SSLTCPADMINPORT and SSLTCPPOINT options.

The TCP/IP communications driver must be enabled with COMMMETHOD TCPIP or COMMMETHOD V6TCPIP.

## Syntax

---

```
>>-SSLTCPADMINPort--port_number-----<<
```

## Parameters

---

port\_number

Specifies the port number of the server. Valid values are 1024 - 32767. There is no default.

## Examples

---

```
ssltcpadminport 1543
```

## SSLTCPPOINT

---

The SSLTCPPOINT option specifies the Secure Sockets Layer (SSL) port number for SSL-enabled sessions only. The server TCP/IP communication driver waits for requests on this port for SSL-enabled sessions from the client.

Important: Beginning with IBM Spectrum Protect™ Version 8.1.2, you are no longer required to use the SSLTCPPOINT or SSLTCPADMINPORT option to allow SSL-enabled sessions from the client. The port number that is specified in the TCPPOINT or TCPADMINPORT option listens for both TCP/IP and SSL-enabled client sessions.

The following types of sessions do not use SSL:

- Network Data Management Protocol (NDMP)
- Automated Cartridge System Library Software (ACSLs)
- Database restore operations

If the ADMINONCLIENTPORT option is set to NO, SSL-enabled sessions for the administrative client require that different port numbers are specified for the SSLTCPADMINPORT and SSLTCPPOINT options.

If you specify the same port number for the SSLTCPPOINT and TCPPOINT options, only SSL connections are accepted and TCP/IP connections are disabled for the port.

The TCP/IP communications driver must be enabled with COMMMETHOD TCPIP or COMMMETHOD V6TCPIP.

## Syntax

---

```
>>-SSLTCPPOINT--port_number-----<<
```

## Parameters

---

port\_number

Specifies the port number of the server. Valid values are 1024 - 32767. There is no default.

## Examples

---

```
ssltcpport 1542
```

## TCPADMINPORT

---

The TCPADMINPORT option specifies the port number on which the server TCP/IP communication driver waits for requests for TCP/IP and SSL-enabled sessions other than client sessions. This includes administrative sessions, server-to-server sessions, storage agent sessions, library client sessions, managed server sessions, and event server sessions.

Using different port numbers for the options TCPSPORT and TCPADMINPORT enables you to create one set of firewall rules for client sessions and another set for the previously listed session types. By using the SESSIONINITIATION parameter of REGISTER NODE and UPDATE NODE commands, you can close the port specified by TCPSPORT at the firewall, and specify nodes whose scheduled sessions will be started from the server. If the two port numbers are different, separate threads are used to service client sessions and the session types. If you allow the two options to use the same port number (by default or by explicitly setting them to the same port number), a single server thread is used to service all session requests.

Client sessions attempting to use the port specified by TCPADMINPORT are terminated (if TCPSPORT and TCPADMINPORT specify different ports). Administrative sessions are allowed on either port, (unless the ADMINONCLIENTPORT option is set to NO) but by default administrative sessions use the port that is specified by TCPADMINPORT.

SSL-enabled sessions that use the TCPADMINPORT option have the same limitations as the SSLTCPADMINPORT option. The following types of sessions do not use the Secure Sockets Layer (SSL) protocol:

- Network Data Management Protocol (NDMP)
- Automated Cartridge System Library Software (ACSLs)
- Database restore operations

If the ADMINONCLIENTPORT option is set to NO, SSL-enabled sessions for the administrative client require that different port numbers are specified for the TCPADMINPORT and TCPSPORT options.

## Syntax

---

```
>>-TCPADMINPort--port_number-----<<
```

## Parameters

---

port\_number

Specifies the port number of the server. Valid values are 1024 - 32767. The default is the value of TCPSPORT.

## Examples

---

```
tcpadminport 1502
```

AIX | Linux

## TCPBUFSIZE

---

The TCPBUFSIZE option specifies the size of the buffer used for TCP/IP send requests. During a restore, client data moves from the IBM Spectrum Protect™ session component to a TCP communication driver. The TCPBUFSIZE option determines if the server sends the data directly from the session buffer or copies the data to the TCP buffer. A 32 KB buffer size forces the server to copy data to its communication buffer and flush the buffer when it fills.

Note: This option is not related to the TCPWINDOWSIZE option.

## Syntax

---

```
>>-TCPBufsize--kilobytes-----<<
```

## Parameters

---

kilobytes

Specifies the size, in kilobytes, of the buffer used for TCP/IP send requests.

AIX | The value range is from 1 to 64. The default is 32.

Linux | The value range is from 1 to 64. The default is 16.

## Examples

---

## TCPNODELAY

---

The TCPNODELAY option specifies whether the server disables the delay of sending successive small packets on the network.

Change the value from the default of YES only under one of these conditions:

- You are directed to change the option by your service representative.
- You fully understand the effects of the TCP Nagle algorithm on network transmissions. Setting the option to NO enables the Nagle algorithm, which delays sending small successive packets.

### Syntax

---

```
>>-TCPNodeLay--+-+Yes-+----->>
                '-No--'
```

### Parameters

---

Yes

Specifies that the server allows successive small packets to be sent immediately over the network. Setting this option to YES might improve performance in some high-speed networks. The default is YES.

No

Specifies that the server does not allow successive small packets to be sent immediately over the network.

### Examples

---

```
tcpnodelay no
```

## TCPPORT

---

The TCPPORT option specifies the port number on which the server TCP/IP communication driver waits for requests for client sessions. The server TCP/IP communication driver listens on this port for both TCP/IP and SSL-enabled sessions from the client.

Using different port numbers for the options TCPPORT and TCPADMINPORT enables you to create one set of firewall rules for client sessions and another set for other session types (administrative sessions, server-to-server sessions, storage agent sessions, library client sessions, managed server sessions, and event server sessions). If the two port numbers are different, separate threads are used to service client sessions and the other session types. If you allow the two options to use the same port number (by default or by explicitly setting them to the same port number), a single server thread is used to service all session requests.

SSL-enabled client sessions that use the TCPPORT option have the same limitations as the SSLTCPPORT option. The following types of sessions do not use SSL:

- Network Data Management Protocol (NDMP)
- Automated Cartridge System Library Software (ACSL)
- Database restore operations

If the ADMINONCLIENTPORT option is set to NO, SSL-enabled sessions for the administrative client require that different port numbers are specified for the TCPADMINPORT and TCPPORT options.

If you specify the same port number for both the SSLTCPPORT and TCPPORT options, only SSL connections are accepted and TCP/IP connections are disabled for the port.

**Windows** You can change this option with the SETOPT command. When you change a port, the IBM Spectrum Protect™ server starts listening on the new port immediately. All current connections remain in use until closed.

### Syntax

---

```
>>-TCPPort--port_number----->>
```

## Parameters

---

port\_number

Specifies the port number of the server. Valid values are 1024 - 32767. The default value is 1500.

tcpport 1500

## TCPWINDOWSIZE

---

The TCPWINDOWSIZE option specifies, in kilobytes, the amount of receive data that can be buffered at one time on a TCP/IP connection. The sending host cannot send more data until it receives an acknowledgment and a TCP receive window update. Each TCP packet contains the advertised TCP receive window on the connection. A larger window lets the sender continue sending data, and may improve communication performance, especially on fast networks with high latency.

Note:

- To improve backup performance, increase the TCPWINDOWSIZE on the server. To improve restore performance, increase the TCPWINDOWSIZE on the client.
- The TCP window acts as a buffer on the network.
- A window size larger than the buffer space on the network adapter might degrade throughput due to resending packets that were lost on the adapter.
- **AIX** | **Linux** The TCPWINDOWSIZE option is not related to the TCPBUFFSIZE option nor to the send and receive buffers allocated in client or server memory.

## Syntax

---

```
>>-TCPWindowsize--kilobytes-----<<
```

## Parameters

---

kilobytes

Specifies the size you want to use, in kilobytes, for the TCP/IP sliding window for your client node. You can specify a value from 0 to 2048. The default is 63. If you specify 0, the server uses the default window size set by the operating system. Values from 1 to 2048 indicate that the window size is in the range of 1 KB to 2 MB.

## Examples

---

```
tcpwindowsize 63
```

## TECBEGINEVENTLOGGING

---

The ECBEGINEVENTLOGGING option specifies whether event logging for the Tivoli® receiver should begin when the server starts up. If the TECHOST option is specified, ECBEGINEVENTLOGGING defaults to YES.

## Syntax

---

```
>>-TECBegineventlogging--+-Yes+-----<<  
                        '-No--'
```

## Parameters

---

Yes

Specifies that event logging begins when the server starts up and if a TECHOST option is specified.

No

Specifies that event logging should not begin when the server starts up. To later begin event logging to the TIVOLI receiver (if the TECHOST option has been specified), you must issue the BEGIN EVENTLOGGING command.

## Examples

---

```
tecbegineventlogging yes
```

## TECHOST

---

The TECHOST option specifies the host name or IP address for the Tivoli® event server.

### Syntax

---

```
>>-TECHost--host_name-----<<
```

### Parameters

---

**host\_name**  
Specifies the host name or IP address for the Tivoli event server.

## Examples

---

```
techost 9.114.22.345
```

## TECPORT

---

The TECPORT option specifies the TCP/IP port address on which the Tivoli® event server is listening. This option is only required if the Tivoli event server is on a system that does not have a Port Mapper service running.

### Syntax

---

```
>>-TECPort--port_number-----<<
```

### Parameters

---

**port\_number**  
Specifies the Tivoli event server port address. The value must be between 0 and 32767. AIX Linux This option is not required.

## Examples

---

```
tecport 1555
```

## TECUTF8EVENT

---

The TECUTF8EVENT option allows the IBM Spectrum Protect™ administrator to send information to the Tivoli Enterprise Console® (TEC) server in UTF-8 data format. The default is No. You can display whether or not this option is enabled by issuing the QUERY OPTION command.

### Syntax

---

```
>>-TECUTF8event--+-Yes+-----<<  
                '-No--'
```

### Parameters

---

Yes

Specifies that the IBM Spectrum Protect server will encode the TEC event into UTF-8 before issuing the event to the TEC server.

No

Specifies that IBM Spectrum Protect server will not encode the TEC event into UTF-8 and it will be issued to the TEC server in ASCII format.

## Examples

---

```
tecutf8event yes
```

## THROUGHPUTDATATHRESHOLD

---

The THROUGHPUTDATATHRESHOLD option specifies a throughput threshold that a client session must reach to prevent being canceled after the time threshold is reached.

This option is used in conjunction with the THROUGHPUTTIMETHRESHOLD server option, which sets the value for the time threshold plus the media wait time. The time threshold starts when the client begins sending data to the server for storage (as opposed to setup or session housekeeping data).

You can update this server option without stopping and restarting the server by using the SETOPT command. See SETOPT (Set a server option for dynamic update).

## Syntax

---

```
>>-THROUGHPUTDatathreshold-- kilobytes_per_second-----<<
```

## Parameters

---

*kilobytes\_per\_second*

Specifies the throughput that client sessions must achieve to prevent cancellation after THROUGHPUTTIMETHRESHOLD minutes have elapsed. This threshold does not include time spent waiting for media mounts. A value of 0 prevents examining client sessions for insufficient throughput. Throughput is computed by adding send and receive byte counts and dividing by the length of the session. The length does not include time spent waiting for media mounts and starts at the time a client sends data to the server for storage. The default is 0. The minimum value is 0; the maximum is 99999999.

## Examples

---

Specify that the server is to wait until 90 minutes plus the media wait time after a session has started sending data before storage examines it as a candidate for cancellation due to low throughput. If a session is not achieving 50 KB per second in transfer rates, it will be canceled.

```
throughputtimethreshold 90  
Throughputdatathreshold 50
```

## THROUGHPUTTIMETHRESHOLD

---

The THROUGHPUTTIMETHRESHOLD option specifies the time threshold for a session after which it may be canceled for low throughput.

You can update this server option without stopping and restarting the server by using the SETOPT command. See SETOPT (Set a server option for dynamic update).

## Syntax

---

```
>>-THROUGHPUTTimethreshold--minutes-----<<
```

## Parameters

---



minutes

Specifies the threshold for examining client sessions and canceling them if the data throughput threshold is not met (see the THROUGHPUTDATATHRESHOLD server option). This threshold does not include time spent waiting for media mounts. The time threshold starts when a client begins sending data to the server for storage (as opposed to setup or session housekeeping data). A value of 0 prevents examining client sessions for low throughput. The default is 0. The minimum value is 0; the maximum is 99999999.

## Examples

---

Specify that the server is to wait until 90 minutes plus the media wait time after a session has started sending data before examining it as a candidate for cancellation. If a session is not achieving 50 thousand bytes per second in transfer rates, it will be canceled.

```
throughputtimethreshold 90  
Throughputdatathreshold 50
```

Windows

## TIMEFORMAT

---

The TIMEFORMAT option specifies the format in which time is displayed by the server.

The value for the TIMEFORMAT option is overridden by the time formatting definition of the locale if the locale is successfully initialized at server startup. The locale is specified in the LANGUAGE option.

## Syntax

---

```
>>-TIMEformat--format_number-----<<
```

## Parameters

---

format\_number

Select a number from 1 to 4 to identify the time format used by the server. The default is 1.

- |   |                      |
|---|----------------------|
| 1 | hh:mm:ss             |
| 2 | hh,mm,ss             |
| 3 | hh.mm.ss             |
| 4 | hh:mm:ss a.m or p.m. |
| 5 | a.m or p.m. hh:mm:ss |

## Examples

---

```
timeformat 4
```

## TXNGROUPMAX

---

The TXNGROUPMAX option specifies the number of objects that are transferred as a group between a client and the server between transaction commit points. The minimum value is 4 objects and the maximum value is 65000 objects. The default value is 4096 objects. The objects transferred are actual files, directories, or both. The server counts each file or directory as one object.

It is possible to affect the performance of client backup, archive, restore, and retrieve operations by using a larger value for this option:

1. If you increase the value of the TXNGROUPMAX option by a large amount, watch for possible effects on the recovery log. A larger value for the TXNGROUPMAX option can result in increased utilization of the recovery log, as well as an increased

length of time for a transaction to commit. If the effects are severe enough, they can lead to problems with operation of the server.

2. Increasing the value of the TXNGROUPMAX option can improve throughput for operations storing data directly to tape, especially when storing a large number of objects. However, a larger value of the TXNGROUPMAX option can also increase the number of objects that must be resent in the case where the transaction is stopped because an input file changed during backup, or because a new storage volume was required. The larger the value of the TXNGROUPMAX option, the more data must be resent.
3. Increasing the TXNGROUPMAX value will affect the responsiveness of stopping the operation and the client may have to wait longer for the transaction to complete.

You can override the value of this option for individual client nodes. See the TXNGROUPMAX parameter in REGISTER NODE (Register a node) and UPDATE NODE (Update node attributes).

This option is related to the TXNBYTELIMIT option in the client options file. TXNBYTELIMIT controls the number of bytes, as opposed to the number of objects, that are transferred between transaction commit points. At the completion of transferring an object, the client commits the transaction if the number of bytes transferred during the transaction reaches or exceeds the value of TXNBYTELIMIT, regardless of the number of objects transferred.

## Syntax

---

```
>>-TXNGroupmax--number_of_objects-----<<
```

## Parameters

---

number\_of\_objects

Specifies a number from 4 to 65000 for the maximum number of objects per transaction. The default is 4096.

## Examples

---

```
txngroupmax 4096
```

## UNIQUETDPTECEVENTS

---

The UNIQUETDPTECEVENTS option generates a unique Tivoli Enterprise Console® (TEC) event class for each individual IBM Spectrum Protect™ message, including client, server, and IBM Spectrum Protect Data Protection client messages. The default is No.

## Syntax

---

```
>>-UNIQUETDPtecevents---+Yes+-----<<  
                        '-No--'
```

## Parameters

---

Yes

Specifies that unique IBM Spectrum Protect Data Protection messages are sent to the TEC event server. Dynamically sets UNIQUETEEvents to YES.

No

Specifies that general messages are sent to the TEC event server.

## Examples

---

```
uniquetdptecevents yes
```

## UNIQUETECEVENTS

---

The UNIQUETECEVENTS option generates a unique Tivoli Enterprise Console® (TEC) event class for each individual IBM Spectrum Protect™ message. The default is No.

## Syntax

---

```
>>-UNIQUETECEvents---Yes+-----><
      '-No--'
```

## Parameters

---

- Yes  
Specifies that unique messages are sent to the TEC event server.
- No  
Specifies that general messages are sent to the TEC event server.

## Examples

---

```
uniquetecevents yes
```

## USEREXIT

---

The USEREXIT option specifies a user-defined exit that will be given control to manage an event.

## Syntax

---

```
>>-USEREXIT---Yes+---module_name---(1)---DLL_name---(2)----->
      '-No--'
```

```
>>-function---(3)-----><
```

Notes:

1. *module\_name* is available only on AIX, HP-UX, Linux, Solaris, and z/OS.
2. *DLL\_name* is available only on Windows.
3. *function* is available only on Windows.

## Parameters

---

- Yes  
Specifies that event logging to the user exit receiver begins automatically at server startup.
- No  
Specifies that event logging to the user exit receiver does not begin automatically at server startup. When this parameter has been specified, you must begin event logging manually by issuing the BEGIN EVENTLOGGING command.
- AIX** | **Linux** *module\_name*  
**AIX** | **Linux** Specifies the module name of the user exit.
- AIX** | **Linux** This is the name of a shared library containing the exit. The module name can be either a fully qualified path name or just the module name itself. If it is just the module name, it is loaded from the current directory.
- Windows** *DLL\_name*  
**Windows** Specifies the DLL name that contains the user-exit function.
- Windows** *function*  
**Windows** Specifies the name of the user-exit function in the DLL.

## Examples

---

```
Windows  
userexit yes dllname.dll dllmodulename
```

**AIX** | **Linux**

```
userexit yes fevent.exit
```

## VERBCHECK

---

The VERBCHECK option specifies that the server will do additional error checking on the structure of commands sent by the client. This option should only be enabled when the client sends incorrectly formed requests to the server, causing the server to crash. When this option is enabled, you will get a protocol error instead of a server crash.

### Syntax

---

```
>>-VERBCHECK-----<<
```

### Parameters

---

None

### Examples

---

Enable additional error checking for commands sent by the client:

```
verbcheck
```

## VOLUMEHISTORY

---

The VOLUMEHISTORY option specifies the name of files to be automatically updated whenever server sequential volume history information is changed. There is no default for this option.

You can include one or more VOLUMEHISTORY options in the server options file. When you use multiple VOLUMEHISTORY options, the server automatically updates and stores a backup copy of the volume history information in each file you specify.

### Syntax

---

```
>>-VOLUMEHistory--file_name-----<<
```

### Parameters

---

file\_name

Specifies the name of the file where you want the server to store a backup copy of the volume history information that it collects.

### Examples

---

```
volumehistory volhist.out
```

## Server utilities

---

Use server utilities to perform special tasks on the server while the server is not running.

- **Windows** DSMMAXSG (Increase the block size for writing data)  
Use the DSMMAXSG utility to increase the maximum transfer length for host bus adapters (HBAs). As a result, the block size that is used by the IBM Spectrum Protect™ server for writing data to and getting data from certain types of tape drives is increased.
- DSMSERV (Start the server)  
Use this utility to start the IBM Spectrum Protect server.
- **AIX** | **Linux** Server startup script: rc.dsmserv  
You can use the rc.dsmserv script in your system startup to automatically start a server instance under a specific user ID.

- **Linux** Server startup script: dmserv.rc  
You can use the dmserv.rc script to stop a server instance, or to manually or automatically start a server.
- DSMSEV DISPLAY DBSPACE (Display information about database storage space)  
Use this utility to display information about storage space that is defined for the database. The output of this utility is the same as the output of the QUERY DBSPACE command, but you can use this utility when the server is not running.
- DSMSEV DISPLAY LOG (Display recovery log information)  
Use this utility to display information about recovery logs including the active log, the mirror for the active log, the failover directory for the archive log, and the overflow location for logs. Use this utility when the server is not running.
- DSMSEV EXTEND DBSPACE (Increase space for the database)  
Use this utility to increase space for the database by adding directories for the database to use. This utility performs the same function as the EXTEND DBSPACE command, but you can use it when the server is not running.
- DSMSEV FORMAT (Format the database and log)  
Use the DSMSEV FORMAT utility to initialize the server database and recovery log. No other server activity is allowed while initializing the database and recovery log.
- DSMSEV INSERTDB (Move a server database into an empty database)  
Use the DSMSEV INSERTDB utility to move a server database into a new database. The database can be extracted from the original server and inserted into a new database on the new server by using a network connection between the two servers. The database can also be inserted from media that contains the extracted database.
- DSMSEV LOADFORMAT (Format a database)  
Use the DSMSEV LOADFORMAT utility when upgrading from Version 5. The utility formats an empty database in preparation for inserting an extracted database into the empty database.
- DSMSEV REMOVEDB (Remove a database)  
Use the DSMSEV REMOVEDB utility to remove an IBM Spectrum Protect server database.
- DSMSEV RESTORE DB (Restore the database)  
Use this utility to restore a database by using a database backup.
- **Windows** DSMSEV UPDATE (Create registry entries for a server instance)  
Use this utility to create registry entries for an IBM Spectrum Protect server instance if the entries were accidentally deleted.
- **AIX** DSMULOG (Capture IBM Spectrum Protect server messages to a user log file)  
Use this command to capture IBM Spectrum Protect server console messages to a user log file. You can specify that IBM Spectrum Protect write messages to more than one user log file.

**Windows**

## DSMMAXSG (Increase the block size for writing data)

Use the DSMMAXSG utility to increase the maximum transfer length for host bus adapters (HBAs). As a result, the block size that is used by the IBM Spectrum Protect™ server for writing data to and getting data from certain types of tape drives is increased.

With this utility, the maximum block size that you can specify is 256 KB. Depending on your system environment, increasing the block size can improve the rate at which IBM Spectrum Protect processes data for backup and restore operations and for archive and retrieve operations. However, the utility does not affect the generation of backup sets.

You can use tape drives that are only attached to SCSI or Fibre Channel HBAs and that have the following device types:

- 3590
- 3592
- DLT
- ECARTRIDGE
- LTO

The utility runs automatically as part of the IBM Spectrum Protect server and storage agent installation. However, if you install a new HBA on your system after you install a server or storage agent, or if you install a new version of an existing HBA device driver that resets the value of the maximum transfer size, you must run the utility manually to take advantage of the larger block size.

When you run this utility, it modifies one registry key for every HBA driver on the system. The name of the key is MaximumSGList.

Restriction: If data is backed up or archived to tape using the 256 KB block size, the tape cannot be appended to or read from using an HBA that does not support the 256 KB block size. For example, if you use a 256 KB Windows system to back up client data to the IBM Spectrum Protect server, you cannot restore the data using a Windows system that supports a different transfer length. To append to or read from tape written to using a 256 KB transfer length, you must install an HBA that supports 256 KB transfers.

## Syntax

```
>>-dsmmaxsg----->>
```

### Example: Increase the block size for writing data

Run the DSMMAXSG utility to increase the block size that is used by the IBM Spectrum Protect.

```
dsmmaxsg
```

## DSMSERV (Start the server)

Use this utility to start the IBM Spectrum Protect™ server.

Restrictions:

- Do not enter more than 1022 characters in the DSMSERV console command-line interface. Text that exceeds 1022 characters is truncated.
- **Windows** The following parameters are mutually exclusive:
  - NOEXPIRE
  - RUNFILE
  - MAINTENANCE

AIX | Linux | Windows

## Syntax

```
>>-DSMSERV----->
| (1) |
|----- -u--user_name-|
|
| (2) .- -k--Server1--.
|----- -i--instance_dir-| |----- -k--key_name-|
|
| (1) | | (3) |
|----- -noexpire-| |-----NOEXPIRE-|
|
|----- -o--options_file-| | (1) |
|----- -quiet-|
|
|----->>
+-RUNFILE--file_name-+
| (4) |
|-----MAINTenance-----|
```

Notes:

1. This parameter applies only to AIX® and Linux servers.
2. This parameter applies only to Windows servers.
3. This parameter applies only to Windows servers.
4. This parameter applies only to AIX, Linux, and Windows servers.

AIX | Linux | Windows

## Parameters

AIX | Linux -u user\_name

AIX | Linux Specifies a user name to switch to before you start the server. To start the server from the root user ID, you must specify the -u parameter and follow the instructions in Starting the server from the root user ID.

**AIX** | **Linux** `-i instance_dir`  
**AIX** | **Linux** Specifies an instance directory to use. The instance directory becomes the current working directory of the server.

**Windows** `-k key_name`  
**Windows** Specifies the name of the Windows registry key from which to retrieve information about the server. The default is Server1.

**AIX** | **Linux** `-noexpire`  
**AIX** | **Linux** Specifies that the server does not remove expired files from the server database. The files are not deleted from server storage when you start the server.

**Windows** `NOEXPIRE`  
**Windows** Specifies that the server does not remove expired files from the server database. The files are not deleted from server storage when you start the server.

`-o options_file`  
 Specifies an options file to use.

**AIX** | **Linux** `-quiet`  
**AIX** | **Linux** Specifies that messages to the console are suppressed.

**AIX** | **Linux** | **Windows** `MAINTenance`  
**AIX** | **Linux** | **Windows** Specifies that the server is started in maintenance mode, and that administrative command schedules, client schedules, client sessions, storage-space reclamation, inventory expiration, and storage-pool migration are disabled.  
 Tip: Maintenance mode is the preferred method for running the server during maintenance or reconfiguration tasks. When you run the server in maintenance mode, operations that might disrupt maintenance or reconfiguration tasks are disabled automatically.

`RUNFILE file_name`  
 Specifies the name of a text file to be run on the server. The file contains a list of server commands.  
 Attention: Whenever the RUNFILE parameter is used, the server halts when processing is complete. You must restart the server by using the DSMSERV utility.

## Example: Start the server

Start the server for normal operation. Issue the following command on one line:

**AIX**

```
LDR_CNTRL=TEXTPSIZE=64K@DATAPSIZE=64K@STACKPSIZE=64K@SHMPsize=64K
usr/bin/dsmserv
```

**AIX** Ensure that you include a space after `SHMPsize=64K`. By starting the server with this command, you enable 64 KB memory pages for the server. This setting helps you optimize server performance.

**Linux**

```
/opt/tivoli/tsm/server/bin/dsmserv
```

**Windows**

```
C:\Program Files\Tivoli\TSM\bin\dsmserv -k server2
```

**Windows**

## Example: Start an additional server

Start an additional server by using the registry key named SERVER2.

```
dsmserv -k server2
```

**AIX** | **Linux** | **Windows**

## Example: Load the sample script

Load the sample script file that is provided with the server.

```
dsmserv runfile scripts.smp
```

**AIX** | **Linux** | **Windows**

## Example: Start the server in maintenance mode

Before you begin maintenance or reconfiguration tasks, start the server in maintenance mode.

```
dsmserv maintenance
```

**Related tasks:**

Starting the server in maintenance mode

AIX

## Server startup script: rc.dsmserv

---

You can use the rc.dsmserv script in your system startup to automatically start a server instance under a specific user ID.

### Syntax

---

```
>>-rc.dsmserv--+- -u--user_name+---+-----+-----><
                '- -U--user_name-' '- -i--instance_dir-'
```

### Parameters

---

-u user\_name

Specifies the instance user ID for which the environment is set up. The server will run under this user ID.

-U user\_name

Specifies the instance user ID for which the environment is set up. The server will run under the user ID of the invoker of the command.

-i instance\_dir

Specifies an instance directory, which becomes the working directory of the server.

**Related tasks:**

[AIX: Automatically starting servers](#)

Linux

## Server startup script: dsmserv.rc

---

You can use the dsmserv.rc script to stop a server instance, or to manually or automatically start a server.

### Prerequisites

---

Before you issue the DSMSERV.RC command, complete the following steps:

1. Ensure that the server instance runs under a non-root user ID with the same name as the instance owner.
2. Copy the dsmserv.rc script to the /etc/rc.d/init.d directory. The dsmserv.rc script is in the server installation directory, for example, /opt/tivoli/tsm/server/bin.
3. Rename the script so that it matches the name of the server instance owner, for example, tsminst1.
4. If the server instance directory is not home\_directory/tsminst1, locate the following line in the script copy:

```
instance_dir="${instance_home}/tsminst1"
```

Change the line so that it points to your server instance directory, for example:

```
instance_dir="/tsminst1"
```

5. In the script copy, locate the following line:

```
# pidfile: /var/run/dsmserv_instancename.pid
```

Change the instance name value to the name of the server instance owner. For example, if the server instance owner is tsminst1, update the line as shown:

```
# pidfile: /var/run/dsmserv_tsminst1.pid
```

6. Use tools such as the CHKCONFIG utility to configure the run level in which the server automatically starts. Specify a value that corresponds to a multiuser mode, with networking turned on. Typically, the run level to use is 3 or 5, depending on the operating system and its configuration. For details about run levels, see the documentation for your operating system.



## Syntax

---

```
>>-dmserv.rc-----><
      +-start---+
      +-stop----+
      +-status---+
      '-restart-'
```

## Parameters

---

**start**  
Starts the server.

**stop**  
Stops the server.

**status**  
Shows the status of the server. If the status is `started`, the process ID of the server process is also shown.

**restart**  
Stops the server and starts it again.

### Related tasks:

[Linux: Automatically starting servers on Linux systems](#)

## DSMSERV DISPLAY DBSPACE (Display information about database storage space)

---

Use this utility to display information about storage space that is defined for the database. The output of this utility is the same as the output of the `QUERY DBSPACE` command, but you can use this utility when the server is not running.

## Syntax

---

```
>>-DSMSERV +----->
           | (1) |
           '----- -u--user_name-'

               (2) .- -k--Server1--.
>-+-----+----->
  | (1) | | '- -k--key_name-'
  '----- -i--instance_dir-'

>-+-----+-----+-----+----->
  '- -o--options_file-' '- -noexpire-' '- -quiet-'

>--DISPlay DBSPace-----><
```

### Notes:

1. This parameter applies to AIX® and Linux servers only.
2. This parameter applies only to Windows servers.

## Parameters

---

**AIX Linux** `-u user_name`  
**AIX Linux** Specifies a user name to switch to before initializing the server.

**AIX Linux** `-i instance_dir`  
**AIX Linux** Specifies an instance directory to use. This becomes the current working directory of the server.

**Windows** `-k key_name`  
**Windows** Specifies the name of a Windows registry key that is used to store information about this server. Use this parameter only when there is more than one server on the same system. The default value is `SERVER1`.

`-o options_file`  
Specifies an options file to use.

- noexpire  
Specifies that expiration processing is suppressed when starting.
- quiet  
Specifies that messages to the console are suppressed.

## Example: Display database space information

Display information about database storage space. See Field descriptions for details about the information shown in the output. Issue the command.

```
dsmserv display dbspace
```

AIX		Linux	
Location	Total Space (MB)	Used Space (MB)	Free Space (MB)
/tsmdb001	46,080.00	20,993.12	25,086.88
/tsmdb002	46,080.00	20,992.15	25,087.85

Windows			
Location	Total Space (MB)	Used Space (MB)	Free Space (MB)
d:\tsm\db001	46,080.00	20,993.12	25,086.88
d:\tsm\db002	46,080.00	20,993.15	25,087.85

## Field descriptions

### Location

The directory or path that is used for storing the database

### Total Space (MB)

The total number of megabytes in the location

### Used Space (MB)

The number of megabytes in use in the location

### Free Space (MB)

**AIX** | **Linux** The space remaining in the file system where the path is located

**Windows** The space remaining on the drive where the directory is located

## DSMSERV DISPLAY LOG (Display recovery log information)

Use this utility to display information about recovery logs including the active log, the mirror for the active log, the failover directory for the archive log, and the overflow location for logs. Use this utility when the server is not running.

## Syntax

```
>>-DSMSERV -+-----+----->
          | (1)          |
          |----- -u--user_name-|
          |
          | (2) .- -k--Server1--.
>+-----+-----+-----+----->
          | (1)          |          | - -k--key_name-|
          |----- -i--instance_dir-|
          |
          |-----+-----+-----+----->
          | - -o--options_file-| - -noexpire-| - -quiet-|
>--DISPLAY LOG-----><
```

### Notes:

1. This parameter applies to AIX® and Linux servers only.
2. This parameter applies only to Windows servers.

## Parameters

- AIX Linux** `-u user_name`  
Specifies a user name to switch to before initializing the server.
- AIX Linux** `-i instance_dir`  
Specifies an instance directory to use. This becomes the current working directory of the server.
- Windows** `-k key_name`  
**Windows** Specifies the name of the Windows registry key from which to retrieve information about the server. Use this parameter only when there is more than one server on the same system. The default is SERVER1.
- `-o options_file`  
Specifies an options file to use.
- `-noexpire`  
Specifies that expiration processing is suppressed when starting.
- `-quiet`  
Specifies that messages to the console are suppressed.

## Examples: Display recovery log information

---

Display information about the recovery logs. See Field descriptions for details about the information shown in the output.

```
dmserv display log
```

```
AIX Linux
Total Space (MB): 38,912
Used Space (MB): 401.34
Free Space (MB): 38,358.65
Active Log Directory: /activelog
Archive Log Directory: /archivelog
Mirror Log Directory: /mirrorlog
Archive Failover Log Directory: /archfailoverlog
```

```
Windows
Total Space (MB): 38,912
Used Space (MB): 401.34
Free Space (MB): 38,358.65
Active Log Directory: h:\tsm\activelog
Archive Log Directory: k:\tsm\archivelog
Mirror Log Directory: i:\tsm\mirrorlog
Archive Failover Log Directory: j:\tsm\archfailoverlog
```

## Field descriptions

---

- Total Space**  
Specifies the maximum size of the active log.
- Used Space**  
Specifies the total amount of active log space currently used in the database, in megabytes.
- Free Space**  
Specifies the amount of active log space in the database that is not being used by uncommitted transactions, in megabytes.
- Active Log Directory**  
Specifies the location where active log files are stored. When you change the active log directory, the server moves all archived logs to the archive log directory and all active logs to a new active log directory.
- Mirror Log Directory**  
Specifies the location where the mirror for the active log is maintained.
- Archive Failover Log Directory**  
Specifies the location in which the server saves archive logs if the logs cannot be archived to the archive log destination.

## DSMSERV EXTEND DBSPACE (Increase space for the database)

---

Use this utility to increase space for the database by adding directories for the database to use. This utility performs the same function as the EXTEND DBSPACE command, but you can use it when the server is not running.

Restriction: Redistribution of data and reclaiming of space as part of an operation to extend database space only works with DB2® Version 9.7 or later table spaces, which are created when you format a new Version 6.3 or later server.

## Syntax

---

```

>>-DSMSERV -+-----+----->
          | (1) |
          |----- -u--user_name-|
          |-----+-----+----->
                                     (2) .- -k--Server1--.
>+-----+-----+----->
          | (1) |
          |----- -i--instance_dir-|
          |-----+-----+----->
                                     .- ,----- .
                                     v |
>--EXTend DBSpace---db_directory+----->
          .-RECLAIMstorage---Yes-----.
>+-----+-----+-----><
          '-RECLAIMstorage---+No--+-'
          |-----Yes-|

```

Notes:

1. This parameter applies to AIX® and Linux servers only.
2. This parameter applies only to Windows servers.

## Parameters

- AIX | Linux** `-u user_name`  
**AIX | Linux** Specifies a user name to switch to before you initialize the server.
- AIX | Linux** `-i instance_dir`  
**AIX | Linux** Specifies an instance directory to use. This becomes the current working directory of the server.
- Windows** `-k key_name`

**Windows** Specifies the name of a Windows registry key that is used to store information about this server. Use this parameter only when there is more than one server on the same system. The default value is SERVER1.

db\_directory (Required)

Specifies the directories for database storage. The directories must be empty and accessible by the user ID of the database manager. A directory name must be a fully qualified name and cannot exceed 175 characters in length. Enclose the name in quotation marks if it contains embedded blanks, an equal sign, or other special characters. If you are specifying a list of directories for database storage, the maximum length of the list can be 1400 characters.

**Windows** Restriction: You cannot specify Universal Naming Convention (UNC) paths.

Tip: Specify directories that are the same size as existing directories to ensure a consistent degree of parallelism for database operations. If one or more directories for the database are smaller than the others, they reduce the potential for optimized parallel prefetching and distribution of the database.

RECLAIMstorage

Specifies whether data is redistributed across newly created database directories and space is reclaimed from the old storage paths when you add space to the database. This parameter is optional. The default value is Yes.

Yes

Specifies that data is redistributed so that new directories are available for immediate use.

Important: The redistribution process uses considerable system resources so ensure that you plan ahead. Also, the server might be offline for a while, until the process is completed.

No

Specifies that data is not redistributed across database directories and storage space is not reclaimed.

**AIX | Linux**

## Example: Increase space for the database

Add a directory named stg1 in the tsm\_db directory for the database storage space and then redistribute data and reclaim space by issuing the following command:

```
dsmserve extend dbspace /tsm_db/stg1
```

**Windows**

## Example: Increase space for the database

Add drive D to the storage space for the database and then redistribute data and reclaim space by issuing the following command:

```
dsmserv extend dbspace D:
```

**Related reference:**

EXTEND DBSPACE (Increase space for the database)

## DSMSERV FORMAT (Format the database and log)

---

Use the DSMSERV FORMAT utility to initialize the server database and recovery log. No other server activity is allowed while initializing the database and recovery log.

The directories that are specified in this utility should be on fast, reliable storage. Do not place the directories on file systems that might run out of space. If certain directories (for example, the active log directory) become unavailable or full, the server stops.

**Windows Restriction:** If you are using a File Allocation Table (FAT or FAT32) or a New Technology File System (NTFS) format, you cannot specify the root directory of that system as the location of a database directory or log directory. Instead, you must create one or more subdirectories within the root directory. Then, create the database directories and log directories within the subdirectories.

**Windows Important:** The installation program creates a set of registry keys. One of these keys points to the directory where a default server, named SERVER1, is created. To install an extra server, create a directory and use the DSMSERV FORMAT utility, with the -k parameter, from that directory. That directory becomes the location of the server. The registry tracks the installed servers.

When a server is initially created by using the DSMSERV FORMAT utility or the configuration wizard, a server database and recovery log are created. In addition, files are created to hold database information that is used by the database manager.

### Syntax

---

```
>>-DSMSERV -+-----+----->
              | (1) |
              '----- -u--user_name-'
(2) .- -k--Server1--
>--+-----+-----+----->
              | (1) |      '- -k--key_name-'
              '----- -i--instance_dir-'
>--+-----+-----+-----+-----FORMAT-->
              '- -o--options_file-' '- -noexpire-' '- -quiet-'
              .-,-----'.
              v |
>--+DBDir-----directory+----->
              '-DBFile-----file-----'
              .-ACTIVELOGSize-----16384-----.
>--+-----+----->
              '-ACTIVELOGSize-----megabytes-'
>--+ACTIVELOGDirectory-----directory----->
>--+ARCHLogdirectory-----directory----->
>--+-----+----->
              '-ARCHFailoverlogdirectory-----directory-'
>--+-----+-----><
              '-MIRRORlogdirectory-----directory-'
```

Notes:

1. This parameter applies to AIX® and Linux servers only.
2. This parameter applies only to Windows servers.

### Parameters

---

- AIX Linux** `-u user_name`  
Specifies a user name to switch to before initializing the server. This parameter is optional.
- AIX Linux** `-i instance_dir`  
Specifies an instance directory to use. This directory becomes the current working directory of the server. This parameter is optional.
- Windows** `-k key_name`  
**Windows** Specifies the name of a Windows registry key that is used to store information about this server. Use this parameter only to install extra servers on the same system. After you install a server by using this parameter, you must always start it with the value of this parameter. This parameter is optional. The default is SERVER1.  
Restriction: Additional instances of the IBM Spectrum Protect™ server that are running on the same system will compete for resources and impact overall performance of each IBM Spectrum Protect server.

- `-o options_file`  
Specifies an options file to use. This parameter is optional.
- `-noexpire`  
Specifies that expiration processing is suppressed when starting. This parameter is optional.
- `-quiet`  
Specifies that messages to the console are suppressed. This parameter is optional.

**DBDir**  
Specifies the relative path names of one or more directories that are used to store database objects. Directory names must be separated by commas but without spaces. You can specify up to 128 directory names. You must specify either the DBDIR or the DBFILE parameter.  
Tip: If you specify multiple directories, ensure that the underlying file systems are of equal size to ensure a consistent degree of parallelism for database operations. If one or more directories for the database are smaller than the others, they reduce the potential for optimized parallel prefetching and distribution of the database.

**DBFile**  
Specifies the name of a file that contains the relative path names of one or more directories that are used to store database objects. Each directory name must be on a separate line in the file. You can specify up to 128 directory names. You must specify either the DBDIR or the DBFILE parameter.

**ACTIVELOGSize**  
Specifies the size of the active log file in megabytes. This parameter is optional. The minimum value is 2048 MB (2 GB); the maximum is 524,288 MB (512 GB). If an odd number is specified, the value is rounded up to the next even number. The default is 16384 MB.  
The size of an active log file is based on the value of the ACTIVELOGSIZE option. Guidelines for space requirements are in the following table:

Table 1. How to estimate volume and file space requirements

ACTIVELOGSize option value	Reserve this much free space in the active log directory, in addition to the ACTIVELOGSize space
16 GB - 128 GB	5120 MB
129 GB - 256 GB	10240 MB
257 GB - 512 GB	20480 MB

**ACTIVELOGDirectory (Required)**  
Specifies the directory in which the server writes and stores active log files. There is only one active log location. The name must be a fully qualified directory name. The directory must exist, it must be empty, and it must be accessible by the user ID of the database manager. The maximum number of characters is 175.

**ARCHLogdirectory (Required)**  
Specifies the directory for the archive log files. The name must be a fully qualified directory name. The maximum number of characters is 175.

**ARCHFailoverlogdirectory**  
Specifies the directory to be used as an alternative storage location if the ARCHLOGDIRECTORY directory is full. This parameter is optional. The maximum number of characters is 175.

**MIRRORlogdirectory**  
Specifies the directory in which the server mirrors the active log (those files in the ACTIVELOGDIRECTORY directory). This parameter is optional. The directory must be a fully qualified directory name. The maximum number of characters is 175.

## Example: Format a database

**AIX Linux**

```
dmserv format dbdir=/tsmdb001 activelogsiz=8192
activelogdirectory=/activelog archlogdirectory=/archlog
```

```
archfailoverlogdirectory=/archfaillog mirrorlogdirectory=/mirrorlog
```

#### Windows

```
dsmserve -k server2 format dbdir=d:\tsm\db001 activelogsiz=8192  
activelogdirectory=e:\tsm\activelog archlogdirectory=f:\tsm\archlog  
archfailoverlogdirectory=g:\tsm\archfaillog mirrorlogdirectory=h:\tsm\mirrorlog
```

## DSMSERV INSERTDB (Move a server database into an empty database)

Use the DSMSERV INSERTDB utility to move a server database into a new database. The database can be extracted from the original server and inserted into a new database on the new server by using a network connection between the two servers. The database can also be inserted from media that contains the extracted database.

Before you use the DSMSERV INSERTDB utility, complete the planning and preparation tasks, such as backing up the database and saving configuration information. Ensure that you meet all requirements before you move the server database.

### Requirements for insertion by using media

Before you run the utility to insert the server database into an empty database, ensure that your system meets the following requirements.

- The manifest file from the DSMUPGRD EXTRACTDB operation must be available.
- If the manifest file does not contain device configuration information, or if you are specifying the CONFIGINFO=DEVCONFIG parameter, both of the following statements must be true:
  - The server options file must contain an entry for the device configuration file.
  - The device configuration file must have information about the device class that is specified in the manifest file.
- The media that contains the extracted database must be available to the V8 server. Also, the permissions must be set to grant access to the media for the user ID that owns the V8 server instance.

### Syntax

```
>>-DSMSERV +-----+----->  
          | (1) |  
          +----- -u--user_name-'  
  
          (2) .- -k--Server1--.  
>+-----+-----+----->  
          | (1) | | | '- -k--key_name-'  
          +----- -i--instance_dir-'  
  
>+-----+-----+-----+-----+----->  
          '- -o--options_file- ' '- -noexpire- ' '- -quiet-'  
  
>--INSERTDB--+-| A: Insert from media |----->  
              '-| B: Insert over a network |-'  
  
          .-PREview--==--No-----.  
>+-----+-----+-----><  
          '-PREview--==--Yes--+'  
          '-No--'  
  
A: Insert from media  
  
+-----+----->  
'-DEVclass--==--device_class_name-'  
  
          .-CONFiginfo--==--MANifest-----.  
>+-----+-----+-----+-----+-----+-----|  
          '-CONFiginfo--==--MANifest--+-' -MANifest--==--file_name-----|  
          '-DEVconfig-'  
  
B: Insert over a network  
  
          .-SESSWait--==--60-----.  
+-----+-----|  
'-SESSWait--==--minutes-'
```

Notes:

1. This parameter applies to AIX® and Linux servers only.
2. This parameter applies only to Windows servers.

## Parameters

---

<b>AIX</b>	<b>Linux</b>	<b>-u user_name</b>	
<b>AIX</b>	<b>Linux</b>		Specifies a user name to switch to before initializing the server. This parameter is optional.
<b>AIX</b>	<b>Linux</b>	<b>-i instance_dir</b>	
<b>AIX</b>	<b>Linux</b>		Specifies an instance directory to use. This directory becomes the current working directory of the server. This parameter is optional.
<b>Windows</b>		<b>-k key_name</b>	
	<b>Windows</b>		Specifies the name of the Windows registry key from which to retrieve information about the server. This parameter is optional. The default is SERVER1.
<b>-o options_file</b>			
Specifies an options file to use. This parameter is optional.			
<b>-noexpire</b>			
Specifies that expiration processing is suppressed when starting. This parameter is optional.			
<b>-quiet</b>			
Specifies that messages to the console are suppressed. This parameter is optional.			
<b>DEVclass</b>			
Specifies a sequential-access device class. You can specify any device class except for the DISK device class. The definition for the device class must exist in either the manifest file or the device configuration file.			
This parameter is optional and is used only when the database that you want to insert into the empty V8 database was extracted to media. If the database is on media and you do not specify a device class, the device class that is identified in the manifest file is used.			
Restriction: You cannot use a device class with a device type of NAS or CENTERA.			
<b>MANifest</b>			
Specifies the location of the manifest file. Use a fully qualified file name, or place in a local directory. For example: ./manifest.txt			
This parameter is required when the database that you want to insert into the empty V8 database was extracted to media.			
<b>CONFiginfo</b>			
Specifies the source of the device configuration information that is used by the DSMSEV INSERTDB operation. The default value for this parameter is MANIFEST. Possible values are as follows:			
<b>MANifest</b>			
Specifies that device configuration information is read from the manifest file. If the manifest file does not have device configuration information, the device configuration file is used instead.			
<b>DEVConfig</b>			
Specifies that device configuration information is read from the device configuration file.			
<b>SESSWait</b>			
Specifies the number of minutes that the V8 server waits to be contacted by the original server. The default value is 60 minutes.			
Use this parameter only if the data that is inserted into the empty V8 database is transmitted from the source server with a network connection.			
<b>PREview</b>			
Specifies whether to preview the insertion operation. This parameter is optional. The default value is NO.			
Use the PREVIEW=YES parameter to test a database. When you use this parameter, the operation includes all steps of the process, except for the actual insertion of data into the new database. When you preview the insertion operation, you can quickly verify that the source database is readable. You can also identify any data constraint violations that might prevent an upgraded database from being put into production.			

## DSMSERV LOADFORMAT (Format a database)

---

Use the DSMSERV LOADFORMAT utility when upgrading from Version 5. The utility formats an empty database in preparation for inserting an extracted database into the empty database.



## Syntax

```
>>-DSMSERV -+-----+----->
          | (1) |
          |----- -u--user_name-|
          |
          | (2) .- -k--Server1--.
>+-----+-----+-----+----->
  | (1) | | | | |
  |----- -i--instance_dir-| | | | |
  |----- -o--options_file-| | | | |
  |----- -noexpire-| | | | |
  |----- -quiet-|
  |
  | .-,-----.
  | V |
>--LOADFORMAT--+-DBDir-------directory--+----->
  |-----DBFile-----file-----|
  |
  | .-ACTIVELOGSize-----16384-----.
>+-----+-----+-----+----->
  |-----ACTIVELOGSize-----megabytes-|
  |
>--ACTIVELOGDirectory-----directory----->
>--ARCHLogdirectory-----directory----->
>+-----+-----+-----+----->
  |-----ARCHFailoverlogdirectory-----directory-|
  |
>+-----+-----+-----+-----><
  |-----MIRRorlogdirectory-----directory-|
```

### Notes:

1. This parameter applies to AIX® and Linux servers only.
2. This parameter applies only to Windows servers.

## Parameters

Platform	Parameter	Description
AIX   Linux	<code>-u user_name</code>	Specifies a user name to switch to before initializing the server. This parameter is optional.
AIX   Linux	<code>-i instance_dir</code>	Specifies an instance directory to use. This directory becomes the current working directory of the server. This parameter is optional.
Windows	<code>-k key_name</code>	Specifies the name of a Windows registry key that is used to store information about this server. Use this parameter only to install additional servers on the same system. After you install a server by using this parameter, you must always start it with the value of this parameter. The default is SERVER1.
	<code>-o options_file</code>	Specifies an options file to use. This parameter is optional.
	<code>-noexpire</code>	Specifies that expiration processing is suppressed when the server starts. This parameter is optional.
	<code>-quiet</code>	Specifies that messages to the console are suppressed. This parameter is optional.
	<code>DBDir</code>	Specifies the relative path names of one or more directories that are used to store database objects. Directory names must be separated by commas but without spaces. You can specify up to 128 directory names. You must specify either the DBDIR or the DBFILE parameter. Tip: If you specify multiple directories, ensure that the underlying file systems are of equal size to ensure a consistent degree of parallelism for database operations. If one or more directories for the database are smaller than the others, they reduce the potential for optimized parallel prefetching and distribution of the database.
	<code>DBFile</code>	Specifies the name of a file that contains the relative path names of one or more directories that are used to store database objects. Each directory name must be on a separate line in the file. You can specify up to 128 directory names. You must

specify either the DBDIR or the DBFILE parameter.

#### ACTIVELOGSize

Specifies the size of the active log file in megabytes. This parameter is optional. The minimum value is 2048 MB (2 GB); the maximum is 524,288 MB (512 GB). If an odd number is specified, the value is rounded up to the next even number. The default is 16384 MB.

The size of an active log file is based on the value of the ACTIVELOGSIZE option. Guidelines for space requirements are in the following table:

Table 1. How to estimate volume and file space requirements

ACTIVELOGSize option value	Reserve this much free space in the active log directory, in addition to the ACTIVELOGSize space
16 GB - 128 GB	5120 MB
129 GB - 256 GB	10240 MB
257 GB - 512 GB	20480 MB

#### ACTIVELOGDirectory (Required)

Specifies the directory in which the server writes and stores active log files. There is only one active log location. The name must be a fully qualified directory name. The directory must exist, it must be empty, and it must be accessible by the user ID of the database manager. The maximum number of characters is 175.

#### ARCHLogdirectory (Required)

Specifies the directory for the archive log files. The name must be a fully qualified directory name. The maximum number of characters is 175.

#### ARCHFailoverlogdirectory

Specifies the directory to be used as an alternative storage location if the ARCHLOGDIRECTORY directory is full. This parameter is optional. The maximum number of characters is 175.

#### MIRRORlogdirectory

Specifies the directory in which the server mirrors the active log (those files in the ACTIVELOGDIRECTORY directory). This parameter is optional. The directory must be a fully qualified directory name. The maximum number of characters is 175.

## Example: Format a database

#### AIX | Linux

```
dsmserv loadformat dbdir=/tsmdb001 activelogsiz=8192
activelogdirectory=/activelog archlogdirectory=/archlog
archfailoverlogdirectory=/archfaillog mirrorlogdirectory=/mirrorlog
```

#### Windows

```
dsmserv -k server2 loadformat dbdir=d:\tsm\db001 activelogsiz=8192
activelogdirectory=e:\tsm\activelog archlogdirectory=f:\tsm\archlog
archfailoverlogdirectory=g:\tsm\archfaillog mirrorlogdirectory=h:\tsm\mirrorlog
```

## DSMSERV REMOVEDB (Remove a database)

Use the DSMSERV REMOVEDB utility to remove an IBM Spectrum Protect™ server database.

When you run this utility, you delete the server database, active log files, and active log mirror files. However, the archive log files and archive log failover log files are deleted only after you start a point-in-time database restore.

You must halt the IBM Spectrum Protect server before you issue this command.

## Syntax

```
>>-DSMSERV +-----+----->
          | (1) |
          '----- -u--user_name-'
                                     (2) .- -k--Server1--.
>-+-----+-----+----->
      | (1) | | '- -k--key_name-'
      '----- -i--instance_dir-'
>-+-----+-----+----->
```

```
'- -o--options_file-' '- -noexpire-' '- -quiet-'
      .- -force---No-----
>--REMOVEDB--database_name--+-----+-----><
      '- -force---+No---+'
      '-Yes-'
```

Notes:

1. This parameter applies to AIX® and Linux servers only.
2. This parameter applies only to Windows servers.

## Parameters

**AIX** | **Linux** **-u** user\_name  
**AIX** | **Linux** Specifies a user name to switch to before initializing the server.

**AIX** | **Linux** **-i** instance\_dir  
**AIX** | **Linux** Specifies an instance directory to use. This becomes the current working directory of the server.

**Windows** **-k** key\_name  
**Windows** Specifies the name of the Windows registry key from which to retrieve information about the server. The default is SERVER1.

**-o** options\_file  
 Specifies an options file to use.

**-noexpire**  
 Specifies that expiration processing is suppressed when starting.

**-quiet**  
 Specifies that messages to the console are suppressed.

**database\_name**  
 The database name that was entered during installation. If the database was formatted manually, then this is the database name parameter in the DSMSEV FORMAT or DSMSEV LOADFORMAT utility. This database name can also be found in dsmserv.opt file. This parameter is required.

**-force**  
 Specifies whether the database is removed when there are open connections. The default is No. This parameter is optional. The values are as follows:

**Yes**  
 Specifies that the database is removed regardless of open connections

**No**  
 Specifies that the database is removed only when all connections are closed.

## Example: Remove a database

Remove the IBM Spectrum Protect server database TSMDB1 and all of its references.

```
dsmserv removedb TSMDB1
```

## Example: Remove a database with force parameter

Remove the IBM Spectrum Protect server database TSMDB1 and all of its references, even if it has open connections:

```
dsmserv removedb TSMDB1 force=yes
```

## DSMSERV RESTORE DB (Restore the database)

Use this utility to restore a database by using a database backup.

Restriction: You cannot restore a server database if the release level of the server database backup is different from the release level of the server that is being restored. For example, an error occurs when you restore a Version 7.1.3 database and you are using a Version 8.1 IBM Spectrum Protect™ server.

The restore operation uses database backups created with the BACKUP DB command.

Important: After a point-in-time restore operation, issue the AUDIT VOLUME command to audit all DISK volumes and resolve any inconsistencies between database information and storage pool volumes. Before restoring the database, examine the volume history file to find out about any sequential access storage pool volumes that were deleted or reused since the point in time to which the database was restored.

- DSMSERV RESTORE DB (Restore a database to its most current state)  
Use the DSMSERV RESTORE DB utility to restore a database to its most current state under certain conditions.
- DSMSERV RESTORE DB (Restore a database to a point-in-time)  
Use this command to restore a database to a point in time. A volume history file and a device configuration file must be available.

## DSMSERV RESTORE DB (Restore a database to its most current state)

Use the DSMSERV RESTORE DB utility to restore a database to its most current state under certain conditions.

The following conditions must be met:

- An intact volume history file is available.
- The recovery logs are available.
- A device configuration file with the applicable device information is available.

Restriction: You cannot restore a server database if the release level of the server database backup is different from the release level of the server that is being restored. For example, an error occurs when you restore a Version 7.1.3 database and you are using a Version 8.1 IBM Spectrum Protect™ server.

IBM Spectrum Protect requests volume mounts to load the most recent backup series and then uses the recovery logs to update the database to its most current state.

Snapshot database backups cannot be used to restore a database to its most current state.

### Syntax

```
>>-DSMSERV -+-----+----->
          | (1) |
          '----- -u--user_name-'

                                     (2) .- -k--Server1--.
>+-----+-----+----->
  | (1) | | | '- -k--key_name-'
  '----- -i--instance_dir-'

>+-----+-----+-----RESTORE DB----->
  '- -o--options_file-' | (1) |
                       '----- -quiet-'

>+-----+----->
  '-RECOVerydir----directory-'

>+-----+----->
  '-ACTIVELOGDir----directory-'

                                     .-PReview----No-----.
>+-----+-----+----->
  '-ON-----target_directory_file-' '-PReview-----+Yes+-'
                                     '-No--'

  .-RESTOREKeys----No-----.
>+-----+-----+----->
  '-RESTOREKeys-----+No----+'
                                     +-YES--+
                                     '-ONLY-'

>+-----+-----><
  '-PASSword----password_name-'
```

Notes:

1. This parameter applies to AIX® and Linux servers only.
2. This parameter applies only to Windows servers.

## Parameters

- AIX** | **Linux** `-u user_name`  
**AIX** | **Linux** Specifies a user name to switch to before initializing the server.
- AIX** | **Linux** `-i instance_dir`  
**AIX** | **Linux** Specifies an instance directory to use. This instance directory becomes the current working directory of the server.
- Windows** `-k key_name`  
**Windows** Specifies the name of the Windows registry key from which to retrieve information about the server. The default is SERVER1.
- `-o options_file`  
 Specifies an options file to use.
- AIX** | **Linux** `-quiet`  
**AIX** | **Linux** Specifies that messages to the console are suppressed.

### RECOVERydir

Specifies a directory in which to store recovery log information from the database backup media. This directory must have enough space to hold this transaction recovery information and must be an empty directory. If this parameter is not specified, the default is to the directory specified by one of the following parameters in the DSMSEV FORMAT or DSMSEV LOADFORMAT utility:

- ARCHFAILOVERLOGDIRECTORY, if specified
- ARCHLOGDIRECTORY, if ARCHFAILOVERLOGDIRECTORY is not specified

### ACTIVELOGDir

Specifies a directory in which to store the log files that are used to track the active database operations. This directory must be specified only if the intent is to switch to an active log directory different from the one that had already been configured.

### On

Specifies a file that lists the directories to which the database is restored. Specify each directory on a separate line in the file. For example, the ON parameter specifies the restorelist.txt file, which contains the following list:

```
/tsmdb001
/tsmdb002
/tsmdb003
```

### **Windows**

```
e:\tsm\db001
f:\tsm\db002
g:\tsm\db003
```

If this parameter is not specified, the original directories that were recorded in the database backup are used.

Tip: If you specify multiple directories, ensure that the underlying file systems are of equal size to ensure a consistent degree of parallelism for database operations. If one or more directories for the database are smaller than the others, they reduce the potential for optimized parallel prefetching and distribution of the database.

### PReview

Specifies that the volume history files be examined and that the database backup volumes from the volume history file be evaluated.

1. Which set of database backup volumes best meets the most current criteria that are specified for restore processing? The volume history information provides details about the backup series ID, the operation ID (full, incremental 1, incremental 2, and so on), the date of the database backup, and the device class. This information and the parameters that are specified in the DSMSEV RESTORE DB command determine what to use to perform the restore. The volume history file is examined to find the most recent database backup and then to restore the data by using that backup.
2. Is self-describing data available for the selected set of database backup volumes? Cross-check the volume history information for this backup series. The reconciliation reports what the self-describing data contains compared to what was learned from the volume history entries. The cross-check involves mounting one or more of the volumes that are indicated by the volume history. Then, using the self-describing data that was included in the database backup volumes, that information is reconciled against what is in the volume history for the database backup. If the information from the volume history file is inconsistent with the self-describing data, then messages are issued to identify the problem. For example, not all values are specified and available, and no self-describing data is found.

If the volume history information is consistent with self-describing data from the database backup, a message is issued indicating that the database backup can be used for restore processing.

If the volume history information is inconsistent with the self-describing data from the database backup or if the self-describing data for the backup cannot be found, error messages are issued indicating what was checked and what was missing.

If the PREVIEW parameter is not specified or if it is set to NO, and if the volume history and self-describing data from the database backup are consistent, then the restore proceeds.

If the PREVIEW parameter is not specified or if it is set to NO, and the reconciliation and validation fail, the database restore is not performed. Make extra volumes available and referred to from the volume history file, or remove the incomplete backup series or operation so that the IBM Spectrum Protect server selects a different preferred series or operation and continues processing.

If the PREVIEW parameter is set to YES, the process performs only the evaluation of the volume history file and the reconciliation and validation against the selected database backup.

AIX	Linux	Windows	RESTOREKeys
AIX	Linux	Windows	Specifies whether to restore the server master encryption key that is used to encrypt storage pool data when the database is restored. This parameter is optional and only applies if you are using encrypted container storage pools in a cloud environment. If the server master key is protected when the database is restored, the default is YES. If the server master key is not protected when the database is restored, the default is NO. You can specify one of the following values:

No

Specifies that the server master key is not restored when the database is restored.

Yes

Specifies that the server master key is restored when the database is restored. You must specify a password with this parameter.

Only

Specifies that only the server master key is restored. The database is not restored.

AIX	Linux	Windows	PASSword
AIX	Linux	Windows	Specifies the password that is used to protect the database backup. This parameter only applies if you are using encrypted container storage pools in a cloud environment. If you specify a password for database backup, you must specify the same password on the RESTORE DB command to restore the database. You must use a password if you specify the RESTOREKEYS=YES or RESTOREKEYS=ONLY parameter.

## Example: Restore the database to its most current state

---

Restore the database to its most current state by using the already configured active log directory.

```
dmserv restore db
```

## Example: Restore the server master key without restoring the database

---

Restore the server master key without restoring the database by issuing the following command:

```
dmserv restore db restorekeys=only
```

## DSMSERV RESTORE DB (Restore a database to a point-in-time)

---

Use this command to restore a database to a point in time. A volume history file and a device configuration file must be available.

Restriction: You cannot restore a server database if the release level of the server database backup is different from the release level of the server that is being restored. For example, an error occurs when you restore a Version 7.1.3 database and you are using a Version 8.1 IBM Spectrum Protect™ server.

You can use full and incremental database backups, or snapshot database backups can be used to restore a database to a point in time.

Tip: When you restore a V7 or later IBM Spectrum Protect server database to a specific point in time, the preferred method is to issue the DSMSERV REMOVE DB command before you issue the DSMSERV RESTORE DB command. This ensures that the system

is in a clean state. The system drops and uncatalogs the database in the background. When you restore data to a specific point in time, all the required logs and the database image are retrieved from the backup media.

## Syntax

```
>>-DSMSERV -+-----+----->
          | (1) |
          |----- -u--user_name-'
          |
          | (2) .- -k--Server1--.
>+-----+----->
          | (1) | |----- -k--key_name-'
          |----- -i--instance_dir-'
          |
          |-----+-----+-----+-----+-----+-----+-----+-----+-----+----->
          | -o--options_file-' | (1) |
          |----- -quiet-'
          |
          |-----+-----+-----+-----+-----+-----+-----+-----+-----+----->
          |----- -TTime----23:59:59-.
>--TODate----date-+-----+----->
          |----- -TTime----time-----'
          |
          |-----+-----+-----+-----+-----+-----+-----+-----+-----+----->
          |----- -Source----DBBackup-----.
          |-----+-----+-----+-----+-----+-----+-----+-----+-----+----->
          |----- -Source----+DBBackup----+-'
          |----- -DBSnapshot-'
          |
          |-----+-----+-----+-----+-----+-----+-----+-----+-----+----->
          |----- -RECOVerydir----directory-'
          |
          |-----+-----+-----+-----+-----+-----+-----+-----+-----+----->
          |----- -ACTIVELOGDir----directory-'
          |
          |-----+-----+-----+-----+-----+-----+-----+-----+-----+----->
          |----- -PReview----No-----.
          |-----+-----+-----+-----+-----+-----+-----+-----+-----+----->
          |----- -ON----target_directory_file-' |----- -PReview----+Yes--+-'
          |----- -No--'
          |
          |-----+-----+-----+-----+-----+-----+-----+-----+-----+----->
          |----- -RESTOREKeys----No-----.
          |-----+-----+-----+-----+-----+-----+-----+-----+-----+----->
          |----- -RESTOREKeys----+No----+-'
          |----- +-YES--+
          |----- -ONLY-'
          |
          |-----+-----+-----+-----+-----+-----+-----+-----+-----+-----><
          |----- -PASSword----password_name-'
```

### Notes:

1. This parameter applies to only AIX® and Linux servers.
2. This parameter applies only to Windows servers.

## Parameters

AIX	Linux	<b>-u</b> user_name
Specifies a user name to switch to before you initialize the server.		
AIX	Linux	<b>-i</b> instance_dir
Specifies an instance directory to use. This becomes the current working directory of the server.		
Windows		<b>-k</b> key_name
Specifies the name of the Windows registry key from which to retrieve information about the server. The default is SERVER1.		
<b>-o</b> options_file		
Specifies an options file to use.		
AIX	Linux	<b>-quiet</b>
Specifies that messages to the console are suppressed.		
<b>TODate</b> (Required)		
Specifies the date to which to restore the database. The following values are possible:		

#### MM/DD/YYYY

Specifies that you want to restore a database by using the last backup series that was created before this specified date.

#### TODAY

Specifies that you want to restore a database by using the most recent backup series that was created before today.

#### TODAY-numdays or -numdays

Specifies that you want to restore a database by using the most recent backup series that was created the specified number of days before the current date.

#### TOTime

Specifies the time of day to which to restore the database. This parameter is optional. The default is the end of the day (23:59:59). Possible values are:

#### HH:MM:SS

Specifies that you want to restore the database by using the last backup series that is created on or before the specified time on the date that is specified on the TODATE parameter.

#### NOW

Specifies that you want to restore the database by using a backup series that is created on or before the current time on the date that is specified on the TODATE parameter.

For example, if you issue the DSMSEV RESTORE DB utility at 9:00 with TOTIME=NOW, the database is restored by using the last backup series that is created on or before 9:00 on the date that is specified on the TODATE parameter.

#### NOW-numhours:numminutes or -numhours:numminutes

Specifies that you want to restore the database by using a backup series that is created on or before the current time minus a specified number of hours and, optionally, minutes on the date that is specified on the TODATE parameter.

For example, if you issue the DSMSEV RESTORE DB utility at 9:00 with TOTIME=NOW-3:30 or TOTIME+-3:30, the database is restored by using the last backup series that is created on or before 5:30 on the date that is specified on the TODATE parameter.

#### Source

Specifies whether the database is restored by using either database full and incremental backup volumes or snapshot database volumes. This parameter is optional. The default value is DBBackup. The following values are possible:

#### DBBackup

Specifies that the database is restored as follows:

1. Reads the volume history file to locate the database full and incremental backup volumes that are needed.
2. Requests mounts and loads the data from the database full and incremental backup volumes as required to restore the database volume to the specified time.

#### DBSnapshot

Specifies that the database is restored as follows:

1. Reads the volume history file to locate the snapshot database volumes that are needed,
2. Requests mounts and loads data from snapshot database volumes as required to restore the volume to the specified time.

#### RECOVdir

Specifies a directory in which to store recovery log information from the database backup media. This log information is used to establish transaction consistency of the server database as part of the recovery processing. This directory must have enough space to hold this transaction recovery information and must be an empty directory. If this parameter is not specified, the default is the directory that is specified by one of the following parameters in the DSMSEV FORMAT or DSMSEV LOADFORMAT utility:

- ARCHFAILOVERLOGDIRECTORY, if specified
- ARCHLOGDIRECTORY, if ARCHFAILOVERLOGDIRECTORY is not specified

#### ACTIVELOGDir

Specifies a directory in which to store the log files that are used to track the active database operations. Specify this directory only if the intent is to switch to an active log directory that is different from the one that was already configured.

#### On

Specifies a file that lists the directories to which the database is restored. Specify each directory on a separate line in the file. For example, the ON parameter specifies the restorelist.txt file, which contains the following list:

AIX Linux



```
/tsmdb001  
/tsmdb002  
/tsmdb003
```

#### Windows

```
e:\tsm\db001  
f:\tsm\db002  
g:\tsm\db003
```

If this parameter is not specified, the original directories that were recorded in the database backup are used.

Tip: If you specify multiple directories, ensure that the underlying file systems are of equal size to ensure a consistent degree of parallelism for database operations. If one or more directories for the database are smaller than the others, they reduce the potential for optimized parallel prefetching and distribution of the database.

#### PREVIEW

Specifies that the volume history files be examined and that the database backup volumes from the volume history file be evaluated.

1. Which set of database backup volumes best meets the point-in-time criteria that are specified for restore processing? The volume history information provides details about the backup series ID, the operation ID (full, incremental 1, incremental 2, and so on), the date of the database backup, and the device class. This information and the parameters that are specified in the DSMSEV RESTORE DB command determine what to use to perform the restore. The volume history file is examined to find the best database backup that meets the specified point-in-time criteria and then perform the restore by using that backup.
2. Is self-describing data available for the selected set of database backup volumes? Cross-check the volume history information for this backup series. The reconciliation reports what the self-describing data contains compared to what was learned from the volume history entries. The cross-check involves mounting one or more of the volumes that are indicated by the volume history. Then, using the self-describing data that was included in the database backup volumes, that information is reconciled against what is in the volume history for the database backup. If the information from the volume history file is inconsistent with the self-describing data, then messages are issued to identify the problem. For example, not all values are specified and available, and no self-describing data is found.

If the volume history information is consistent with self-describing data from the database backup, a message is issued indicating that the database backup can be used for restore processing.

If the volume history information is inconsistent with the self-describing data from the database backup or if the self-describing data for the backup cannot be found, error messages are issued indicating what was checked and what was missing.

If the PREVIEW parameter is not specified or if it is set to NO, and if the volume history and self-describing data from the database backup are consistent, then the restore proceeds.

If the PREVIEW parameter is not specified or if it is set to NO, and the reconciliation and validation fail, the database restore is not performed. Make extra volumes available and referred to from the volume history file, or remove the incomplete backup series or operation so that the IBM Spectrum Protect server selects a different preferred series or operation and continues processing.

If the PREVIEW parameter is set to YES, the process performs only the evaluation of the volume history file and the reconciliation and validation against the selected database backup.

#### AIX Linux Windows RESTOREKeys

Specifies whether to restore the server master encryption key that is used to encrypt storage pool data when the database is restored. This parameter is optional and only applies if you are using encrypted container storage pools in a cloud environment. If the server master key is protected when the database is restored, the default is YES. If the server master key is not protected when the database is restored, the default is NO. You can specify one of the following values:

No

Specifies that the server master key is not restored when the database is restored.

Yes

Specifies that the server master key is restored when the database is restored. You must specify a password with this parameter.

Only

Specifies that only the server master key is restored. The database is not restored.

#### AIX Linux Windows PASSWORD

**AIX** | **Linux** | **Windows** Specifies the password that is used to protect the database backup. This parameter only applies if you are using encrypted container storage pools in a cloud environment. If you specify a password for database backup, you must specify the same password on the RESTORE DB command to restore the database. You must use a password if you specify the RESTOREKEYS=YES or RESTOREKEYS=ONLY parameter.

## Example: Restore the database to a specific point in time

Restore the database to its state on May 12, 2011 at 2:25 PM.

```
dsmserv restore db todate=05/12/2011 totime=14:45
```

## Example: Restore the server master key without restoring the database

Restore the server master key without restoring the database by issuing the following command:

```
dsmserv restore db restorekeys=only
```

**Windows**

## DSMSERV UPDATE (Create registry entries for a server instance)

Use this utility to create registry entries for an IBM Spectrum Protect™ server instance if the entries were accidentally deleted.

Run this utility from the instance directory for the database (where files such as dsmserv.dsk are stored for the server). The utility re-creates the original registry entries for the server.

### Syntax

```
.- -k--Server1--.  
>>-DSMSERV--+-+-----+-----+-----UPDATE----->>  
'- -k--key_name-'
```

### Parameters

**-k key\_name**  
Specifies the name of the Windows registry key in which to store information about the server. The default is Server1.

## Example: Re-create registry entries for a server instance

Run the utility to re-create registry entries for the server instance, Server2.

```
"c:\Program Files\Tivoli\TSM\server\bin\dsmserv" -k server2 update
```

**AIX** | **Linux**

## DSMULOG (Capture IBM Spectrum Protect server messages to a user log file)

Use this command to capture IBM Spectrum Protect™ server console messages to a user log file. You can specify that IBM Spectrum Protect write messages to more than one user log file.

**Important:** Do not place the user logs in the /usr or /opt file systems because space constraints in the file system can prevent the server from starting.

### Syntax

```
>>-DSMULOG--+-+-----+-----+----->>  
| .-,-----|  
| v         |  
'---logfile---+--'
```

## Parameters

---

logfilename (Required)

Specifies the name of one or more user log files to which IBM Spectrum Protect writes server console messages. When you specify multiple file names, each file is written to for one day and then the server moves to the next file to capture log messages. When all the files in the list have been written to, the server begins writing to the first file again and any messages contained therein are overwritten.

### Example: Capture console messages to a user log file

---

Use the DSMULOG command to log console messages to a user log file. Specify the user log files to which you want to log console messages.

```
dsmulog /u/admin/log1 /u/admin/log2 /u/admin/log3
```

## IBM Spectrum Protect server device utilities

---

You can use device utilities for tasks that are related to configuring storage devices for the server.

### Device utilities

---

- **AIX** tsmdlst (Display information about devices)
- **Linux** autoconf (Auto configure devices)
- **Windows** tsmdlst (Display information about devices)

**AIX**

### tsmdlst (Display information about devices)

---

Use the tsmdlst utility to view device names and other information about medium changer, and tape devices that are controlled by the IBM Spectrum Protect™ device driver.

The tsmdlst utility is part of the IBM Spectrum Protect device driver package that is the same for the server and the storage agent. You must install the IBM Spectrum Protect device driver to run the tsmdlst utility for the storage agent.

After devices are configured, you can run the tsmdlst utility to display device information. The utility saves this information in files that you can retrieve. The files are named lbinfo for medium changer devices, and mtinfo for tape devices. After a device is added or reconfigured, you can update these files by running the tsmdlst utility again.

The tsmdlst utility and the output files it generates are in the devices/bin directory, which is /opt/tivoli/tsm/devices/bin by default. Before you run the tsmdlst utility, make sure that either the IBM Spectrum Protect server is stopped or that all device activities are stopped. If a device is in use by the IBM Spectrum Protect server when the tsmdlst utility runs, a device busy error is issued.

### Options

---

/t

Displays trace messages for the tsmdlst utility.

/?

Displays usage information about tsmdlst and its parameters.

**AIX**

### Example: Display information about all devices

---

Display information about all devices that were configured by the IBM Spectrum Protect device driver:

```
tsmdlst
```

```
TSM Device Name Vendor Product ID Firmware World Wide Name Serial Number
-----
/dev/lb4 ATL P3000 0100 N/A 1651639999
TSM Device Name Vendor Product ID Firmware World Wide Name Serial Number
-----
```

/dev/mt0	QUANTUM	DLT-S4	2A2A	50:0e:09:e0:00:16:ca:47	QD0619AMD00052
/dev/mt1	QUANTUM	DLT-S4	2A2A	50:0e:09:e0:00:16:cd:e5	QD0624AMD00184
/dev/mt22	QUANTUM	DLT7000	0100	N/A	1651639000
/dev/mt23	QUANTUM	DLT7000	0100	N/A	1651639002

Linux

## autoconf (Auto configure devices)

Use the autoconf utility to configure devices for use with the IBM Spectrum Protect™ server.

The autoconf utility performs the following tasks:

- Loads the driver to the kernel
- Creates the necessary files for the IBM Spectrum Protect device driver
- Creates device information files for libraries and tape devices

The autoconf utility is included in the device driver package and is installed to the /opt/tivoli/tsm/devices/bin directory.

### Options

- a Adds read and write permissions to IBM Spectrum Protect device files to allow all users access to the devices. Specify this value to configure devices if the IBM Spectrum Protect server is started by a non-root user.
- g Adds read and write permissions to the IBM Spectrum Protect device files to allow anyone in the same group as a root user to use the devices.
- t Enables tracing for the autoconf utility.
- ? Displays information about the autoconf utility and its parameters.

### Example: Configure devices by using the autoconf utility

Run autoconf utility to configure IBM Spectrum Protect devices:

```
> /opt/tivoli/tsm/devices/bin/autoconf
```

Linux

### Example: For a server that is started by a non-root user ID, configure devices by using the autoconf utility

Run autoconf to configure IBM Spectrum Protect devices. Use the a option because the server is started by a user ID that is not the root user.

```
> /opt/tivoli/tsm/devices/bin/autoconf -a
```

```
Added the read and write permissions for all users to /dev/sg4.
Added the read and write permissions for all users to /dev/sg5.
Added the read and write permissions for all users to /dev/sg6.
Added the read and write permissions for all users to /dev/sg7.
Added the read and write permissions for all users to /dev/sg8.
Added the read and write permissions for all users to /dev/sg9.
Added the read and write permissions for all users to /dev/sg10.
Added the read and write permissions for all users to /dev/sg11.
Added the read and write permissions for all users to /dev/sg12.
Added the read and write permissions for all users to /dev/sg13.
Added the read and write permissions for all users to /dev/sg14.
Added the read and write permissions for all users to /dev/sg15.
Added the read and write permissions for all users to /dev/sg16.
Added the read and write permissions for all users to /dev/sg17.
Added the read and write permissions for all users to /dev/sg18.
Added the read and write permissions for all users to /dev/sg19.
Added the read and write permissions for all users to /dev/sg20.
Added the read and write permissions for all users to /dev/sg21.
Added the read and write permissions for all users to /dev/sg22.
```

Added the read and write permissions for all users to /dev/sg23.  
 Added the read and write permissions for all users to /dev/sg24.  
 Added the read and write permissions for all users to /dev/sg25.  
 Added the read and write permissions for all users to /dev/sg26.  
 Added the read and write permissions for all users to /dev/sg27.  
 Added the read and write permissions for all users to /dev/sg28.  
 Added the read and write permissions for all users to /dev/sg29.

#### Tape Drives:

```
=====
```

Index	Minor	Host	CHN	ID	LUN	Type	Vendor_ID	Device_Serial_Number	Product_ID	Rev.
000	004	003	000	004	000	001	IBM	1068000439	ULTRIUM-HH5	C5X1
001	007	003	000	008	001	001	HP	01UbWSD-04	Ultrium 2-SCSI	R210
002	008	003	000	008	002	001	HP	01UbWSD-05	Ultrium 2-SCSI	R210
003	010	003	000	008	004	001	HP	01UbWSD-07	Ultrium 3-SCSI	R210
004	012	003	000	008	006	001	HP	01UbWSD-01	Ultrium 3-SCSI	R210
005	013	003	000	008	007	001	HP	01UbWSD-02	Ultrium 3-SCSI	R210
006	014	003	000	008	008	001	HP	01UbWSD-08	Ultrium 3-SCSI	R210
007	015	003	000	008	009	001	HP	01UbWSD-09	Ultrium 3-SCSI	R210
008	016	003	000	008	010	001	HP	01UbWSD-0a	Ultrium 3-SCSI	R210
009	017	003	000	008	011	001	HP	01UbWSD-0b	Ultrium 3-SCSI	R210
010	018	003	000	008	012	001	HP	01UbWSD-0c	Ultrium 3-SCSI	R210
011	019	003	000	008	013	001	HP	01UbWSD-0d	Ultrium 3-SCSI	R210
012	020	003	000	005	000	001	IBM	1068000913	ULTRIUM-HH5	C5X1
013	022	003	000	009	001	001	QUANTUM	01UbWSD-0f	SDLT320	R210
014	023	003	000	009	002	001	QUANTUM	01UbWSD-0g	SDLT320	R210
015	024	003	000	009	003	001	QUANTUM	01UbWSD-0h	SDLT320	R210
016	025	003	000	009	004	001	QUANTUM	01UbWSD-0i	SDLT320	R210
017	026	003	000	006	000	001	IBM	1068001573	ULTRIUM-HH4	B5Q1
018	027	003	000	007	000	001	IBM	1068001545	ULTRIUM-HH4	B5Q1
019	028	003	000	010	000	001	HP	HU19477PAE	Ultrium 5-SCSI	I65W

#### Medium Changer Devices:

```
=====
```

Index	Minor	Host	CHN	ID	LUN	Type	Vendor_ID	Device_Serial_Number	Product_ID	Rev.
000	005	003	000	004	001	008	NEC	2Y11BB0023	LL-2B01	0004
001	006	003	000	008	000	008	HP	01UbWSD-03	VLS	1.00
002	009	003	000	008	003	008	HP	01UbWSD-06	ThinStor AutoLdr	T133
003	011	003	000	008	005	008	HP	01UbWSD-00	ESL E-Series	2.00
004	021	003	000	009	000	008	HP	01UbWSD-0e	MSL6000 Series	0430
005	029	003	000	010	001	008	HP	3615-0101	MSL G3 Series	1120

Windows

## tsmdlst (Display information about devices)

Use the tsmdlst utility to view device names and other information about medium changer and tape devices on the system.

### Options

After devices are configured, you can run the tsmdlst utility to display device information. The utility is in the devices server directory, which is \Program Files\Tivoli\TSM\server by default.

/computer=computer\_name

Specifies the name of the computer for which devices are listed. The default is the local system.

/detail

Displays details on devices in the list. By default, a summary is shown.

/all

Displays information about all types of devices. By default, only tape drives and tape libraries are included in the results.

/nogenerictapecheck

Skips the step for opening detected drives to see whether they are supported for the IBM Spectrum Protect™ GENERICTAPE device type.

/nohbatcheck

Skips the step for host bus adapter (HBA) API detection, which might speed up processing. This option can be useful when debugging is needed.

/trace

Used for diagnostic purposes. Stores trace output in the tsmdlst\_trace.txt file.

/?

Displays usage information about tsmdlst and its parameters.

## /xinquiry

Provides an alternative way to obtain serial number and worldwide name information. This option is used only for devices that are supported by the IBM® tape device driver. The following parameters are specific to the /xinquiry option:

### /processAll

Indicates that the process loops until all devices are processed.

### /maxRetries=#

Indicates the maximum number of attempts to open each drive. This option requires the /processAll option.

### /genpathfile

Use this option to generate a list of devices and serial numbers. The tsmdlst\_pathfile.txt file is written with information for the /genmacropathsync and /genmacropathoffline options.

### /includelib

If this parameter is specified with the /genpathfile option, the list of devices includes libraries in addition to drives.

## /genmacropathsync

Generates a macro to synchronize IBM Spectrum Protect paths for the storage agent based on serial number. A drive must have a serial number that is defined to IBM Spectrum Protect for this option to work.

## /genmacropathoffline

Generates a macro to update IBM Spectrum Protect paths for the storage agent to online or offline status based on drive accessibility. A drive is accessible if an operating system open call results in: ERROR\_SUCCESS, ERROR\_BUSY or ERROR\_ACCESS\_DENIED. This option works only for devices that are using the IBM device driver. A symbolic name, for example \\.\tape0, is required to open a device.

The following options are used only with the /genmacropathsync and /genmacropathoffline options:

### /server=servername

Specifies the name of the server that the storage agent is using.

### /stagent=stagentname

Specifies the name of the storage agent.

### /tcps=address

Specifies the IBM Spectrum Protect server address.

### /tcpport=port

Specifies the IBM Spectrum Protect server port. The default is 1500.

### /id=id

Specifies the IBM Spectrum Protect administrative ID.

### /pass=password

Specifies the IBM Spectrum Protect administrative password.

### /devicetype=drivetype

Specifies the device type of the drive, for example, LTO. This option is case-sensitive and optional.

### /libraryname=libname

Filters on the library name of the drive, for example LTO3584. This option is case-sensitive and optional.

### /execmacropathsync

Issues the path synchronize macro to the IBM Spectrum Protect server.

### /execmacropathoffline

Issues the path offline macro to the IBM Spectrum Protect server.

### /addpaths

Adds define and update path statements. This option is used with the /genmacropathsync option.

### /verbose

Lists both drive and path information returned from the IBM Spectrum Protect server and contents of the path file.

### /encodednames

If a path is set to online=no, the device name encodes time stamp, error, and device as the updated device name.

## Example: Display information about devices

---

Display information about tape devices and tape libraries for a local system, WANTON, by running the tsmdlst utility:

```
tsmdlst
```

The device name that is displayed is the alias name that can be used in the DEFINE PATH command and the UPDATE PATH command. The alias name is not the actual device name.

```
Computer Name:      WANTON
OS Version:        6.2
OS Build #:        9200
TSM Device Driver: TSMScsi - Not Running
```

4 HBAs were detected.

Manufacturer	Model	Driver	Version	Firmware	NodeWWN	Description
QLogic Corporation	QLE2562	ql2300.sys	9.1.11.28	7.03.00	20000024FF25F846	QLogic QLE2562 Fibre Channel Adapter
QLogic Corporation	QLE2562	ql2300.sys	9.1.11.28	7.03.00	20000024FF25F847	QLogic QLE2562 Fibre Channel Adapter
QLogic Corporation	QLE2562	ql2300.sys	9.1.11.28	7.03.00	20000024FF25F7FE	QLogic QLE2562 Fibre Channel Adapter
QLogic Corporation	QLE2562	ql2300.sys	9.1.11.28	7.03.00	20000024FF25F7FF	QLogic QLE2562 Fibre Channel Adapter

TSM Name Identifier	ID	LUN	Bus	Port	SSN	WWN	TSM Type	Driver	Device
mt0.0.0.7	0	0	0	7	000001327176	5005076300566011	3592	IBM	IBM
03592E06	2883								
lb0.1.0.7	0	1	0	7	0000013400480405	5005076300566011	LIBRARY	IBM	IBM
03584L22	E01q								
mt1.0.0.7	1	0	0	7	000001327147	5005076300566012	3592	IBM	IBM
03592E06	2883								
mt2.0.0.7	2	0	0	7	000001327349	5005076300566013	3592	IBM	IBM
03592E06	2883								
mt3.0.0.7	3	0	0	7	000001327140	5005076300566014	3592	IBM	IBM
03592E06	2883								
mt4.0.0.7	4	0	0	7	1068000254	500507630F51FA05	LTO	IBM	IBM
ULT3580-TD5	D8D4								
lb4.1.0.7	4	1	0	7	0000078216780402	500507630F51FA05	LIBRARY	IBM	IBM
03584L32	C460								
mt5.0.0.7	5	0	0	7	1068000039	500507630F51FA06	LTO	IBM	IBM
ULT3580-TD5	D8D4								
mt6.0.0.7	6	0	0	7	1068000047	500507630F51FA07	LTO	IBM	IBM
ULT3580-TD5	D8D4								
mt7.0.0.7	7	0	0	7	1068000017	500507630F51FA08	LTO	IBM	IBM
ULT3580-TD5	D8D4								

## Server scripts and macros for automation

You can automate common administrative tasks by creating IBM Spectrum Protect™ server scripts or administrative client macros. Server scripts are stored in the server database and can be scheduled to run with an administrative schedule command. Administrative client macros are stored as files on the administrative client. Macros cannot be distributed across servers and cannot be scheduled on the server.

- **Server scripts**  
You can automate common administrative tasks with scripts that are stored in the server database. You can schedule a script for processing by using the administrative command scheduler on the server.
- **Administrative client macros**  
A macro is a file that contains one or more administrative client commands. You can run a macro from the administrative client only in batch or interactive modes. Macros are stored as a file on the administrative client. Macros are not distributed across servers and cannot be scheduled on the server.

## Server scripts

You can automate common administrative tasks with scripts that are stored in the server database. You can schedule a script for processing by using the administrative command scheduler on the server.

IBM Spectrum Protect™ scripts have the following capabilities and statements:

- Command parameter substitution.
- SELECT commands that you specify when the script is processed.
- Command execution control, such as PARALLEL and SERIAL processing options.
- Conditional logic flow statements. These logic flow statements include the following statements:
  - The IF clause; this clause determines how processing proceeds based on the current return code value.
  - The EXIT statement; this statement ends script processing.

- The GOTO and LABEL statement. This statement directs logic flow to continue processing with the line that starts with the label specified.
- Comment lines.

Sample scripts are provided in the scripts.smp file. The sample scripts have an example order of execution for scheduling administrative commands.

If one of the specified commands in the script does not process successfully, the remaining commands are not processed.

- Defining a server script  
You can define a server script line-by-line, create a file that contains the command lines, or copy an existing script.
- Updating a script  
You can update a script to change a command line or to add a command line to a script.
- Querying a server script to create another server script  
You can create more server scripts by querying a script and specifying the FORMAT=RAW and OUTPUTFILE parameters. You can use the resulting output as input into another script without having to create a script line by line.
- Running a server script  
To process a script, use the RUN command. You can run a script that contains substitution variables by specifying them along with the RUN command.

## Defining a server script

---

You can define a server script line-by-line, create a file that contains the command lines, or copy an existing script.

### About this task

---

**Restriction:** You cannot redirect the output of a command within a server script. Instead, run the script and then specify command redirection. For example, to direct the output of script1 to the c:\temp\test.out directory, run the script and specify command redirection as in the following example:

```
run script1 > c:\temp\test.out
```

### Procedure

---

1. Define a script with the DEFINE SCRIPT command. You can initially define the first line of the script with this command. For example:

```
define script qaixc "select node_name from nodes where platform='aix'"
desc='Display AIX clients'
```

This example defines the script as QAIXC. When you run the script, all AIX® clients are displayed.

2. Define more lines in the script with the UPDATE SCRIPT command. For example, you want to add a QUERY SESSION command, enter:

```
update script qaixc "query session *"
```

3. Optional: You can specify a WAIT parameter with the DEFINE CLIENTACTION command. By using this parameter, you can specify that the client action must complete before the next step in the command script or macro is processed.
  4. Optional: To help you determine where a problem is within a command in a script, use the ISSUE MESSAGE command.
- Running commands in parallel or serially  
You have the options of running commands in a script serially, in parallel, or serially and in parallel. You can do so by using the SERIAL or PARALLEL script commands in the COMMAND\_LINE parameter of DEFINE and UPDATE SCRIPT. Therefore, it is possible to run multiple commands in parallel and wait for them to complete before the next command is run.
  - Continuing commands across multiple command lines  
You can continue long commands across multiple command lines by specifying the continuation character (-) as the last character for a command that is continued.
  - Including substitution variables in a script  
You can include substitution variables in a script. Substitution variables are specified with a \$ character followed by a number that represents the position of the parameter when the script is processed.
  - Including logic flow statements in a script  
You can use conditional logic flow statements that are based on return codes that are issued from previous command processing. By using these logic statements, you can process your scripts according to the outcome of certain commands. You can use IF, EXIT, or GOTO (label) statements.



- Using SELECT commands in a script  
An IBM Spectrum Protect™ script is one or more commands that are stored as an object in the database. You can define a script that contains one or more SELECT commands.

## Running commands in parallel or serially

---

You have the options of running commands in a script serially, in parallel, or serially and in parallel. You can do so by using the SERIAL or PARALLEL script commands in the COMMAND\_LINE parameter of DEFINE and UPDATE SCRIPT. Therefore, it is possible to run multiple commands in parallel and wait for them to complete before the next command is run.

### About this task

---

Running commands serially in a script ensures that any preceding commands are complete before proceeding and ensures that any following commands are run serially. When a script starts, all commands are run serially until a PARALLEL command is encountered. Multiple commands that are running in parallel and accessing common resources, such as tape drives, can run serially.

Script return codes remain the same before and after a PARALLEL command is run. When a SERIAL command is encountered, the script return code is set to the maximum return code from any previous commands that were run in parallel.

When you use server commands that support the WAIT parameter after a PARALLEL command, the behavior is as follows:

- If you specify (or use the default) WAIT=NO, a script does not wait for the completion of the command when a subsequent SERIAL command is encountered. The return code from that command reflects processing only up to the point that the command starts a background process. The final return code from the command is not available to your script.
- If you specify WAIT=YES, your script waits for the completion of the command when a subsequent SERIAL command is encountered. The return code from that command reflects processing for the entire command.

In most cases, you can use WAIT=YES on commands that are run in parallel.

Restriction: If the command starts a background process that does not have the WAIT parameter, the command is considered to be complete after the background thread is started. Therefore, the command can run only in parallel.

The following example illustrates how the PARALLEL command is used to back up, migrate, and reclaim storage pools.

```
/*run multiple commands in parallel and wait for
them to complete before proceeding*/
PARALLEL
/*back up four storage pools simultaneously*/
BACKUP STGPOOL PRIMPOOL1 COPYPOOL1 WAIT=YES
BACKUP STGPOOL PRIMPOOL2 COPYPOOL2 WAIT=YES
BACKUP STGPOOL PRIMPOOL3 COPYPOOL3 WAIT=YES
BACKUP STGPOOL PRIMPOOL4 COPYPOOL4 WAIT=YES
/*wait for all previous commands to finish*/
SERIAL
/*after the backups complete, migrate stgpools
simultaneously*/
PARALLEL
MIGRATE STGPOOL PRIMPOOL1 DURATION=90 WAIT=YES
MIGRATE STGPOOL PRIMPOOL2 DURATION=90 WAIT=YES
MIGRATE STGPOOL PRIMPOOL3 DURATION=90 WAIT=YES
MIGRATE STGPOOL PRIMPOOL4 DURATION=90 WAIT=YES
/*wait for all previous commands to finish*/
SERIAL
/*after migration completes, reclaim storage
pools simultaneously*/
PARALLEL
RECLAIM STGPOOL PRIMPOOL1 DURATION=120 WAIT=YES
RECLAIM STGPOOL PRIMPOOL2 DURATION=120 WAIT=YES
RECLAIM STGPOOL PRIMPOOL3 DURATION=120 WAIT=YES
RECLAIM STGPOOL PRIMPOOL4 DURATION=120 WAIT=YES
```

#### Related reference:

DEFINE SCRIPT (Define a server script)  
UPDATE SCRIPT (Update a server script)

## Continuing commands across multiple command lines

---

---

You can continue long commands across multiple command lines by specifying the continuation character (-) as the last character for a command that is continued.

## About this task

---

The following example continues an SQL statement across multiple command lines:

```
/*-----*/
/* Sample continuation example */
SELECT-
 * FROM-
NODE WHERE-
PLATFORM='win32'
```

When this command is processed, it runs the following command:

```
select * from nodes where platform='win32'
```

## Including substitution variables in a script

---

You can include substitution variables in a script. Substitution variables are specified with a \$ character followed by a number that represents the position of the parameter when the script is processed.

### About this task

---

The following example SQLSAMPLE script specifies substitution variables \$1 and \$2:

```
/*-----*/
/* Sample substitution example */
/* -----*/
SELECT-
$1 FROM-
NODES WHERE-
PLATFORM=' $2'
```

When you run the script you must specify two values, one for \$1 and one for \$2. For example:

```
run sqlsample node_name aix
```

The command that is processed when the SQLSAMPLE script is run is the following command:

```
select node_name from nodes where platform='aix'
```

## Including logic flow statements in a script

---

You can use conditional logic flow statements that are based on return codes that are issued from previous command processing. By using these logic statements, you can process your scripts according to the outcome of certain commands. You can use IF, EXIT, or GOTO (label) statements.

As each command is processed in a script, the return code is saved for possible evaluation before the next command is processed. The return code can be one of three severities: OK, WARNING, or ERROR. See Return codes for use in scripts for a list of valid return codes and severity levels.

- Specifying the IF clause  
You can use the IF clause at the beginning of a command line to determine how processing of the script proceeds based on the current return code value. In the IF clause, you specify a return code symbolic value or severity.
- Specifying the EXIT statement  
Use the EXIT statement to end script processing.
- Specifying the GOTO statement  
The GOTO statement is used with a label statement. The label statement is the target of the GOTO statement. The GOTO statement directs script processing to the line that contains the label statement to resume processing from that point.

## Specifying the IF clause

---

You can use the IF clause at the beginning of a command line to determine how processing of the script proceeds based on the current return code value. In the IF clause, you specify a return code symbolic value or severity.

## About this task

---

The server initially sets the return code at the beginning of the script to RC\_OK. The return code is updated by each processed command. If the current return code from the processed command is equal to any of the return codes or severities in the IF clause, the remainder of the line is processed. If the current return code is not equal to one of the listed values, the line is skipped.

The following script example backs up the BACKUPPOOL storage pool only if there are no sessions currently accessing the server. The backup proceeds only if a return code of RC\_NOTFOUND is received:

```
/* Backup storage pools if clients are not accessing the server */
select * from sessions
/* There are no sessions if rc_notfound is received */
if(rc_notfound) backup stg backuppool cypool
```

The following script example backs up the BACKUPPOOL storage pool if a return code with a severity of warning is encountered:

```
/* Backup storage pools if clients are not accessing the server */
select * from sessions
/* There are no sessions if rc_notfound is received */
if(warning) backup stg backuppool cypool
```

## Specifying the EXIT statement

---

Use the EXIT statement to end script processing.

## About this task

---

The following example uses the IF clause together with RC\_OK to determine if clients are accessing the server. If an RC\_OK return code is received, it indicates that client sessions are accessing the server. The script proceeds with the exit statement, and the backup does not start.

```
/* Back up storage pools if clients are not accessing the server */
select * from sessions
/* There are sessions if rc_ok is received */
if(rc_ok) exit
backup stg backuppool cypool
```

## Specifying the GOTO statement

---

The GOTO statement is used with a label statement. The label statement is the target of the GOTO statement. The GOTO statement directs script processing to the line that contains the label statement to resume processing from that point.

## About this task

---

The label statement always has a colon (:) after it and can be blank after the colon. The following example uses the GOTO statement to back up the storage pool only if there are no sessions currently accessing the server. In this example, the return code of RC\_OK indicates that clients are accessing the server. The GOTO statement directs processing to the `done:` label, which contains the EXIT statement that ends the script processing:

```
/* Back up storage pools if clients are not accessing the server */
select * from sessions
/* There are sessions if rc_ok is received */
if(rc_ok) goto done
backup stg backuppool cypool
done:exit
```

## Using SELECT commands in a script

---

An IBM Spectrum Protect™ script is one or more commands that are stored as an object in the database. You can define a script that contains one or more SELECT commands.

## About this task

---

A script can be run from an administrative client or the server console. You can also include it in an administrative command schedule to run automatically. See Server scripts for details.

IBM Spectrum Protect is shipped with a file that contains a number of sample scripts. The file, `scripts.smp`, is in the server directory. To create and store the scripts as objects in your server's database, issue the `DSMSERV RUNFILE` command during installation:

```
> dsmserv runfile scripts.smp
```

You can also run the file as a macro from an administrative command line client:

```
macro scripts.smp
```

The sample scripts file contains commands. These commands first delete any scripts with the same names as those to be defined, then define the scripts. The majority of the samples create `SELECT` commands, but others do such things as back up storage pools. You can also copy and change the sample scripts file to create your own scripts.

Here are a few examples from the sample scripts file:

```
def script q_inactive_days /* -----*/
upd script q_inactive_days /* Script Name:  Q_INACTIVE          */
upd script q_inactive_days /* Description: Display nodes that have not /*
upd script q_inactive_days /*   accessed the backup server for a /*
upd script q_inactive_days /*   specified number of days /*
upd script q_inactive_days /* Parameter 1: days /*
upd script q_inactive_days /* Example:   run q_inactive_days 5 /*
upd script q_inactive_days /* -----*/
upd script q_inactive_days "select node_name,lastacc_time from nodes where -"
upd script q_inactive_days " cast((current_timestamp-lastacc_time)days as -"
upd script q_inactive_days " decimal) >= $1 "

/* Display messages in the activity log of severity X or Y          */

def script q_msg_sev desc='Show msgs in the activity log of severity X or Y'
upd script q_msg_sev /* -----*/
upd script q_msg_sev /* Script Name:  Q_MSG_SEV          */
upd script q_msg_sev /* Description: Display messages in the /*
upd script q_msg_sev /*   activity log that have either /*
upd script q_msg_sev /*   of two specified severities. /*
upd script q_msg_sev /* Parameter 1: severity 1 /*
upd script q_msg_sev /* Parameter 2: severity 2 /*
upd script q_msg_sev /* where severity is I, W, E, S, or D /*
upd script q_msg_sev /* Example:   run q_msg_sev S E /*
upd script q_msg_sev /* -----*/
upd script q_msg_sev "select date_time,msgno,message from actlog -"
upd script q_msg_sev " where severity=upper('$1') or severity=upper('$2')"
```

## Updating a script

---

You can update a script to change a command line or to add a command line to a script.

- **Appending a new command**  
To append a command line to an existing script issue the `UPDATE SCRIPT` command without the `LINE=` parameter. The appended command line is assigned a line number of five greater than the last command line number in the command line sequence. For example, if your script ends with line 010, the appended command line is assigned a line number of 015.
- **Replacing an existing command**  
You can change an existing command line by specifying the `LINE=` parameter.
- **Adding a command and line number**  
You can change an existing script by adding new lines.
- **Deleting a command from a server script**  
You can delete an individual command line from a script. When you specify a line number, only the corresponding command line is deleted from the script.

## Appending a new command

---

To append a command line to an existing script issue the UPDATE SCRIPT command without the LINE= parameter. The appended command line is assigned a line number of five greater than the last command line number in the command line sequence. For example, if your script ends with line 010, the appended command line is assigned a line number of 015.

## About this task

---

The following is an example of the QSTATUS script. The script has lines 001, 005, and 010 as follows:

```
001 /* This is the QSTATUS script */
005 QUERY STATUS
010 QUERY PROCESS
```

To append the QUERY SESSION command at the end of the script, issue the following command:

```
update script qstatus "query session"
```

The QUERY SESSION command is assigned a command line number of 015 and the updated script is as follows:

```
001 /* This is the QSTATUS script */
005 QUERY STATUS
010 QUERY PROCESS
015 QUERY SESSION
```

## Replacing an existing command

---

You can change an existing command line by specifying the LINE= parameter.

## About this task

---

Line number 010 in the QSTATUS script contains a QUERY PROCESS command. To replace the QUERY PROCESS command with the QUERY STGPOOL command, specify the LINE= parameter as follows:

```
update script qstatus "query stgpool" line=10
```

The QSTATUS script is updated to contain the following lines:

```
001 /* This is the QSTATUS script */
005 QUERY STATUS
010 QUERY STGPOOL
015 QUERY SESSION
```

## Adding a command and line number

---

You can change an existing script by adding new lines.

## About this task

---

To add the QUERY NODE command as the new line 007 in the QSTATUS script, issue the following command:

```
update script qstatus "query node" line=7
```

The QSTATUS script is updated to contain the following lines:

```
001 /* This is the QSTATUS script */
005 QUERY STATUS
007 QUERY NODE
010 QUERY STGPOOL
015 QUERY SESSION
```

## Deleting a command from a server script

---

You can delete an individual command line from a script. When you specify a line number, only the corresponding command line is deleted from the script.

## About this task

---

For example, to delete the 007 command line from the QSTATUS script, issue the following command:

```
delete script qstatus line=7
```

## Querying a server script to create another server script

---

You can create more server scripts by querying a script and specifying the `FORMAT=RAW` and `OUTPUTFILE` parameters. You can use the resulting output as input into another script without having to create a script line by line.

### About this task

---

The following example shows how to query the SRTL2 script and direct the output to `newsript.script`:

```
query script srtl2 format=raw outputfile=newscript.script
```

You can then edit the `newsript.script` file with an editor that is available to you on your system. To create a new script by using the edited output from your query, issue:

```
define script srtnew file=newscript.script
```

## Running a server script

---

To process a script, use the `RUN` command. You can run a script that contains substitution variables by specifying them along with the `RUN` command.

### About this task

---

To stop a script that is running, an administrator must halt the server. You cannot cancel a script after it starts by using an IBM Spectrum Protect™ command.

### Procedure

---

- Preview the commands in a script to evaluate the script before you run it. To preview the script without running the commands, enter the `RUN` command with the `PREVIEW=YES` parameter. If the script contains substitution variables, the commands are displayed with the substituted variables.
- Run a script that has no variables by entering the following command: `run qaixc` where `qaixc` is the name of the script.
- Run a script that contains substitution variables by specifying the variable values with the command. Contents of the script:

```
/*-----*/  
/* Sample continuation and substitution example */  
/* -----*/  
SELECT-  
$1 FROM-  
NODES WHERE-  
PLATFORM='$2'
```

To run this script, enter the following command:

```
run qaixc node_name aix
```

Where `node_name` is the value for the `$1` variable and `aix` is the value for the `$2` variable.

#### Related reference:

[RUN \(Run a server script\)](#)

## Administrative client macros

---

A macro is a file that contains one or more administrative client commands. You can run a macro from the administrative client only in batch or interactive modes. Macros are stored as a file on the administrative client. Macros are not distributed across servers and cannot be scheduled on the server.

Macros can include the following elements:

- Administrative server commands

- Comments
- Continuation characters
- Variables

The name for a macro must follow the naming conventions of the administrative client that is running on your operating system.

In a macro that contains several commands, use the COMMIT and ROLLBACK commands to control command processing within the macro.

You can include the MACRO command within a macro file to call other macros up to 10 levels deep. A macro that is called from the administrative client command line is called a high-level macro. Any macros that are called from within the high-level macro are called *nested* macros.

- Writing commands in a macro  
Add administrative commands to a macro. The administrative client ignores any blank lines included in your macro. However, a blank line ends a command that is continued (with a continuation character).
- Writing comments in a macro  
Add comments to your macro file to describe the purpose or the commands in it.
- Including continuation characters in a macro  
You can use continuation characters in a macro file when you want to run a command that is longer than your screen or window width.
- Including substitution variables in a macro  
You can use substitution variables in a macro so that when you run the macro, you can provide values for items such as command parameters. When you use substitution variables, you can use a macro again and again, whenever you need to complete the same task for different objects or with different parameter values.
- Running a macro  
Use the MACRO command when you want to run a macro. You can enter the MACRO command in batch or interactive mode.
- Command processing in a macro  
When you issue a MACRO command, the server processes all commands in the macro file in order, including commands that are contained in any nested macros. The server commits all commands in a macro after successfully completing processing for the highest-level macro.

## Writing commands in a macro

---

Add administrative commands to a macro. The administrative client ignores any blank lines included in your macro. However, a blank line ends a command that is continued (with a continuation character).

### About this task

---

The following is an example of a macro that is called REG.MAC that registers and grants authority to a new administrator:

```
register admin pease mypasswd -
  contact='david pease, x1234'
grant authority pease -
  classes=policy,storage -
  domains=domain1,domain2 -
  stgpools=stgpool1,stgpool2
```

This example uses continuation characters in the macro file. For more information about continuation characters, see Including continuation characters in a macro.

After you create a macro file, you can update the information that it contains and use it again. You can also copy the macro file. After you have a copy of the macro, you can modify and run the copy.

## Writing comments in a macro

---

Add comments to your macro file to describe the purpose or the commands in it.

### About this task

---

To write a comment:

- Write a slash and an asterisk (/\*) to indicate the beginning of the comment.

- Write the comment.
- Write an asterisk and a slash (\*) to indicate the end of the comment.

You can put a comment on a line by itself, or you can put it on a line that contains a command or part of a command.

For example, to use a comment to identify the purpose of a macro, write the following line:

```
/* auth.mac-register new nodes */
```

Or you can write a comment to explain something about a command or part of a command:

```
domain=domain1 /*assign node to domain1 */
```

Comments cannot be nested and cannot span lines. Every line of a comment must contain the comment delimiters.

## Including continuation characters in a macro

---

You can use continuation characters in a macro file when you want to run a command that is longer than your screen or window width.

### About this task

---

Without continuation characters, you can enter up to 256 characters. With continuation characters, you can enter up to 1500 characters. In the MACRO command, values of substitution variables are included in the count of characters.

To use a continuation character, enter a dash or a backslash at the end of the line that you want to continue. With continuation characters, you can continue the following lines of a macro.

### Examples

---

- Continue a command, for example:

```
register admin pease mypasswd -  
contact="david, ext1234"
```

- Continue a list of values by entering a dash or a backslash, with no preceding blank spaces, after the last comma of the list that you enter on the first line. Then, enter the remaining items in the list on the next line with no preceding blank spaces. In the following example a list of storage pool names continues across lines:

```
stgpools=stg1, stg2, stg3, -  
stg4, stg5, stg6
```

- Continue a string of values that are enclosed in quotation marks by entering the first part of the string in quotation marks, followed by a dash or a backslash at the end of the line. Then, enter the remainder of the string on the next line. Enclose the remainder of the string in the same type of quotation marks. The following example shows a string that continues across lines:

```
contact="david pease, bldg. 100, room 2b, san jose, "-  
"ext. 1234, alternate contact-norm pass, ext 2345"
```

The two strings are concatenated with no intervening blanks. You must use only this method to continue a quoted string of values across more than one line.

## Including substitution variables in a macro

---

You can use substitution variables in a macro so that when you run the macro, you can provide values for items such as command parameters. When you use substitution variables, you can use a macro again and again, whenever you need to complete the same task for different objects or with different parameter values.

### About this task

---

A substitution variable consists of a percent sign (%), followed by a unique number that identifies the substitution variable. When you run the file with the MACRO command, you must specify values for the variables.

Restrictions:



- If your system uses the percent sign as a wildcard character, the administrative client interprets a pattern-matching expression in a macro where the percent sign is immediately followed by a digit as a substitution variable.
- You cannot enclose a substitution variable in quotation marks. However, a value that you supply as a substitution for the variable can be a quoted string.

## Example

Create a macro that is named AUTH.MAC to register new nodes. The macro has four substitution variables for parameters in the command:

```
/* register new nodes */
register node %1 %2 -      /* userid password          */
  contact=%3 -           /* 'name, phone number'    */
  domain=%4              /* policy domain           */
```

When you run the macro, you must enter the values that you want to pass to the server to process the command.

For example, to use the macro to register the node that is named DAVID with a password of DAVIDPW, include a name and phone number as contact information, and assign it to the DOMAIN1 policy domain, enter the following command:

```
macro auth.mac david davidpw "david pease, x1234" domain1
```

## Running a macro

Use the MACRO command when you want to run a macro. You can enter the MACRO command in batch or interactive mode.

### About this task

If the macro does not contain substitution variables, run the macro by entering the MACRO command with the name of the macro file. For example:

```
macro reg.mac
```

If the macro contains substitution variables, include the values that you want to supply after the name of the macro. Each value is delimited by a space. For example:

```
macro auth.mac pease mypasswd "david pease, x1234" domain1
```

If you enter fewer values than there are substitution variables in the macro, the administrative client replaces the remaining variables with null strings.

If you want to omit one or more values between values, enter a null string ("" ) for each omitted value. For example, if you omit the contact information in the previous example, you must enter:

```
macro auth.mac pease mypasswd "" domain1
```

#### Related reference:

MACRO (Invoke a macro)

## Command processing in a macro

When you issue a MACRO command, the server processes all commands in the macro file in order, including commands that are contained in any nested macros. The server commits all commands in a macro after successfully completing processing for the highest-level macro.

If an error occurs in any command in the macro or in any nested macro, the server stops processing and rolls back any changes that were caused by all previous commands.

If you specify the ITEMCOMMIT option when you enter the DSMADMC command, the server commits each command in a script or a macro individually after successfully completing processing for each command. If an error occurs, the server continues processing and rolls back only the changes caused by the failed command.

You can control precisely when commands are committed with the COMMIT command. If an error occurs while the server is processing the commands in a macro, the server stops processing the macro and rolls back any uncommitted changes. Uncommitted changes are commands that were processed since the last COMMIT command. Make sure that your administrative

client session is not running with the ITEMCOMMIT option if you want to control command processing with the COMMIT command.

You can test a macro before you implement it by using the ROLLBACK command. You can enter the commands (except the COMMIT command) you want to issue in the macro, and enter ROLLBACK as the last command. Then, you can run the macro to verify that all the commands process successfully. Any changes to the database caused by the commands are rolled back by the ROLLBACK command. Remember to remove the ROLLBACK command before you make the macro available for actual use. Also, make sure that your administrative client session is not running with the ITEMCOMMIT option if you want to control command processing with the ROLLBACK command.

Tip: Commands that start background processes cannot be rolled back.

If you have a series of commands that process successfully from the command line, but are unsuccessful when issued within a macro, there are probably dependencies between commands. It is possible that a command issued within a macro cannot be processed successfully until a previous command that is issued within the same macro is committed. Either of the following actions allows successful processing of these commands within a macro:

- Insert a COMMIT command before the command dependent on a previous command. For example, if COMMAND C is dependent upon COMMAND B, you would insert a COMMIT command before COMMAND C.

```
command a
command b
commit
command c/
```

- Start the administrative client session by using the ITEMCOMMIT option. This option causes each command within a macro to be committed before the next command is processed.

**Related reference:**

COMMIT (Control committing of commands in a macro)

ROLLBACK (Rollback uncommitted changes in a macro)

## Return codes for use in IBM Spectrum Protect scripts

You can write IBM Spectrum Protect™ scripts that use return codes to determine how script processing proceeds. The return codes can be one of three severities: OK, WARNING, ERROR.

IBM Spectrum Protect scripts use the symbolic return code for processing, not the numeric value. The administrative client displays the numeric values when a command is run. The return codes are shown in the following table.

Table 1. Return codes

Return code	Severity	Numeric value	Description
RC_OK	OK	0	The command completed successfully.
RC_UNKNOWN	ERROR	2	The command is not found; not a known command.
RC_SYNTAX	ERROR	3	The command is valid, but one or more parameters were not specified correctly.
RC_ERROR	ERROR	4	An internal server error prevented the command from successfully completing.
RC_NOMEMORY	ERROR	5	The command could not be completed because of insufficient memory on the server.
RC_NOLOG	ERROR	6	The command could not be completed because of insufficient recovery log space on the server.
RC_NODB	ERROR	7	The command could not be completed because of insufficient database space on the server.
RC_NOSTORAGE	ERROR	8	The command could not be completed because of insufficient storage space on the server.
RC_NOAUTH	ERROR	9	The command failed because the administrator is not authorized to issue the command.

Return code	Severity	Numeric value	Description
RC_EXISTS	ERROR	10	The command failed because the specified object already exists on the server.
RC_NOTFOUND	WARNING	11	Returned by a QUERY or SQL SELECT command when no objects are found that match specifications.
RC_INUSE	ERROR	12	The command failed because the object to be operated upon was in use.
RC_ISREFERENCED	ERROR	13	The command failed because the object to be operated upon is still referenced by some other server construct.
RC_NOTAVAILABLE	ERROR	14	The command failed because the object to be operated upon is not available.
RC_IOERROR	ERROR	15	The command failed because an input/output (I/O) error was encountered on the server.
RC_NOTXN	ERROR	16	The command failed because a database transaction failed on the server.
RC_NOLOCK	ERROR	17	The command failed because a lock conflict was encountered in the server database.
RC_NOTHREAD	ERROR	19	The command could not be completed because of insufficient memory on the server.
RC_LICENSE	ERROR	20	The command failed because the server is not in compliance with licensing.
RC_INVDEST	ERROR	21	The command failed because a destination value was invalid.
RC_IFILEOPEN	ERROR	22	The command failed because an input file that was needed could not be opened.
RC_OFILEOPEN	ERROR	23	The command failed because it could not open a required output file.
RC_OFILEWRITE	ERROR	24	The command failed because it could not successfully write to a required output file.
RC_INVADMIN	ERROR	25	The command failed because the administrator was not defined.
RC_SQLERROR	ERROR	26	An SQL error was encountered during a SELECT statement query.
RC_INVALIDUSE	ERROR	27	The command failed because the command is used in an invalid manner.
RC_NOTABLE	ERROR	28	The command failed because of an unknown SQL table name.
RC_FS_NOTCAP	ERROR	29	The command failed because of incompatible file space name types.
RC_INVALIDADDR	ERROR	30	The command failed because of an incorrect high-level address or low-level address.
RC_INVALIDCG	ERROR	31	The command failed because the management class does not have an archive copy group.
RC_OVERSIZE_VOL	ERROR	32	The command failed because the volume size exceeds the maximum allowed.

Return code	Severity	Numeric value	Description
RC_DEFVOL_FAIL	ERROR	33	The command failed because volumes cannot be defined in RECLAMATIONTYPE=SNAPLOCK storage pools.
RC_DELVOL_FAIL	ERROR	34	The command failed because volumes cannot be deleted in RECLAMATIONTYPE=SNAPLOCK storage pools.
RC_CANCELED	WARNING	35	The command is canceled.
RC_INVPOLICY	ERROR	36	The command failed because there is an invalid definition in the policy domain.
RC_INVALIDPW	ERROR	37	The command failed because of an invalid password.
RC_UNSUPP_PARM	WARNING	38	The command failed because the command or the parameter is not supported.

**Related reference:**

DEFINE SCRIPT (Define an IBM Spectrum Protect script)  
 UPDATE SCRIPT (Update an IBM Spectrum Protect script)  
 RUN (Run an IBM Spectrum Protect script)

## Server documentation in PDF files

Prebuilt PDF files for IBM Spectrum Protect™ documentation are available for you to download.

Tip: Beginning with V7.1.3, the *Administrator's User Guide* is obsolete. Use the solution guides to implement and manage a single-site disk solution and a multisite disk solution. Procedures for completing system administration tasks are available in the following topics:

- Configuring and managing the storage environment
- IBM Spectrum Protect data protection solutions

To complete the following tasks, see the PDF files in the following links.

Task	Components	Links
Learning about product concepts and solutions	<ul style="list-style-type: none"> <li>• Server</li> <li>• Operations Center</li> </ul>	Introduction to Data Protection Solutions
Deploying a best practice solution	<ul style="list-style-type: none"> <li>• Server</li> <li>• Operations Center</li> </ul>	<ul style="list-style-type: none"> <li>• Single-Site Disk Solution Guide</li> <li>• Multisite Disk Solution Guide</li> <li>• Tape Solution Guide</li> </ul>
Installing components	<ul style="list-style-type: none"> <li>• Server</li> <li>• Operations Center</li> </ul>	<ul style="list-style-type: none"> <li>• AIX®</li> <li>• Linux</li> <li>• Windows</li> </ul>
Upgrading components	<ul style="list-style-type: none"> <li>• Server</li> </ul>	<ul style="list-style-type: none"> <li>• AIX</li> <li>• Linux</li> <li>• Windows</li> </ul>
Using commands and options	<ul style="list-style-type: none"> <li>• Server</li> </ul>	<ul style="list-style-type: none"> <li>• AIX</li> <li>• Linux</li> <li>• Windows</li> </ul>
Using messages and error codes	<ul style="list-style-type: none"> <li>• Server</li> </ul>	All operating systems

## IBM Spectrum Protect backup-archive clients

---

To save copies of files and directories on workstations and file servers, use the IBM Spectrum Protect™ backup-archive client to store the data to the IBM Spectrum Protect server. You can recover those copies if the originals are ever damaged or lost. Depending on your reasons for saving data, you can either back up or archive the data.

- **What's new for IBM Spectrum Protect backup-archive clients**  
Read about new and changed features. Review the release notes before installing the product.
- **Protection for workstations and file servers**  
IBM Spectrum Protect is a client/server licensed product that provides storage management services in a multiplatform computer environment.
- **Installing the IBM Spectrum Protect backup-archive clients (UNIX, Linux, and Windows)**  
The IBM Spectrum Protect backup-archive client helps you protect information on your workstations.
- **Configuring backup-archive clients**  
You can configure the backup-archive client to use many of the available client features. Information for configuring the backup-archive client is provided.
- **Back up and restore data with backup-archive clients**  
If you want to save a copy of a file from your computer to the IBM Spectrum Protect server, use the *backup* function. If the original file is ever damaged or lost, you can *restore* the backup version from the server.
- **Archive and retrieve data with backup-archive clients**  
If you want to save a copy of a file to long-term storage on the IBM Spectrum Protect server for archival purposes, use the *archive* function.
- **Schedule operations for backup-archive clients**  
You can schedule backup operations that protect client data to ensure that the operations run on a regular basis.
- **Storage management policies**  
Storage management policies are rules your administrator defines in order to manage your backups and archives on the server.
- **Backup-archive client options and commands**  
Use the client options to tailor backup-archive client processing to meet your needs. Use the client command-line interface (CLI) as an alternative to the graphical user interface (GUI). Reference information for the client options, commands, and other supplemental information is provided.
- ANS 0000-9999 messages

### Related tasks:

Developing solutions with the application programming interface

### Related reference:

PDF files for printing

## What's new for IBM Spectrum Protect backup-archive clients

---

Read about new and changed features. Review the release notes before installing the product.

- **Backup-archive client updates**  
Learn about new features and updates for the backup-archive client in IBM Spectrum Protect Version 8.1.
- **Release notes for IBM Spectrum Protect Backup-Archive Client Version 8.1**  
IBM Spectrum Protect Backup-Archive Client V8.1 is available. Read this document to find important installation information. You can also learn about product updates, compatibility issues, limitations, and known problems.
- **Readme files for IBM Spectrum Protect Version 8.1 backup-archive client fix packs**  
Readme files for the IBM Spectrum Protect V8.1 backup-archive client fix packs are available in the Support knowledge base when there is a fix pack update.
- **Late-breaking documentation updates**  
Updates to the IBM Spectrum Protect backup-archive client documentation can occur after the documentation is published in IBM® Knowledge Center.

## Backup-archive client updates

---

Learn about new features and updates for the backup-archive client in IBM Spectrum Protect™ Version 8.1.

Release	New features and updates
8.1.2	Protect your client with enhanced security settings

Release	New features and updates
	<p>Beginning in IBM Spectrum Protect Version 8.1.2, several changes are introduced in the backup-archive client to work with the IBM Spectrum Protect V8.1.2 server, which provides enhancements to improve the security between client and server communications.</p> <p>After the IBM Spectrum Protect server is upgraded to V8.1.2 and configured with the improved security protocol, and the backup-archive client is upgraded to V8.1.2, the security settings for the client must be configured to work with the security enhancements on the server. For more information about the configuring the client for different security scenarios, see <a href="#">Configuring the client security settings to connect to the IBM Spectrum Protect server version 8.1.2 and later</a>.</p> <p>The following changes are available in this release:</p> <p><b>New sslacceptcertfromserv option, changes to three existing SSL-related options</b></p> <p>To simplify the process of distributing server certificates, IBM Spectrum Protect now includes a new sslacceptcertfromserv option to control whether the backup-archive client or the API application accepts and trusts the IBM Spectrum Protect server's Secure Sockets Layer (SSL) public certificate the first time they connect.</p> <p>In addition, three SSL-related options ssl, ssldisablelegacytls, and sslrequired have changed. Their operation varies depending on whether operation is with IBM Spectrum Protect server V8.1.2 or with IBM Spectrum Protect server V8.1.1 and earlier V8 levels, and V7.1.7 and earlier levels.</p> <p>For a description of these option settings and important version information, see <a href="#">Sslacceptcertfromserv, Ssl, Ssldisablelegacytls, and Sslrequired</a>.</p> <p><b>The IBM Spectrum Protect password location is changed</b></p> <p>Beginning in V8.1.2, the IBM® Global Security Kit (GSKit) keystores are used to store all IBM Spectrum Protect passwords. When you upgrade to IBM Spectrum Protect V8.1.2 backup-archive client, the existing passwords are automatically migrated to new locations on the client system.</p> <p>For more information about the new password location and related considerations, see <a href="#">Secure password storage</a>.</p> <p>A new way of importing server certificates is available with the dsmscert utility. For information about importing server certificates, see <a href="#">Configuring IBM Spectrum Protect client/server communication with Secure Sockets Layer</a>.</p> <p>Because of the use of the new secure password storage, new procedures for granting password access to non-administrative users are available.</p> <p><b>AIX   Linux   Mac OS X   Solaris</b> For UNIX and Linux clients, see <a href="#">Enable non-root users to manage their own data</a>.</p> <p><b>Windows</b> For Windows clients, see <a href="#">Backup-archive client operations and security rights</a>.</p> <p><b>Automatically deploy backup-archive client updates</b></p> <p>The IBM Spectrum Protect server administrator can use server commands to schedule updates for one or more backup-archive clients. The updates can be fix packs or new releases. This feature was available in previous releases of IBM Spectrum Protect, but an improved procedure is available for V8.1.2. For more information, see <a href="#">Schedule automatic updates for backup-archive clients</a>.</p> <p><b>Deprecated functions</b></p> <p>The following functions are deprecated in this release:</p> <p><b>lanfreessl and replsslport options</b></p> <p>Two SSL-related options, lanfreessl and replsslport, are deprecated and unavailable if you are connecting to an IBM Spectrum Protect server V8.1.2 and later. These options are still valid and available if you are connecting to an IBM Spectrum Protect server V8.1.1 and earlier V8 levels, and V7.1.7 and earlier levels.</p> <p><b>AIX   Linux   Mac OS X   Solaris</b> Trusted communications agent (TCA)</p> <p><b>AIX   Linux   Mac OS X   Solaris</b> The trusted communications agent (TCA), previously used by non-root users in V8.1.0 and V7.1.6 and older clients, is no longer available. Root users can use other methods to allow non-root users to manage their files. For more information, see:</p>

Release	New features and updates
	<ul style="list-style-type: none"> <li>• The trusted communications agent is no longer available</li> <li>• Enable non-root users to manage their own data</li> </ul> <p>IBM Spectrum Protect web client</p> <p>You can no longer use the web client to connect to the IBM Spectrum Protect V8.1.2 or later server. However, you can still use the web client to connect to IBM Spectrum Protect V8.1.1, V8.1.0, or V7.1.7 or earlier servers. For more information, see Using the web client in the new security environment.</p> <p><b>AIX</b>   <b>Solaris</b>   <b>Windows</b> NDMP command-line and web client operations</p> <p><b>AIX</b>   <b>Solaris</b>   <b>Windows</b> If you are connecting to IBM Spectrum Protect server V8.1.2 or later, you can no longer use the client command-line interface or web client to back up or restore NAS file servers using Network Data Management Protocol (NDMP). Alternatively, you can use IBM Spectrum Protect server commands with the administrative command-line client (dsmadm) to restore NDMP data. For more information, see the NDMP information in Using the web client in the new security environment.</p> <p>Open registration</p> <p>If the client is connecting to IBM Spectrum Protect server V8.1.2 or later, the open registration feature is no longer available. To connect to the IBM Spectrum Protect server, you must use closed registration. For more information, see Closed registration.</p> <p>Open registration is still available if the client is connecting to IBM Spectrum Protect V8.1.1, V8.1.0, or V7.1.7 and earlier servers.</p> <p>For more information about security improvements on the server, see Protect your storage environment with an improved security protocol.</p> <p><b>Windows</b> Enhanced support for Data Protection for Microsoft Hyper-V running on Windows Server 2016</p> <p><b>Windows</b></p> <p>Back up virtual machines by using resilient change tracking (RCT)</p> <p>To improve the scalability and performance of virtual machine (VM) backups, resilient change tracking (RCT) is used for all VM backup operations of Hyper-V hosts that run on the Microsoft Windows Server 2016 operating system.</p> <p>For more information, see Virtual machine backups with resilient change tracking (RCT).</p> <p><b>Windows</b></p> <p>Exercise more control over backup operations on VMs with physical disks</p> <p>You can control whether full Hyper-V RCT VM backups are processed if the VM has one or more physical disks (pass-through disks) provisioned.</p> <p>For more information, see the following options:</p> <ul style="list-style-type: none"> <li>• Vmprocessvmwithphysdisks</li> <li>• Vmskipphysdisks</li> </ul> <p>Specify the number of snapshot attempts and the level of data consistency for backup operations</p> <p>To determine the total number of snapshot attempts to try for a virtual machine that fails during backup processing due to snapshot failure, use the INCLUDE.VMSNAPSHOTATTEMPTS option. You can choose to attempt application-consistent or crash-consistent snapshots.</p> <p>For more information, see INCLUDE.VMSNAPSHOTATTEMPTS.</p> <p>Exclude VM disks from or include VM disks in backup operations</p> <p>You can use the exclude.vmdisk option to exclude a VM disk (VHDX) from VM backup operations or use the include.vmdisk option to include a VM disk in VM backup operations.</p> <p>For more information, see the following topics:</p> <ul style="list-style-type: none"> <li>• Exclude.vmdisk</li> <li>• Include.vmdisk</li> <li>• Domain.vmfull</li> <li>• Backup VM</li> </ul>

Release	New features and updates
	<p data-bbox="354 142 1507 201"><b>Windows</b> Enhanced support for Data Protection for Microsoft Hyper-V running on Windows Server 2012 and 2012 R2</p> <p data-bbox="422 205 527 226"><b>Windows</b></p> <p data-bbox="422 256 1468 373">Scalability and reliability of VM backups are improved VMs are logically grouped into a single snapshot to reduce or eliminate snapshot conflicts at the Hyper-V host level. Improved snapshot retry processing simplifies scheduling and improves reliability across cluster nodes.</p> <ul data-bbox="532 403 1481 520" style="list-style-type: none"> <li>• To control the number of VMs to include in a snapshot, use the <code>vmmaxpersnapshot</code> option. For more information, see <code>Vmmaxpersnapshot</code>.</li> <li>• To control how many snapshot retries are attempted, use the <code>vmmaxsnapshotretry</code> option. For more information, see <code>Vmmaxsnapshotretry</code>.</li> </ul> <p data-bbox="490 546 1481 604">Use these grouping and retry improvements along with the <code>vmmaxparallel</code> option to help improve performance.</p> <p data-bbox="490 630 1507 659">For information, see <a href="#">Tuning scheduled VM backups for Windows Server 2012 and 2012 R2 clusters</a>.</p> <p data-bbox="354 684 993 714"><b>Linux</b>   <b>Windows</b> Enhanced Virtual Volumes (VVOL) support</p> <p data-bbox="422 718 1500 802"><b>Linux</b>   <b>Windows</b> VVOL support is enhanced to include support for persisted snapshots on the hardware storage and application protection. For more information about new VVOL support features, see <a href="#">IBM Spectrum Protect for Virtual Environments: Data Protection for VMware updates</a>.</p> <p data-bbox="422 827 1364 856">To use enhanced VVOL features, use the options that are described in the following sections:</p> <p data-bbox="422 882 1490 999">Specify the location for virtual machine backup and restore operations: local, server, or both For virtual machines that are hosted on VVOL datastores, you can now specify one of the following backup locations for backup and restore operations: local, server, or both. A local backup is a persisted snapshot on the hardware storage.</p> <p data-bbox="490 1003 1338 1062">To specify the backup location for the Backup VM or Restore VM command, use the <code>vmbackuplocation</code> option. For more information, see <code>Vmbackuplocation</code>.</p> <p data-bbox="490 1066 1406 1125">You can also specify the backup location or locations to query when you run the Query VM command. For more information, see <code>Query VM</code>.</p> <p data-bbox="490 1129 1468 1188">The Local Backup Management (IBM Spectrum Protect) tags are available for local backups. For more information, see <a href="#">Supported data protection tags</a>.</p> <p data-bbox="422 1213 672 1243">Create a schedule group</p> <p data-bbox="490 1247 1507 1390">You can use the <code>schedgroup</code> option to create a group that contains multiple schedules. You can then use the IBM Spectrum Protect vSphere Client plug-in to assign the schedule group to an object in the VMware vSphere Web client rather than an individual schedule. An example of the use of this option is to group multiple daily local backup schedules with a single IBM Spectrum Protect server backup schedule.</p> <p data-bbox="490 1394 889 1423">For more information, see <code>Schedgroup</code>.</p> <p data-bbox="354 1449 1023 1478"><b>Linux</b>   <b>Windows</b> Restore multiple virtual disks simultaneously</p> <p data-bbox="422 1482 1383 1566"><b>Linux</b>   <b>Windows</b> You can use the IBM Spectrum Protect client restore multiple virtual disks simultaneously on the Microsoft Windows and Linux operating systems by using the <code>vmmaxrestoreparalleldisks</code> option.</p> <p data-bbox="422 1591 1256 1621">For instructions about setting the option settings, see <code>Vmmaxrestoreparalleldisks</code>.</p> <p data-bbox="354 1646 1494 1675"><b>Linux</b>   <b>Windows</b> The <code>snapdiffchangelogdir</code> client option is added for snapshot differential backup operations</p> <p data-bbox="422 1680 1487 1764"><b>Linux</b>   <b>Windows</b> Snapshot differential backups no longer use the <code>stagingdirectory</code> option for storing snapshot differential change log files. Beginning with V8.1.2, use the new <code>snapdiffchangelogdir</code> option to specify the location where the client stores persistent change logs for snapshot differential backups.</p> <p data-bbox="422 1789 1425 1848">For a description of the option settings and important information about migrating from prior client versions, see <code>Snapdiffchangelogdir</code>.</p> <p data-bbox="354 1873 766 1902"><b>Mac OS X</b> Support for Apple File System</p> <p data-bbox="422 1906 1500 1965"><b>Mac OS X</b> The Apple File System (APFS) is supported for backup, archive, restore, and retrieve operations. The Case Sensitive version and sparse files are not supported.</p>



8.1.0 Release	<p>IBM Tivoli® Storage Manager is now IBM Spectrum Protect</p> <p><b>New features and updates</b></p> <p>IBM Spectrum Protect Version 8.1 is the next generation of Tivoli Storage Manager. This new release represents more than a name change in the user interface and documentation. It is an evolution to a higher level of data protection that is designed to meet the complex demands of today's world.</p> <p>For more information, see Meet IBM Spectrum Protect.</p> <p>An administrative user ID is no longer created by default with the REGISTER NODE server command</p> <p>Beginning with IBM Spectrum Protect V8.1, the REGISTER NODE server command does not automatically create an administrative user ID that matches the node name. This product update is designed to optimize user authentication to a Lightweight Directory Access Protocol (LDAP) server.</p> <p>This product update does not affect existing client nodes, but can affect the process of registering new client nodes, including but not limited to nodes for IBM Spectrum Protect backup-archive clients. In some cases, you might have to create an administrative user ID when you register a node. You can create the administrative user ID by issuing the REGISTER NODE command and specifying the USERID parameter. For information about the types of clients that are affected, see technote 7048963.</p> <p>If you plan to use the web client, you must manually create an administrative user ID when you register a new node. For more information, see Register your workstation with a server.</p> <p>Run the web client independently of the web browser</p> <p>Instead of running the IBM Spectrum Protect web client as a Java™ Applet, the web client is delivered as a Java Web Start application, which can be started and managed independently of the web browser.</p> <p>For more information about starting the web client, see Starting a web client session.</p> <p><b>Linux</b>   <b>Windows</b> Backup management enhancements, including new data protection tags, are available for tagging support</p> <p><b>Linux</b>   <b>Windows</b></p> <p>New data protection tags are available for tagging support</p> <p>New data protection tags are added to help you manage virtual machine backup operations with the IBM Spectrum Protect vSphere Client plug-in in the VMware vSphere Web Client. In addition to using tags to exclude virtual machines from scheduled backup operations and assign retention or management classes, introduced in V7.1.6, you can assign the new tags to vSphere inventory objects to do the following tasks:</p> <ul style="list-style-type: none"> <li>• Include virtual machines in scheduled backup operations</li> <li>• Assign a data mover to a virtual machine</li> <li>• Specify a list of virtual disks to back up</li> <li>• Assign a backup schedule to virtual machines in a container</li> <li>• Specify the data consistency to achieve for snapshot attempts during virtual machine backup operations</li> <li>• Provide application protection to virtual machines that run Microsoft SQL Server or Microsoft Exchange Server software</li> </ul> <p>For more information, see Supported data protection tags.</p> <p>Set a default data mover for tagging</p> <p>You can set a default data mover for protecting virtual machines in vSphere inventory objects that are tagged with data protection tags. New virtual machines that are added to the tagged container and are protected by a schedule but do not have a data mover tag are backed up by the default data mover.</p> <p>For more information, see Vmtagdefaultdatamover.</p> <p>Data protection tags can be inherited from higher-level vSphere inventory objects</p> <p>You can use tag inheritance to manage data protection for virtual machines in your vSphere inventory.</p> <p>For more information, see Inheritance of data protection settings.</p> <p>Virtual machines can be added to a backup schedule by using the IBM Spectrum Protect vSphere Client plug-in</p>
------------------	--

Release	New features and updates
	<p>You can select a backup schedule for virtual machines from the IBM Spectrum Protect vSphere Client plug-in in the VMware vSphere Web Client. The backup schedule specifies how often and when to automatically back up the virtual machines in a vSphere inventory object.</p> <p>For more information, see <a href="#">Selecting a schedule for backing up virtual machines</a>.</p> <p>You can also view and manage backup schedules from the IBM Spectrum Protect vSphere Client plug-in. For more information, see <a href="#">Managing backup schedules in the vCenter</a>.</p> <p><b>Linux</b>   <b>Windows</b> Snapshot differential backup is no longer supported on AIX®</p> <p><b>Linux</b>   <b>Windows</b> You can no longer run snapshot differential backups of NetApp filer volumes on the backup-archive client on the IBM AIX operating system. You can run snapshot differential backups only on Linux and Microsoft Windows clients.</p> <p><b>Discontinued functions</b></p> <p>The following functions are discontinued in this release:</p> <p><b>Linux</b>   <b>Windows</b> Virtual machine operations on the backup-archive client</p> <p><b>Linux</b>   <b>Windows</b> Virtual machine operations are available only if you are using the client as a data mover for the IBM Spectrum Protect for Virtual Environments products (Data Protection for VMware or Data Protection for Microsoft Hyper-V).</p> <p>You can no longer run virtual machine operations without installing IBM Spectrum Protect for Virtual Environments.</p> <p><b>Linux</b>   <b>Windows</b> VMware vStorage API is no longer part of the client installation</p> <p><b>Linux</b>   <b>Windows</b> The VMware vStorage API runtime files component that is used for VMware operations is no longer part of the backup-archive client installation. It is installed as part of the Data Protection for VMware installation package.</p> <p><b>Linux</b>   <b>Windows</b> Virtual machine operations that are discontinued for the data mover</p> <p><b>Linux</b>   <b>Windows</b></p> <p><b>File-level virtual machine backups</b></p> <p>You can no longer run file-level VMware virtual machine backups on the data mover. Instead, use incremental-forever full or incremental-forever incremental backup operations.</p> <p><b>Periodic full backups and incremental backups</b></p> <p>You can no longer run periodic full backups and incremental backups of virtual machines on the data mover. Instead, use incremental-forever full or incremental-forever incremental backup operations.</p> <p><b>VMware vCloud Director support</b></p> <p>You can no longer back up or restore vCloud vApps with the data mover. To back up or restore vApps, you must use Data Protection for VMware V7.1.</p> <p><b>Windows</b> Online system state restores</p> <p><b>Windows</b> You can no longer restore the system state on a system that is online. Instead, use the Automated System Recovery (ASR) based recovery method to restore the system state in offline Windows Preinstallation Environment (PE) mode.</p> <p>For more information, see:</p> <ul style="list-style-type: none"> <li>• Restoring the Windows operating system with Automated System Recovery</li> <li>• Restore Systemstate</li> </ul> <p><b>Windows</b> Adaptive subfile backup</p> <p><b>Windows</b> Adaptive subfile backup operations are discontinued, but you can still restore existing subfile backup data.</p> <p><b>Data Encryption Standard (DES) 56-bit data encryption</b></p> <p>For increased security, use Advanced Encryption Standard (AES) 128-bit or AES 256-bit data encryption for backup and archive operations.</p> <p>For more information, see <a href="#">Encryptiontype</a>.</p> <p><b>Windows</b> GPFS™ support for the Windows client</p> <p><b>Windows</b> The Windows backup-archive client can no longer back up or restore files in a Windows only GPFS cluster. However, you can still use the AIX or Linux backup-archive client to protect data in GPFS clusters that contain mixed nodes, which can include AIX, Linux, and Windows.</p>

Release	New features and updates
	<p data-bbox="423 144 837 172">Data Protection for IBM Domino® plug-in</p> <p data-bbox="492 176 1498 291">The Data Protection for IBM Domino plug-in is stabilized at V7.1.0 and is no longer supported by the backup-archive client. If the Data Protection for IBM Domino plug-in is installed and configured on the same server as the IBM Domino Server and the V8.1 backup-archive client, you can no longer back up and restore IBM Domino databases and transaction log files with the web client.</p> <p data-bbox="423 298 781 325">The guitreeviewafterbackup option</p> <p data-bbox="492 329 1482 417">The guitreeviewafterbackup option is no longer supported in this release and is removed from the Preferences Editor. If this option is present in the client options file when you run the client, the option is ignored and no client error messages are displayed.</p> <p data-bbox="354 443 854 470">Discontinued support of client operating systems</p> <p data-bbox="423 474 1498 531">To take advantage of new product features, install the V8.1 backup-archive client on one of the supported operating systems. For the current list of supported operating systems, see technote 1243309.</p> <p data-bbox="423 558 1304 585">The following operating systems are no longer supported by the backup-archive client:</p> <ul data-bbox="464 611 1498 852" style="list-style-type: none"> <li>• Windows 32-bit operating systems (client and API).</li> <li>• Windows Server 2008, Windows Server 2008 R2, Windows 7, and Windows 8 operating systems.</li> <li>• HP-UX operating systems. You can still use the IBM Spectrum Protect API on an HP-UX operating system.</li> <li>• Linux on Power Systems™ (big endian). You can still use the IBM Spectrum Protect API on Linux on Power Systems (big endian).</li> <li>• Solaris SPARC operating systems. You can still use the IBM Spectrum Protect API on Solaris SPARC operating systems.</li> </ul>

**Related information:**

Protection for workstations and file servers

## Release notes for IBM Spectrum Protect Backup-Archive Client Version 8.1

IBM Spectrum Protect™ Backup-Archive Client V8.1 is available. Read this document to find important installation information. You can also learn about product updates, compatibility issues, limitations, and known problems.

### Contents

- Description
- Announcement
- Compatibility with earlier versions
- System requirements
- Installing the backup-archive client
- Updates, limitations, and known problems

### Description

IBM Spectrum Protect is a client/server licensed product that provides storage management services in a multiplatform computer environment. You can use the backup-archive client to back up and archive files from workstations or file servers to storage, and restore and retrieve backup versions and archive copies of files to local workstations.

For a list of the APARs that are fixed in this release, see technote 1993247.

### Announcement

The announcement for the IBM Spectrum Protect V8.1 family of products includes the following information:

- Detailed product description, including a description of new functions
- Product-positioning statement
- Packaging and ordering details
- International compatibility information

To search for the product announcement, complete the following steps:

1. Go to the product announcement website.
2. In the Search for field, enter the product identifier (PID) for your product. The PID for IBM Spectrum Protect is 5725-W98.
3. In the Information Type field, select Announcement letters, and click Search.
4. From the Search in list, select Product Number.
5. Optional: In the Refine Your Search pane on the left side of the window, select the country where you reside.
6. In the Sort by section, select Newest first.

## Compatibility with earlier versions

---

For compatibility with earlier versions, see IBM Spectrum Protect Server/Client Compatibility and Upgrade Considerations.

## System requirements

---

For information about hardware and software compatibility, see the detailed system requirements document at the following websites:

Apple Macintosh client requirements

Technote 1053584

IBM® AIX® client requirements

Technote 1052226

Linux on Power® Systems client requirements

Technote 1169963

Linux x86\_64 client requirements

Technote 1052223

Linux on z Systems™ client requirements

Technote 1066436

Microsoft Windows client requirements

Technote 1197133

Oracle Solaris x86\_64 client requirements

Technote 1232956

## Installing the backup-archive client

---

If you download the product from IBM Passport Advantage®, follow the directions in the download document at technote 4042940.

For installation instructions, see Installing the IBM Spectrum Protect backup-archive clients (UNIX, Linux, and Windows).

## Updates, limitations, and known problems

---

Documentation updates, limitations, and known problems are documented as technotes in the Support knowledge base at the IBM Support Portal for IBM Spectrum Protect. As problems are discovered and resolved, IBM Software Support updates the knowledge base. By searching the knowledge base, you can find workarounds or solutions to problems.

Limitations and known problems

At the time of publication, the limitations and known problems are documented in the following technotes:

- For AIX, Linux, Mac OS X, and Oracle Solaris operating systems, see technote 1993251.
- For Windows operating systems, see technote 1993250.

Documentation updates

For information that was not available at the time of publication, documentation updates are available in the following tech docs:

- For AIX, Linux, Mac OS X, and Oracle Solaris operating systems, see technote 7048955.
- For Windows operating systems, see technote 7048956.

## Readme files for IBM Spectrum Protect Version 8.1 backup-archive client fix packs

---

Readme files for the IBM Spectrum Protect™ V8.1 backup-archive client fix packs are available in the Support knowledge base when there is a fix pack update.

View IBM Spectrum Protect V8.1 backup-archive client fix pack readme files

## Late-breaking documentation updates

---

Updates to the IBM Spectrum Protect™ backup-archive client documentation can occur after the documentation is published in IBM® Knowledge Center.

Late-breaking documentation updates are available in the following documents in the IBM Support Portal:

- For AIX®, Linux, Mac OS X, and Oracle Solaris clients, see technote 7048955.
- For Windows clients, see technote 7048956.

## Protection for workstations and file servers

---

IBM Spectrum Protect™ is a client/server licensed product that provides storage management services in a multiplatform computer environment.

The backup-archive client program enables users to back up and archive files from their workstations or file servers to storage, and restore and retrieve backup versions and archived copies of files to their local workstations.

In addition to the backup-archive client, IBM Spectrum Protect includes the following components:

- A server program that acts as a backup and archive server for distributed workstations and file servers.

**AIX** **Linux** **Solaris** The server program also supplies hierarchical storage management (HSM) services, and enables systems to perform as a migration server.

- An administrative client program that you can access from a web browser or from the command line. The program enables the IBM Spectrum Protect administrator to control and monitor server activities, define storage management policies for backup, archive, and space management services, and set up schedules to perform those services at regular intervals.
- An application programming interface (API) that you can use to enhance an existing application with storage management services. When an application is registered with a server as a client node, the application can back up, restore, archive, and retrieve objects from storage.
- A web backup-archive client that enables an authorized administrator, help desk person, or other users to perform backup, restore, archive, and retrieve services by using a web browser on a remote system.

**AIX** **Linux** **Solaris** Associated with IBM Spectrum Protect, but sold separately, are the IBM Spectrum Protect for Space Management and IBM Spectrum Protect HSM for Windows client programs. These products automatically migrate eligible files to storage to maintain specific levels of free space on local file systems and automatically recall migrated files when they are accessed. It also enables users to migrate and recall specific files.

**AIX** **Linux** **Solaris** The terms *hierarchical storage management* and *space management* have the same meaning throughout this publication.

### Related concepts:

**AIX** **Linux** **Mac OS X** **Solaris** [Planning your backups](#)

**Windows** [Planning your backups \(Windows\)](#)

[Backup-archive client updates](#)

[Installing the IBM Spectrum Protect backup-archive clients \(UNIX, Linux, and Windows\)](#)

### Related tasks:

[Configuring backup-archive clients](#)

[Back up and restore data with backup-archive clients](#)

[Archive and retrieve data with backup-archive clients](#)

**AIX** **Mac OS X** **Linux** **Solaris** **Windows**

## Installing the IBM Spectrum Protect backup-archive clients (UNIX, Linux, and Windows)

---

The IBM Spectrum Protect™ backup-archive client helps you protect information on your workstations.

You can maintain backup versions of your files that you can restore if the original files are damaged or lost. You can also archive infrequently used files, preserve them in their current state, and retrieve them when necessary.

The backup-archive client works in conjunction with the IBM Spectrum Protect server. Contact your IBM Spectrum Protect server administrator to obtain backup or archive access to the server, or refer to the server publications to install and configure the IBM Spectrum Protect server.

- **Upgrading the backup-archive client**  
The following sections explain what you need to do if you are upgrading to IBM Spectrum Protect backup-archive client Version 8.1.2 from a previous version.
- **Client environment requirements**  
Each of the IBM Spectrum Protect clients has hardware and software requirements.
- **AIX** | **Solaris** | **Windows** **NDMP support requirements (Extended Edition only)**  
You can use the Network Data Management Protocol (NDMP) to back up and restore network attached storage (NAS) file systems to tape drives or libraries that are locally attached to Network Appliance and EMC Celerra NAS file servers.
- **Linux** | **Windows** **Installation requirements for backing up and archiving Tivoli Storage Manager FastBack client data**  
Before you can back up or archive your FastBack client data, you must install the required software.
- **Windows** **Client configuration wizard for Tivoli Storage Manager FastBack**  
The backup-archive client provides a wizard to configure the backup-archive client for Tivoli® Storage Manager FastBack.
- **AIX** | **Linux** | **Solaris** | **Mac OS X** **Install the UNIX and Linux backup-archive clients**  
This section provides instructions to install and set up IBM Spectrum Protect UNIX and Linux clients.
- **Windows** **Windows backup-archive client installation overview**  
You can install the IBM Spectrum Protect Windows backup-archive client from the installation media.
- **Linux** | **Windows** **Installing the client management service to collect diagnostic information**  
You can install IBM Spectrum Protect client management services to collect diagnostic information about the backup-archive client. The client management service makes the information available to the IBM Spectrum Protect Operations Center for basic monitoring capability.

#### **Related concepts:**

Backup-archive client updates

**AIX** | **Linux** | **Mac OS X** | **Solaris** **Planning your backups**

**Windows** **Planning your backups (Windows)**

#### **Related tasks:**

Configuring backup-archive clients

Back up and restore data with backup-archive clients

Archive and retrieve data with backup-archive clients

## **Upgrading the backup-archive client**

---

The following sections explain what you need to do if you are upgrading to IBM Spectrum Protect™ backup-archive client Version 8.1.2 from a previous version.

- **Upgrade path for clients and servers**  
IBM Spectrum Protect clients and servers can be upgraded at different times. The combination of servers and clients that you deploy must be compatible with each other.
- **Additional upgrade information**  
When you upgrade the backup-archive client, there is additional information to consider before you use the new client software.
- **Automatic backup-archive client deployment**  
The IBM Spectrum Protect server administrator can automatically deploy a backup-archive client to update workstations where the backup-archive client is already installed.

## **Upgrade path for clients and servers**

---

IBM Spectrum Protect™ clients and servers can be upgraded at different times. The combination of servers and clients that you deploy must be compatible with each other.

To prevent disruption of your backup and archive activities while you upgrade from one release to another, follow the compatibility guidelines for IBM Spectrum Protect clients and servers in technote 1053218.

**AIX** For information about upgrading your current AIX® IBM® PowerHA® SystemMirror® setups, see Migrating legacy AIXIBM PowerHA SystemMirror setups.

## Additional upgrade information

---

When you upgrade the backup-archive client, there is additional information to consider before you use the new client software.

Be aware of the following information when you upgrade a backup-archive client:

- **Linux Solaris** If you are upgrading from the IBM® Tivoli® Storage Manager Version 7.1.2 or earlier backup-archive client on the Oracle Solaris operating system, you must uninstall any previously installed language packages before you proceed with the upgrade.
- **Mac OS X** For Mac users, updates to the Mac OS X client contained in IBM Spectrum Protect™ V6.3, or newer versions, require you to consider the following items:
  - When you use the Mac OS X client that is provided in this release, ensure that the `dsm.sys` and `dsm.opt` files are encoded by using Unicode (UTF-8). UTF-8 encoding enables the use of characters from any language in the options files. If your `dsm.sys` or `dsm.opt` files were previously encoded as MacRoman (or anything other than UTF-8), open them in an editor like TextEdit and save them with UTF-8 encoding, and without the `.txt` extension. Your include-exclude lists can be encoded as either UTF-8 or UTF-16. For more information about using Unicode, see Considerations for Unicode-enabled clients.
  - IBM Spectrum Protect server file spaces that were created by Mac OS 9 clients cannot be managed by the Mac OS X client that was provided in IBM Spectrum Protect V6.3. Use `q file node f=d` on the server to list files stored for a node. Any Mac-platform files that do not start with a slash (/) were probably created by an older Mac client. You cannot restore or otherwise manage these files by using the Mac OS X client that is provided in this release. You can manage these files, but you must use a Mac client that is installed on a version 6.2.2 or older client node.
- **Windows** The size of the buffer to record change notifications for a particular journal file system (`DirNotifyBufferSize`) has changed. The default value is 16 KB.
- For a list of new and changed messages since the previous IBM Spectrum Protect release, see the `client_message.chg` file in the client package.

## Automatic backup-archive client deployment

---

The IBM Spectrum Protect™ server administrator can automatically deploy a backup-archive client to update workstations where the backup-archive client is already installed.

The IBM Spectrum Protect server can be configured to automatically upgrade backup-archive clients on client workstations. The existing backup-archive clients must be at version 6.4.3 or later.

For more information about automatically deploying client upgrades from the server, see the following documents:

- For IBM Spectrum Protect 8.1.2 or later servers, see technote 2004596.
- For IBM® Tivoli® Storage Manager V7.1 servers and IBM Spectrum Protect V8.1.0 and V8.1.1 servers, see technote 1673299.

Restrictions: The following restrictions apply to automatic client deployment:

- The Windows cluster services environment is not supported.
- Only the backup-archive client can be deployed from the IBM Spectrum Protect server. Other related products such as IBM Spectrum Protect for Space Management, IBM Spectrum Protect HSM for Windows, IBM Spectrum Protect for Virtual Environments, and other Data Protection products are not supported. If a deployment of an unsupported product is attempted, the deployment process stops with a failure message.
- Do not schedule automatic client deployments to workstations that already have the IBM Spectrum Protect for ERP application installed on them.

When the server administrator schedules automatic backup-archive client deployments, the updated client packages (which include the client components and the API library) are installed on the workstations that receive them. A dependency check is performed by the client installation program to ensure that the API library does not conflict with the client package that is already installed.

IBM Spectrum Protect for ERP applications do not use the same installation technology that is used by the client installation program. Therefore, the client installation dependency check is not able to detect whether the API library that is being used by the IBM Spectrum Protect for ERP applications is compatible with the API library that will be installed by automatic client deployments. If a client package is automatically deployed to and installed on a workstation, the API library that is installed might not be compatible with the API library that was installed by the IBM Spectrum Protect for ERP application. The newly deployed API library can cause the IBM Spectrum Protect for ERP applications to fail.



## How the autodeploy client option can affect client deployment

---

You can use the autodeploy option to conditionally enable automatic client deployment, if the deployment does not require a restart of the client workstation.

By default, the autodeploy option is enabled, and the client workstation is restarted if required.

To use automatic deployment but not restart the system, specify the autodeploy noreboot option.

To turn off automatic client deployment, add autodeploy no to the client options file.

You can set the autodeploy option in the following places:

- On a schedule definition on the IBM Spectrum Protect server. Schedule definitions that deploy client software updates have an `action=deploy` statement. On those schedules, you can include the autodeploy option as part of the command that you include on the `-postnschedulecmd` statement.
- On the client node, in an options file that is associated with the client scheduler or client acceptor. The deployment manager detects options files that are associated with the scheduler or client acceptor. If multiple scheduler or client acceptor processes are running on the same computer at the same time, and the processes use different options files, the deployment manager uses the autodeploy option value that is set in one of the options files.
- On the client in the client options file (`dsm.opt`). The autodeploy option that is set in the client options file overrides any other autodeploy setting.

### Related reference:

Autodeploy

## Client environment requirements

---

Each of the IBM Spectrum Protect™ clients has hardware and software requirements.

The following list shows the location of the environment prerequisites for each supported platform.

For current information about the client environment prerequisites for all of the supported backup-archive client platforms, see technote 1243309.

- **AIX** AIX client environment  
This section contains client environment information, backup-archive client components, and hardware and software requirements for the AIX® platform.
- HP-UX Itanium 2 API environment  
Review API environment information, installable components, and hardware and software requirements for the HP-UX Itanium 2 platform.
- **Linux** Linux on Power Systems client environment  
This section contains client environment information, backup-archive client components, and hardware and software requirements for the Linux on Power Systems™ client platforms.
- **Linux** Linux x86\_64 client environment  
This section contains client environment information, backup-archive client components, and hardware and software requirements for the Linux on Intel (Linux x86\_64) platform.
- **Linux** Linux on System z client environment  
This section contains client environment information, backup-archive client components, and hardware and software requirements for the Linux on System z® platform.
- **Mac OS X** Mac OS X client environment  
This section contains client environment information, backup-archive client components, and hardware and software requirements for the Mac OS X client.
- **Solaris** Oracle Solaris client environment  
Review client environment information, client components, and hardware and software requirements for the Oracle Solaris platform.
- **Windows** Windows client environment requirements  
This section contains client environment information, backup-archive client components, and hardware and software requirements for the supported Windows platforms.

### Related concepts:

**AIX** **Solaris** **Windows** NDMP support requirements (Extended Edition only)  
**AIX**



## AIX client environment

This section contains client environment information, backup-archive client components, and hardware and software requirements for the AIX® platform.

- **AIX** AIX client installable components  
The backup-archive client is comprised of several installable components.
- **AIX** System requirements for the AIX client  
The IBM Spectrum Protect AIX client requires a minimum amount of hardware, disk space, memory, and software.
- **AIX** AIX client communication methods  
The TCP/IP and shared memory communication methods are available for the AIX backup-archive client.
- **AIX** Backup-archive client features that are available on AIX  
This topic lists the features that are supported on AIX.

AIX

## AIX client installable components

The backup-archive client is comprised of several installable components.

The installable components for the AIX® client are as follows:

- Backup-archive command line client
- Administrative client
- Backup-archive client graphical user interface, which uses Oracle Java™ technology
- Backup-archive web client
- IBM Spectrum Protect™ 64-bit API

The API can be separately installed. The other components are all installed when you install the AIX package (tivoli.tsm.client.api.64bit).

AIX

## System requirements for the AIX client

The IBM Spectrum Protect™ AIX® client requires a minimum amount of hardware, disk space, memory, and software.

For software and hardware requirements for all supported versions of AIX clients, including the most recent fix packs, see technote 1052226.

AIX

## AIX client communication methods

The TCP/IP and shared memory communication methods are available for the AIX® backup-archive client.

You can use the following communication methods with the IBM Spectrum Protect™ Version 8.1.2 AIX client:

Table 1. AIX client communication methods

To use this communication method:	Install this software:	To connect to these IBM Spectrum Protect servers:
TCP/IP	TCP/IP (Standard with supported AIX platforms)	AIX, Linux, Windows
Shared Memory	TCP/IP (Standard with supported AIX platforms)	AIX

AIX

## Backup-archive client features that are available on AIX

This topic lists the features that are supported on AIX®.

Table 1. Supported features on AIX

Features	Supported on AIX?
Backup-archive command-line and GUI	yes
Journal-based backup	yes
LAN-free operations	yes
Online image backup	yes
Offline image backup	yes

## HP-UX Itanium 2 API environment

Review API environment information, installable components, and hardware and software requirements for the HP-UX Itanium 2 platform.

- **HP-UX Itanium 2 API installable component**  
You can install only the HP-UX Itanium 2 API in IBM Spectrum Protect Version 8.1.2.
- **System requirements for the HP-UX Itanium 2 API**  
The IBM Spectrum Protect HP-UX Itanium 2 API requires a minimum amount of hardware, disk space, memory, and software.
- **HP-UX Itanium 2 API communication methods**  
The TCP/IP and shared memory communication methods are available for the HP-UX Itanium 2 API.

## HP-UX Itanium 2 API installable component

You can install only the HP-UX Itanium 2 API in IBM Spectrum Protect™ Version 8.1.2.

## System requirements for the HP-UX Itanium 2 API

The IBM Spectrum Protect™ HP-UX Itanium 2 API requires a minimum amount of hardware, disk space, memory, and software.

For software and hardware requirements for all supported versions of the HP-UX Itanium 2 API, including the most recent fix packs, see technote 1197146.

## HP-UX Itanium 2 API communication methods

The TCP/IP and shared memory communication methods are available for the HP-UX Itanium 2 API.

Table 1. HP-UX Itanium 2 API communication methods

To use this communication method:	Install this software:	To connect to these IBM Spectrum Protect™ servers:
TCP/IP	TCP/IP (Standard with HP-UX)	AIX®, Linux, Windows

Linux

## Linux on Power Systems client environment

This section contains client environment information, backup-archive client components, and hardware and software requirements for the Linux on Power Systems™ client platforms.

- **Linux** Linux on Power Systems client installable components  
The backup-archive client command-line, Java™ GUI, web backup-archive, and API comprise the Linux on Power Systems backup-archive client installable components.
- **Linux** System requirements for clients on Linux on Power Systems  
The IBM Spectrum Protect clients on Linux on Power Systems require a minimum amount of hardware, disk space, memory, and software.
- **Linux** Linux on Power Systems client communication methods  
Backup-archive clients on Linux on Power Systems can use either TCP/IP or shared memory as the communications method for client-server communications.

## Linux on Power Systems client installable components

The backup-archive client command-line, Java™ GUI, web backup-archive, and API comprise the Linux on Power Systems™ backup-archive client installable components.

You can install the following components with IBM Spectrum Protect™ Version 8.1.2:

- Backup-archive client
- Administrative client
- Backup-archive Java graphical user interface (GUI)
- Web backup-archive client
- IBM Spectrum Protect API (64-bit)

## System requirements for clients on Linux on Power Systems

The IBM Spectrum Protect™ Linux on Power Systems™ require a minimum amount of hardware, disk space, memory, and software.

For software and hardware requirements for all supported versions of clients on Linux on Power Systems, including the most recent fix packs, see technote 1169963.

## Linux on Power Systems client communication methods

Backup-archive clients on Linux on Power Systems™ can use either TCP/IP or shared memory as the communications method for client-server communications.

Table 1 lists the available Linux on Power Systems client communications methods, and the IBM Spectrum Protect™ server operating systems that you can use them with.

Table 1. Linux on Power Systems client communication methods

To use this communication method:	Install this software:	To connect to these IBM Spectrum Protect servers:
TCP/IP	TCP/IP (Standard with Linux)	AIX®, Linux, Windows
Shared Memory	TCP/IP (Standard with Linux)	Linux on Power® Systems

## Linux x86\_64 client environment

This section contains client environment information, backup-archive client components, and hardware and software requirements for the Linux on Intel (Linux x86\_64) platform.

- **Linux** Linux x86\_64 client installable components  
The backup-archive client command-line, Java™ GUI, web backup-archive, administrative client, and the API comprise the Linux on Intel (Linux x86\_64) backup-archive client installable components.
- **Linux** System requirements for Linux x86\_64 clients  
The IBM Spectrum Protect Linux x86\_64 clients require a minimum amount of hardware, disk space, memory, and software.
- **Linux** Linux x86\_64 client communication methods  
The TCP/IP and shared memory communication methods are available for the Linux on Intel (Linux x86\_64) backup-archive client.

## Linux x86\_64 client installable components

The backup-archive client command-line, Java™ GUI, web backup-archive, administrative client, and the API comprise the Linux on Intel (Linux x86\_64) backup-archive client installable components.

You can install the following components with IBM Spectrum Protect™ Version 8.1.2:

- Backup-archive client
- Administrative client
- Backup-archive Java graphical user interface (GUI)
- Web backup-archive client
- IBM Spectrum Protect API

Linux

## System requirements for Linux x86\_64 clients

The IBM Spectrum Protect™ Linux x86\_64 clients require a minimum amount of hardware, disk space, memory, and software.

For software and hardware requirements for all supported versions of Linux x86\_64 clients, including the most recent fix packs, see technote 1052223.

Linux

## Linux x86\_64 client communication methods

The TCP/IP and shared memory communication methods are available for the Linux on Intel (Linux x86\_64) backup-archive client.

You can use the following communication methods with the IBM Spectrum Protect™ Version 8.1.2 Linux on Intel (Linux x86\_64) client:

Table 1. Linux on Intel x86\_64 client communication methods

To use this communication method:	Install this software:	To connect to these IBM Spectrum Protect servers:
TCP/IP	TCP/IP (Standard with Linux)	AIX®, Linux, Windows
Shared Memory	TCP/IP (Standard with Linux)	Linux x86_64

Linux

## Linux on System z client environment

This section contains client environment information, backup-archive client components, and hardware and software requirements for the Linux on System z® platform.

- **Linux** Linux on System z client installable components  
The backup-archive client command-line, administrative client, web backup-archive client, and API comprise the Linux on System z backup-archive client installable components.
- **Linux** System requirements for Linux on System z clients  
IBM Spectrum Protect Linux System z clients require a minimum amount of hardware, disk space, memory, and software.
- **Linux** Linux on System z client communication methods  
The TCP/IP and shared memory communication methods are available for the Linux on System z backup-archive client.

Linux

## Linux on System z client installable components

The backup-archive client command-line, administrative client, web backup-archive client, and API comprise the Linux on System z® backup-archive client installable components.

You can install the following components with IBM Spectrum Protect™ Version 8.1.2:

- Backup-archive client
- Administrative client
- Web backup-archive client
- IBM Spectrum Protect API

## System requirements for Linux on System z clients

IBM Spectrum Protect™ Linux System z® clients require a minimum amount of hardware, disk space, memory, and software.

For software and hardware requirements for all supported versions of Linux System z clients, including the most recent fix packs, see technote 1066436.

## Linux on System z client communication methods

The TCP/IP and shared memory communication methods are available for the Linux on System z® backup-archive client.

You can use the following communication methods with the IBM Spectrum Protect™ Version 8.1.2 Linux on System z client:

Table 1. Linux on System z client communication methods

To use this communication method:	Install this software:	To connect to these IBM Spectrum Protect servers:
TCP/IP	TCP/IP (Standard with Linux)	AIX®, Linux, Windows
Shared Memory	TCP/IP (Standard with Linux)	Linux on System z

## Mac OS X client environment

This section contains client environment information, backup-archive client components, and hardware and software requirements for the Mac OS X client.

- Mac OS X** Mac OS X client installable components  
 The backup-archive client command-line, Java™ GUI, web backup-archive, and API comprise the Mac OS X backup-archive client installable components.
- Mac OS X** System requirements for Mac OS X clients  
 The IBM Spectrum Protect Mac OS X clients require a minimum amount of hardware, disk space, memory, and software.
- Mac OS X** Mac OS X client communication methods  
 The TCP/IP communication methods are available for the Mac OS X backup-archive client.

## Mac OS X client installable components

The backup-archive client command-line, Java™ GUI, web backup-archive, and API comprise the Mac OS X backup-archive client installable components.

The following components are installed with IBM Spectrum Protect™ Version 8.1.2:

- Backup-archive client
- Administrative client
- Web backup-archive client
- IBM Spectrum Protect API
- Backup-archive Java graphical user interface (GUI)

Tip: The `dsmj` shell script file for the Java GUI is installed in the following location:

```
/Library/Application Support/tivoli/tsm/client/ba/bin
```

## System requirements for Mac OS X clients

The IBM Spectrum Protect™ Mac OS X clients require a minimum amount of hardware, disk space, memory, and software.

For software and hardware requirements for all supported versions of Mac OS X clients, including the most recent fix packs, see technote 1053584.

Mac OS X

## Mac OS X client communication methods

The TCP/IP communication methods are available for the Mac OS X backup-archive client.

You can use the following communication methods with the IBM Spectrum Protect™ Version 8.1.2 Mac OS X client:

Table 1. Mac OS X client communication methods

To use this communication method:	Install this software:	To connect to these IBM Spectrum Protect servers:
TCP/IP	TCP/IP (standard with Mac OS X)	AIX®, Linux, Windows

Solaris

## Oracle Solaris client environment

Review client environment information, client components, and hardware and software requirements for the Oracle Solaris platform.

Starting in IBM Spectrum Protect™ Version 8.1.0, the Oracle Solaris backup-archive client is available only on the Oracle Solaris x86\_64 platform. The Oracle Solaris API is available on the Oracle Solaris x86\_64 and Oracle Solaris SPARC platforms.

- **Solaris** Oracle Solaris client installable components  
The IBM Spectrum Protect command-line, Java™ GUI, web backup-archive, and API comprise the Solaris backup-archive client installable components.
- **Solaris** System requirements for Oracle Solaris clients  
The IBM Spectrum Protect Oracle Solaris clients require a minimum amount of hardware, disk space, memory, and software.
- **Solaris** Oracle Solaris client communication methods  
The TCP/IP and shared memory communication methods are available for the Oracle Solaris backup-archive client.

Solaris

## Oracle Solaris client installable components

The IBM Spectrum Protect™ command-line, Java™ GUI, web backup-archive, and API comprise the Solaris backup-archive client installable components.

You can install the following client components on Oracle Solaris x86\_64:

- Backup-archive client
- Administrative client
- Backup-archive Java graphical user interface (GUI)
- Web backup-archive client
- IBM Spectrum Protect API

You can install the IBM Spectrum Protect API on Oracle Solaris SPARC.

Solaris

## System requirements for Oracle Solaris clients

The IBM Spectrum Protect™ Oracle Solaris clients require a minimum amount of hardware, disk space, memory, and software.

For software and hardware requirements for all supported versions of IBM Spectrum Protect Oracle Solaris clients, including the most recent fix packs, see the following IBM® support pages:

- For Oracle Solaris x86\_64 client requirements, see technote 1232956.
- For Oracle Solaris SPARC API requirements, see technote 1052211.

Solaris

## Oracle Solaris client communication methods

---

The TCP/IP and shared memory communication methods are available for the Oracle Solaris backup-archive client.

You can use the following communication methods with the Oracle Solaris client:

Table 1. Oracle Solaris client communication methods

To use this communication method:	Install this software:	To connect to these IBM Spectrum Protect™ servers:
TCP/IP	TCP/IP (Standard with Solaris)	AIX®, Linux, Windows

Windows

## Windows client environment requirements

---

This section contains client environment information, backup-archive client components, and hardware and software requirements for the supported Windows platforms.

- **Windows** Windows client installable components  
The backup-archive client is comprised of several installable components.
- **Windows** System requirements for Windows clients  
The backup-archive client on Windows requires a minimum amount of disk space for installation and a supported operating system.
- **Windows** Windows client communication methods  
The TCP/IP and shared memory communication methods are available for the Windows backup-archive client.
- **Windows** Backup-archive client features that are available on Windows platforms  
This topic lists which features are supported or not supported on the various Windows platforms.
- **Windows** Windows supported file systems  
The IBM Spectrum Protect Windows backup-archive client is supported on specific file systems.

Windows

## Windows client installable components

---

The backup-archive client is comprised of several installable components.

The installable components for the Windows backup-archive client are as follows:

- Backup-archive command-line client
- Administrative client
- Backup-archive client graphical user interface, which uses Oracle Java™ technology
- Backup-archive web client
- IBM Spectrum Protect™ API (64-bit)

Windows

## System requirements for Windows clients

---

The backup-archive client on Windows requires a minimum amount of disk space for installation and a supported operating system.

For software and hardware requirements for all supported versions of Windows clients, including the most recent fix packs, see technote 1197133.

Windows

## Windows client communication methods

---

The TCP/IP and shared memory communication methods are available for the Windows backup-archive client.

You can use the following communication methods with the Windows backup-archive client:

Table 1. Windows client communication methods

To use this communication method:	Install this software:	To connect to these IBM Spectrum Protect™ servers:
TCP/IP	TCP/IP (Standard with all supported Windows)	AIX®, Linux, Windows
Named Pipes	Named Pipes (Standard with all supported Windows platforms)	Windows
Shared Memory	TCP/IP (Standard with all supported Windows platforms)	Windows

Windows

## Backup-archive client features that are available on Windows platforms

This topic lists which features are supported or not supported on the various Windows platforms.

Table 1 shows the supported and unsupported features on the various Windows platforms.

Table 1. Supported features on Windows platforms

Features	Windows 10	Windows Server 2012 Windows Server 2012 R2 Windows Server 2016
Journal-based backup	yes	yes
Online image backup	yes	yes
Offline image backup	yes	yes
System state support with Volume Shadowcopy Services (VSS)	yes	yes
LAN-free operations	yes	yes
Automated System Recovery (ASR)	yes	BIOS: yes UEFI: yes
Open File Support (OFS)	yes	yes

Windows

## Windows supported file systems

The IBM Spectrum Protect™ Windows backup-archive client is supported on specific file systems.

The Windows backup-archive client supports the following types of file systems:

- File Allocation Table (FAT and FAT32)
- Microsoft New Technology File System (NTFS)
- Microsoft Resilient File System (ReFS). ReFS was introduced on Windows Server 2012 systems.

AIX

Solaris

Windows

## NDMP support requirements (Extended Edition only)

You can use the Network Data Management Protocol (NDMP) to back up and restore network attached storage (NAS) file systems to tape drives or libraries that are locally attached to Network Appliance and EMC Celerra NAS file servers.

*NDMP support is available only on IBM Spectrum Protect™ Extended Edition.*

NDMP support requires the following hardware and software:

- IBM Spectrum Protect Extended Edition
- Tape drive and tape library. For supported combinations, go to: product information

Linux

Windows



# Installation requirements for backing up and archiving Tivoli Storage Manager FastBack client data

---

Before you can back up or archive your FastBack client data, you must install the required software.

You must install the following software:

- Tivoli® Storage Manager FastBack Version 6.1
- Tivoli Storage Manager client V6.1.3.x (where x is 1 or higher) or V6.2 or later
- Tivoli Storage Manager server V6.1.3 or higher
- Tivoli Storage Manager Administration Center V6.1.3
  - Required only if you want to use integrated Tivoli Storage Manager FastBack - administration.

Starting with V7.1, the Administration Center component is no longer included in Tivoli Storage Manager or IBM Spectrum Protect™ distributions. FastBack users who have an Administration Center from a previous server release, can continue to use it to create and modify FastBack schedules. If you do not already have an Administration Center installed, you can download the previously-released version from <ftp://public.dhe.ibm.com/storage/tivoli-storage-management/maintenance/admincenter/v6r3/>. If you do not already have an Administration Center installed, you must create and modify FastBack schedules on the IBM Spectrum Protect server. For information about creating schedules on the server, see the IBM Spectrum Protect server documentation.

The Tivoli Storage Manager FastBack environment must be running. For information about installing and setting up Tivoli Storage Manager FastBack, see the product information at Tivoli Storage Manager FastBack.

For information about integrating IBM Spectrum Protect and Tivoli Storage Manager FastBack, see Integrating Tivoli Storage Manager FastBack and IBM Spectrum Protect.

You can install the IBM Spectrum Protect client in one of the following ways:

- **Windows** Install the backup-archive client on a workstation where the FastBack server is installed. In this case, the prerequisites are: the FastBack server, the FastBack shell, and the FastBack mount.
- **Linux** Install the backup-archive client on a workstation where the FastBack Disaster Recovery Hub is installed. In this case, the prerequisites are: the FastBack Disaster Recovery Hub setup, and the FastBack shell.
- **Windows** Install the backup-archive client on a workstation where the FastBack Disaster Recovery Hub is installed. In this case, the prerequisites are: the FastBack Disaster Recovery Hub setup, the FastBack shell, and the FastBack mount.
- **Linux** Install backup-archive client on a workstation where neither the FastBack server or the FastBack Disaster Recovery Hub is installed. In this case, the FastBack shell is still required.
- **Windows** Install the backup-archive client on a workstation where neither the FastBack server or the FastBack Disaster Recovery Hub is installed. In this case, ensure that the FastBack shell and the FastBack mount are installed.

## Related concepts:

Configuring the client to back up and archive Tivoli Storage Manager FastBack data

**Windows**

## Client configuration wizard for Tivoli Storage Manager FastBack

---

The backup-archive client provides a wizard to configure the backup-archive client for Tivoli® Storage Manager FastBack.

The wizard is available in a remote application (the web client) and in a local application (the Java™ GUI). The wizard helps you set the options to send FastBack client data to the IBM Spectrum Protect™ server on a scheduled basis.

## Related concepts:

Configuring the backup-archive client to protect FastBack client data

**AIX**

**Linux**

**Solaris**

**Mac OS X**

## Install the UNIX and Linux backup-archive clients

---

This section provides instructions to install and set up IBM Spectrum Protect™ UNIX and Linux clients.

Note: You must log on as the root user to install the backup-archive client on a UNIX or Linux workstation.

The supported UNIX and Linux clients and the location of the installation instructions for each client are listed here.

- **AIX** Installing the AIX client  
You can install the AIX® backup-archive client from the product installation media.
- **AIX** Uninstalling the AIX client  
You can use the following procedures to uninstall the IBM Spectrum Protect AIX backup-archive client.
- Installing the HP-UX Itanium 2 API  
You can install the HP-UX Itanium 2 API from the product installation media.
- Uninstalling the HP-UX Itanium 2 API  
You can use the following procedures to uninstall the IBM Spectrum Protect HP-UX Itanium 2 API.
- **Linux** Installing the backup-archive client on Linux on Power Systems (Little Endian)  
You can install the backup-archive client from the product installation media.
- **Linux** Uninstalling the backup-archive client on Linux on Power Systems (Little Endian)  
You can uninstall the IBM Spectrum Protect client on Linux on Power Systems™ (Little Endian).
- **Linux** Installing the backup-archive client on Ubuntu Linux on Power Systems (Little Endian)  
You can install the backup-archive client from the product installation media.
- **Linux** Uninstalling the client on Ubuntu Linux on Power Systems (Little Endian)  
You can uninstall the IBM Spectrum Protect backup-archive client on Ubuntu Linux on Power Systems (Little Endian).
- **Linux** Installing the API on Linux on Power Systems (Big Endian)  
You can install the IBM Spectrum Protect API from the product installation media.
- **Linux** Uninstalling the API on Linux on Power Systems (Big Endian)  
You can uninstall the IBM Spectrum Protect API on IBM Spectrum Protect Linux on Power Systems (Big Endian).
- **Linux** Installing the Linux x86\_64 client  
You can install the Linux x86\_64 backup-archive client from the product installation media.
- **Linux** Uninstalling the Linux x86\_64 client  
You can use the following procedure to uninstall the IBM Spectrum Protect Linux x86\_64 client.
- **Linux** Installing the Ubuntu Linux x86\_64 client  
You can install the Ubuntu Linux 64-bit backup-archive client from the product installation media.
- **Linux** Uninstalling the Ubuntu Linux x86\_64 client  
Use the following procedure to uninstall the IBM Spectrum Protect Ubuntu Linux 64-bit client.
- **Linux** Installing the Linux on System z client  
You can install the Linux on System z® backup-archive client from the product installation media.
- **Linux** Uninstalling the Linux on System z client  
You can use the following procedures to uninstall the IBM Spectrum Protect Linux on System z client.
- **Mac OS X** Installing the Mac OS X client  
You can install the IBM Spectrum Protect Mac OS X backup-archive client from the product installation media.
- **Mac OS X** Uninstalling the Mac OS X client  
You can uninstall the IBM Spectrum Protect Mac OS X client if you no longer need it.
- **Solaris** Installing the Oracle Solaris x86\_64 client  
You can install the IBM Spectrum Protect Oracle Solaris x86\_64 backup-archive client from the product installation media.
- **Solaris** Uninstalling the Oracle Solaris x86\_64 client  
You can uninstall all the packages that are related to IBM Spectrum Protect Oracle Solaris x86\_64 client, including the command-line, GUI, web GUI, and administrative client components.
- **Solaris** Installing the Oracle SPARC API  
You can install the IBM Spectrum Protect Oracle Solaris SPARC API from the product installation media.
- **Solaris** Uninstalling the Oracle Solaris SPARC API  
You can uninstall all the packages that are related to IBM Spectrum Protect Oracle Solaris SPARC API.
- **AIX** **Linux** **Mac OS X** **Solaris** Software updates  
Software updates might periodically be made available by IBM® for download.

#### Related concepts:

Configure the IBM Spectrum Protect client

**AIX**

## Installing the AIX client

---

You can install the AIX® backup-archive client from the product installation media.

### About this task

---

In IBM Spectrum Protect™ Version 8.1.2, a 64-bit version of the AIX client is provided in the distribution libraries. You cannot upgrade a previously installed 32-bit AIX client to new the 64-bit AIX client. If you have a 32-bit client that is installed from a previous version of IBM Spectrum Protect, use SMIT to perform the following steps:

1. Uninstall the 32-bit client (tivoli.tsm.client.ba).
2. Uninstall any national language files that were previously installed.
3. Uninstall the API (tivoli.tsm.client.api.32bit).

Next, use SMIT to install the following packages in the IBM Spectrum Protect V8.1.2 distribution libraries, in the following order:

1. Install the 64-bit API (tivoli.tsm.client.api.64bit).
2. Install the 64-bit client (tivoli.tsm.client.ba.64bit).

If you already have a 64-bit IBM Spectrum Protect V6.3 (or newer) client installed, you can upgrade the client instead of uninstalling it and reinstalling it.

If you have a 64-bit client from an earlier version of IBM Spectrum Protect installed (for example, V6.1, or V6.2) you must uninstall the client, language packs, and API. Then, install the new IBM Spectrum Protect API and client.

All of the packages that are needed to install the client are in the AIX client package, and they overwrite any older runtime applications on your system during installation. The LibC (C Set ++ ) runtime library is required.

When you use the `installp` command to install this client, do not change the default field values for the following two choices:

- AUTOMATICALLY install requisite software?
- OVERWRITE same or newer versions?

Disabling or changing the values allows a lower-level client component to install over a currently higher installed component. Under such circumstances, function calls between components at different levels might not be valid any longer.

Install the following packages. They are all provided on the installation media. You need an Extended Edition license to use the NAS client.

The following files are listed in order of dependency. For example, the API is dependent on the Global Security Kit (GSKit). When you install all of them using SMIT, you can select them (F7) in any order.

GSKit8.gskcrypt64.ppc.rte and GSKit8.gskssl64.ppc.rte

IBM® GSKit 64-bit (required by the 64-bit client API).

tivoli.tsm.client.api.64bit

Installs the 64-bit API.

tivoli.tsm.client.ba.64bit

Installs the following 64-bit client files:

- Backup-archive Java™ client (GUI)
- Backup-archive web client
- NAS backup client

tivoli.tsm.filepath\_aix

Installs the file path kernel extension that is required for journal-based backup.

tivoli.tsm.client.jbb.64bit

Installs the journal-based backup component.

Each package is installed in the following default installation directory:

- The backup-archive, web client, and administrative client (dsmadm) 64-bit files are installed in the `/usr/tivoli/tsm/client/ba/bin64` directory.
- The IBM Spectrum Protect 64-bit API files are installed in the `/usr/tivoli/tsm/client/api/bin64` directory.
- The sample system-options file, `dsm.sys.smp`, is placed in the installation directory.

This installation procedure can be used to install new distributions or updates from downloaded installation media. The downloaded files that you use to install the client might be compressed. Depending on the package file format, either copy or extract the files to disk and use these instructions to install the components.

You can download the appropriate package file from one of the following websites:

- Download the client package from Passport Advantage or Fix Central.
- For the latest information, updates, and maintenance fixes, go to the IBM Support Portal.

If you are copying the client files into a local directory first, a `.toc` file is automatically created by the `installp` command. You can create a `.toc` file manually by running `/usr/sbin/inutoc` in the local directory to which you copied the IBM Spectrum Protect image. From the AIX command line, enter:

```
/usr/sbin/inutoc /usr/sys/inst.images
```

A .toc file is created in that directory.

## Procedure

---

1. Log in as the root user.
2. Mount the volume that you are installing from.
3. From the AIX command line, type `smitty install` and press Enter.
4. Select Install and Update Software and press Enter.
5. Select Install and Update From ALL Available Software and press Enter.
6. At the `INPUT device/directory for software` prompt, press the F4 key and specify the directory that contains the installation images, and press Enter.
7. At the `SOFTWARE to install` prompt, press the F4 key. Select the IBM Spectrum Protect file sets you want to install by pressing the F7 key. Then, press the Enter key.
8. On the Install and Update From ALL Available Software panel, press the F4 key to change any entry fields, or use the default fields. Press Enter twice to begin the installation.
9. After the installation completes, press F10 to exit.

## Results

---

When file sets are installed, they are automatically committed on the system. The previous version of backup-archive client software is replaced by the newly installed version.

The backup-archive client files are installed in the `/usr/tivoli/tsm/client/ba/bin64` directory. If you move the client files to another directory, you must perform the following steps:

1. Make sure that the permissions of the installed files have not changed.
2. Update the symbolic links for the installed files in the following directories:
  - The `/usr/bin` directory
  - The `/usr/lib` directory for IBM Spectrum Protect libraries
3. Ensure that every user of the backup-archive client sets the `DSM_DIR` environment variable to the newly installed directory.

## What to do next

---

After the installation completes, see [Configure the IBM Spectrum Protect client for required and optional tasks to complete before you use the backup-archive client](#).

Note:

- AIX workload partitions (WPAR) are supported as follows:
  - Supported in global environments
  - Supported with non-shared system WPARs
  - Supported with shared system WPARs (backup-archive client logs and configuration files must be defined to non-default locations)
  - No support for application WPARs
  - No support for image backup
  - No support for backup set restore from tape
- On AIX Version 6.1, if you are using encrypted file systems (EFS) with the backup-archive client, and if the EFS user keystore password is different from the user login password, the EFS keystore is not automatically opened when you log on. If the EFS keystore is not open when you log on, the client might not restore a non-EFS file into an EFS file system. You can prevent the EFS file system restore problem one of the following ways:
  - Start the backup-archive client by using the `efskeymgr -o` command. For example: `efskeymgr -o ./dsmj`
  - Synchronize the keystore password with the user login password by using the `efskeymgr -n` command. For example: `efskeymgr -n`

AIX

## Uninstalling the AIX client

---

You can use the following procedures to uninstall the IBM Spectrum Protect™ AIX® backup-archive client.

## Before you begin

---

IBM Spectrum Protect client modules and components are tightly integrated and installed file sets are automatically committed. There is no option for rollbacks of uninstalled components.

## Procedure

---

1. Enter the following AIX command: `smitty remove`.
2. Press the ENTER key.
3. In the SOFTWARE name field, press F4 to list the IBM Spectrum Protect file sets that you want to uninstall; press the ENTER key.
4. Select the IBM Spectrum Protect file sets that you want to uninstall; press the ENTER key.  
Note: The journal-based backup feature is contained in two file sets. Select both `tivoli.tsm.client.jbb.64bit` and `tivoli.tsm.filepath_aix`. If you uninstall the file sets one at a time, uninstall the `tivoli.tsm.client.jbb.64bit` file set first.
5. In the PREVIEW only? field (the remove operation does not occur), select No; press the ENTER key.

## Installing the HP-UX Itanium 2 API

---

You can install the HP-UX Itanium 2 API from the product installation media.

### About this task

---

The following source packages are available on the installation media:

`tsmcli/hp11ia64/gskcrypt64-8.x.x.x.hpux.ia64.tar.Z` and `tsmcli/hp11ia64/gskssl64-8.x.x.x.hpux.ia64.tar.Z`

Contains the GSKit. If you have a previous version of the GSKit, uninstall it before you install the new version.

`tsmcli/hp11ia64/TIVsmCapi64`

In this package, the software selection name that is used by `swlist` for the top-level product name is `TIVsm64`. The component under `TIVsm64` is `TIVsm.CLIENT_API64`.

### Default installation directories

Here are the default directories where some files are stored as part of the client installation:

- The IBM Spectrum Protect™ API files are installed in the `/opt/tivoli/tsm/client/api/bin64` directory.
- The sample system-options file, `dsm.sys.smp`, is placed in the installation directory.

To remove previous backup-archive client versions, log in as the root user and enter the following command:

```
/usr/sbin/swremove -x mount_all_filesystems=false -v TIVsm64
```

If you installed additional languages in a Version 7.1.2 or earlier client, run the following command to remove them:

```
/usr/sbin/swremove -x mount_all_filesystems=false -v TIVsm64.CLIENT_msg_lang
```

Replace *lang* with the appropriate language code from Table 1.

Table 1. HP-UX Itanium 2 client:  
Language codes for installation  
packages

Language	Language code
Simplified Chinese	ZH_CN
Traditional Chinese	ZH_TW
Czech	CS_CZ
French	FR_FR
German	DE_DE
Hungarian	HU_HU
Italian	IT_IT

Language	Language code
Japanese	JA_JP
Korean	KO_KR
Polish	PL_PL
Brazilian Portuguese	PT_BR
Russian	RU_RU
Spanish	ES_ES

This installation procedure can be used to install new distributions or updates from downloaded installation media. The downloaded files that you use to install the client might be compressed. Depending on the package file format, either copy or extract the files to disk and use these instructions to install the components.

You can download the appropriate package file from one of the following websites:

- Download the client package from Passport Advantage or Fix Central.
- For the latest information, updates, and maintenance fixes, go to the IBM Support Portal.

## Procedure

---

1. Log in as the root user.
2. Mount the volume that you are installing from.
3. To install GSKit: If you have a previous version of GSKit installed, remove it before you install the new version. Extract the contents of gskcrypt64-8.x.x.x.hpux.ia64.tar.Z and gskssl64-8.x.x.x.hpux.ia64.tar.Z to a directory on your hard disk. Enter the following commands to install the packages:

```
/usr/sbin/swinstall -x mount_all_filesystems=false -v -s `pwd`
/gskcrypt64 gskcrypt64
/usr/sbin/swinstall -x mount_all_filesystems=false -v -s `pwd`
/gskssl64 gskssl64
```

4. If you downloaded from FTP, go to the directory where the installable image is located. Enter the following command:

```
/usr/sbin/swinstall -x mount_all_filesystems=false -v -s `pwd`/TIVsmCapi64 TIVsm64
```

``pwd`` can be used instead of the absolute name of the current directory.

- Increasing the default limit of the data segment size  
The default limit of the data segment size of a process in HP-UX 11i v2 is 64 MB. When backing up large file systems, the API might exceed this limit and run out of memory.

### Related concepts:

Configure the IBM Spectrum Protect client

## Uninstalling the HP-UX Itanium 2 API

---

You can use the following procedures to uninstall the IBM Spectrum Protect™ HP-UX Itanium 2 API.

### Before you begin

---

Important: Make sure that you uninstall the packages in the order shown.

### Procedure

---

1. To remove the CLIENT\_API file set, enter the following command:

```
/usr/sbin/swremove -x mount_all_filesystems=false -v TIVsm64
```

2. To remove the Global Security Kit (GSKit), enter the following commands:

```
/usr/sbin/swremove -x mount_all_filesystems=false gskssl64
/usr/sbin/swremoveswremove -x mount_all_filesystems=false gskcrypt64
```

## What to do next

---

After you uninstall the HP-UX API, several empty directories remain in the file system, such as the following directories:

- The license directory (/opt/tivoli/tsm/license)
- One or more language directories (/opt/tivoli/tsm/client/ba/bin/xx\_XX), where xx\_XX represents one of the following language codes: cs\_CZ, de\_DE, es\_ES, it\_IT, fr\_FR, hu\_HU, ja\_JP, ko\_KR, pl\_PL, pt\_BR, ru\_RU, zh\_CN and zh\_TW
- /opt/tivoli/tsm/client/ba/bin/cit
- /opt/tivoli/tsm/client/ba/bin/images
- /opt/tivoli/tsm/client/ba/bin/plugin

If you want to remove these empty directories, you can manually remove them.

Linux

## Installing the backup-archive client on Linux on Power Systems™ (Little Endian)

---

You can install the backup-archive client from the product installation media.

### Before you begin

---

You must be logged in as root user to install the product.

This installation procedure can be used to install new distributions or updates from downloaded installation media. The downloaded files that you use to install the client might be compressed. Depending on the package file format, either copy or extract the files to disk and use these instructions to install the components.

You can download the appropriate package file from one of the following websites:

- Download the client package from Passport Advantage or Fix Central.
- For the latest information, updates, and maintenance fixes, go to the IBM Support Portal.

### About this task

---

The following installation options are available in uncompressed packages on the installation media.

Table 1. Package names, contents, and default directory

Package Name	Contents	Default directory
gskcrypt64-8.x.x.x.linux.ppcle.rpm gskssl64-8.x.x.x.linux.ppcle.rpm	64-bit Global Security Kit (GSKit) packages	/usr/local/ibm/gsk8
TIVsm-API64.ppc64le.rpm	Application programming interface (API), which contains the shared libraries and samples for the IBM Spectrum Protect™ API.	/opt/tivoli/tsm/client/api/bin64

Package Name	Contents	Default directory
TIVsm-BA.ppc64le.rpm	Backup-archive client (command-line and GUI), administrative client (dsmadm), and the web client.	<p>/opt/tivoli/tsm/client/ba/bin</p> <p>This directory is typically the default installation directory for many backup-archive client files. The sample system-options file (dsm.sys.smp) is written to this directory. If you do not set the DSM_DIR environment variable, the dsmc executable file, the resource files, and the dsm.sys file are stored in this directory.</p> <p>If you do not set the DSM_CONFIG environment variable, the client user-options file must be in this directory.</p> <p>If you do not set the DSM_LOG environment variable, the backup-archive client writes messages to the dsmerror.log and dsmsched.log files in the current working directory.</p>
TIVsm-APIcit.ppc64le.rpm TIVsm-BAcit.ppc64le.rpm	These files provide the Common Inventory Technology components that you can use to obtain information about the number of client and server devices that are connected to the system, and the utilization of processor value units (PVUs) by server devices. These files are optional. For more information about PVUs, see Estimating processor value units in the IBM Spectrum Protect server documentation.	<p>APIcit is installed in /opt/tivoli/tsm/client/api/bin64/cit</p> <p>BAcit is installed in /opt/tivoli/tsm/client/ba/bin/cit</p>
TIVsm-filepath-source.tar.gz TIVsm-JBB.ppc64le.rpm	Files that are needed for journal-based backups.	<p>The filepath and TIVsm-JBB packages are only required if you plan to use journal-based backups.</p> <p>Filepath is installed in /opt/filepath</p> <p>The TIVsm-JBB.ppc64le.rpm package is installed in /opt/tivoli/tsm/client/ba/bin.</p>

## Procedure

1. Mount the volume that you are installing the packages from.
2. Change to the directory where the installation packages are stored.
3. Install the 64-bit GSKit packages. In the following command example, the "8.x.x.x" characters represent the GSKit version:

```
rpm -U gskcrypt64-8.x.x.x.linux.ppcle.rpm gskssl64-8.x.x.x.linux.ppcle.rpm
```

4. Install the IBM Spectrum Protect API, and optionally install the Common Inventory Technology package that is necessary to support processor value unit (PVU) calculations.
  - a. Required: Install the API:

```
rpm -ivh TIVsm-API64.ppc64le.rpm
```



- b. Optional: Install the Common Inventory Technology package that is used by the API. This package depends on the API so it must be installed after the API package is installed.

```
rpm -ivh TIVsm-APIcit.ppc64le.rpm
```

Tip: If you are upgrading the API and the Common Inventory Technology package was previously installed, you must upgrade both the API and Common Inventory Technology packages. For example, you can run the following command:

```
rpm -U TIVsm-API64.ppc64le.rpm TIVsm-APIcit.ppc64le.rpm
```

If you need only the API installed, you can stop here. The rest of the steps in this procedure describe how to install the backup-archive client components and an optional client package that is needed only if you want the client to send PVU metrics to the server. Also described in subsequent steps are the installation of the packages that are needed if you want to perform journal-based backups.

5. Install the backup-archive client, and optionally install the Common Inventory Technology package that is necessary to support processor value unit (PVU) calculations.
  - a. Install the backup-archive client components.

```
rpm -ivh TIVsm-BA.ppc64le.rpm
```

- b. Optional: Install the Common Inventory Technology package the client uses to send PVU metrics to the server. This package depends on the client package so it must be installed after the client package is installed.

```
rpm -ivh TIVsm-BAcit.ppc64le.rpm
```

6. Optional: If you want to use journal-based backups, install the packages that are needed for the filepath component and journal-based backups.
  - a. Extract TIVsm-filepath-source.tar.gz and see the README file for compile and install instructions. The filepath kernel module is licensed pursuant to the terms of the GNU General Public License ("GPL").
  - b. Install the journal-based backup package:

```
rpm -ivh TIVsm-JBB.ppc64le.rpm
```

#### Related concepts:

Configure the IBM Spectrum Protect client

Linux

## Uninstalling the backup-archive client on Linux on Power Systems (Little Endian)

---

You can uninstall the IBM Spectrum Protect™ Linux on Power Systems™ (Little Endian).

### Before you begin

---

You must be logged in as root user to uninstall the product. You must uninstall the packages in the order that is shown, otherwise the uninstallation fails.

### Procedure

---

To uninstall the backup-archive client, enter the following commands to remove the packages for journal-based backup, the filepath component, the backup-archive client, the API, and the IBM Global Security Kit (GSKit).

Tip: The version number of the packages is not required.

1. To uninstall the journal-based backup components only, remove both packages (journal-based backup and filepath). The TIVsm-JBB package is dependent on the filepath package. If you use two separate rpm -e commands to uninstall the components one at a time, uninstall the TIVsm-JBB package first.

```
rpm -e TIVsm-JBB TIVsm-filepath
```

2. Uninstall the backup-archive client package:

```
rpm -e TIVsm-BA
```

3. Uninstall the backup-archive client packages:

a. If you installed the client common inventory package (TIVsmBAcit), uninstall it:

```
rpm -e TIVsm-BAcit
```

b. Uninstall the backup-archive client package:

```
rpm -e TIVsm-BA
```

4. Uninstall products that are dependent on the API, such as IBM Spectrum Protect for Databases and IBM Spectrum Protect for Mail. Any API-dependent products must be uninstalled before you uninstall the API package. If you uninstall an API-dependent product, you must reinstall it after you install a newer version of the backup-archive client and API packages. Follow the instructions of the API-dependent products to determine what you need to do to prevent data loss when you uninstall and reinstall the products.

5. Uninstall the API package by using the following command:

```
rpm -e TIVsm-API64
```

6. Uninstall the API packages:

a. If you installed the API common inventory package (TIVsm-APIcit), uninstall it:

```
rpm -e TIVsm-APIcit
```

b. Uninstall the API package by using the following command:

```
rpm -e TIVsm-API64
```

7. Uninstall GSKit by entering the following command:

```
rpm -e gskcrypt64 gskssl64
```

**Related tasks:**

Installing the backup-archive client on Linux on Power Systems (Little Endian)

Linux

## Installing the backup-archive client on Ubuntu Linux on Power Systems™ (Little Endian)

You can install the backup-archive client from the product installation media.

### Before you begin

You must be logged in as the root user to install the product.

This installation procedure can be used to install new distributions or updates from downloaded installation media. The downloaded files that you use to install the client might be compressed. Depending on the package file format, either copy or extract the files to disk and use these instructions to install the components.

You can download the appropriate package file from one of the following websites:

- Download the client package from Passport Advantage or Fix Central.
- For the latest information, updates, and maintenance fixes, go to the IBM Support Portal.

### About this task

The following installation packages are available on the installation media.

Table 1. Package names, contents, and default directory

Package Name	Contents	Default directory
gskcrypt64_8.x.x.x.ppc64el.deb	64-bit Global Security Kit (GSKit) packages	/usr/local/ibm/gsk8
gskssl64_8.x.x.x.ppc64el.deb		

Package Name	Contents	Default directory
tivsm-api64.ppc64el.deb	Application programming interface (API), which contains the shared library and samples for the IBM Spectrum Protect™ API.	/opt/tivoli/tsm/client/api/bin64
tivsm-ba.ppc64el.deb	Backup-archive client (command-line and GUI), administrative client (dsmadm), and the web client.	<p>/opt/tivoli/tsm/client/ba/bin</p> <p>This directory is typically the default installation directory for many backup-archive client files. The sample system-options file (dsm.sys.smp) is written to this directory.</p> <p>If you do not set the DSM_DIR environment variable, the dsmc executable file, the resource files, and the dsm.sys file are stored in this directory.</p> <p>If you do not set the DSM_CONFIG environment variable, the client user-options file must be in this directory.</p> <p>If you do not set the DSM_LOG environment variable, the backup-archive writes messages to the dsmererror.log and dsmsched.log files in the current working directory.</p>
TIVsm-filepath-source.tar.gz tivsm-jbb.ppc64el.deb	Files that are required for journal-based backups.	<p>The TIVsm-filepath-source.tar.gz package is installed in the /opt/filepath directory.</p> <p>The tivsm-jbb.ppc64el.rpm package is installed in the /opt/tivoli/tsm/client/ba/bin directory.</p>

## Procedure

1. Mount the volume that you are installing the packages from.
2. Change to the directory where the installation packages are stored.
3. Install the 64-bit GSKit packages. In the following command example, the "8.x.x.x" characters represent the GSKit version:

```
dpkg -i gskcrypt64_8.x.x.x.ppc64el.deb gskssl64_8.x.x.x.ppc64el.deb
```

4. Install the IBM Spectrum Protect API:

```
dpkg -i tivsm-api64.ppc64el.deb
```

If you need to install only the API, you can stop here. Use the following steps to install the backup-archive client and the packages that are required to run journal-based backups.

5. Install the backup-archive client:

```
dpkg -i tivsm-ba.ppc64el.deb
```

6. Optional: If you want to use journal-based backups, install the following packages:
  - a. Extract TIVsm-filepath-source.tar.gz and review the README file for instructions about how to compile and install the software. The Linux Filepath kernel module is licensed pursuant to the terms of the GNU General Public License ("GPL").
  - b. Install the journal-based backup package:

```
dpkg -i tivsm-jbb.ppc64el.deb
```

### Related concepts:

Configure the IBM Spectrum Protect client

Linux

# Uninstalling the client on Ubuntu Linux on Power Systems (Little Endian)

---

You can uninstall the IBM Spectrum Protect™ backup-archive client on Linux on Power Systems™ (Little Endian).

## Before you begin

---

You must be logged in as the root user to uninstall the product.

Requirement: You must uninstall the packages in the order that is shown, otherwise the uninstallation fails.

## Procedure

---

To uninstall the backup-archive client, enter the following commands to remove the packages for journal-based backup, the backup-archive client, the API, and the IBM Global Security Kit (GSKit). Instructions for uninstalling the filepath component are provided with the source code for filepath, when you obtain the software from IBM®.

Tip: The version number of the packages is not required.

1. To uninstall only the journal-based backup components, remove both the tivsm-jbb and filepath packages. The tivsm-jbb package depends on the filepath package. Uninstall the tivsm-jbb package first.

- a. `dpkg -r tivsm-jbb`
- b. `dpkg -r TIVsm-filepath`

2. Uninstall the backup-archive client package:

```
dpkg -r tivsm-ba
```

3. Uninstall any products that depend on the API, such as IBM Spectrum Protect for Databases and IBM Spectrum Protect for Mail.

If you uninstall an API-dependent product, you must reinstall it after you install a newer version of the backup-archive client and API packages. Follow the instructions of the API-dependent products to determine what you need to do to prevent data loss when you uninstall and reinstall the products.

4. Uninstall the API package by issuing the following command:

```
dpkg -r tivsm-api64
```

5. Remove the GSKit packages:

```
dpkg -r gskcrypt64 gskssl64
```

### Related tasks:

Installing the backup-archive client on Ubuntu Linux on Power Systems (Little Endian)

Linux

# Installing the API on Linux on Power Systems™ (Big Endian)

---

You can install the IBM Spectrum Protect™ API from the product installation media.

## Before you begin

---

You must be logged in as root user to install the product.

## About this task

---

If you have IBM Spectrum Protect Version 6.2 (or an earlier version) installed, remove it (`rpm -e`) and any other dependent software programs before you install a newer version.

If you have IBM Spectrum Protect V6.3 (or newer) installed, you can use the rpm upgrade option (`rpm -U`) or the rpm freshen option (`rpm -F`) to upgrade the existing software to a newer version. The `rpm -U` command can be used to install new packages or upgrade existing packages; `rpm -F` can update only packages that are already installed.

Stop any running client processes before you uninstall or upgrade the IBM Spectrum Protect API or backup-archive client. If you are running a V7.1.2 or earlier client, you must uninstall any language packages before you proceed with the upgrade.

Table 1 shows the installation options that are available in uncompressed packages on the installation media.

Table 1. Package names, contents, and default directory

Package Name	Contents	Default directory
gskcrypt64-8.x.x.x.linux.ppc.rpm gskssl64-8.x.x.x.linux.ppc.rpm	64-bit Global Security Kit (GSKit) packages	/usr/local/ibm/gsk8
TIVsm-API64.ppc64.rpm	Application programming interface (API), which contains the IBM Spectrum Protect API shared libraries and samples.	/opt/tivoli/tsm/client/api/bin64
TIVsm-APIcit.ppc64.rpm	Optional. These files provide the Common Inventory Technology components that you can use to obtain information about the number of client and server devices that are connected to the system, and the utilization of processor value units (PVUs) by server devices. For more information about PVUs, see Estimating processor value units in the IBM Spectrum Protect server documentation.	APIcit is installed in /opt/tivoli/tsm/client/api/bin64/cit

This installation procedure can be used to install new distributions or updates from downloaded installation media. The downloaded files that you use to install the client might be compressed. Depending on the package file format, either copy or extract the files to disk and use these instructions to install the components.

You can download the appropriate package file from one of the following websites:

- Download the client package from Passport Advantage or Fix Central.
- For the latest information, updates, and maintenance fixes, go to the IBM Support Portal.

## Procedure

1. Mount the volume that you are installing from.
2. Change to the directory where the installation packages are stored.
3. Install the 64-bit GSKit packages. In this example, the "8.x.x.x" characters represent the GSKit version:

```
rpm -U gskcrypt64-8.x.x.x.linux.ppc.rpm gskssl64-8.x.x.x.linux.ppc.rpm
```

4. Install the IBM Spectrum Protect API, and optionally install the Common Inventory Technology package that is needed to support processor value unit (PVU) calculations.
  - a. Required: Install the API:

```
rpm -i TIVsm-API64.ppc64.rpm
```

- b. Optional: Install the Common Inventory Technology package that is used by the API. This package is dependent on the API so it must be installed after the API package is installed.

```
rpm -i TIVsm-APIcit.ppc64.rpm
```

Tip: If you are upgrading the API and the Common Inventory Technology package was previously installed, you must upgrade both the API and Common Inventory Technology packages. For example, you can run the following command:

```
rpm -U TIVsm-API64.ppc64.rpm TIVsm-APIcit.ppc64.rpm
```

**Related concepts:**

Configure the IBM Spectrum Protect client

Linux

## Uninstalling the API on Linux on Power Systems (Big Endian)

You can uninstall the IBM Spectrum Protect™ API on IBM Spectrum Protect Linux on Power Systems™ (Big Endian).

### Before you begin

You must be logged in as root to uninstall the product. Uninstall the packages in the order shown.

### Procedure

To uninstall a previously installed IBM Spectrum Protect package, enter the following commands to remove the packages for journal-based backup, the filepath component, the backup-archive client (if applicable), the API, and the IBM Global Security Kit (GSKit).

Tip: The version number of the packages is not needed for uninstall.

1. Complete this step if a version 7.1 or earlier client was installed previously.

To uninstall the journal-based backup components only, remove both packages (journal-based backup and filepath). The TIVsm-JBB package is dependent on the filepath package. If you use two separate rpm -e commands to uninstall the components one at a time, uninstall the TIVsm-JBB package first.

```
rpm -e TIVsm-JBB TIVsm-filepath
```

2. If a version 7.1 or earlier client was installed previously, uninstall the backup-archive client packages.
  - a. If you installed the optional TIVsmBACit package, uninstall it by using the following command:

```
rpm -e TIVsm-BACit
```

- b. Uninstall the backup-archive client package:

```
rpm -e TIVsm-BA
```

Note: If language packages are installed in a Version 7.1.2 or earlier client, you must remove them before you remove the API package. Enter the following command, and replace xx\_xx with the language code for each additional language that you installed. For a list of language code identifiers, see Table 1.

```
rpm -e TIVsm-BA.msg.xx_xx
```

Table 1. Language pack identifiers

Language	Language identifier
Czech	CS_CZ
French	FR_FR
German	DE_DE
Hungarian	HU_HU
Italian	IT_IT
Japanese	JA_JP
Korean	KO_KR
Polish	PL_PL
Portuguese	PT_BR
Russian	RU_RU
Spanish	ES_ES

Language	Language identifier
Traditional Chinese (EUC)	ZH_CN
Traditional Chinese Big5	ZH_TW

- Uninstall any products that are dependent on the API, such as IBM Spectrum Protect for Databases and IBM Spectrum Protect for Mail. Any API-dependent products must be uninstalled before you uninstall the API package. If you uninstall an API-dependent product, you must reinstall it after you install a newer version of the API package. Consult the documentation of the dependent product to determine what you need to do to prevent data loss when you uninstall and reinstall the products.
- If you installed the optional API common inventory package (TIVsm-APIcit), use the following command to uninstall the package:

```
rpm -e TIVsm-APIcit
```

- Uninstall the API package by using the following command:

```
rpm -e TIVsm-API64
```

- Uninstall GSKit by using the following command:

```
rpm -e gskcrypt64 gskssl64
```

#### Related tasks:

Installing the API on Linux on Power Systems (Big Endian)

Linux

## Installing the Linux x86\_64 client

You can install the Linux x86\_64 backup-archive client from the product installation media.

### Before you begin

- You must be logged in as root to install the product.
- If you have IBM Spectrum Protect™ Version 6.2 (or an earlier version) installed, remove it (rpm -e) and any other dependent software programs before you install a newer version.
- If you have IBM Spectrum Protect V6.3 (or later) installed, you can use the rpm upgrade option (rpm -U) or the rpm freshen option (rpm -F) to upgrade the existing software to a newer version. The rpm -U command can be used to install new packages or upgrade existing packages only if you did not previously install any language packages. The rpm -F command can update only packages that are already installed.
- Stop any running client processes before you uninstall or upgrade the IBM Spectrum Protect API or backup-archive client.
- If any language packages are installed, you must uninstall them before you install or upgrade the IBM Spectrum Protect API or backup-archive client.

### About this task

The following installation options are available in uncompressed packages on the installation media.

Table 1. Package names, contents, and default directory

Package Name	Contents	Default directory
gskcrypt64-8.x.x.x.linux.x86_64.rpm gskssl64-8.x.x.x.linux.x86_64.rpm	64-bit Global Security Kit (GSKit) packages	/usr/local/ibm/gsk8
TIVsm-API64.x86_64.rpm	Application programming interface (API), which contains the IBM Spectrum Protect API shared libraries and samples.	/opt/tivoli/tsm/client/api/bin64

Package Name	Contents	Default directory
TIVsm-BA.x86_64.rpm	Backup-archive client (command-line and GUI), administrative client (dsmadm), and the web client.	<p>/opt/tivoli/tsm/client/ba/bin</p> <p>This directory is considered to be the default installation directory for many backup-archive client files. The sample system-options file (dsm.sys.smp) is written to this directory. If the DSM_DIR environment variable is not set, the dsmc executable file, the resource files, and the dsm.sys file are stored in this directory.</p> <p>If DSM_CONFIG is not set, the client user-options file must be in this directory.</p> <p>If you do not define DSM_LOG, writes messages to the dsmerror.log and dsmsched.log files in the current working directory.</p>
TIVsm-APIcit.x86_64.rpm TIVsm-BACit.x86_64.rpm	Optional. These files provide the Common Inventory Technology components that you can use to obtain information about the number of client and server devices that are connected to the system, and the utilization of processor value units (PVUs) by server devices. For more information about PVUs, see Estimating processor value units in the IBM Spectrum Protect server documentation.	<p>APIcit is installed in /opt/tivoli/tsm/client/api/bin64/cit/</p> <p>BACit is installed in /opt/tivoli/tsm/client/ba/bin/cit/</p>
TIVsm-filepath-source.tar.gz TIVsm-JBB.x86_64.rpm	Files needed to support journal-based backups.	<p>Filepath is installed in /opt/filepath</p> <p>JBB is installed in /opt/tivoli/tsm/client/ba/bin</p>
TIVsm_BAhdw.x86_64.rpm	Provides support for snapshot incremental backup for NetAPP and N-Series file servers.	/opt/tivoli/tsm/client/ba/bin/plugins

This installation procedure can be used to install new distributions or updates from downloaded installation media. The downloaded files that you use to install the client might be compressed. Depending on the package file format, either copy or extract the files to disk and use these instructions to install the components.

You can download the appropriate package file from one of the following websites:

- Download the client package from Passport Advantage or Fix Central.
- For the latest information, updates, and maintenance fixes, go to the IBM Support Portal.

## Procedure

To install the Linux x86\_64 backup-archive client, complete the following steps:

1. Mount the volume that you are installing from.
2. Change to the directory where the installation packages are stored.
3. Install the 64-bit GSKit packages. In this example, the "8.x.x.x" characters represent the GSKit version:

```
rpm -U gskcrypt64-8.x.x.x.linux.x86_64.rpm gskssl64-8.x.x.x.linux.x86_64.rpm
```



4. Install the IBM Spectrum Protect API, and optionally install the Common Inventory Technology package that is necessary to support processor value unit (PVU) calculations.

- a. Required: Install the API:

```
rpm -i TIVsm-API64.x86_64.rpm
```

- b. Optional: Install the Common Inventory Technology package that is used by the API. This package depends on the API so it must be installed after the API package is installed.

```
rpm -i TIVsm-APIcit.x86_64.rpm
```

Tip: If you are upgrading the API and the Common Inventory Technology package was previously installed, you must upgrade both the API and Common Inventory Technology packages. For example, you can run the following command:

```
rpm -U TIVsm-API64.x86_64.rpm TIVsm-APIcit.x86_64.rpm
```

If you need only the API installed, you can stop here. The rest of the steps in this procedure describe how to install the backup-archive client components and an optional client package that is needed only if you want the client to send PVU metrics to the server. Also described in subsequent steps are the installation of the packages that are needed if you want to perform journal-based backups.

5. Install the backup-archive client, and optionally install the Common Inventory Technology package that is necessary to support processor value unit (PVU) calculations.

- a. Install the backup-archive client components.

```
rpm -i TIVsm-BA.x86_64.rpm
```

- b. Optional: Install the Common Inventory Technology package the client uses to send PVU metrics to the server. This package depends on the client package so it must be installed after the client package is installed.

```
rpm -i TIVsm-BAcit.x86_64.rpm
```

6. Optional: If you want to use journal-based backups, you must compile and install the filepath component that matches the Linux kernel on your client computer. Extract TIVsm-filepath-source.tar.gz and see the README file for compile and install instructions. The Linux filepath kernel module is licensed pursuant to the terms of the GNU General Public License ("GPL").

7. Install the snapshot difference incremental backup support for NetApp and N-Series file servers by entering the following command:

```
rpm -i TIVsm-BAhdw.x86_64.rpm
```

#### Related concepts:

Configure the IBM Spectrum Protect client

Linux

## Uninstalling the Linux x86\_64 client

---

You can use the following procedure to uninstall the IBM Spectrum Protect™ Linux x86\_64 client.

### Before you begin

---

You must be logged in as root to uninstall the product. Uninstall the packages in the order shown.

### Procedure

---

To uninstall a previously installed IBM Spectrum Protect client package, enter the following commands to remove the packages for journal-based backup, the filepath component, the backup-archive client, the API, and the IBM Global Security Kit (GSKit).

Tip: The version number of the packages is not needed for uninstall.

1. To uninstall the journal-based backup components only, remove both packages (journal-based backup and filepath). The TIVsm-JBB package depends on the filepath package. If you use two separate rpm -e commands to uninstall the components one at a time, uninstall the TIVsm-JBB package first.

```
rpm -e TIVsm-JBB TIVsm-filepath
```

2. Uninstall the backup-archive client packages:

- a. If you installed the optional TIVsm-BAcit package, uninstall it before you uninstall the client:

```
rpm -e TIVsm-BAcit
```

b. Uninstall the backup-archive client.

```
rpm -e TIVsm-BA
```

Note: If language packages are installed in a Version 7.1.2 or earlier client, you must remove them before you remove the API package. Enter the following command, and replace `xx_xx` with the language code for each additional language that you installed. For a list of language code identifiers, see Table 1.

```
rpm -e TIVsm-msg.xx_xx
```

Table 1. Language pack identifiers

Language	Language identifier
Czech	CS_CZ
French	FR_FR
German	DE_DE
Hungarian	HU_HU
Italian	IT_IT
Japanese	JA_JP
Korean	KO_KR
Polish	PL_PL
Portuguese	PT_BR
Russian	RU_RU
Spanish	ES_ES
Traditional Chinese (EUC)	ZH_CN
Traditional Chinese Big5	ZH_TW

3. Uninstall any products that depend on the API, such as IBM Spectrum Protect for Databases and IBM Spectrum Protect for Mail. Any API-dependent products must be uninstalled before you uninstall the API package. If you uninstall an API-dependent product, you must reinstall it after you install a newer version of the backup-archive client and API packages. Consult the documentation of the dependent product to determine what you need to do to prevent data loss when you uninstall and reinstall the products.

a. If you installed the optional API common inventory package (TIVsm-APIcit), uninstall it before you uninstall the API package. Use the following command to uninstall the package:

```
rpm -e TIVsm-APIcit
```

b. Uninstall the API package by using the following command:

```
rpm -e TIVsm-API64
```

4. To remove the GSKit 64-bit package, enter the following command:

```
rpm -e gskcrypt64 gskssl64
```

**Related tasks:**

Installing the Linux x86\_64 client

Linux

## Installing the Ubuntu Linux x86\_64 client

You can install the Ubuntu Linux 64-bit backup-archive client from the product installation media.

### About this task

The following installation options are available in uncompressed packages on the installation media.

Table 1. Package names, contents, and default directory

Package Name	Contents	Default directory
gskcrypt64_8.0-50.40.linux.x86_64.deb gskssl64_8.0-50.40.linux.x86_64.deb	64-bit Global Security Kit (GSKit) packages	/usr/local/ibm/gsk8
tivsm-api64.amd64.deb	Application programming interface (API), which contains the IBM Spectrum Protect™ API shared libraries and samples.	/opt/tivoli/tsm/client/api/bin64
tivsm-ba.amd64.deb	Backup-archive client (command-line and GUI), administrative client (dsmadm), and the web client.	/opt/tivoli/tsm/client/ba/bin  This directory is considered to be the default installation directory for many backup-archive client files. The sample system-options file (dsm.sys.smp) is written to this directory. If the DSM_DIR environment variable is not set, the dsmd executable file, the resource files, and the dsm.sys file are stored in this directory.  If DSM_CONFIG is not set, the client user-options file must be in this directory.  If you do not define DSM_LOG, writes messages to the dsmderror.log and dsmsched.log files in the current working directory.
tivsm-apicit.amd64.deb tivsm-bacit.amd64.deb	Optional. These files provide the Common Inventory Technology components that you can use to obtain information about the number of client and server devices that are connected to the system, and the utilization of processor value units (PVUs) by server devices. For more information about PVUs, see Estimating processor value units in the IBM Spectrum Protect server documentation.	APIcit is installed in /opt/tivoli/tsm/client/api/bin64/cit  BACit is installed in /opt/tivoli/tsm/client/ba/bin/cit
tivsm-filepath-source.tar.gz tivsm-jbb.amd64.deb	Files needed to support journal-based backups.	The filepath and tivsm-jbb packages are only required if you plan to use journal-based backups.  The tivsm-jbb.x86_64.deb package is installed in /opt/tivoli/tsm/client/ba/bin.
tivsm-bahdw.amd64.deb	Provides support for snapshot incremental backup for NetAPP and N-Series file servers.	/opt/tivoli/tsm/client/ba/bin/plugins

This installation procedure can be used to install new distributions or updates from downloaded installation media. The downloaded files that you use to install the client might be compressed. Depending on the package file format, either copy or extract the files to disk and use these instructions to install the components.

You can download the appropriate package file from one of the following websites:

- Download the client package from Passport Advantage or Fix Central.
- For the latest information, updates, and maintenance fixes, go to the IBM Support Portal.

## Procedure

---

To install the Ubuntu Linux x86\_64 backup-archive client, complete the following steps.

1. Mount the volume that you are installing from.
2. Change to the directory where the installation packages are stored.
3. Install the 64-bit GSKit packages.

```
sudo dpkg -i gskcrypt64_8.0-50.40.linux.x86_64.deb gskssl64_8.0-50.40.linux.x86_64.deb
```

4. Install the IBM Spectrum Protect API, and optionally install the Common Inventory Technology package that is necessary to support processor value unit (PVU) calculations.

a. Required: Install the API:

```
sudo dpkg -i tivsm-api64.amd64.deb
```

b. Optional: Install the Common Inventory Technology package that is used by the API. This package depends on the API so it must be installed after the API package is installed.

```
sudo dpkg -i tivsm-apicit.amd64.deb
```

If you need only the API installed, you can stop here. The rest of the steps in this procedure describe how to install the backup-archive client components and an optional client package that is needed only if you want the client to send PVU metrics to the server. Also described in subsequent steps are the installation of the packages that are needed if you want to perform journal-based backups.

5. Install the backup-archive client, and optionally install the Common Inventory Technology package that is necessary to support processor value unit (PVU) calculations.

a. Install the backup-archive client components.

```
sudo dpkg -i tivsm-ba.amd64.deb
```

b. Optional: Install the Common Inventory Technology package that the client uses to send PVU metrics to the server. This package depends on the client package so it must be installed after the client package is installed.

```
sudo dpkg -i tivsm-bacit.amd64.deb
```

6. Optional: Complete this step only if you plan to use journal-based backups.

a. Extract `tivsm-filepath-source.tar.gz` and see the README file for compile and install instructions. The filepath kernel module is licensed pursuant to the terms of the GNU General Public License ("GPL").

b. Install the journal-based backup package: `dpkg -i tivsm-jbb.amd64.deb`.

7. Install the snapshot difference incremental backup support for NetApp and N-Series file servers by entering the following command:

```
sudo dpkg -i tivsm-bahdw.amd64.deb
```

### Related concepts:

Configure the IBM Spectrum Protect client

Linux

## Uninstalling the Ubuntu Linux x86\_64 client

---

Use the following procedure to uninstall the IBM Spectrum Protect™ Linux 64-bit client.

### Procedure

---

To uninstall a previously installed IBM Spectrum Protect client package, enter the following commands to remove the packages for journal-based backup, the backup-archive client, the API, and the IBM Global Security Kit (GSKit). Instructions to uninstall the filepath component are provided with the source code for filepath, when you obtain the software from IBM®.

1. To uninstall only the journal-based backup components, remove both the `tivsm-jbb` and the filepath component. The `tivsm-jbb` package depends on the filepath package. Uninstall the `tivsm-jbb` package first.

a. `sudo dpkg -r tivsm-jbb`

b. `sudo dpkg -r tivsm-filepath`

2. Uninstall the backup-archive client packages:

a. If you installed the optional tivsm-bacit package, uninstall it before you uninstall the client:

```
sudo dpkg -r tivsm-bacit
```

b. Uninstall the backup-archive client.

```
sudo dpkg -r tivsm-ba
```

Note: If language packages are installed in a Version 7.1.2 or earlier client, you must remove them before you remove the API package. Enter the following command, and replace xx-xx with the language code for each additional language that you installed. For a list of language code identifiers, see Table 1.

```
dpkg -r tivsm-msg.xx-xx
```

Table 1. Language pack identifiers

Language	Language identifier
Czech	cs-cz
French	fr-fr
German	de-de
Hungarian	hu-hu
Italian	it-it
Japanese	ja-jp
Korean	ko-kr
Polish	pl-pl
Portuguese	pt-br
Russian	ru-ru
Spanish	es-es
Traditional Chinese (EUC)	zh-cn
Traditional Chinese Big5	zh-tw

3. Uninstall any products that depend on the API, such as IBM Spectrum Protect Data Protection products. Any API-dependent products must be uninstalled before you uninstall the API package. If you uninstall an API-dependent product, you must reinstall it after you install a newer version of the backup-archive client and API packages. Consult the documentation of the dependent product to determine what you need to do to prevent data loss when you uninstall and reinstall the products.

a. If you installed the optional API common inventory package (tivsm-apicit), uninstall it before you uninstall the API package. Use the following command to uninstall the package:

```
sudo dpkg -r tivsm-apicit
```

b. Uninstall the API package by using the following command:

```
sudo dpkg -r tivsm-api64
```

4. To remove the GSKit 64-bit packages, enter the following command:

```
sudo dpkg -r gskcrypt64 gskssl64
```

**Related tasks:**

Installing the Ubuntu Linux x86\_64 client

Linux

## Installing the Linux on System z client

You can install the Linux on System z® backup-archive client from the product installation media.

### Before you begin

You must be logged in as root to install the product.

## About this task

If you have IBM Spectrum Protect™ Version 6.2 (or an earlier version) installed, remove it (rpm -e) and any other dependent software programs before you install a newer version.

If you have IBM Spectrum Protect V6.3 (or newer) installed, you can use the rpm upgrade option (rpm -U) or the rpm freshen option (rpm -F) to upgrade the existing software to a newer version. The rpm -U command can be used to install new packages or upgrade existing packages; rpm -F can update only packages that are already installed.

Stop any running client processes before you uninstall or upgrade the IBM Spectrum Protect API or backup-archive client. If you are running a V7.1.2 or earlier client, you must uninstall any language packages before you proceed with the upgrade.

The following installation options are available in uncompressed packages on the installation media.

Table 1. Package names, contents, and default directory

Package Name	Contents	Default directory
gskcrypt64-8.x.x.x.linux.s390x.rpm gskssl64-8.x.x.x.linux.s390x.rpm	64-bit Global Security Kit (GSKit) packages	/usr/local/ibm/gsk8
TIVsm-API64.s390x.rpm	Application programming interface (API), which contains the IBM Spectrum Protect API shared libraries and samples.	/opt/tivoli/tsm/client/api/bin64
TIVsm-BA.s390x.rpm	Backup-archive client (command-line and GUI), administrative client (dsmadm), and the web client.	/opt/tivoli/tsm/client/ba  This directory is considered to be the default installation directory for many backup-archive client files. The sample system-options file (dsm.sys.smp) is written to this directory. If the DSM_DIR environment variable is not set, the dsme executable file, the resource files, and the dsm.sys file are stored in this directory.  If DSM_CONFIG is not set, the client user-options file must be in this directory.  If you do not define DSM_LOG, the backup-archive client writes messages to the dsmeerror.log and dsmsched.log files in the current working directory.

Package Name	Contents	Default directory
TIVsm-APIcit.s390x.rpm TIVsm-BAcit.s390x.rpm	Optional. These files provide the Common Inventory Technology components that you can use to obtain information about the number of client and server devices that are connected to the system, and the utilization of processor value units (PVUs) by server devices. For more information about PVUs, see Estimating processor value units in the IBM Spectrum Protect server documentation.	APIcit is installed in /opt/tivoli/tsm/client/api/bin64/cit  BAcit is installed in /opt/tivoli/tsm/client/ba/bin/cit
TIVsm-filepath-source.tar.gz TIVsm-JBB.s390x.rpm	Files needed to support journal-based backups.	Filepath is installed in /opt/filepath  JBB is installed in /opt/tivoli/tsm/client/ba/bin

This installation procedure can be used to install new distributions or updates from downloaded installation media. The downloaded files that you use to install the client might be compressed. Depending on the package file format, either copy or extract the files to disk and use these instructions to install the components.

You can download the appropriate package file from one of the following websites:

- Download the client package from Passport Advantage or Fix Central.
- For the latest information, updates, and maintenance fixes, go to the IBM Support Portal.

## Procedure

1. Mount the volume that you are installing from.
2. Change to the directory where the packages are stored.
3. Install the 64-bit GSKit packages. In this example, the "8.x.x.x" characters represent the GSKit version:

```
rpm -U gskcrypt64-8.x.x.x.linux.s390x.rpm gskssl64-8.x.x.x.linux.s390x.rpm
```

4. Install the IBM Spectrum Protect API, and optionally install the Common Inventory Technology package that is needed to support processor value unit (PVU) calculations.
  - a. Required: Install the API:

```
rpm -i TIVsm-API64.s390x.rpm
```

- b. Optional: Install the Common Inventory Technology package that is used by the API. This package is dependent on the API so it must be installed after the API package is installed.

```
rpm -i TIVsm-APIcit.s390x.rpm
```

**Tip:** If you are upgrading the API and the Common Inventory Technology package was previously installed, you must upgrade both the API and Common Inventory Technology packages. For example, you can run the following command:

```
rpm -U TIVsm-API64.s390x.rpm TIVsm-APIcit.s390x.rpm
```

If you need only the API installed, you can stop here. The rest of the steps in this procedure describe how to install the backup-archive client components and an optional client package that is needed only if you want the client to send PVU metrics to the server. Also described in subsequent steps are the installation of the packages that are needed if you want to perform journal-based backups.

5. Install the backup-archive client, and optionally install the Common Inventory Technology package that is needed to support processor value unit (PVU) calculations.

- a. Install the backup-archive client components.

```
rpm -i TIVsm-BA.s390x.rpm
```

- b. Optional: Install the Common Inventory Technology package the client uses to send PVU metrics to the server. This package is dependent on the client package so it must be installed after the client package is installed.

```
rpm -i TIVsm-BAcit.s390x.rpm
```

6. Optional: If you want to use journal-based backups, you must compile and install the filepath component that matches the Linux kernel on your client computer. Extract TIVsm-filepath-source.tar.gz and see the README file for compile and install instructions. The Linux filepath kernel module is licensed pursuant to the terms of the GNU General Public License ("GPL").

**Related concepts:**

Configure the IBM Spectrum Protect client

Linux

## Uninstalling the Linux on System z client

You can use the following procedures to uninstall the IBM Spectrum Protect™ Linux on System z® client.

### Before you begin

You must be logged in as root to install the product. Uninstall the packages in the order shown.

### About this task

To uninstall a previously installed IBM Spectrum Protect client package, enter the following commands to remove the packages for journal-based backup, the filepath component, the backup-archive client, the API, and the IBM® Global Security Kit (GSKit).

Tip: The version number of the packages is not needed for uninstall.

### Procedure

1. To uninstall the journal-based backup components only, remove both packages (journal-based backup and filepath). The TIVsm-JBB package is dependent on the filepath package. If you use two separate rpm -e commands to uninstall the components one at a time, uninstall the TIVsm-JBB package first.

```
rpm -e TIVsm-JBB TIVsm-filepath
```

2. Uninstall the backup-archive client packages:

- a. If you installed the optional TIVsm-BAcit package, uninstall it before you uninstall the client:

```
rpm -e TIVsm-BAcit
```

- b. Uninstall the backup-archive client.

```
rpm -e TIVsm-BA
```

Note: If language packages are installed in a Version 7.1.2 or earlier client, you must remove them before you remove the API package. Enter the following command, and replace xx\_xx with the language code for each additional language that you installed. For a list of language code identifiers, see Table 1.

```
rpm -e TIVsm-msg.xx_xx
```

Table 1. Language pack identifiers

Language	Language identifier
Czech	CS_CZ
French	FR_FR
German	DE_DE
Hungarian	HU_HU
Italian	IT_IT



Language	Language identifier
Japanese	JA_JP
Korean	KO_KR
Polish	PL_PL
Portuguese	PT_BR
Russian	RU_RU
Spanish	ES_ES
Traditional Chinese (EUC)	ZH_CN
Traditional Chinese Big5	ZH_TW

- Uninstall any products that are dependent on the API, such as IBM Spectrum Protect for Databases and IBM Spectrum Protect for Mail. Any API-dependent products must be uninstalled before you uninstall the API package. If you uninstall an API-dependent product, you must reinstall it after you install a newer version of the backup-archive client and API packages. Consult the documentation of the dependent product to determine what you need to do to prevent data loss when you uninstall and reinstall the products.

- If you installed the optional API common inventory package (TIVsm-APIcit), uninstall it before you uninstall the API package. Use the following command to uninstall the package:

```
rpm -e TIVsm-APIcit
```

- Uninstall the API package by using the following command:

```
rpm -e TIVsm-API64
```

- To remove the GSKit 64-bit package, enter the following command:

```
rpm -e gskcrypt64 gskssl64
```

#### Related tasks:

Installing the Linux on System z client

Mac OS X

## Installing the Mac OS X client

---

You can install the IBM Spectrum Protect™ Mac OS X backup-archive client from the product installation media.

### Before you begin

---

You must be a system administrator to install the backup-archive client.

### About this task

---

This installation procedure can be used to install new distributions or updates from downloaded installation media. The downloaded files that you use to install the client might be compressed. Depending on the package file format, either copy or extract the files to disk and use these instructions to install the components.

You can download the appropriate package file from one of the following websites:

- Download the client package from Passport Advantage or Fix Central.
- For the latest information, updates, and maintenance fixes, go to the IBM Support Portal.

For MAC OS X clients, you can use an installation wizard that prompts you for information as the product is installed, or you can also install the client from the command line. When you install the client by using the command-line installation procedure, the installation runs without user interaction. The command-line procedure is useful if you want to script the installation and run it on many nodes, or if you must install the software on a system that does not have a monitor.

### Procedure

---

Select an installation method and install the client. Use either the installation wizard method or install the client from the command line.

Installation method	Procedure
Installation wizard	a. Double-click the 8.1.2.0.0-TIV-TSMBAC-Mac.dmg file to mount the disk image. b. Double-click the IBM Spectrum Protect installation package icon and follow the prompts to complete the installation.
Command line	a. Change directories to where the IBM Spectrum Protect installer is located. b. Install the custom installation package with the following command: <pre> /usr/sbin/installer -pkg "/Volumes/IBM Spectrum Protect/ IBM Spectrum Protect.pkg" -target / </pre>

## What to do next

A sample client system options file, called `dsm.sys.smp`, is created in the installation directory. You can copy this file and modify it to create the client systems options file for your node. The default name for the client systems option file is `dsm.sys`.

After you install the client, you might need to set environment variables before you use it. For more information about setting environment variables, see [Set processing environment variables](#).

Mac OS X

## Uninstalling the Mac OS X client

You can uninstall the IBM Spectrum Protect™ Mac OS X client if you no longer need it.

### Before you begin

If the IBM Spectrum Protect scheduler is configured as a startup item, use the IBM Spectrum Protect Tools for Administrators function or the `StopCad.sh` shell script to stop and uninstall the scheduler before you begin this procedure.

### About this task

You can use a shell script to uninstall the backup-archive client. The shell script name is `uninstall.sh` and it is in the default installation directory, which is `/Library/Application Support/tivoli/tsm/client/ba/bin`. Use the `sudo` command to run the script.

Alternately, you can complete the following steps instead of using the script:

### Procedure

1. Move the following folders to the trash:
  - o `/Applications/IBM Spectrum Protect`
  - o `/Library/Application Support/tivoli`
2. Remove the following symbolic links:
  - o `/usr/bin/dsmc`
  - o `/usr/bin/dsmcad`
  - o `/usr/bin/dsmadm`
  - o `/usr/bin/dsmtrace`
  - o `/usr/bin/dsmagent`
  - o `/usr/lib/libxmlutil-6.2.0.dylib`
  - o `/usr/lib/libtsm620xerces-c1_6_0.dylib`
3. Optional: Remove the log files and options files if you do not want to preserve them. The uninstall process leaves them on disk so your settings are retained in case you reinstall the product later.

The backup-archive client might have created log files in these locations:

- a. `/Library/Logs/tivoli`
- b. `~/Library/Logs/tivoli`

The client option files (`dsm.opt` and `dsm.sys`) are typically saved in the following locations:

- a. /Library/Preferences/Tivoli Storage Manager
- b. ~/Library/Preferences/Tivoli Storage Manager

Solaris

## Installing the Oracle Solaris x86\_64 client

You can install the IBM Spectrum Protect™ Oracle Solaris x86\_64 backup-archive client from the product installation media.

### Before you begin

Starting in IBM Spectrum Protect Version 8.1.0, the Oracle Solaris backup-archive client is available only on the Oracle Solaris x86\_64 platform. The backup-archive client is no longer available on the Oracle Solaris SPARC platform; only the IBM Spectrum Protect API is available on Oracle Solaris SPARC. For information about how to install the Solaris SPARC API, see [Installing the Oracle SPARC API](#).

### About this task

If a previous version of the backup-archive client is installed, remove it before you install a new version. For information about removing previous Solaris client packages, see [Uninstalling the Oracle Solaris x86\\_64 client](#).

The IBM Spectrum Protect installation administration file (tsmadmin) is used in place of the default administration file (/var/sadm/install/admin), so that you are not asked about `setuid`, `setgid`, or superuser permission during installation. If you want to use the default administration file, remove the `-a ./tsmadmin` option from the commands that are shown, and answer the questions about `setuid`, `setgid`, or superuser permission during installation with `Y`.

Table 1. Installation package names and descriptions

Package	Package Name	Package Description
IBM® Global Security Kit (GSKit) 64 bit	gsk8cry64.pkg and gsk8ssl64.pkg	Contains the IBM GSKit that provides Secure Sockets Layer (SSL) 64-bit data encryption between the IBM Spectrum Protect client and server.
IBM Spectrum Protect application programming interface (API)	TIVsmCapi.pkg	Contains the IBM Spectrum Protect 64-bit API shared library and samples.
Backup-archive client	TIVsmCba.pkg	<p>Contains the following 64-bit components:</p> <ul style="list-style-type: none"> <li>• Backup-archive client (command-line and GUI)</li> <li>• Administrative client (command-line)</li> <li>• Web backup-archive client</li> </ul> <p>Note:</p> <ol style="list-style-type: none"> <li>1. TCP/IP and Shared memory are supported as communication methods.</li> <li>2. The web client is a part of the backup-archive client package and cannot be installed without it.</li> </ol>

This installation procedure can be used to install new distributions or updates from downloaded installation media. The downloaded files that you use to install the client might be compressed. Depending on the package file format, either copy or extract the files to disk and use these instructions to install the components.

You can download the appropriate package file from one of the following websites:

- Download the client package from [Passport Advantage](#) or [Fix Central](#).
- For the latest information, updates, and maintenance fixes, go to the [IBM Support Portal](#).

Install the packages in the order shown; some packages depend on the presence of others. For example, GSKit is a prerequisite of the API, and the API is a prerequisite of the backup-archive client package.

## Procedure

---

1. Log in as the root user.
2. Mount the volume that you are installing from.
3. Change to the directory where the packages are stored.
4. The IBM GSKit; it is a prerequisite of the IBM Spectrum Protect API package. Install GSKit by using the following commands:

```
pkgadd -n -a ./tsmadmin -d ./gsk8cry64.pkg gsk8cry64
pkgadd -n -a ./tsmadmin -d ./gsk8ssl64.pkg gsk8ssl64
```

Note: On Solaris 10, these commands install the 64-bit GSKit in the global zone and in all running non-global zones. To install the client in a sparse-root, non-global zone only, GSKit must first be installed in the global zone. On Solaris 11, the packages are only installed in the zone where these commands are run.

5. Use the following command to install the IBM Spectrum Protect API:

```
pkgadd -n -a ./tsmadmin -d ./TIVsmCapi.pkg TIVsmCapi
```

Note: On Solaris 10, this command installs the IBM Spectrum Protect 64-bit API in the global zone and in all running non-global zones. If you want to install it in the global zone only, use the `-G` parameter of the `pkgadd` command. On Solaris 11, the API is only installed in the zone where this command is run.

6. Use the following command to install the backup-archive client:

```
pkgadd -n -a ./tsmadmin -d ./TIVsmCba.pkg TIVsmCba
```

Note: On Solaris 10, this command installs the backup-archive client components in the global zone and in all running non-global zones. If you want to install them in the global zone only, use the `-G` parameter of the `pkgadd` command. On Solaris 11, the client components must be only installed in the zone where this command is run.

## Results

---

Important: For a Solaris 10 sparse root non-global zone, the `/usr` file system is normally mounted as read-only (LOFS) from the global zone, and the following conditions apply:

- If the client is not installed in the global zone, a warning message appears at the end of the installation. The message asks the global administrator to create the required links that are provided as part of the warning messages.
- If the client is already installed in the global zone, creation of these links is not necessary. The links are already present and they are pointing to the correct executable files and libraries.

### Related concepts:

Configure the IBM Spectrum Protect client

Solaris

## Uninstalling the Oracle Solaris x86\_64 client

---

You can uninstall all the packages that are related to IBM Spectrum Protect™ Oracle Solaris x86\_64 client, including the command-line, GUI, web GUI, and administrative client components.

## About this task

---

Important: Make sure that you uninstall the packages in the specified order.

The IBM Spectrum Protect installation administration file (`tsmadmin`) is used in place of the default administration file (`/var/sadm/install/admin`), so that you are not prompted for questions about `setuid`, `setgid`, or superuser permission during installation. If you want to use the default administration file, remove the `-a ./tsmadmin` option from the following commands and answer the questions about `setuid`, `setgid`, or superuser permission during installation with `y`.

## Procedure

---

1. Enter the following command to uninstall the backup-archive client:

```
pkgrm -n -a ./tsmadmin TIVsmCba
```

This command uninstalls all of the components of the backup-archive client (command-line, GUI, web client, and the administrative client). You cannot uninstall individual components of this package (for example, the command-line client).

**Note:** If one or more language messages packages are installed in Version 7.1.2 or earlier clients, remove them before you remove the API package. Enter the following command as the root user:

```
pkgrm -n -a ./tsmadmin TIVsmClCs TIVsmClDe TIVsmClEs TIVsmClFr \  
TIVsmClHu TIVsmClIt TIVsmClJa TIVsmClKo \  
TIVsmClPl TIVsmClPt TIVsmClRu TIVsmClSc TIVsmClTc
```

2. Enter the following command to uninstall the IBM Spectrum Protect API:

```
pkgrm -n -a ./tsmadmin TIVsmCapi
```

The API cannot be removed if the backup-archive client is installed. The backup-archive client must be removed first.

3. Enter the following commands to uninstall the GSKit:

```
pkgrm -n -a ./tsmadmin gsk8ssl64  
pkgrm -n -a ./tsmadmin gsk8cry64
```

Solaris

## Installing the Oracle SPARC API

You can install the IBM Spectrum Protect™ Oracle Solaris SPARC API from the product installation media.

### About this task

If a previous version of the API installed, remove it before you install a new version. For information about removing previous Solaris API packages, see [Uninstalling the Oracle Solaris SPARC API](#).

The IBM Spectrum Protect installation administration file (tsmadmin) is used in place of the default administration file (/var/sadm/install/admin), so that you are not asked about `setuid`, `setgid`, or superuser permission during installation. If you want to use the default administration file, remove the `-a ./tsmadmin` option from the commands that are shown, and answer the questions about `setuid`, `setgid`, or superuser permission during installation with `y`.

Table 1. Installation package names and descriptions

Package	Package Name	Package Description
IBM® Global Security Kit (GSKit) 64 bit	gsk8cry64.pkg and gsk8ssl64.pkg	Contains the IBM GSKit that provides Secure Sockets Layer (SSL) 64-bit data encryption between the IBM Spectrum Protect API and server.
IBM Spectrum Protect application programming interface (API)	TIVsmCapi.pkg	Contains the IBM Spectrum Protect 64-bit API shared library and samples.

This installation procedure can be used to install new distributions or updates from downloaded installation media. The downloaded files that you use to install the client might be compressed. Depending on the package file format, either copy or extract the files to disk and use these instructions to install the components.

You can download the appropriate package file from one of the following websites:

- Download the client package from Passport Advantage or Fix Central.
- For the latest information, updates, and maintenance fixes, go to the IBM Support Portal.

Install the packages in the order shown.

### Procedure

1. Log in as the root user.
2. Mount the volume that you are installing from.
3. Change to the directory where the packages are stored.

4. The IBM GSKit; it is a prerequisite of the IBM Spectrum Protect API package. Install GSKit by using the following commands:

```
pkgadd -n -a ./tsmadmin -d ./gsk8cry64.pkg gsk8cry64
pkgadd -n -a ./tsmadmin -d ./gsk8ssl64.pkg gsk8ssl64
```

Note: On Solaris 10, these commands install the 64-bit GSKit in the global zone and in all running non-global zones. To install the API in a sparse-root, non-global zone only, GSKit must first be installed in the global zone. On Solaris 11, the packages are only installed in the zone where these commands are run.

5. Use the following command to install the IBM Spectrum Protect API:

```
pkgadd -n -a ./tsmadmin -d ./TIVsmCapi.pkg TIVsmCapi
```

Note: On Solaris 10, this command installs the IBM Spectrum Protect 64-bit API in the global zone and in all running non-global zones. If you want to install it in the global zone only, use the -G parameter of the pkgadd command. On Solaris 11, the API is only installed in the zone where this command is run.

## Results

---

Important: For a Solaris 10 sparse root non-global zone, the `/usr` file system is normally mounted as read-only (LOFS) from the global zone, and the following conditions apply:

- If the API is not installed in the global zone, a warning message appears at the end of the installation. The message asks the global administrator to create the required links that are provided as part of the warning messages.
- If the API is already installed in the global zone, creation of these links is not necessary. The links are already present and they are pointing to the correct executable files and libraries.

### Related concepts:

Configure the IBM Spectrum Protect client

Solaris

## Uninstalling the Oracle Solaris SPARC API

---

You can uninstall all the packages that are related to IBM Spectrum Protect™ Oracle Solaris SPARC API.

### About this task

---

Important: Make sure that you uninstall the packages in the specified order.

The IBM Spectrum Protect installation administration file (`tsmadmin`) is used in place of the default administration file (`/var/sadm/install/admin`), so that you are not prompted for questions about `setuid`, `setgid`, or superuser permission during installation. If you want to use the default administration file, remove the `-a ./tsmadmin` option from the following commands and answer the questions about `setuid`, `setgid`, or superuser permission during installation with `y`.

### Procedure

---

1. Enter the following command to uninstall the IBM Spectrum Protect API:

```
pkgrm -n -a ./tsmadmin TIVsmCapi
```

2. Enter the following commands to uninstall the GSKit:

```
pkgrm -n -a ./tsmadmin gsk8ssl64
pkgrm -n -a ./tsmadmin gsk8cry64
```

AIX

Linux

Mac OS X

Solaris

## Software updates

---

Software updates might periodically be made available by IBM® for download.

For the latest information, updates, and maintenance fixes, see the IBM Support Portal for IBM Spectrum Protect™.

Windows

# Windows backup-archive client installation overview

You can install the IBM Spectrum Protect™ Windows backup-archive client from the installation media.

## Before you begin

Before you begin a Windows client installation, ensure that the system that you want to install the client on meets the client requirements. Then, determine the type of installation that you need to perform, and follow the steps in the appropriate procedure.

For the hardware and software requirements for the Windows client, see technote 1197133.

- **Windows** Windows client installation might require a reboot  
As part of the Windows client installation process, one or more Microsoft C++ redistributable packages are installed, if they are not already installed on the Windows workstation. These packages can also be automatically updated by the Windows Update service. If the packages are updated, the update can cause the system to reboot when you start the Windows client installation program.
- **Windows** Installation procedures  
The procedure that you follow to install the IBM Spectrum Protect Windows backup-archive client depends on the type of installation that you want to perform.
- **Windows** Troubleshooting problems during installation (Windows)  
If you are upgrading from a previous version of the backup-archive client and there are client services running (for example, Client Acceptor or Scheduler), you might see an error during the installation.
- **Windows** Software updates  
Software updates might periodically be made available by IBM® for download.

### Related concepts:

**Windows** Automatic backup-archive client deployment

### Related tasks:

**Windows** Creating and modifying the client options file

Starting a web client session

**Windows**

## Windows client installation might require a reboot

As part of the Windows client installation process, one or more Microsoft C++ redistributable packages are installed, if they are not already installed on the Windows workstation. These packages can also be automatically updated by the Windows Update service. If the packages are updated, the update can cause the system to reboot when you start the Windows client installation program.

The reboot that is triggered if the C++ redistributable packages are updated can occur, even under any of the following conditions:

- An automatic client deployment pushes a client upgrade to a node, and the client or the scheduler sets the AUTODEPLOY=NOREBOOT option.
- A manual installation or upgrade of the client is started.
- A client silent installation is started, even if the options to suppress reboot prompts, and the client reboot itself, are set.

Additionally, because the Microsoft Visual Studio C++ redistributable package is a shared Windows component, other applications that have dependencies on the package might be stopped or restarted by Windows as part of the installation or upgrade of the C++ redistributable package. Schedule client installations and upgrades during a maintenance window when other applications will not be adversely affected if they are stopped or restarted when the C++ redistributable package is installed. Monitor other applications after the client is installed to see whether there are any applications that were stopped and not restarted.

**Windows**

## Installation procedures

The procedure that you follow to install the IBM Spectrum Protect™ Windows backup-archive client depends on the type of installation that you want to perform.

Procedures are provided for each of the following installation types:

Installation type	Installation description

Installing the Windows client for the first time	Describes how to install the Windows backup-archive client for the first time. This procedure presumes that the Windows computer that you are installing the client on has never had a previous version of the client installed on it before.
Upgrading the Windows client	Describes how to upgrade an earlier version of the Windows backup-archive client to this latest version.
Reinstalling the Windows client	Describes how to reinstall the Windows backup-archive client, if you uninstalled it.
Silent installation	Describes how to install the Windows backup-archive client silently, without user interaction during the installation procedure.
Repairing, modifying, or uninstalling the Windows client	Describes how to add or remove features from an installed backup-archive client (modify), replace damaged files or missing registry keys (repair), or uninstall the Windows backup-archive client.

- **Windows** Installing the Windows client for the first time  
Complete this procedure to install the Windows backup-archive client for the first time.
- **Windows** Upgrading the Windows client  
You can upgrade an earlier version of the IBM Spectrum Protect Windows backup-archive client to Version 8.1.2. Your previous configuration settings are preserved, where it is possible to do so. However, enhancements that are in the latest version of the client can deprecate or prohibit the use of options that were available in earlier versions of the client.
- **Windows** Reinstalling the Windows client  
If you uninstall the Version 8.1.2 Windows client, you can reinstall it if you need to.
- **Windows** Silent installation  
The backup-archive client installation program supports silent, unattended installations.
- **Windows** Modifying, repairing, or uninstalling the Windows client  
You can modify, repair, or uninstall an existing Windows client.

#### Windows

## Installing the Windows client for the first time

Complete this procedure to install the Windows backup-archive client for the first time.

### Before you begin

If you have an earlier version of the Windows backup-archive client that is already installed on a node and you want to upgrade it to Version 8.1.2, see Upgrading the Windows client.

**Important:** You must know the host name or IP address of the IBM Spectrum Protect server, the port number that the server listens on for client communications, and the communications method to use when the client communicates with the server. Obtain this information from your IBM Spectrum Protect server administrator before you start this procedure.

### Procedure

1. Download the appropriate package file from one of the following websites.
  - o Download the client package from Passport Advantage or Fix Central.
  - o For the latest information, updates, and maintenance fixes, go to the IBM Support Portal.
2. Install the product by using the compressed installation file that you download from Passport Advantage®.
  - a. Copy the downloaded compressed installation package to a local disk or to a network-accessible share. Be sure to extract the installation files to an empty directory.
  - b. To extract the installation files to the same directory, double-click the compressed installation package.
  - c. By default, the uncompressed files are stored in the current disk drive, in the `download_directory\TSMClient` directory. If the installation program detects files from another client installation attempt in this directory, you are prompted about whether to overwrite the old files. If you receive this prompt, enter **A** to overwrite the existing files; this selection ensures that only the files from the current installation are used.
  - d. Double-click the `spinstall.exe` file to start the client installation program.
3. Select a language to use for this installation and click OK.
4. If the installation wizard indicates that one or more Microsoft C++ redistributable files must be installed, click Install. These files are needed to run the Windows client.
5. On the IBM Spectrum Protect client welcome screen, click Next to begin installing the client software.



6. Accept the default installation directory by clicking Next, or specify a different installation directory. The default installation directory is C:\Program Files\Tivoli\TSM.
7. Select the installation type: Typical or Custom.

Option	Description
<b>Typical</b>	A typical installation installs the following components: <ul style="list-style-type: none"> <li>○ The backup-archive client GUI files (needed to use the Java™ GUI)</li> <li>○ The backup-archive client web files (needed to use the web client)</li> <li>○ The client API files (as needed by your client and operating system)</li> </ul>
<b>Custom</b>	A custom installation installs the same files as a typical installation. However, you can choose to install the following optional components: <ul style="list-style-type: none"> <li>○ The API SDK files (only needed if you are developing applications that work with the backup-archive client)</li> <li>○ The Administrative Client command-line files (required to remotely run administrator functions on the IBM Spectrum Protect server)</li> </ul>

8. Click Next, then click Install.
9. When the installer completes the installation, click Finish.
10. Verify the installation. Click Start > All Programs > IBM Spectrum Protect. The client components that you installed are shown in the list of IBM Spectrum Protect startable programs. The administrative command-line client, backup-archive command-line client, and the backup-archive GUI are the only components that are displayed in this list. The administrative command-line client is only shown if you perform a custom installation and you include the administrative command-line client. If you installed other components, such as the API Runtime and SDK, they are not shown in this list.
11. Click Backup-Archive GUI to start the client GUI. The Client Options File Configuration Wizard starts. Click Next to start the wizard.
12. On the Options File Task screen, select Create a new options file and click Next.
13. On the Client Node Name screen, specify a node name. A node name uniquely identifies your node to the IBM Spectrum Protect server. The default node name is the short host name of the Windows computer that you are installing the client on. Accept the default node name or specify a new node name. Click Next.
14. On the IBM Spectrum Protect Client/Server Communications screen, specify the communications method to use when the client communicates with the server and click Next. This information must be provided to you by your IBM Spectrum Protect server administrator. If you are not sure what to select, accept the default setting (TCP/IP). If the default setting does not work when the client attempts to connect to the server, contact the server administrator to determine which communications method to specify.
15. On the TCP/IP Options screen, specify the server address and port information that your IBM Spectrum Protect administrator provided to you. In the Server Address field, specify the IP address or fully qualified domain name of the IBM Spectrum Protect server. In the Port Number field, specify the port number that the server listens on for client communications. The default port number is 1500. Click Next.
16. The Recommended Include/Exclude List screen contains a list of system files and directories that are typically included, or excluded from client operations. The excluded files are typically not required to restore your system. You can select or clear all default selections. Alternatively, you can use the Shift and Ctrl keys to selectively include objects. To facilitate the installation process, click Select All; you can add or remove files from this list later, if you want to. Click Next.
17. The Common File Exclusion Selection screen provides a default list of file extensions that you can exclude from client operations. The file extensions that are provided in this list are typically large files, like graphics or multimedia extension. These files consume server disk space but they might not be required to restore critical data. Click Select All to exclude all of the default file extensions. Alternatively, you can use the Shift and Ctrl keys to selectively choose which extensions to exclude from client operations. Click Clear All to clear any extensions that you selected. You can modify these extensions later if you want to. Click Next.
18. The Domains for Backup screen specifies the default file systems and objects to include in client operations for incremental and image backups.
  - a. To configure the default file systems for incremental backups, in the Backup Type field, select Incremental. By default, Back up all local file systems is selected. If you do not want to back up all local file systems as the default action during incremental backups, clear this option and individually select the file systems to include. You can override the default selection when you initiate an incremental backup operation.
  - b. To configure the default file systems for image backups, in the Backup Type field, select Image. By default, Back up all local file systems is selected. If you do not want to back up all local file systems as the default action during image backups, clear this option and individually select the file systems to include. You can override the default selection when you initiate an image backup operation.
  - c. Click Next.
19. On the Confirm and apply your configuration screen, click Apply. You might be prompted to enter a user ID and password to log on to the IBM Spectrum Protect server. The user ID defaults to the node name that you specified in step 13.

20. You can accept the default user ID or specify a different user ID. Specify the password that you will use when you log on to the server. Click Login. What happens next depends on whether the IBM Spectrum Protect server is configured for open or closed registration.

Option	Description
<b>Server is configured for open registration (IBM Spectrum Protect server V8.1.1, V8.1.0, V7.1.7 or earlier)</b>	<p>The Register New Node screen prompts you for contact information and it prompts you again for the password.</p> <p>Adding text to the Contact Information field is optional, but suggested; specify your name.</p> <p>Re-enter your password, twice, in the two Password fields. If the password that you enter and confirm in these Password fields does not match what you previously specified in the Login into an IBM Spectrum Protect server screen, the password that you specify and confirm here becomes the password that is required to log on to the server.</p> <p>Click Register to register this node on the server.</p> <p>Click Finish. The graphical user interface opens and is ready for use. You can also start any of the other installed client components from the Start menu.</p>
<b>Server uses closed registration</b>	<p>Click Finish. Provide the information that you specified in the client configuration wizard to your IBM Spectrum Protect server administrator. Provide the administrator with the following information:</p> <ul style="list-style-type: none"> <li>o The node name that you specified.</li> <li>o The user ID and password that you entered.</li> <li>o Your contact information, such as your name, email address, and phone number, so the administrator can contact you after your node and user information is registered on the server.</li> </ul> <p>After the administrator registers your node, you can start any of the installed client components from the Start menu.</p>

**Related concepts:**

Troubleshooting problems during installation (Windows)

Windows

## Upgrading the Windows client

You can upgrade an earlier version of the IBM Spectrum Protect™ Windows backup-archive client to Version 8.1.2. Your previous configuration settings are preserved, where it is possible to do so. However, enhancements that are in the latest version of the client can deprecate or prohibit the use of options that were available in earlier versions of the client.

### Before you begin

Wait for any in-progress backup-archive client tasks (backup, restore, archive, retrieve) to complete before you upgrade a client node.

### About this task

To upgrade to the Version 8.1.2 Windows client, install the Version 8.1.2 Windows client; you do not need to uninstall previously installed client software first. The Version 8.1.2 client installation program preserves your current client options and settings (in dsm.opt), and it does not overwrite or delete the dsmerror.log, dsmsched.log, and dsmwebcl.log files, if you install the new client into the same directory that was used by the previous installation.

The Logical Volume Snapshot Agent (LVSA) component was deprecated in IBM Spectrum Protect Version 6.4. If you previously had LVSA configured as your snapshot provider, install the Version 8.1.2 client, and then configure it to use the Microsoft Volume Shadow Copy Service (VSS) as the snapshot provider in the new installation. If LVSA was installed, your client reboots after the upgrade installation completes, to allow for the removal of LVSA entries from the registry.

The installation program stops any client services that are running before it upgrades the client software. If you prefer, you can manually stop the services by using the control panel or command line. Table 1 shows the stoppable services, and the names to look for in the Control Panel > Administrative Tools > Services list, so you can stop them with the Control Panel. The table also provides the commands to stop them from a command prompt or a script.

Note: The service names that are shown in the table are the default names that are set by the installation program. You can change some of these service names when you configure the services by using one of the configuration wizards on the Utilities > Setup Wizard menus. If you change the service name, record the name that you specify and use that name to stop the services.

Table 1. Stoppable services

Control panel display name	Command-line procedure
TSM Journal Service	<code>net stop "tsm journal service"</code>
TSM Client Acceptor	<code>net stop "tsm client acceptor"</code>
TSM Client Scheduler	<code>net stop "tsm client scheduler"</code>
Remote Client Agent	<code>net stop "tsm remote client agent"</code>

Complete the following steps to upgrade an earlier version of the Windows backup-archive client to Version 8.1.2:

## Procedure

- Download the appropriate package file from one of the following websites.
  - Download the client package from Passport Advantage or Fix Central.
  - For the latest information, updates, and maintenance fixes, go to the IBM Support Portal.
- Install the product by using the compressed installation file that you download from Passport Advantage®.
  - Copy the downloaded compressed installation package to a local disk or to a network-accessible share. Be sure to extract the installation files to an empty directory.
  - To extract the installation files to the same directory, double-click the compressed installation package.
  - By default, the uncompressed files are stored in the current disk drive, in the *download\_directory*\TSMClient directory. If the installation program detects files from another client installation attempt in this directory, you are prompted about whether to overwrite the old files. If you receive this prompt, enter **A** to overwrite the existing files; this selection ensures that only the files from the current installation are used.
  - Double-click the spinstall.exe file to start the client installation program.
- Select a language to use for this installation and click OK.
- If you are prompted to install one, or more, Microsoft C++ redistributable files, the prompt indicates that your node does not have the C++ files that are required by the Windows backup-archive client. Click Install to install the files and continue with the client installation; or, click Cancel to end the installation process.
- The backup-archive client installation program starts. On the Welcome screen, click Next to begin installing the new client software.
- Accept or change the default installation directory.
- Select the installation type: Typical or Custom.

Option	Description
<b>Typical</b>	A typical installation installs the following components: <ul style="list-style-type: none"> <li>The backup-archive client GUI files (required to use the Java™ GUI)</li> <li>The backup-archive client web files (required to use the web client)</li> <li>The client API files (as needed by your client and operating system)</li> </ul>
<b>Custom</b>	A custom installation installs the same files as a typical installation. However, you can choose to install the following optional components: <ul style="list-style-type: none"> <li>The API SDK files. These files are only needed if you are developing applications that work with the backup-archive client.</li> <li>The administrative client command line files. These files are needed if you want to run administrator functions on the IBM Spectrum Protect server.</li> </ul>

- Click Next, then click Install.
- When the installer completes the installation, click Finish.
- Verify the installation. Click Start > All Programs > IBM Spectrum Protect. The client components that you installed are shown in the list of IBM Spectrum Protect startable programs. This list includes only the administrative command-line client, backup-archive command-line client, or the backup-archive GUI. The other installable components (the API Runtime and SDK files) do not display in this list.
- Click the Backup-Archive GUI entry in the startable programs list.
  - When prompted, type your user ID and password and click Login.
  - After the GUI starts, click Help > About IBM Spectrum Protect. Verify that the version shown is Version 8.1.2.

## What to do next

Your previous configuration settings are preserved in the `dsm.opt` file. If you previously used LVSA as the snapshot provider, warning messages are displayed when the command-line client is started. The messages provide instructions to edit the `dsm.opt` file and remove the LVSA options. Removing the unused options is not required, but removing options that have no affect or are not used, can facilitate troubleshooting. If you are using the GUI, the messages are not displayed, but they are logged in the `dsmerror.log` file, which is in the client installation directory, in the `baclient` directory. Messages are issued when any of the following options are included in `dsm.opt`. Some of these options are valid for VSS, and if they are, the messages are displayed and logged only if they contain parameters that are specific to LVSA.

- `snapshotcachelocation`
- `snapshotfsidleretries`
- `snapshotproviderimage`
- `snapshotproviderfs`
- `snapshotcachesize`

You can set VSS options on the Snapshot tab in the Preferences Editor. They can also be set by running the online image support and open file support configuration wizards. To use the wizards, start the GUI and click Utilities > Setup Wizard. Select the wizards that you want to run, click Next, and follow the prompts to make your selections.

**Related concepts:**

Troubleshooting problems during installation (Windows)

Windows

## Reinstalling the Windows client

---

If you uninstall the Version 8.1.2 Windows client, you can reinstall it if you need to.

### About this task

---

If you reinstall the Windows client into the same directory that it was installed in before, the previous configuration information is detected by the installation program. Because the previous configuration information is detected, the installation process is the same as an upgrade installation; follow the steps in [Upgrading the Windows client to reinstall the Windows client](#).

If you do not want to preserve the old configuration information, you can remove it. For information about thoroughly removing client settings and files, see the IBM® developerWorks® article, [How to completely remove the Backup-Archive client from Microsoft Windows](#)

If you do completely remove all configuration settings and later decide to reinstall the Windows client, follow the steps in [Installing the Windows client for the first time](#). That procedure is the appropriate installation procedure to follow if you reinstall the software into a different directory, or if you reinstall the software on a system that contains no previous configuration information.

Windows

## Silent installation

---

The backup-archive client installation program supports silent, unattended installations.

Note: The Microsoft Visual C++ 2010 and 2012 redistributable packages are required to use the backup-archive client. The graphical installation program installs these packages for you. If you are silently installing the client by using `MSIEXEC`, you must separately install the Microsoft Visual C++ 2010 and 2012 redistributable packages. The packages can be installed before or after the silent installation of the client is completed, but they must be installed before you use the backup-archive client. Use the following executable files to install the C++ 2010 and 2012 redistributable packages. In the paths that are shown, the *dir* text string represents the drive and directory where you saved the files when you extracted them from the installation package.

Windows executable files for installing C++ redistributable packages

`dir\ISSetupPrerequisites\{270b0954-35ca-4324-bbc6-ba5db9072dad}` (contains MS 2010 x86 C++ Runtime - `vcredist_x86.exe`)

`dir\ISSetupPrerequisites\{BF2F04CD-3D1F-444e-8960-D08EBD285C3F}` (contains MS 2012 x86 C++ Runtime - `vcredist_x86.exe`)

`dir\ISSetupPrerequisites\{7f66a156-bc3b-479d-9703-65db354235cc}` (contains MS 2010 x64 C++ Runtime - `vcredist_x64.exe`)

`dir\ISSetupPrerequisites\{3A3AF437-A9CD-472f-9BC9-8EEDD7505A02}` (contains MS 2012 x64 C++ Runtime - `vcredist_x64.exe`)

To install a predefined (custom) dsm.opt file, use the following instructions before you begin the silent installation.

- Place the customized copy of the dsm.opt file in the ...\\CONFIG directory that is located within the installation image, for example:
  - C:\\tsm\_images\\TSMClient\\Program Files 64\\Tivoli\\TSM\\configThe file must be named *dsm.opt*.
- The installation program copies the predefined dsm.opt file to the ..\\BACLIENT directory when BOTH of the following conditions are met:
  - dsm.opt does NOT exist in the ..\\BACLIENT directory. The installation program does not copy over an existing dsm.opt file.
  - dsm.opt exists in the ..\\CONFIG directory of the installation image, as described earlier.

To silently install the C++ redistributables or the backup-archive client, you must turn off User Account Control (UAC).

To turn off UAC, use either the Windows Control Panel or the MSCONFIG utility.

- To turn off UAC by using the Control Panel, go to the Control Panel and find User Account Control settings, then set the notification level to Never Notify.
- To turn off UAC by using the MSCONFIG utility, open a command prompt window and enter msconfig. Select the User Account Control settings tool, and set the notification level to Never Notify.

After you install the C++ redistributables and the Windows client, remember to turn on UAC.

The C++ redistributables require elevated privileges to install them. Open a command prompt window as follows:

1. Click Start Menu > All Programs > Accessories > Command Prompt.
2. Right-click the Command Prompt icon to view the properties.
3. Click Run as administrator.
4. Click Continue in the permission window.
5. Start the product installation by using the command prompt window.

Silently installing C++ redistributables

Run the following command twice. Run it first from the directory where the C++ 2010 vcredist\_x86.exe file is stored. Then, run it again from the directory where the C++ 2012 vcredist\_x86.exe file is stored.

```
vcredist_x86.exe /install /quiet /norestart /log logfilename
```

For more information about the vcredist\_x86.exe command, run the following command:

```
vcredist_x86.exe /?
```

Run the following command twice. Run it first from the directory where the C++ 2010 vcredist\_x64.exe file is stored. Then, run it again from the directory where the C++ 2012 vcredist\_x64.exe file is stored.

```
vcredist_x64.exe /install /quiet /norestart /log logfilename
```

For more information about the vcredist\_x86.exe command, run the following command:

```
vcredist_x64.exe /?
```

Install the Windows backup-archive client. UAC must still be turned off. If it is not turned off, turn off UAC now. Open a command prompt that has elevated privileges.

1. Click Start Menu > All Programs > Accessories > Command Prompt.
2. Right-click the Command Prompt icon to view the properties.
3. Click Run as administrator.
4. Click Continue in the permission window.
5. Start the Windows backup-archive client silent installation by using the command prompt window. Use the following instructions to silently install the Windows client and API.

Silent installation of the Windows client

When you place a customized version of the msixec command (which calls the Microsoft Software Installer) in a script or batch file, you can perform installations on multiple Windows systems. The following example is a sample command to install the backup-archive command-line client, client GUI, web client, API, and Administrative command-line client. You might need to customize this example to run correctly on your system. Although the command is physically spread across multiple lines in the following example, enter it on a single command line.

```
msiexec /i "Z:\tsm_images\TSMClient\IBM Tivoli Storage Manager Client.msi" RebootYesNo="No"
REBOOT="Suppress" ALLUSERS=1 INSTALLDIR="C:\Program Files\Tivoli\Tsm"
ADDLOCAL="BackupArchiveGUI,BackupArchiveWeb,Api64Runtime, AdministrativeCmd"
TRANSFORMS=1033.mst /qn /l*v "C:\log.txt"
```

The descriptions of the silent installation parameters are as follows:

**msiexec**

Starts the Microsoft Software Installer (MSI) program.

**/i**

Installs the specified source package (replace with /x to uninstall the package).

**"Z:\tsm\_images\TSMClient\IBM Tivoli Storage Manager Client.msi"**

Specifies the complete path to the source package. The Z drive is shown in this example. Specify the drive letter for the disk drive, in your configuration, that contains the installation image.

**RebootYesNo="No" REBOOT="Suppress"**

Under certain conditions, a system reboot might be necessary for the installation to complete successfully. This option causes the installation program to not reboot the system if circumstances would otherwise cause the reboot to occur. While this option is convenient, use it with caution because suppressing the reboot might cause the program to behave in an unpredictable manner. The most common reason that a reboot is required is if the installation was an upgrade to an existing backup-archive client, and the installation was performed while the client programs were running. Therefore, shut down all backup-archive client programs and services before you begin the installation.

**ALLUSERS=1**

Specifies that the package is for all users. This option is required.

**INSTALLDIR="C:\Program Files\Tivoli\TSM"**

Specifies the destination path. If you already installed this product or a previous version of this product on your workstation, use the current installation directory as the destination path for this package.

**ADDLOCAL="BackupArchiveGUI,BackupArchiveWeb,Api64Runtime"**

Specifies the features to install. Specify all the components on a single line within quotation marks, separated by commas, with no spaces before or after the commas. The installable client features are shown in the following table:

Windows client features	Feature description
BackupArchiveGUI	Graphical user interface
BackupArchiveWeb	Backup-archive web client
Api64Runtime	API Runtime
ApiSdk	API SDK
AdministrativeCmd	Administrative Command Line

**TRANSFORMS=1033.mst**

Specifies which language transform to use. The following language transforms are available:

Transform	Language
1028.mst	CHT Traditional Chinese
1029.mst	CSY Czech
1031.mst	DEU German
1033.mst	ENG English
1034.mst	ESP Spanish
1036.mst	FRA French
1038.mst	HUN Hungarian
1040.mst	ITA Italian
1041.mst	JPN Japanese
1042.mst	KOR Korean
1045.mst	PLK Polish
1046.mst	PTB Portuguese
1049.mst	RUS Russian

Transform	Language
2052.mst	CHS Simplified Chinese

/qn

Specifies to install the product silently.

/l\*v "C:\log.txt"

Specifies verbose logging and the name and location of the log file.

The installation process creates the IBM Spectrum Protect™ folder in the programs folder of the Windows Start menu. You can start the backup-archive client by clicking one of the icons in this folder.

**Related concepts:**

Troubleshooting problems during installation (Windows)



## Modifying, repairing, or uninstalling the Windows client

You can modify, repair, or uninstall an existing Windows client.

### About this task

Use the Windows control panel to modify, repair, or uninstall the Windows client.

### Procedure

1. Click Start > Control Panel > Uninstall a program.
2. Select IBM Spectrum Protect™ Client in the list of installed programs.
3. Select the function that you want to perform: Repair, Change, or Uninstall.

O p t i o n	Description
R e p a i r	<p>Wait for any in-progress backup-archive client tasks to completed before you repair the Windows client.</p> <p>This option repairs an existing Windows client installation. If you select Repair, the files installed by the installation program are examined to determine whether they have somehow become corrupted. If a file is determined to be corrupted, the repair option attempts to replace it from the saved installation image. The repair option also repairs missing program short cuts and icons, missing files, and registry keys.</p>
C h a n g e	<p>Wait for any in-progress backup-archive client tasks to completed before you modify the Windows client.</p> <p>This option modifies an existing installation. If you select Change, the next screen that is displayed shows Modify as the option for changing installed programs. If you already installed the client and you need to add or remove components, click Change, and select Modify. Choose the icon next to the feature that you want to install or remove and select the appropriate action from the drop-down list. For example, if you selected a typical installation when you installed the client, the administrative client command line interface files are not installed. If you decide that a node needs this interface, select the icon next to Administrative Client Command Line Files and click the This feature will be installed on local hard drive option.</p> <p>Note: This option achieves the same effect as upgrading the client. The difference is that you bypass the initial steps and the installation process begins with the last installation type that you selected. If you want to change the installation type, you can click Back, and select the new installation type; then complete the information as you are prompted for it. Use the information that is provided in Upgrading the Windows client (start at step 7) if you have questions about a prompt.</p>

Option	Description
Uninstall	<p>Wait for any in-progress backup-archive client tasks to completed before you uninstall the Windows client.</p> <p>This option uninstalls the Windows client program. It does not remove any client services. It also does not remove log files, or other items that were created when you configured or used the client. Most of these artifacts remain in the installation directory (Program Files\Tivoli\TSM directory), but they can exist anywhere on the disk, depending on what you chose for the installation directory and other options. This option also does not remove files that were copied to the local disk if you extracted the installation files from a compressed distribution file.</p> <p>Leaving these artifacts on disk is not a problem if you want to reinstall the client in the future. However, if you want to more thoroughly remove the client and related files and settings, see the wiki article <a href="#">How to completely remove the Backup-Archive client from Microsoft Windows</a>.</p> <p>The installation program stops any client services that are running before it uninstalls the software. If you want to stop the services yourself, type the following commands at a command prompt window:</p> <ul style="list-style-type: none"> <li>o net stop "tsm journal service"</li> <li>o net stop "tsm client acceptor"</li> <li>o net stop "tsm client scheduler"</li> <li>o net stop "tsm remote client agent"</li> </ul> <p>You can also use the Control Panel to stop these services. Their display names match the name used on the command line.</p> <p>Note: The service names shown here are the default names that are set by the installation program. You can change some of these service names when you configure the services using one of the configuration wizards on the Utilities &gt; Setup Wizard menus. If you change the service name, record the name that you specify and use that name to stop the services.</p> <p>If you want to remove any of these services without uninstalling the client, perform the following steps:</p> <ol style="list-style-type: none"> <li>a. Click Start &gt; All Programs &gt; IBM Spectrum Protect &gt; Backup-Archive GUI.</li> <li>b. Click Utilities &gt; Setup Wizard.</li> <li>c. Select and run the wizard for each service that you want to remove. The setup wizard options can also remove the configuration information for online image support and open file support.</li> </ol>

Windows

## Troubleshooting problems during installation (Windows)

If you are upgrading from a previous version of the backup-archive client and there are client services running (for example, Client Acceptor or Scheduler), you might see an error during the installation.

If there are other IBM Spectrum Protect™ client services running on any account (for example, Client Acceptor or Scheduler), you might see a request to reboot the system during installation. You must stop all instances of the IBM Spectrum Protect client on all accounts before starting the installation.

You might see the following error during installation:

```
Error 1303. The installer has insufficient privileges to access this directory:
(Install Drive):\Program Files\Tivoli\TSM\baclient\plugins. The installation
cannot continue. Log on as an administrator or contact your system administrator.
```

When this error occurs, you must stop the installation. After stopping the installation process, the previous version is no longer installed. Stop the client services and retry the installation process.

Windows

## Software updates

Software updates might periodically be made available by IBM® for download.

For the latest information, updates, and maintenance fixes, see the IBM Support Portal for IBM Spectrum Protect™.



## Installing the client management service to collect diagnostic information

You can install IBM Spectrum Protect™ client management services to collect diagnostic information about the backup-archive client. The client management service makes the information available to the IBM Spectrum Protect Operations Center for basic monitoring capability.

### About this task

After you install the backup-archive client, install the client management service on the same computer so that the IBM Spectrum Protect server administrator can view diagnostic information from the Operations Center.

For installation instructions and more information about the client management service, see [Collecting diagnostic information with IBM Spectrum Protect client management services](#).

## Configuring backup-archive clients

You can configure the backup-archive client to use many of the available client features. Information for configuring the backup-archive client is provided.

- **Configure the IBM Spectrum Protect client**  
After installing the backup-archive client, you must configure it before performing any operations.
- **Getting started**  
Before you can use the IBM Spectrum Protect backup-archive client, you must learn how to start a GUI or command-line session, and how to start the client scheduler automatically. You can also learn about other commonly used tasks.

#### Related concepts:

Installing the IBM Spectrum Protect backup-archive clients (UNIX, Linux, and Windows)

#### Related tasks:

Back up and restore data with backup-archive clients

Archive and retrieve data with backup-archive clients

Schedule operations for backup-archive clients

#### Related reference:

Backup-archive client options and commands

## Configure the IBM Spectrum Protect client

After installing the backup-archive client, you must configure it before performing any operations.

**AIX** | **Linux** | **Solaris** | **Mac OS X** If you are upgrading the backup-archive client, it is unnecessary to reconfigure the scheduler, web client, or other configuration settings. If the `dsm.opt` and `dsm.sys` files used by the previous client installation are available in the default installation directory or the directory or file pointed to by the `DSM_CONFIG` and `DSM_DIR` environment variables, the client accesses these files for configuration information.

**Windows** If you are upgrading the backup-archive client, it is unnecessary to reconfigure the scheduler, web client, or other configuration settings. If the `dsm.opt` file used by the previous client installation is available in the default installation directory or the directory or file pointed to by the `DSM_CONFIG` and `DSM_DIR` environment variables, the client accesses this file for configuration information.

Some configuration tasks are required, while other tasks are optional. The following configuration tasks are required:

- **Mac OS X** | **AIX** | **Linux** | **Solaris** Creating and modifying the client system-options file
- **Windows** Creating and modifying the client options file
- Register your workstation with a server

The following configuration tasks are optional:

- **AIX** | **Linux** | **Solaris** Creating a default client-user options file
- **AIX** | **Linux** | **Solaris** Creating a customized client user-options file

- **AIX** **Linux** **Solaris** Environment variables
- **Windows** Create a shared directory options file
- **Windows** Creating multiple client options files
- **Windows** Environment variables
- **Windows** Configuring the language for displaying the Java GUI
- **Windows** Configuring the web client on Windows systems
- **AIX** **Linux** **Mac OS X** **Solaris** Configuring the web client on AIX, Linux, Mac, and Solaris systems
- Configuring the scheduler
- **Windows** Configuring the journal engine service
- **Windows** Configuring online-image backup support
- **Windows** Configuring Open File Support
- Creating an include-exclude list
- **Linux** **Windows** Configuring parallel backups of VMware virtual machines. See Parallel backups of virtual machines
- **Mac OS X** **AIX** **Linux** **Solaris** UNIX and Linux client root and authorized user tasks  
An authorized user is any non-root user who has read and write access to the stored password (TSM.sst file), or anyone who knows the password and enters it interactively. Authorized users use the passworddir option to define the directory where their copy of the password file is saved.
- **AIX** **Linux** **Mac OS X** **Solaris** Enable non-root users to manage their own data  
To enable non-root users to use the backup-archive client to manage their own data, the system administrator must complete steps in addition to the normal configuration steps to setup first-time Authorized users for non-root users.
- Client options file overview  
You set (specify) client options and values in a client options file. Client options can also be set on the server in a *client option set*. Client options that are set on the server in a client option set override client options that are set in the client options file.
- **Windows** Environment variables  
Generally, setting the environment variables is an optional task. Setting them makes it more convenient for you to use the command line.
- **Mac OS X** **AIX** **Linux** **Solaris** Environment variables  
Generally, setting the environment variables is an optional task. Setting these variables makes it more convenient for you to use the command line.
- **Windows** Configuring the language for displaying the Java GUI  
You can select the language to use for displaying the backup-archive client Java GUI.
- Web client configuration overview  
The IBM Spectrum Protect web client provides remote management of a client node from a web browser. The procedures to configure the web client vary depending on which operating system is on the client node.
- Configuring the scheduler  
Your IBM Spectrum Protect administrator can schedule the client to perform tasks automatically. For scheduled events to occur on the client, you must configure the client scheduler to communicate with the IBM Spectrum Protect server.
- **Mac OS X** **AIX** **Linux** **Solaris** Start the client scheduler  
This task guides you through the steps to schedule events using the GUI and the command-line client.
- **Windows** Starting the client scheduler  
To start the client scheduler, use the Services Control Panel or the **net start** command.
- Configuring IBM Spectrum Protect client/server communication across a firewall  
In most cases, the IBM Spectrum Protect server and clients can work across a firewall.
- **AIX** **Linux** **Solaris** **Windows** Configuring IBM Spectrum Protect client/server communication with Secure Sockets Layer  
Secure Sockets Layer (SSL) allows industry standard SSL-based secure communications between the IBM Spectrum Protect client and server.
- **AIX** **Windows** **Linux** Configure your system for journal-based backup  
You must install and configure the journal daemon (Linux) or journal engine service (Windows) before you can perform journal-based backups.
- Client-side data deduplication  
*Data deduplication* is a method of reducing storage needs by eliminating redundant data.
- Automated client failover configuration and use  
The backup-archive client can automatically fail over to a secondary server for data recovery when the IBM Spectrum Protect server is unavailable. You can configure the client for automated failover or prevent the client from failing over. You can also determine the replication status of your data on the secondary server before you restore or retrieve the replicated data.
- **Linux** **Windows** Configuring the client to back up and archive Tivoli Storage Manager FastBack data  
Before you can back up or archive Tivoli® Storage Manager FastBack client data, you must complete configuration tasks.

- **Windows** Configuring the backup-archive client to protect FastBack client data  
You can configure the backup-archive client to protect FastBack client data by using the client configuration wizard.
- **Mac OS X** | **AIX** | **Linux** | **Solaris** Cluster environment configuration and use  
The term *cluster* has different meanings in different environments. It can mean highly available, high performance, load balancing, grid computing, or some combination of all of these terms.
- **Windows** Configuring the backup-archive client in a cluster server environment  
You can install the backup-archive client software locally on each node of a Microsoft Cluster Server (MSCS) or Veritas Cluster Server (VCS) environment cluster.
- **Windows** Configuring online-image backup support  
If the online image feature is configured, the backup-archive client performs a snapshot-based image backup, during which the real volume is available to other system applications.
- **Windows** Configuring Open File Support  
You configure Open File Support (OFS) after you install the Window client.
- **AIX** AIX configuration considerations prior to performing snapshot-based file backups and archives  
If you are configuring your IBM Spectrum Protect AIX® client to perform snapshot-based file backups and archives, there are some items that you need to consider.
- **Linux** | **Windows** Configuring NetApp and IBM Spectrum Protect for snapshot difference incremental backups  
You must configure the NetApp file server connection information to run the snapshot difference incremental backup command on the backup-archive client. You must also use the set password command to specify the file server host name, and the password and user name that is used to access the file server.
- Register your workstation with a server  
Before you can use IBM Spectrum Protect, you must set up a node name and password and your node must be registered with the server.
- Creating an include-exclude list  
If you do not create an include-exclude list, the backup-archive client considers all files for backup services and uses the default management class for backup and archive services.

**Mac OS X** | **AIX** | **Linux** | **Solaris**

## UNIX and Linux client root and authorized user tasks

An authorized user is any non-root user who has read and write access to the stored password (TSM.sth file), or anyone who knows the password and enters it interactively. Authorized users use the passworddir option to define the directory where their copy of the password file is saved.

Table 1 shows the tasks that can and cannot be performed by the root user, authorized users, and other users.

Table 1. Tasks for root users and authorized users

Task	Root user	Authorized user
Log on to the IBM Spectrum Protect™ server, using an LDAP server to authenticate credentials.	Yes	Yes
Register new nodes with the IBM Spectrum Protect server (if registration is set to open on the server).	Yes	Yes

Task	Root user	Authorized user
Set or re-create the IBM Spectrum Protect password for client workstations	Yes	Yes
Backup	Yes Note: The IBM Spectrum Protect administrator can specify an option on either the Register Node or Update Node commands to specify who is allowed to back up data for a node. Setting BACKUPINITiation to root restricts backups so that only root or authorized users can back up files on a node. Setting BACKUPINITiation to all allows any user to back up data on a node. For information about these commands and options, see the IBM Spectrum Protect server documentation.	Yes, if you have read permission, regardless of ownership
Restore	Yes; when restoring to a new location or the same location, file permission and ownership are preserved	Yes; however, the operating system prevents writing to the same location if the file has read only permission. When restoring to the same location, file permissions and ownership are preserved. When restoring to a different location, the permissions of the restored file are preserved but the ownership changed to the current user.
Archive	Yes	Yes, if you have read permission, regardless of ownership
Retrieve	Yes. When retrieving to a new location or to the same location, file permissions and ownership are preserved.	Yes. However, the operating system prevents writing to the same location if the file has read only permission. Ownership of all retrieved objects is changed to the current user.
Client scheduler	Yes	Yes, if not using the client acceptor daemon.  You must be root to manage the client acceptor daemon. A non-root authorized user can use the scheduler (dsmc sched).
Grant user access to files on the IBM Spectrum Protect server	Yes	Yes
Delete IBM Spectrum Protect server file spaces	Yes, if the node is granted backup or archive delete authority by the IBM Spectrum Protect server administrator	Yes, if the node is granted backup or archive delete authority by the IBM Spectrum Protect server administrator

On Mac OS X systems, a system administrator is any user that is allowed to administer the system. You can check your account type using the System Preferences > Accounts tool. System Administrators have an account type of Admin.

**Mac OS X** The system administrator is responsible for configuring the backup-archive client so non-administrators can manage their own data. Non-administrators (or non-authorized users) meet the following criteria:

**Mac OS X**

- They do not have a user ID of 0. They are not the root user.
- They have a user account that has not been configured as a system administrator.

**Mac OS X** When a task requires additional authority to complete, you must use the authorization application to start the backup-archive client. This allows the client to run with sufficient system privileges to complete the task. The following table lists the authorization tools to use.

Table 2. Mac OS X authorization tools and associated IBM Spectrum Protect applications

Mac OS X authorization tool	Associated IBM Spectrum Protect application
IBM Spectrum Protect For Administrators	IBM Spectrum Protect StartCad.sh StopCad.sh
sudo	dsmc

AIX Linux Mac OS X Solaris

## Enable non-root users to manage their own data

To enable non-root users to use the backup-archive client to manage their own data, the system administrator must complete steps in addition to the normal configuration steps to setup first-time Authorized users for non-root users.

In addition to the normal configuration steps, the system administrator must complete the following steps to setup Authorized users for non-root users:

1. Add a stanza in the client system-options file, dsm.sys, for the non-root user.
2. In this stanza, use the passworddir option to point to a directory that is owned by the non-root user. The non-root user can then create a file in this passworddir directory.
3. Assign the non-root user with a unique TSM node name.
4. Ensure that an earlier TSM.PWD file that is not owned by the non-root user, does not exist in the passworddir directory. If such a file exists, change ownership of this file to the non-root user or remove the file.
5. Ensure that TSM.KDB, TSM.IDX or TSM.sth files that are not owned by the non-root user, do not exist in the passworddir directory. If such files exist, remove them.

On completion of the steps by the system administrator, the non-root user must complete the following steps:

1. Create a client system-options file, dsm.opt, and use the servername option to specify the stanza name.
2. Ensure that the dsm.opt file can be read by default by the DSM\_CONFIG environment variable. Issue the export DSM\_CONFIG=<dsm.opt> command from a shell command window to check.
3. Run the dsmc q f command to use password files that are pointed to by the passworddir option. If no password files exist, the user is prompted.

- **AIX Linux Mac OS X Solaris** Enabling encryption for backup-archive client users  
If you configure the backup-archive client to encrypt data during backup and archive operations, and if you specify the option to store the encryption key password (encryptkey save), by default, only root and IBM Spectrum Protect™ authorized users can use the stored password to encrypt or decrypt files. Authorized users include any non-root users who have read and write access to the stored password (TSM.sth file), or users who know the password and enter it interactively.

## Client options file overview

You set (specify) client options and values in a client options file. Client options can also be set on the server in a *client option set*. Client options that are set on the server in a client option set override client options that are set in the client options file.

**Windows** On Windows systems, the default client options file is named dsm.opt.

**AIX Linux Mac OS X Solaris** On AIX®, Linux, Mac, and Solaris systems, the default client options file is named dsm.opt. For these operating systems, two files contain backup-archive client options:

- The *client-user options* file. The default name for this file is dsm.opt. For brevity, this file is often called the *client options file*.
- The *client-system options* file. The default name for this file is dsm.sys. The client-system options file is an editable file that identifies the server and communication method, and provides the configuration for backup, archiving, hierarchical storage management, and scheduling. For brevity, this file is often called the *system options file*.

You can create multiple client options files. If your client options file is not named `dsm.opt`, or if `dsm.opt` is not in the default directory, use the `OPTFILE` client option to tell the backup-archive client which file to read the options and parameters from when the backup-archive client is started.

**AIX** | **Linux** | **Mac OS X** | **Solaris** You cannot change the name of the client-system option file. It must be named `dsm.sys`.

You can use a text editor application to directly edit the client options file. You can also set options by using the backup-archive client GUI. In the GUI, select `Edit > Preferences` and use the Preferences Editor to set client options. Options that you set in the Preferences Editor are stored in the client options file. Not all client options can be set by using the Preferences Editor.

**Mac OS X** **Restriction:** For Mac OS X, the client-user options file and client-system options file must be plain text files, encoded as Unicode (UTF-8). By default, TextEdit does not save files as plain text. Select `Format > Make Plain Text` to save the files as plain text files. Select `Unicode (UTF-8)` in the Plain Text Encoding drop down list. Do not add the `.txt` extension when you save the file.

You can use the `query options` command to display all or part of your options and their current settings. This command accepts an argument to specify a subset of options. The default is to display all options.

Some options consist of only the option name, such as `verbose` and `quiet`. You can enter the entire option name, or its abbreviation. For example, you can specify the `verbose` option in either of the following ways:

```
verbose
ve
```

Follow these rules when you add options to your options files:

- You can annotate option settings by adding comments to the options file. Begin each comment with an asterisk (\*) as the first character on the line.
- Do not specify options on a line that contains a comment.
- You can optionally indent options with spaces or tabs, to make it easier to view the options and values that you specify in the file.
- Enter each option on a separate line and enter all parameters for an option on the same line, as shown in the following examples:

**AIX** | **Linux** | **Mac OS X** | **Solaris**

```
domain /home /mfg /planning /mrketing /mgmt
domain / /Volumes/fs2 /Volumes/fs2 /Volumes/fs3 /Volumes/fs4
```

**Windows**

```
domain="c: d:"
domain="ALL-LOCAL -c: -systemstate"
```

- To set an option in this file, enter the option name and one or more blank spaces, followed by the option value.
- Enter one or more blank spaces between parameters.
- The lengths of file and path names in the client options files cannot exceed the following limits:
  - **AIX** | **Linux** | **Mac OS X** | **Solaris** On AIX, Mac OS, and Solaris, the maximum length for a file name is 255 bytes. The maximum combined length of the file name and path name is 1024 characters. The Unicode representation of a character can occupy several bytes, so the maximum number of characters that a file name might contain can vary.
  - **Linux** On Linux, the maximum length for a file name is 255 bytes. The maximum combined length of the file name and path name is 4096 bytes. This matches the `PATH_MAX` that is supported by the operating system. The Unicode representation of a character can occupy several bytes, so the maximum number of characters that comprises a path and file name can vary. The limitation is the number of bytes in the path and file components, which might or might not correspond to an equal number of characters.
  - **Windows** On Windows, a file name cannot exceed 255 bytes. Directory names, including the directory delimiter, are also limited to 255 bytes. The maximum combined length for a file name and path name is 5192 bytes. The Unicode representation of a character can occupy several bytes, so the maximum number of characters that a file name might contain can vary.

File path and file name limits are shown in Table 1.

- For archive or retrieve operations, the maximum length that you can specify for a path and file name, combined, is 1024 bytes.

**Windows**

Table 1. File path and name limits

MBCS encoding	Path name length limits	File name length limits
---------------	-------------------------	-------------------------

MBCS encoding	Path name length limits	File name length limits
1	5192 bytes	255 bytes
2	4092 bytes	127 bytes
3	2728 bytes	85 bytes

**Windows** In the table, MBCS encoding has these meanings:

#### Basic Latin

Standard US English characters, numbers, symbols, and control characters that are traditionally represented in 7-bit ASCII have a 1:1 ratio of bytes to characters.

#### Latin extensions

Latin characters that have tildes, grave or acute accents, and so on, as well as Greek, Coptic, Cyrillic, Armenian, Hebrew, and Arabic characters, typically have a 2:1 ratio of bytes to characters.

#### Chinese, Japanese, Korean, Vietnamese

These characters and other East Asian language characters typically have a 3:1 ratio of bytes to characters.

**Windows** If you update the client options file while a session is active, you must restart the session to pick up the changes. If you use the client GUI setup wizard to make changes, the changes are effective immediately. If you are not using the client acceptor to manage the scheduler, you must also restart the scheduler.

**Mac OS X** **AIX** **Linux** **Solaris** If you update the client-user options file while a session is active, you must restart the session to pick up the changes.

- Mac OS X** **AIX** **Linux** **Solaris** Creating and modifying the client system-options file

The client system-options file is an editable file that identifies the server and communication method, and provides the configuration for backup, archiving, hierarchical storage management, and scheduling.
- Windows** Creating and modifying the client options file

The client options file is an editable text file that contains configuration information for the backup-archive client.
- Mac OS X** **AIX** **Linux** **Solaris** Creating a default client-user options file

A client-user options file stores the backup-archive client processing options. The backup-archive installation program places a sample client-user options file on disk when you install the backup-archive client. A system administrator or root can edit this file to create a default client options file, and makes the file accessible to workstation users who use the backup-archive client. Individual users can create and use their own client options file.
- Mac OS X** **AIX** **Linux** **Solaris** Creating a customized client user-options file

If you want to use different options than those specified in the default client user-options file (dsm.opt), you can create your own client user-options file.
- Windows** Create a shared directory options file

The IBM Spectrum Protect™ server administrator can generate client options files in a shared directory.
- Windows** Creating multiple client options files

You can create multiple client options files if you must work with multiple servers, or find that you need multiple sets of parameters to do back up or archive tasks.

#### Related reference:

Optfile

Query Options

**Mac OS X** **AIX** **Linux** **Solaris**

## Creating and modifying the client system-options file

The client system-options file is an editable file that identifies the server and communication method, and provides the configuration for backup, archiving, hierarchical storage management, and scheduling.

### About this task

Creating and modifying the client system-options file (dsm.sys) is a required task.

The backup-archive client GUI provides a Configuration Wizard that can be used to create basic configuration files and test the connection to the IBM Spectrum Protect™ server. The Configuration Wizard starts automatically if the configuration files are not found when the GUI starts. If you want to modify the configuration files after they are created, click on Setup Wizard from the Tools menu of the GUI.

If you do not use the Configuration Wizard, you can create and modify the client options file manually.

**Mac OS X** For Mac OS X, copy the dsm.sys.smp file to dsm.sys in one of the following locations. The default locations are listed in the order that they are searched.

1. A location identified by the DSM\_DIR environment variable
2. /Library/Application Support/tivoli/tsm/client/ba/bin/
3. /Library/Preferences/Tivoli Storage Manager/

The client uses the first options file that is found. You must use the name dsm.sys for this file. The dsm.sys file is controlled by the system administrator.

**Solaris** For Oracle Solaris systems, copying dsm.sys.smp to dsm.sys is not required. The client options files (dsm.opt and dsm.sys) are automatically created in /usr/bin, if they do not already exist, and they are linked to the client installation directory when you install the client. Note that the files are not removed if you uninstall the client, so you can reuse your settings if you upgrade or reinstall the client.

**Mac OS X** | **AIX** | **Linux** For the other platforms, as the root user, copy the dsm.sys.smp file to dsm.sys and then edit that file to configure your settings. The client looks for dsm.sys in the directory specified by the DSM\_DIR environment variable (if it is set and exported), and then in the installation directory.

**Important:** If you are reinstalling and you want to keep your existing dsm.sys file intact, do not copy the dsm.sys.smp file to dsm.sys.

Use the dsm.sys file to specify one or more servers to contact for services, and communications options for each server. This file can also include authorization options, backup and archive processing options, and scheduling options.

Edit dsm.sys to include the server or servers to which you want to connect. The following is an example of a client system-options file stanza which contains the required options for a server you want users to contact. You can specify options for more than one server:

```
Servername          server_a
COMMethod           TCPip
TCPPort             1500
TCPServeraddress    node.domain.company.com
```

**Important:** If you want to use the web client, you must also specify the passwordaccess=generate option, and log in with the client to save the password.

As the default, your client node contacts the first server identified in the dsm.sys file. You can specify a different server to contact by entering the servername option in your own client user-options file (dsm.opt), or by entering that option with a command.

**AIX** | **Linux** | **Solaris** You can also specify a default server and a migration server (if you have the HSM client installed on your workstation) in your dsm.sys file.

The dsm.sys file can also contain the following option categories:

- Communication options
- Backup and archive processing options
- Restore and retrieve processing options
- Scheduling options
- Authorization options
- Error processing options
- Transaction processing option
- Web client options

You can modify your dsm.sys file using one of the following methods:

- From the client Java™ GUI main window, select Edit > Client Preferences.
- Use your favorite text editor.

**Mac OS X** **Important:** For Mac OS X, the system-options file must be a plain text file, encoded as Unicode (UTF-8). By default, TextEdit does not save files as plain text. Select Format > Make PlainText to save the user-options file as a plain text file. Set the Plain Text Encoding: to Unicode (UTF-8). Do not add the .txt extension.

If you update the dsm.sys file while the client is running, you must restart the process to pick up the changes.

#### **Related concepts:**

Client options file overview



## Creating and modifying the client options file

The client options file is an editable text file that contains configuration information for the backup-archive client.

### About this task

The first time that you start the Windows backup-archive client GUI, the installation program searches for an existing client options file, called `dsm.opt`. If this file is not detected, a client options file configuration wizard starts and prompts you to specify initial client configuration settings. When the wizard completes, it saves the information that you specified in the `dsm.opt` file. By default, the `dsm.opt` file is saved to `C:\Program Files\Tivoli\TSM\baclient`.

The options file must contain the following information to communicate with the server:

- The host name or IP address of the IBM Spectrum Protect™ server.
- The port number that the server listens on for client communications. A default port number is configured by the client options file configuration wizard. You do not need to override this default port number unless your server is configured to listen on a different port.
- Your client node name. The node name is a name that uniquely identifies your client node. The node name defaults to the short host name of the computer that the client is installed on.

Additional client options can be specified, as needed.

Note: Client options can also be set on the server in a *client option set*. Client options that are defined on the server in a client option set override client options that are set in the client options file.

A sample options file is copied to your disk when you install the backup-archive client. The file is called `dsm.smp`. By default, the `dsm.smp` file is copied to `C:\Program Files\Tivoli\TSM\config\`. You can view the contents of this file to see examples of different options and how they are specified. The file also contains comments that explain syntax conventions for include lists, exclude lists, and wildcard use. You can also use this file as a template for your client options file by editing it and saving it as `dsm.opt` in the `C:\Program Files\Tivoli\TSM\baclient` directory.

After the initial client options file is created, you can modify the client options by adding or changing the options as needed. You can modify the `dsm.opt` file in any of the following ways:

- By running the client options file configuration setup wizard
- By using the client preferences editor
- By editing the `dsm.opt` file with a text editor program, such as Notepad

Perform the following steps to modify the client options:

### Procedure

1. Select a method to modify the file.

Option	Description
<b>Setup wizard</b>	<ol style="list-style-type: none"> <li>a. Click Start &gt; All Programs &gt; IBM Spectrum Protect &gt; Backup-Archive GUI.</li> <li>b. Select Utilities &gt; Setup Wizard &gt; Help me configure the Client Options File. On-screen text and online help is available to provide guidance as you navigate through the wizard panels. This client options file configuration wizard offers limited choices and configures only the most basic options.</li> </ol>
<b>Preferences editor</b>	<ol style="list-style-type: none"> <li>a. Click Start &gt; All Programs &gt; IBM Spectrum Protect &gt; Backup-Archive GUI.</li> <li>b. Select Edit &gt; Client Preferences. Select the tabs in the preferences editor to set client options. Specify the options in the dialog boxes, drop down lists, and other controls. Online help is provided. Click the question mark (?) icon to display the help topics for the online help for the tab that you are editing. You can set more options in the preferences editor than you can set in the setup wizard.</li> </ol>

Option	Description
<b>Edit the dsm.opt file</b>	<p>a. Edit the dsm.opt file by using a plain text editor. Each of the options is described in detail in the documentation in Client options reference. This method is the most versatile way to set client options because not all options can be set in the client options file configuration wizard or in the preferences editor.</p> <p>b. To comment out a setting, insert an asterisk (*) as the first character on the line that you want to comment out. Remove the asterisk to make the commented option active.</p>

2. Save the changes.
  - a. Changes made in the client options file configuration wizard and in the preferences editor are saved and recognized by the client when the wizard completes, or when you exit the preferences editor.
  - b. If you edit the client options file with a text editor while the client is running, you must save the file and restart the client so the changes are detected.

Mac OS X    AIX    Linux    Solaris

## Creating a default client-user options file

A client-user options file stores the backup-archive client processing options. The backup-archive installation program places a sample client-user options file on disk when you install the backup-archive client. A system administrator or root can edit this file to create a default client options file, and makes the file accessible to workstation users who use the backup-archive client. Individual users can create and use their own client options file.

### Before you begin

You must be root or a system administrator to complete this procedure.

### About this task

Creating a default client-user options file is an optional task.

By default, the client-user options file is named dsm.opt, and the file contains the following types of client options:

- Backup and archive processing options
- Restore and retrieve processing options
- Scheduling options
- Format options
- Command processing options
- Authorization options
- Error processing options
- Transaction processing option
- Web client options

For Mac clients, the client installation program places a sample client-user options file named dsm.opt.smp in /Libraries/Preferences/Tivoli Storage Manager/. This directory is the same directory that the installation program places a sample client-system option file (dsm.sys.smp) in.

For AIX® and Linux clients, the client installation program places a sample client-user options file named dsm.opt.smp in the default client installation directory. This directory is the same directory that the installation program places a sample client-system option file (dsm.sys.smp) in.

For Oracle Solaris clients, the installation program places an initial client-user options file named dsm.opt in the /usr/bin directory. This directory is the same directory that the installation program places a sample client-system option (dsm.sys) file in.

For all client operating systems, the following procedure instructs you to edit the sample client-user options file and save it with the default name, dsm.opt. You can save the file with a different name or path, if you want to, but if you change the file name or if you move the file from the default installation directory, you must use either of the following methods to specify the path and name of the client-user options file:

- Set the DSM\_CONFIG environment variable to indicate the path and file name of the client-user option file (dsm.opt). Set the DSM\_DIR environment variable to indicate the path and file name of the client-system option file (dsm.sys). For more information about the environment variables, see Set processing environment variables.
- Specify the backup-archive client optfile option to specify the path and file name of the client-user options file.

Note: All node users must have read access to the disk location where you store the client-user options file.

## Procedure

---

1. Change to the directory that contains the sample client-user options file.
2. Copy the file to dsm.opt.
3. Add options for your node to the dsm.opt file. Use either of the following methods to set the client-user options:
  - o Edit dsm.opt with a text editor to add the options that are needed in the node.  
Note: On Mac OS X, the dsm.opt file must be saved as a plain text file and use Unicode (UTF-8) as the encoding scheme. By default, TextEdit does not save files as plain text. To save dsm.opt, in TextEdit, select Format > Make Plain Text. In the Plain Text Encoding drop-down list, select Unicode (UTF-8). Do not add the .txt extension to the file name.
  - o Set client options by using the preferences editor. In the backup-archive client GUI, select Edit > Client Preferences and select the options that you want to configure. The preferences editor updates the client configuration files, dsm.opt, and dsm.sys if you add, change, or remove options. If you update the dsm.opt file while the backup-archive client is running, you must restart the backup-archive client so the updates are recognized.

The preferences editor uses the DSM\_DIR environment variable to locate the client-system options file (dsm.sys) and the DSM\_CONFIG environment variable to locate the client user-options file (dsm.opt). If you want dsm.opt to be in a non-default location, set DSM\_CONFIG before you start backup-archive client and then use the preferences editor to set the options. The preferences editor queries the server for options on the server, but cannot change the server options file.

### Related concepts:

Processing options

Set processing environment variables

### Related tasks:

Creating and modifying the client system-options file

Mac OS X | AIX | Linux | Solaris

## Creating a customized client user-options file

---

If you want to use different options than those specified in the default client user-options file (dsm.opt), you can create your own client user-options file.

### About this task

---

You can set all of the options that can be set in the default user options file. Creating a customized client user-options file (dsm.opt) is an optional task. To create or modify a client user-options file, use the following method:

## Procedure

---

1. Contact the IBM Spectrum Protect™ administrator on your workstation to determine the location of the sample client user-options file dsm.opt.smp, and to get the TCP/IP address of the backup server you are connecting to and the port it listens on.
2. Copy dsm.opt.smp to your home directory as dsm.opt, or a new file name of your choice. Store your client user-options file in any directory to which you have write access.
3. Set the DSM\_CONFIG environment variable to point to your new client user-options file.
4. Edit your dsm.opt file as appropriate for your system or use the Preferences Editor by selecting Edit > Client Preferences from the backup-archive client GUI.

## Results

---

Once you have created an options file, you can use the following steps to edit your options file from the GUI.

1. Open the Edit menu and select Client Preferences.
2. Make any necessary changes, then click OK to save those changes.

**Mac OS X** Important: For Mac OS X, the system-options file must be a plain text file, encoded as Unicode (UTF-8). By default, TextEdit does not save files as plain text. Select Format > Make PlainText to save the user-options file as a plain text file. Set the Plain Text Encoding drop-down list selection to Unicode (UTF-8). Do not add the .txt extension.

### Related concepts:

## Create a shared directory options file

---

The IBM Spectrum Protect™ server administrator can generate client options files in a shared directory.

Windows clients can access the shared directory, and use the files there to create their own client options file.

Creating a shared directory options file is an optional root user or authorized user task.

## Creating multiple client options files

---

You can create multiple client options files if you must work with multiple servers, or find that you need multiple sets of parameters to do back up or archive tasks.

### About this task

---

Suppose you want to back up your files to one server (`server a`), and archive files to another (`server b`). Instead of editing the `dsm.opt` file each time you want to connect to a different server, create two options files. For example, create the options files `a.opt` for `server a`, and `b.opt` for `server b`.

### Procedure

---

Use one of the following methods to specify or use a different client options file:

- Replace the `dsm.opt` file with the appropriate options file before you start the backup-archive client.  
For example, issue the following commands to copy the `a.opt` file to `dsm.opt` and then start the backup-archive client GUI:

```
copy a.opt dsm.opt
dsm
```

- Start the backup-archive client from the command line and use the `optfile` option to specify the options file that you want to use.  
For example:

```
dsm -optfile=b.opt
```

- Define the `DSM_CONFIG` environment variable to specify the options file to use before you start a backup-archive client session.  
For example:

```
SET DSM_CONFIG=C:\Program Files\Tivoli\TSM\baclient\b.opt
```

### What to do next

---

If you are running the backup-archive client from the command line, the `DSM_DIR` and `DSM_LOG` environment variables might also need to be configured as follows:

- Define the `DSM_DIR` environment variable to point to the directory where all other executable files reside:

```
SET DSM_DIR=C:\Program Files\Tivoli\TSM\baclient
```

- Define the `DSM_LOG` environment variable to point to the directory where `dsmerror.log` resides:

```
SET DSM_LOG=C:\Program Files\Tivoli\TSM\baclient
```

Note: The directory path where the client executable files are located must be included in the `PATH` environment variable or you must enter a fully qualified path.

## Environment variables

---

Generally, setting the environment variables is an optional task. Setting them makes it more convenient for you to use the command line.

## About this task

---

You must set the environment variables if you need to run in either of the following environments:

- You want to invoke the backup-archive client from a directory other than the directory where the backup-archive client is installed.
- You want to specify a different options file for the backup-archive client, the administrative client, or both.

Note: You can also specify an alternate client options file for the command-line client (not the administrative client) using the **optfile** option.

You need to set four environment variables:

### PATH

This is the default search path the operating system uses to locate executable files. Set this to include the fully qualified paths of the client installation directories.

### DSM\_CONFIG

Set this environment variable to the fully qualified path and file name of the client options file.

### DSM\_DIR

Set this environment variable to the directory where the client message file dsc\*.txt is located.

### DSM\_LOG

Set this environment variable to the directory where the log files should reside.

Ensure that the environment variables meet the following guidelines:

- Include the directory where the executable files (for example, dsm.exe) reside in the current PATH environment variable. If you accepted the default installation directory using the C: drive, you can set this from a command prompt by typing:

```
SET PATH=C:\Program Files\Tivoli\TSM\baclient
```

- Specify the fully-qualified path name of your client options file (dsm.opt) using the DSM\_CONFIG environment variable:

```
SET DSM_CONFIG=C:\Program Files\Tivoli\TSM\baclient\dsm.opt
```

- Define the DSM\_DIR environment variable to point to the directory where the client message file dsc\*.txt is located:

```
SET DSM_DIR=C:\Program Files\Tivoli\TSM\baclient
```

### Related reference:

Optfile

[AIX](#) | [Linux](#) | [Mac OS X](#) | [Solaris](#)

## Environment variables

---

Generally, setting the environment variables is an optional task. Setting these variables makes it more convenient for you to use the command line.

- [Mac OS X](#) | [AIX](#) | [Linux](#) | [Solaris](#) Set language environment variables  
The backup-archive client automatically detects the language of the system locale and displays in that language.
- [Mac OS X](#) | [AIX](#) | [Linux](#) | [Solaris](#) Set processing environment variables  
Some circumstances require you to set environment variables to ensure that IBM Spectrum Protect™ applications can locate the files that are needed to perform client operations, and that applications can create log files that record events and errors that occur during client operations.
- [Mac OS X](#) | [AIX](#) | [Linux](#) | [Solaris](#) Set Bourne and Korn shell variables  
Enter the environment variables in the `.profile` file (Korn shell) or `.bash_profile` file (Bourne shell) in your `$HOME` directory.
- [Mac OS X](#) | [AIX](#) | [Linux](#) | [Solaris](#) Set C shell variables  
For the C shell, add the `DSM_CONFIG`, `DSM_LOG` and `DSM_DIR` variables to the `.cshrc` file in your `$HOME` directory.
- [Mac OS X](#) | [AIX](#) | [Linux](#) | [Solaris](#) Set API environment variables  
If you installed the IBM Spectrum Protect API, set the following environment variables.

[AIX](#) | [Linux](#) | [Solaris](#)

## Set language environment variables

---

The backup-archive client automatically detects the language of the system locale and displays in that language.

For example, a French operating system displays the backup-archive client in French by default. If the backup-archive client cannot load the French message catalog, it defaults to the English (United States) language. For example, if the client is running in an unsupported language and locale combination, such as French/Canada or Spanish/Mexico, the client defaults to English (United States).

You can use the LANG environment variable to specify the language for the UNIX and Linux clients.

Note: The operating system locale, the terminal character set, and the file name character set encoding must match in order for files names to be displayed or entered correctly.

To set the LANG environment variable to French, type the following statement:

```
export LANG=fr_FR
```

Note:

- This task does not apply to Mac OS X.
- To display the IBM Spectrum Protect™ help browser menus in the language of your current locale, ensure that the NLSPATH environment variable in the `/etc/profile` file contains the following path:

```
NLSPATH=/usr/dt/lib/nls/msg/%L/%N.cat:$NLSPATH
export NLSPATH
```

If the locale of the backup-archive client is the same as the character encoding of the file names, all of those files are backed up or restored correctly. If you are running in any single-byte character set (SBCS), then all file names are valid and are backed up or restored by the backup-archive client.

If you are running in a DBCS or UTF-8 locale, file names that are composed of characters that are not valid in the DBCS or UTF-8 locale cannot be entered on the backup-archive client command line. The files might be skipped when you run a backup where a wildcard ("\*") specification is used. If files are skipped, here is an example of the error message that is issued:

```
ANS4042E Object name '/testData/en_US_files/file3?'
contains one or more unrecognized characters and is not valid.
```

If all directories and files are not created with the same locale, then run your scheduled backups by using a single-byte character set locale. This action ensures that files are not skipped because the file names contain characters that are not defined in the current locale. When you restore files, run in the same locale that matches the locale encoding of the file name.

For example, file names that consist of Japanese characters might contain invalid multibyte characters if they are displayed in a Chinese locale. These files are not backed up and are not shown by the graphical user interface. If such files are found during backup, the `dsmerror.log` file lists the skipped files.

Tip: When you use the backup-archive client scheduling mode to back up a whole system, set the LANG environment variable to `en_US` (or some other SBCS language) to avoid skipped files.

Mac OS X | AIX | Linux | Solaris

## Set processing environment variables

---

Some circumstances require you to set environment variables to ensure that IBM Spectrum Protect™ applications can locate the files that are needed to perform client operations, and that applications can create log files that record events and errors that occur during client operations.

You must set the environment variables in any of the following circumstances:

- You want to invoke the backup-archive client from a directory other than the directory where the backup-archive client is installed
- You want to specify a different options file for the backup-archive client, the administrative client, or both.
- You do not want log files to be written to the default installation directory.

Tip: You can also specify an alternate client options file for the command-line client (not the administrative client) using the `optfile` option.

There are four environment variables you can set which affect backup-archive client processing:

## PATH

Includes the directory where the executable file for the client executables (dsmc, dsmadm, dsmj) resides.

## DSM\_DIR

Specifies the directory where the executable file for the client executables (dsmc, dsmadm, dsmj) the resource files, and the dsm.sys file reside. You cannot specify the root (/) directory for DSM\_DIR.

Refer to the installation section for your operating system to find the default installation directory information.

**Mac OS X** | **AIX** | **Linux** | **Solaris** When you request an image backup, image restore, snapshot-based file backup, NAS backup, or NAS restore, the client uses the DSM\_DIR environment variable to locate the corresponding plug-in library. If DSM\_DIR is not set, the client looks for the plug-in library in the following directories:

### AIX®

/usr/tivoli/tsm/client/ba/bin/plugins

Oracle Solaris and all Linux clients

/opt/tivoli/tsm/client/ba/bin/plugins

## DSM\_CONFIG

Specifies the fully-qualified path and file name of the client user options file for users who create their own personalized options file. If DSM\_CONFIG is not set, or the client optfile option is not used, the client user options file is expected to satisfy these requirements:

1. The options file must be named `dsm.opt`.
2. For UNIX clients other than Mac OS X, if DSM\_DIR is *not* set, then the file must reside in the default installation directory. If DSM\_DIR is set, then the file must reside in the directory specified by DSM\_DIR.
3. **Mac OS X** For Mac OS X, the file can reside in any of the following locations. These directories are searched in order, and the first option file found is used. `~/Library Preferences/Tivoli Storage Manager`, `/Library Preferences/Tivoli Storage Manager`, or `/Library/Application Support/tivoli/tsm/client/ba/bin`.

Refer to the installation section for your operating system to find the default installation directory information.

## DSM\_LOG

Points to the directory where you want the IBM Spectrum Protect log files to reside. You cannot specify the root (/) directory for DSM\_LOG. The log files contain information about errors and events that occur during processing. The client creates the logs to help the technical support team diagnose severe errors.

Refer to the installation section for your operating system to find the default installation directory information.

**Important:** Set the DSM\_LOG environment variable to name a directory where read-write permissions allow the required write access for the user to create and write to the log file. This prevents log write failures and process termination. Use the `chmod` or `setacl` commands to give the files permissions that allow all client user IDs to read and write them. If the log names are the default names, just set the DSM\_LOG environment variable to point to the directory where they reside. When the client cannot write to the log file, an error message is written to `stderr` and to the `syslog` daemon. The `syslog` daemon must be running and configured to process messages with a priority of `LOG_ERR` for the error message to appear in the system log. Starting and configuring the `syslog` daemon is system specific. Use `man syslogd` command for information about starting the `syslog` daemon. Use `man syslog.conf` for information about configuring the `syslog` daemon.

Note:

1. The `errorlogname` and `schedlogname` options override DSM\_LOG. If you specify the `errorlogname` client option, the file is stored in the directory specified by the `errorlogname` option and not in the location specified by DSM\_LOG. If you specify the `schedlogname` client option, it is written to the directory specified by the `schedlogname` option and not in the location specified by DSM\_LOG.
2. The log files cannot be symbolic links. The client detects any such links, delete the links, then exits the operation. This action prevents the client from overwriting protected data. The affected logs are created as files in a subsequent operation.

To use the backup-archive client Java™ GUI program, you must export the directory where you installed the java binary file. For example, enter the following command:

```
export PATH=$PATH:java_bin_dir
```

where: `java_bin_dir` is the path to the runnable Java binary file in your file system.

### Related reference:

Optfile

## Set Bourne and Korn shell variables

Enter the environment variables in the `.profile` file (Korn shell) or `.bash_profile` file (Bourne shell) in your `$HOME` directory.

The following is an example, where `/home/davehil/dsm.opt` is the path and file name for your client user-options file, and the `/home/davehil` directory is where you want to store the `dsmerror.log` file, executable file, resource files, and `dsm.sys` file.

```
DSM_DIR=/home/davehil
DSM_CONFIG=/home/davehil/dsm.opt
DSM_LOG=/home/davehil
export DSM_DIR DSM_CONFIG DSM_LOG
```

## Set C shell variables

For the C shell, add the `DSM_CONFIG`, `DSM_LOG` and `DSM_DIR` variables to the `.cshrc` file in your `$HOME` directory.

The following is an example, where `/home/davehil/dsm.opt` is the path and file name for your client user-options file, and the `/home/davehil` directory is where you want to store the `dsmerror.log` file, executable file, resource files, and `dsm.sys` file.

```
setenv DSM_DIR /home/davehil
setenv DSM_CONFIG /home/davehil/dsm.opt
setenv DSM_LOG /home/davehil
```

## Set API environment variables

If you installed the IBM Spectrum Protect™ API, set the following environment variables.

**DSMI\_DIR**

Points to your installation directory. The file `dsm.sys` must reside in the directory pointed to by `DSMI_DIR`. This environment variable must be present.

**DSMI\_CONFIG**

Full path name of your own client user-options file (`dsm.opt`).

**DSMI\_LOG**

Path for `dserror.log` (this path cannot be a symbolic link).

Note: End users of applications that are developed with the API can consult the installation directions for that application for special path names or guidelines for options.

For more information about the environment variables, see [Set processing environment variables](#).

For more information about the IBM Spectrum Protect API, see [Developing solutions with the application programming interface](#).

## Configuring the language for displaying the Java GUI

You can select the language to use for displaying the backup-archive client Java™ GUI.

### About this task

The language that is displayed by the backup-archive client Java GUI is defined by the Windows display locale and not the Windows system locale. For example, if the Windows system and input locale is French, but the display locale is Russian, the language that is displayed by the Java GUI is Russian by default, if the language option is not used.

If you want to display the Java GUI in US English or another language, you can override the default display language by specifying the language option.



Tip: The language option does not affect the web client. The web client displays in the language that is associated with the locale of the browser. If the browser is running in a locale that client does not support, the web client is displayed in US English.

## Procedure

Use one of the following methods to configure the language for displaying the Java GUI:

- Add the `language language` option to the client options file (`dsm.opt`). For example, to set the display language to US English, add the following statement:

```
language enu
```

- Complete the following steps in the backup-archive client Java GUI:
  1. In the main window of the Java GUI, click Edit > Client Preferences.
  2. Click the Regional Settings tab.
  3. Click the Language drop-down list and select a language.
  4. Click OK.

### Related reference:

Language

## Web client configuration overview

The IBM Spectrum Protect™ web client provides remote management of a client node from a web browser. The procedures to configure the web client vary depending on which operating system is on the client node.

Beginning with IBM Spectrum Protect Version 8.1.2, you can no longer use the web client to connect to the IBM Spectrum Protect V8.1.2 or later server. However, you can still use the web client to connect to IBM Spectrum Protect V8.1.1, V8.1.0, or V7.1.7 and earlier servers. For more information, see [Using the web client in the new security environment](#).

Backup-archive client options are used to configure web client settings. These options include `httpport`, `managementservices`, `webports`, and `revokeremoteaccess`.

**Windows** On Windows client nodes, a web client setup wizard is provided in the backup-archive client GUI. You can use the setup wizard to configure the web client. The options that you select in the wizard are copied to the client-user options file (`dsm.opt`). You can also add the options directly to the `dsm.opt` file by editing the file and adding the web client options to it.

**AIX** **Linux** **Mac OS X** **Solaris** On AIX®, Linux, Mac, and Solaris client nodes, you add the web client options to the client-systems option file (`dsm.sys`).

To use the web client from the IBM Spectrum Protect Operations Center interface, specify the web client address in the URL parameter of the REGISTER NODE or UPDATE NODE command. The web address must include the DNS name or IP address of the node, and the port number that the web client uses. For example, `http://node.example.com:1581`. Replace this example host name with the IP address or host name of your client node. When you access the web client by using a web browser, enter the same URL syntax in the browser address bar.

All web client messages are written to the web client log file, which is named `dsmwebcl.log`. By default, the `dsmwebcl.log` file and the backup-archive client error log file (`dsmerror.log`) are created in the client installation directory. You can use the `DSM_LOG` environment variable to override the default locations for the error logs. If you do set the `DSM_LOG` environment variable, do not specify the root directory as location for the error logs. You can also use the backup-archive client `errorlogname` option, to change the location of the error log files. If you specify this option, it overrides the `DSM_LOG` environment variable setting.

- **AIX** **Linux** **Mac OS X** **Solaris** Configuring the web client on AIX, Linux, Mac, and Solaris systems  
To configure the web client, edit the client-system options file (`dsm.sys`) to specify the required options, and then start the client acceptor daemon.
- **Windows** Configuring the web client on Windows systems  
On Windows systems, you can configure and start the web client by using a wizard that is available in the backup-archive client GUI, or by using both IBM Spectrum Protect and Windows commands.

### Related concepts:

Web client options

### Related tasks:

**AIX** **Linux** **Mac OS X** **Solaris** Configuring the web client on AIX, Linux, Mac, and Solaris systems

**Windows** Configuring the web client on Windows systems

## Configuring the web client on AIX®, Linux, Mac, and Solaris systems

To configure the web client, edit the client-system options file (`dsm.sys`) to specify the required options, and then start the client acceptor daemon.

### Procedure

1. Set the following options in the `dsm.sys` file: `managedservices webclient schedule` and `passwordaccess generate`.
2. Generate the IBM Spectrum Protect™ password. Enter `dsmc query session`. When you are prompted for credentials, enter the IBM Spectrum Protect user name and password.

**Mac OS X** On Mac OS X systems, you can also generate the password by using the IBM Spectrum Protect Tools for Administrators application. In the application, select IBM Spectrum Protect to start the client.

3. Start the client acceptor daemon. Enter `dsmcad`.

**Mac OS X** On Mac OS X, you can also start the client acceptor daemon with the IBM Spectrum Protect Tools for Administrators application. In the application, select Start the Client Acceptor Daemon.

4. To access the web client from a browser, specify the host name or IP address of the client node in the browser address bar, followed by the web client port number. The default port number is 1581. For example, to access the web client on the node that is named `myserver.example.com`, specify: `http://myserver.example.com:1581`

If you must change the default web client port number, use the backup-archive client `httpport` option to assign a different port number.

### What to do next

After you configure the web client, you can use the IBM Spectrum Protect Operations Center or a browser to backup or restore, or archive or retrieve, data on a node.

**Related concepts:**

Scheduling options

Web client options

**Related tasks:**

Starting a web client session

**Related reference:**

`Httpport`

`Passwordaccess`

**Windows**

## Configuring the web client on Windows systems

On Windows systems, you can configure and start the web client by using a wizard that is available in the backup-archive client GUI, or by using both IBM Spectrum Protect™ and Windows commands.

### Procedure

Choose one of the following methods to configure the Windows web client:

Setup method	Procedure
Setup wizard	<ol style="list-style-type: none"> <li>a. Start the backup-archive client GUI.</li> <li>b. Click Utilities &gt; Setup Wizard.</li> <li>c. Select the Help me configure the Web Client check box.</li> <li>d. Click NEXT and follow the wizard instructions to configure the web client options.</li> </ol>

Setup method	Procedure
<b>Command prompt</b>	<p>a. Set the following options in the dsm.opt file: managedservices webclient schedule and passwordaccess generate.</p> <p>b. Install the client acceptor service by entering the following command:</p> <pre>dsmcutil install cad /name:"TSM CAD" /node:nodename /password:password /autostart:yes</pre> <p>where:</p> <p><i>TSM CAD</i> a name for the service. The default name is TSM Client Acceptor.</p> <p><i>nodename</i> is the name of the client node.</p> <p><i>password</i> is the IBM Spectrum Protect password.</p> <p><i>/autostart:yes</i> indicates that the client acceptor service is started when the operating system starts.</p> <p>Start the service by using the Windows net start command.</p> <p>c. Install the IBM Spectrum Protect remote-client-agent service by entering the following command:</p> <pre>dsmcutil install remoteagent /name:"TSM AGENT" /node:nodename /password:password /partnername:"TSM CAD"</pre> <p>where:</p> <ul style="list-style-type: none"> <li>o <i>TSM AGENT</i> is a name for the remote-client-agent service. The default service name is TSM Remote Client Agent.</li> <li>o <i>nodename</i> is the name of the client node.</li> <li>o <i>password</i> is the IBM Spectrum Protect password.</li> <li>o <i>TSM CAD</i> is the service-partner name. This name must match the service name that you specified when you installed the client acceptor service. The default name is TSM Client Acceptor.</li> </ul> <p>Do not start the TSM Remote Client Agent service from the Control Panel &gt; Administrative Tools &gt; Services view, or by using the net start command. The client acceptor service starts the remote client agent when it is needed.</p>

## What to do next

After you configure the web client, you can use the IBM Spectrum Protect Operations Center or a browser to backup or restore, or archive or retrieve, data on a node.

**Related concepts:**

Scheduling options

Web client options

**Related tasks:**

Starting a web client session

**Related reference:**

Httpport

Passwordaccess

## Configuring the scheduler

Your IBM Spectrum Protect™ administrator can schedule the client to perform tasks automatically. For scheduled events to occur on the client, you must configure the client scheduler to communicate with the IBM Spectrum Protect server.

## About this task

For example, you can automatically back up files at the end of each day or archive some of your files every Friday. This procedure, which is known as central scheduling, is a cooperative effort between the server and your client node. Your administrator associates clients with one or more schedules that are part of the policy domain that is maintained in the server database. The IBM Spectrum Protect administrator defines central scheduling on the server and you start the client scheduler on your workstation. After you start the client scheduler, no further intervention is required.

With client scheduling, you can perform the following tasks:

- Display information about available schedules.
- Display information about work that the schedule completed.
- **Windows** Modify scheduling options in the client options file (dsm.opt).
- **Mac OS X** | **AIX** | **Linux** | **Solaris** Modify scheduling options in the dsm.sys file.

The most effective way to manage the client scheduler is to use the client acceptor service. You can read about a comparison between using the client acceptor and traditional scheduler services to manage the scheduler. You can also learn how to configure the client to use the client acceptor to manage the scheduler.

- Comparison between client acceptor-managed services and traditional scheduler services  
You can use either the client acceptor service or the traditional scheduler service to manage the IBM Spectrum Protect scheduler. A comparison of these methods is provided.
- Configuring the client to use the client acceptor service to manage the scheduler  
One of the most effective ways of managing the client scheduler is to use the client acceptor. You must configure the client to use the client acceptor to manage the scheduler.

## Comparison between client acceptor-managed services and traditional scheduler services

You can use either the client acceptor service or the traditional scheduler service to manage the IBM Spectrum Protect™ scheduler. A comparison of these methods is provided.

The following table shows the differences between the client acceptor-managed services and the default traditional scheduler services methods.

Table 1. Client acceptor-managed services versus traditional scheduler services

Client acceptor-managed services	IBM Spectrum Protect traditional scheduler services
<p>Defined by using the <code>manageservices schedule</code> option and started with client acceptor services.</p> <p><b>AIX</b>   <b>Linux</b>   <b>Mac OS X</b>   <b>Solaris</b> The client acceptor daemon is started with the <code>dsmcad</code> command</p> <p><b>Windows</b> The client acceptor service is started as a Windows service</p>	<p>Started with command <code>dsmc sched</code> command.</p>
<p>The client acceptor service starts and stops the scheduler process as needed for each scheduled action.</p>	<p>Remains active, even after scheduled backup is complete.</p>
<p>Requires fewer system resources when idle.</p>	<p>Requires higher use of system resources when idle.</p>
<p>Client options and IBM Spectrum Protect server override options are refreshed each time the client acceptor services start a scheduled backup.</p>	<p>Client options and IBM Spectrum Protect server override options are only processed after <code>dsmc sched</code> is started.</p>
<p>Cannot be used with <code>SESSIONINITiation=SERVEROnly</code> backups.</p>	<p>You must restart the scheduler process for updated client options to take effect. Important: If you run the client scheduler on the command line, the scheduler does not run as a background service. Tip: Restart the traditional scheduler periodically to free system resources previously used by system calls.</p>

## Configuring the client to use the client acceptor service to manage the scheduler

One of the most effective ways of managing the client scheduler is to use the client acceptor. You must configure the client to use the client acceptor to manage the scheduler.

## Before you begin

---

- If you include files for encryption, ensure that the encryptkey option is set to save in the options file. This option is set by selecting Save Encryption Key Password Locally on the Authorization tab in the preference editor. Setting this option enables unattended scheduled services. If the encryption key was not previously saved, you must run an attended backup of at least one file so that you get the encryption prompt to save the key.
- You cannot use the client acceptor for scheduling when the sessioninitiation option is set to serveronly.

## About this task

---

The client acceptor serves as an external timer for the scheduler. When the scheduler is started, it queries the server for the next scheduled event. The event is either run immediately or the scheduler exits. The client acceptor restarts the scheduler when it is time to run the scheduled event. This action reduces the number of background processes on your workstation and resolves memory retention problems that can occur when the scheduler is run without client acceptor management.

The client acceptor service is also known as the client acceptor daemon.

## Procedure

---

- **AIX | Linux | Mac OS X | Solaris** Complete the following steps to use the client acceptor to manage the client scheduler:
  1. From the backup-archive client GUI, select Edit > Preferences.
  2. Click the Web Client tab.
  3. In the Managed Services Options field, click Schedule. If you also want the client acceptor to manage the web client, click Both option.
  4. Start the client acceptor daemon by running the following command on the command line:

```
dsmcad
```

Tip:

- You can also use the managedservices option in the client system-options file (dsm.sys) to specify whether the client acceptor manages the scheduler.
- If you need the client acceptor to manage the scheduler in polling mode without opening a listening port, use the cadlistenonport option in the dsm.sys file.
- **Windows** Complete the following steps to use the client acceptor to manage the scheduler on the Windows client:
  1. In the backup-archive client GUI, click Utilities > Setup Wizard > Help me configure the Client Scheduler and click Next.
  2. Read the information in the Scheduler Wizard page and click Next.
  3. In the Scheduler Task page, select Install a new or additional scheduler and click Next.
  4. In the Scheduler Name and Location page, specify a name for the client acceptor service that you want to manage the scheduler. Then, select Use the client acceptor to manage the scheduler and click Next.
  5. If the client acceptor is already installed for use by the web client, select that name of the client acceptor from the drop-down list in the Web Service Name page. Otherwise, type the name that you want to assign to this client acceptor. The default name is TSM Client Acceptor. Click Next.
  6. Follow the instructions on the remaining screens to complete the configuration.

Use the following information to help you complete the wizard pages:

- If the sessioninitiation option is set to serveronly in the client options file (dsm.opt), the client configuration wizard and scheduler service might be unable to initiate authentication with the IBM Spectrum Protect™ server. To avoid this problem, ensure that the Contact the IBM Spectrum Protect Server to validate password check box on the IBM Spectrum Protect Authentication page is cleared.
  - For the client acceptor-managed scheduler, select Manually when I explicitly start the service in the Service login options page.
7. Start the client acceptor service from the Services Control Panel, but do not start the scheduler service. The scheduler service is started and stopped automatically by the client acceptor service as needed.

Tip:

- You can also use the managedservices option in the client options file (dsm.opt) to specify whether the client acceptor manages the scheduler.

- If you need the client acceptor to manage the scheduler in polling mode without opening a listening port, use the `cadlistenonport` option in the `dsm.opt` file.
- If you do not use the client acceptor to manage the scheduler, select Automatically when Windows boots in the Service login options window. This setting starts the service automatically when Windows starts so that your schedules are run automatically. Alternatively, you can use the Services Control Panel or the `net start` command to start the Scheduler service.
- You can also use the Scheduler Service Configuration utility (`dsmcutil.exe`) to configure the scheduler. The Scheduler Service Configuration utility must be run from an account that belongs to the Administrator/Domain Administrator group. You can start multiple client scheduler services on your system.

**Related concepts:**

Web client configuration overview  
 Enable or disable scheduled commands  
 Scheduling options

**Related tasks:**

Setting the client scheduler process to run as a background task and start automatically at startup

**Related reference:**

Cadlistenonport  
 Manageservices  
 Sessioninitiation

**AIX** | **Linux** | **Mac OS X** | **Solaris**

## Start the client scheduler

---

This task guides you through the steps to schedule events using the GUI and the command-line client.

- **Mac OS X** | **AIX** | **Linux** | **Solaris** Scheduling events using the command-line client  
 This task guides you through the steps to schedule events using the command-line client.

**Windows**

## Starting the client scheduler

---

To start the client scheduler, use the Services Control Panel or the **net start** command.

### About this task

---

To avoid problems, do not run the client scheduler on the command line. The command line does not run the scheduler as a background service.

When you start the client scheduler, it runs continuously until you close the window, shut down your system, or log out of your system. If you are running the Scheduler Service, the scheduler runs until the system is shutdown or you explicitly stop it using the services control panel.

- **Windows** Scheduling events using the GUI  
 This task guides you through the steps to schedule events using the GUI.

**Related concepts:**

Processing options

## Configuring IBM Spectrum Protect client/server communication across a firewall

---

In most cases, the IBM Spectrum Protect™ server and clients can work across a firewall.

### About this task

---

Every firewall is different, so the firewall administrator might need to consult the instructions for the firewall software or hardware in use.

There are two methods for enabling client and server operations through a firewall:

## Method 1:

To allow clients to communicate with a server across a firewall, the following ports must be opened in the firewall by the firewall administrator:

### TCP/IP port

To enable the backup-archive client, command-line admin client, and the scheduler to run outside a firewall, the port specified by the server option **tcpport** (default 1500) must be opened by the firewall administrator. This port is set on the client and the server using the **tcpport** option. The setting must be the same on the client and server. This allows IBM Spectrum Protect scheduler communications in both *polling* and *prompted* mode, client acceptor-managed schedulers, and regular backup-archive client operations.

**Note:** The client cannot use the port specified by the **tcpadminport** option (on the server) for a client session. That port can be used for administrative sessions only.

### HTTP port

To allow the web client to communicate with remote workstations across a firewall, the HTTP port for the remote workstation must be opened. Use the **httpport** option in the remote workstation client options file to specify this port. The default HTTP port is 1581.

### TCP/IP ports for the remote workstation

The two TCP/IP ports for the remote workstation client must be opened. Use the **webports** option in the remote workstation client options file to specify these ports. If you do not specify the values for the **webports** option, the default zero (0) causes TCP/IP to randomly assign two free port numbers.

### TCP/IP port for administrative sessions

Specifies a separate TCP/IP port number on which the server is waiting for requests for administrative client sessions, allowing secure administrative sessions within a private network.

## Method 2:

For the client scheduler in prompted mode, it is unnecessary to open *any* ports on the firewall. If you set the **sessioninitiation** option to *serveronly*, the client will not attempt to contact the server. *All sessions are initiated by server prompted scheduling* on the port defined on the client with the **tcpclientport** option. The **sessioninitiation** option only affects the behavior of the client scheduler running in the prompted mode.

The IBM Spectrum Protect server must set the SESSIONINITiation parameter on the **register node** and **update node** commands for each node. If the server specifies SESSIONINITiation=*clientorserver*, the default, the client can decide which method to use. If the server specifies SESSIONINITiation=*serveronly*, all sessions are initiated by the server.

Note:

1. If **sessioninitiation** is set to *serveronly*, the value for the **tcpclientaddress** client option must be the same as the value for the **HLAddress** option of the **update node** or **register node** server command. The value for the **tcpclientport** client option must be the same as the value for the **LLAddress** option of the **update node** or **register node** server command.
2. **AIX** | **Linux** | **Mac OS X** | **Solaris** If you set the **sessioninitiation** option to *serveronly*, with the exception of client acceptor-managed schedulers, the command-line client, backup-archive client Java™ GUI, and web client GUI still attempts to initiate sessions, but are blocked by the IBM Spectrum Protect server for nodes that have the **sessioninitiation** option set to *serveronly*.
3. **Windows** If you set the **sessioninitiation** option to *serveronly*, with the exception of client acceptor-managed schedulers, the command-line client, backup-archive client GUI, and web client GUI still attempts to initiate sessions, but are blocked by the IBM Spectrum Protect server for nodes that have the **sessioninitiation** option set to *serveronly*.
4. **Windows** When installing the scheduler using the setup wizard or **dsmcutil**, and the IBM Spectrum Protect server is behind a firewall, the node password will not get stored on the client workstation. As a result, the scheduler service might be unable to authenticate to the server when the server contacts the client to run a schedule. In this case, you can run the scheduler from the command line (**dsmc schedule**), wait until a scheduled operation starts, and enter the password for your node when prompted. After you enter the password for your node, restart the scheduler service. You can also use the following **dsmcutil** command to save the password:

```
dsmcutil updatepw /node:nnn /password:ppp /validate:no
```

If **sessioninitiation** option is set to *serveronly* in your client options file (**dsm.opt**), the client setup wizard and scheduler service is unable to initiate authentication with the IBM Spectrum Protect server. To avoid this problem, when configuring the client scheduler using the setup wizard, ensure that the Contact the IBM Spectrum Protect Server to validate password check box on the IBM Spectrum Protect Authentication page is unchecked.

A similar problem can occur if an encryption key is required for backup operations. In this case, you can run the scheduler from the command line (`dsmc schedule`), wait until a scheduled backup starts, and enter the encryption key when prompted. After the password and encryption key are updated, you must restart the scheduler.

5. When configuring the scheduler on a client workstation for the first time, the scheduler service might be unable to authenticate to the server when the server contacts the client scheduler to run a schedule. This can happen when the **passwordaccess** is set to generate and the IBM Spectrum Protect server is behind a firewall and the encrypted password cannot be locally stored before the scheduler is started. To correct this problem, you need to run the scheduler from the command line (`dsmc schedule`), wait until a scheduled operation starts, and enter the password for your node when prompted.
6. The client cannot prompt for the encryption key password in scheduler mode. If you are using IBM Spectrum Protect data encryption, you must run an initial interactive backup once to set up the encryption key by opening the TCP/IP connection from the client workstation to the server workstation. See **Method 1** for more information about setting up this communication. After the encryption key is set, you can use server-initiated sessions to back up the files using encryption.

If you set the **sessioninitiation** option to *client*, the client initiates sessions with the server (**Method 1**) by communicating on the TCP/IP port defined with the *server* option **tcpport**. This is the default. Server prompted scheduling can be used to prompt the client to connect to the server.

When using IBM Spectrum Protect across a firewall in *prompted* mode, the IBM Spectrum Protect server needs to contact the client. In order to complete this action, some software might need to be installed on the IBM Spectrum Protect server to route the request through the firewall. This software routes the server request through a socks port on the firewall. This method is typically called *socksifying* a system. Proxies are not supported, because they only route a few types of communication protocols (HTTP, FTP, GOPHER). IBM Spectrum Protect communications are not routed by proxies. It is important to note that the client creates a new connection to the IBM Spectrum Protect server when prompted. This means that the firewall configuration discussed above must be in place.

**Related tasks:**

Configuring the scheduler

**Related reference:**

Sessioninitiation

Tcpadminport

Tcpport

Webports

## Configuring IBM Spectrum Protect client/server communication with Secure Sockets Layer

---

Secure Sockets Layer (SSL) allows industry standard SSL-based secure communications between the IBM Spectrum Protect™ client and server.

### About this task

---

The following client components support SSL:

- Command-line client
- Administrative command-line client
- Client GUI
- Client API

Only outgoing client/server connections support SSL. A V8.1.2 client communicating with a down-level servers supports SSL. A V8.1.2 client communicating with a V8.1.2 server must use SSL. Incoming connections (for example, client acceptor, server-initiated schedule connections) do not support SSL. Client-to-client communications do support SSL. Web GUI does not support SSL. The Web GUI is no longer supported when communicating with a V8.1.2 server.

Each IBM Spectrum Protect server that is enabled for SSL must have a unique certificate. The certificate can be one of the following types:

- A certificate that is self-signed by IBM Spectrum Protect.
- A certificate that is issued by a certificate authority (CA). The CA can be from a company such as VeriSign or Thawte, or an internal CA, maintained within your company.



Follow these steps to enable SSL communication with a self-signed certificate:

1. Obtain the IBM Spectrum Protect server self-signed certificate (cert256.arm) Use the cert.arm certificate file when the server is not setup to use Transport Layer Security (TLS) 1.2; otherwise, use the cert256.arm file. The client certificate file must be the same as the certificate file that the server uses.
2. Configure the clients. To use SSL, each client must import the self-signed server certificate.

Use the dsmcert utility to import the certificate.

3. For a disaster recovery of the IBM Spectrum Protect server, if the certificate has been lost, a new one is automatically generated by the server. Each client must obtain and import the new certificate.

For fast path details for communication between a V8.1.2 client and a V8.1.2 server, you can use the SSLACCEPTCERTFROMSERV option to automatically accept a self-signed certificate. See Default security settings for the client (fast path) for details.

Follow these steps to enable SSL communication with a CA-signed certificate:

1. Obtain the CA root certificate.
2. Configure the clients. To use SSL, each client must import the self-signed server certificate.

Use the dsmcert utility to import the certificate.

Tip: After you complete this step, if the server gets a new certificate that is signed by the same CA, the client does not need to import the root certificate again.

3. If you are recovering the backup-archive client as part of disaster recovery, you must install the SSL certificate on the server again. If the certificate was lost, you must get a new one. You do not need to reconfigure the client if the new certificate has been signed by a CA.

**Windows** The dsmcert utility is provided by the backup-archive client and automatically installs it in C:\Program Files\Tivoli\TSM\baclient.

**Windows** Before you set up the server certificate on the client, follow these steps:

1. Open a command prompt and change the directory to the backup-archive client directory, for example: cd "C:\Program Files\Tivoli\TSM\baclient"
2. Append the GSKit binary path and library path to the PATH environment variable, for example:

```
set PATH=C:\Program Files\Common Files\Tivoli\TSM\api64\gsk8\bin\;  
C:\Program Files\Common Files\Tivoli\TSM\api64\gsk8\lib64;%PATH%
```

See Creating a symbolic link to access the latest GSKit library and IBM Global Security Kit return codes for details on GSKit libraries.

Next, you must import the server certificate, or the CA root certificate.

If you use a self-signed certificate

**AIX** | **Linux** | **Mac OS X** | **Solaris** Each IBM Spectrum Protect server generates its own certificate. The certificate has a fixed file name of either cert.arm or cert256.arm. The certificate file is stored on the server workstation in the server instance directory, for example, /opt/tivoli/tsm/server/bin/cert256.arm. If the certificate file does not exist and you specify the SSLTCPPOINT or SSLTCPADMINPORT server option, the certificate file is created when you restart the server with these options set. IBM Spectrum Protect V6.3 servers (and newer versions) generate files named cert256.arm and cert.arm. IBM Spectrum Protect servers older than V6.3 generate only certificate files named cert.arm. You must choose the certificate that is set as the default on the server.

**Windows** Each IBM Spectrum Protect server generates its own certificate. The certificate has a fixed file name of either cert.arm or cert256.arm. The certificate file is stored on the server workstation in the server instance directory, for example, C:\Program Files\tivoli\tsm\server1\cert256.arm. If the certificate file does not exist and you specify the SSLTCPPOINT or SSLTCPADMINPORT server option, the certificate file is created when you restart the server with these options set. IBM Spectrum Protect V6.3 servers (and newer versions) generate files named cert256.arm and cert.arm. IBM Spectrum Protect servers older than V6.3 generate only certificate files named cert.arm. You must choose the certificate that is set as the default on the server.

**AIX** | **Linux** | **Mac OS X** | **Solaris** | **Windows** Follow these steps to set up the SSL connection to a server:

1. Obtain the certificate from the server administrator.
2. Import the certificate into the client key database by using the following command:

```
dsmcert -add -server <servername> -file <path_to_cert256.arm>
```

If you use a certificate from a certificate authority

If the certificate was issued by a certificate authority (CA) such as VeriSign or Thawte, the client is ready for SSL and you can skip the following steps.

For the list of preinstalled root certificates from external certificate authorities, see Certificate Authorities root certificates.

If the certificate was not issued by one of the well-known certificate authorities, follow these steps:

1. Obtain the root certificate of the signing CA.
2. Import the certificate into the client key database by using the following command:

```
dsmcert -add -server <servername> -file <path_to_cert256.arm>
```

Important:

1. A pseudo random password is used to encrypt the key database. The password is automatically stored encrypted in the stash file (`dsmcert.sth`). The stash file is used by the backup-archive client to retrieve the key database password.
2. More than one server certificate can be added to the client key database file so that the client can connect to different servers. Also, more than one CA root certificate can be added to the client key database.

3. **AIX Linux Mac OS X Solaris** If you do not run the preceding commands from the backup-archive client directory, you must copy `dsmcert.kdb` and `dsmcert.sth` into that directory.

4. **AIX Linux Mac OS X Solaris** By default, local key database files have root ownership and permissions and cannot be read by other users. If you plan to run the client as a non-root user, you must update the permissions. For example, to grant read access to all users and groups, run the following command:

```
# chmod go+r dsmcert.*
```

5. **Windows** If you do not run the preceding commands from the backup-archive client directory, you must copy `dsmcert.kdb` and `dsmcert.sth` into that directory.

6. For performance reasons, use SSL only for sessions where it is needed. A V8.1.2 client communicating with a V8.1.2 server must use SSL. SSL No (the default value) indicates that encryption is not used when data is transferred between the client and a server earlier than V8.1.2. When the client connects to a V8.1.2 or later server, the default value No indicates that object data is not encrypted. All other information is encrypted, when the client communicates with the server. When the client connects to a V8.1.2 or later server, the value Yes indicates that SSL is used to encrypt all information, including object data, when the client communicates with the server. Consider adding more processor resources on the IBM Spectrum Protect server system to manage the increased requirements.

7. In order for a client to connect to a server that is using Transport Layer Security (TLS) Version 1.2, the certificate's signature algorithm must be SHA-1 or stronger. If you are using a self-signed certificate, you must use the `cert256.arm` certificate. Your IBM Spectrum Protect administrator might need to change the default certificate on the IBM Spectrum Protect server.

Additional details for a V8.1.2 client communicating with a server V8.1.1 and earlier V8 levels, and V7.1.7 and earlier levels.

After the server certificate is added to the client key database, add the SSL Yes option to the client options file, and update the value of the `TCPPORT` option. It is important to understand that the server is normally set up for SSL connections on a different port. In other words, two ports are opened on the server:

1. One port accepts regular non-SSL client connections
2. Another port accepts SSL connections only

You cannot connect to a non-SSL port with an SSL-enabled client, and vice versa.

If the value of `tcpport` is incorrect, the client cannot connect to the server. Specify the correct port number on the `tcpport` option.

To disable security protocols that are less secure than TLS 1.2, add the `SSLDISABLELEGACYtls yes` option to the client options file, or within the Java™ GUI select the Require TLS 1.2 or above checkbox on the Communication tab of the Preferences editor. Requiring TLS 1.2 or above helps prevent attacks by malicious programs.

- **AIX Linux Solaris Windows** Creating a symbolic link to access the latest GSKit library  
You can create a symbolic link to point the directory where the older version of GSKit is installed to the location of the latest GSKit libraries on the system.

- **AIX Linux Solaris Windows** Certificate Authorities root certificates  
The backup-archive client includes a list of root certificates for a number of common Certificate Authorities.

**Related reference:**

Ssl

Sslfipsmode

# Creating a symbolic link to access the latest GSKit library

---

You can create a symbolic link to point the directory where the older version of GSKit is installed to the location of the latest GSKit libraries on the system.

## About this task

---

When you install DB2 for Linux, UNIX, and Windows, on UNIX and Linux, local GSKit libraries are also installed. Those libraries are stored in <db2\_install\_path>/lib64/gskit\_db2 or <db2\_install\_path>/lib32/gskit\_db2. On Windows, the default location is C:\Program Files\ibm\gsk8.

During the installation of other IBM products, such as IBM Spectrum Protect™, another copy of the GSKit libraries might be installed. Depending on the product, these libraries might be either local GSKit libraries or global GSKit libraries. When DB2 for Linux, UNIX, and Windows and another IBM product that includes GSKit libraries are both installed on the same system, some interoperability issues might arise. These interoperability issues might occur because GSKit allows only libraries from a single GSKit source to exist in any single process. The interoperability issues might lead to unpredictable behavior and runtime errors.

To ensure that a single source of GSKit libraries is used, the symbolic link approach can be used. During an initial DB2 for Linux, UNIX, and Windows installation, the installer creates a symbolic link <db2\_install\_path>/lib64/gskit or <db2\_install\_path>/lib32/gskit to <db2\_install\_path>/lib64/gskit\_db2 or <db2\_install\_path>/lib32/gskit\_db2. These symbolic links are the default locations from where GSKit libraries are loaded. Products that bundle DB2 for Linux, UNIX, and Windows, and change the symbolic link from the default directory to the library directory of another copy of GSKit must ensure that the newly installed GSKit is at the same or a newer level. This restriction applies whether the libraries are global or local. During an upgrade or update of DB2 for Linux, UNIX, and Windows, the symbolic link is preserved. If the newly installed copy has a symbolic link to the default location, the symbolic link that is associated with the older installation copy is preserved. If the newly installed copy does not have a symbolic link to the default location, the symbolic link that is associated with the newer installation copy is preserved.

Some limitations exist since the symbolic link <db2\_install\_path>/lib64/gskit or <db2\_install\_path>/lib32/gskit is in the path of the DB2 for Linux, UNIX, and Windows installation copy. For example, if two or more instances are created for any DB2 copy, the symbolic link changes affect all the instances.

You can also modify a Domino Server GSKit in a similar manner. A Domino server does not have a GSKit folder, but it has folders C and N, and a library libgsk8iccs\_64.so. You can first create soft links for these folders, and files to point to the corresponding folders on the GSKit package, where the IBM Spectrum Protect backup-archive client V8.1.2 is installed, as follows:

- `ln -s /usr/local/ibm/gsk8_64/lib64/C /opt/ibm/lotus/notes/90010/zlinux`
- `ln -s /usr/local/ibm/gsk8_64/lib64/N /opt/ibm/lotus/notes/90010/zlinux`
- `ln -s /usr/local/ibm/gsk8_64/lib64/libgsk8iccs_64.so /opt/ibm/lotus/notes/90010/zlinux`

Next, change the DPD node's password to domdsmc CHANGEADSMpwd tvt1054\_domnote2 tvt1054\_domnote2 tvt1054\_domnote2. Finally, run domdsmc query adsm.

## Procedure

---

1. Create a symbolic link on Windows, if you have administrator privileges. Rename the DB2 GSKit copy of the lib64 directory that is located in the default location, C:\Program Files\ibm\gsk8. Start a DOS shell, navigate to the DB2 GSKit location, and rename the directory as follows:

```
cd C:\Program Files\ibm\gsk8
rename lib64 lib64-db2
```

2. Create a symbolic link in the location of the DB2 GSKit copy and point to the location of the TSM GSKit copy by running the following commands in the DOS shell. Navigate to the location of the DB2 GSKit copy and then create the symbolic link as follows:

```
cd C:\Program Files\ibm\gsk8
mklink /d lib64 "c:\Program Files\Common Files\Tivoli\TSM\api64\gsk8\lib64"
```

3. Restart DB2 for changes to take effect. On startup, DB2 loads GSKit from the new location, which points to the IBM Spectrum Protect copy of GSKit. In the DB2 command prompt, enter these commands as follows:

```
db2stop
```

## Certificate Authorities root certificates

---

The backup-archive client includes a list of root certificates for a number of common Certificate Authorities.

The following is a list of root certificates for a number of common Certificate Authorities that are delivered with the client:

- Entrust.net Global Secure Server Certification Authority
- Entrust.net Global Client Certification Authority
- Entrust.net Client Certification Authority
- Entrust.net Certification Authority (2048)
- Entrust.net Secure Server Certification Authority
- VeriSign Class 3 Public Primary Certification Authority
- VeriSign Class 2 Public Primary Certification Authority
- VeriSign Class 1 Public Primary Certification Authority
- VeriSign Class 4 Public Primary Certification Authority - G2
- VeriSign Class 3 Public Primary Certification Authority - G2
- VeriSign Class 2 Public Primary Certification Authority - G2
- VeriSign Class 1 Public Primary Certification Authority - G2
- VeriSign Class 4 Public Primary Certification Authority - G3
- VeriSign Class 3 Public Primary Certification Authority - G3
- VeriSign Class 2 Public Primary Certification Authority - G3
- VeriSign Class 1 Public Primary Certification Authority - G3
- Thawte Personal Premium CA
- Thawte Personal Freemail CA
- Thawte Personal Basic CA
- Thawte Premium Server CA
- Thawte Server CA
- RSA Secure Server Certification Authority

To use certificates issued by any other Certificate Authority you must install the root certificate of the Certificate Authority on all clients as part of the client configuration.

## Configure your system for journal-based backup

---

You must install and configure the journal daemon (Linux) or journal engine service (Windows) before you can perform journal-based backups.

- **Windows** Configuring the journal engine service  
Journal-based backup can be used for all Windows clients. If you install the journal engine service and it is running, then by default the incremental command automatically performs a journal-based backup on selected file systems that are being monitored by the journal engine service.
- **AIX** | **Linux** Journal daemon configuration  
Journal-based backup is enabled by installing and configuring the IBM Spectrum Protect™ journal daemon.

## Configuring the journal engine service

---

Journal-based backup can be used for all Windows clients. If you install the journal engine service and it is running, then by default the incremental command automatically performs a journal-based backup on selected file systems that are being monitored by the journal engine service.

### About this task

---

Journal-based backup is enabled by installing and configuring the IBM Spectrum Protect™ journal service. You can install the journal service with the GUI Setup wizard or with the dsmscutil command. Basic journal service configuration can be done with the

GUI Setup wizard, more advanced configuration can be done by editing the journal service configuration file, `tsmjbbd.ini`.  
Tip: The default location for journal service configuration file is `C:\Program Files\Tivoli\TSM\baclient\tsmjbbd.ini`. If this is the first time you are configuring the journal engine service and a copy of `tsmjbbd.ini` does not already exist, copy the sample file `C:\Program Files\Tivoli\TSM\config\tsmjbbd.ini.smp` to `C:\Program Files\Tivoli\TSM\baclient\tsmjbbd.ini`.

To install and configure this service using the client Java™ GUI setup wizard, perform the following steps:

## Procedure

---

1. From the main window, open the Utilities menu and select Setup Wizard.
2. Select the Help me configure the Journal Engine check box.
3. Select the task you want to perform. You can install a new journal engine, update a previously installed journal engine, or remove a previously installed journal engine from your system.
4. Complete each panel in the wizard and click the Next button to continue. To return to a previous panel, click the Back button. To display help information for a panel, click the Help button.

## Results

---

Journal service configuration settings are stored in the journal configuration file `tsmjbbd.ini`. This file can be installed and configured with the GUI setup wizard or be manually edited.

Follow these steps to set up multiple journal services:

1. Create and set up a separate journal configuration file (`tsmjbbd.ini`) for each journal service to be installed. Each configuration file must specify a different `JournalPipe` value, and must also specify different drives to journal, so that the two services do not interfere with each other. Multiple journal services journaling the same drive causes problems. The different services attempts to write to the same journal database unless this is specifically overridden by specifying different journal directories in the different configuration files.
2. Install the multiple journal services using the `dsmcutil.exe` tool. Use distinct names for each service, and specify the `/JBBCONFIGFILE` option to identify the `tsmjbbd.ini` to be used for that particular journal instance. For example:

```
dsmcutil install journal /name:"TSM Journal Service 1"  
/JBBCONFIGFILE:c:\journalconfig\tsmjbbd1.ini  
  
dsmcutil install journal /name:"TSM Journal Service 2"  
/JBBCONFIGFILE:d:\journalconfig\tsmjbbd2.ini
```

Note: In Uniform Naming Convention (UNC) format, the `jbconfigfile` path must contain a drive letter. In the following UNC format example, the path contains the drive letter `D$`: `\\computer7\D$\journalconfig\tsmjbbd1.ini`

3. Different backup clients (based on the distinct `dsm.opt` file used) can now connect to the desired journal service by specifying the appropriate `JournalPipe` option in the appropriate `dsm.opt`, which corresponds to the `JournalPipe` journal service setting.

Note:

1. Each journal service instance is associated to only one backup-archive client node name. Changing the association requires a restart of the journal service to recognize the new association.
2. You cannot use network and removable file systems.

Configuration settings that you apply when the journal service is started and any changes you make while the journal service is running are applied without having to restart the service. This also applies to the journal exclude list. However, some settings for journaled file systems do not take effect until the file system is brought offline and then back online.

File systems can be taken online (added) or offline (removed) without stopping and restarting the journal service. You can bring a file system offline by removing it from the list of journaled file systems in the journal configuration file `tsmjbbd.ini`, or by shutting down the journal service. You can bring a file system back online by adding it to the list of journaled file systems in the journal configuration file `tsmjbbd.ini` or by starting (restarting) the journal service.

Attention: If you take a file system offline without setting the `PreserveDbOnExit` value of 1, the journaled file system journal database is deleted. `PreserveDbOnExit=1` specifies that the journaled file system journal database is not deleted when the journal file system goes offline. The database is also valid when the journal file system comes back online.

The following is the syntax for stanza and stanza settings:

Syntax for stanzas:  
[StanzaName]

Syntax for stanza settings:  
`stanzaSetting=value`

Note:

1. You can specify comments in the file by beginning the line with a semicolon.
  2. Stanza and value names are not case sensitive.
  3. Numeric values can be specified in hexadecimal by preceding the value with `0x` otherwise they are interpreted as decimal.
  4. There is no correlation between these settings and any settings in the backup-archive client options file. The journal service is a completely independent process and does not process backup-archive client options.
- **Windows** `JournalSettings` stanza (Windows)  
Settings under this stanza are global and apply to the entire journal service.
  - **Windows** `JournalExcludeList` stanza  
This list of exclude statements filters changes from being recorded in the journal database. Changes to objects which match statements in this stanza are ignored and are not recorded in the journal database.
  - **Windows** `JournalizedFileSystemSettings` stanza  
Settings under this stanza apply to each specified journaled file system unless they are overridden for individual file systems in an override stanza.
  - **Windows** `Overriding stanzas`  
Any setting in the **`JournalizedFileSystemSettings`** stanza, except for the buffer sizes, can be overridden for a particular journaled file system by creating an override stanza.

**Related concepts:**

Journal-based backup

**Windows**

## JournalSettings stanza (Windows)

---

Settings under this stanza are global and apply to the entire journal service.

The following is the syntax for the `JournalSettings` stanza:

Syntax for `JournalSettings` stanza:  
`[JournalSettings]`

Syntax for stanza settings:  
`JournalSettings=value`

You can specify the following `JournalSettings` values:

`JournalPipe=pipeName`

Specifies the pipe name of the journal service session manager to which backup clients initially connect, when establishing a journal-based backup session. This setting is used in conjunction with the backup client option of the same name. The default pipe name is `\\.\pipe\jnlSessionMgr1`. For example, in `dsm.opt`:

```
JournalPipe \\.\pipe\jnlSessionMgr1
```

Under `tsmjbbd.ini` `[JournalSettings]` stanza:

```
JournalPipe=\\.\pipe\jnlSessionMgr1
```

**Note:** The same pipe name must be specified by the client using the `JournalPipe` option.

`NlsRepos`

Specifies the National Language Support repository the journal service uses for generating messages. Since the journal service is non-interactive, this only applies to messages written to the journal error log. The default value is `dscameng.txt`. For example:

```
NlsRepos=dscenu.txt
```

`ErrorLog`

Specifies the log file where detailed error messages generated by the journal service are written. Note that less detailed error and informational messages are written to the Windows application event log as well. The default value is `jbberror.log`. For example:

```
ErrorLog=jbberror.log
```

In Uniform Naming Convention (UNC) format, the path must contain a drive letter. In the following UNC format example, the path contains the drive letter D\$: \\computer7\D\$\temp\jbberror.log.

#### JournalDir

Specifies the directory where journal database files are stored and written. The default directory is the journal service installation directory. You can specify different journal locations for each file system being journaled. This is useful when running in a clustered environment because the location of the journal must be accessible by each workstation in the cluster running the journal service. Typically the journal for local resources being journaled resides in the same location and the journal for shared cluster resources (which can move from workstation to workstation) is located on the shared resource to ensure that it is accessible to both workstations.

By default, this setting applies to all journaled file systems but can be overridden by an override stanza for each journal file system. If the default value is a fully qualified path (for example c:\tsmjournal), all journal database files are written to the specified directory. If the default value does not specify a drive letter, (for example \tsmjournal) the journal database files for each journal file system are written to the specified directory on each journal file system.

In Uniform Naming Convention (UNC) format, the path must contain a drive letter. In the following UNC format example, the path contains the drive letter D\$: \\computer7\D\$\temp\tsmjournal.

The following is an example configuration stanza:

```
[JournalSettings]
;
; Store all resources in one location unless overridden
; by an override stanza
;
JournalDir=c:\tsmjournal
;
;
[JournaledFileSystemSettings.D:\]
;
; Journal for d: only is in location specified below
;
JournalDir=d:\tsmjournal
```

Note: Changes to this setting do not take effect until the journaled file systems are brought online.

#### Windows

## JournalExcludeList stanza

---

This list of exclude statements filters changes from being recorded in the journal database. Changes to objects which match statements in this stanza are ignored and are not recorded in the journal database.

Note:

1. Excluding files from the journal has no bearing on those files being excluded by the backup client, other than preventing the files from being sent to the backup client to be processed during journal-based backup. A file that is not excluded from the journal should still be excluded by the backup-archive client, if there is a matching exclude statement in the client options file.
2. The journal service only provides a subset of the INCLUDE/EXCLUDE function provided by the backup-archive client. The journal service does not support INCLUDE statements and it does not support the *exclude.dir* option.

There is no correlation between the journal exclude list and the backup-archive client exclude list.

The following are examples of equivalent journal exclude statements:

dsm.opt: tsmjbbd.ini

```
EXCLUDE c:\testdir\...\* c:\testdir\*
EXCLUDE.DIR c:\testdir\test* c:\testdir\test*\*
```

The following pattern matching meta characters are supported:

%

Matches exactly one character.

\*

Matches zero or more characters.



%EnvVar%

Expands environment variable.

The following is an exclude statement syntax example:

```
[JournalExcludeList]
%SystemRoot%\System32\Config\*
C:\Program Files\Tivoli\TSM\baclient\adsm.sys\*
%TEMP%\*
%TMP%\*
c:\excluedir\*
c:\dir1\excludefile
*.*\*.tmp
```

Note: The `c:\excluedir\*` statement matches the entire tree including subdirectories and files.

Windows

## JournaledFileSystemSettings stanza

---

Settings under this stanza apply to each specified journaled file system unless they are overridden for individual file systems in an override stanza.

The following is the syntax for the `JournaledFileSystemSettings` stanza:

Syntax for ***JournaledFileSystemSettings*** stanza:

**[*JournaledFileSystemSettings*]**

Syntax for stanza settings:

***JournaledFileSystemSetting***=value

You can specify the following ***JournaledFileSystemSettings*** values:

### *DirNotifyBufferSize*

Specifies the size of the buffer to record change notifications for a particular journal file system. You might need to increase this value for journaled file systems that generate a very large volume of change activity. The buffer size is limited by memory. The default value is 16 KB.

### *JournaledFileSystems*

Specifies a space delimited list of file systems to journal. Full file system specifications and Windows junctions are supported. There is no default value. You must specify at least one journaled file system for the journal service to run. Journaled file systems can be added or removed online without having to restart the service. For example:

```
JournaledFileSystems=c: d:
```

### *JournalDbSize*

Specifies the maximum size the journal database can grow. The journal database size is expressed in bytes. A value of zero (0) indicates that the database size is limited only by the capacity of the file system containing the journal database. The default is 0 (unlimited). For example:

```
JournalDBSize=0x10000000
```

### *NotifyBufferSize*

Specifies the size of the memory buffer receiving file system change notifications for a particular journal file system. You might need to increase this value for journaled file systems that generate a very large volume of change activity. The buffer size is limited by memory. The default value is 32 KB. For example:

```
NotifyBufferSize=0x00008000
```

### *NotifyFilter*

Specifies what file system change actions generate notifications to the journal service. ***NotifyFilter*** applies to file changes and directory modifications. Directory name changes, such as deletions and creations, are always tracked regardless of the filter value. Multiple actions can be monitored by combining (adding) values together. The default value is `0x11F` (File and Dir Name, Attrib, Size, Last Write, and security Changes). You can also use the IBM Spectrum Protect™ Journal Engine Wizard to specify that any or all of these actions are monitored. Supported values are:

Value type	Decimal	Hex
File Name	1	0x001
Dir Name	2	0x002



Value type	Decimal	Hex
Attribute	4	0x004
File size*	8	0x008
Last Write Time*	16	0x010
Last Access Time	32	0x020
Create Time	64	0x040
Security (ACL)	256	0x100

The asterisk (\*) indicates that notification might be deferred until disk write cache is flushed. Name changes are object creations, deletions, or renames.

Example:

```
NotifyFilter=0x107
```

### **PreserveDbOnExit setting**

This setting allows a journal to remain valid when a journaled file system goes offline and comes back online. This is useful for preserving the journal during system reboots, cluster failovers, and resource movement.

File systems go offline when the journal service stops or when the file system is removed from the configuration file. File systems come back online when the journal service is started or when the file system is added to the configuration file.

This setting allows a journal-based backup to continue processing when the service is restarted (or the file system comes back online) without performing a full incremental backup.

**Note:** Any change activity which occurs while the journal service is not running (or the file system is offline) is not recorded in the journal.

In a clustered environment, shared resources can move to different workstations in the cluster. The journal service running on each workstation in the cluster must include these shared resources in the list of journaled file systems. The journal service running on the workstation which currently owns the resource actively journals the shared resource while other journal services on workstations in the cluster which do not own the resource must defer journaling until the resource becomes available (or is moved to that workstation). The configuration settings *deferFSMonStart*, *deferRetryInterval*, and *logFSErrors* allows deferment for a file system until the file system is available and accessible.

A value of 1 specifies that the journaled file system journal database is not deleted when the journal file system goes offline. The database is also valid when the journal file system comes back online. This value should be used with caution because any file system change activity which occurs while the journaled file system is offline is not reflected in the journal database. The default setting of 0 deletes the journaled file system journal database.

**Note:** The journal is only preserved when a journaled file system comes offline normally or is brought offline when the resource is no longer available and you specify the *deferFsMonStart* setting. If a file system comes offline due to an error such as a notification buffer overrun, the journal is not preserved.

An example for not deleting the journal database upon exit is:

```
[JournaledFileSystemSettings.D:\]
;
; Do not delete the journal when D:\ goes offline
;
PreserveDbOnExit=1
```

### **deferFSMonStart setting**

This setting defers an attempt to begin monitoring a file system in the following cases:

- When the specified journaled file system is not valid or available
- The journal directory for the specified journaled file system cannot be accessed or created

Resources are checked at the interval you specify using the *deferRetryInterval* setting.

The *deferFSMonStart* setting is most commonly used in a cluster environment where shared resources might move to different workstations in the cluster.

A value of 1 indicates that the setting is on. A value of 0 indicates that the setting is off. The default value is off (set to 0) .

### **deferRetryInterval setting**

This setting specifies the value in seconds that a deferred file systems with the *deferRetryInterval* setting enabled are checked for availability and brought online. The default value is 1 second.

### **logFSErrors setting**

This setting specifies whether errors encountered while accessing a journaled file system or journal directory are logged in the `joberror.log` and the event log.

Use the *logFSErrors* setting with the *deferFSMonStart* setting to prevent excessive *File System unavailable* messages from being logged when bringing a journaled file system online is deferred. The first error which causes the file system to be deferred is logged. Subsequent errors are not logged. A value of 1 indicates that the setting is on. A value of 0 indicates that the setting is off.

An example to defer journaling until the file system journal directories are valid is:

```
[JournalSettings]
;
; Place journal files in directory on each journaled file system
;
journalDir=\tsmjournal

[JournaledFileSystemSettings]
;
; journal c:, d:, and f:
;
JournaledFileSystems=c: d: d:\mountpoint f:
;
; Override stanza to defer starting journaling for f:\
; until it is a valid file system

[JournalFileSystemSettings.f:\]
;
; Keep database valid if file system goes offline
;
PreserveDBOnExit=1
;
; Defer journaling until file system and journal directory
; are valid
;
deferFSMonStart=1
;
; Attempt to start journaling every 120 seconds when deferred
;
deferRetryInterval=120
;
; Do not log excessive resource unavailable messages
;
logFsErrors=0
```

### **Related concepts:**

Overriding stanzas

Windows

## Overriding stanzas

---

Any setting in the **JournaledFileSystemSettings** stanza, except for the buffer sizes, can be overridden for a particular journaled file system by creating an override stanza.

The following is the syntax for the **JournaledFileSystemSettings** stanza:

Syntax for JournaledFileSystemSettings stanza:

```
[JournaledFileSystemSettings.fs]
```

Syntax for stanza settings:

```
JournaledFileSystemSetting=override value
```

Example:

```
[JournalFileSystemSettings.C:\]
NotifyBuffer=0x0020000
NotifyFilter=0x107
```

## Journal daemon configuration

Journal-based backup is enabled by installing and configuring the IBM Spectrum Protect™ journal daemon.

Configure the journal daemon by editing the journal daemon configuration sample file, `tsmjbbd.ini.smp`, and saving it as `tsmjbbd.ini`. Both files should be in the default installation directory.

After you configured the `tsmjbbd.ini` file, start the journal daemon by starting the `tsmjbbd` executable file.

**AIX** To start the journal daemon after you restart your system on AIX®, run the `jbbinittab` script file to add an entry to the `/etc/inittab` file. The `tsmjbbd` executable file and the `jbbinittab` script file should be in the default installation directory.

**AIX** To stop the journal daemon on AIX, issue the `kill nnnn` command, where `nnnn` is the process ID of `tsmjbbd`. Before the journal daemon process (`tsmjbbd`) shuts down, it notifies the filepath kernel extension to stop buffering file changes. Important: Do not use the `kill -9 nnnn` command, because the `kill -9` command immediately ends the process without notifying filepath to stop buffering file changes.

**Linux** On Linux, the installer creates the `tsmjbbd` service in `/etc/init.d`. To control the service, run the following command as root to stop, start, or restart the service, or to check its status:

```
>>-service tsmjbbd--+-start-----+----->>
                +-stop-----+
                +-restart--+
                '-status--'
```

If the Linux operating system runs the `systemd` initialization service, complete the following steps to start the journal daemon:

1. Copy the provided `systemd` unit file `/opt/tivoli/tsm/client/ba/bin/tsmjbbd.service` to the `/etc/systemd/system/` directory.
2. Run the following command to refresh the `systemd` unit list:

```
systemctl daemon-reload
```

3. Run the following command to start the journal daemon at system boot time:

```
systemctl enable tsmjbbd.service
```

4. Run the following command to start the journal daemon:

```
systemctl start tsmjbbd.service
```

Note:

1. Network and removable file systems are not supported.
2. Periodic full incremental backups should be performed to complement daily journal-based backups. Full progressive incremental backups can take longer to run than a journal-based backup. Take this information into account when you schedule them, perhaps scheduling the incremental backups during off-peak times. Balance these two backup techniques according to your business needs. For example, you might decide to schedule nightly journal-based backups and also schedule a weekly full progressive incremental backup.
3. Journal-based backup uses the filepath kernel extension to monitor file system changes. To improve the performance of journal-based backups, directories that do not contain user files are not monitored for changes and are not included in journal-based backups. The following lists the directories that are not included in journal-based backups on AIX and Linux systems. Changes to these directories are processed if you perform periodic full incremental backups by using the incremental command with the `-nojournal` option.

AIX	Linux
/bin	/bin
/dev	/boot
/etc	/dev
/lib	/etc
/usr/bin	/lib
/usr/lib	/proc
/usr/share	/sbin
	/sys
	/usr/bin
	/usr/lib

	/usr/share
	/var

The journal daemon configuration file is periodically checked for updates to the list of journaled file systems. You can add or remove file systems from the list of monitored file systems without stopping the journal daemon.

Attention: If you bring a file system that is being monitored by the journal daemon offline, the journal database for that file system is deleted. To preserve the database, set `PreserveDbOnExit=1` in the journaled file systems settings stanza. This setting preserves the journal database when it is taken offline and ensures that the journal database is valid when the file system comes back online. For more information, see `JournaledFileSystemSettings` stanza.

The syntax for stanza and stanza settings is as follows:

Syntax for stanzas:

`[StanzaName]`

Syntax for stanza settings:

`stanzaSetting=value`

Note:

1. You can specify comments in the file by beginning the line with a semicolon.
2. Stanza and value names are not case-sensitive.
3. Numeric values can be specified in hexadecimal by preceding the value with `0x`; otherwise, they are interpreted as decimal.
4. These journaled file system settings do not correlate to any settings in the client options file. The journal daemon is an independent process; it does not process any options in the client options file.

- **AIX** | **Linux** `JournalSettings` stanza

Settings under this stanza are global and apply to the entire journal daemon.

- **AIX** | **Linux** `JournalExcludeList` stanza

This list of exclude statements filters changes from being recorded in the journal database.

- **AIX** | **Linux** `JournaledFileSystemSettings` stanza

Settings under this stanza apply to each specified journaled file system unless they are overridden for individual file systems in an override stanza.

- **AIX** | **Linux** Overriding stanzas

Any setting in the `JournaledFileSystemSettings` stanza, except for the buffer sizes, can be overridden for a particular journaled file system by creating an override stanza.

**AIX** | **Linux**

## JournalSettings stanza

Settings under this stanza are global and apply to the entire journal daemon.

The following is the syntax for the `JournalSettings` stanza:

Syntax for `JournalSettings` stanza:

`[JournalSettings]`

Syntax for stanza settings:

`JournalSettings=value`

You can specify the following `JournalSettings` values:

**ErrorLog**

Specifies the log file where detailed error messages generated by the journal daemon are written. The default value is `jbberror.log` in the directory of the daemon executable. For example:

```
ErrorLog=/logs/jbberror.log
```

**JournalDir**

Directory where journal database files are stored and written.

If the path given is an absolute (for example, it begins with a `dir` delimiter) `pathname`, this is the directory used. If the path given is a relative directory name, then this path is appended to each file system name and the resulting path name is used.

The default is a directory named `.tSm_JoUrNaL` (used within each file system being journaled).

The advantage of having the journal database on the file system being monitored is that the database stays with the file system. The disadvantage is that the updates to the database must be processed and discarded.  
Important: Directing the database to a non-journaled file system, unless this file system is shared in a cluster environment.

This setting applies to all journaled file systems but can be overridden with an override stanza for each journal file system.

AIX

## JournalExcludeList stanza

---

This list of exclude statements filters changes from being recorded in the journal database.

Changes to objects which match statements in this stanza are ignored and are not recorded in the journal database.

Note:

1. Excluding files from the journal has no bearing on those files being excluded by the backup client, other than preventing the file names from being sent to the backup client to be processed during journal-based backup. A file that is not excluded from the journal should still be excluded by the backup-archive client, if there is a matching exclude statement in the client options file.
2. The journal daemon only provides a subset of the INCLUDE/EXCLUDE function provided by the backup-archive client. The journal daemon does not support INCLUDE statements and it does not support the *exclude.dir* option.

There is no correlation between the journal exclude list and the backup-archive client exclude list.

The following pattern matching meta characters are supported:

%

Matches exactly one character.

\*

Matches zero or more characters.

%EnvVar%

Expands environment variable.

The following is an exclude statement syntax example:

```
[JournalExcludeList]
*.jbb.jbbdb
*.jbbInc.jbbdb
```

AIX

Linux

## JournaledFileSystemSettings stanza

---

Settings under this stanza apply to each specified journaled file system unless they are overridden for individual file systems in an override stanza.

File systems that you specify in the JournalFileSystems.Extended stanza override any file systems specified in the list of journaled file systems that you might have previously specified in the JournaledFileSystemSettings stanza. Any other options that you have specified in the JournaledFileSystemsSettings stanza are preserved.

The syntax for the JournaledFileSystemSettings stanza is as follows:

Syntax for **JournaledFileSystemSettings** stanza:

**[JournaledFileSystemSettings]**

Syntax for stanza settings:

**JournaledFileSystemSetting=value**

You can specify the following **JournaledFileSystemSettings** values:

*JournaledFileSystems*

Specifies a space delimited list of file systems to journal. Full file system specifications and Windows junctions are supported. There is no default value. You must specify at least one journaled file system for the journal daemon to run. Journaled file systems can be added or removed online without having to restart the daemon. For example:

```
JournaledFileSystems=/home /other
```

Important: The journal selects object names based strictly on a string match. The implication for the user is that care must be taken when selecting file systems to journal. For example, suppose you have a file system `/jbb` and another file system called `/jbb/mnt1`. If you ask the journal to monitor just `/jbb`, then all the changes for `/jbb/mnt1` also match this string and are entered in the database. When, however, you do a back up on the client, it parses the name based on file systems, realizes the journal is not monitoring this file system and then tells the journal to remove the `/jbb/mnt1` files from the database. The solution is to either monitor both or use the `JournalExcludeList`. The same is true for the virtual mount point options. You must be consistent with this list. For example, if you specify `/home/student1` as a virtual mount point in your `dsm.sys` option file and you want to journal `/home`, then you must specify `JournaledFileSystems=/home/home/student1`. In this case, two separate databases are created.

#### *JournalDbSize*

Specifies the maximum size the journal database can grow. The journal database size is expressed in bytes. A value of zero (0) indicates that the database size is limited only by the capacity of the file system containing the journal database. The default is 0 (unlimited). For example:

```
JournalDBSize=0x10000000
```

#### *NotifyBufferSize, DirNotifyBufferSize*

Specify change notification buffer sizes for a journaled file system. A large amount of change activity on a journaled file system might require this to be increased. The default is `0x00020000` (128 k) for files and `0x00010000` (64 k) for directories.

```
NotifyBufferSize=0x00200000
```

#### **PreserveDbOnExit setting**

This setting allows a journal to remain valid when a journaled file system goes offline and comes back online. This is useful for preserving the journal during system reboots, and resource movement.

This setting allows a journal-based backup to continue processing when the daemon is restarted (or the file system comes back online) without performing a full incremental backup.

Note: Any change activity which occurs while the journal daemon is not running (or the file system is offline) is not recorded in the journal.

A value of 1 specifies that the journaled file system journal database is not deleted when the journal file system goes offline. The database is also valid when the journal file system comes back online. This value should be used with caution because any file system change activity which occurs while the journaled file system is offline is not reflected in the journal database. The default setting of 0 deletes the journaled file system journal database.

Note: The journal is only preserved when a journaled file system comes offline normally or is brought offline when the resource is no longer available and you specify the `deferFsMonStart` setting. If a file system comes offline due to an error such as a notification buffer overrun, the journal is not preserved.

Note: Set `PreserveDBonExit` only when you can ensure that there is a controlled shutdown of the journal service. The scope of "controlled shutdown" includes stopping the journal service in order to reboot the system, failing over a cluster resource, or moving a cluster resource. The journal database can become corrupted if the shutdown is not controlled. Therefore, perform the following steps if the journal service was not shut down in a controlled manner or if the journal database was otherwise taken offline in an uncontrolled manner.

1. Stop the journal service (if it is running)
2. Delete the corrupted journal databases
3. Restart the journal service
4. Perform an incremental backup

An example for not deleting the journal database upon exit is:

```
preserveDBonExit=1
```

#### **deferFSMonStart setting**

This setting defers an attempt to begin monitoring a file system in the following cases:

- When the specified journaled file system is not valid or available
- The journal directory for the specified journaled file system cannot be accessed or created

Resources are checked at the interval you specify using the `deferRetryInterval` setting.

A value of 1 indicates that the setting is on. A value of 0 indicates that the setting is off. The default value is off (set to 0).

### ***deferRetryInterval* setting**

This setting specifies the value in seconds that deferred file systems with the *deferRetryInterval* setting enabled are checked for availability and brought online. The default value is 5 seconds.

### ***logFSErrors* setting**

A value of 1 indicates that all errors encountered accessing a journaled file system or journal directory should be logged. A value of zero indicates that logging of errors encountered while checking deferred file systems and journal directories is suppressed. This is usually used in conjunction with the *deferFSMonStart* setting to eliminate excessive `File System Unavailable` messages from being written to the logs when bringing a journaled file system online is deferred. The default value is 1 (log all errors).

- Linux AIX `JournalFileSystems.Extended` stanza

The `JournalFileSystems.Extended` stanza overrides any file systems that are included in the `JournalFileSystems` stanza. It also removes the 1023 character limitation imposed by the `JournalFileSystem` stanza.

### **Related concepts:**

Overriding stanzas

`JournalFileSystems.Extended` stanza

AIX Linux

## Overriding stanzas

---

Any setting in the `JournalFileSystemSettings` stanza, except for the buffer sizes, can be overridden for a particular journaled file system by creating an override stanza.

### HookFileName

In order for the journal to begin monitoring a file system, it must know the name of an existing file in that file system. This setting specifies an existing file. Access to this file is then used as a test of whether or not this file system is online. (The system definition of `mounted` cannot be used because we allow the use of virtual mount points in the backup-archive client. This means that the backup-archive client system can treat a directory as a (virtual) file system).

Therefore, if this file system can be mounted and unmounted, a `HookFileName` needs to be provided.

If a `HookFileName` is not entered, the journal daemon attempts to create a temporary file in the highest directory, use it to begin monitoring, and then delete it.

The following is the syntax for the `JournalFileSystemSettings` stanza:

Syntax for `JournalFileSystemSettings` stanza:

**[*JournalFileSystemSettings*.fs]**

Syntax for stanza settings:

***JournalFileSystemSetting*=*override value***

For example, the override stanza name for `/home` would be:

```
JournalFileSystemSettings./home
HookFileName=/home/doNotDeleteThisFile
```

## Client-side data deduplication

---

*Data deduplication* is a method of reducing storage needs by eliminating redundant data.

### Overview

---

Two types of data deduplication are available: *client-side data deduplication* and *server-side data deduplication*.

*Client-side data deduplication* is a data deduplication technique that is used on the backup-archive client to remove redundant data during backup and archive processing before the data is transferred to the IBM Spectrum Protect™ server. Using client-side data deduplication can reduce the amount of data that is sent over a local area network.

*Server-side data deduplication* is a data deduplication technique that is done by the server. The IBM Spectrum Protect administrator can specify the data deduplication location (client or server) to use with the `DEDUP` parameter on the `REGISTER NODE` or `UPDATE NODE` server command.

## Enhancements

---

With client-side data deduplication, you can:

- Exclude specific files on a client from data deduplication.
- Enable a data deduplication cache that reduces network traffic between the client and the server. The cache contains extents that were sent to the server in previous incremental backup operations. Instead of querying the server for the existence of an extent, the client queries its cache.

Specify a size and location for a client cache. If an inconsistency between the server and the local cache is detected, the local cache is removed and repopulated.

**Note:** For applications that use the IBM Spectrum Protect API, the data deduplication cache must not be used because of the potential for backup failures caused by the cache being out of sync with the IBM Spectrum Protect server. If multiple, concurrent backup-archive client sessions are configured, there must be a separate cache configured for each session.

- Enable both client-side data deduplication and compression to reduce the amount of data that is stored by the server. Each extent is compressed before it is sent to the server. The trade-off is between storage savings and the processing power that is required to compress client data. In general, if you compress and deduplicate data on the client system, you are using approximately twice as much processing power as data deduplication alone.

The server can work with deduplicated, compressed data. In addition, backup-archive clients earlier than V6.2 can restore deduplicated, compressed data.

Client-side data deduplication uses the following process:

- The client creates extents. *Extents* are parts of files that are compared with other file extents to identify duplicates.
- The client and server work together to identify duplicate extents. The client sends non-duplicate extents to the server.
- Subsequent client data-deduplication operations create new extents. Some or all of those extents might match the extents that were created in previous data-deduplication operations and sent to the server. Matching extents are not sent to the server again.

## Benefits

---

Client-side data deduplication provides several advantages:

- It can reduce the amount of data that is sent over the local area network (LAN).
- The processing power that is required to identify duplicate data is offloaded from the server to client nodes. Server-side data deduplication is always enabled for deduplication-enabled storage pools. However, files that are in the deduplication-enabled storage pools and that were deduplicated by the client, do not require additional processing.
- The processing power that is required to remove duplicate data on the server is eliminated, allowing space savings on the server to occur immediately.

Client-side data deduplication has a possible disadvantage. The server does not have whole copies of client files *until* you back up the primary storage pools that contain client extents to a non-deduplicated copy storage pool. (*Extents* are parts of a file that are created during the data-deduplication process.) During storage pool backup to a non-deduplicated storage pool, client extents are reassembled into contiguous files.

By default, primary sequential-access storage pools that are set up for data deduplication must be backed up to non-deduplicated copy storage pools before they can be reclaimed and before duplicate data can be removed. The default ensures that the server has copies of whole files at all times, in either a primary storage pool or a copy storage pool.

**Important:** For further data reduction, you can enable client-side data deduplication and compression together. Each extent is compressed before it is sent to the server. Compression saves space, but it increases the processing time on the client workstation.

In a data deduplication-enabled storage pool (file pool) only one instance of a data extent is retained. Other instances of the same data extent are replaced with a pointer to the retained instance.

When client-side data deduplication is enabled, and the server has run out of storage in the destination pool, but there is a next pool defined, the server will stop the transaction. The backup-archive client retries the transaction without client-side data deduplication. To recover, the IBM Spectrum Protect administrator must add more scratch volumes to the original file pool, or retry the operation with deduplication disabled.

For client-side data deduplication, the IBM Spectrum Protect server must be Version 6.2 or higher.



## Prerequisites

When configuring client-side data deduplication, the following requirements must be met:

- The client and server must be at version 6.2.0 or later. The latest maintenance version should always be used.
- When a client backs up or archives a file, the data is written to the primary storage pool that is specified by the copy group of the management class that is bound to the data. To deduplicate the client data, the primary storage pool must be a sequential-access disk (FILE) storage pool that is enabled for data deduplication.
- The value of the DEDUPLICATION option on the client must be set to YES. You can set the DEDUPLICATION option in the client options file, in the preference editor of the backup-archive client GUI, or in the client option set on the IBM Spectrum Protect server. Use the DEFINE CLIENTOPT command to set the DEDUPLICATION option in a client option set. To prevent the client from overriding the value in the client option set, specify FORCE=YES.
- Client-side data deduplication must be enabled on the server. To enable client-side data deduplication, use the DEDUPLICATION parameter on the REGISTER NODE or UPDATE NODE server command. Set the value of the parameter to CLIENTORSERVER.
- Ensure files on the client are not excluded from client-side data deduplication processing. By default, all files are included. You can optionally exclude specific files from client-side data deduplication with the exclude.dedup client option.
- Files on the client must not be encrypted. Encrypted files and files from encrypted file systems cannot be deduplicated.
- Files must be larger than 2 KB and transactions must be below the value that is specified by the CLIENTDEDUPTXNLIMIT option. Files that are 2 KB or smaller are not deduplicated.

The server can limit the maximum transaction size for data deduplication by setting the CLIENTDEDUPTXNLIMIT option on the server. For more information about this option, see the IBM Spectrum Protect server documentation.

The following operations take precedence over client-side data deduplication:

- LAN-free data movement
- Simultaneous-write operations
- Data encryption

**Important:** Do not schedule or enable any of those operations during client-side data deduplication. If any of those operations occur during client-side data deduplication, client-side data deduplication is turned off, and a message is written to the error log.

The setting on the server ultimately determines whether client-side data deduplication is enabled. See Table 1.

Table 1. Data deduplication settings: Client and server

Value of the client DEDUPLICATION option	Setting on the server	Data deduplication location
Yes	On either the server or the client	Client
Yes	On the server only	Server
No	On either the server or the client	Server
No	On the server only	Server

## Encrypted files

The IBM Spectrum Protect server and the backup-archive client cannot deduplicate encrypted files. If an encrypted file is encountered during data deduplication processing, the file is not deduplicated, and a message is logged.

**Tip:** You do not have to process encrypted files separately from files that are eligible for client-side data deduplication. Both types of files can be processed in the same operation. However, they are sent to the server in different transactions.

As a security precaution, you can take one or more of the following steps:

- Enable storage-device encryption together with client-side data deduplication.
- Use client-side data deduplication only for nodes that are secure.
- If you are uncertain about network security, enable Secure Sockets Layer (SSL).
- If you do not want certain objects (for example, image objects) to be processed by client-side data deduplication, you can exclude them on the client. If an object is excluded from client-side data deduplication and it is sent to a storage pool that is set up for data deduplication, the object is deduplicated on server.
- Use the SET DEDUPVERIFICATIONLEVEL command to detect possible security attacks on the server during client-side data deduplication. Using this command, you can specify a percentage of client extents for the server to verify. If the server detects a possible security attack, a message is displayed.

- Configuring the client for data deduplication  
Configure the client so that you can use data deduplication to back up or archive your files.
- Excluding files from data deduplication  
You can exclude a file from data deduplication during backup or archive processing.

**Related tasks:**

Configuring the client for data deduplication

**Related reference:**

- Deduplication
- Exclude options
- Dedupcachepath
- Dedupcachesize
- Enablededupcache
- Teobjtype

## Configuring the client for data deduplication

Configure the client so that you can use data deduplication to back up or archive your files.

### Before you begin

Before you configure your client to use data deduplication, ensure that the requirements listed in Client-side data deduplication are met:

- The server must enable the client for client-side data deduplication with the DEDUP=CLIENTORSERVER parameter on either the REGISTER NODE or UPDATE NODE command.
- The storage pool destination for the data must be a data deduplication-enabled storage pool.
- Ensure that your files are bound to the correct management class.
- Files must be larger than 2 KB.

A file can be excluded from client-side data deduplication processing. By default, all files are included. Refer to the exclude.dedup option for details.

The server can limit the maximum transaction size for data deduplication by setting the CLIENTDEDUPTXNLIMIT option on the server.

### Procedure

Use one of the following methods to enable data deduplication on the client:

Option	Description
<b>Edit the client options file</b>	<ul style="list-style-type: none"> <li>• <b>AIX</b>   <b>Linux</b>   <b>Mac OS X</b>   <b>Solaris</b> Add the deduplication yes option to the dsm.sys file.</li> <li>• <b>Windows</b> Add the deduplication yes option to the dsm.opt file.</li> </ul>
<b>Preferences editor</b>	<ol style="list-style-type: none"> <li>From the IBM Spectrum Protect™ window, click Edit &gt; Client Preferences.</li> <li>Click Deduplication.</li> <li>Select the Enable Deduplication check box.</li> <li>Click OK to save your selections and close the Preferences Editor.</li> </ol>

### Results

After you have configured the client for data deduplication, start a backup or archive operation. When the operation completes, the backup or archive report shows the amount of data that was deduplicated in this operation, and how many files were processed by client-side data deduplication.

If you do not have enough disk space for the backup or archive operation, you can enable client-side data deduplication without local data deduplication cache on the client by using these steps:

1. Add the deduplication yes option to the client options file.

- o **AIX** | **Linux** | **Mac OS X** | **Solaris** Add the deduplication `yes` option to the `dsm.sys` file. You can also set this option in the GUI.
  - o **Windows** Add the deduplication `yes` option to the `dsm.opt` file. You can also set this option in the GUI.
2. Turn off the local data deduplication cache by completing one of the following steps:
- o **AIX** | **Linux** | **Mac OS X** | **Solaris** Add the `ENABLEDEDUPCACHE NO` option to the `dsm.sys` file.
  - o **Windows** Add the `ENABLEDEDUPCACHE NO` option to the `dsm.opt` file.

You can also set this option in the backup-archive client preferences editor by clearing the Enable Deduplication Cache check box.

## Example

The following example uses the query session command to show the type of data that was processed for data deduplication:

```
Protect> q sess
IBM Spectrum Protect Server Connection Information

Server Name.....: SERVER1
Server Type.....: Windows
Archive Retain Protect..: "No"
Server Version.....: Ver. 6, Rel. 2, Lev. 0.0
Last Access Date.....: 08/25/2009 13:38:18
Delete Backup Files.....: "No"
Delete Archive Files.....: "Yes"
Deduplication.....: "Client Or Server"

Node Name.....: AVI
User Name.....:
```

The following example uses the query management class command to show the type of data that was processed for data deduplication:

```
Protect> q mgmt -det
Domain Name : DEDUP
Activated Policy Set Name : DEDUP
Activation date/time : 08/24/2009 07:26:09
Default Mgmt Class Name : DEDUP
Grace Period Backup Retn. : 30 day(s)
Grace Period Archive Retn.: 365 day(s)

MgmtClass Name : DEDUP
Description : dedup - values like standard
Space Management Technique : None
Auto Migrate on Non-Usage : 0
Backup Required Before Migration: YES
Destination for Migrated Files : SPACEMGPOOL
Copy Group
Copy Group Name.....: STANDARD
Copy Type.....: Backup
Copy Frequency.....: 0 day(s)
Versions Data Exists...: 2 version(s)
Versions Data Deleted..: 1 version(s)
Retain Extra Versions..: 30 day(s)
Retain Only Version....: 60 day(s)
Copy Serialization.....: Shared Static
Copy Mode.....: Modified
Copy Destination.....: AVIFILEPOOL
Lan Free Destination...: NO
Deduplicate Data.....: YES

Copy Group Name.....: STANDARD
Copy Type.....: Archive
Copy Frequency.....: Cmd
Retain Version.....: 365 day(s)
Copy Serialization.....: Shared Static
Copy Mode.....: Absolute
Retain Initiation.....: Create
Retain Minimum.....: 65534 day(s)
Copy Destination.....: FILEPOOL
Lan Free Destination...: NO
Deduplicate Data.....: YES
```

ANSI900I Return code is 0.

**Related concepts:**

Client-side data deduplication

**Related reference:**

CLIENTDEDUPTXNLIMIT option

REGISTER NODE command

UPDATE NODE command

Deduplication

Enablededupcache

Exclude options

## Excluding files from data deduplication

---

You can exclude a file from data deduplication during backup or archive processing.

### About this task

---

**AIX** | **Linux** | **Mac OS X** | **Solaris** You can exclude only files for archive data deduplication. You can exclude files and images (where applicable) for backup data deduplication.

**Windows** You can exclude only files for archive data deduplication. You can exclude files, images, system state objects, and ASR for backup data deduplication.

### Procedure

---

If you do not want certain files to be processed by client-side data deduplication, you can exclude files from data deduplication processing using the GUI:

1. Click Edit > Client Preferences.
2. Click the Include-Exclude tab.
3. Click Add to open the Define Include-Exclude Options window.
4. Select a category for processing.
  - o To exclude a file from data deduplication during archive processing, select Archive in the Category list.
  - o To exclude a file from data deduplication during backup processing, select Backup in the Category list.
5. Select Exclude.Dedup in the Type list.
6. Select an item from the Object Type list.
  - o For archive processing, only the File object type is available.
  - o For backup processing, select one of the following object types:
    - File
    - Image
    - **Windows** System state
    - **Windows** ASR
7. Specify a file or pattern in the File or Pattern field. You can use wildcard characters. If you do not want to type a file or pattern, click Browse to open a selection window and select a file. For mounted file spaces, you can choose the directory mount point from the selection window.

**Windows** For ASR and system state, this field is filled out automatically. When you specify the image object type, the drive letter must be followed by :\*\\* . For example, to exclude drive E:, enter the following pattern:

```
E:*\* \*
```
8. Click OK to close the Define Include-Exclude Options window. The exclude options that you defined are in an exclude statement at the bottom of the Statements list box in the Include-Exclude Preferences tab.
9. Click OK to save your selections and close the Preferences Editor.

### What to do next

---

**AIX** | **Linux** | **Mac OS X** | **Solaris** You can also exclude files from data deduplication processing by editing the dsm.sys file:

1. Add the `deduplication yes` option.
2. Exclude the files in a directory from data deduplication. For example, to exclude the files in the `/Users/Administrator/Documents/Taxes/` directory, add the following statement: `EXCLUDE .dedup`

```
/Users/Administrator/Documents/Taxes/.../*
```

3. Exclude client-side data deduplication for image backup of a file system. For example, to exclude the /home file system, add the following statement: `EXCLUDE.DEDUP /home/*/* IEOBJTYPE=Image`.

**Windows** You can also exclude files from data deduplication processing by editing the `dsm.opt` file:

1. Add the `deduplication yes` option
2. Exclude client-side data deduplication for image backup of drive. For example, to exclude drive E:, add the following statement: `EXCLUDE.DEDUP E:\*\* IEOBJTYPE=Image` to `dsm.opt`.

**Important:** If an object is sent to a data deduplication pool, data deduplication occurs on the server, even if the object is excluded from client-side data deduplication.

**Related concepts:**

Client-side data deduplication

**Related reference:**

Deduplication

Enablededupcache

Exclude options

## Automated client failover configuration and use

---

The backup-archive client can automatically fail over to a secondary server for data recovery when the IBM Spectrum Protect™ server is unavailable. You can configure the client for automated failover or prevent the client from failing over. You can also determine the replication status of your data on the secondary server before you restore or retrieve the replicated data.

- **Automated client failover overview**  
When there is an outage on the IBM Spectrum Protect server, the backup-archive client can automatically fail over to a secondary server for data recovery.
- **Configuring the client for automated failover**  
You can manually configure the client to automatically fail over to the secondary server.
- **Determining the status of replicated client data**  
You can verify whether the most recent backup of the client was replicated to the secondary server before you restore or retrieve client data from the secondary server.
- **Preventing automated client failover**  
You can configure the client to prevent automated client failover to the secondary server.
- **Forcing the client to fail over**  
The client can immediately fail over to the secondary server even if the primary server is operational. For example, you can use this technique to verify that the client is failing over to the expected secondary server.

**Related tasks:**

Restoring or retrieving data during a failover

## Automated client failover overview

---

When there is an outage on the IBM Spectrum Protect™ server, the backup-archive client can automatically fail over to a secondary server for data recovery.

The IBM Spectrum Protect server that the client connects to during normal production processes is called the *primary server*. When the primary server and client nodes are set up for node replication, that server is also known as the *source replication server*. The client data on the source replication server can be replicated to another IBM Spectrum Protect server, which is the *target replication server*. This server is also known as the *secondary server*, and is the server that the client automatically fails over to when the primary server fails.

For the client to automatically fail over to the secondary server, the connection information for the secondary server must be made available to the client. During normal operations, the connection information for the secondary server is automatically sent to the client from the primary server during the logon process. The secondary server information is automatically saved to the client options file. No manual intervention is required by you to add the information for the secondary server.

Each time the client logs on to the IBM Spectrum Protect server, the client attempts to contact the primary server. If the primary server is unavailable, the client automatically fails over to the secondary server, according to the secondary server information in the client options file. In this failover mode, you can restore or retrieve any replicated client data. When the primary server is online again, the client automatically fails back to the primary server the next time the client is started.

**Windows** For example, the following sample text is the connection information about the secondary server that is sent to the client and saved to the client options file (dsm.opt):

```
*** These options should not be changed manually
REPLSERVERNAME          TARGET
  REPLTCPSEVERADDRESS  192.0.2.9
  REPLTCPPOINT         1501
  REPLSSLPORT          1502
  REPLSERVERGUID       60.4a.c3.e1.85.ba.11.e2.af.ce.00.0c.29.2f.07.d3

MYREPLICATIONServer TARGET
MYPRIMARYServer SERVER1
*** end of automatically updated options
```

**AIX | Linux | Mac OS X | Solaris** For example, the following sample text is the connection information that secondary server is sent to the client and saved to the client system options file (dsm.sys):

```
*** These options should not be changed manually
REPLSERVERNAME          TARGET
  REPLTCPSEVERADDRESS  192.0.2.9
  REPLTCPPOINT         1501
  REPLSSLPORT          1502
  REPLSERVERGUID       60.4a.c3.e1.85.ba.11.e2.af.ce.00.0c.29.2f.07.d3

MYREPLICATIONServer TARGET
*** end of automatically updated options
```

- Requirements for automated client failover  
Before you configure or use the client for automated client failover, the backup-archive client and IBM Spectrum Protect server must meet several requirements.
- Restrictions for automated client failover  
Review the following information to better understand the process and the restrictions that apply to automated client failover.
- Failover capabilities of IBM Spectrum Protect components  
IBM Spectrum Protect components and products rely on the backup-archive client or API to back up data to the primary IBM Spectrum Protect server. When the primary server becomes unavailable, some of these products and components can fail over to the secondary server, while others are not capable of failover.

## Requirements for automated client failover

---

Before you configure or use the client for automated client failover, the backup-archive client and IBM Spectrum Protect™ server must meet several requirements.

Ensure that the client meets the following requirements for automated client failover:

- The primary server, secondary server, and backup-archive client must be running IBM Spectrum Protect Version 7.1, or a later version.
- The primary and secondary servers must be set up for node replication.
- The client node must be configured for node replication on the source replication server by using the `REGISTER NODE REPLSTATE=ENABLED` or `UPDATE NODE REPLSTATE=ENABLED` server commands.
- By default, the client is enabled for automated client failover. However, if the `usereplicationfailover no` option is specified in the client options file, either change the value to `yes`, or remove the option.
- Valid connection information for the secondary server must exist in the client options file. During normal operations, this information is automatically sent to the client from the primary server.
- To save the secondary server connection information that is sent from the primary server, the client must have write access to the dsm.opt file on Windows clients, and the dsm.sys file on AIX®, Linux, Mac OS X, and Oracle Solaris clients. If the client does not have write access to these files, the secondary server information is not saved to the client options file, and an error is added to the error log.
- Non-root users cannot use the default location for the node replication table. You must specify a different location by adding the `nrtablepath` option to the dsm.sys file. For more information, see `Nrtablepath`.
- The following processes must occur before the connection information for the secondary server is sent to the options file:
  - The client must be backed up to the source replication server at least one time.
  - The client node must be replicated to the target replication server at least one time.
- Failover occurs for client nodes that are backed up with client-node proxy support when both the target and agent nodes are configured for replication to the target replication server. When the target node is explicitly replicated, the agent node is implicitly replicated to the target replication server as well, along with the proxy relationship.

For example, Node\_B is granted authority to perform client operations on behalf of Node\_A with the following server command:

```
grant proxynode target=Node_A agent=Node_B
```

If both nodes are configured for replication with the `replstate=enabled` option in the node definition, when Node\_A is replicated, Node\_B and the proxy relationship are replicated as well.

## Restrictions for automated client failover

---

Review the following information to better understand the process and the restrictions that apply to automated client failover.

The following restrictions apply for automated client failover:

- When the client is in failover mode, you cannot use any functions that require data to be stored on the secondary server, such as backup or archive operations. You can use only data recovery functions, such as restore, retrieve, or query operations. You can also edit client options and change the IBM Spectrum Protect™ client password.
- Schedules are not replicated to the secondary server. Therefore, schedules are not run while the primary server is unavailable.
- After the client connects to the secondary server in failover mode, it does not attempt to connect to the primary server until the next initial logon to the server. The client attempts to fail over to the secondary server only when the initial connection to the primary server fails. The initial connection is the first connection that the client makes with the server.

If the primary server becomes unavailable during a client operation, the client does not fail over to the secondary server, and the operation fails. You must restart the client so that it can fail over to the secondary server, and then run the client operation again.

Restore operations that are interrupted when the primary server goes down cannot be restarted after the client fails over. You must run the whole restore operation again after the client fails over to the secondary server.

- If the IBM Spectrum Protect password is changed before the client node is replicated, the password will not be synchronized between the primary and secondary servers. If a failover occurs during this time, you must manually reset the password on the secondary server and the client. When the primary server is online again, the password must be reset for the client to connect to the primary server.

If the password is reset while the client is connected to the secondary server, the password must be reset on the primary server before the client can log on to the primary server. This restriction is true if the `passwordaccess` option is set to `generate` or if the password is manually reset.

- If you backed up or archived client data, but the primary server goes down before it replicates the client node, the most recent backup or archive data is not replicated to the secondary server. The replication status of the file space is not current. If you attempt to restore or retrieve the data in failover mode and the replication status is not current, a message is displayed that indicates that the data you are about to recover is out-of-date. You can decide whether to proceed with the recovery or wait until the primary server comes back online.
- If an administrative user ID with client owner authority exists on the source replication server, and the user ID has the same name as the client node, the administrative user ID is replicated during the node replication process on the server. If such a user ID does not exist on the source replication server, the replication process does not create this administrator definition on the target replication server.

If other administrative user IDs are assigned to the node, the IBM Spectrum Protect administrator must manually configure the administrative user IDs on the target replication server. Otherwise, the administrative user cannot connect to the target replication server (secondary server) with the IBM Spectrum Protect web client.

- If you restore a file from the IBM Spectrum Protect, and the file system is managed by IBM Spectrum Protect for Space Management, you must not restore the file as a stub file. You must restore the complete file. Use the `restoremigstate=no` option to restore the complete file. If you restore the file as a stub from the target server, the following consequences can occur:
  - You cannot recall the file from the IBM Spectrum Protect source server by using the IBM Spectrum Protect for Space Management client.
  - The IBM Spectrum Protect for Space Management reconciliation process that runs against the IBM Spectrum Protect source server expires the file. If the file is expired by a reconciliation process, you can restore the complete file with the backup-archive client and the `restoremigstate=no` option.

## Failover capabilities of IBM Spectrum Protect components

IBM Spectrum Protect™ components and products rely on the backup-archive client or API to back up data to the primary IBM Spectrum Protect server. When the primary server becomes unavailable, some of these products and components can fail over to the secondary server, while others are not capable of failover.

To learn more about the failover capabilities of IBM Spectrum Protect components and products, see technote 1649484.

### Related tasks:

Determining the status of replicated client data

## Configuring the client for automated failover

You can manually configure the client to automatically fail over to the secondary server.

### Before you begin

Before you begin the configuration:

- Ensure that the client node participates in node replication on the primary server.
- Ensure that the client meets the requirements for automated client failover.
- Use this procedure only if the connection information for the secondary server is not current or if it is not in the client options file.

### About this task

You might manually configure the client for automated failover in the following situations:

- The secondary server configuration was changed and the primary server is down before the client logs on to the server. When you manually add the connection information, the client is enabled for failover to the secondary server.
- You accidentally erased some or all of the secondary server connection information in the client options file.  
Tip: Instead of manually configuring the client options file, you can run the `dsmc q session` command, which prompts you to log on to the primary server. The connection information for the secondary server is sent automatically to the client options file.

### Procedure

To manually configure the client for automated failover, complete the following steps:

1. Ensure that the client is enabled for automated client failover by verifying that the `usereplicationfailover` option is either not in the client options file or is set to `yes`. By default, the client is enabled for automated client failover so the `usereplicationfailover` is not required in the client options file.
2. Obtain the connection information about the secondary server from the IBM Spectrum Protect server administrator and add the information to the beginning of the client options file. Group the statements into a stanza under the `replservername` statement.

**AIX** | **Linux** | **Mac OS X** | **Solaris** For example, add the following statements to the `dsm.sys` file:

```
REPLSERVERNAME          TARGET
REPLTCPSERVERADDRESS    192.0.2.9
REPLTCPSPORT             1501
REPLSSLPORT              1502
REPLSERVERGUID           60.4a.c3.e1.85.ba.11.e2.af.ce.00.0c.29.2f.07.d3
```

```
SErvername      server_a
COMMMethod      TCPip
TCPPort         1500
TCPServeraddress server_hostname1.example.com
PASSWORDAccess  prompt
MYREPLICATIONServer TARGET
```

**Windows** For example, add the following statements to the `dsm.opt` file:

```
REPLSERVERNAME          TARGET
REPLTCPSERVERADDRESS    192.0.2.9
```



```
REPLTCPPORT      1501
REPLSSLPORT      1502
REPLSERVERGUID   60.4a.c3.e1.85.ba.11.e2.af.ce.00.0c.29.2f.07.d3
```

```
MYREPLICATIONServer TARGET
MYPRIMARYSERVERNAME SERVER1
```

3. **AIX** **Linux** **Mac OS X** **Solaris** Non-root users must specify a location for the node replication table by adding the `nrtablepath` option to the `dsm.sys` file. The backup-archive client uses this table to store information about each backup or archive operation to the IBM Spectrum Protect server.

You must specify a location that your user ID has write access to. For example:

```
nrtablepath /Volumes/nrtbl
```

Restriction: Do not specify the root directory (/) for the location of the node replication table.

4. Save and close the client options file.
5. Restart the backup-archive client GUI or log on to the IBM Spectrum Protect server from the command-line interface. The client is connected to the secondary server.

## Example

---

After you configured the client for automated client failover, and the client attempts to log on to the server, the following sample command output is displayed:

```
IBM Spectrum Protect
Command Line Backup-Archive Client Interface
  Client Version 8, Release 1, Level 0.0
  Client date/time: 12/16/2016 12:05:35
(c) Copyright by IBM Corporation and other(s) 1990, 2016. All Rights Reserved.

Node Name: MY_NODE_NAME
ANS2106I Connection to primary IBM Spectrum Protect server 192.0.2.1 failed

ANS2107I Attempting to connect to secondary server TARGET at 192.0.2.9 : 1501

Node Name: MY_NODE_NAME
Session established with server TARGET: Windows
  Server Version 8, Release 1, Level 0.0
  Server date/time: 12/16/2016 12:05:35  Last access: 12/15/2016 09:55:56

  Session established in failover mode to secondary server
ANS2108I Connected to secondary server TARGET.
```

## What to do next

---

You can restore or retrieve any replicated data in failover mode.

### Related concepts:

Automated client failover overview

### Related tasks:

Restoring or retrieving data during a failover

### Related reference:

Forcefailover

**Windows** Myprimaryserver

Myreplicationserver

Nrtablepath

Replserverguid

Replservername

Replsslport

Repltcpport

Repltcpserveraddress

Usereplicationfailover

## Determining the status of replicated client data

---

You can verify whether the most recent backup of the client was replicated to the secondary server before you restore or retrieve client data from the secondary server.

## About this task

---

You can obtain the status of replicated client data to determine whether the most recent client backup was replicated to the secondary server.

If the time stamp of the most recent backup operation on the client matches the time stamp of the backup on the secondary server, the replication status is current.

If the time stamp of the most recent backup operation is different from the time stamp of the backup on the secondary server, the replication status is not current. This situation can occur if you backed up the client, but before the client node can be replicated, the primary server goes down.

## Procedure

---

To determine the status of replicated client data, issue the following command at the command prompt:

```
dsmc query filespace -detail
```

The following sample output shows that the time stamps on the server and the client match, therefore the replication status is current:

#	Last Incr Date	Type	fsID	Unicode	Replication	File Space Name
1	00/00/0000 00:00:00	HFS	9	Yes	Current	/
	Last Store Date	Server		Local		
	-----	-----		-----		
	Backup Data :	04/22/2013 19:39:17		04/22/2013 19:39:17		
	Archive Data :	No Date Available		No Date Available		

The following sample output shows that time stamps on the server and the client do not match, therefore the replication status is not current:

#	Last Incr Date	Type	fsID	Unicode	Replication	File Space Name
1	00/00/0000 00:00:00	HFS	9	Yes	Not Current	/
	Last Store Date	Server		Local		
	-----	-----		-----		
	Backup Data :	04/22/2013 19:39:17		04/24/2013 19:35:41		
	Archive Data :	No Date Available		No Date Available		

## What to do next

---

If you attempt to restore the data in failover mode and the replication status is not current, a message is displayed that indicates that the data you are about to restore is old. You can decide whether to proceed with the restore or wait until the primary server is online.

### Related tasks:

Restoring or retrieving data during a failover

### Related reference:

Nrtablepath

## Preventing automated client failover

---

You can configure the client to prevent automated client failover to the secondary server.

## About this task

---

You might want to prevent automated client failover, for example, if you know that the data on the client node was not replicated to the secondary server before the primary server went offline. In this case, you do not want to recover any replicated data from the secondary server that might be old.

## Procedure

---

To prevent the client node from failing over to the secondary server, add the following statement to the client options file:

```
usereplicationfailover no
```

This setting overrides the configuration that is provided by the IBM Spectrum Protect™ server administrator on the primary server.

## Results

---

The client node does not automatically fail over to the secondary server the next time it tries to connect to the offline primary server.

### Related tasks:

Determining the status of replicated client data

### Related reference:

Usereplicationfailover

## Forcing the client to fail over

---

The client can immediately fail over to the secondary server even if the primary server is operational. For example, you can use this technique to verify that the client is failing over to the expected secondary server.

## Procedure

---

To force the client to immediately fail over to the secondary server, complete the following steps:

1. **AIX** | **Linux** | **Mac OS X** | **Solaris** Add the forcefailover yes option in the client-system options file (dsm.sys).
2. **Windows** Add the forcefailover yes option in the client options file (dsm.opt).
3. Connect to the secondary server by restarting the backup-archive client GUI or by starting a command session with the dsmc command.
4. Optional: Instead of updating the options file, you can establish a connection with the secondary server by specifying the `-forcefailover=yes` option with a command. For example:

```
dsmc q sess -forcefailover=yes
```

## What to do next

---

You can verify that you are connected to the secondary server with one of the following methods:

- Check the Secondary Server Information field in the Connection Information window in the backup-archive client GUI.
- Check the command output when you start a command session. The status of the secondary server is displayed in the output.

**Linux** | **Windows**

## Configuring the client to back up and archive Tivoli Storage Manager FastBack data

---

Before you can back up or archive Tivoli® Storage Manager FastBack client data, you must complete configuration tasks.

First ensure that you have configured the backup-archive client and that you installed the Tivoli Storage Manager FastBack client.

Install the FastBack client by using the information at Tivoli Storage Manager FastBack.

**Linux** After you install the FastBack client, complete the following tasks:

**Windows** After you install the FastBack client, complete the following tasks. You can also use the Client Configuration wizard for Tivoli Storage Manager FastBack.

1. Register a node for each FastBack client where data is backed up or archived. The node name must be the short host name of the FastBack client.

This is a one-time configuration performed once for each FastBack client whose volumes need to be backed up or archived.

This registration step must be performed manually only when the backup-archive client is used as a stand-alone application.

The Administration Center does this node registration automatically when the user creates schedules for archiving or backing up FastBack data using the Administration Center. Starting with Version 7.1, the Administration Center component is no longer included in Tivoli Storage Manager or IBM Spectrum Protect™ distributions. FastBack users who have an Administration Center from a previous server release can continue to use it to create and modify FastBack schedules. If you do not already have an Administration Center installed, you can download the previously-released version from <ftp://public.dhe.ibm.com/storage/tivoli-storage-management/maintenance/admincenter/v6r3/>. If you do not have an Administration Center installed, you must create and modify FastBack schedules on the IBM Spectrum Protect server. For information about creating schedules on the server, see the IBM Spectrum Protect server documentation.

2. Use the server GRANT PROXY command to grant proxy authority to your current backup-archive client node on each node representing the FastBack client created in step 1. The FastBack node should be the target, and the current client node should be the proxy.

This is a one-time configuration, and is performed by the Administration Center if the backup or archive is initiated by the Administration Center.

3. Run the set password command to store the credentials of the FastBack repositories where the backup-archive client connects. Run the `set password -type=fastback` command once for each repository where the backup-archive client is expected to connect.

The credentials that are stored depends on these configurations:

- Backup-archive client on the FastBack server
- Backup-archive client on the FastBack Disaster Recovery Hub
- Backup-archive client on a dedicated proxy workstation

For information about integrating IBM Spectrum Protect and Tivoli Storage Manager FastBack, see [Integrating Tivoli Storage Manager FastBack and IBM Spectrum Protect](#).

#### Related concepts:

Installation requirements for backing up and archiving Tivoli Storage Manager FastBack client data

 Client configuration wizard for Tivoli Storage Manager FastBack

 Configuring the backup-archive client to protect FastBack client data

#### Related reference:

Set Password



## Configuring the backup-archive client to protect FastBack client data

---

You can configure the backup-archive client to protect FastBack client data by using the client configuration wizard.

Before you can use the IBM Spectrum Protect™ Client Configuration wizard for FastBack, you must complete the following tasks:

- Ensure that either the FastBack server, or the FastBack Disaster Recovery Hub, is installed and configured for short-term data retention.
- Also ensure that at least one snapshot has been taken.
- Ensure that the backup-archive client is properly configured with the IBM Spectrum Protect server. Also make sure that the client acceptor service (`dsmcad.exe`) is running. You can use the IBM Spectrum Protect Client Configuration wizard in the backup-archive client GUI, after you install the backup-archive client.
- Complete a one-time post-installation setup for these purposes:
  - To specify the FastBack user name and password to be used by the wizard, to query and mount volumes from the FastBack repository
  - To run IBM Spectrum Protect scheduler scripts
- Set up the FastBack credentials file. The user ID that you specify must have Tivoli® Storage Manager FastBack administrative authority.
  1. Configure the user ID and password. Run the following command on the workstation where the backup-archive client and FastBack server or Disaster Recovery Hub are installed:

```
cd <TSM_FastBack_install_location>\FastBack\shell
```

where <TSM\_FastBack\_install\_location> is the directory location where the Tivoli Storage Manager FastBack client is installed.

2. If it does not exist, create a folder called FastbackTSMScripts under the system drive of the workstation, using the following command:

```
mkdir <machine_system_drive>:\FastbackTSMScripts
```

3. Run the fastbackshell command:

```
FastBackShell -c encrypt -u userName -d domain -p password -f  
<machine_system_drive>:\FastbackTSMScripts\credential.txt
```

The following options are used in the preceding command example:

- -u specifies the Tivoli Storage Manager FastBack administrator user name.
- -p specifies the Tivoli Storage Manager FastBack administrator password.
- -d specifies the Tivoli Storage Manager FastBack domain for the user name.
- -f specifies the output file where the encrypted credentials are to be written.

Important: The credentials file must be generated with the name "credential.txt". The credentials file must also be located in the FastbackTSMScripts directory of the system drive of the workstation, for the wizard to function properly.

You can use the client configuration wizard in the backup-archive client Java™ GUI or the backup-archive web client.

Follow these steps to use the client configuration wizard in the Java GUI:

1. Ensure that the backup-archive client is properly configured with the IBM Spectrum Protect server.
2. The configuration wizard starts automatically to create the configuration file.
3. Follow the instructions on the panel to complete the wizard.
4. From the backup-archive client GUI main window, select Utilities > Setup Wizard.
5. From the welcome page, select Help me configure the client to protect FastBack client data and click Next.
6. Use the wizard to complete the configuration process.

Follow these steps to start the client configuration wizard in the web client:

1. Ensure that the web client is properly configured with the IBM Spectrum Protect server, and that the IBM Spectrum Protect client acceptor service is running.

To configure the web client, follow these steps:

- a. From the backup-archive client GUI main window in the Java GUI, click Utilities > Setup Wizard.
  - b. From the welcome page, select Help me configure the Web Client and click Next. Follow the instructions on the panel to complete the wizard.
2. Start the web client. In your web browser, specify the client node name and port number where the client acceptor service is running.

For example: `http://<machine_name_or_ip_address>:1585`

3. From the backup-archive client GUI main window, click Utilities > Setup Wizard.
4. From the welcome page, select Help me configure the client to protect FastBack client data, and click Next.
5. Use the wizard to complete the configuration process.

#### Related concepts:

Client configuration wizard for Tivoli Storage Manager FastBack

AIX Linux Solaris Mac OS X

## Cluster environment configuration and use

---

The term *cluster* has different meanings in different environments. It can mean highly available, high performance, load balancing, grid computing, or some combination of all of these terms.

There are currently several clustering products available for UNIX and Linux, and this section defines those aspects of a clustering environment that need to exist in order for this backup methodology to work correctly. A basic understanding of how your cluster software functions is needed. Cluster software related activities such as the development of application start and stop scripts are not described in this section.

A cluster environment refers to a UNIX or a Linux environment which exhibits the following characteristics:

- Disks are shared between physical workstations, either in an exclusive fashion (only one host has access to the logical disk at any one time) or in a concurrent fashion.
- Disks appear as local disks to the host and not as network resources.  
Important: Mount the file systems locally to the system, not through a LAN-based file share protocol such as network file system (NFS).
- Mount points of local disks are identical on each physical host in the environment (if file system `/group1_disk1` fails from NodeA to NodeB, it is mounted on NodeB as `/group1_disk1`).
- [Mac OS X](#) | [AIX](#) | [Linux](#) | [Solaris](#) **Overview of cluster environments**  
Cluster environments can be set up in many different configurations. This section describes the most popular cluster configurations.
- [Mac OS X](#) | [AIX](#) | [Linux](#) | [Solaris](#) **Configuring the backup-archive client in a cluster environment**  
The backup-archive client is designed to manage the backup of cluster drives by placing the backup-archive client within the context of the cluster's resource groups.
- [Mac OS X](#) | [AIX](#) | [Linux](#) | [Solaris](#) **Enabling web client access in a Cluster Environment**  
If IBM Spectrum Protect™ web client access is needed during a failover condition, you must configure the web client acceptor daemon that is associated with the cluster to failover along with the cluster resource.
- [AIX](#) **Migrating legacy AIX/IBM PowerHA SystemMirror setups**  
If you are currently using the backup-archive client in an IBM® PowerHA® SystemMirror® environment using the `clusternode` option, you must update your current configurations. The `clusternode` option is no longer supported.

[AIX](#) | [Linux](#) | [Solaris](#) | [Mac OS X](#)

## Overview of cluster environments

---

Cluster environments can be set up in many different configurations. This section describes the most popular cluster configurations.

- [Mac OS X](#) | [AIX](#) | [Linux](#) | [Solaris](#) **Active/Active: Pool cluster resources**  
In an active/active configuration, each node is actively managing at least one resource and is configured as a backup for one or more resources in the cluster. Active/active is the most common form of a cluster environment.
- [Mac OS X](#) | [AIX](#) | [Linux](#) | [Solaris](#) **Active/Passive: Fault tolerant**  
In an active/passive configuration, one node actively manages the resource.
- [Mac OS X](#) | [AIX](#) | [Linux](#) | [Solaris](#) **Concurrent access**  
In a concurrent configuration, more than one node manages a resource. When a fault occurs, the resource continues to be managed by the other nodes.

[AIX](#) | [Linux](#) | [Solaris](#) | [Mac OS X](#)

## Active/Active: Pool cluster resources

---

In an active/active configuration, each node is actively managing at least one resource and is configured as a backup for one or more resources in the cluster. Active/active is the most common form of a cluster environment.

[AIX](#) | [Linux](#) | [Solaris](#) | [Mac OS X](#)

## Active/Passive: Fault tolerant

---

In an active/passive configuration, one node actively manages the resource.

The other node is only used if the primary node experiences a fault and the resource needs to failover. An active/passive cluster is a subtype of an active/active cluster.

[AIX](#) | [Linux](#) | [Solaris](#) | [Mac OS X](#)

## Concurrent access

---

In a concurrent configuration, more than one node manages a resource. When a fault occurs, the resource continues to be managed by the other nodes.

[AIX](#) | [Linux](#) | [Solaris](#) | [Mac OS X](#)

# Configuring the backup-archive client in a cluster environment

---

The backup-archive client is designed to manage the backup of cluster drives by placing the backup-archive client within the context of the cluster's resource groups.

## About this task

---

This gives the advantage of backing up data from local resources (as opposed to accessing the data across the network) to maximize the performance of the backup operation and to manage the backup data relative to the resource group. Therefore, the backup-archive client can always back up data on cluster resources as if the data were local data and maximize backup performance. This ensures that critical data is getting backed up across system failures.

For example, an active/active cluster environment has three physical hosts in the cluster named `NodeA`, `NodeB`, and `NodeC`.

The nodes have the following qualities:

- `NodeA` owns the cluster resource with file systems `/A1` and `/A2`
- `NodeB` owns the cluster resources with file systems `/B1` and `/B2`
- `NodeC` owns the cluster resources with file systems `/C1` and `/C2`

Note: `NodeA` might also have two non-clustered volumes, `/fs1` and `/fs2`, that must be backed up.

For best backup performance, you might want all nodes in the cluster to perform the backups of the shared file systems that they own. When a node failover occurs, the backup tasks of the failed node shift to the node to which the failover occurred. For example, when `NodeA` fails over to `NodeB`, the backup of `/A1` and `/A2` moves to `NodeB`.

The following are prerequisites before configuring the backup-archive client to back up cluster and non-cluster volumes:

- A separate backup-archive client scheduler process must be run for each resource group being protected. In normal conditions, each node would have two scheduler processes: one for the cluster resources, and one for the local file systems. After a failure, additional scheduler processes are started on a node in order to protect the resources that have moved over from another node.
- The backup-archive client password files must be stored on cluster disks so that after a failure, the generated backup-archive client password is available to the takeover node.
- The file systems to be protected as part of a resource group are defined using the backup-archive client domain option. The domain option is specified in the `dsm.sys` file, which should also be stored on a cluster disk so that it can be accessed by the takeover node.

Follow the steps below to configure the backup-archive client in a cluster environment.

## Procedure

---

1. Register backup-archive client node definitions on the IBM Spectrum Protect™ server. All nodes in the cluster must be defined on the IBM Spectrum Protect server. If you are defining multiple cluster resources in a cluster environment to failover independently, then unique node names must be defined per resource group. For the above sample three-way active/active cluster configuration, define three nodes (one per resource), as follows: (1) `Protect: IBM>register node nodeA nodeApw domain=standard`, (2) `Protect: IBM>register node nodeB nodeBpw domain=standard`, (3) `Protect: IBM>register node nodeC nodeCpw domain=standard`.
2. Configure the backup-archive client system-options file. Each node in the cluster must have separate server stanzas for each cluster resource group in order to be backed up in each respective `dsm.sys` file. You must ensure that the server stanzas are identical in the system option files on each node. Alternatively, you can place the `dsm.sys` file on a shared cluster location. The server stanzas defined to back up clustered volumes must have the following special characteristics:
  - The `nodename` option must refer to the client node name registered on the IBM Spectrum Protect server. If the client node name is not defined, the node name defaults to the host name of the node, which might conflict with other node names used for the same client system.  
Important: Use the `nodename` option to explicitly define the client node.
  - The `tcpclientaddress` option must refer to the service IP address of the cluster node.
  - The `passworddir` option must refer to a directory on the shared volumes that are part of the cluster resource group.
  - The `errorlogname` and `schedlogname` options must refer to files on the shared volumes that are part of the cluster resource group to maintain a single continuous log file.
  - All `include exclude` statements must refer to files on the shared volumes that are part of the cluster resource group.
  - If you use the `inlexcl` option, it must refer to a file path on the shared volumes that are part of the cluster group.
  - The stanza names identified with the `servername` option must be identical on all systems.

3. Other backup-archive client options can be set as needed. In the following example, all three nodes, NodeA, NodeB, and NodeC, must have the following three server stanzas in their `dsm.sys` file:

```
Servername      server1_nodeA
nodename        NodeA
commmethod      tcpip
tcpport         1500
tcpserveraddress server1.example.com
tcpclientaddress nodeA.example.com
passwordaccess  generate
passworddir     /A1/tsm/pwd
manageservices  schedule
schedlogname    /A1/tsm/dsmsched.log
errorlogname    /A1/tsm/errorlog.log
```

```
Servername      server1_nodeB
nodename        NodeB
commmethod      tcpip
tcpport         1500
tcpserveraddress server1.example.com
tcpclientaddress nodeB.example.com
passwordaccess  generate
passworddir     /B1/tsm/pwd
manageservices  schedule
schedlogname    /B1/tsm/dsmsched.log
errorlogname    /B1/tsm/errorlog.log
```

```
Servername      server1_nodeC
nodename        NodeC
commmethod      tcpip
tcpport         1500
tcpserveraddress server1.example.com
tcpclientaddress nodeC.example.com
passwordaccess  generate
passworddir     /C1/tsm/pwd
manageservices  schedule
schedlogname    /C1/tsm/dsmsched.log
errorlogname    /C1/tsm/errorlog.log
```

4. Configure the backup-archive client user-options file. The options file (`dsm.opt`) must reside on the shared volumes in the cluster resource group. Define the `DSM_CONFIG` environment variable to refer to this file. Ensure that the `dsm.opt` file contains the following settings:

- o The value of the servername option must be the server stanza in the `dsm.sys` file which defines parameters for backing up clustered volumes.
- o Define the clustered file systems to be backed up with the domain option.  
Note: Ensure that you define the domain option in the `dsm.opt` file or specify the option in the schedule or on the backup-archive client command line. This is to restrict clustered operations to cluster resources and non-clustered operations to non-clustered resources.

In the example, nodes NodeA, NodeB, and NodeC set up their corresponding `dsm.opt` file and `DSM_CONFIG` environment variable as follows:

**NodeA:**

- 1) Set up the `/A1/tsm/dsm.opt` file:

```
servername server1_nodeA
domain      /A1 /A2
```

- 2) Issue the following command or include it in your user profile:

```
export DSM_CONFIG=/A1/tsm/dsm.opt
```

**NodeB:**

- 1) Set up the `/B1/tsm/dsm.opt` file:

```
servername server1_nodeB
domain      /B1 /B2
```

- 2) Issue the following command or include it in your user profile:



```
export DSM_CONFIG=/B1/tsm/dsm.opt
```

**NodeC:**

1) Set up the /C1/tsm/dsm.opt file:

```
servername server1_nodeC  
domain /C1 /C2
```

2) Issue the following command or include it in your user profile:

```
export DSM_CONFIG=/C1/tsm/dsm.opt
```

5. Set up the schedule definitions for each cluster resource group. After the basic setup is completed, define the automated schedules to back up cluster resources to meet the backup requirements. The procedure illustrates the schedule setup by using the built-in IBM Spectrum Protect scheduler. If you are using a vendor-acquired scheduler, refer to the documentation provided by the scheduler vendor.

- o Define a schedule in the policy domain where cluster nodes are defined. Ensure that the schedule's startup window is large enough to restart the schedule on the failover node in case of a failure and fallback event. This means that the schedule's duration must be set to longer than the time it takes to complete the backup of the cluster data for that node, under normal conditions.

If the reconnection occurs within the start window for that event, the scheduled command is restarted. This scheduled incremental backup reexamines files sent to the server before the failover. The backup then "catches up" to where it stopped before the failover situation.

In the following example, the `clus_backup` schedule is defined in the standard domain to start the backup at 12:30 A.M. every day with the duration set to two hours (which is the normal backup time for each node's data).

```
Protect: IBM>define schedule standard clus_backup action=incr  
starttime=00:30 startdate=TODAY Duration=2
```

- o Associate the schedule with the all of the backup-archive client nodes defined to backup cluster resources, as follows: (1) `Protect: IBM>define association standard clus_backup nodeA`, (2) `Protect: IBM>define association standard clus_backup nodeB`, (3) `Protect: IBM>define association standard clus_backup nodeC`.

6. Set up the scheduler service for backup. On each client node, a scheduler service must be configured for each resource that the node is responsible for backing up, under normal conditions. The `DSM_CONFIG` environment variable for each resource scheduler service must be set to refer to the corresponding `dsm.opt` file for that resource. For the sample configuration, the following shell scripts must be created to allow `dsmcad` processes to be started, as needed, from any node in the cluster.

```
NodeA: /A1/tsm/startsched  
#!/bin/ksh  
export DSM_CONFIG=/A1/tsm/dsm.opt  
dsmcad  
NodeB: /B1/tsm/startsched  
#!/bin/ksh  
export DSM_CONFIG=/B1/tsm/dsm.opt  
dsmcad  
NodeC: /C1/tsm/startsched  
#!/bin/ksh  
export DSM_CONFIG=/C1/tsm/dsm.opt  
dsmcad
```

7. Define the backup-archive client to the cluster application. To continue the backup of the failed resource after a failover condition, the IBM Spectrum Protect scheduler service (for each cluster client node) must be defined as a resource to the cluster application in order to participate in the failover processing. This is required in order to continue the backup of the failed resources from the node that takes over the resource. Failure to do so would result in the incomplete backup of the failed resource. The sample scripts in step 5 can be associated with the cluster resources to ensure that they are started on nodes in the cluster while the disk resources being protected move from one node to another. The actual steps required to set up the scheduler service as a cluster resource are specific to the cluster software. Refer to your cluster application documentation for additional information.

8. Ensure that the password for each node is generated and cached correctly in the location specified using the `passworddir` option. This can be validated by performing the following steps:

- a. Validate that each node can connect to the IBM Spectrum Protect server without the password prompt. You can do this by running the backup-archive client command line interface and issuing the following command on each node:

```
#dsmc query session
```

If you are prompted to submit your password, enter the password to run the command successfully and rerun the command. The second time, the command should run without the prompt for the password. If you get prompted for the password, check your configuration.

- b. Validate that the other nodes in the cluster can start sessions to the IBM Spectrum Protect server for the failed-over node. This can be done by running the same commands, as described in the step above, on the backup nodes. For example, to validate if `NodeB` and `NodeC` can start a session as `NodeA` in the failover event without prompting for the password, perform the following commands on `NodeB` and `NodeC`

```
#export DSM_CONFIG=/A1/tsm/dsm.opt
#dsmc query session
```

The prompt for the password might appear at this time, but this is unlikely. If you are prompted, the password was not stored in the shared location correctly. Check the `passworddir` option setting used for `NodeA` and follow the configuration steps again.

- c. Ensure that the schedules are run correctly by each node. You can trigger a schedule by setting the schedule's start time to `now`. Remember to reset the start time after testing is complete.

```
Protect: IBM>update sched standard clus_backup starttime=now
```

- d. Failover and fallback between `nodeA` and `nodeB`, while `nodeA` is in the middle of the backup and the schedule's start window, is still valid. Verify that the incremental backup continues to run and finish successfully after failover and fallback.
- e. Issue the command below to cause a node's (`nodeA`) password to expire. Ensure that backup continues normally under normal cluster operations, as well as failover and fallback:

```
Protect: IBM>update node nodeA forcep=yes
```

## 9. Configure the backup-archive client to back up local resources.

- a. Define client nodes on the IBM Spectrum Protect server. Local resources should never be backed up or archived using node names defined to back up cluster data. If local volumes that are not defined as cluster resources are backed up, separate node names (and separate client instances) must be used for both non-clustered and clustered volumes.

In the following example, assume that only `NodeA` has local file systems `/fs1` and `/fs2` to be backed up. In order to manage the local resources, register a node `NodeA_local` on the IBM Spectrum Protect server: `Protect`:

```
IBM>register node nodeA_local nodeA_localpw domain=standard.
```

- b. Add a separate stanza in each node's system options file `dsm.sys` that must back up local resources with the following special characteristics:
  - The value of the `tcpclientaddress` option must be the local host name or IP address. This is the IP address used for primary traffic to and from the node.
  - If the client backs up and restores non-clustered volumes without being connected to the cluster, the value of the `tcpclientaddress` option must be the boot IP address. This is the IP address used to start the system (node) before it rejoins the cluster:

Example stanza for `NodeA_local`:

```
Servername      server1_nodeA_local
nodename        nodeA_local
commmethod      tcpip
tcpport         1500
tcpserveraddress server1.example.com
tcpclientaddress nodeA_host.example.com
passwordaccess  generate
managedservices schedule
```

- c. Define the user options file `dsm.opt` in a path that is on a non-clustered resource.
  - The value of the `servername` option must be the server stanza in the `dsm.sys` file which defines parameters for backing up non-clustered volumes.
  - Use the `domain` option to define the non-clustered file systems to be backed up.

Note: Ensure that you define the `domain` option in the `dsm.opt` file or specify the option in the schedule or on the backup-archive client command line, in order to restrict the backup-archive operations to non-clustered volumes.

In the following example, nodeA uses the following `/home/admin/dsm.opt` file and sets up the `DSM_CONFIG` environment to refer to `/home/admin/A1.dsm.opt`.

Contents of `/home/admin/A1.dsm.opt`

```
servername ibm_nodeA_local
domain     /fs1 /fs2
```

```
export DSM_CONFIG=/home/admin/A1.dsm.opt
```

d. Define and set up a schedule to perform the incremental backup for non-clustered file systems.

```
Protect: IBM>define schedule standard local_backup action=incr
starttime=00:30 startdate=TODAY Duration=2
```

Associate the schedule with all of the backup-archive client nodes that are defined to backup non-clustered resources.

```
Protect: IBM>define association standard nodeA_local
```

10. Restore cluster file system data. All volumes in a cluster resource are backed up under the target node defined for that cluster resource. If you need to restore the data that resides on a cluster volume, it can be restored from the client node that owns the cluster resource at the time of the restore. The backup-archive client must use the same user options file (`dsm.opt`) that was used during the backup to restore the data. There are no additional setup requirements necessary to restore data on cluster volumes.
11. Restore local file system data. The non-clustered volumes are backed up under the separate node name setup for non-clustered operations. In order to restore this data, the backup-archive client must use the same user options file `dsm.opt` that was used during the backup. In the example, set environment variable `DSM_CONFIG` to refer to `/home/admin/A1.dsm.opt` prior to performing a client restore for the local node `nodeA_local`.

#### Related concepts:

Restoring your data

AIX

Linux

Solaris

Mac OS X

## Enabling web client access in a Cluster Environment

---

If IBM Spectrum Protect™ web client access is needed during a failover condition, you must configure the web client acceptor daemon that is associated with the cluster to failover along with the cluster resource.

### Before you begin

---

Beginning with IBM Spectrum Protect Version 8.1.2, you can no longer use the web client to connect to the IBM Spectrum Protect V8.1.2 or later server. However, you can still use the web client to connect to IBM Spectrum Protect V8.1.1, V8.1.0, or V7.1.7 and earlier servers. For more information, see *Using the web client in the new security environment*.

### About this task

---

After you have completed the configuration steps described in the *Configuring the backup-archive client in a cluster environment* section, perform the additional steps described below to complete the web client access setup:

### Procedure

---

1. Set up the client acceptor daemon to manage the web client and scheduler. The client acceptor daemon should be set up to manage schedulers as well as web client access. This reduces the number of daemons that need to be configured as cluster applications and thus simplifies the configuration and administration. When a failover occurs, the client acceptor starts on the node that is managing the takeover.
2. Update the `managerservices` option in the system-options file `dsm.sys` on each node for each server stanza, as shown below for NodeA

```
Servername      server1_NodeA
nodename        NodeA
commmethod      tcpip
tcpip           1500
tcps            server1.example.com
tcpclientaddress nodeA.example.com
```

```

passwordaccess    generate
passworddir      /A1/tsm/pwd
schedlogn        /A1/tsm/dsmsched.log
errorlogname     /A1/tsm/errorlog.log
managementservices webclient schedule

```

3. Set up the client acceptor daemon to use a known HTTP port. By default, the client acceptor daemon uses HTTP port 1581, when available, for the web client access. If this port is not available, the client acceptor finds the first available port, starting with 1581. In a failover condition of an active-active cluster configuration, a failover cluster host system is probably running multiple instances of the client acceptor. If default settings are used for the HTTP port, the failover node uses any available port for the client acceptor being failed over, since the default port is probably in use by the current client acceptor processes of the failover host. This causes problems for the web client associated with the client acceptor that failed over, as the new HTTP port is not known to the web client users. You might use the `httpport` option to specify the specific ports for the web client access for each resource. This allows you to always use the same port when connecting from a web browser, independent of the node serving the cluster resource. Add the `httpport` option in the `system-options` file (`dsm.sys`) on each node for each server stanza as follows, making sure that each stanza uses a unique value:

```

Servername       server1_NodeA
nodename         NodeA
commmethod       tcpip
tcpp             1500
tcps            server1.example.com
tcpclientaddress nodeA.example.com
passwordaccess   generate
passworddir     /A1/tsm/pwd
managementservices webclient schedule
schedlogn       /A1/tsm/dsmsched.log
errorlogname    /A1/tsm/errorlog.log
httpport        1510

```

```

Servername       server1_NodeB
nodename         NodeB
commmethod       tcpip
tcpp             1500
tcps            server1.example.com
tcpclientaddress nodeB.example.com
passwordaccess   generate
passworddir     /B1/tsm/pwd
managementservices webclient schedule
schedlogn       /B1/tsm/dsmsched.log
errorlogname    /B1/tsm/errorlog.log
httpport        1511

```

```

Servername       server1_NodeC
nodename         NodeC
commmethod       tcpip
tcpp             1500
tcps            server1.example.com
tcpclientaddress nodeC.example.com
passwordaccess   generate
passworddir     /C1/tsm/pwd
managementservices webclient schedule
schedlogn       /C1/tsm/dsmsched.log
errorlogname    /C1/tsm/errorlog.log
httpport        1512

```

AIX

## Migrating legacy AIX® IBM PowerHA SystemMirror setups

If you are currently using the backup-archive client in an IBM® PowerHA® SystemMirror® environment using the `clusternode` option, you must update your current configurations. The `clusternode` option is no longer supported.

### About this task

Perform the following steps to update your current configurations:

## Procedure

1. Update the backup-archive client system-options file. As with the `clusternode` option, each node in the cluster must continue to have separate server stanzas for each cluster resource group to be backed up in each respective `dsm.sys` file. The existing `dsm.sys` file for NodeA might appear as follows:

```
Servername          server1_nodeA
commmethod          tcpip
tcpp                1500
tcps               server1.example.com
tcpclientaddress    nodeA.example.com
passwordaccess      generate
passworddir         /A1
clusternode         yes
manageservices      schedule
schedlogn           /A1/dsmsched.log
errorlogname        /A1/errorlog.log
```

2. Notice that no `nodename` option is used in this sample. Make the following changes to the existing `dsm.sys` file for NodeA.
  - o Remove the `clusternode` option.
  - o Specify a `nodename` option if you do not have one already specified.
3. The new `dsm.sys` file for NodeA should appear as follows:

```
Servername          server1_nodeA
commmethod          tcpip
nodename            myclus (myclus is the existing cluster name )
tcpp                1500
tcps               server1.example.com
tcpclientaddress    nodeA.example.com
passwordaccess      generate
passworddir         /A1
manageservices      schedule
schedlogn           /A1/dsmsched.log
errorlogname        /A1/errorlog.log
```

4. Register backup-archive client nodes on the IBM Spectrum Protect™ server. If new backup-archive client nodes are added in the first step to replace the current default value of the cluster node name, register those nodes on the IBM Spectrum Protect server.
5. Update schedule definitions. If new backup-archive client nodes are added in the previous step, ensure that the backup schedule definitions used earlier to back up this node's data are now associated with the new client node names.
6. Validate the setup. For more information, see [Configuring the backup-archive client in a cluster environment](#)

Windows

## Configuring the backup-archive client in a cluster server environment

You can install the backup-archive client software locally on each node of a Microsoft Cluster Server (MSCS) or Veritas Cluster Server (VCS) environment cluster.

You can use the backup-archive client in a VCS environment on the supported Windows Server platforms.

You can also install and configure the Scheduler Service for each cluster node to manage all local disks and each cluster group containing physical disk resources.

For example, MSCS cluster `mscs-cluster` contains two nodes: `node-1` and `node-2`, and two cluster groups containing physical disk resources: `group-a` and `group-b`. In this case, an instance of the IBM Spectrum Protect™ Backup-Archive Scheduler Service should be installed for `node-1`, `node-2`, `group-a`, and `group-b`. This ensures that proper resources are available to the Backup-Archive client when disks move (or fail) between cluster nodes.

The `clusternode` option ensures that the client manages backup data logically, regardless of which cluster node backs up a cluster disk resource. Use this option for client nodes that process cluster disk resources, and not local resources.

Note: You must set the `clusternode` option to `yes` for all IBM Spectrum Protect-managed cluster operations. Inconsistent use of the `clusternode` option for a given IBM Spectrum Protect cluster node name can cause the client to invalidate the cluster node name encrypted password, and prompt the user to reenter the password during the next backup-archive client program invocation.

Use the `optfile` option to properly call the correct (cluster) `dsm.opt` for all client programs to ensure proper functionality for cluster related operations.

How you install and configure the backup-archive client in a cluster environment depends on the cluster server technology used (MSCS or VCS) and the operating system being used by the nodes in the cluster.

- **Windows** Protecting data in MSCS clusters (Windows Server clients)  
A client configuration wizard is used on nodes in an MSCS cluster environment to automate and simplify the configuration of the backup-archive client to protect cluster disk groups. The wizard can only be used on nodes that run supported Windows Server clients as their operating system.
- **Windows** Configure the web client in a cluster environment  
To use the web client in a cluster environment, you must configure the backup-archive client GUI to run in a cluster environment.
- **Windows** Frequently asked questions  
This section contains some frequently asked questions and answers about using cluster services.

**Related reference:**

Optfile

**Windows**

## Protecting data in MSCS clusters (Windows Server clients)

---

A client configuration wizard is used on nodes in an MSCS cluster environment to automate and simplify the configuration of the backup-archive client to protect cluster disk groups. The wizard can only be used on nodes that run supported Windows Server clients as their operating system.

- **Windows** Configuring cluster protection (Windows Server clients)  
Use the IBM Spectrum Protect™ cluster wizard to configure the backup-archive client to protect cluster resources. The wizard gathers the information that is needed so the backup-archive client can protect cluster resources, and log on to the server.

**Windows**

## Configure the web client in a cluster environment

---

To use the web client in a cluster environment, you must configure the backup-archive client GUI to run in a cluster environment.

Beginning with IBM Spectrum Protect™ Version 8.1.2, you can no longer use the web client to connect to the IBM Spectrum Protect V8.1.2 or later server. However, you can still use the web client to connect to IBM Spectrum Protect V8.1.1, V8.1.0, or V7.1.7 and earlier servers. For more information, see [Using the web client in the new security environment](#).

See **Windows** Configuring cluster protection (Windows Server clients) for detailed information about installing and configuring the backup-archive client in a MSCS or VCS environment.

- **Windows** Configure the web client to process cluster disk resources  
After installing and configuring the backup-archive client in a MSCS or VCS environment, there are some steps you must perform to process cluster disk resources.

**Windows**

## Frequently asked questions

---

This section contains some frequently asked questions and answers about using cluster services.

### About this task

---

Q: How do you configure a shortcut for the backup-archive client GUI in a cluster environment?

A: To configure a backup-archive client GUI icon (for example on the Windows desktop) that you can use to manage operations for a cluster resource group on a Windows cluster, perform the following steps:

### Procedure

---

1. Right-click on the desktop and select New > Shortcut.
2. In the window that appears, find the path to the dsm.exe executable (located by default in directory `C:\program files\tivoli\tsm\baclient\`). If you type the path in, instead of using the Browse button, the path should be enclosed in double quotation marks. For example: `"C:\Program Files\tivoli\tsm\baclient\dsm.exe"`
3. After you enter the path and executable in the text field, add the following information after the closing double quotation marks (add a space between the double quotation marks and the following): -  
`optfile="x:\path\to\cluster\dsm.opt"`. This identifies the proper IBM Spectrum Protect™ cluster options file you want to use. This example assumes that the cluster options file is located in the folder `"x:\path\to\cluster\"` and has the file name `dsm.opt`.
4. The complete line in the text field now should look similar to the following: `"C:\Program Files\tivoli\tsm\baclient\dsm.exe" -optfile="x:\path\to\cluster\ dsm.opt"`.
5. Click Next and give this shortcut a meaningful name, such as Backup-Archive GUI: Cluster Group X.
6. Click Finish. A desktop icon should now be available. The properties of this icon shows the following correct Target, as noted in step 4: `"C:\Program Files\tivoli\tsm\baclient\dsm.exe" -optfile="x:\path\to\cluster\dsm.opt"`.

## Results

Q: How do you verify that a scheduler service setup in a cluster environment works?

A: Setting up a scheduler service for a Microsoft clustered resource group can be time consuming, and can be lengthened by mistakes and errors in the syntax of the commands used to set them up. Carefully entering the commands and recording important information about the cluster setup can minimize setup time. To successfully set up a scheduler service for Microsoft cluster environments:

1. Carefully read the information in this appendix for correct syntax on setting up a scheduler service for a cluster group.
2. Ensure that the proper dsm.opt file(s) are used for the cluster. In a typical normal workstation, only one dsm.opt file is used. In a clustered environment, additional dsm.opt files are required. Each cluster group that is backed up must have its own dsm.opt file. A cluster group is any group listed under the GROUPS folder of the cluster tree within the Microsoft Cluster Administrator utility or VCS Configuration Editor.
3. Understand what the following dsmcutil.exe options mean, and when to use them. (1) `/clustername:clustername` - Specifies the name of the Microsoft cluster, where *clustername* is the name at the top level of the tree within the Microsoft Cluster Administrator utility or VCS Configuration Editor. Use this option with dsmcutil.exe, only when installing a scheduler service for a cluster group. Do not specify a clustername of more than 64 characters. If you specify more than 256 characters and you are using Veritas Storage Foundation with High Availability or a Microsoft Cluster Server configuration, you might not be able to install or start the IBM Spectrum Protect scheduler service, and (2) `/clusternode:yes` - Specifies that you want to enable support for cluster resources. Use this option in the dsm.opt file for each cluster group, and with dsmcutil.exe when installing a scheduler service for a cluster group.
4. Common mistakes are made in typing the syntax of the dsmcutil.exe command. An easy way to prevent such syntax problems is to create a temporary text file which is accessible to the cluster group (for instance, place it on a cluster drive belonging to that cluster group), and type the syntax into this file. When needed, cut and paste this syntax from the file to the DOS prompt and press the Enter key. It guarantees the consistency of the command syntax regardless of which computer you enter it on.
5. If the scheduler service is failing to restart after a failover of the cluster group occurs (using the MOVE GROUP option in Cluster Administrator, for example), there might be potential password synchronization problems between the two cluster workstations. To verify that the passwords are the same, browse to this registry key on each workstation and compare the encrypted password value:  
`HKEY_LOCAL_MACHINE\SOFTWARE\IBM\ADSM\CurrentVersion\Nodes\nodename\servername.`

If the encrypted keys for this node do not match between the two cluster workstations, there is a password mismatch on one or both of the two workstations. To correct this problem, use the dsmc.exe program to update the password manually on both workstations.

For example, assume that the Y: drive is part of the cluster group that is experiencing problems being backed up with a scheduler service. The Y:\tsm directory contains the dsm.opt file for this cluster group in the Y:\tsm directory. To update the password manually, enter the following command on both workstations: `dsmc -optfile=Y:\tsm\dsm.opt -clusternode=yes`, and enter the following command to receive the prompt for the node name and password: `dsmc q se -optfile=Y:\tsm\dsm.opt -clusternode=yes`.

Verify that the passwords are synchronized, and restart the scheduler service to verify if the password remains consistent. If password mismatching continues, it might be due to a syntax error in the original dsmcutil.exe command that was used to install the scheduler service. In this case, uninstall the scheduler service (using the

`dsmcutil remove /name:schedule_name` command) and reinstall the scheduler service again (using the shared text file syntax as shown previously).

Q: How do you add a cluster drive to an existing cluster scheduler service resource for backup?

A: To add an additional cluster drive resource to an existing backup-archive client cluster scheduler service, the following components must be modified or updated to properly reflect this change:

1. The cluster drive resource, and any related resource shares, must exist and reside within the designated cluster group as defined in the Microsoft Cluster Administrator utility or VCS Configuration Editor. The designated cluster group must already contain the cluster scheduler service resource for which this new drive is added.
2. The `dsm.opt` file used by the designated cluster scheduler service resource must be modified to include the additional cluster drive resource on the domain option statement. For example, if you want to add the `R:\` drive, and the domain statement currently identifies cluster drives `Q:` and `S:`, update the domain statement in your `dsm.opt` file as follows: `domain Q: S: R:`.
3. You must modify the cluster scheduler service resource properties to include this file in the list of dependent resources needed to bring this resource online. This ensures that the cluster drive resource being added is included in the new backups, and for backups which run after a failover occurs.

After the changes above are made, bring the cluster scheduler service resource offline, and back online. The schedule should now process this additional resource for backups.

Q: The client acceptor service has been removed and now the generic service resource for the cluster group is failing. How can this be corrected?

A: The client acceptor can be used to control the scheduler, the web client, or both for a cluster environment. If the client acceptor is removed without updating the generic cluster resource, the resource fails. To correct this:

1. Verify which scheduler service was controlled by the client acceptor.
2. Using the Microsoft Cluster Administrator utility or VCS Configuration Editor, go to the properties window of the service resource, select the Parameters tab, and enter the name of the correct scheduler service to use.
3. Repeat steps one and two for each cluster group that was managed by the specific client acceptor.
4. To test the updated service resource, initiate a failure of the resource. If the resource comes back online with no failures, the update has worked properly.

Note: To fully disable the client acceptor service, remove the `managedservices` option from the cluster group `dsm.opt` file or comment it out.

Windows

## Configuring online-image backup support

---

If the online image feature is configured, the backup-archive client performs a snapshot-based image backup, during which the real volume is available to other system applications.

### About this task

---

A consistent image of the volume is maintained during the online image backup.

To configure online image backup, perform the following steps:

### Procedure

---

1. Select Utilities > Setup Wizard from the backup-archive client GUI main window. The Client Configuration Wizard panel appears.
2. Select Help me configure Online Image Support and click Next. The Online Image Support Wizard panel appears.
3. Click Volume Shadowcopy Services (VSS) and then click Next. To disable online image support, click None (Disable online image support).
4. Click Finish button to complete the setup.
5. Complete each panel in the wizard and click the Next to continue. To return to a previous panel, click the Back. To display help information for a panel, click the help icon.

### Results

---



To set preferences for open file support, use the Include-Exclude tab on the IBM Spectrum Protect™ Preferences editor. You can set these options for all volumes or for individual volumes using the include.fs option: snapshotproviderfs, presnapshotcmd, postsnapshotcmd.

**Related concepts:**

Client options reference

Image backup

Windows

## Configuring Open File Support

---

You configure Open File Support (OFS) after you install the Window client.

### About this task

---

If the Open File Support feature is configured, the backup-archive client performs a snapshot-based, file-level operation, during which the real volume is available to other system applications. A consistent image of the volume is maintained during the operation.

To configure OFS, perform the following steps:

### Procedure

---

1. Start the Windows client Java GUI (run dsm.exe).
2. Select Utilities > Setup Wizard.
3. Select Help me configure Online Image Support and click Next.
4. Click Next again.
5. Select the VSS snapshot provider to enable Open File Support or select None to perform normal (non-snapshot) backups of the files on your volume; then click Next.
6. Click Apply and then click Finish.

### Results

---

To set preferences for open file support, use the Include-Exclude tab on the Preferences editor. You can set these options for all volumes or for individual volumes using the include.fs option: snapshotproviderfs, presnapshotcmd, postsnapshotcmd

**Related concepts:**

Client options reference

AIX

## AIX configuration considerations prior to performing snapshot-based file backups and archives

---

If you are configuring your IBM Spectrum Protect™ AIX® client to perform snapshot-based file backups and archives, there are some items that you need to consider.

- Ensure that the volume group containing the file system to be snapshot has sufficient disk space to allow JFS2 external snapshots to be created for the file system.
- The client uses a default size of 100 percent of the file system size for the snapshot size. This value was found to be most appropriate for file systems with even moderate file system activity. If you need to lower this value based on your experience with your own file system activity, you can use the snapshotcachesize option to fine-tune this value.
- Do not enable internal snapshots when creating new JFS2 file systems on AIX 6.1 or later for all file systems managed by IBM Spectrum Protect. The client uses external snapshots and JFS2 does not allow the creation of external and internal snapshots concurrently for the same file system.

**Related reference:**

Snapshotcachesize

Linux

Windows

# Configuring NetApp and IBM Spectrum Protect for snapshot difference incremental backups

You must configure the NetApp file server connection information to run the snapshot difference incremental backup command on the backup-archive client. You must also use the set password command to specify the file server host name, and the password and user name that is used to access the file server.

## Procedure

1. Establish a console session on the NetApp filer and define a new user on the file server by using the following steps:
  - a. Add the user ID to a group that permits users to log in to the file server with http and running API commands.
  - b. From the file server, enter the following command to list the user ID to verify the settings and verify that the output is similar:

```
useradmin user list snapdiff_user
```

```
Name: snapdiff_user
Info:
Rid: 131077
Groups: snapdiff_group
Full Name:
```

For 7-mode NetApp filers:

```
Allowed Capabilities: login-http-admin,api-*
```

For clustered-data ONTAP NetApp filers, the only capability that is required is `ontapapi` with the `admin` role.

- c. If the `security.passwd.firstlogin.enable` option for the user ID on the NetApp server is set to on, ensure that all groups have the `login-telnet` and `cli-passwd*` capabilities.  
Tip: When `security.passwd.firstlogin.enable` option is enabled, the user ID is set to expired when created. The user cannot run any commands, including snapshot differential incremental, until their password is changed. Users in groups that do not have these capabilities cannot log in to the storage system. For information about defining a user ID and a password on the NetApp file server, see the NetApp documentation.
2. Configure the NetApp Data ONTAP built-in HTTP server to allow remote administrative sessions to the NetApp filer.
    - a. If you plan to use a plain HTTP connection for snapshot differential backups, turn on the `httpd.admin.enable` option on the NetApp filer.
    - b. If you plan to use a secure HTTPS connection for snapshot differential backups (by specifying the `-snapdiffhttps` option), turn on the `httpd.admin.ssl.enable` option on the NetApp filer.
    - c. From the IBM Spectrum Protect™ client node, test the connection between the IBM Spectrum Protect client computer and the NetApp ONTAP server to ensure that firewalls or other NetApp configuration options do not prevent you from connecting to the NetApp server.  
Tip: See the NetApp ONTAP documentation for instructions on how to test the connection.
  3. **Windows** Export the NetApp volumes and consider the following settings:  
Tip: See the NetApp documentation for details on exporting the NetApp volumes for use with Windows.
    - o Map the NetApp volumes by using CIFS.
    - o Ensure the NetApp volumes have the NTFS security setting.
  4. **Linux** Export the NetApp volumes and consider the following settings:  
Tip: See the NetApp documentation for details on exporting the NetApp volumes for use with Linux hosts.
    - o Map the NetApp volumes by using an NFS mount.
    - o Ensure the NetApp volumes have the UNIX security setting
  5. Set the user ID, and password on the backup-archive client for the user ID that you created in step 1 using the following steps:
    - a. **Linux** Log in as the root user ID.
    - b. **Windows** Log on as the user with read/write access to the CIFS share.
    - c. From the backup-archive client command line, enter the following command:

```
dsmc set password -type=filer my_file_server snapdiff_user newPassword
```

Substitute the following values:

```
my_file_server
```

This value is the fully qualified host name of your NetApp file server.

```
snapdiff_user
```

This value is the user ID that you created in step 1.

*newPassword*

This value is the password for the user ID that you created in step 1.

- **Linux** | **Windows** Protecting clustered-data ONTAP NetApp file server volumes  
You can create a snapshot differential incremental backup of a volume on a NetApp file server that is part of a clustered-data ONTAP configuration (c-mode file server).
- **Linux** | **Windows** SnapMirror support for NetApp snapshot-assisted progressive incremental backup (snapdiff)  
You can use NetApp's SnapDiff backup processing in conjunction with NetApp's SnapMirror replication to back up NetApp source or destination filer volumes.

#### Related tasks:

Protecting clustered-data ONTAP NetApp file server volumes

#### Related reference:

Snapdiff

Snapdiffhttps

Createnewbase

**Linux** | **Windows**

## Protecting clustered-data ONTAP NetApp file server volumes

---

You can create a snapshot differential incremental backup of a volume on a NetApp file server that is part of a clustered-data ONTAP configuration (c-mode file server).

### Before you begin

---

- Complete the procedure in Configuring NetApp and IBM Spectrum Protect for snapshot difference incremental backups.
- Ensure that the clustered-data ONTAP environment is correctly set up by the NetApp storage virtual machine administrator.

Restriction: IBM Spectrum Protect™ support for snapshot differential incremental backups of clustered-data ONTAP volumes is supported only on NetApp ONTAP 8.2.1 and later versions.

### About this task

---

In a clustered-data ONTAP environment, storage virtual machines (also referred to as data vServers) contain data volumes that can be protected by the backup-archive client.

A storage virtual machine consists of a single infinite volume or one or more flex volumes. Volumes are accessed remotely using file sharing (CIFS on Windows operating systems, NFS on Linux operating systems).

The storage virtual machines are managed by the cluster management filer, which is the physical filer (the c-mode filer) on which the storage virtual machines reside. The backup client is installed on the remote machine that accesses the volumes.

The backup-archive client must be configured with credentials for the NetApp c-mode filers that are being accessed for backup operations.

Requirements:

- The following information is required for this procedure:
  - The host name or IP address of the cluster management filer.
  - The host name or IP address of the storage virtual machine.
  - The storage virtual machine name.
  - The cluster management filer credentials (user name and password).
- The cluster management filer user that is configured by the client must be assigned the `ontapapi` capability with the role of `admin`.

The `ontapapi` capability does not allow interactive access to the filer with methods such as `telnet`, `ssh`, or `http/https`. No other user capabilities are required to run snapshot differential incremental backups.

### Procedure

---

Complete the following steps on the remote machine where the backup-archive client is installed:

1. Configure the backup-archive client with the cluster management filer credentials. Use the `dsmc set password` command to store the credentials of the management filer that is associated with the storage virtual machine. For example, enter the following command:

```
dsmc set password -type=filer management_filer_hostname
management_filer_username management_filer_password
```

Where:

*management\_filer\_hostname*

The host name or IP address of the cluster management filer.

*management\_filer\_username*

The user name of the cluster management filer.

*management\_filer\_password*

The password for user of the management filer.

Tip: The cluster management filer password is encrypted when it is stored by the backup-archive client.

2. Associate each storage virtual machine with the management filer with the `dsmc set netappsvm` command. For example, enter the following command:

```
dsmc set netappsvm storage_virtual_machine_hostname
management_filer_hostname storage_virtual_machine_name
```

Where:

*storage\_virtual\_machine\_hostname*

The host name or IP address of the storage virtual machine that is used to mount volumes to back up.

*management\_filer\_hostname*

The host name or IP address of the cluster management filer.

*storage\_virtual\_machine\_name*

The name of the storage virtual machine.

Note: The host name or IP address of the storage virtual machine that is used to mount volumes must be consistent with what is specified in the `dsmc set` commands. For example, if the volumes are mounted with a storage virtual machine IP address, the IP address (not the host name) must be used in the `dsmc set` commands. Otherwise, client authentication with the cluster management filer fails.

You need only to specify the `dsmc set netappsvm` command once for each storage virtual machine. If the storage virtual machine is moved to a different cluster management filer, you must use the command to update the associated cluster management filer host name.

3. **Windows** Map the volumes to drive letters. For example, enter the following command for each storage virtual machine:

```
net use y: \\storage_virtual_machine_hostname domain_name\CIFS_share_name
```

Where:

*y:*

The drive to map the volume to.

*storage\_virtual\_machine\_hostname*

The host name or IP address of the storage virtual machine.

*domain\_name\CIFS\_share\_name*

The CIFS share that is defined on the filer on the volume being backed up.

4. **Linux** Mount the remote storage virtual machine to a local file system. For example, enter the following command for each storage virtual machine:

```
mount storage_virtual_machine_hostname /tmp/fs1
```

Where:

*storage\_virtual\_machine\_hostname*

The host name or IP address of the storage virtual machine.

*/tmp/fs1*

An example of a file system to mount the storage virtual machine volume to.

5. Start a full progressive incremental backup of a flex or infinite volume.

By default, HTTP access to the NetApp file server is not enabled. If you did not configure your file server to allow access by using HTTP, use the backup-archive client `snapdiffhttps` option to enable access to the cluster management server with the HTTPS protocol.

**Windows** For example, on Windows clients, enter the following command:

```
dsmc incr y: -snapdiff -snapdiffhttps
```

**Linux** For example, on Linux clients, enter the following command:

```
dsmc incr /tmp/fs1 -snapdiff -snapdiffhttps
```

Tip: You need only to run the full progressive incremental backup once. After this backup is successfully completed, run differential backups in future backup operations.

6. Start a snapshot differential backup of the flex or infinite volume.

**Windows** For example, on Windows clients, enter the following command:

```
dsmc incr y: -snapdiff -snapdiffhttps
```

**Linux** For example, on Linux clients, enter the following command:

```
dsmc incr /tmp/fs1 -snapdiff -snapdiffhttps
```

## Example

---

A backup-archive client user wants to complete a snapshot differential incremental backup of the volumes on a c-mode file server. The user is using a Windows backup-archive client to complete the backup and the volumes are mounted as CIFS shares. The c-mode filer configuration is as follows:

### ONTAP 8.31 management filer

```
Hostname: netapplmgmt.example.com
User: netapplmgmt_user
Password: pass4netapplmgmt
CIFS Domain Controller: WINDC
Domain User: domainuser
```

### Flex volume storage virtual machine

```
Hostname: netappl-v1.example.com
Storage virtual machine name: netappl-client1
CIFS share: demovol
Volume name: demovol
```

### Infinite volume storage virtual machine

```
Hostname: netappl-v4.example.com
Storage virtual machine name: netappl-infiniteVolume1
CIFS Share: InfiniteVol
```

The user completes the following steps on the backup-archive client:

1. Configure the client with the management filer credentials by issuing the following command:

```
dsmc set password -type=filer netapplmgmt.example.com netapplmgmt_user pass4netapplmgmt
```

2. Define storage virtual machine associations for each storage virtual machine with the following commands:

```
dsmc set netappsvm netappl-v1.example.com netapplmgmt.example.com netappl-client1
```

```
dsmc set netappsvm netappl-v4.example.com netapplmgmt.example.com netappl-infiniteVolume1
```

3. Map remote volumes to drive letters for each storage virtual machine:

```
net use y: \\netappl-v1.example.com\demovol WINDC\domainuser
```

```
net use z: \\netappl-v4.example.com\InfiniteVol WINDC\domainuser
```

4. Run a full progressive incremental backup of the flex volume and infinite volume:

```
dsmc incr y: -snapdiff -snapdiffhttps
```

```
dsmc incr z: -snapdiff -snapdiffhttps
```

You need only to run the full progressive incremental backup once. After this backup is successfully completed, run differential backups in future backup operations.

5. Run a snapshot differential backup of the flex volume and infinite volume:

```
dsmc incr y: -snapdiff -snapdiffhttps
```

```
dsmc incr z: -snapdiff -snapdiffhttps
```

Linux | Windows

## SnapMirror support for NetApp snapshot-assisted progressive incremental backup (snapdiff)

---

You can use NetApp's SnapDiff backup processing in conjunction with NetApp's SnapMirror replication to back up NetApp source or destination filer volumes.

In a NetApp SnapMirror environment, data that is on volumes attached to the primary data center are mirrored to volumes attached to a remote server at a disaster recovery site. The NetApp filer in the primary data center is called the source filer; the NetApp filer at the disaster recovery site is called the destination filer. You can use the backup-archive client to create snapshot differential backups of the source or destination filer volumes.

### Scenario: Back up data on a source filer volume

---

**Linux** You can configure the backup archive client to back up data from the source filer volumes. This scenario requires you to configure a backup-archive client node such that it has access to the NetApp source filer volumes by using NFS-exported shares to mount the filer volumes.

**Windows** You can configure the backup archive client to back up data from the source filer volumes. This scenario requires you to configure a backup-archive client node such that it has access to the NetApp source filer volumes by using CIFS shares to mount the filer volumes.

**Linux** For example, assume a configuration where the source filer is named ProdFiler. Assume that a volume named UserDataVol exists on ProdFiler filer and that the volume is accessible by using NFS from a backup-archive client node. Assume that the share is mounted as UserDataVol\_Share.

**Windows** For example, assume a configuration where the source filer is named ProdFiler. Assume that a volume named UserDataVol exists on ProdFiler filer and that the volume is accessible by using CIFS from a backup-archive client node. Assume that the share is mounted as UserDataVol\_Share.

When you initiate a snapshot differential backup, the NetApp filer creates a new differential snapshot on the volume that is being backed up. That differential snapshot is compared with the base (previous) snapshot. The base snapshot name was registered on the IBM Spectrum Protect™ server when the previous backup was completed. The contents of that base snapshot are compared to the differential snapshot that is created on the source filer volume. Differences between the two snapshots are backed up to the server.

The following command is used to initiate the snapshot differential backup. The command is entered on the console of a client node that is configured to access and protect the source filer volumes. Because this command is issued to back up volumes on a source filer, a new snapshot (the differential snapshot) is created and the snapshot registered on the IBM Spectrum Protect server is used as the base snapshot. Creating both the differential and base snapshots is the default behavior; the `-diffsnapshot=create` option is a default value, and it does not need to be explicitly specified on this command.

```
dsmc incr \\ProdFiler\UserDataVol_Share -snapdiff -diffsnapshot=create
```

### Back up data on a destination filer

---

A more typical configuration is to offload the backups from the source filer by creating backups of the source volumes by using the replicated volume snapshots stored on the destination filer. Ordinarily, backing up a destination filer presents a problem because creating a snapshot differential backup requires that a new snapshot must be created on the volume that you are backing up. The destination filer volumes that mirror the contents of the source volumes are read only volumes, so snapshots cannot be created on them.

To overcome this read-only restriction, client configuration options are provided to allow you to use the existing base and differential snapshots on the read-only destination volume to back up changes to the IBM Spectrum Protect server.

**AIX** | **Linux** Like in the source filer scenario, the destination filer volumes are accessed by using NFS-exported shares.

**Windows** Like in the source filer scenario, the destination filer volumes are accessed by using CIFS shares.

## Snapshot differential options summary

---

The `useexistingbase` option causes the most recent snapshot on the volume to be used as the base snapshot, when a base snapshot must be established. A new base snapshot is established when any of the following conditions are true:

- When this backup is the initial backup.
- When `createnewbase=yes` is specified.
- When the base snapshot that was registered by a previous differential snapshot no longer exists, and an existing snapshot that is older than the missing base snapshot does not exist.

If this option is not specified, a new snapshot is created on the volume that is being backed up. Because destination filer volumes are read-only volumes, `useexistingbase` must be specified when creating snapshot differential backups of destination filer volumes. If `useexistingbase` is not specified, snapshot differential backups of a destination filer volume fail because the new snapshot cannot be created on the read-only volume.

When backing up destination filer volumes, use both the `useexistingbase` option and the `diffsnapshot=latest` option to ensure that the most recent base and most recent differential snapshots are used during the volume backup.

You use the `basesnapshotname` option to specify which snapshot, on the destination filer volume, to use as the base snapshot. If you do not specify this option, the most recent snapshot on the destination filer volume is used as the base snapshot. You can use wildcards to specify the name of the base snapshot.

You use the `diffsnapshotname` option to specify which differential snapshot, on the destination filer volume, to use during a snapshot differential backup. This option is only specified if you also specify `diffsnapshot=latest`. You can use wildcards to specify the name of the differential snapshot.

The `diffsnapshot=latest` option specifies that you want to use the latest snapshot that is found on the file server as the source snapshot.

Additional information about each of these options is provided in the Client options reference topics.

## Snapshot differential backup command examples

---

In the examples that follow, assume that volumes on a source filer are replicated, by using NetApp's SnapMirror technology, to a disaster recovery filer (host name is DRFiler). Because the DRFiler volumes are read only, you use the options to specify which of the replicated snapshots that you want to use as the base snapshot, and which of the snapshots you want to use as the differential snapshot. By specifying the snapshots to use when creating a snapshot differential backup of a destination filer, no attempt is made to create a snapshot on the read-only volumes.

The following commands are used to initiate snapshot differential backups. Most of these commands create snapshot differential backups by using snapshots stored on the destination filer volumes. When backing up from a destination filer volume, be sure to include the `-useexistingbase` option, because that option prevents attempts to create a new snapshot on the read-only destination filer volumes.

**Example 1:** Back up a destination filer by using default nightly backups that were created by the NetApp snapshot scheduler

```
dsmc incr \\DRFiler\UserDataVol_Share -snapdiff -useexistingbase
-diffsnapshot=latest -basesnapshotname="nightly.?"
```

You can use a question mark (?) to match a single character. In this example, `-basesnapshotname=nightly.?` uses the latest base snapshot that is named "nightly.", followed by a single character (for example: `nightly.0`, `nightly.1`, and so on).

**Example 2:** Back up a destination filer volume by using snapshots created manually (not created by the NetApp snapshot scheduler)

```
dsmc incr \\DRFiler\UserDataVol_Share -snapdiff -useexistingbase
-diffsnapshot=latest -basesnapshotname="share_vol_base?"
-diffsnapshotname="share_vol_diff?"
```

This example also uses the question mark (?) wildcard to illustrate the syntax if the base and differential snapshot names have different numbers as part of the name.

Example 3. Back up a destination filer volume, and specify which snapshots to use for the base and differential snapshots

```
dsmc incr \\DRFiler\UserDataVol_Share -snapdiff -useexistingbase
-diffsnapshot=latest -basesnapshotname="share_vol_base"
-diffsnapshotname="share_vol_diff_snap"
```

Example 4: Back up script-generated snapshots that use a naming convention

In this example, a script that is running on the NetApp filer adds a date and time stamp to the snapshot names. For example, a snapshot created on November 3, 2012 at 11:36:33 PM is named UserDataVol\_20121103233633\_snapshot. You can use wildcards with the options to select the most recent base and differential snapshots. For example:

```
dsmc incr \\DRFiler\UserDataVol_Share -snapdiff -useexistingbase
-basesnapshotname="UserDataVol_Share_*_snapshot" -diffsnapshot=latest
-diffsnapshotname="UserDataVol_Share_*_snapshot"
```

-useexistingbase selects the most recent base snapshot. Adding an asterisk (\*) wildcard to -basesnapshotname selects the most recent base snapshot that follows the script-naming convention. The -diffsnapshot=latest option suppresses the creating of a new differential snapshot and -diffsnapshotname= selects the most recent existing differential snapshot that follows the script-naming convention. (The asterisks wildcards match any string).

Example 5: Perform a snapshot differential backup by using an existing differential snapshot that exists on the source filer

To use an existing differential snapshot that exists on the source filer, use the -diffsnapshot=latest to prevent the creation of a new differential snapshot. Also use the -diffsnapshotname option to specify which existing differential snapshot to use. The snapshot you specify is compared to the base snapshot, which was registered in the IBM Spectrum Protect server database when the last backup was created. For example:

```
dsmc incr \\ProdFiler\UserDataVol_Share -snapdiff -diffsnapshot=latest
-diffsnapshotname="share_vol_diff_snap"
```

## Register your workstation with a server

---

Before you can use IBM Spectrum Protect™, you must set up a node name and password and your node must be registered with the server.

The process of setting up a node name and password is called *registration*. Two types of registration are available, *open* and *closed*.

Your IBM Spectrum Protect server administrator chooses the type of registration for your site.

Restriction: Beginning with the IBM Spectrum Protect Version 8.1.2 server, open registration is no longer available. You must use closed registration. Open registration is available only for the IBM Spectrum Protect V8.1.1, V8.1.0, V7.1.7 or earlier server.

**AIX** **Linux** **Mac OS X** **Solaris** You must be a root user or authorized user to perform this required task.

If you plan to use the web client, you must have an administrative user ID with system privilege, policy privilege, client access authority, or client owner authority. When a new node is registered, the server administrator must create an administrative user ID that matches the node name. By default, this node has client owner authority.

The IBM Spectrum Protect server administrator must specify the userid parameter with the REGISTER NODE server command:

```
REGISTER NODE node_name password userid=user_id
```

where the node name and the administrative user ID must be the same. For example:

```
REGISTER NODE node_a mypassw0rd userid=node_a
```

- Closed registration  
With closed registration, the IBM Spectrum Protect administrator must register your workstation as a client node with the server. If your enterprise uses closed registration, you must provide some information to your IBM Spectrum Protect administrator.
- Open registration  
With open registration, a system administrator can register your workstation as a client node with the IBM Spectrum Protect Version 8.1.1, V8.1.0, V7.1.7 or earlier server.

## Closed registration

---



With closed registration, the IBM Spectrum Protect™ administrator must register your workstation as a client node with the server. If your enterprise uses closed registration, you must provide some information to your IBM Spectrum Protect administrator.

## About this task

---

You must provide the following items to your IBM Spectrum Protect administrator:

- Your node name (the value returned by the **hostname** command, the name of your workstation, or the node name you specified with the **nodename** option). If you do not specify a node name with the **nodename** option, the default login ID is the name that the **hostname** command returns.
- The initial password you want to use, if required.
- Contact information, such as your name, user ID, and phone number.

Your IBM Spectrum Protect administrator defines the following for you:

- The policy domain to which your client node belongs. A policy domain contains policy sets and management classes that control how IBM Spectrum Protect manages the files you back up and archive.
- Whether you can compress files before sending them to the server.
- Whether you can delete backup and archive data from server storage.

## Open registration

---

With open registration, a system administrator can register your workstation as a client node with the IBM Spectrum Protect™ Version 8.1.1, V8.1.0, V7.1.7 or earlier server.

## About this task

---

The first time you start a session, you are prompted for information necessary to register your workstation with the IBM Spectrum Protect server that is identified in your client options file. You need to supply your node name, a password, and contact information.

When you use open registration:

- Your client node is assigned to a policy domain named **standard**.
- You can delete archived copies of files from server storage, but not backup versions of files.

If necessary, your IBM Spectrum Protect administrator can change these defaults later.

## Creating an include-exclude list

---

If you do not create an include-exclude list, the backup-archive client considers all files for backup services and uses the default management class for backup and archive services.

## About this task

---

This is an optional task, but an important one.

You can create an include-exclude list to exclude a specific file or groups of files from backup services, and to assign specific management classes to files. The client backs up any file that is not explicitly excluded. You should exclude IBM Spectrum Protect™ client directories from backup services. You can use the query `inlxcxl` command to display a list of include and exclude statements in the order they are examined when determining whether an object is to be included.

**Windows** Specify your include-exclude list in your client options file (`dsm.opt`). The include-exclude list can also go into a separate file, which is referred to by the `inlxcxl` option. The include-exclude statements are not case-sensitive.

**Windows** The client options file, `dsm.opt`, must be in a non-Unicode format. However, if you are using a separate include-exclude file, it can be in Unicode or non-Unicode format.

**AIX** | **Linux** | **Solaris** | **Mac OS X** Specify the include-exclude list in your `dsm.sys` file. If you define more than one server in your `dsm.sys` file, each server must have its own include-exclude list. This list can also contain include-exclude statements obtained from the include-exclude files you specify with the `inlxcxl` option.

**Windows** When the client processes include-exclude statements, the include-exclude statements within the include-exclude file are placed at the position occupied by the `inclexcl` option in `dsm.opt`, in the same order, and processed accordingly.

**AIX Linux Solaris Mac OS X** When the client processes include-exclude statements, the include-exclude statements within the include-exclude file are placed at the position occupied by the `inclexcl` option in `dsm.sys`, in the same order, and processed accordingly.

## Procedure

You can use the following methods to create an include-exclude list or specify an include-exclude file:

- You can add include-exclude statements in the backup-archive client GUI or web client directory tree. The online help provides detailed instructions.
  1. Open the Edit menu and select Client Preferences. In the Preferences dialog, select the Include/Exclude tab. You can specify an `INCLEXCL` file using the Preferences editor. However, you cannot create the `INCLEXCL` file using the Preferences editor.
  2. Create the include-exclude list manually, following the steps listed.
- You can create an include-exclude list manually by performing the following steps:
  1. Determine your include and exclude requirements.
  2. **Windows** Locate the client options file
  3. **AIX Linux Mac OS X Solaris** Locate the server stanza in your `dsm.sys` file. Each server stanza must have its own include-exclude list.
  4. **Windows** **Important:** Group your include-exclude options together in your client options file.
  5. **AIX Linux Mac OS X Solaris** Enter your include and exclude statements. The client evaluates all `exclude.fs` and `exclude.dir` statements *first* (regardless of their position within the include-exclude list), and removes the excluded file spaces, directories, and files from the list of objects available for processing. All other include-exclude statements are processed from the bottom of the list up. Therefore, it is important to enter all your include-exclude statements in the proper order. For example, in the following include-exclude list the `includefile.cpp` file is *not* backed up:

```
include /Users/user01/Documents/includefile.cpp
exclude /Users/user01/Documents/.../*
```

However, in the following include-exclude list the `includefile.cpp` file is backed up:

```
exclude /Users/user01/Documents/.../*
include /Users/user01/Documents/includefile.cpp
```

6. **Windows** Enter your include and exclude statements. The client evaluates all `exclude.dir` statements *first* (regardless of their position within the include-exclude list), and removes the excluded directories and files from the list of objects available for processing. All other include-exclude statements are processed from the bottom of the list up. Therefore, it is important to enter all your include-exclude statements in the proper order. For example, in the following include-exclude list the `includefile.txt` file is *not* backed up:

```
include c:\test\includefile.txt
exclude c:\test\...*
```

However, in the following include-exclude list the `includefile.txt` file is backed up:

```
exclude c:\test\...*
include c:\test\includefile.txt
```

7. Save the file and close it.

**Mac OS X** For Mac OS X, ensure that you save the file as plain text encoded as Unicode (UTF-8 or UTF-16). Do not add the `.txt` extension.

8. **Windows** Restart the client and the scheduler and client acceptor services to enable your include-exclude list.
9. **AIX Linux Mac OS X Solaris** Restart the client to enable your include-exclude list.

- Include-exclude options  
This topic provides brief descriptions of the include and exclude options that you can specify in your client options file, a minimum include-exclude list that excludes system files, a list of supported wildcard characters, and examples of how you might use wildcard characters with include and exclude patterns.
- **Mac OS X AIX Linux Solaris** Symbolic link and alias processing  
The backup-archive client evaluates all `exclude.fs` and `exclude.dir` statements and removes the excluded file spaces and

directories.

- Determine compression and encryption processing  
The backup-archive client evaluates `exclude.dir` and any other include-exclude options controlling backup and archive processing, and then determines which files undergo compression and encryption processing.
- Preview include-exclude list files  
You can preview the list of objects to be backed up or archived according to the include-exclude list, prior to sending any data to the server.
- Include and exclude option processing  
The IBM Spectrum Protect server can define include-exclude options using the `inclxcl` parameter in a client option set.
- **Windows** Processing rules when using UNC names  
When processing files with UNC names, there are rules that must be followed.

**Related concepts:**

**AIX** | **Linux** | **Solaris** | **Mac OS X** Considerations for Unicode-enabled clients

System files to exclude

Storage management policies

**Related reference:**

Inclxcl

## Include-exclude options

This topic provides brief descriptions of the include and exclude options that you can specify in your client options file, a minimum include-exclude list that excludes system files, a list of supported wildcard characters, and examples of how you might use wildcard characters with include and exclude patterns.

- Exclude file spaces and directories  
Use `exclude.dir` statements to exclude all files and subdirectories in the specified directory from processing.
- **Windows** Include-exclude statements for networked file systems  
Include-exclude statements that involve networked file systems (remote drives) must be written in the UNC format.
- **AIX** | **Windows** Exclude files and directories from a journal-based backup  
There are two methods of excluding files and directories from a journal-based backup.
- Control processing with exclude statements  
After the client evaluates all exclude statements, the following options are evaluated against the remaining list of objects available for processing.
- System files to exclude  
There are some system files that should be placed in the client options file so that they are excluded.
- **Windows** Exclude files with UNC names  
You can exclude remotely accessed files by specifying their universal naming convention (UNC) names in your exclude statement.
- Include and exclude files that contain wildcard characters  
You must use special escape characters when including or excluding files and directories that contain wildcard characters.
- Include and exclude groups of files with wildcard characters  
You can use wildcard characters to include or exclude groups of files.
- Examples using wildcards with include and exclude patterns  
The backup-archive client accepts the `exclude.dir` option, which can be used to exclude directory entries. However, the include and `exclude.dir` options cannot be used together.

## Exclude file spaces and directories

Use `exclude.dir` statements to exclude all files and subdirectories in the specified directory from processing.

The backup-archive client evaluates all `exclude.dir` statements *first* (regardless of their position within the include-exclude list), and removes the excluded directories and files from the list of objects available for processing. The `exclude.dir` statements override all include statements that match the pattern.

Table 1 lists the options you can use to exclude file spaces and directories from processing.

Table 1. Options for excluding file spaces and directories

Option	Description
--------	-------------

Option	Description								
<table border="1" data-bbox="199 153 407 201"> <tr> <td>AIX</td> <td>Linux</td> </tr> <tr> <td>Solaris</td> <td>Mac OS X</td> </tr> </table> <p>exclude.fs Exclude options</p>	AIX	Linux	Solaris	Mac OS X	<table border="1" data-bbox="483 153 886 176"> <tr> <td>AIX</td> <td>Linux</td> <td>Solaris</td> <td>Mac OS X</td> </tr> </table> <p>Excludes file spaces matching the pattern. The client does not consider the specified file space for processing and the usual deleted-file expiration process cannot occur. If you exclude a file space that was previously included, existing backup versions remain on the server subject to retention rules specified in the associated management class definition.</p>	AIX	Linux	Solaris	Mac OS X
AIX	Linux								
Solaris	Mac OS X								
AIX	Linux	Solaris	Mac OS X						
<table border="1" data-bbox="199 321 407 369"> <tr> <td>Mac OS X</td> <td>AIX</td> </tr> <tr> <td>Linux</td> <td>Solaris</td> </tr> </table> <p>exclude.dir Exclude options</p>	Mac OS X	AIX	Linux	Solaris	<table border="1" data-bbox="483 321 886 344"> <tr> <td>Mac OS X</td> <td>AIX</td> <td>Linux</td> <td>Solaris</td> </tr> </table> <p>Excludes a directory, its files, and all its subdirectories and their files from backup processing. For example, the statement <code>exclude.dir /test/dan/data1</code> excludes the <code>/test/dan/data1</code> directory, its files, and all its subdirectories and their files. Using the <code>exclude.dir</code> option is preferable over the standard <code>exclude</code> option to exclude large directories containing many files that you do not want to back up. You cannot use include options to override an <code>exclude.dir</code> statement. Only use <code>exclude.dir</code> when excluding an entire directory branch.</p> <ul style="list-style-type: none"> <li>• Use the following statements to exclude volumes <code>/Volumes/disk2</code> altogether from backup processing. Note that the volume (<code>/Volumes/disk2</code>) is backed up, but all other directories on <code>/Volumes/disk2</code> is excluded. <pre data-bbox="557 646 932 695">exclude /Volumes/disk2/* exclude.dir /Volumes/disk2/*</pre> </li> <li>• An alternative method for excluding an entire volume from domain incremental backup is to use a domain statement to exclude the volume. For example: <pre data-bbox="545 800 862 823">domain "-/Volumes/disk2"</pre> <p data-bbox="545 852 1422 875">This alternative still permits selective backup processing of files on <code>/Volumes/disk2</code>.</p> </li> </ul>	Mac OS X	AIX	Linux	Solaris
Mac OS X	AIX								
Linux	Solaris								
Mac OS X	AIX	Linux	Solaris						

Option	Description
<p><b>Windows</b> <code>exclude.dir</code> Exclude options</p>	<p><b>Windows</b> Excludes a directory, its files, and all its subdirectories and their files from backup processing. For example, the statement <code>exclude.dir c:\test\dan\data1</code> excludes the <code>c:\test\dan\data1</code> directory, its files, and all its subdirectories and their files. Using the <code>exclude.dir</code> option is preferable over the standard <code>exclude</code> option to exclude large directories containing many files that you do not want to back up. You cannot use <code>include</code> options to override an <code>exclude.dir</code> statement. Only use <code>exclude.dir</code> when excluding an entire directory branch.</p> <p>If you define an exclude statement without using a drive letter, such as <code>exclude.dir dirname</code>, this excludes from processing any directory named <code>dirname</code> on any drive.</p> <ul style="list-style-type: none"> <li>The following examples illustrate valid <code>exclude.dir</code> statements: Exclude directory <code>C:\MyPrograms\Traverse</code> and its files and subdirectories: <pre>exclude.dir c:\MyPrograms\Traverse</pre> Exclude all directories below <code>c:\MyPrograms\Traverse</code>. Note that directory <code>C:\MyPrograms\Traverse</code> and the files immediately below <code>C:\MyPrograms\Traverse</code> is eligible for backup. <pre>exclude.dir c:\MyPrograms\Traverse\*</pre> Exclude all directories whose names begin with <code>temp</code>, and are located within directory <code>x:\documents and settings</code> and its subdirectories, where <code>x</code>: is any drive. <pre>exclude.dir "x:\documents and settings\...\temp"</pre> Exclude all directories whose names begin with <code>temp</code>, regardless of the drive or directory in which they reside: <pre>exclude.dir temp*</pre> The following example is invalid because it ends with a directory delimiter: <pre>exclude.dir c:\MyPrograms\Traverse\</pre></li> <li>Use the following statements to exclude drive <code>x</code>: altogether from backup processing. Note that the drive root (<code>x:\</code>) is backed up, but all other files and directories on <code>x</code>: is excluded. <pre>exclude x:\* exclude.dir x:\*</pre></li> <li>An alternative method for excluding an entire drive from domain incremental backup is to use a domain statement to exclude the drive. For example: <pre>domain -x:</pre> This alternative still permits selective and explicit incremental backup processing of files on <code>x:</code>. For example: <pre>dsmc s x:\ -subdir=yes dsmc i x: dsmc i x:\MyPrograms\ -subdir=yes</pre></li> </ul>

**Windows**

## Include-exclude statements for networked file systems

Include-exclude statements that involve networked file systems (remote drives) must be written in the UNC format.

In the following example `Z:` is a mapped drive to a remote file system on `vista.example.com`.

The old format would be to exclude `\dir\dir2` on the remote file system, as in this example:

```
EXCLUDE.DIR "Z:\dir1\dir2"
```

Here is an example of the new format using UNC:

```
EXCLUDE.DIR "\\vista.example.com\d$\dir1\dir2"
```

The include-exclude statements written in the old format will not be recognized by the client.

AIX Windows Linux

## Exclude files and directories from a journal-based backup

There are two methods of excluding files and directories from a journal-based backup.

AIX Linux

- On AIX® and Linux, one method is to add exclude statements to the client options file to prevent the files or directories from being backed up during backup processing.
- On AIX and Linux the other method is to add exclude statements to the journal configuration file `tsmjbbd.ini`, to prevent journal entries from being added for the files or directories, which prevents them from being processed during a journal-based backup.

**AIX** If you are running AIX Version 6.1 or later, add an `exclude .snapshot` statement to the `tsmjbbd.ini` file to prevent JFS2 internal snapshot directories from being monitored by the journal-based backup daemon.

Windows

- One method is to add exclude statements to the client options file to prevent the files or directories from being backed up during backup processing.
- The other method is to add exclude statements to the journal configuration file `tsmjbbd.ini`, to prevent journal entries from being added for the files or directories, which prevents them from being processed during a journal-based backup.

Note: There is no correlation between the two exclude statements. The preferred place for exclude statements in `tsmjbbd.ini` is to prevent them from entering the journal database and being processed during a journal-based backup.

## Control processing with exclude statements

After the client evaluates all exclude statements, the following options are evaluated against the remaining list of objects available for processing.

Table 1 lists the options that you can use to control processing with include and exclude statements.

Table 1. Options for controlling processing using include and exclude statements

Option	Description	Page
<b>Back up processing</b>		
exclude exclude.backup exclude.file exclude.file.backup	<i>These options are equivalent.</i> Use these options to exclude a file or group of files from backup services and space management services (if the HSM client is installed). The <code>exclude.backup</code> option only excludes files from normal backup, but not from HSM.	Exclude options
include include.backup include.file	Use these options to include files or assign management classes for backup processing.	Include options
<b>AIX</b> <b>Linux</b> <b>Solaris</b> <b>Mac OS X</b> include.fs	<b>AIX</b> <b>Linux</b> <b>Solaris</b> <b>Mac OS X</b> Controls how the client processes your file space for incremental backups.	<b>AIX</b> <b>Linux</b> <b>Solaris</b> <b>Mac OS X</b> Include options
<b>Windows</b> include.fs	<b>Windows</b> Use this option to set options on a file space-by-file space basis.	<b>Windows</b> Include options
<b>Archive processing</b>		
exclude.archive	Excludes a file or group of files from archive services.	Exclude options

Option	Description	Page
include include.archive	<i>These options are equivalent.</i> Use these options to include files or assign management classes for archive processing.	Include options
<b>AIX   Linux   Solaris   Windows Image processing</b>		
<b>AIX   Solaris</b> exclude.fs.nas	<b>AIX   Solaris</b> Excludes file systems on the NAS file server from an image backup when used with the backup nas command. If you do not specify a NAS node name, the file system identified applies to all NAS file servers. The backup nas command ignores all other exclude statements including exclude.fs and exclude.dir statements. This option is for AIX® and Solaris clients <i>only</i> .	<b>AIX   Solaris</b> Exclude options
<b>Windows</b> exclude.fs.nas	<b>Windows</b> Excludes file systems on the NAS file server from an image backup when used with the backup nas command. If you do not specify a NAS node name, the file system identified applies to all NAS file servers. The backup nas command ignores all other exclude statements including exclude.dir statements. This option is for all Windows clients.	<b>Windows</b> Exclude options
<b>AIX   Linux   Solaris</b> exclude.image	<b>AIX   Linux   Solaris</b> Excludes mounted file systems and raw logical volumes that match the specified pattern from full image backup operations. Incremental image backup operations are unaffected by exclude.image. This option is valid for AIX, Solaris, and all Linux clients.	<b>AIX   Linux   Solaris</b> Exclude options
<b>Windows</b> exclude.image	<b>Windows</b> Excludes mounted file systems and raw logical volumes that match the specified pattern from full image backup operations. Incremental image backup operations are unaffected by exclude.image. This option is valid for all Windows clients.	<b>Windows</b> Exclude options
<b>AIX   Solaris</b> include.fs.nas	<b>AIX   Solaris</b> Use the include.fs.nas option to bind a management class to Network Attached Storage (NAS) file systems. To specify whether the client saves Table of Contents (TOC) information during a NAS file system image backup, use the toc option with the include.fs.nas option in your dsm.sys file. For more information, see Toc. This option is valid only for AIX and Solaris clients.	<b>AIX   Solaris</b> Include options
<b>Windows</b> include.fs.nas	<b>Windows</b> Use the include.fs.nas option to bind a management class to Network Attached Storage (NAS) file systems. To specify whether the client saves Table of Contents (TOC) information during a NAS file system image backup, use the toc option with the include.fs.nas option in your client options file (dsm.opt). See Toc for more information. This option is valid for all Windows clients.	<b>Windows</b> Include options
<b>AIX   Linux   Solaris</b> include.image	<b>AIX   Linux   Solaris</b> Includes a file space or logical volume, assigns a management class, or allows you to assign one of several image backup processing options to a specific logical volume when used with the backup image command. The backup image command ignores all other include options. This option is valid for AIX, Solaris, Linux x86_64, and Linux on POWER® only.	<b>AIX   Linux   Solaris</b> Include options
<b>Windows</b> include.image	<b>Windows</b> Includes a file space or logical volume, assigns a management class, or allows you to assign one of several image backup processing options to a specific logical volume when used with the backup image command. The backup image command ignores all other include options. This option is valid for all Windows clients.	<b>Windows</b> Include options
<b>Windows System state processing</b>		
<b>Windows</b> include.systemstate	<b>Windows</b> Assigns management classes for backup of the Windows system state. The default is to bind the system state object to the default management class.	<b>Windows</b> Include options
<b>Mac OS X   Windows</b>		

## System files to exclude

There are some system files that should be placed in the client options file so that they are excluded.

Attention: These system files are either locked by the operating system or they can cause problems during restore. These are system files that cannot be recovered without the possibility of corrupting the operating system, or temporary files with data that you can easily recreate.

The implicitly generated statements can be seen in the lines of output of the query `inlxccl` command with the source "operating system".

**Windows** Use the sample include-exclude list in the `dsm.smp` file as a starting point for your include-exclude list. This is the minimum include-exclude list that you should have. The `dsm.smp` file is located in the `config` folder in the installation directory. If you accepted the defaults, the path to this file is `C:\Program Files\Tivoli\TSM\config\dsm.smp`

**Windows** There are exclude statements generated from a list defined by the Windows operating system in the Windows Registry. Those implicitly generated statements can be seen in the lines of output of the query `inlxccl` command with the source "operating system".

**Mac OS X** The backup-archive client adds the following exclude statements to the include-exclude list from your `dsm.sys` file. Do not include any of these statements in the `dsm.sys` file, or duplicate entries occurs.

```
EXCLUDE.ARCHIVE "/.../Desktop DB"
EXCLUDE.BACKUP "/.../Desktop DB"
EXCLUDE.ARCHIVE "/.../Desktop DF"
EXCLUDE.BACKUP "/.../Desktop DF"
EXCLUDE.ARCHIVE /.vol
EXCLUDE.BACKUP /.vol
EXCLUDE.ARCHIVE /automount
EXCLUDE.BACKUP /automount
EXCLUDE.ARCHIVE /Network
EXCLUDE.BACKUP /Network
EXCLUDE.ARCHIVE /dev
EXCLUDE.BACKUP /dev
EXCLUDE.BACKUP /.vol/.../*
EXCLUDE.ARCHIVE /.vol/.../*
EXCLUDE.BACKUP /automount/.../*
EXCLUDE.ARCHIVE /automount/.../*
EXCLUDE.BACKUP /Network/.../*
EXCLUDE.ARCHIVE /Network/.../*
EXCLUDE.BACKUP /dev/.../*
EXCLUDE.ARCHIVE /dev/.../*
EXCLUDE.DIR /.vol
EXCLUDE.DIR /automount
EXCLUDE.DIR /Network
EXCLUDE.DIR /dev
```

**Mac OS X** Note:

1. Do not specify volumes with periods in the name (...). The backup-archive client uses the sequence of periods as part of include-exclude processing. The client reports an invalid include-exclude statement if a volume has a sequence of periods in the name. The volume *must* be renamed.
2. Objects that have a type of `rhap` and a creator of `lcmt` are excluded from processing. Generally, these are special file-system objects that can also be created with the `mknod` command or are UNIX mount points. The objects or mount points must be manually recreated as part of a full system restore.

**Mac OS X** You should have the following minimum include-exclude list in your include-exclude options file:

```
EXCLUDE /.../dsmsched.log
EXCLUDE /.../dsmprune.log
EXCLUDE /.../dsmj.log
EXCLUDE /.../dsmerror.log
EXCLUDE /.../.hotfiles.bTree

EXCLUDE.DIR /private/tmp
EXCLUDE.DIR /private/var/vm
EXCLUDE.DIR /private/var/tmp
EXCLUDE.DIR /private/var/db/netinfo/local.nidb

EXCLUDE.DIR /.../.Trashes
EXCLUDE.DIR /.../.Spotlight-*
EXCLUDE.DIR /.../Library/Caches
EXCLUDE.DIR /.../.fseventsd
```

**Windows**



## Exclude files with UNC names

You can exclude remotely accessed files by specifying their universal naming convention (UNC) names in your exclude statement.

The following example assumes that local drive letter `g` is mapped to the remote share point:

```
\\remote\books
```

You would like to exclude from backups all files at the root of this share point that have an extension of `.txt`. You could use either of the following commands:

```
exclude g:\*.txt
exclude \\remote\books\*.txt
```

You cannot specify UNC names for removable drives such as DVD, ZIP, or diskette. For example, the following command is *not valid*:

```
exclude \\ocean\as$winnt\system32\...\*
```

## Include and exclude files that contain wildcard characters

You must use special escape characters when including or excluding files and directories that contain wildcard characters.

The backup-archive client treats wildcard characters in different ways on different platforms.

The names of directories and files can contain different symbols. The types of symbols that are allowed depend on the operating system.

**AIX** **Linux** **Mac OS X** **Solaris** For example, on AIX®, the names of directories or files can contain:

```
* ? : [ ]
```

**Windows** For example, on Windows, the names of directories and files should not contain the following symbols:

```
? * < > " / \ : |
```

**Windows** However, they can contain the following symbols:

```
[ ]
```

To specify files and directories in include and exclude statements, you must use the escape character `"\"` to specify the wildcards. However, the escape character can only be used inside the character classes `"[ ]"`.

The following examples illustrate how to specify files and directories that contain wildcard characters using the escape character and character classes in include-exclude statements.

**AIX** **Linux** **Mac OS X** **Solaris** To exclude the single directory `/usr1/[dir2]` from backup processing, enter the following in the `dsm.sys` file or the include-exclude file:

```
exclude.dir "/usr1/[[]dir2[\\]"
```

**AIX** **Linux** **Mac OS X** **Solaris** To exclude the single file `/usr1/fi*le1` from backup processing, enter the following statement in the `dsm.sys` file or the include-exclude file:

```
exclude "/usr1/fi[\\*]le1"
```

**AIX** **Linux** **Mac OS X** **Solaris** Tip: If you use the Preferences Editor to include or exclude a single file or directory that contains wildcard characters, you must manually edit the include or exclude statement to escape the wildcard characters. The Preferences Editor does not automatically escape the wildcard characters. Follow the previous examples to edit the include or exclude statements in the `dsm.sys` file or the include-exclude file.

**Windows** To exclude the single directory `C:\[dir2]` from backup processing, enter the following in the `dsm.opt` file:

```
exclude.dir "C:[\\[]dir2[\\]"
```

**Windows** To exclude the single file `C:\file[.txt]` from backup processing, enter the following in the `dsm.opt` file:

```
exclude.dir "C:[file[\\].txt"
```

**Windows** Tip: If you use the Preferences Editor to include or exclude a single file or directory that contains wildcard characters, you must manually edit the include or exclude statement to escape the wildcard characters. The Preferences Editor does not automatically escape the wildcard characters. Follow the previous examples to edit the include or exclude statements in the `dsm.opt` file or the include-exclude file.

**Related concepts:**

Wildcard characters

## Include and exclude groups of files with wildcard characters

You can use wildcard characters to include or exclude groups of files.

To specify groups of files that you want to include or exclude, use the wildcard characters listed in the following table. This table applies to include and exclude statements *only*.

A very large include-exclude list can decrease backup performance. Use wildcards and eliminate unnecessary include statements to keep the list as short as possible.

Table 1. Wildcard and other special characters

Character	Function
?	<p>The match one character matches any single character <i>except</i> the directory separator; it does not match the end of the string. For example:</p> <ul style="list-style-type: none"> <li>The <b>pattern</b> <code>ab?</code>, <b>matches</b> <code>abc</code>, but <b>does not match</b> <code>ab</code>, <code>abab</code>, or <code>abzzz</code>.</li> <li>The <b>pattern</b> <code>ab?rs</code>, <b>matches</b> <code>abfrs</code>, but <b>does not match</b> <code>abrs</code>, or <code>abllrs</code>.</li> <li>The <b>pattern</b> <code>ab?ef?rs</code>, <b>matches</b> <code>abdefjrs</code>, but <b>does not match</b> <code>abefrs</code>, <code>abdefrs</code>, or <code>abefjrs</code>.</li> <li>The <b>pattern</b> <code>ab??rs</code>, <b>matches</b> <code>abcdrs</code>, <code>abzzrs</code>, but <b>does not match</b> <code>abrs</code>, <code>abjrs</code>, or <code>abkkrs</code>.</li> </ul>
*	<p>The match-all character. For example:</p> <ul style="list-style-type: none"> <li>The <b>pattern</b> <code>ab*</code>, <b>matches</b> <code>ab</code>, <code>abb</code>, <code>abxxx</code>, but <b>does not match</b> <code>a</code>, <code>b</code>, <code>aa</code>, <code>bb</code>.</li> <li>The <b>pattern</b> <code>ab*rs</code>, <b>matches</b> <code>abrs</code>, <code>abtrs</code>, <code>abrsrs</code>, but <b>does not match</b> <code>ars</code>, or <code>aabrs</code>, <code>abrss</code>.</li> <li>The <b>pattern</b> <code>ab*ef*rs</code>, <b>matches</b> <code>abefrs</code>, <code>abefghrs</code>, but <b>does not match</b> <code>abefr</code>, <code>abers</code>.</li> <li>The <b>pattern</b> <code>abcd.*</code>, <b>matches</b> <code>abcd.c</code>, <code>abcd.txt</code>, but <b>does not match</b> <code>abcd</code>, <code>abcdc</code>, or <code>abcdtxt</code>.</li> </ul>
<b>Windows</b> \...	<p><b>Windows</b> The match-n character matches zero or more directories.</p> <p>The following pattern specifies all files in the root directory of the C drive:</p> <pre>c:\*</pre> <p>The following pattern specifies all files and all directories on the C drive:</p> <pre>c:\...\*</pre>
<b>AIX</b> <b>Linux</b> <b>Solaris</b> <b>Mac OS X</b> /...	<p><b>AIX</b>   <b>Linux</b>   <b>Solaris</b>   <b>Mac OS X</b> The match-n character matches zero or more directories.</p>
[	<p>The open character-class character begins the enumeration of a character class. For example:</p> <pre>xxx[abc] matches xxxa, xxxb, or xxxc.</pre>
-	<p>The character-class range includes characters from the first character to the last character specified. For example:</p> <pre>xxx[a-z] matches xxxa, xxxb, xxxc, ... xxxz.</pre> <p><b>Windows</b> This format should not be used to specify remote drives in an <b>exclude</b> statement.</p>
<b>AIX</b> <b>Linux</b> <b>Solaris</b> <b>Mac OS X</b> <b>Windows</b> \	<p><b>AIX</b>   <b>Linux</b>   <b>Solaris</b>   <b>Mac OS X</b>   <b>Windows</b> The literal escape character. When used within a character class, it treats the next character literally. When used outside of a character class, it is not treated in this way. For example, if you want to include the <code>]</code> in a character class, enter <code>[...]</code>. The escape character removes the usual meaning of <code>]</code> as the close character-class character.</p>
]	<p>The close character-class character ends the enumeration of a character class.</p>

Character	Function
<b>Windows</b> :	<b>Windows</b> The drive separator character separates a file specification. The character <i>before</i> the colon identifies a drive letter. The characters <i>after</i> the colon identify file specification or pattern. For example:  d:\direct\file.nam

**Windows** Note: Because a drive specification can consist of only one letter, you should not use more than one wildcard or a combination of a wildcards with a letter to designate a drive specification. The following patterns are not allowed, and if specified in the client options file (dsm.opt), stops the client program immediately after it starts:

- Windows**
- ?\*:\test.txt
  - \*?:\...\pagefile.sys
  - H\*:\test.\*
  - \*H:\test.txt
  - myvolume\*:\
  - myvolume?\*\*\

**Windows** If you are using UNC names, Table 2 shows how to correctly specify shared drives.

Table 2. Specifying a drive specification using wildcards

Incorrect	Correct
\\remote*:\...\**	\\remote*\$\...\**
\\remote?:\...\**	\\remote?\$\...\**
\\remote*:\...\pagefile.sys	\\remote*\$\...\pagefile.sys

**Related concepts:**

Wildcard characters

## Examples using wildcards with include and exclude patterns

The backup-archive client accepts the exclude.dir option, which can be used to exclude directory entries. However, the include and exclude.dir options cannot be used together.

**Mac OS X** **AIX** **Linux** **Solaris** **Mac OS X** Note: In the dsm.sys file, the include and exclude options do not work with symbolic links to directories. For example, do not use /u in your include or exclude statements because /u is a symbolic link to the /home directory. Instead of entering:

```
include /u/tmp/save.fil
```

enter:

```
include /home/tmp/save.fil
```

**AIX** **Linux** **Solaris** **Mac OS X** However, the exclude option does work with symbolic links to directories when you enter a backup command with the absolute path that contains the symbolic link.

Table 1 shows how to use wildcard characters to include or exclude files.

Table 1. Using wildcard characters with include and exclude patterns

Task	Pattern
<b>AIX</b> <b>Linux</b> <b>Solaris</b> <b>Mac OS X</b> Exclude all files that end with .doc, except those found in the home directory of aleko, Documents directory.	<b>AIX</b> <b>Linux</b> <b>Solaris</b> <b>Mac OS X</b> EXCLUDE ../../*.doc INCLUDE "/home/aleko/Documents/ *.doc"
<b>AIX</b> <b>Linux</b> <b>Solaris</b> <b>Mac OS X</b> Exclude all files during backup with an extension of bak, except those found on the /usr file system in the dev directory.	<b>AIX</b> <b>Linux</b> <b>Solaris</b> <b>Mac OS X</b> exclude ../../*.bak include /usr/dev/*.bak
<b>Windows</b> Exclude all files during backup with an extension of bak, except those found on the d: drive in the dev directory.	<b>Windows</b> exclude ?:\*.bak include d:\dev\*.bak

Task	Pattern
<b>AIX</b> <b>Linux</b> <b>Solaris</b> <b>Mac OS X</b> Exclude all files and directories under any Documents directory that might exist, <i>except</i> for the Current file of user aleko.	<b>AIX</b> <b>Linux</b> <b>Solaris</b> <b>Mac OS X</b> EXCLUDE /.../Documents/.../* INCLUDE "/home/aleko/Documents/Current"
<b>AIX</b> <b>Linux</b> <b>Solaris</b> <b>Mac OS X</b> Exclude all files in any directory named "tmp" and its subdirectories, <i>except</i> for the file /home/tmp/save.fil.	<b>AIX</b> <b>Linux</b> <b>Solaris</b> <b>Mac OS X</b> exclude /.../tmp/.../* include /home/tmp/save.fil
<b>Windows</b> Exclude all files in any directory named "tmp" and its subdirectories, <i>except</i> for the file d:\tmp\save.fil.	<b>Windows</b> exclude ?:\...\tmp\...*\ninclude d:\tmp\save.fil
<b>Mac OS X</b> <b>AIX</b> <b>Linux</b> <b>Solaris</b> <b>Mac OS X</b> Exclude any .cpp file in any directory on the Vol1, Vol2, Vol3, and Vol4 volumes.	<b>Mac OS X</b> <b>AIX</b> <b>Linux</b> <b>Solaris</b> <b>Mac OS X</b> EXCLUDE /Volumes/Vol[1-4]/.../*.cpp
<b>Mac OS X</b> Exclude any .cpp file in any directory on the Vol1, Vol2, Vol3, and Vol4 volumes.	<b>Mac OS X</b> EXCLUDE /Volumes/Vol[1-4]/.../*.cpp
<b>AIX</b> <b>Linux</b> <b>Solaris</b> <b>Mac OS X</b> Exclude any .cpp file in any directory on the /fs1, /fs2, /fs3 and /fs4 file systems.	<b>AIX</b> <b>Linux</b> <b>Solaris</b> <b>Mac OS X</b> EXCLUDE /fs[1-4]/.../*.cpp
<b>AIX</b> <b>Linux</b> <b>Solaris</b> <b>Mac OS X</b> Exclude the .cpp files found in the /fs2/source directory.	<b>AIX</b> <b>Linux</b> <b>Solaris</b> <b>Mac OS X</b> EXCLUDE /fs2/source/*.cpp
<b>Windows</b> Exclude any .obj file for backup in any directory on the c: e: f: and g: drives.	<b>Windows</b> exclude [ce-g]:\...*.obj  The c: e: f: and g: drives are local or removable.
<b>AIX</b> <b>Linux</b> <b>Solaris</b> <b>Mac OS X</b> Exclude any .o file in any directory on the /usr1, /usr2, and /usr3 file systems.	<b>AIX</b> <b>Linux</b> <b>Solaris</b> <b>Mac OS X</b> exclude /usr[1-3]/.../*.o
<b>AIX</b> <b>Linux</b> <b>Solaris</b> <b>Mac OS X</b> Exclude the .o files found in the root directory in the usr2 file system <i>only</i> .	<b>AIX</b> <b>Linux</b> <b>Solaris</b> <b>Mac OS X</b> exclude /usr2/*.o
<b>Windows</b> Exclude the .obj files found in the root directory in the d: drive <i>only</i> .	<b>Windows</b> exclude d:\*.obj
<b>AIX</b> <b>Linux</b> <b>Solaris</b> <b>Mac OS X</b> Exclude any file that resides under the tmp directory found in any file system.	<b>AIX</b> <b>Linux</b> <b>Solaris</b> <b>Mac OS X</b> exclude /.../tmp/.../*
<b>Windows</b> Exclude any file that resides under the tmp directory found on any drive.	<b>Windows</b> exclude ?:\tmp\...*\n
<b>AIX</b> <b>Linux</b> <b>Solaris</b> <b>Mac OS X</b> Exclude the entire directory structure /var/spool from all processing.	<b>AIX</b> <b>Linux</b> <b>Solaris</b> <b>Mac OS X</b> exclude.dir /var/spool
<b>AIX</b> <b>Linux</b> <b>Solaris</b> <b>Mac OS X</b> Exclude a single file system from backup processing.	<b>AIX</b> <b>Linux</b> <b>Solaris</b> <b>Mac OS X</b> exclude.fs /fs1 exclude.fs home:
<b>AIX</b> <b>Linux</b> <b>Solaris</b> <b>Mac OS X</b> Exclude all file systems mounted anywhere in the /test/myfs/fs01 and /test/myfs/fs02 directory tree from backup processing.	<b>AIX</b> <b>Linux</b> <b>Solaris</b> <b>Mac OS X</b> exclude.fs /test/myfs/fs01/.../* exclude.fs /test/myfs/fs02/*
<b>AIX</b> <b>Linux</b> <b>Solaris</b> <b>Mac OS X</b> Exclude the /home/mydir/test1 directory and any files and subdirectories under it.	<b>AIX</b> <b>Linux</b> <b>Solaris</b> <b>Mac OS X</b> exclude.dir /home/mydir/test1
<b>Windows</b> Exclude the c:\mydir\test1 directory and any files and subdirectories under it.	<b>Windows</b> exclude.dir c:\mydir\test1

Task	Pattern
<b>AIX</b>   <b>Linux</b>   <b>Solaris</b>   <b>Mac OS X</b> Exclude all directories under the /home/mydir directory with names beginning with test.	<b>AIX</b>   <b>Linux</b>   <b>Solaris</b>   <b>Mac OS X</b> exclude.dir /home/mydir/test*
<b>Windows</b> Exclude all directories under the \mydir directory with names beginning with test.	<b>Windows</b> exclude.dir c:\mydir\test*
<b>AIX</b>   <b>Linux</b>   <b>Solaris</b>   <b>Mac OS X</b> Exclude all directories directly under the /mydir directory with names beginning with test, on any file system.	<b>AIX</b>   <b>Linux</b>   <b>Solaris</b>   <b>Mac OS X</b> exclude.dir ../mydir/test*
<b>Windows</b> Exclude all directories directly under the \mydir directory with names beginning with test, on any drive.	<b>Windows</b> exclude.dir ?:\mydir\test*
<b>AIX</b>   <b>Linux</b>   <b>Solaris</b> Exclude the raw logical volume from image backup.	<b>AIX</b>   <b>Linux</b>   <b>Solaris</b> exclude.image /dev/hd0
<b>Windows</b> Exclude the raw logical volume from image backup.	<b>Windows</b> exclude.image c:\*
<b>AIX</b>   <b>Linux</b>   <b>Solaris</b>   <b>Mac OS X</b>   <b>Mac OS X</b> Exclude all symbolic links or aliases (aliases apply to Mac OS X) from backup processing, except for the Docs directory for user1.	<b>AIX</b>   <b>Linux</b>   <b>Solaris</b>   <b>Mac OS X</b>   <b>Mac OS X</b> EXCLUDE.ATTRIBUTE.SYMLINK ../* INCLUDE.ATTRIBUTE.SYMLINK /Users/ user1/Docs/*
<b>Windows</b> Exclude all directories and files on the local drives, except the c: drive.	<b>Windows</b> exclude [abd-z]:\...\* exclude.dir [abd-z]:\...\*

#### Related concepts:

Examples using wildcards with include and exclude patterns

#### Related reference:

Exclude options

<b>Mac OS X</b>	<b>AIX</b>	<b>Linux</b>	<b>Solaris</b>
-----------------	------------	--------------	----------------

## Symbolic link and alias processing

The backup-archive client evaluates all exclude.fs and exclude.dir statements and removes the excluded file spaces and directories.

After this initial evaluation, the client evaluates any include-exclude statements for controlling symbolic link and alias processing (exclude.attribute.symlink and include.attribute.symlink) against the remaining list of objects available for processing.

Alias processing applies to Mac OS X.

Table 1 defines options for controlling symbolic link and alias processing.

Table 1. Options for controlling symbolic link and alias processing

Option	Description	Page
exclude.attribute.symlink	Excludes a file or a group of files that are symbolic links or aliases from backup processing only.	Exclude options
include.attribute.symlink	Includes a file or a group of files that are symbolic links or aliases within broad group of excluded files for backup processing only.	Include options

## Determine compression and encryption processing

The backup-archive client evaluates exclude.dir and any other include-exclude options controlling backup and archive processing, and then determines which files undergo compression and encryption processing.

The following options determine which files undergo compression and encryption processing.

Table 1. Options for controlling compression and encryption processing

Option	Description	Page
<b>Compression processing</b>		
exclude.compression	Excludes files from compression processing if compression=yes is specified. This option applies to backups and archives.	Exclude options
include.compression	Includes files for compression processing if compression=yes is specified. This option applies to backups and archives.	Include options
<b>Encryption processing</b>		
exclude.encrypt	Excludes files from encryption processing.	Exclude options
include.encrypt	Includes files for encryption processing.  The data that you include is stored in encrypted form, and encryption does not affect the amount of data sent or received.  <b>Important:</b> The include.encrypt option is the only way to enable encryption on the Backup-Archive client. If no include.encrypt statements are used encryption will not occur.	Include options

AIX

Linux

Solaris

Table 2. Options for controlling compression and encryption

Option	Description	Page
<b>Compression processing</b>		
exclude.compression	Excludes files from compression processing if compression=yes is specified. This option applies to backups and archives.	Exclude options
include.compression	Includes files for compression processing if compression=yes is specified. This option applies to backups and archives.	Include options
<b>Encryption processing</b>		
exclude.encrypt	Excludes files from encryption processing.	Exclude options
include.encrypt	Includes files for encryption processing.  The data that you include is stored in encrypted form, and encryption does not affect the amount of data sent or received.  <b>Important:</b> The include.encrypt option is the only way to enable encryption on the Backup-Archive client. If no include.encrypt statements are used encryption will not occur.	Include options

## Preview include-exclude list files

You can preview the list of objects to be backed up or archived according to the include-exclude list, prior to sending any data to the server.

The backup-archive client GUI directory tree shows detailed information of included and excluded objects. The directory tree windows in the backup-archive client GUI allow you to select files and directories to include or exclude. You should use this preview command to make sure that you include and exclude the correct files. The following is a sample scenario for using the include-exclude preview function.

For example, follow these steps to back up the files on your `/Users/home` file space:

1. Start the backup-archive client GUI and open the Backup tree. You can see all of the directories and files that have been excluded by your options file and other sources.
2. Scroll down the tree and notice that all of the `*.o` files in your `/Volumes/home/mary/myobjdir` are backed up.
3. You do not want to back up all of the `*.o` files, so you right click a `.o` file, and choose "View File Details" from the popup menu.

4. The dialog shows that these files are included, so click the "Advanced" button and create a rule to exclude all .o files from the DATA:\home file space.
5. A rule is created at the bottom of your options file. The current directory is refreshed in the Backup tree, and the .o files have the red 'X', meaning they are excluded.
6. When you look at other directories, they show the new excludes that you have added. Press "Backup" and back up the files on your /home file space.

**Related reference:**

Preview Archive  
Preview Backup

## Include and exclude option processing

The IBM Spectrum Protect™ server can define include-exclude options using the `inclexcl` parameter in a client option set.

The include-exclude statements specified by the server are evaluated along with those in the client options file. The server include-exclude statements are always enforced and placed at the bottom of the include-exclude list and evaluated before the client include-exclude statements.

**Windows** If the client options file include-exclude list contains one or more `inclexcl` options that specify include-exclude files, the include-exclude statements in these files are placed in the list position occupied by the `inclexcl` option and processed accordingly.

**AIX** **Linux** **Solaris** **Mac OS X** If the `dsm.sys` file include-exclude list contains one or more `inclexcl` options that specify include-exclude files, the include-exclude statements in these files are placed in the list position occupied by the `inclexcl` option and processed accordingly.

A very large include-exclude list can decrease backup performance. Use wildcards and eliminate unnecessary include statements to keep the list as short as possible.

**Windows** When performing an incremental backup, the client evaluates all `exclude.dir` statements first, and removes the excluded directories and files from the list of objects available for processing.

**AIX** **Linux** **Solaris** **Mac OS X** When performing an incremental backup, the client evaluates all `exclude.fs` and `exclude.dir` statements first, and removes the excluded file spaces, directories, and files from the list of objects available for processing.

**Windows** After evaluating all `exclude.dir` statements, the client evaluates the include-exclude list from the bottom up and stops when it finds an include or exclude statement that matches the file it is processing. The order in which the include and exclude options are entered therefore affects which files are included and excluded.

**AIX** **Linux** **Solaris** **Mac OS X** After evaluating all `exclude.fs` and `exclude.dir` statements, the client evaluates the include-exclude statements for controlling symbolic link or alias processing (`exclude.attribute.symlink` and `include.attribute.symlink`) from the bottom up and stops if it finds an include or exclude statement that matches the file it is processing. After the include-exclude statements for controlling symbolic link or alias processing are processed, the client evaluates the remaining include-exclude list from the bottom up and stops when it finds an include or exclude statement that matches the file it is processing. The order in which the include and exclude options are entered therefore affects which files are included and excluded.

To display a list of all include-exclude statements in effect on your client workstation in the actual order they are processed, use the query `inclexcl` command.

The client program processes the list of include-exclude statements according to the following rules:

1. Files are checked; directories are only checked if the `exclude.dir` option is specified.
2. File names are compared to the patterns in the include-exclude list from the bottom up. When a match is found, the processing stops and checks whether the option is include or exclude. If the option is include, the file is backed up. If the option is exclude, the file is not backed up.  
Note: If a match is not found, files are implicitly included and backed up.
3. When a file is backed up, it is bound to the default management class unless it matched an include statement that specified a different management class name, in which case the file is bound to that management class.

The following examples demonstrate bottom up processing. **Mac OS X** **AIX** **Linux** **Solaris**

**Example 1**

Assume that `Ia Pomme` is not the startup disk.

```
EXCLUDE /.../*.cpp
INCLUDE "/Volumes/La Pomme/Foo/.../*.cpp"
EXCLUDE "/Volumes/La Pomme/Foo/Junk/*.cpp"
```

The file being processed is: /Volumes/La Pomme/Foo/Dev/test.cpp. Processing follows these steps:

1. Rule 3 (the last include or exclude statement defined) is checked first because of bottom-up processing. The pattern /Volumes/La Pomme/Foo/Junk/\*.cpp does not match the file name that is being processed.
2. Processing moves to Rule 2 and checks. This time, pattern /Volumes/La Pomme/Foo/.../\*.cpp matches the file name that is being processed. Processing stops, the option is checked, and it is included.
3. File /Volumes/La Pomme/Foo/Dev/test.cpp is backed up.

#### Example 2

Assume that La Pomme is not the startup disk.

```
EXCLUDE /.../*.cpp
INCLUDE "/Volumes/La Pomme/Foo/.../*.cpp"
EXCLUDE "/Volumes/La Pomme/Foo/Junk/*.cpp"
```

The file being processed is: /Volumes/La Pomme/Widget/Sample File. Processing follows these steps:

1. Rule 3 is checked and finds no match.
2. Rule 2 is checked and finds no match.
3. Rule 1 is checked and finds no match.
4. Because a match is not found, Volumes/La Pomme/Widget/Sample File is implicitly included and is backed up.

#### Example 3

Assume that you defined the following statements for the include and exclude options:

```
exclude *.o
include /home/foo/.../*.o
exclude /home/foo/junk/*.o
```

The file being processed is: /home/foo/dev/test.o. Processing follows these steps:

1. Rule 3 (the last statement defined) is checked first because of bottom-up processing. The pattern /home/foo/junk/\*.o does not match the file name that is being processed.
2. Processing moves to Rule 2 and checks. This time, pattern /home/foo/.../\*.o matches the file name that is being processed. Processing stops, the option is checked, and it is include.
3. File /home/foo/dev/test.o is backed up.

#### Example 4

Assume that you defined the following statements for the include and exclude options:

```
exclude *.obj
include /home/foo/.../*.o
exclude /home/foo/junk/*.o
```

The file being processed is: /home/widg/copyit.txt . Processing follows these steps:

1. Rule 3 is checked and finds no match.
2. Rule 2 is checked and finds no match.
3. Rule 1 is checked and finds no match.
4. Because a match is not found, file /home/widg/copyit.txt is implicitly included and backed up.

#### Example 5

Assume that you defined the following statements for the include and exclude options:

```
exclude /.../*.o
include /home/foo/.../*.o
exclude /home/foo/junk/*.o
```

The current file being processed is: /home/lib/objs/printf.o. Processing follows these steps:

1. Rule 3 is checked and finds no match.
2. Rule 2 is checked and finds no match.
3. Rule 1 is checked and a match is found.
4. Processing stops, the option is checked, and it is excluded.
5. File /home/lib/objs/printf.o is not backed up.



## Example 6

Assume that you defined the following statements for the include and exclude options:

```
exclude.attribute.symlink /.../*
exclude /.../*.o
include /home/foo/.../*.o
exclude /home/foo/junk/*.o
```

The current file being processed is: /home/lib/objs/printf.o. Processing follows these steps:

1. The exclude.attribute.symlink statement is checked first. If the printf.o file is a symbolic link it is excluded, otherwise proceed to the next step. Note that the exclude.attribute.symlink statements are always processed before the other include-exclude statements, regardless of their position in the include-exclude list.
2. Rule 3 is checked and finds no match.
3. Rule 2 is checked and finds no match.
4. Rule 1 is checked and a match is found.
5. Processing stops, the option is checked, and it is excluded.
6. File /home/lib/objs/printf.o is not backed up.

## Windows

## Example 1

Assume that you defined the following statements for the include and exclude options:

```
exclude ?:\*.obj
include c:\foo\...\*.obj
exclude c:\foo\junk\*.obj
```

The file being processed is: c:\foo\dev\test.obj. Processing follows these steps:

1. Rule 3 (the last statement defined) is checked first because of bottom-up processing. The pattern c:\foo\junk\\*.obj does not match the file name that is being processed.
2. Processing moves to Rule 2 and checks. This time, pattern c:\foo\...\\*.obj matches the file name that is being processed. Processing stops, the option is checked, and it is included.
3. File c:\foo\dev\test.obj is backed up.

## Example 2

Assume that you defined the following statements for the include and exclude options:

```
exclude ?:\*.obj
include c:\foo\...\*.obj
exclude c:\foo\junk\*.obj
```

The file being processed is: c:\widg\copyit.bat. Processing follows these steps:

1. Rule 3 is checked and finds no match.
2. Rule 2 is checked and finds no match.
3. Rule 1 is checked and finds no match.
4. Because a match is not found, file c:\widg\copyit.bat is implicitly included and backed up.

## Example 3

Assume that you defined the following statements for the include and exclude options:

```
exclude ?:\...\*.obj
include c:\foo\...\*.obj
exclude c:\foo\junk\*.obj
```

The current file being processed is: c:\lib\objs\printf.obj. Processing follows these steps:

1. Rule 3 is checked and finds no match.
2. Rule 2 is checked and finds no match.
3. Rule 1 is checked and a match is found.
4. Processing stops, the option is checked, and it is excluded.
5. File c:\lib\objs\printf.obj is not backed up.

## Related concepts:

Exclude file spaces and directories

Processing options

## Related reference:

## Processing rules when using UNC names

When processing files with UNC names, there are rules that must be followed.

The backup-archive client uses the rules that are described in Include and exclude option processing. The rules in Explicit use of UNC names for remote drives also apply.

- **Windows** Explicit use of UNC names for remote drives  
The backup-archive client recognizes explicit use of UNC names for remote drives.
- **Windows** Conversion of DOS pathnames for fixed and remote drives  
The backup-archive client converts DOS path names that are mapped to remote share points.
- **Windows** Character-class matching examples  
This topic shows examples of valid matches using character class.

Windows

## Explicit use of UNC names for remote drives

The backup-archive client recognizes explicit use of UNC names for remote drives.

For example, as shown in Table 1, the UNC name pattern can be substituted for the DOS pattern.

Assume local drive letter `r:` is mapped to remote share point `\\remote\c$`, `s:` is mapped to `\\remote\share4`, and `t:` is mapped to `\\remote\share2`.

Table 1. UNC name patterns and DOS patterns

UNC name pattern	DOS pattern
<code>\\remote\c\$\include\file.out</code>	<code>r:\include\file.out</code>
<code>\\remote\c\$\...\file.out</code>	<code>r:\...\file.out</code>
<code>\\remote\share4\exclude\*</code>	<code>s:\exclude\*</code>
<code>\\remote\share2\...\?.out</code>	<code>t:\...\?.out</code>

Windows

## Conversion of DOS pathnames for fixed and remote drives

The backup-archive client converts DOS path names that are mapped to remote share points.

For example, a remote share point that is mapped from `r:\test\...\exclude.out` to `\\remote\share\test\...\exclude.out` is converted. Remote share points that are not mapped are not converted. Files on removable media are not converted.

Windows

## Character-class matching examples

This topic shows examples of valid matches using character class.

```
\\remote[a-z]\share\file.txt  
matches    \\remotea\share\file.txt  
           \\remote\share[a-z]\file.txt  
matches    \\remote\sharex\file.txt  
           \\remote\share\file[a-z].txt  
matches    \\remote\share\fileg.txt
```

## Getting started

Before you can use the IBM Spectrum Protect™ backup-archive client, you must learn how to start a GUI or command-line session, and how to start the client scheduler automatically. You can also learn about other commonly used tasks.

Before you use the backup-archive client, complete the following tasks:

- Starting a Java GUI session
- Starting a command-line session
- Starting a web client session
- Start the client scheduler automatically
- Changing your password

You can also complete the following tasks:

- Sorting file lists using the backup-archive client GUI
- Displaying online help
- Ending a session
- Configuring the client security settings to connect to the IBM Spectrum Protect server version 8.1.2 and later  
There are several configuration options that pertain to the IBM Spectrum Protect client security settings when connecting to the IBM Spectrum Protect server version 8.1.2 and later. Accepting the default values for those options transparently configures the client for enhanced security, and is recommended for most use cases.
- Secure password storage  
Beginning in IBM Spectrum Protect Version 8.1.2, the location of the IBM Spectrum Protect password is changed.
- **Windows** Backup-archive client operations and security rights  
This section explains the types of IBM Spectrum Protect backup-archive client operations that can be performed and the security rights that are needed.
- **Windows** Permissions required to restore files that use adaptive subfile backup  
Adaptive subfile backup is deprecated, but you can still restore subfile backup data that was created with the version 7.1 or earlier client. To restore files that were processed using adaptive subfile backup, you must either be the owner of the file or have read access.
- **Windows** Permissions required to back up, archive, restore or retrieve files on cluster resources  
To back up, restore, archive, or retrieve data residing on Microsoft Cluster Server (MSCS) or Veritas Cluster Server cluster resources, your Windows account must belong to the Administrators or Domain Administrators group or Backup Operators group.
- IBM Spectrum Protect client authentication  
When using the graphical user interface or command line interface of the IBM Spectrum Protect client, you can log on using a node name and password or administrative user ID and password.
- **Windows** User account control  
User Account Control (UAC) is a Windows security feature that helps prevent malware from compromising the operating system. UAC restricts programs to standard user privileges.
- Starting a Java GUI session  
The steps that are used to start the backup-archive client graphical interface (GUI) program depend on the operating system.
- Starting a command-line session  
You can start a command-line session by invoking the `dsmc` command.
- Specifying input strings that contain blank spaces or quotation marks  
You must follow certain rules when you specify an input string that has blanks or quotation marks.
- **Mac OS X** | **AIX** | **Linux** | **Solaris** Starting: Additional considerations  
You can include options as arguments to `dsmj` and `dsmc` commands. For example, you can use options to modify the format that displays dates, times, and numbers, or to include your password so that the backup-archive client does not prompt for it.
- Using the web client in the new security environment  
Beginning with IBM Spectrum Protect Version 8.1.2, you can no longer use the web client to connect to the IBM Spectrum Protect V8.1.2 or later server.
- **Mac OS X** | **AIX** | **Linux** | **Solaris** | **Windows** Start the client scheduler automatically  
You can start the client scheduler automatically when you start your workstation.
- Changing your password  
Your IBM Spectrum Protect administrator can require you to use a password to connect to the server.
- Sorting file lists using the backup-archive client GUI  
You can use the backup-archive client GUI to display, sort, or select files.
- Displaying online help  
You can display online help in any of the following ways: On the backup-archive client GUI, from the web client, or from the `dsmc` command line.

- Ending a session  
You can end a client session from the backup-archive client GUI or from the dsmc command line.
- Online forums  
To participate in user discussions of IBM Spectrum Protect products, you can subscribe to the ADSM-L list server.

## Configuring the client security settings to connect to the IBM Spectrum Protect server version 8.1.2 and later

---

There are several configuration options that pertain to the IBM Spectrum Protect™ client security settings when connecting to the IBM Spectrum Protect server version 8.1.2 and later. Accepting the default values for those options transparently configures the client for enhanced security, and is recommended for most use cases.

- Default security settings for the client (fast path)  
Fast path details the configuration options that impact the security of the client connection to the server and the behavior for various use cases when default values are accepted. This scenario minimizes the steps in the configuration process at endpoints. It automatically obtains certificates from the server when the client connects the first time, assuming that the IBM Spectrum Protect server 'SESSIONSECURITY' parameter is set to 'TRANSITIONAL', which is the default and recommended value. You can follow this scenario whether you first upgrade the IBM Spectrum Protect server to version 8.1.2 and then upgrade the client to version 8.1.2 or vice versa.
- Configuring the client without automatic certificate distribution  
This scenario details the configuration options that impact the security of the client when automatic distribution of certificates from the server is not acceptable. Automatic distribution of certificates from the server is not acceptable if the server is configured to use LDAP authentication or it is necessary that certificates are signed by a certificate authority.

### Default security settings for the client (fast path)

---

Fast path details the configuration options that impact the security of the client connection to the server and the behavior for various use cases when default values are accepted. This scenario minimizes the steps in the configuration process at endpoints. It automatically obtains certificates from the server when the client connects the first time, assuming that the IBM Spectrum Protect™ server 'SESSIONSECURITY' parameter is set to 'TRANSITIONAL', which is the default and recommended value. You can follow this scenario whether you first upgrade the IBM Spectrum Protect server to version 8.1.2 and then upgrade the client to version 8.1.2 or vice versa.

Attention: This scenario cannot be used if the IBM Spectrum Protect server is configured for LDAP authentication. If LDAP is used, you can manually import the certificates necessary by using the dsmcert utility. See [Configuring IBM Spectrum Protect client/server communication with Secure Sockets Layer](#) for details.

### Client options that affect session security

---

1. **SSLREQUIRED.** The default value Default enables existing session-security connections to servers earlier than V8.1.2, and automatically configures the client to securely connect to a V8.1.2 or newer server by using TLS for authentication.
2. **SSLACCEPTCERTFROMSERV.** The default value Yes enables the client to automatically accept a self-signed public certificate from the server, and to automatically configure the client to use that certificate when the client connects to a V8.1.2 or later server.
3. **SSL.** The default value No indicates that encryption is not used when data is transferred between the client and a server earlier than V8.1.2. When the client connects to a V8.1.2 or later server, the default value No indicates that object data is not encrypted. All other information is encrypted, when the client communicates with the server. When the client connects to a V8.1.2 or later server, the value Yes indicates that SSL is used to encrypt all information, including object data, when the client communicates with the server.
4. **SSLFIPSMODE.** The default value No indicates that a Federal Information Processing Standards (FIPS) certified SSL library is not needed.

In addition, the following options apply only when the client uses SSL connections to a server earlier than V8.1.2. They are ignored when the client connects to a V8.1.2 or later server.

1. **SSLDISABLELEGACYTLS.** The default value No indicates that connections at TLS 1.1 and lower SSL protocols are allowed when the client communicates with a server V8.1.1 and earlier V8 levels, and V7.1.7 and earlier levels.
2. **LANFREESSL.** Specifies whether the client uses SSL communication with the Storage Agent when LAN-free data transfer is configured.

3. REPLSSLPORT. Specifies the TCP/IP port address that is enabled for SSL when the client communicates with the replication target server.

## Uses cases for default security settings for the client (fast path)

---

1. First, the server is upgraded to V8.1.2. Then, the client is upgraded. The existing client is not using SSL communications:
  - o No changes are needed to the client security options.
  - o The client configuration is automatically updated to use TLS when the client authenticates with the server.
2. First, the server is upgraded to V8.1.2. Then, the client is upgraded. The existing client is using SSL communications:
  - o No changes are needed to the client security options.
  - o SSL communication with existing server public certificate continues to be used.
  - o SSL communication is automatically enhanced to use the TLS level that is needed by the server.
3. First, the client is upgraded to V8.1.2. Then, the server is upgraded later. The existing client is not using SSL communications:
  - o No changes are needed to the client security options.
  - o Existing authentication protocol continues to be used to servers at levels earlier than V8.1.2.
  - o The client configuration is automatically updated to use TLS when the client authenticates with the server after the server is updated to V8.1.2 or later.
4. First, the client is upgraded to V8.1.2. Then, the server is upgraded later. The existing client is using SSL communications:
  - o No changes are needed to the client security options.
  - o SSL communication with existing server public certificate continues to be used with servers at levels earlier than V8.1.2.
  - o SSL communication is automatically enhanced to use the TLS level that is needed by the server after the server is updated to V8.1.2 or later.
5. First, the client is upgraded to V8.1.2. Then, the client connects to multiple servers. The servers are upgraded to V8.1.2 at different times:
  - o No changes are needed to the client security options.
  - o The client uses existing authentication and session security protocol to servers at versions earlier than V8.1.2, and automatically upgrades to use TLS authentication when initially connecting to a server at V8.1.2 or later. Session security is managed per server.
6. New client installation, server is at V8.1.2 or later:
  - o Configure the client according to a new client installation.
  - o Default values for the client security options automatically configure the client for TLS-encrypted session authentication.
  - o Set the SSL parameter to the Yes value if encryption of all data transfers between the client and the server is needed.
7. New client installation, server is at a version earlier than V8.1.2:
  - o Configure the client according to a new client installation.
  - o Accept the default values for client session-security parameters if SSL encryption of all data transfers is not needed.
    - Non-SSL authentication protocol is used until the server is upgraded to V8.1.2 or later.
  - o Set the SSL parameter to the Yes value if encryption of all data transfers between the client and the server is needed, and proceed with the manual client configuration for SSL.
    - See Configuring IBM Spectrum Protect client/server communication with Secure Sockets Layer for details.
    - SSL communication is automatically enhanced to use the TLS level that is needed by the server after the server is updated to V8.1.2 or later.

### Related reference:

Sslrequired  
Sslacceptcertfromserv  
Ssl  
Sslfipsmode  
Ssldisablelegacytls  
Lanfreessl  
Replsslport

## Configuring the client without automatic certificate distribution

---

This scenario details the configuration options that impact the security of the client when automatic distribution of certificates from the server is not acceptable. Automatic distribution of certificates from the server is not acceptable if the server is configured to use LDAP authentication or it is necessary that certificates are signed by a certificate authority.

Note: In this scenario, you can accept the default values for most of the session-security options, except for the SSLACCEPTCERTFROMSERV option.

## Client options that affect session security

---

1. **SSLREQUIRED.** The default value Default enables existing session-security connections to servers earlier than V8.1.2, and automatically configures the client to securely connect to a V8.1.2 or newer server by using TLS for authentication.
2. **SSLACCEPTCERTFROMSERV.** Set this value to No to ensure that the client does not automatically accept a self-signed public certificate from the server when the client first connects to a V8.1.2 or later server.
3. **SSL.** The default value No indicates that encryption is not used when data is transferred between the client and a server earlier than V8.1.2. When the client connects to a V8.1.2 or later server, the default value No indicates that object data is not encrypted. All other information is encrypted, when the client communicates with the server. When the client connects to a V8.1.2 or later server, the value Yes indicates that SSL is used to encrypt all information, including object data, when the client communicates with the server.
4. **SSLFIPSMODE.** The default value No indicates that a Federal Information Processing Standards (FIPS) certified SSL library is not needed.

In addition, the following options apply only when the client uses SSL connections to a server earlier than V8.1.2. They are ignored when the client connects to a V8.1.2 or later server.

1. **SSLDISABLELEGACYTLS.** The default value No indicates that connections at TLS 1.1 and lower SSL protocols are allowed when the client communicates with a server V8.1.1 and earlier V8 levels, and V7.1.7 and earlier levels.
2. **LANFREESSL.** Specifies whether the client uses SSL communication with the Storage Agent when LAN-free data transfer is configured.
3. **REPLSSLPORT.** Specifies the TCP/IP port address that is enabled for SSL when the client communicates with the replication target server.

## Uses cases for configuring the client without automatic certificate distribution

---

1. First, the server is upgraded to V8.1.2. Then, the client is upgraded. The existing client is not using SSL communications:
  - o Use the client configuration wizard to set the SSLACCEPTCERTFROMSERV option with the value No.
  - o Obtain the necessary certificate from a trusted source.
  - o Use the dsmdcert utility to import the certificate for client use. See Configuring IBM Spectrum Protect client/server communication with Secure Sockets Layer for details.
2. First, the server is upgraded to V8.1.2. Then, the client is upgraded. The existing client is using SSL communications:
  - o No changes are needed to the client security options. If the client already has a server certificate for SSL communication, the SSLACCEPTCERTFROMSERV option does not apply.
  - o SSL communication with existing server public certificate continues to be used.
  - o SSL communication is automatically enhanced to use the TLS level that is needed by the server.
3. First, the client is upgraded to V8.1.2. Then, the server is upgraded later. The existing client is not using SSL communications:
  - o Use the client configuration wizard to set the SSLACCEPTCERTFROMSERV option with the value No.
  - o Existing authentication protocol continues to be used to servers at levels earlier than V8.1.2.
  - o Before the client connects to an 8.1.2 or later server:
    - Obtain the necessary certificate from a trusted source.
    - Use the dsmdcert utility to import the certificate for client use. See Configuring IBM Spectrum Protect client/server communication with Secure Sockets Layer for details.
4. First, the client is upgraded to V8.1.2. Then, the server is upgraded later. The existing client is using SSL communications:
  - o No changes are needed to the client security options. If the client already has a server certificate for SSL communication, the SSLACCEPTCERTFROMSERV option does not apply.
  - o SSL communication with existing server public certificate continues to be used with servers at levels earlier than V8.1.2.
  - o SSL communication is automatically enhanced to use the TLS level that is needed by the server after the server is updated to V8.1.2 or later.
5. First, the client is upgraded to V8.1.2. Then, the client connects to multiple servers. The servers are upgraded to V8.1.2 at different times:
  - o Use the client configuration wizard to set the SSLACCEPTCERTFROMSERV option with the value No.
  - o Existing authentication protocol continues to be used to servers at levels earlier than V8.1.2.
  - o Before the client connects to an 8.1.2 or later server, or when SSL communication is needed at any server level:
    - Obtain the necessary certificate for the target server from a trusted source.
    - Use the dsmdcert utility to import the certificate for client use. See Configuring IBM Spectrum Protect client/server communication with Secure Sockets Layer for details.

- The client uses existing authentication and session security protocol to servers at versions earlier than V8.1.2, and automatically upgrades to use TLS authentication when initially connecting to a server at V8.1.2 or later. Session security is managed per server.
- 6. New client installation, server is at V8.1.2 or later:
  - Configure the client according to a new client installation.
  - Use the client configuration wizard to set the SSLACCEPTCERTFROMSERV option with the value No.
  - Obtain the necessary certificate from a trusted source.
  - Use the dsmdcert utility to import the certificate for client use. See Configuring IBM Spectrum Protect client/server communication with Secure Sockets Layer for details.
  - Set the SSL parameter to the Yes value if encryption of all data transfers between the client and the server is needed.
- 7. New client installation, server is at a version earlier than V8.1.2, SSL-encrypted sessions are needed:
  - Configure the client according to a new client installation.
  - Set the SSL parameter to the Yes value.
  - Obtain the necessary certificate from a trusted source.
  - Use the dsmdcert utility to import the certificate for client use. See Configuring IBM Spectrum Protect client/server communication with Secure Sockets Layer for details.
- 8. New client installation, server is at a version earlier than V8.1.2, SSL-encrypted sessions are not needed:
  - Configure the client according to a new client installation.
  - Use the client configuration wizard to set the SSLACCEPTCERTFROMSERV option with the value No.
    - Non-SSL authentication protocol is used until the server is upgraded to V8.1.2 or later.
  - Before the client connects to an 8.1.2 or later server:
    - Obtain the necessary certificate from a trusted source.
    - Use the dsmdcert utility to import the certificate for client use. See Configuring IBM Spectrum Protect client/server communication with Secure Sockets Layer for details.

**Related reference:**

Sslrequired  
 Sslacceptcertfromserv  
 Ssl  
 Sslfipsmode  
 Ssldisablelegacytls  
 Lanfreessl  
 Replsslport

## Secure password storage

---

Beginning in IBM Spectrum Protect™ Version 8.1.2, the location of the IBM Spectrum Protect password is changed.

In V8.1.0 and V7.1.6 and earlier clients, the IBM Spectrum Protect password was stored in the Windows registry for Windows clients, and stored in the TSM.PWD file on UNIX and Linux clients.

Beginning in V8.1.2, the IBM® Global Security Kit (GSKit) keystores are used to store all IBM Spectrum Protect passwords. The process of importing server certificates is simplified. For information about importing server certificates, see Configuring IBM Spectrum Protect client/server communication with Secure Sockets Layer.

When you upgrade to IBM Spectrum Protect V8.1.2 backup-archive client, the existing passwords are migrated to the following files in the new password store:

TSM.KDB

The file that stores the encrypted passwords.

TSM.sth

The file that stores the random encryption key that is used to encrypt passwords in the TSM.KDB file. This file is protected by the file system. This file is needed for automated operations.

TSM.IDX

An index file that is used to track the passwords in the TSM.KDB file.

**Linux** **Windows** For Data Protection for VMware clients, the Data Protection for VMware GUI server administration password is migrated to a keystore.

**Windows**

## Password locations on Windows clients

---



On Windows clients, the passwords in the SOFTWARE\IBM\ADSM\CurrentVersion\BackupClient\Nodes registry key and the SOFTWARE\IBM\ADSM\CurrentVersion\Nodes registry key are migrated to the new password store.

The password entries in these registry keys are deleted after the migration.

The migrated server and encryption passwords are stored in the password stores in separate subdirectories of the C:\ProgramData\Tivoli\TSM\baclient directory (a hidden directory). Separating the server passwords this way allows an administrator to grant a non-administrative user access to individual passwords without giving that user access to all the other passwords. The following directories are examples of password file locations:

- C:\ProgramData\Tivoli\TSM\BAClient\NodeName\ServerName
- C:\ProgramData\Tivoli\TSM\BAClient\(\VCB)\ServerName
- C:\ProgramData\Tivoli\TSM\BAClient\(\DOMAIN)\ServerName
- C:\ProgramData\Tivoli\TSM\BAClient\(\FILER)\ServerName

Access to the password stash files (TSM.sth) is restricted to the creator of the keystore, Administrators, and System. A utility (dsmcutil addace) is available to allow Windows users to easily modify password file access control lists. For more information, see ADDACE and DELETEACE.

AIX Linux Mac OS X Solaris

## Password locations on UNIX and Linux clients

---

On UNIX and Linux clients, the existing passwords in the TSM.PWD files are migrated to the new password store in the same location. For root users, the default location for the password store is /etc/adsm. For non-root users, the location of the password store is specified by the passworddir option.

The TSM.PWD file is deleted after the migration.

AIX Linux Mac OS X Solaris

## The trusted communications agent is no longer available

---

The trusted communications agent (TCA), previously used by non-root users in V8.1.0 and V7.1.6 and older clients, is no longer available. Root users can use the following methods to allow non-root users to manage their files:

### Help desk method

With the help desk method, the root user runs all backup and restore operations. The non-root user must contact the root user to request certain files to be backed up or restored.

### Authorized user method

With the authorized user method, a non-root user is given read/write access to the password store by using the passworddir option to point to a password location that is readable and writable by the non-root user. This method allows non-root users to back up and restore their own files, use encryption, and manage their passwords with the passwordaccess generate option.

For more information, see Enable non-root users to manage their own data.

If neither of these methods are satisfactory, you must use the earlier clients that included the TCA.

Windows

## Password locations in cluster environments

---

If you are operating the client in a cluster environment (CLUSTERNODE YES in the client options file), the password files are stored in a subdirectory of the client options file location. The subdirectory name is:

```
NODES\NodeName\ServerName
```

In a cluster configuration, the options file is stored on a cluster disk so that it can be accessed by the takeover node. The password files must also be stored on a cluster disk so that after a failure, the generated backup-archive client password is available to the takeover node.

For example, if the dsm.opt file is in the c:\ClusterStorage\Volume1\SPData directory, the node name is Cluster-B, and the server name is Bigdata, the location for password files is:

```
C:\ClusterStorage\Volume1\SPdata\Nodes\Cluster-B\Bigdata
```

Windows



## Backup-archive client operations and security rights

This section explains the types of IBM Spectrum Protect™ backup-archive client operations that can be performed and the security rights that are needed.

You must have local or domain administrator privileges to install and configure IBM Spectrum Protect client services.

Table 1 summarizes the user security rights needed for backup and restore operations. The information in the table assumes that the default privileges for the Microsoft Windows Administrators group, Backup Operators group, and Users group have not been altered.

Table 1. Required user security rights for IBM Spectrum Protect backup and restore services

Operating system	Account	What can I back up and restore?
Windows Clients	Member of Administrators group	<ul style="list-style-type: none"> <li>Back up and restore all file and directory objects</li> <li>Back up and restore system state</li> <li>System state data (Backup Operators group cannot back up ASR writer data and cannot restore system state data)</li> </ul>
Windows Clients	Member of Backup Operators group	<ul style="list-style-type: none"> <li>Back up and restore all file and directory objects</li> <li>Back up system state, except for ASR Writer</li> </ul> <p>Note: Backup Operator group members cannot restore system state.</p>
Windows Clients	Member of Users or other group	<ul style="list-style-type: none"> <li>Back up and restore all file and directory objects</li> </ul> <p>Attention: Users must have the following Microsoft Windows security privileges in order to back up and restore files and directories:</p> <ul style="list-style-type: none"> <li>Back up files and directories</li> <li>Restore files and directories</li> </ul> <p>These privileges represent a potential security risk since they allow the user to back up any file, or restore any file for which a backup copy exists. The privileges should be granted only to trusted users. For more information about these privileges, see the Microsoft Windows documentation.</p> <p>Note: System state cannot be backed up or restored.</p>

By default, IBM Spectrum Protect client services run under the local system account. However, the local system account does not have access to network mapped drives and does not have the same permissions and logon properties as a user that is logged in to the system. If you experience discrepancies between a user initiated backup and a scheduled backup using the local system account, consider changing the services to run under the user account.

Tip: In addition to the appropriate user security rights, the IBM Spectrum Protect backup-archive client requires that the user has read permission to the root of any drive that needs to be backed up or restored. If you are using the system account to logon for the IBM Spectrum Protect scheduler service, ensure that you grant the system account (SYSTEM) read access to the root of the drive. It is not sufficient to grant Everyone read access to the root of the drive.

Domain resources, such as network drives, can only be accessed by services configured to run under a domain authorized account using `dsmcutil` or the Service Control Panel Application.

Beginning with IBM Spectrum Protect Version 8.1.2, stricter access control is enforced for the IBM Spectrum Protect password storage on Windows operating systems. By default, only the Administrator, SYSTEM, or LocalSystem account has access to the password store and SSL certificates.

You can use the `dsmcutil addace` command to modify the access control list to allow additional users, such as non-administrative users, or processes such as the IBM Spectrum Protect Data Protection client processes to access the password store and SSL certificates.

You can use the `dsmcutil deleteace` command to modify the access control list to remove access to the password store and client certificates for users, such as non-administrative users or processes such as the IBM Spectrum Protect Data Protection client processes.

For more information, see `ADDACE` and `DELETEACE`.

- **Windows** Backup Operators group operations  
The Backup Operators group allows users to back up and restore files regardless of whether they have read or write access to the files.
- **Windows** Considerations before you start using a Backup Operators group account  
There are some items that you need to consider before you use a Backup Operators group account to back up, archive, restore, or retrieve your data.

**Windows**

## Backup Operators group operations

---

The Backup Operators group allows users to back up and restore files regardless of whether they have read or write access to the files.

This group has a limited set of user rights, so some functions are not available to members of the Backup Operators group.

The following list contains the backup-archive client operations that a member of the Backup Operators can do:

- Back up and restore files (see Table 1)
- Back up system state

You must be a member of the Administrators group to back up ASR writer data.

- Start the scheduler service

The following list contains the backup-archive client operations that a member of the Backup Operators cannot do:

- Start any other services (client acceptor, remote client agent, and journal service)
- Install and configure client services
- Use open file support (OFS)
- Back up and restore images
- Back up and restore Windows file shares

**Windows**

## Considerations before you start using a Backup Operators group account

---

There are some items that you need to consider before you use a Backup Operators group account to back up, archive, restore, or retrieve your data.

Consider these items before using a Backup Operators group account to back up, archive, restore, or retrieve your data:

- If you have already been using the backup-archive client with an Administrators group account you might not be able to launch the client because you cannot open the log files (for example `dsmerror.log`). To alleviate this problem, you can grant the Backup Operators group Read and Write permissions to the log files or the directories containing these log files.
- If you have existing backups from a version 5.2 or earlier backup-archive client and you attempt an incremental backup of an existing file space with a member of the Backup Operators group, all of the data appears as changed and it is resent to the IBM Spectrum Protect™ Server.

- Members of the Backup Operators group might not be able to back up or restore file data that was encrypted by an Administrator account using the Windows encrypting file system (EFS).
- Members of the Backup Operators group do not have the proper authority to update the last access time for files that is encrypted with the Windows encrypting file system (EFS). If EFS files are restored by a member of the Backup Operators group, the last access time will not be preserved.

Windows

## Permissions required to restore files that use adaptive subfile backup

---

Adaptive subfile backup is deprecated, but you can still restore subfile backup data that was created with the version 7.1 or earlier client. To restore files that were processed using adaptive subfile backup, you must either be the owner of the file or have read access.

These permissions are in addition to those required to perform a normal restore.

For information about adaptive subfile backup, see Performing a backup with limited bandwidth in the version 7.1 backup-archive client documentation.

Windows

## Permissions required to back up, archive, restore or retrieve files on cluster resources

---

To back up, restore, archive, or retrieve data residing on Microsoft Cluster Server (MSCS) or Veritas Cluster Server cluster resources, your Windows account must belong to the Administrators or Domain Administrators group or Backup Operators group.

By default, Backup Operators do not have the user rights necessary to perform these tasks on a cluster node. However, Backup Operators can perform this procedure if that group is added to the security descriptor for the Cluster service. You can do that using Cluster Administrator or cluster.exe.

## IBM Spectrum Protect client authentication

---

When using the graphical user interface or command line interface of the IBM Spectrum Protect™ client, you can log on using a node name and password *or* administrative user ID and password.

The client prompts for your user ID and compares it to the configured node name. If they match, the client attempts to authenticate the user ID as a node name. If the authentication fails or if the user ID does not match the configured node name, the client attempts to authenticate the user ID as an administrative user ID.

To use an administrative user ID with any of the backup-archive clients, the user ID must have one of the following authorities:

### *System privilege*

Authority over the entire system. An administrator with system privilege can perform any administrative task.

### *Policy privilege*

Authority over the node policy domain. Allows an administrator to manage policy objects, register client nodes, and schedule client operations for client nodes.

### *Client owner*

Authority over the registered IBM Spectrum Protect client node. You can access the client through the web client or backup-archive client. You own the data and have a right to physically gain access to the data remotely. You can back up and restore files on the same or different system, and you can delete file spaces or archive data.

### *Client access*

To use the web client to back up and restore files on a remote client system, you must have an administrative user ID with client access authority over the node name for the remote client system. If you do not want IBM Spectrum Protect administrators with client access authority over your node name to be able to back up and restore files on your system, specify the `revokeremoteaccess` option in your client options file.

Client access authority only allows IBM Spectrum Protect administrators to back up and restore files on remote systems. They do not have physical access to the data. That is, they cannot restore the data belonging to the remote system to their own systems. To restore data belonging to a remote system to your own system, you must possess at least client owner authority.

To determine what authority you have, you can use either of the following methods:

- From the main IBM Spectrum Protect GUI window, select **File** → **Connection Information**.
- Use the IBM Spectrum Protect server QUERY ADMIN command from the administrative command-line client.

**Related reference:**

Revokeremoteaccess  
 QUERY ADMIN command

**Windows**

## User account control

User Account Control (UAC) is a Windows security feature that helps prevent malware from compromising the operating system. UAC restricts programs to standard user privileges.

When UAC is enabled, programs that require elevated privileges cannot run without your permission.

The backup-archive client requires elevated privileges. If UAC is enabled when you run the client, a User Account Control dialog box is displayed. The dialog asks if you want to allow the program to run. If you are not logged in as an administrator, the dialog also asks for your account credentials.

- **Windows** Enabling client access to network shares when UAC is enabled  
 When Windows User Account Control (UAC) is enabled, the backup-archive client cannot access existing network share mappings. The solution is to map the network shares from an elevated command prompt before you start the client.

## Starting a Java GUI session

The steps that are used to start the backup-archive client graphical interface (GUI) program depend on the operating system.

### Procedure

Complete the procedure that is appropriate for your operating system to start the Java™ GUI.

Operating System	Procedure
<p><b>Mac OS X</b></p>	<p><b>Mac OS X</b></p> <ul style="list-style-type: none"> <li>• Double-click the IBM Spectrum Protect™ application to start the backup-archive client without system administrator privileges. When you run the client without system administrator privileges, you can manage files that are owned by the current user.</li> <li>• Double-click IBM Spectrum Protect for Administrators and select IBM Spectrum Protect. After you enter a system administrator user name and password, the client starts with system administrator privileges. When you run the client with system administrator privileges, you can manage files that are owned by all users on the system.</li> <li>• You can also start the backup-archive client by using the dsmj command. You can run the client as either a foreground or background process. The dsmj script is installed in /Library/Application Support/tivoli/tsm/client/ba/bin.</li> </ul>
<p><b>AIX®, Linux, Solaris</b></p>	<p><b>AIX   Linux   Solaris</b></p> <p>On UNIX systems other than Mac OS X, the backup-archive client GUI must be run from the X Window System. If you see the IBM Spectrum Protect icon on your desktop, the client is already running. Double-click the icon to open the IBM Spectrum Protect window. If the IBM Spectrum Protect icon is not displayed on your desktop, start the backup-archive client graphical interface by using the dsmj command. You can run the client as either a foreground or background process.</p>

Operating System	Procedure
<p><b>Windows</b></p> <p><b>Windows</b></p>	<p><b>Windows</b></p> <p>To start the backup-archive client GUI on a Windows system, use one of the following methods:</p> <ul style="list-style-type: none"> <li>• Click Start &gt; Programs &gt; IBM Spectrum Protect &gt; Backup-Archive GUI.</li> <li>• Click Start &gt; Run and enter the full path to the backup client dsm.exe file.</li> <li>• On the command line, change directory to the backup-archive client installation directory and enter dsm.</li> </ul> <p>On Windows operating systems that have the User Account Control feature enabled, you might be prompted to allow the dsm.exe program to run. To allow the program to continue and start the backup-archive client GUI, provide administrative credentials.</p>

**Windows** The backup-archive client locates and uses the options that are specified in the client options file (dsm.opt).

**AIX** **Linux** **Mac OS X** **Solaris** The backup-archive client locates and uses the options that are specified in the client system options file (dsm.sys) and the client options files (dsm.opt).

- IBM Spectrum Protect password  
Your IBM Spectrum Protect administrator can require you to use a password to connect to the server.
- Setup wizard  
When the client GUI starts, it checks to see whether a client options file exists.

**Related tasks:**

**Windows** Configuring the language for displaying the Java GUI

## IBM Spectrum Protect password

Your IBM Spectrum Protect™ administrator can require you to use a password to connect to the server.

The IBM Spectrum Protect client prompts you for the password if one is required. Contact your IBM Spectrum Protect administrator if you do not know your password.

**Related tasks:**

Changing your password

## Setup wizard

When the client GUI starts, it checks to see whether a client options file exists.

If the client options file does not exist (which usually happens after you have installed the client for the first time on your system), the setup wizard automatically starts and guides you through the configuration process.

**Mac OS X** **AIX** **Linux** **Solaris** The client options file is dsm.sys.

**Windows** You can launch the setup wizard at any time to modify your client options file.

**Windows** The client options file is dsm.opt.

## Starting a command-line session

You can start a command-line session by invoking the dsmc command.

**AIX** **Linux** **Solaris** **Mac OS X** Note: If the /usr/bin directory contains a symbolic link to the IBM Spectrum Protect™ executable, and all DSM environment variables are set, you can enter the dsmc command from any directory. Otherwise, enter the fully qualified path of the command.

**Mac OS X** Note: On Mac OS X, system administrators can use the sudo command to gain additional authority so the backup-archive client can access files for all users on the system.

**Mac OS X** **AIX** **Linux** **Solaris** On the command line enter dsmc followed by the command (*batch mode*). If the /usr/bin or opt/bin directory contains a symbolic link to the IBM Spectrum Protect installation directory, you can enter the dsmc command from any directory. Otherwise you can enter the fully qualified name.

**Windows** Note: If the PATH environment variable is set to the client installation directory, you can enter the `dsmc` command from any directory; otherwise, enter the fully qualified path.

One can start client with "`dsmc`" command only in case PATH environment variable is updates with path to the client location.

**Windows** You can open the Windows Start menu and select Programs > IBM Spectrum Protect > Backup-Archive Command Line.

Your IBM Spectrum Protect administrator can require you to use a password to connect to the server. The client prompts you for a password, if it is required. Contact your administrator if you do not know your password.

- Using batch mode  
Use *batch* mode to enter a single client command. When you use batch mode, you must precede the command with **dsmc**.
- Issuing a series of commands by using interactive mode  
Use *interactive* mode when you want to issue a series of commands.
- **Windows** Displaying Euro characters in a command-line prompt  
This topic explains how to display the Euro character in the Windows command-line prompt (console window).
- **Windows** Use options on the DSMC command  
This topic shows some examples of how to use options on the `dsmc` command.

#### Related concepts:

**Windows** Backup-archive client operations and security rights  
Options in interactive mode

**Windows** Start and end a client command session

**Mac OS X** UNIX and Linux client root and authorized user tasks  
Using commands

## Using batch mode

---

Use *batch* mode to enter a single client command. When you use batch mode, you must precede the command with **dsmc**.

### About this task

---

For example, to issue the incremental command, enter the following at the command prompt:

```
dsmc incremental
```

Some commands require one or more arguments. For example, to archive a file:

<b>AIX</b>	<b>Linux</b>	<b>Solaris</b>	<b>Mac OS X</b>
------------	--------------	----------------	-----------------

```
dsmc archive /home/proj1/file1.txt
```

**Windows**

```
dsmc archive c:\myfiles\file1.dat
```

Depending upon the current setting of your `passwordaccess` option, the client might prompt you for your password before the command is processed in a batch mode session.

When you enter your password, the password is not displayed on your screen.

#### Related reference:

`Passwordaccess`

## Issuing a series of commands by using interactive mode

---

Use *interactive* mode when you want to issue a series of commands.

### About this task

---

The connection to the server is established only once for interactive mode, so you can process a series of commands more quickly in interactive mode than in batch mode.

To start a client command session in interactive mode, enter either of the following commands:

- dsmc
- dsmc loop

The following prompt is displayed on your screen:

```
Protect>
```

**Windows** When you log on with an administrator ID, you can complete standard user tasks.. If you are not logged on before you begin a task from a command-prompt window, you are prompted to do so..

When you are in interactive mode, do not precede commands with dsmc. For example, instead of typing dsmc archive to archive a file, type only **archive**.

For example, to archive a file, enter the command with the file specification:

**AIX** | **Linux** | **Solaris** | **Mac OS X**

```
archive /home/proj1/file1.txt
```

**Windows**

```
archive c:\myfiles\file1.dat
```

Depending upon the current setting of the passwordaccess option, the client might prompt you for your password before you are allowed to enter a command in an interactive session.

When you enter your password, the password is not displayed on your screen.

**Windows**

## Displaying Euro characters in a command-line prompt

This topic explains how to display the Euro character in the Windows command-line prompt (console window).

### Procedure

1. Contact your Microsoft Representative for the 858 code page (the file name is `c_858.nls`). Copy the file into your Windows system32 directory (for example, `C:\WINNT\system32`).
2. Edit the Windows Registry key, using this command:  
`HKEY_LOCAL_MACHINE\SYSTEM\CurrentControlSet\Control\Nls\CodePage\850`, and set it to value `c_858.nls`.  
**Any changes that you make to the Windows Registry editor cannot be undone.** Errors made in editing the Windows Registry can cause your system to malfunction, and you might not even be able to restart your system. **Be very careful** when editing the Windows Registry. If you are unfamiliar with using the Windows Registry editor, then ask someone else who is familiar with the Windows Registry editor to help you.
3. In your Regional Settings, select a Western European country (Germany, France, Italy, etc.) as your locale setting.
4. Exit and reboot the system.

### Results

Ensure that the console window font that you use supports the Euro symbol (such as Lucida Console).

**Windows**

## Use options on the DSMC command

This topic shows some examples of how to use options on the dsmc command.

### About this task

For example, suppose you have one workstation with node name `galaxy1`, and another workstation with node name `galaxy2`, and you want to restore the data from `galaxy1` to the `galaxy2` system. To recover a file from one workstation (`galaxy1`) while at the other workstation (`galaxy2`), you must access `galaxy1`. Use the `set access` command to gain access.

For example, assume the file to be recovered on `galaxy1` is `c:\universe\saturn.planet`. The owner of `galaxy1` enters the following command:

```
dsmc set access archive c:\universe\saturn.planet galaxy2
```

When access is granted, you would retrieve the file by entering the following command:

```
dsmc retrieve -fromnode=galaxy1 \\galaxy1\universe\saturn.planet c:\
```

Note: Access to the files of another user can also be granted and gained using the GUI.

If you have more than one backup server in your organization, you can easily switch between them using a command-line option. To override the server specified in `dsm.opt`, you could use a command such as this:

```
dsmc -tcpserveraddress=myserver -node=mynode -tcpport=1599
```

**Related reference:**

Fromnode

Set Access

## Specifying input strings that contain blank spaces or quotation marks

---

You must follow certain rules when you specify an input string that has blanks or quotation marks.

Follow these rules when you specify an input string that has blank spaces or quotation marks:

- If the input string has one or more spaces, enclose the string with either single or double quotation marks. You can use single or double quotation marks, as long as they match.
- If the input string has a single quotation mark, enclose the string within double quotation marks, as in this example:  

```
-description="Annual backup of the accounting department's monthly reports"
```
- If the input string has a double quotation mark, enclose the string within single quotation marks, as in this example:  

```
-description='New translations of "The Odyssey" and "The Iliad"'
```
- If the input string has spaces and quotation marks, enclose the string in quotation marks. The outer quotation marks must not be the same as the quotation marks within the string.

Restriction: An input string that has single and double quotation marks is not a valid input string.

The following rules apply to these types of data:

- Fully qualified names
- The description that you specify in the archive command
- Any value for an option value where the character string can include spaces or quotation marks

Important: You cannot use escape characters in input strings. Escape characters are treated the same as any other characters. Here are some examples where escape characters are not recognized:

- If the character string is in an option file
- If the character string is in a list file
- If the character string is entered in interactive mode

Mac OS X

AIX

Linux

Solaris

## Starting: Additional considerations

---

You can include options as arguments to **dsmj** and **dsmc** commands. For example, you can use options to modify the format that displays dates, times, and numbers, or to include your password so that the backup-archive client does not prompt for it.

### About this task

---

In addition, if you have more than one server defined in `dsm.sys` and you want to contact a different server for backup-archive services (other than the one specified in your client user-options file `dsm.opt`), specify the server with the `servername` option.

For example:

```
dsmj -servername=server_b
```



**AIX** | **Linux** | **Solaris** | **Mac OS X** The Java™ GUI (dsmj) accepts command-line parameters, such as the Java -X options. Because of this, you can also now modify the Java Heap Size. For example:

**AIX** | **Linux** | **Solaris** | **Mac OS X**

```
dsmj -Xmx512M
```

## Using the web client in the new security environment

---

Beginning with IBM Spectrum Protect™ Version 8.1.2, you can no longer use the web client to connect to the IBM Spectrum Protect V8.1.2 or later server or the V7.1.8 or later V7 server.

However, you can still use the web client to connect to IBM Spectrum Protect V8.1.1, V8.1.0, or V7.1.7 or earlier servers.

If you are connected to the IBM Spectrum Protect V8.1.2 or later V8 server or the V7.1.8 or later V7 server, use the following alternatives to the web client:

- To restore data that was backed up with the backup-archive client, use the backup-archive client Java GUI (dsmj) or the command-line client (dsmc). For more information, see:
  - Backing up your data
  - Restoring your data
- **AIX** | **Solaris** | **Windows** To back up and restore NAS file servers using Network Data Management Protocol (NDMP), use the IBM Spectrum Protect server commands on the administrative command-line client (dsmadmc). For more information, see the following server documentation:
  - Protecting NAS file servers
  - Backing up and restoring NAS file servers using NDMP
  - File-level backup and restore for NDMP operations

Tip: If you already upgraded the backup-archive client to V8.1.2 or later, you can uninstall it and reinstall the V8.1.0 client to continue to use the web client. The IBM Spectrum Protect server administrator needs to set the SESSIONSECURITY parameter on the node back to TRANSITIONAL. For more information, see UPDATE NODE (Update node attributes).

- Starting a web client session  
The web client is a Java™ Web Start application that can be started and managed independent of web browser software. After you install and configure the web client on your workstation, you can use the web client for remote access to remotely back up, restore, archive, or retrieve data on the client node. The web client facilitates the use of assistive devices for users with disabilities and contains improved keyboard navigation.

**Mac OS X** | **AIX** | **Linux** | **Solaris** | **Windows**

## Start the client scheduler automatically

---

You can start the client scheduler automatically when you start your workstation.

If the IBM Spectrum Protect™ administrator has defined schedules for your node, starting the client scheduler permits you to automatically back up your workstation (or perform other scheduled actions).

You can also use the IBM Spectrum Protect Client Acceptor service to manage the scheduler.

**Windows** IBM Spectrum Protect supports remote network connections to the server. With a remote network connection, mobile users no longer need to dial-in to their company network when a backup is scheduled to run. IBM Spectrum Protect automatically establishes a connection before the scheduled backup occurs. If the connection fails, IBM Spectrum Protect reestablishes the connection before attempting the backup.

### Related tasks:

Setting the client scheduler process to run as a background task and start automatically at startup

## Changing your password

---

Your IBM Spectrum Protect™ administrator can require you to use a password to connect to the server.

### About this task

---

The backup-archive client prompts you for the password if one is required. Contact your IBM Spectrum Protect administrator if you do not know your password.

Important: The password discussed in this topic is different than the password used for encrypting files.

To change your password from the GUI:

## Procedure

1. **Mac OS X** On Mac OS X clients, start the backup-archive client with IBM Spectrum Protect Tools for Administrators.
2. **AIX** | **Linux** | **Solaris** | **Mac OS X** | **Windows** From the main window, open the **Utilities** menu and select **Change password**.
3. Enter your current and new passwords, and enter your new password again in the **Verify password** field.
4. Click **Change**.

## Results

To change your password from the command-line client, enter this command:

**AIX** | **Linux** | **Solaris** | **Mac OS X** | **Windows** For UNIX, Linux, and Windows clients:

```
dsmc set password
```

**Mac OS X** For Mac OS X clients, enter this command to change your password from the command-line client:

```
sudo dsmc set password
```

Then, enter your old and new passwords when prompted.

Passwords can be up to 63 character in length. Password constraints vary, depending on where the passwords are stored and managed, and depending on the version of the IBM Spectrum Protect server that your client connects to.

If your IBM Spectrum Protect server is at version 6.3.3 or later, and if you use an LDAP directory server to authenticate passwords Use any of the following characters to create a password:

```
a b c d e f g h i j k l m n o p q r s t u v w x y z
A B C D E F G H I J K L M N O P Q R S T U V W X Y Z
0 1 2 3 4 5 6 7 8 9 . ! @ # $ % ^ & * _ - + = ` ( )
| { } [ ] : ; < > , ? / ~
```

Passwords are case-sensitive and are subject to more restrictions that can be imposed by LDAP policies.

If your IBM Spectrum Protect server is at version 6.3.3 or later, and if you do not use an LDAP directory server to authenticate passwords

Use any of the following characters to create a password:

```
a b c d e f g h i j k l m n o p q r s t u v w x y z
A B C D E F G H I J K L M N O P Q R S T U V W X Y Z
0 1 2 3 4 5 6 7 8 9 . ! @ # $ % ^ & * _ - + = ` ( )
| { } [ ] : ; < > , ? / ~
```

Passwords are stored in the IBM Spectrum Protect server database and are not case-sensitive.

If your IBM Spectrum Protect server is earlier than version 6.3.3

Use any of the following characters to create a password:

```
a b c d e f g h i j k l m n o p q r s t u v w x y z
A B C D E F G H I J K L M N O P Q R S T U V W X Y Z
0 1 2 3 4 5 6 7 8 9
_ - & + .
```

Passwords are stored in the IBM Spectrum Protect server database and are not case-sensitive.

**AIX** | **Linux** | **Mac OS X** | **Solaris** | **Windows** Remember:

On the command line, enclose all parameters that contain one or more special characters in quotation marks. Without quotation marks, the special characters can be interpreted as shell escape characters, file redirection characters, or other characters that have significance to the operating system.

## Windows

On Windows systems:

Enclose the command parameters in quotation marks (").

Command line example:

```
dsmc set password "t67@#$%^&" "pass2<w0rd"
```

## AIX

## Linux

## Solaris

On AIX®, Linux, and Solaris systems:

Enclose the command parameters in single quotation marks (').

Command line example:

```
dsmc set password -type=vmquest 'Win 2012 SQL' 'tsml2dag\administrator' '7@#$%^&7'
```

Quotation marks are not required when you type a password with special characters in an options file.

### Related concepts:

Start the client scheduler automatically

### Related tasks:

#### Mac OS X

#### AIX

#### Linux

#### Solaris

Starting: Additional considerations

### Related reference:

Password

Set Password

## Sorting file lists using the backup-archive client GUI

You can use the backup-archive client GUI to display, sort, or select files.

### About this task

Table 1. Working with your files using the backup-archive client GUI

Task	Procedure
Displaying files	To display files in a directory, click the folder icon next to the directory name. The files appear in the File List box on the right.
Sorting the file list	<ul style="list-style-type: none"><li>Click the appropriate column heading in the File List box.</li></ul>
Display active and inactive backup versions	<ul style="list-style-type: none"><li>Click the Display Active/Inactive Files option from the View menu.</li><li>Click the Display both active and inactive files tool on the tool bar.</li></ul>
Display only active backup versions	Click the Display active files only option from the View menu.
Selecting files to restore or retrieve.	<ul style="list-style-type: none"><li>Click the selection box next to the directory or file name that you want to restore or retrieve.</li><li>Highlight the files that you want to restore or retrieve and click the Select Items tool on the tool bar.</li><li>Highlight the files that you want to restore or retrieve and click the Select Items option from the Edit menu.</li></ul>
Deselecting files	<ul style="list-style-type: none"><li>Click the checked selection box next to the directory or file name.</li><li>Highlight the files that you want to deselect and click the Deselect Items tool on the tool bar.</li><li>Highlight the files that you want to deselect and click the Deselect Items option from the Edit menu.</li></ul>
Displaying file information	<ul style="list-style-type: none"><li>Highlight the file name, and click the View File Details button on the tool bar.</li><li>Highlight the file name, and select File Details from the View menu.</li></ul>

Note:

1. Unless otherwise noted, the tasks and procedures in the above table apply to all client GUIs.

2. Using the client GUIs, you can sort a list of files by various attributes, such as name, directory, size, or modification date. Sorting files by the last backup date can be useful in determining what date and time to use for the point-in-time function.
3. An *active* file is the most recent backup version of a file that existed on your workstation when you ran your last backup. All other backup versions of that file are *inactive*. Only active backup versions of files are displayed, unless you select the Display active/inactive files menu option. If you delete the file from your workstation, the active version becomes inactive the next time you run an incremental backup.

On the command-line client, you can use query commands with the inactive option to display both active and inactive objects. You can use restore commands with the pick and inactive options to produce the list of active and inactive backups to choose from.

**Related reference:**

Inactive  
Pick

## Displaying online help

---

You can display online help in any of the following ways: On the backup-archive client GUI, from the web client, or from the dsmc command line.

### About this task

---

- On the backup-archive client GUI:
  - Open the help menu. Click Help or press F1.
  - Click the Help button in the current window.
  - **Mac OS X** On Mac systems, click the GUI question mark (?) icon, which displays online information about the current operation.
- From the dsmc command line: Enter the help command. The complete table of contents for the available help text is displayed.

**Related reference:**

Help

## Ending a session

---

You can end a client session from the backup-archive client GUI or from the dsmc command line.

### About this task

---

AIX	Linux	Solaris	Mac OS X
-----	-------	---------	----------

- From the backup-archive client GUI:
  - **Mac OS X** Open the File menu and select Quit.
  - **Mac OS X** Press Command+Q.
  - **AIX** **Linux** **Solaris** **Mac OS X** **Windows** Open the File menu and select Exit.
  - **Windows** Click the X icon in the upper right corner.
  - **AIX** **Linux** **Solaris** **Mac OS X** **Windows** Open the System menu and select Close.
  - **Windows** Press Alt+F4.
  - **AIX** **Linux** **Solaris** **Mac OS X** **Windows** For the web client: Open a different URL or close the browser.
- From the DSMC command line:
  - In batch mode, each dsmc command you enter is a complete session. The client ends the session when it finishes processing the command.
  - To end an interactive session, enter quit at the `Protect>` prompt.
  - To interrupt a dsmc command before the client has finished processing, enter QQ on the IBM Spectrum Protect™ console. In many cases but not all, this interrupts the command. If the command cannot be interrupted, use the UNIX kill -9 command from an available command prompt. Do not press Ctrl-C or use the UNIX kill -15 command because it can lead to unexpected results.

Windows
---------

- From the backup-archive client GUI main window:
  - Click File > Exit.

- Press `Alt-X`.
  - For the web client: Open a different URL or close the browser.
- From the DSMC command line:
  - In batch mode, each `dsmc` command you enter is a complete session. The client ends the session when it finishes processing the command.
  - To end an interactive session, enter `quit` at the `protect>` prompt.
  - To interrupt a `dsmc` command before the client has finished processing, enter `QQ` on the IBM Spectrum Protect console. In many cases but not all, this interrupts the command. If the command cannot be interrupted, use the Windows Task Manager to end the `dsmc` process. Do not press `Ctrl-C` because, while it ends the session, it can lead to unexpected results.

**Related reference:**

Loop

## Online forums

---

To participate in user discussions of IBM Spectrum Protect™ products, you can subscribe to the ADSM-L list server.

### About this task

---

This is a user forum maintained by Marist College. While not officially supported by IBM®, product developers and other IBM support staff also participate on an informal, best-effort basis. Because this is not an official IBM support channel, you should contact IBM Technical Support if you require a response specifically from IBM. Otherwise there is no guarantee that IBM will respond to your question on the list server.

You can subscribe by sending a note to the following e-mail address:

`listserv@vm.marist.edu`

The body of the message must contain the following:

`SUBSCRIBE ADSM-L yourfirstname yourlastname`

The list server will send you a response asking you to confirm the subscription request. Once you confirm your subscription request, the list server will send you further instructions. You will then be able to post messages to the list server by sending e-mail to:

`ADSM-L@vm.marist.edu`

If at a later time you want to unsubscribe from ADSM-L, you can send a note to the following e-mail address:

`listserv@vm.marist.edu`

The body of the message must contain the following:

`SIGNOFF ADSM-L`

You can also read and search the ADSM-L archives, join discussion forums, and access other resources at the following URL:

<http://www.adsm.org>

## Back up and restore data with backup-archive clients

---

If you want to save a copy of a file from your computer to the IBM Spectrum Protect™ server, use the *backup* function. If the original file is ever damaged or lost, you can *restore* the backup version from the server.

- **Backing up your data**  
Use the backup-archive client to store backup versions of your files on the IBM Spectrum Protect server. You can restore these backup versions if the original files are lost or damaged.
- **Restoring your data**  
Use IBM Spectrum Protect to restore backup versions of specific files, a group of files with similar names, or entire directories.

## Backing up your data

---

Use the backup-archive client to store backup versions of your files on the IBM Spectrum Protect™ server. You can restore these backup versions if the original files are lost or damaged.

**AIX** **Linux** **Mac OS X** **Solaris** All client backup and restore procedures also apply to the web client.

Restriction: The web client does not provide a Preferences Editor for setting client options.

**Windows** All client backup and restore procedures also apply to the web client.

Restriction: The web client does not provide a Preferences Editor for setting client options. The web client does not offer a Setup wizard, which is available in the backup-archive client GUI on Windows clients. The web client cannot browse network resources.

**Windows** Unless otherwise specified, references to Windows refer to all supported Windows operating systems.

**Windows** The client provides backup and archive services for all files on the following file systems: File Allocation Table (FAT), FAT 32, NTFS, and ReFS.

The following is a list of primary backup tasks.

- **Windows** Planning your backups (Windows)
- **Mac OS X** **AIX** **Linux** **Solaris** Planning your backups
- **Windows** Pre-backup considerations (Windows)
- **Mac OS X** **AIX** **Linux** **Solaris** Pre-backup considerations (UNIX and Linux)
- **Windows** Incremental, selective, or incremental-by-date backups (Windows)
- **Mac OS X** **AIX** **Linux** **Solaris** Performing an incremental, selective, or incremental-by-date backup (UNIX and Linux)
- **Windows** Deleting backup data
- **Mac OS X** **AIX** **Linux** **Solaris** Deleting backup data
- **Windows** Backing up files from one or more file spaces for a group backup (Windows)
- **Mac OS X** **AIX** **Linux** **Solaris** Backing up files from one or more file spaces for a group backup (UNIX and Linux)
- **Windows** Backing up Windows system state
- **Windows** Backing up Automated System Recovery files
- **AIX** **Linux** **Solaris** **Windows** Image backup
- Back up NAS file systems using Network Data Management Protocol
- **Windows** Preparing the environment for full backups of VMware virtual machines
- **Windows** Back up virtual machines on a Hyper-V system
- **Windows** Backing up Net Appliance CIFS share definitions
  
- **Windows** Planning your backups (Windows)  
If you are a first-time user, or if you only back up files occasionally, you can use the table in this topic as a checklist of preliminary steps to consider before performing a backup.
- **Mac OS X** **AIX** **Linux** **Solaris** Planning your backups  
If you are a first-time user, or if you only back up files occasionally, you can use the table in this topic as a checklist of preliminary steps to consider before backing up data.
- Which files are backed up  
When you request a backup, the client backs up a file if certain requirements are met.
- **Windows** Open file support for backup operations  
The VSS snapshot provider is used for open file support.
- **Windows** Backing up data using the GUI  
You can use the backup-archive client GUI to back up specific files, a group of files with similar names, or entire directories.
- **Windows** Backing up data using the command line  
You can use the incremental or selective commands to perform backups. The following table shows examples of using commands to perform different tasks.
- **Windows** Deleting backup data  
If your administrator has given you authority, you can delete individual backup copies from the IBM Spectrum Protect server without deleting the entire file space.
- When to back up and when to archive files  
When the backup-archive client backs up or archives a file, it sends a copy of the file and its associated attributes to the server; however, backup and archive operations have different results.
- **Windows** Pre-backup considerations (Windows)  
Various factors in your system or environment can affect the way the backup-archive client processes data. Review these considerations before you back up your data.
- **Mac OS X** **AIX** **Linux** **Solaris** Pre-backup considerations (UNIX and Linux)  
Various factors in your system or environment can affect the way the backup-archive client processes data. Review these considerations before you back up your data.

- Windows** Incremental, selective, or incremental-by-date backups (Windows)  
Your administrator might set up schedules to automatically back up files. This section contains information about how to back up files without a schedule.
- AIX** **Linux** **Mac OS X** **Solaris** Performing an incremental, selective, or incremental-by-date backup (UNIX and Linux)  
Your administrator might have set up schedules to automatically back up files on your workstation. The following sections discuss how to back up files without using a schedule.
- Windows** Backing up files from one or more file spaces for a group backup (Windows)  
Use the backup group command to create and back up a group from a list of files from one or more file space origins to a virtual file space on the IBM Spectrum Protect server.
- Mac OS X** **AIX** **Linux** **Solaris** Backing up files from one or more file spaces for a group backup (UNIX and Linux)  
You can use the backup group command to create and back up a group containing a list of files from one or more file space origins to a virtual file space on the IBM Spectrum Protect server.
- Windows** Backing up data with client-node proxy support (Windows)  
Backups of multiple nodes that share storage can be consolidated to a common target node name on the IBM Spectrum Protect server.
- Mac OS X** **AIX** **Linux** **Solaris** Backing up data with client-node proxy support (UNIX and Linux)  
Backups of multiple nodes that share storage can be consolidated to a common target node name on the IBM Spectrum Protect server.
- Windows** Associate a local snapshot with a server file space (Windows)  
Use the snapshotroot option with the incremental and selective commands in conjunction with a vendor-supplied application that provides a snapshot of a logical volume, to associate the data on the local snapshot with the real file space data that is stored on the IBM Spectrum Protect server.
- Mac OS X** **AIX** **Linux** **Solaris** Associate a local snapshot with a server file space (UNIX and Linux)  
Use the snapshotroot option with the incremental and selective commands in conjunction with an independent software vendor application that provides a snapshot of a logical volume, to associate the data on the local snapshot with the real file space data that is stored on the IBM Spectrum Protect server.
- Windows** Backing up Windows system state  
The backup-archive client uses VSS to back up all system state components as a single object, to provide a consistent point-in-time snapshot of the system state. System state consists of all bootable system state and system services components.
- Windows** Backing up Automated System Recovery files  
You can back up Automated System Recovery (ASR) files in preparation for recovering the Windows disk configuration information and system state in case a catastrophic system or hardware failure occurs.
- Windows** Preparation for Automated System Recovery  
Specific backups and media are required for Windows Automated System Recovery (ASR).
- AIX** **Linux** **Solaris** **Windows** Image backup  
From your local workstation, you can back up a logical volume as a single object (image backup) on your system.
- AIX** Snapshot-based file backup and archive and snapshot-based image backup  
For backup-archive clients running on AIX 5.3 or later JFS2 file systems as root user, snapshot-based image backup is created using snapshots by default.
- Linux** Protecting Btrfs file systems  
Btrfs file systems can be included as file specifications for backup and restore commands, archive and retrieve commands, and on backup image and restore image commands. You can also specify Btrfs subvolumes as file specification to the backup and restore, and archive and retrieve functions. You cannot use the backup-archive client image backup or image restore commands on a Btrfs subvolume.
- AIX** **Solaris** **Windows** Back up NAS file systems using Network Data Management Protocol  
Windows, AIX, and Solaris backup-archive clients can use Network Data Management Protocol (NDMP) to efficiently back up and restore network attached storage (NAS) file system images. The file system images can be backed up to, or be restored from, automated tape drives or libraries that are locally attached to Network Appliance or EMC Celerra NAS file servers, or to or from tape drives or libraries that are locally attached to the IBM Spectrum Protect server.
- Windows** Support for CDP Persistent Storage Manager  
Persistent Storage Manager (PSM) is the snapshot technology that is included with a number of Microsoft Server Appliance Kit-based NAS boxes that include the IBM® TotalStorage NAS 200, 300, and 300G.
- Mac OS X** **AIX** **Linux** **Solaris** Backup network file systems  
You can configure the backup-archive client to protect files that are accessed with either Network File System (NFS) or Common Internet File System (CIFS) protocols.
- AIX** Back up AIX workload partition file systems  
Using the backup-archive client on AIX, you can back up and restore local partition file data within the global partition by using the local partition name space available within the global partition.
- Solaris** Backing up Solaris Zettabyte file systems  
On Solaris SPARC and Solaris x86 systems, you can backup Zettabyte file systems (ZFS), by using ZFS snapshots. The



advantage of this approach, over an ordinary incremental or selective backup, is that the files and folders in a snapshot are always in a read-only state, so they cannot be changed during a backup.

- **AIX** AIX JFS2 encrypted file system backup  
Use AIX JFS2 Encrypted File System (EFS) to back up files either in clear text or raw format. With clear text format, the file is decrypted by EFS as it is read. With raw format, the data is not decrypted. The default is raw format, but when you set the efsdecrypt option to yes, you get clear text backups.
- **AIX** Back up AIX JFS2 extended attributes  
AIX Enhanced Journal File System (JFS2) provides backup processing for named extended attributes for all file systems that support named extended attributes.
- **Linux** | **Windows** Backing up VMware virtual machines  
You can use the backup-archive client to back up and restore a VMware virtual machine (VM). Full backups of the virtual machine operate at a disk image level. Incremental backups copy only the data that is changed since the previous full backup.
- **Windows** Back up virtual machines on a Hyper-V system  
You can use the backup-archive client to backup virtual machines that are managed by a Microsoft Hyper-V server.
- **Linux** | **Windows** Back up and archive Tivoli Storage Manager FastBack data  
Use Tivoli® Storage Manager FastBack to back up and archive the latest snapshots for short-term retention.
- **Windows** Backing up Net Appliance CIFS share definitions  
Network Appliance (NetApp) CIFS share definitions include share permissions that are set on the file server.
- Display backup processing status  
During a backup, by default the backup-archive client displays the status of each file it attempts to back up.
- **Windows** Backup (Windows): Additional considerations  
This section discusses additional information to consider when backing up data.
- **Mac OS X** | **AIX** | **Linux** | **Solaris** Backup (UNIX and Linux): Additional considerations  
There are some special situations that you need to consider before you back up your data.

**Windows**

## Planning your backups (Windows)

If you are a first-time user, or if you only back up files occasionally, you can use the table in this topic as a checklist of preliminary steps to consider before performing a backup.

Read the tasks listed in this table to determine whether you are ready to back up your data.

Table 1. Planning your backups

<input type="checkbox"/>	Decide whether you want to back up or archive files. See When to back up and when to archive files for more information.
<input type="checkbox"/>	See Pre-backup considerations (Windows) for important migration information, and how you might increase performance before backing up files and directories.
<input type="checkbox"/>	Create an include-exclude list to specify files and directories you want to exclude from backup services. See Control processing with an include-exclude list for more information.
<input type="checkbox"/>	Decide what type of backup you want according to your needs. See the following sections for more information: <ul style="list-style-type: none"> <li>• Incremental, selective, or incremental-by-date backups (Windows)</li> <li>• Backing up files from one or more file spaces for a group backup (Windows)</li> <li>• Backing up Windows system state</li> <li>• Backing up Automated System Recovery files</li> <li>• Image backup</li> <li>• Back up NAS file systems using Network Data Management Protocol</li> <li>• Parallel backups of virtual machines</li> </ul>
<input type="checkbox"/>	For additional backup considerations, see Backup (Windows): Additional considerations.

### Related concepts:

Installing the IBM Spectrum Protect backup-archive clients (UNIX, Linux, and Windows)

### Related tasks:

Configuring backup-archive clients

**Mac OS X** | **AIX** | **Linux** | **Solaris**



## Planning your backups

---

If you are a first-time user, or if you only back up files occasionally, you can use the table in this topic as a checklist of preliminary steps to consider before backing up data.

Read the list of tasks to determine whether you are ready to back up your data.

- Decide whether you want to back up files or archive them. See [When to back up and when to archive files](#) for more information.
- See [Pre-backup considerations \(UNIX and Linux\)](#) for important considerations before you back up your files and directories.
- Do you need to exclude files from backup services? See [Include-exclude options to control processing](#) for more information.

### Related concepts:

[Installing the IBM Spectrum Protect backup-archive clients \(UNIX, Linux, and Windows\)](#)

### Related tasks:

[Configuring backup-archive clients](#)

## Which files are backed up

---

When you request a backup, the client backs up a file if certain requirements are met.

To back up a file, the client must meet the following are the requirements:

- The selected management class contains a backup copy group.
- The file meets the serialization requirements that are defined in the backup copy group. If the copy group serialization parameter is static or shrstatic, and the file changes during backup, the file is not backed up.
- The file meets the mode requirements that are defined in the backup copy group. If the copy group mode parameter is modified, the file must have changed since the last backup. If the mode is absolute, the file can be backed up even if it does not change.
- The file meets the frequency requirements that are defined in the backup copy group. The specified minimum number of days since the last backup must elapse before a file is backed up.
- The file is not excluded from backup by an exclude statement.
- The file is not excluded from backup by the operating system. These excluded files can be found in registry subkey `HKEY_LOCAL_MACHINE\SYSTEM\CurrentControlSet\Control\BackupRestore\FilesNotToBackup`.

Files that are part of the Windows system state are eligible for backup only when the system state is backed up. You can back up the system state only as a single entity because of dependencies among the system state components. You cannot back up or restore the files individually. For example, because `C:\windows\system32\ntoskrnl.exe` is part of the Windows system state, it is not backed up during an incremental or selective backup of the `C:\` drive.

Windows

## Open file support for backup operations

---

The VSS snapshot provider is used for open file support.

VSS is the snapshot provider for Windows.

Some applications can create files and open these files in a way that denies access to all other processes on a Microsoft Windows operating system. Although this is not a common practice, it is sometimes used by database vendors or other applications that might want to limit access to certain files. By restricting access to these files, backup products are prevented from backing up the data. These locked files are not the same as files that are open, or in use. The backup-archive client, running without the open file support (OFS) feature, can back up open, or in use files, including files that are open for reading or writing, files that are changing during the backup, executable and dll files that are running, log files that are being appended to, and so on.

You can create OFS or online image backups on workstations with a single NTFS-based, or ReFS-based, `C:\` drive.

The following is the error message that is seen in the `dsmerror.log` when the client encounters one of these locked files without OFS support enabled:

```
ANS4987E Error processing '\\machine1\d$\dir1\lockedfile.xyz': the object is in use by another process
```

```
ANSI228E Sending of object '\\machine1\d$\dir1\lockedfile.xyz' failed
```

Do not use OFS for backing up locked Windows system files, such as the Windows system state. The client has advanced features for backing up data that is contained within these files. The backup of the system data that is contained in these files requires extra processing and must be backed up in a group to allow for a successful restore. These files are excluded from IBM Spectrum Protect™ file level backup.

For database applications that use certain files for transactional consistency (for example, a recovery log file), it might not be possible to back up and restore these files without database coordination. In these situations, do not back up these database files with the normal file level backup. You can exclude these files from backup processing by using an exclude or exclude.dir statement. A number of data protection clients (IBM Spectrum Protect for Databases, IBM Spectrum Protect for Mail, and so on) are available to provide this database coordination and backup along with other advanced database backup features. For a current list of data protection clients go to this website: <http://www.ibm.com/systems/storage/spectrum/protect/>.

For private applications or other database products where a Data Protection client is not available, you can use the preschedulecmd option to signal the database or application to do one of the following actions:

- Take the steps necessary to move these files to a consistent and unopen state.
- Bring down the database before the file level backup is started.
- Program or script another method to back up this data and exclude these files from the file level backup. In these cases the OFS feature is not necessary since these files are no longer unavailable or locked by the application. After the file level backup completes, use the postschedulecmd option to bring the database back online or restart the application.

If the time it takes to complete the file level backup is too long to have the open files offline (for example, having the database offline or holding up transactions), use the OFS feature to create a point-in-time snapshot of the volume. In this case, use the presnapshotcmd and postsnapshotcmd options to signal the database or application to coordinate with the backup of these open files. The snapshot, which occurs between the pre-snapshot command and post-snapshot command, generally takes only a few seconds to create. This allows the database or application to resume operations quickly while still allowing the client to perform a full incremental backup of the volume, including the locked files. There are other situations where these application-locked files can be safely backed up and restored on a file-by-file basis. In these situations, you can enable the OFS feature for that volume where the open files exist. The client then has access to these files and back them up using file level backup and archive operations.

For information about Open File Support restrictions and issues, see technote 1248971.

If open file support has been configured, the client performs a snapshot backup or archive of files that are locked (or "in use") by other applications. The snapshot allows the backup to be taken from a point-in-time copy that matches the file system at the time the snapshot is taken. Subsequent changes to the file system are not included in the backup. You can set the snapshotproviderfs parameter of the include.fs option to none to specify which drives do not use open file support.

To control an open file support operation, you can specify these additional options in your dsm.opt file or as values of the include.fs option: snapshotproviderfs, and presnapshotcmd and postsnapshotcmd.

Note:

1. You can use the include.fs option to set snapshot options on a per file system basis.
2. Open file support is provided for both backup and archive. For backup, this includes incremental, incremental by date, selective, incremental image, and journal-based backup.
3. Open file support is only available for local fixed volumes (mounted to either drive letters or volume mount points) formatted with FAT, FAT32, NTFS, or ReFS file systems. This support includes SAN-attached volumes that meet these requirements.
4. To enable OFS support in a cluster environment, all workstations in the cluster must have OFS configured. Set VSS as the snapshot provider on the snapshotproviderfs option.

**Related concepts:**

Processing options

**Related tasks:**

Backing up Windows system state

Configuring Open File Support

Windows

## Backing up data using the GUI

---

You can use the backup-archive client GUI to back up specific files, a group of files with similar names, or entire directories.

## About this task

---

You can locate the files that you want to back up by searching or filtering. Filtering displays only the files that match the filter criteria for your backup. Files that do not match the filter criteria do not display.

To perform a GUI backup, use the following steps:

## Procedure

---

1. Click Backup from the GUI main window. The Backup window appears.
2. Expand the directory tree by clicking the plus sign +. To display files in a folder, click the Folder icon. To search or filter files, click the Search icon from the toolbar.
3. Click the selection box for the objects that you want to back up.
4. Select the type of backup from the pull-down menu:
  - a. To run an incremental backup, select Incremental (complete).
  - b. To run an incremental backup by date, select Incremental (date only).
  - c. To run a selective backup, select Always backup.
  - d. To run an incremental backup without using the journal database, select Incremental (without journal). If you installed the journal engine service and it is running, then by default the Incremental command automatically performs a journal-based backup on selected file systems that are being monitored by the journal engine service. This option performs a traditional full incremental backup, instead of the default journal-based backup.
5. Click Backup. The Backup Task List window displays the backup processing status. When processing completes, the Backup Report window displays processing details.

## Results

---

The following are some items to consider when you use the GUI to back up your data.

- IBM Spectrum Protect™ uses management classes to determine how to manage your backups on the server. Every time you back up a file, the file is assigned a management class. The management class that is used is either a default that is selected for you, or one that you assign to the file using an include option in the include-exclude options list. Select Utilities → View Policy Information from the backup-archive client or web client GUI to view the backup policies that are defined by the IBM Spectrum Protect server for your client node. Select Edit → Client Preferences from the backup-archive client or web client GUI and select the Include-Exclude tab in the Preferences editor to display your include-exclude list.
- To modify specific backup options, click the Options button. Any options that you change are effective during the current session only.
- To perform subsequent incremental backups, from the IBM Spectrum Protect main window, open the Actions menu and select Backup Domain.
- The web client GUI cannot browse network resources to perform a backup. No shares are listed if you expand the Network branch. It is possible to backup a network resource from the web client as long as the entire file is processed. To do this, the filesystem is specified using the domain option in `dsm.opt`. E.g. `domain all-local \\server\share`. To complete the backup, select Backup Domain from the Action menu. This processes all the filesystems that are specified with the domain option. Alternatively, you can use the GUI Client to perform the backup.
- **Windows** Specifying drives in your domain  
When you start the client, it sets your default domain to the drives you specify with the domain option in the `dsm.opt` file.

### Related concepts:

Storage management policies

### Related tasks:

Restoring data by using the GUI

Setting the client scheduler process to run as a background task and start automatically at startup

**Windows**

## Backing up data using the command line

---

You can use the incremental or selective commands to perform backups. The following table shows examples of using commands to perform different tasks.

## About this task

---

Table 1. Command line backup examples

Task	Command	Considerations
<i>Incremental backups</i>		
Perform an incremental backup of your client domain.	<code>dsmc incremental</code>	See Incremental for more information about the incremental command. See Full and partial incremental backup for detailed information about incremental backups.
Back up the <code>g:</code> and <code>h:</code> drives in addition to the <code>c:</code> , <code>d:</code> , and <code>e:</code> drives defined in your client domain.	<code>dsmc incremental -domain="g: h:"</code>	See Domain for more information about the domain option.
Back up all local volumes defined in your client domain <i>except</i> for the <code>c:</code> drive and systemobject domain.	<code>dsmc incremental -domain="all-local - c: -systemobject"</code>	You cannot use the (-) operator in front of the domain keyword all-local. See Domain for more information. For Windows clients you can also exclude the systemstate domain from backup processing in this way.
Back up all local volumes defined in your client domain <i>except</i> for the <code>c:</code> drive and systemstate domain.	<code>dsmc incremental -domain="all-local - c: -systemstate"</code>	You cannot use the (-) operator in front of the domain keyword all-local. See Domain for more information.
Back up <i>only</i> the <code>g:</code> and <code>h:</code> drives.	<code>dsmc incremental g: h:</code>	None
Back up all files in the <code>c:\Accounting</code> directory and all its subdirectories.	<code>dsmc incremental c:\Accounting\* - sub=yes</code>	See Subdir for more information about the subdir option.
Assuming that you initiated a snapshot of the <code>C:</code> drive and mounted the snapshot as the logical volume <code>\\florence\c\$\snapshots\snapshot.0</code> , run an incremental backup of all files and directories under the local snapshot and manage them on the IBM Spectrum Protect™ server under the file space name <code>C:</code> .	<code>dsmc incremental c: -snapshot= \\florence\c\$\snapshots\ snapshot.0</code>	See Snapshotroot for more information.
<i>Incremental-by-date backup</i>		
Perform an incremental-by-date backup of your default client domain.	<code>dsmc incremental -incrbydate</code>	Use the incrbydate option with the incremental command to back up new and changed files with a modification date later than the last incremental backup stored at the server. See Incrbydate for more information about the incrbydate option.
<i>Selective backups</i>		

Task	Command	Considerations
Back up all files in the d:\proj directory.	<code>dsmc selective d:\proj\</code>	Use the selective command to back up specific files, a group of files with similar names, or empty directories and their attributes regardless of whether those files or directories were backed up during your last incremental backup and without affecting the last incremental backup count from the backup server. You can use wildcards to back up multiple files at once. See Selective for more information about the selective command.
Back up the d:\proj directory and all its subdirectories.	<code>dsmc selective d:\proj\ -subdir=yes</code>	See Subdir for more information about the subdir option.
Back up the d:\h1.doc and d:\test.doc files.	<code>dsmc selective d:\h1.doc d:\test.doc</code>	You can specify as many file specifications as available resources or other operating system limits permit. Separate file specifications with a space. You can also use the filelist option to process a list of files. The backup-archive client opens the file you specify with this option and processes the list of files within according to the specific command. See Filelist for more information.
Back up a list of files in the c: drive.	<code>dsmc selective - filelist=c:\filelist.txt</code>	Use the filelist option to process a list of files. See Filelist for more information.
Assuming that you initiated a snapshot of the C: drive and mounted the snapshot as the logical volume \\florence\c\$\snapshots\snapshot.0, run a selective backup of the c:\dir1\sub1 directory tree from the local snapshot and manage it on the IBM Spectrum Protect server under the file space name C:.	<code>dsmc selective c:\dir1\sub1\* - subdir=yes snapshot=\\florence\c\$\snapshots\ snapshot.0</code>	See Snapshotroot for more information.

**Related concepts:**

Backup (Windows): Additional considerations

Using commands

 Windows

## Deleting backup data

If your administrator has given you authority, you can delete individual backup copies from the IBM Spectrum Protect™ server without deleting the entire file space.

### About this task

For example, you might need to delete sensitive data that was backed up (intentionally or unintentionally), and now needs to be removed from the server. Or you might need to delete files that were backed up, but were later found to contain viruses. To determine if you have the authority to delete individual backup copies from the IBM Spectrum Protect server without deleting the entire file space, select **File** → **Connection Information** from the backup-archive client GUI or web client main menu. Your authority status is provided in the Delete Backup Files field.

**Important:** When you delete backup files, *you cannot restore them*. Verify that the backup files are no longer needed before you delete them. IBM Spectrum Protect prompts whether you want to continue with the delete. If you specify yes, the specified backup files are immediately deleted and removed from IBM Spectrum Protect server storage.

To delete backup copies using the IBM Spectrum Protect GUI or web client:

## Procedure

---

1. Select **Delete Backup Data** from the **Utilities** menu. The Backup Delete window appears.
2. Expand the Directory tree by clicking the plus sign (+) or folder icon next to the object you want to expand.
3. Select an item from the drop-down list near the top of the **Backup Delete** window to specify the type of backup delete to perform. You can delete active backup versions, inactive backup versions, or all objects that you have selected in the tree. A directory is deleted only if you select **Delete All Objects**.

## Results

---

To delete backup copies using the IBM Spectrum Protect command line client, use the delete backup command.

### Related reference:

Delete Backup

## When to back up and when to archive files

---

When the backup-archive client backs up or archives a file, it sends a copy of the file and its associated attributes to the server; however, backup and archive operations have different results.

Use backups to protect against unforeseen damage to your files, and use archives for maintaining more permanent versions of your files.

Backup data is managed by version by using predetermined policy-based rules. Using these rules, the IBM Spectrum Protect™ administrator can control the following processes:

- The number of versions that are maintained on the IBM Spectrum Protect server
- The number of days each additional backup copy is kept
- What happens to backup versions when the file is deleted on the client system

Each copy of the file that is stored on the server is considered to be a separate and unique version of the file.

Archive is a powerful and flexible mechanism for storing long-term data. Archive data, called archive copies, are kept for a specified number of days. The archive function has no concept or support for versions. The user or administrator is responsible for determining what files get added to an archive.

Tip: If a file is archived multiple times by using the same archive description, a new copy of the file is added to the archive each time that archive is operation run. To simplify the retrieve operation, store only one copy of a file in each archive.

Backups protect against file damage or loss that can occur through accidental deletion, corruption, or disk crashes. The server maintains one or more backup versions for each file that you back up. Older versions are deleted as newer versions are made. The number of backup versions the server maintains is set by your administrator.

**AIX** | **Linux** | **Solaris** | **Mac OS X** | **Windows** Archive copies are saved for long-term storage. Your administrator can limit how long archive copies are kept. The server can store an unlimited number of archive versions of a file. Archives are useful if you must go back to a particular version of your files, or you want to delete a file from your workstation and retrieve it later, if necessary. For example, you might want to save spreadsheets for tax purposes, but because you are not using them, you do not want to leave them on your workstation.

### Related concepts:

**Mac OS X** | **AIX** | **Linux** | **Solaris** Archive and retrieve your data (UNIX and Linux)

Restore data from a backup set

**Windows**

## Pre-backup considerations (Windows)

---

Various factors in your system or environment can affect the way the backup-archive client processes data. Review these considerations before you back up your data.

- **Windows** LAN-free data movement  
LAN-free data movement shifts the movement of client data from the communications network to a storage area network

(SAN). This decreases the load on the IBM Spectrum Protect server.

- **Windows** Unicode file spaces (Windows)

The Windows client is Unicode-enabled. However, client versions before Version 4.2 were not enabled for Unicode.

- **Windows** Incremental backups on memory-constrained systems

Incremental backup performance suffers if the system has a low amount of memory available before starting the backup.

- **Windows** Incremental backups on systems with a large number of files

The client can use large amounts of memory to run incremental backup operations, especially on file systems that contain large numbers of files.

- **Windows** Control processing with an include-exclude list

There might be files on your system that you do not want to back up. These files might be operating system or application files that you can easily recover by reinstalling the program, or any other file that you can easily rebuild.

- **Windows** Data encryption during backup or archive operations

For the strongest possible encryption, use 256-bit Advanced Encryption Standard (AES) data encryption, with the encryptiontype option. AES 128-bit encryption is currently the default.

- **Windows** Maximum file size for operations

The maximum file sizes for backup and restore, and archive and retrieve operations depends on the Windows file system that is used.

- **Windows** How the client handles long user and group names

The backup-archive client can handle user and group names that are up to 64 characters without any issues. However, names longer than 64 characters require special handling.

AIX | Linux | Solaris | Windows

## LAN-free data movement

LAN-free data movement shifts the movement of client data from the communications network to a storage area network (SAN). This decreases the load on the IBM Spectrum Protect™ server.

The SAN provides a path that allows you to back up, restore, archive, and retrieve data to and from a SAN-attached storage device. Client data moves over the SAN to the storage device using the IBM Spectrum Protect Storage Agent. The Storage Agent must be installed on the same system as the client.

AIX | Linux | Solaris | AIX®, Linux, and Solaris clients support LAN-free data movement.

**Windows** All Windows clients support LAN-free data movement.

- **Windows** LAN-free prerequisites

To enable LAN-free support, you must install and configure the IBM Spectrum Protect for SAN storage agent on the client workstation.

- **Windows** LAN-free data movement options

To enable LAN-free data movement, you can use several client options. You must first install and configure the IBM Spectrum Protect for SAN storage agent on the client workstation.

AIX | Linux | Solaris | Windows

## LAN-free prerequisites

To enable LAN-free support, you must install and configure the IBM Spectrum Protect™ for SAN storage agent on the client workstation.

IBM Spectrum Protect for SAN is a separate product.

For more information about installing and configuring the storage agent, see the documentation for IBM Spectrum Protect for SAN.

AIX | Linux | Solaris | Windows

## LAN-free data movement options

To enable LAN-free data movement, you can use several client options. You must first install and configure the IBM Spectrum Protect™ for SAN storage agent on the client workstation.

Use the following options to enable LAN-free data movement:

*enablelanfree*

Specifies whether to enable an available LAN-free path to a SAN-attached storage device.

*lanfreecommmethod*

Specifies a communication protocol between the client and the Storage Agent.

*lanfreeshmport*

Specifies the unique number that is used by the client and the storage agent to identify shared memory area used for communications.

*lanfreetcport*

Specifies the TCP/IP port number where the Storage Agent is listening.

*lanfreetcpserveraddress*

Specifies the TCP/IP address for the storage agent.

**Related reference:**

Enablelanfree

Lanfreecommmethod

Lanfreeshmport

Lanfreessl

Lanfreetcport

Lanfreetcpserveraddress

Windows

## Unicode file spaces (Windows)

---

The Windows client is Unicode-enabled. However, client versions before Version 4.2 were not enabled for Unicode.

If you are backing up a system that had at one time used a client version older than Version 4.2, and the file spaces have not yet been migrated to Unicode, then you need to plan for the migration of file spaces to Unicode. This involves renaming your file spaces on the server and creating new Unicode-enabled file spaces on the server using the `autofsrename` option.

**Related concepts:**

Considerations for Unicode-enabled clients

**Related reference:**

Autofsrename

Detail

Query Filespace

Restore

Retrieve

Mac OS X | AIX | Linux | Solaris | Windows

## Incremental backups on memory-constrained systems

---

Incremental backup performance suffers if the system has a low amount of memory available before starting the backup.

If your system is memory constrained, specify the `memoryefficientbackup yes` option in your client options file. This option causes the backup-archive client to process only one directory at a time, which reduces memory consumption but increases backup time. When you specify `yes`, the client analyzes only one directory at a time for backup consideration. If performance remains poor, check your communication buffer settings and the communication link between your system and the IBM Spectrum Protect™ server. If your system is not memory constrained, setting the `memoryefficientbackup` option to `yes` degrades your backup performance.

**Related reference:**

Memoryefficientbackup

## Incremental backups on systems with a large number of files

---

The client can use large amounts of memory to run incremental backup operations, especially on file systems that contain large numbers of files.

The term *memory* as used here is the addressable memory available to the client process. Addressable memory is a combination of physical RAM and virtual memory.



On average, the client uses approximately 300 bytes of memory per object (file or directory). Thus for a file system with one million files and directories, the client requires, on average, approximately 300 MB of memory. The exact amount of memory that is used per object varies, depending on the length of the object path and name length, or the nesting depth of directories. The number of bytes of data is not an important factor in determining the backup-archive client memory requirement.

The maximum number of files can be determined by dividing the maximum amount of memory available to a process by the average amount of memory that is needed per object.

The total memory requirement can be reduced by any of the following methods:

- Use the client option `memoryefficientbackup diskcachemethod`. This choice reduces the use of memory to a minimum at the expense of performance and a significant increase in disk space that is required for the backup. The file description data from the server is stored in a disk-resident temporary database, not in memory. As directories on the workstation are scanned, the database is consulted to determine whether to back up, update, or expire each object. At the completion of the backup, the database file is deleted.
- Use the client option `memoryefficientbackup yes`. The average memory that is used by the client then becomes 300 bytes times the number of directories plus 300 bytes per file in the directory that is being processed. For file systems with large numbers (millions) of directories, the client still might not be able to allocate enough memory to perform incremental backup with `memoryefficientbackup yes`.
- **AIX** | **Linux** | **Solaris** UNIX and Linux clients might be able to use the `virtualmountpoint` client option to define multiple virtual mount points within a single file system, each of which can be backed up independently by the client.
- If the client option `resourceutilization` is set to a value greater than 4, and multiple file systems are being backed up, then reducing `resourceutilization` to 4 or lower limits the process to incremental backup of a single file system at a time. This setting reduces the memory requirement. If the backup of multiple file systems in parallel is required for performance reasons, and the combined memory requirements exceed the process limits, then multiple instances of the backup client can be used to back up multiple file systems in parallel. For example, if you want to back up two file systems at the same time but their memory requirements exceed the limits of a single process, then start one instance of the client to back up one of the file systems, and start a second instance of the client to back up the other file system.
- Use the `-incrbydate` client option to perform an "incremental-by-date" backup.
- Use the `exclude.dirclient` option to prevent the client from traversing and backing up directories that do not need to be backed up.
- **AIX** | **Linux** | **Solaris** Except for Mac OS X, use the client image backup function to back up the entire volume. An image backup might actually use less system resources and run faster than incremental backup of some file systems with a large number of small files.
- Reduce the number of files per file system by spreading the data across multiple file systems.

**Related reference:**

Snappdiff

Exclude options

Incrbydate

Memoryefficientbackup

Resourceutilization

**AIX** | **Linux** | **Solaris** Virtualmountpoint

**Windows**

## Control processing with an include-exclude list

---

There might be files on your system that you do not want to back up. These files might be operating system or application files that you can easily recover by reinstalling the program, or any other file that you can easily rebuild.

Use the include and exclude options in the client options file (`dsm.opt`) to define which files to include or exclude from incremental or selective backup processing. A file is eligible for backup unless excluded by an exclude option. It is not necessary to use an include option to include specific files for backup unless those files are in a directory that contains other files that you want to exclude.

The include-exclude list might contain items that are specified by the server. To view the contents of your include-exclude list, use the query `inlexcl` command.

IBM Spectrum Protect™ uses *management classes* to determine how to manage your backups on the server. Every time you back up a file, the file is assigned a management class. The management class is either a default that is chosen for you, or one you assign to the file by using the include option in the include-exclude list. If you assign a management class, it must contain a backup copy group for the file to be backed up.

You can also add include-exclude statements in the backup-archive client GUI directory tree. You can use the preview command to see the resultant effects of the currently defined include-exclude list without need of running an actual backup operation.

**Related tasks:**

Creating an include-exclude list

Setting the client scheduler process to run as a background task and start automatically at startup

**Related reference:**

Preview Backup

Windows

## Data encryption during backup or archive operations

For the strongest possible encryption, use 256-bit Advanced Encryption Standard (AES) data encryption, with the encryptiontype option. AES 128-bit encryption is currently the default.

The data that you include is stored in encrypted form, and encryption does not affect the amount of data sent or received.

Attention: If the encryption key password is not saved in the Windows Registry, and you have forgotten the password, your data cannot be recovered.

The include.encrypt option is the only way to enable encryption on the Backup-Archive client. If no include.encrypt statements are used, encryption will not occur.

Encryption is not compatible with VMware virtual machine backups that use the incremental forever backup modes (MODE=IFIncremental and MODE=IFFull). If the client is configured for encryption, you cannot use incremental forever backup.

To encrypt file data, you must select an encryption key password, which the client uses to generate the encryption key for encrypting and decrypting the file data. You can specify whether to save the encryption key password in the Windows Registry by using the encryptkey option.

IBM Spectrum Protect™ client encryption allows you to enter a value of up to 63 characters in length. This encryption password needs to be confirmed when encrypting the file for backup, and also needs to be entered when performing restores of encrypted files.

While restoring an encrypted file, you are prompted for the key password to decrypt the file in the following cases:

- If the encryptkey option is set to Prompt.
- If the key supplied by the user does not match.
- If the encryptkey option is set to Save and the locally saved key password does not match the encrypted file.

**Related concepts:**

Backup (Windows): Additional considerations

**Related reference:**

Encryptiontype

Encryptkey

Exclude options

Include options

Windows

## Maximum file size for operations

The maximum file sizes for backup and restore, and archive and retrieve operations depends on the Windows file system that is used.

The following table shows the maximum file size, in bytes, for backing up, restoring, and retrieving data.

Table 1. Maximum file size

File system	Maximum file size (in bytes)
Windows FAT16	Windows 2 147 483 647 (2 GB)
Windows FAT32	Windows 4 294 967 295 (4 GB)
Windows NTFS and ReFS	Windows 17 592 185 978 880 (16 TB-64 K)

Windows

## How the client handles long user and group names

The backup-archive client can handle user and group names that are up to 64 characters without any issues. However, names longer than 64 characters require special handling.

Restriction: Do not exceed the 64-character limit for user and group names. The client shortens the name to fall within this limit by using the following algorithm: Use the first 53 characters, append a forward slash (/), and then use the numeric ID as a character string.

An error message is logged that contains both the long name and the resulting shortened string. For most functions, you do not need to be aware of the shortened name. The exceptions are:

- The set access command
- The fromowner option
- The users and groups (authorization) options

In each of these cases, when you need to enter a name, you either have to find the error message containing the transformation, or construct the name using the rule outlined here.

AIX Linux Mac OS X Solaris

## Pre-backup considerations (UNIX and Linux)

Various factors in your system or environment can affect the way the backup-archive client processes data. Review these considerations before you back up your data.

- **AIX Linux Solaris** LAN-free data movement  
LAN-free data movement shifts the movement of client data from the communications network to a storage area network (SAN). This decreases the load on the IBM Spectrum Protect server.
- **Mac OS X AIX Linux Solaris** Incremental backups on memory-constrained systems  
Incremental backup performance suffers if the system has a low amount of memory available before starting the backup.
- **Mac OS X AIX Linux Solaris** Incremental backups on systems with a large number of files  
The client can use large amounts of memory to run incremental backup operations, especially on file systems that contain large numbers of files.
- **Mac OS X AIX Linux Solaris** Include-exclude options to control processing  
You might have files in your file systems that you do not want to back up. These files might be core files, local caches of network file systems, operating system or application files that could be easily recovered by reinstalling the program, or any other files that you could easily rebuild.
- **Mac OS X AIX Linux Solaris** Data encryption during backup or archive operations  
The way to ensure data security is by encrypting data. Use data encryption to protect data during a backup or archive operation. Advanced Encryption Standard (AES) 128-bit encryption is the default encryption option. For the highest level of data encryption, use 256-bit Advanced Encryption Standard (AES) data encryption by specifying the encryptiontype option.
- **Mac OS X AIX Linux Solaris** File system and ACL support  
Special file systems contain dynamic information that is generated by the operating system; they contain no data or files. The UNIX and Linux clients ignore special file systems and their contents.
- **Mac OS X AIX Linux Solaris** Maximum file size for operations  
The maximum file size depends on the type of a file system. The backup-archive client does not check any file size limit during backup, archive, restore, or retrieve operations.
- **Mac OS X AIX Linux Solaris Windows** Long user and group names  
The backup-archive client can handle user and group names that are up to 64 characters without any issues. However, names longer than 64 characters require special handling by IBM Spectrum Protect.
- **Mac OS X** Mac OS X volume names  
The backup-archive client backs up volumes based on their UNIX mount point name.
- **Mac OS X** Mac OS X Unicode enablement  
The Mac OS X client is Unicode enabled. New clients storing data on the server for the first time require no special set up.
- **Mac OS X** Mac OS X Time Machine backup disk  
Time Machine is the backup application available with Mac OS X.

AIX Linux Solaris Windows

## LAN-free data movement

LAN-free data movement shifts the movement of client data from the communications network to a storage area network (SAN). This decreases the load on the IBM Spectrum Protect™ server.

The SAN provides a path that allows you to back up, restore, archive, and retrieve data to and from a SAN-attached storage device. Client data moves over the SAN to the storage device using the IBM Spectrum Protect Storage Agent. The Storage Agent must be installed on the same system as the client.

**AIX** | **Linux** | **Solaris** | AIX®, Linux, and Solaris clients support LAN-free data movement.

**Windows** | All Windows clients support LAN-free data movement.

- **AIX** | **Linux** | **Solaris** | LAN-free prerequisites  
To enable LAN-free support, you must install and configure the IBM Spectrum Protect for SAN storage agent on the client workstation.
- **AIX** | **Linux** | **Solaris** | LAN-free data movement options  
To enable LAN-free data movement, you can use several client options. You must first install and configure the IBM Spectrum Protect for SAN storage agent on the client workstation.

**AIX** | **Linux** | **Solaris** | **Windows**

## LAN-free prerequisites

---

To enable LAN-free support, you must install and configure the IBM Spectrum Protect™ for SAN storage agent on the client workstation.

IBM Spectrum Protect for SAN is a separate product.

For more information about installing and configuring the storage agent, see the documentation for IBM Spectrum Protect for SAN.

**AIX** | **Linux** | **Solaris** | **Windows**

## LAN-free data movement options

---

To enable LAN-free data movement, you can use several client options. You must first install and configure the IBM Spectrum Protect™ for SAN storage agent on the client workstation.

Use the following options to enable LAN-free data movement:

*enablelanfree*

Specifies whether to enable an available LAN-free path to a SAN-attached storage device.

*lanfreecommmethod*

Specifies a communication protocol between the client and the Storage Agent.

*lanfreeshmport*

Specifies the unique number that is used by the client and the storage agent to identify shared memory area used for communications.

*lanfreetcport*

Specifies the TCP/IP port number where the Storage Agent is listening.

*lanfreetcserveraddress*

Specifies the TCP/IP address for the storage agent.

### **Related reference:**

Enablelanfree

Lanfreecommmethod

Lanfreeshmport

Lanfreessl

Lanfreetcport

Lanfreetcserveraddress

**Mac OS X** | **AIX** | **Linux** | **Solaris** | **Windows**

## Incremental backups on memory-constrained systems

---

Incremental backup performance suffers if the system has a low amount of memory available before starting the backup.

If your system is memory constrained, specify the `memoryefficientbackup yes` option in your client options file. This option causes the backup-archive client to process only one directory at a time, which reduces memory consumption but increases backup time. When you specify `yes`, the client analyzes only one directory at a time for backup consideration. If performance remains poor, check your communication buffer settings and the communication link between your system and the IBM Spectrum Protect™ server. If your system is not memory constrained, setting the `memoryefficientbackup` option to `yes` degrades your backup performance.

**Related reference:**

`Memoryefficientbackup`

## Incremental backups on systems with a large number of files

---

The client can use large amounts of memory to run incremental backup operations, especially on file systems that contain large numbers of files.

The term *memory* as used here is the addressable memory available to the client process. Addressable memory is a combination of physical RAM and virtual memory.

On average, the client uses approximately 300 bytes of memory per object (file or directory). Thus for a file system with one million files and directories, the client requires, on average, approximately 300 MB of memory. The exact amount of memory that is used per object varies, depending on the length of the object path and name length, or the nesting depth of directories. The number of bytes of data is not an important factor in determining the backup-archive client memory requirement.

The maximum number of files can be determined by dividing the maximum amount of memory available to a process by the average amount of memory that is needed per object.

The total memory requirement can be reduced by any of the following methods:

- Use the client option `memoryefficientbackup diskcachemethod`. This choice reduces the use of memory to a minimum at the expense of performance and a significant increase in disk space that is required for the backup. The file description data from the server is stored in a disk-resident temporary database, not in memory. As directories on the workstation are scanned, the database is consulted to determine whether to back up, update, or expire each object. At the completion of the backup, the database file is deleted.
- Use the client option `memoryefficientbackup yes`. The average memory that is used by the client then becomes 300 bytes times the number of directories plus 300 bytes per file in the directory that is being processed. For file systems with large numbers (millions) of directories, the client still might not be able to allocate enough memory to perform incremental backup with `memoryefficientbackup yes`.
- |     |       |         |
|-----|-------|---------|
| AIX | Linux | Solaris |
|-----|-------|---------|

 UNIX and Linux clients might be able to use the `virtualmountpoint` client option to define multiple virtual mount points within a single file system, each of which can be backed up independently by the client.
- If the client option `resourceutilization` is set to a value greater than 4, and multiple file systems are being backed up, then reducing `resourceutilization` to 4 or lower limits the process to incremental backup of a single file system at a time. This setting reduces the memory requirement. If the backup of multiple file systems in parallel is required for performance reasons, and the combined memory requirements exceed the process limits, then multiple instances of the backup client can be used to back up multiple file systems in parallel. For example, if you want to back up two file systems at the same time but their memory requirements exceed the limits of a single process, then start one instance of the client to back up one of the file systems, and start a second instance of the client to back up the other file system.
- Use the `-incrbydate` client option to perform an "incremental-by-date" backup.
- Use the `exclude.dirclient` option to prevent the client from traversing and backing up directories that do not need to be backed up.
- |     |       |         |
|-----|-------|---------|
| AIX | Linux | Solaris |
|-----|-------|---------|

 Except for Mac OS X, use the client image backup function to back up the entire volume. An image backup might actually use less system resources and run faster than incremental backup of some file systems with a large number of small files.
- Reduce the number of files per file system by spreading the data across multiple file systems.

**Related reference:**

`Snappdiff`

`Exclude options`

`Incrbydate`

`Memoryefficientbackup`

`Resourceutilization`

AIX	Linux	Solaris	<code>Virtualmountpoint</code>
Mac OS X	AIX	Linux	Solaris

## Include-exclude options to control processing

---

You might have files in your file systems that you do not want to back up. These files might be core files, local caches of network file systems, operating system or application files that could be easily recovered by reinstalling the program, or any other files that you could easily rebuild.

You can use the exclude and include options in your include-exclude options list to specify which files to exclude from backup processing.

Use the include and exclude options in `dsm.sys` to define which files to include or exclude from incremental or selective backup processing. A file is eligible for backup unless excluded by an exclude option. It is not necessary to use an include option to include specific files for backup unless those files are in a directory containing other files you want to exclude.

IBM Spectrum Protect™ uses management classes to determine how to manage your backups on the server. Every time you back up a file, the file is assigned a management class. The management class is either a default chosen for you, or one you assign to the file using the include option in the include-exclude list. If you assign a management class, it must contain a backup copy group for the file to be backed up.

### Related tasks:

Creating an include-exclude list

Setting the client scheduler process to run as a background task and start automatically at startup

AIX Linux Solaris Mac OS X

## Data encryption during backup or archive operations

---

The way to ensure data security is by encrypting data. Use data encryption to protect data during a backup or archive operation. Advanced Encryption Standard (AES) 128-bit encryption is the default encryption option. For the highest level of data encryption, use 256-bit Advanced Encryption Standard (AES) data encryption by specifying the `encryptiontype` option.

The data that you include is stored in encrypted form, and encryption does not affect the amount of data that is sent or received.

The `include.encrypt` option is the only way to enable encryption on the backup-archive client. If no `include.encrypt` statements are used encryption cannot occur.

**Linux** Encryption is not compatible with VMware virtual machine backups that use the incremental forever backup modes (`MODE=IFIncremental` and `MODE=IFFull`). If the client is configured for encryption, you cannot use incremental forever backup.

Use the include and exclude options in `dsm.sys` to define which files to include or exclude from incremental or selective backup processing. A file is eligible for backup unless excluded by an exclude option. It is not necessary to use an include option to include specific files for backup unless those files are in a directory that contains other files that you want to exclude.

To encrypt file data, you must select an encryption key password, which the client uses to generate the encryption key for encrypting and decrypting the file data. Store the encryption key password for later use. You can specify whether to save the encryption key password in a file that is named `TSM.sth` by using the `encryptkey` option.

IBM Spectrum Protect™ client encryption allows you to enter a value of up to 63 characters in length. This encryption password needs to be confirmed when encrypting the file for backup, and also needs to be entered when performing restores of encrypted files.

While restoring the encrypted file, the client prompts you for the key password to decrypt the file in the following cases:

- The `encryptkey` option is set to `Prompt`.
- The key supplied by the user in the previous case does not match.
- The `encryptkey` option is set to `Save` and the locally saved key password does not match the encrypted file.

### Related reference:

Encryptiontype

Encryptkey

Exclude options

Include options

Mac OS X AIX Linux Solaris

## File system and ACL support

---

Special file systems contain dynamic information that is generated by the operating system; they contain no data or files. The UNIX and Linux clients ignore special file systems and their contents.

Special file systems include the following types:

- The `/proc` file system on most of the UNIX platforms
- The `/dev/fd` file system on Solaris
- The `/dev/pts` on Linux

The backup-archive client can work on specific file system types that are commonly used. For a list of supported file system types, see Table 1.

Restriction: The table shows full support for NFS on AIX®, including preservation of ACLs and extended attributes. On other operating systems, NFS backups are supported, but the backups include only standard POSIX metadata (access permissions, creation date, and so on). For more information about backing up NFS file systems, see Backup network file systems.

**Table 1. Supported file systems and ACL support**

<b>Platform</b>	<b>File System</b>	<b>ACL Support</b>
AIX	GPFS™	Yes
	JFS	Yes
	JFS2	Yes
	JFS2 NFSV4	Yes
	VxFX	Yes
Linux x86_64	Btrfs	Yes
	XFS	Yes
	EXT2	Yes
	EXT3	Yes
	EXT4	Yes
	ReiserFS	Yes
	GPFS	Yes
	JFS	No
	VxFS	No
	NSS	Yes
Linux on Power Systems™ Servers	Btrfs	Yes
	XFS	Yes
	EXT2	Yes
	EXT3	Yes
	EXT4	Yes
	ReiserFS	Yes
	JFS	No
	GPFS	Yes
Linux on z Systems®	Btrfs	Yes
	EXT2	Yes
	EXT3	Yes
	EXT4	Yes
	ReiserFS	Yes
	JFS	No
	GPFS	Yes

Platform	File System	ACL Support
macOS	HFS Standard (HFS)	Yes
	HFS Extended (HFS+)	Yes
	HFS Extended case-sensitive (HFSX)	Yes
	Xsan (XSAN)	Yes
	Universal disk format (UDF)	Yes
	ISO9660	Yes
	Apple File System (APFS)	Yes
Solaris	UFS	Yes
	VxFS	Yes
	QFS	No
	ZFS	Yes

**AIX** | **Solaris** With file systems where NFS V4 ACLs are defined and used (Solaris ZFS and AIX JFS2 V2), even if only the standard UNIX permissions or ACLs have changed (such as with the CHMOD command), the file or directory is fully backed up again. With other file systems, this type of change causes only an attribute update on the IBM Spectrum Protect™ server.

**AIX** | **Linux** | **Solaris** To process all other file systems, use the virtualmountpoint option to enable support for the following items:

- To back up, restore, archive, and retrieve file data
- For basic UNIX and Linux permissions
- For change, access, and modification time stamps, and the directory tree structure

No other file system specific attributes, such as the ACL, are valid. The file system type for such file systems is set to "UNKNOWN".

**AIX** | **Linux** | **Solaris** For example, if the /media/abc/DATA1 file system is not supported by the client, add the following statement to dsm.sys to back up or archive the data in this file system:

```
VIRTUALMOUNTPOINT /media/abc/DATA1
```

This support is only available if the file system can use basic POSIX system calls, such as read or write processing on your system. Cross-platform backup and restore are not supported. For example, data backed up by an AIX client is not available for restore by a Windows client and vice versa.

**Mac OS X** Note: Data that is backed up or archived by the Mac OS X client cannot be restored by any other client. Additionally, the Mac OS X client cannot restore or retrieve data from any other client.

You can use the cross-file system type restore or retrieve method for ACL information if both the original file system and the destination file system support compatible ACLs. For example, on Solaris, the ACL information that is backed up from a VxFS file system is restored to a UFS file system because these file systems support compatible ACLs. The ACL information is not restored during cross-file system restore or retrieve operations if the original file system and the destination file system do not support ACLs,

The stand-alone package LSCqfs 3.5.0 is the only supported version of QFS. In addition, the following restrictions also apply to the QFS file system:

- **AIX** | **Linux** | **Solaris** Image backup is not supported on QFS file systems.
- The Solaris backup-archive client does not support the combination of QFS and SAM needed to archive files onto tertiary background storage, such as tapes. Instead, it recalls files from tape to disk automatically if it finds migrated files during a backup.
- A QFS file system contains two hidden system files and a system directory that cannot be backed up; and this is acceptable because a backup of these files is not needed. They contain internal data to manage the file system. The internal data is automatically excluded from a backup and is re-created automatically by the file system itself, if a restore of files in that file system is completed.

Incremental, selective, filelist back up, archive, restore, and retrieve processing of the Veritas file system and its ACLs on AIX are supported. Restore of a Veritas volume on a Logical Volume Manager volume (and vice versa) is allowed, provided both have the same file system type.



**Mac OS X** The following information pertains only to Mac OS X systems:

- On Mac OS X systems, the UFS and HFSX file systems are case-sensitive whereas the HFS+ file system is not case-sensitive but is case-preserving. Files that you back up from a UFS or HFSX file system (case-sensitive) might not be restored properly to an HFS+ file system (not case-sensitive) file system. For example, on a UFS file system, files `Afile` and `afile` are seen as different files. However, on an HFS+ file system the two files are seen as identical.
- On Mac OS X, if case-sensitive HFS+ or UFS file systems are used, it is important that the data from the HFSX or UFS file system is not backed up to an HFS+ file system on the IBM Spectrum Protect server. Either a new name must be used on the system or the existing file space on the IBM Spectrum Protect server must be renamed. For example, consider a system that has a file system named `/Volumes/fs2` and this system is repartitioned with a case-sensitive HFS+ file system. Either the `/Volumes/fs2` file system on the IBM Spectrum Protect server must be renamed, or a new name must be used on the local system. If this renaming is not done, the HFSX case-sensitive data is mixed with the HFS+ case-insensitive data that is already stored on the IBM Spectrum Protect server.
- On Mac OS X, aliases and symbolic links are backed up. However, the client does not back up the data to which the symbolic links point.
- On Mac OS X, when files that are backed up from an HFS volume are restored to a UFS volume, the resource forks are not assigned to the correct owner. Correct this problem by using the `chown` command on the resource fork file to change the owner. The resource fork file stores structured data in a file.

**Linux** On Linux on POWER® and Linux on System z®, you must install `libacl.so` for the client to back up ACLs.

**AIX** | **Linux** Important: If you are running GPFS for AIX, GPFS for Linux x86\_64, or GPFS for Linux on z Systems in a multinode cluster, and all nodes share a mounted GPFS file system, the client processes this file system as a local file system. The client backs up the file system on each node during an incremental backup. To avoid this, you can do one of the following things:

- Explicitly configure the domain statement in the client user-options file (`dsm.opt`) to list the file systems you want that node to back up.
- Set the `exclude.fs` option in the `dsm.sys` file to exclude the GPFS file system from backup services.

If the GPFS cluster contains different platforms, you must use backup-archive clients on only one platform to protect a single file system. Do not use backup-archive clients on more than one platform to protect a GPFS file system that is shared among more than one platform

For example, assume that a cluster contains nodes on AIX, Linux x86, and Linux zSeries systems. You can protect file system A with AIX backup-archive clients and protect file system B with Linux zSeries backup-archive clients. Or you can protect file system A and file system B with AIX backup-archive clients. If you protect file system A with an AIX backup-archive client, you must not protect file system A with a backup-archive client on any platform other than AIX.

## Support for cross operating system recovery for files stored in IBM Spectrum Scale file systems

In an IBM Spectrum Scale™ cluster with multiple operating system types, a file that holds ACL or extended attribute metadata and was backed up on a source operating system, can be restored on a target operating system. The ACL or extended attribute metadata is correctly restored correctly if both operating system types on the source and the target use the same version of IBM Spectrum Scale.

The following are the supported source-operating-systems types:

- AIX
- Linux for IBM System Power big endian (pBE)
- Linux x86
- Linux for IBM System z

The following are the supported target-operating-system types:

- Linux for IBM System Power little endian (pLE)
- Linux x86
- Linux for IBM System z

The security settings for affected users and groups must match on both the source and the target systems.

Do not mix operating system types for backup activity. Choose only one operating system type available in your IBM Spectrum Scale cluster, and use it for all backup operations.

**Mac OS X** | **AIX** | **Linux** | **Solaris**

## Maximum file size for operations

The maximum file size depends on the type of a file system. The backup-archive client does not check any file size limit during backup, archive, restore, or retrieve operations.

If the file system allows creation of the file, the client backs up or archives the file.

The following table specifies the maximum file sizes for the native file systems on UNIX and Linux client platforms.

Table 1. Maximum file size

Platform	Max file size (in bytes)
<b>AIX</b> AIX® 6.1 (JFS2) size limitations	<b>AIX</b> Maximum JFS2 file system size: 32 TB Maximum JFS2 file size: 16 TB Minimum JFS2 file system size: 16 MB
<b>Linux</b> All Linux clients	<b>Linux</b> 9 223 372 036 854 775 807 (8 EB-1)
<b>Mac OS X</b> Mac OS X	<b>Mac OS X</b> HFS - 2 147 485 648 (2GB) HFS+, HFSX, XSAN, and UFS - 9 223 372 036 854 775 808 (8EB)
<b>Solaris</b> Solaris	<b>Solaris</b> 1 099 511 627 775 (1 TB-1)
<b>Solaris</b> Solaris (ZFS)	<b>Solaris</b> 18 446 744 073 709 551 616 (16 EB)

**Mac OS X** | **AIX** | **Linux** | **Solaris** | **Windows**

## Long user and group names

The backup-archive client can handle user and group names that are up to 64 characters without any issues. However, names longer than 64 characters require special handling by IBM Spectrum Protect™.

**Important:** Do not exceed the 64 character limit for user and group names. If you do, the client shortens the name to fall within this limit by using the following transformation: Take the first 53 characters, append a forward slash (/), and then the numeric ID as a character string.

An error message is logged that contains both the long name and the resulting shortened string. For most functions, you do not need to be aware of the shortened name. The exceptions are:

- The set access command
- The fromowner option
- The users and groups (authorization) options

In each of these cases, when you need to enter a name, you either have to find the error message containing the transformation, or construct the name using the rule outlined here.

**Mac OS X**

## Mac OS X volume names

The backup-archive client backs up volumes based on their UNIX mount point name.

IBM Spectrum Protect™ maintains each volume name as a separate restore or retrieve volume. These volume names become the names of file spaces on the server.

If you change the name of a volume you have already backed up, the client sees it as a new volume and does not relate it to the previous one. Any backup of the volume backs up the files under the new name. A mismatch might occur if you rename your volumes, or if you access IBM Spectrum Protect from a different workstation than the one from which you backed up the files.

- **Mac OS X** Mac OS X volume naming precautions  
IBM Spectrum Protect creates all new file spaces on the server with the UNIX mount point of the volume.

- **Mac OS X** Mac OS X volume naming precautions on dual boot systems  
If you have more than one version of Mac OS X that you switch between, it is critical that you understand how the client uses the UNIX mount paths for file space names on the IBM Spectrum Protect server.

**Mac OS X**

## Mac OS X volume naming precautions

---

IBM Spectrum Protect™ creates all new file spaces on the server with the UNIX mount point of the volume.

If there are two volumes with the names such as "La Pomme" and "la pomme", two unique UNIX mount points are created.

The following examples show the two mount points that are created:

```
/Volumes/La Pomme  
/Volumes/la pomme
```

If duplicate volumes exist on your desktop, it is possible for the UNIX mount points to be different than the last time the client did a backup. The client might not back up the data to the correct file system on the IBM Spectrum Protect server.

You can check the file system where the client backs up the data:

1. In the Backup window, select a file system.
2. Click **File** → **Show Info**.

The UNIX mount point is in the Information dialog.

The best way to avoid any potential naming problems is to ensure that the volume names are unique.

Important:

- The client continues to use the existing file space names on the IBM Spectrum Protect Server. Only new file spaces use the UNIX mount point for the name.
- Do not specify volumes with periods in the name (...). The client uses the sequence of periods as part of include-exclude processing. The client reports an invalid include-exclude statement if a volume has a sequence of periods in the name. The volume *must* be renamed.

**Mac OS X**

## Mac OS X volume naming precautions on dual boot systems

---

If you have more than one version of Mac OS X that you switch between, it is critical that you understand how the client uses the UNIX mount paths for file space names on the IBM Spectrum Protect™ server.

For example, consider a dual-boot system that has two volumes, El Capitan and Sierra. The finder and the backup-archive client GUI displays these as El Capitan and Sierra. However, the UNIX mount points depend upon which version of Mac OS is running. If El Capitan is the startup disk, the UNIX paths are:

```
/  
/Volumes/Sierra
```

If Sierra is the startup disk, the UNIX paths are:

```
/  
/Volumes/El Capitan
```

When a backup or archive operation is run, the file space names also depend on which version of Mac OS X is running.

Both versions of Mac OS X back up to the / file system on the IBM Spectrum Protect server. When this happens, the system files are intermixed.

To avoid potential problems on dual-boot systems, complete one of these tasks:

1. Select one version of Mac OS X on which to install and run IBM Spectrum Protect. This ensures that the UNIX mount points are the same each time the client does a backup.
2. Configure each version of Mac OS X with a unique IBM Spectrum Protect node name. Then exclude the other version of Mac OS X from backup processing with a domain statement in the system options file. For example, if the volume Sierra is the

startup disk, add this option to the system options file:

```
DOMAIN -/Volumes/El Capitan
```

If the volume El Capitan is the startup disk, add this to the system options file:

```
DOMAIN -/Volumes/Sierra
```

Mac OS X

## Mac OS X Unicode enablement

---

The Mac OS X client is Unicode enabled. New clients storing data on the server for the first time require no special set up.

The server automatically stores files and directories as Unicode enabled. However, if you are upgrading to the Unicode-enabled client, you need to plan the migration of existing file spaces so they can support Unicode.

Any file spaces that are already on the server must be renamed so Unicode-enabled file spaces can be created. Use the `autofsrename` option rename existing file spaces.

### Related reference:

Autofsrename

Mac OS X

## Mac OS X Time Machine backup disk

---

Time Machine is the backup application available with Mac OS X.

IBM Spectrum Protect™ can be used at the same time as Mac OS X Time Machine application. However, due to the unique nature of how the Mac OS X Time Machine application backs up data, consider the following items before using the backup-archive client to back up the Mac OS X Time Machine data:

- The Mac OS X Time Machine backup disk makes extensive use of both file and directory hard links to minimize disk usage. For example, if the disk backed up with the Mac OS X Time Machine application is 5 GB, the first backup copies 5 GBs of data to the Mac OS X Time Machine backup disk.

Subsequent backups only copy the files that have changed since the previous backup. All files and directories that have not changed are hard-linked with the version that was copied during the previous backup.

The Finder shows each backup as 5 GB, for a total size of 10 GB. However, because of the use of hard links, the total disk usage is only slightly larger than 5 GB.

All hard-linked objects that are not already on the IBM Spectrum Protect server are backed up.

For example, 10 GB of data would be sent to the IBM Spectrum Protect server.

- When files that are restored are hard-linked, the client recreates the original hard link. Recreating the original hard link can only be done if *all* files that are hard-linked are restored at the same time. Restoring all the hard-linked files at the same time is not a practical method for a large backup disk that uses the Mac OS X Time Machine application.
- When the Mac OS X Time Machine application copies files to the backup disk, ACLs are added to the files to protect them from deletion. the backup-archive can back up and restore files with ACLs. However, any files that are restored must have these restrictive ACLs in place.

**Tip:** For best results, exclude the Time Machine application backup data. All Time Machine application data is in a directory named `Backups.backupdb`.

### Related concepts:

System files to exclude

Windows

## Incremental, selective, or incremental-by-date backups (Windows)

---

Your administrator might set up schedules to automatically back up files. This section contains information about how to back up files without a schedule.

There are three types of incremental backup: *full*, *partial*, and *incremental-by-date*.

If you migrate files with IBM Spectrum Protect™ HSM for Windows, there can be consequences for backup operations.

- **Windows** Full and partial incremental backup  
An incremental backup backs up only new and changed files. The type of incremental backup depends on what objects you select to be backed up.
- **Windows** Incremental-by-date backup  
For a file system to be eligible for incremental-by-date backups, you must have performed at least one full incremental backup of that file system. Running an incremental backup of only a directory branch or individual file will not make the file system eligible for incremental-by-date backups.
- **Windows** Comparing incremental-by-date, journal-based, and NetApp snapshot difference to full incremental and partial incremental backups  
Incremental-by-date, journal-based, and NetApp snapshot difference are alternatives to full incremental and partial incremental back methods.
- **Windows** Snapshot differential backup with an HTTPS connection  
You can use a secure HTTPS connection for the backup-archive client to communicate with a NetApp filer during a snapshot differential backup.
- **Windows** Selective backup  
Use a selective backup when you want to back up specific files or directories regardless of whether a current copy of those files exists on the server.

**Related concepts:**

**Windows** Backup and restore of migrated files

**Related tasks:**

Setting the client scheduler process to run as a background task and start automatically at startup

## Full and partial incremental backup

An incremental backup backs up only new and changed files. The type of incremental backup depends on what objects you select to be backed up.

**Mac OS X** | **AIX** | **Linux** | **Solaris** If you select entire file systems, the backup is a full incremental backup. If you select a directory tree or individual files, the backup is a partial incremental backup.

**Windows** If you select entire drives, the backup is a full incremental backup. If you select a directory tree or individual files, the backup is a partial incremental backup.

The first time that you run a full incremental backup, the backup-archive client backs up all the files and directories that you specify. The backup operation can take a long time if the number of files is large, or if one or more large files must be backed up. Subsequent full incremental backups only back up new and changed files. The backup server maintains current versions of your files without having to waste time or space by backing up files that exist in IBM Spectrum Protect™ server storage.

**Mac OS X** | **AIX** | **Linux** | **Solaris** | **Windows** Depending on your storage management policies, the IBM Spectrum Protect server might keep more than one version of your files in storage. The most recently backed up files are active backup versions. Older copies of your backed up files are inactive versions. However, if you delete a file from your workstation, the next full incremental backup causes the active backup version of the file to become inactive. You can restore an inactive version of a file. The number of inactive versions that are maintained by the server and how long they are retained is governed by the management policies that are defined by your IBM Spectrum Protect server administrator. The active versions represent the files that existed on your file system at the time of the last backup.

**Mac OS X** | **AIX** | **Linux** | **Solaris** | **Windows** To start a full or partial incremental backup by using the client GUI, select Backup, and then select the Incremental (complete) option. From the command line, use the incremental command and specify file systems, directory trees, or individual files to include in the backup.

**Mac OS X** | **AIX** | **Linux** | **Solaris** | **Windows** During an incremental backup, the client queries the server or the journal database to determine the exact state of your files since the last incremental backup. The client uses this information for the following tasks:

- Back up new files.
- Back up files whose contents changed since the last backup.
  - **Windows** Files are backed up when any of the following attributes change:
    - File size

- o Date or time of last modification
- o Extended Attributes
- o Access Control List
- o Sparse, reparse point or encrypted file attributes.
- o NTFS or ReFS file security descriptors: Owner Security Identifier (SID), Group SID, Discretionary Access Control List (ACL), and System ACL.
- o Directory attributes

If only the following attributes change, the attributes are updated on the IBM Spectrum Protect server, but the file is not backed up:

- o Read-only or read/write
- o Hidden or not hidden
- o Compressed or not compressed

The archive attribute is not examined by IBM Spectrum Protect in determining changed files.

**Mac OS X | AIX | Linux | Solaris** Files are backed up when any of the following attributes change:

- o File size
- o Date or time of last modification
- o Extended Attributes
- o Access Control List

If only the following attributes change, the attributes are updated on the IBM Spectrum Protect server, but the file is not backed up:

- o File owner
- o File permissions
- o Inode
- o Group ID
- o **AIX | Linux** Change time (`ctime`) attribute (for objects in GPFS file systems only and if the `updatectime` option is set to yes). For more details, see the `updatectime` option.
- o Icon location (Mac OS X only)
- o Type or creator (Mac OS X only)

- Back up directories.

A directory is backed up in any of the following circumstances:

- o The directory was not previously backed up.
- o The directory permissions changed since the last backup.
- o The directory Access Control List changed since the last backup.
- o The directory Extended Attributes changed since the last backup.
- o **AIX | Linux** The change time (`ctime`) attribute is updated since the last backup (for GPFS file systems only). For more details, see the `updatectime` option.

**Mac OS X | AIX | Linux | Solaris | Windows** Directories are counted in the number of objects that are backed up. To exclude directories and their contents from backup, use the `exclude.dir` option.

- **Mac OS X | AIX | Linux | Solaris | Windows** Expire backup versions of files on the server that do not have corresponding files on the workstation. The result is that files that no longer exist on your workstation do not have active backup versions on the server. However, inactive versions are retained according to rules defined by the IBM Spectrum Protect administrator.
- Rebind backup versions if management class assignments change. Only objects that have active backup versions are bound again. Objects for which only inactive backup versions exist are not bound again. During a partial incremental backup operation, objects are rebound or expired as follows:

If the file specification matches all files in a path:

Rebinding and expiration occurs for all eligible backup versions that match the file specification. This is the case for an incremental command like `dsmc incr c:\mydir\* -subdir=yes`.

If the file specification does not match all files in a path:

Rebinding and expiration occurs for all eligible backup versions that match the file specification. However, eligible backup versions are not expired or rebound if they were in a directory that no longer exists on the client file system.

Consider an incremental command like `dsmc incr c:\mydir\*.txt -subdir=yes`. Assume that some files in `c:\mydir\` do not have the `txt` file type. Rebinding and expiration occurs only for files that match the `*.txt` specification and whose directories still exist on the client file system.

**Mac OS X | AIX | Linux | Solaris | Windows** You can use the `preservelastaccessdate` option to specify whether to modify the last access date after a backup or archive operation. By default, the access date changes after a backup or archive operation.

- **Windows** Journal-based backup

Journal-based backup is an alternate method of backup that uses a change journal maintained by the IBM Spectrum Protect journal service process.

**Related concepts:**

Storage management policies

**Related reference:**

Exclude options

Mac OS X	AIX	Linux	Solaris	Windows	Preservelastaccessdate
AIX	Linux	Updatectime			

## Incremental-by-date backup

For a file system to be eligible for incremental-by-date backups, you must have performed at least one full incremental backup of that file system. Running an incremental backup of only a directory branch or individual file will not make the file system eligible for incremental-by-date backups.

**Windows** To perform an incremental-by-date backup using the GUI, select the incremental (date only) option from the *type of backup* pull-down menu or use the `incrbydate` option with the incremental command.

The client backs up only those files whose modification date and time is later than the date and time of the last incremental backup of the file system on which the file resides. Files added by the client after the last incremental backup, but with a modification date earlier than the last incremental backup, are not backed up.

Files that were renamed after the last incremental backup, but otherwise remain unchanged, will not be backed up. Renaming a file does not change the modification date and time of the file. However, renaming a file does change the modification date of the directory in which it is located. In this case, the directory is backed up, but not the files it contains.

If you run an incremental-by-date backup of the whole file system, the server updates the date and time of the last incremental backup. If you perform an incremental-by-date backup on only part of a file system, the server does not update the date of the last full incremental backup. In this case, the next incremental-by-date backup backs up these files again.

Note: Unlike incremental backups, incremental-by-date backups do not expire deleted files or rebind backup versions to a new management class if you change the management class.

**Related tasks:**

AIX	Linux	Mac OS X	Solaris	Backing up data using the Java GUI
Windows	AIX	Linux		

## Comparing incremental-by-date, journal-based, and NetApp snapshot difference to full incremental and partial incremental backups

Incremental-by-date, journal-based, and NetApp snapshot difference are alternatives to full incremental and partial incremental back methods.

**Incremental-by-date backup**

An incremental-by-date backup takes less time to process than a full incremental backup and requires less memory.

An incremental-by-date backup might not place exactly the same backup files into server storage because the incremental-by-date backup:

- **Mac OS X** | **AIX** | **Linux** | **Solaris** | **Windows** Does not expire backup versions of files that you delete from the workstation.
- Does not rebind backup versions to a new management class if you change the management class.
- Does not back up files with attributes that change, unless the modification dates and times also change.
- **Mac OS X** | **AIX** | **Linux** | **Solaris** | **Windows** Ignores the copy group frequency attribute of management classes (Journal-based backups also ignore this attribute).

**Journal-based backup**

**AIX** | **Linux** | **Windows** The memory requirements for an initial journaling environment are the same as the memory requirements for a full file space incremental, because journal-based backups must complete the full file space incremental in order to set the journal database as valid, and to establish the baseline for journaling.



**AIX** | **Linux** | **Windows** The memory requirements for subsequent journal-based backups are much less. Journal backup sessions run in parallel and are governed by the resourceutilization client option in the same manner as normal backup sessions. The size of the journal database file reverts to a minimal size (less than 1 KB) when the last entry has been deleted from the journal. Since entries are deleted from the journal as they are processed by the client, the disk size occupied by the journal should be minimal after a complete journal backup. A full incremental backup with journaling active takes less time to process than an incremental-by-date backup.

**AIX** | **Linux** On AIX and Linux, journal-based backup does have some limitations. See Journal-based backup on AIX and Linux for information.

#### NetApp snapshot difference

**Linux** | **Windows** For NAS and N-Series file servers that are running ONTAP 7.3.0, or later, you can use the snapdiff option to invoke the snapshot difference backup from NetApp when running a full-volume incremental backup. Using this option reduces memory usage and is faster.

**Linux** | **Windows** Consider the following restrictions when running a full-volume incremental backup using the snapdiff option, to ensure that data is backed up when it should be.

- A file is excluded due to an exclude rule in the include-exclude file. The client runs a backup of the current snapshot with that exclude rule in effect. This happens when you have not made changes to the file, but you have removed the rule that excluded the file. NetApp will not detect this include-exclude change because it only detects file changes between two snapshots.
- If you added an include statement to the option file, that include option does not take effect unless NetApp detects that the file has changed. The client does not inspect every file on the volume during backup.
- If you used the dsmc delete backup command to explicitly delete a file from the IBM Spectrum Protect inventory, NetApp cannot detect that a file was manually deleted from IBM Spectrum Protect storage. Therefore, the file remains unprotected in IBM Spectrum Protect storage until it is changed on the volume and the change is detected by NetApp, which signals the client to back it up again.
- Policy changes such as changing the policy from mode=modified to mode=absolute are not detected.
- The entire file space is deleted from the IBM Spectrum Protect inventory. This action causes the snapdiff option to create a new snapshot to use as the source, and a full incremental backup to be run.

The NetApp software determines what is a changed object, not IBM Spectrum Protect.

**Linux** If you run a full volume backup of an NFS-mounted NetApp or N-Series volume, all the snapshots under the snapshot directory might also be backed up.

To avoid backing up all snapshots under the snapshot directory, do one of the following actions:

- Run NDMP backups
- Run backups using the snapshotroot option
- Run incremental backups using the snapdiff option  
Tip: If you run an incremental backup using the snapdiff option and you schedule periodic incremental backups, use the createnewbase=yes option with the snapdiff option to create a base snapshot and use it as a source to run an incremental backup.
- Exclude the snapshot directory from backups.

**Linux** On Linux systems, the snapshot directory is in .snapshot.

Note: The .snapshot directory is not backed up for some versions of Red Hat Linux, so you are not required to exclude it.

**Windows** On Windows systems, the snapshot directory is in ~snapshot.

**Windows**

## Snapshot differential backup with an HTTPS connection

You can use a secure HTTPS connection for the backup-archive client to communicate with a NetApp filer during a snapshot differential backup.

The HTTPS protocol is enabled on NetApp filers by default and cannot be disabled.

When you run a snapshot differential backup, the backup-archive client establishes an administrative session with a NetApp filer. The filer credentials, such as the filer host name or IP address, the user name that is used to connect to the filer, and the filer password, are stored locally on the backup-archive client. This information must be transmitted to the filer to establish the



authenticated administrative session. It is important to use a secure connection because authenticating the administrative filer session requires the client to transmit the filer password in clear text.

To establish a secure connection by using the HTTPS communication protocol, you must use the `snappdiffhttps` option whenever you run a snapshot differential backup. Without the `snappdiffhttps` option, the backup-archive client can establish filer sessions only with the HTTP protocol, which would require HTTP administrative access to be enabled on the filer. With the `snappdiffhttps` option, you can establish a secure administrative session with the NetApp filer regardless of whether HTTP administrative access is enabled on the NetApp filer.

Restrictions:

The following restrictions apply to snapshot differential backups with HTTPS:

- The HTTPS connection is used only to securely transmit data over the administrative session between the backup-archive client and the NetApp filer. The administrative session data includes information such as filer credentials, snapshot information, and file names and attributes that are generated by the snapshot differencing process. The HTTPS connection is not used to transmit normal file data that is accessed on the filer by the client through file sharing. The HTTPS connection also does not apply to normal file data transmitted by the client to the IBM Spectrum Protect™ server through the normal IBM Spectrum Protect client/server protocol.
- The `snappdiffhttps` option does not apply to vFiles because the HTTPS protocol is not supported on the NetApp vFiler.
- The `snappdiffhttps` option is available only by using the command-line interface. It is not available for use with the backup-archive client GUI.
- **Windows** Running a snapshot differential backup with an HTTPS connection  
When you run a snapshot differential backup, you can use the `snappdiffhttps` option to create a secure HTTPS connection between the backup-archive client and the NetApp filer.

**Related concepts:**

**Windows** Comparing incremental-by-date, journal-based, and NetApp snapshot difference to full incremental and partial incremental backups

**Related tasks:**

Configuring NetApp and IBM Spectrum Protect for snapshot difference incremental backups

**Windows** Running a snapshot differential backup with an HTTPS connection

**Linux** Running a snapshot differential backup with an HTTPS connection

**Related reference:**

`Snappdiffhttps`

`Snappdiff`

## Selective backup

---

Use a selective backup when you want to back up specific files or directories regardless of whether a current copy of those files exists on the server.

Incremental backups are generally part of an automated system to back up entire file systems. In contrast, selective backups allow you to manually select a set of files to back up regardless of whether they have changed since your last incremental backup.

Unlike incremental backups, a selective backup provides the following:

- Does not cause the server to update the date and time of the last incremental.
- Backs up directory and file entries even if their size, modification timestamp, or permissions have not changed.
- Does not expire deleted files.
- Does not rebind backup versions to a new management class if you change the management class.

**Related tasks:**

**Windows** Backing up data using the GUI

**Mac OS X** **AIX** **Linux** **Solaris** Backing up data using the Java GUI

**Related reference:**

Selective

**Mac OS X** **AIX** **Linux** **Solaris**

## Performing an incremental, selective, or incremental-by-date backup (UNIX and Linux)

---

Your administrator might have set up schedules to automatically back up files on your workstation. The following sections discuss how to back up files without using a schedule.

There are two types of incremental backup: *full incremental* and *partial incremental*.

- **AIX Linux Mac OS X Solaris** Full and partial incremental backup  
An incremental backup backs up only new and changed files. The type of incremental backup depends on what objects you select to be backed up.
- **AIX Linux Mac OS X Solaris** Incremental-by-date backup  
For a file system to be eligible for incremental-by-date backups, you must have performed at least one full incremental backup of that file system. Running an incremental backup of only a directory branch or individual file will not make the file system eligible for incremental-by-date backups.
- **AIX Linux Mac OS X Solaris** Comparing incremental-by-date, journal-based, and NetApp snapshot difference to full incremental and partial incremental backups  
Incremental-by-date, journal-based, and NetApp snapshot difference are alternatives to full incremental and partial incremental back methods.
- **AIX Linux Mac OS X Solaris** Snapshot differential backup with an HTTPS connection  
You can use a secure HTTPS connection for the backup-archive client to communicate with a NetApp filer during a snapshot differential backup.
- **AIX Linux Mac OS X Solaris** Selective backup  
Use a selective backup when you want to back up specific files or directories regardless of whether a current copy of those files exists on the server.
- **Solaris** Solaris global zone and non-global zones backups  
For Solaris zones, perform incremental and selective backups of file systems within the zone where these file systems were created.
- **Mac OS X AIX Linux Solaris** Saving access permissions  
When you back up your files, the backup-archive client also saves standard UNIX access permissions assigned to the files.
- **Mac OS X AIX Linux Solaris** Setting a virtual mount point  
If you are an authorized user and you want to back up files beginning with a specific directory within a file system, you can define that directory as a virtual mount point.
- **Mac OS X AIX Linux Solaris** Backing up data using the Java GUI  
You can back up specific files, entire directories, or entire file systems from the directory tree.
- **Mac OS X AIX Linux Solaris** Backing up data using the command line  
You can use the incremental or selective commands to perform backups.
- **Mac OS X AIX Linux Solaris** Deleting backup data  
If your administrator has given you authority, you can delete individual backup copies from the IBM Spectrum Protect server without deleting the entire file space. To determine if you have this authority, select File > Connection Information from the backup-archive client GUI or web client main menu. Your authority status is provided in the Delete Backup Files field.
- **AIX Linux Solaris Mac OS X** Deleting file spaces  
If your IBM Spectrum Protect administrator gives you authority, you can delete entire file spaces from the server. When you delete a file space, you delete all the files and images, both backup versions and archive copies, that are contained within the file space. For example, if you delete the `/tmp` file space, you are deleting every backup for every file in that file system and every file you archived from that file system. Carefully consider whether you want to delete a file space.

#### Related tasks:

Setting the client scheduler process to run as a background task and start automatically at startup

## Full and partial incremental backup

---

An incremental backup backs up only new and changed files. The type of incremental backup depends on what objects you select to be backed up.

**Mac OS X AIX Linux Solaris** If you select entire file systems, the backup is a full incremental backup. If you select a directory tree or individual files, the backup is a partial incremental backup.

**Windows** If you select entire drives, the backup is a full incremental backup. If you select a directory tree or individual files, the backup is a partial incremental backup.

The first time that you run a full incremental backup, the backup-archive client backs up all the files and directories that you specify. The backup operation can take a long time if the number of files is large, or if one or more large files must be backed up. Subsequent full incremental backups only back up new and changed files. The backup server maintains current versions of your files without having to waste time or space by backing up files that exist in IBM Spectrum Protect™ server storage.

**Mac OS X | AIX | Linux | Solaris | Windows** Depending on your storage management policies, the IBM Spectrum Protect server might keep more than one version of your files in storage. The most recently backed up files are active backup versions. Older copies of your backed up files are inactive versions. However, if you delete a file from your workstation, the next full incremental backup causes the active backup version of the file to become inactive. You can restore an inactive version of a file. The number of inactive versions that are maintained by the server and how long they are retained is governed by the management policies that are defined by your IBM Spectrum Protect server administrator. The active versions represent the files that existed on your file system at the time of the last backup.

**Mac OS X | AIX | Linux | Solaris | Windows** To start a full or partial incremental backup by using the client GUI, select Backup, and then select the Incremental (complete) option. From the command line, use the incremental command and specify file systems, directory trees, or individual files to include in the backup.

**Mac OS X | AIX | Linux | Solaris | Windows** During an incremental backup, the client queries the server or the journal database to determine the exact state of your files since the last incremental backup. The client uses this information for the following tasks:

- Back up new files.
- Back up files whose contents changed since the last backup.

**Windows** Files are backed up when any of the following attributes change:

- File size
- Date or time of last modification
- Extended Attributes
- Access Control List
- Sparse, reparse point or encrypted file attributes.
- NTFS or ReFS file security descriptors: Owner Security Identifier (SID), Group SID, Discretionary Access Control List (ACL), and System ACL.
- Directory attributes

If only the following attributes change, the attributes are updated on the IBM Spectrum Protect server, but the file is not backed up:

- Read-only or read/write
- Hidden or not hidden
- Compressed or not compressed

The archive attribute is not examined by IBM Spectrum Protect in determining changed files.

**Mac OS X | AIX | Linux | Solaris** Files are backed up when any of the following attributes change:

- File size
- Date or time of last modification
- Extended Attributes
- Access Control List

If only the following attributes change, the attributes are updated on the IBM Spectrum Protect server, but the file is not backed up:

- File owner
- File permissions
- Inode
- Group ID
- **AIX | Linux** Change time (`ctime`) attribute (for objects in GPFS file systems only and if the `updatectime` option is set to yes). For more details, see the `updatectime` option.
- Icon location (Mac OS X only)
- Type or creator (Mac OS X only)

- Back up directories.

A directory is backed up in any of the following circumstances:

- The directory was not previously backed up.
- The directory permissions changed since the last backup.
- The directory Access Control List changed since the last backup.
- The directory Extended Attributes changed since the last backup.
- **AIX | Linux** The change time (`ctime`) attribute is updated since the last backup (for GPFS file systems only). For more details, see the `updatectime` option.

**Mac OS X | AIX | Linux | Solaris | Windows** Directories are counted in the number of objects that are backed up. To exclude directories and their contents from backup, use the `exclude.dir` option.

- **Mac OS X | AIX | Linux | Solaris | Windows** Expire backup versions of files on the server that do not have corresponding files on the workstation. The result is that files that no longer exist on your workstation do not have active

backup versions on the server. However, inactive versions are retained according to rules defined by the IBM Spectrum Protect administrator.

- Rebind backup versions if management class assignments change. Only objects that have active backup versions are bound again. Objects for which only inactive backup versions exist are not bound again.

During a partial incremental backup operation, objects are rebound or expired as follows:

If the file specification matches all files in a path:

Rebinding and expiration occurs for all eligible backup versions that match the file specification. This is the case for an incremental command like `dsmc incr c:\mydir\* -subdir=yes`.

If the file specification does not match all files in a path:

Rebinding and expiration occurs for all eligible backup versions that match the file specification. However, eligible backup versions are not expired or rebound if they were in a directory that no longer exists on the client file system.

Consider an incremental command like `dsmc incr c:\mydir\*.txt -subdir=yes`. Assume that some files in `c:\mydir\` do not have the `txt` file type. Rebinding and expiration occurs only for files that match the `*.txt` specification and whose directories still exist on the client file system.

**Mac OS X** **AIX** **Linux** **Solaris** **Windows** You can use the `preservelastaccessdate` option to specify whether to modify the last access date after a backup or archive operation. By default, the access date changes after a backup or archive operation.

- **AIX** Journal-based backup on AIX and Linux  
Journal-based backup is an alternate method of backup that uses a change journal maintained by the IBM Spectrum Protect journal daemon process.

#### Related concepts:

Storage management policies

#### Related reference:

Exclude options

**Mac OS X** **AIX** **Linux** **Solaris** **Windows** `Preservelastaccessdate`  
**AIX** **Linux** `Updatectime`

## Incremental-by-date backup

For a file system to be eligible for incremental-by-date backups, you must have performed at least one full incremental backup of that file system. Running an incremental backup of only a directory branch or individual file will not make the file system eligible for incremental-by-date backups.

**Windows** To perform an incremental-by-date backup using the GUI, select the incremental (date only) option from the *type of backup* pull-down menu or use the `incrbydate` option with the incremental command.

The client backs up only those files whose modification date and time is later than the date and time of the last incremental backup of the file system on which the file resides. Files added by the client after the last incremental backup, but with a modification date earlier than the last incremental backup, are not backed up.

Files that were renamed after the last incremental backup, but otherwise remain unchanged, will not be backed up. Renaming a file does not change the modification date and time of the file. However, renaming a file does change the modification date of the directory in which it is located. In this case, the directory is backed up, but not the files it contains.

If you run an incremental-by-date backup of the whole file system, the server updates the date and time of the last incremental backup. If you perform an incremental-by-date backup on only part of a file system, the server does not update the date of the last full incremental backup. In this case, the next incremental-by-date backup backs up these files again.

Note: Unlike incremental backups, incremental-by-date backups do not expire deleted files or rebind backup versions to a new management class if you change the management class.

#### Related tasks:

**AIX** **Linux** **Mac OS X** **Solaris** Backing up data using the Java GUI  
**Windows** **AIX** **Linux**

## Comparing incremental-by-date, journal-based, and NetApp snapshot difference to full incremental and partial incremental backups

Incremental-by-date, journal-based, and NetApp snapshot difference are alternatives to full incremental and partial incremental back methods.

### Incremental-by-date backup

An incremental-by-date backup takes less time to process than a full incremental backup and requires less memory.

An incremental-by-date backup might not place exactly the same backup files into server storage because the incremental-by-date backup:

- **Mac OS X | AIX | Linux | Solaris | Windows** Does not expire backup versions of files that you delete from the workstation.
- Does not rebind backup versions to a new management class if you change the management class.
- Does not back up files with attributes that change, unless the modification dates and times also change.
- **Mac OS X | AIX | Linux | Solaris | Windows** Ignores the copy group frequency attribute of management classes (Journal-based backups also ignore this attribute).

### Journal-based backup

**AIX | Linux | Windows** The memory requirements for an initial journaling environment are the same as the memory requirements for a full file space incremental, because journal-based backups must complete the full file space incremental in order to set the journal database as valid, and to establish the baseline for journaling.

**AIX | Linux | Windows** The memory requirements for subsequent journal-based backups are much less. Journal backup sessions run in parallel and are governed by the resourceutilization client option in the same manner as normal backup sessions. The size of the journal database file reverts to a minimal size (less than 1 KB) when the last entry has been deleted from the journal. Since entries are deleted from the journal as they are processed by the client, the disk size occupied by the journal should be minimal after a complete journal backup. A full incremental backup with journaling active takes less time to process than an incremental-by-date backup.

**AIX | Linux** On AIX and Linux, journal-based backup does have some limitations. See Journal-based backup on AIX and Linux for information.

### NetApp snapshot difference

**Linux | Windows** For NAS and N-Series file servers that are running ONTAP 7.3.0, or later, you can use the snapdiff option to invoke the snapshot difference backup from NetApp when running a full-volume incremental backup. Using this option reduces memory usage and is faster.

**Linux | Windows** Consider the following restrictions when running a full-volume incremental backup using the snapdiff option, to ensure that data is backed up when it should be.

- A file is excluded due to an exclude rule in the include-exclude file. The client runs a backup of the current snapshot with that exclude rule in effect. This happens when you have not made changes to the file, but you have removed the rule that excluded the file. NetApp will not detect this include-exclude change because it only detects file changes between two snapshots.
- If you added an include statement to the option file, that include option does not take effect unless NetApp detects that the file has changed. The client does not inspect every file on the volume during backup.
- If you used the dsmc delete backup command to explicitly delete a file from the IBM Spectrum Protect inventory, NetApp cannot detect that a file was manually deleted from IBM Spectrum Protect storage. Therefore, the file remains unprotected in IBM Spectrum Protect storage until it is changed on the volume and the change is detected by NetApp, which signals the client to back it up again.
- Policy changes such as changing the policy from mode=modified to mode=absolute are not detected.
- The entire file space is deleted from the IBM Spectrum Protect inventory. This action causes the snapdiff option to create a new snapshot to use as the source, and a full incremental backup to be run.

The NetApp software determines what is a changed object, not IBM Spectrum Protect.

**Linux** If you run a full volume backup of an NFS-mounted NetApp or N-Series volume, all the snapshots under the snapshot directory might also be backed up.

To avoid backing up all snapshots under the snapshot directory, do one of the following actions:

- Run NDMP backups
- Run backups using the snapshotroot option
- Run incremental backups using the snapdiff option

Tip: If you run an incremental backup using the `snappdiff` option and you schedule periodic incremental backups, use the `creatnewbase=yes` option with the `snappdiff` option to create a base snapshot and use it as a source to run an incremental backup.

- Exclude the snapshot directory from backups.

**Linux** On Linux systems, the snapshot directory is in `.snapshot`.

Note: The `.snapshot` directory is not backed up for some versions of Red Hat Linux, so you are not required to exclude it.

**Windows** On Windows systems, the snapshot directory is in `~snapshot`.

**Linux**

## Snapshot differential backup with an HTTPS connection

---

You can use a secure HTTPS connection for the backup-archive client to communicate with a NetApp filer during a snapshot differential backup.

The HTTPS protocol is enabled on NetApp filers by default and cannot be disabled.

When you run a snapshot differential backup, the backup-archive client establishes an administrative session with a NetApp filer. The filer credentials, such as the filer host name or IP address, the user name that is used to connect to the filer, and the filer password, are stored locally on the backup-archive client. This information must be transmitted to the filer to establish the authenticated administrative session. It is important to use a secure connection because authenticating the administrative filer session requires the client to transmit the filer password in clear text.

To establish a secure connection by using the HTTPS communication protocol, you must use the `snappdiffhttps` option whenever you run a snapshot differential backup. Without the `snappdiffhttps` option, the backup-archive client can establish filer sessions only with the HTTP protocol, which would require HTTP administrative access to be enabled on the filer. With the `snappdiffhttps` option, you can establish a secure administrative session with the NetApp filer regardless of whether HTTP administrative access is enabled on the NetApp filer.

Restrictions:

The following restrictions apply to snapshot differential backups with HTTPS:

- The HTTPS connection is used only to securely transmit data over the administrative session between the backup-archive client and the NetApp filer. The administrative session data includes information such as filer credentials, snapshot information, and file names and attributes that are generated by the snapshot differencing process. The HTTPS connection is not used to transmit normal file data that is accessed on the filer by the client through file sharing. The HTTPS connection also does not apply to normal file data transmitted by the client to the IBM Spectrum Protect™ server through the normal IBM Spectrum Protect client/server protocol.
- The `snappdiffhttps` option does not apply to vFilers because the HTTPS protocol is not supported on the NetApp vFiler.
- The `snappdiffhttps` option is available only by using the command-line interface. It is not available for use with the backup-archive client GUI.

- **AIX** **Linux** **Mac OS X** **Solaris** Running a snapshot differential backup with an HTTPS connection  
When you run a snapshot differential backup, you can use the `snappdiffhttps` option to create a secure HTTPS connection between the backup-archive client and the NetApp filer.

### Related concepts:

**Windows** Comparing incremental-by-date, journal-based, and NetApp snapshot difference to full incremental and partial incremental backups

### Related tasks:

Configuring NetApp and IBM Spectrum Protect for snapshot difference incremental backups

**Windows** Running a snapshot differential backup with an HTTPS connection

**Linux** Running a snapshot differential backup with an HTTPS connection

### Related reference:

`Snappdiffhttps`

`Snappdiff`

## Selective backup

---

Use a selective backup when you want to back up specific files or directories regardless of whether a current copy of those files exists on the server.

Incremental backups are generally part of an automated system to back up entire file systems. In contrast, selective backups allow you to manually select a set of files to back up regardless of whether they have changed since your last incremental backup.

Unlike incremental backups, a selective backup provides the following:

- Does not cause the server to update the date and time of the last incremental.
- Backs up directory and file entries even if their size, modification timestamp, or permissions have not changed.
- Does not expire deleted files.
- Does not rebind backup versions to a new management class if you change the management class.

**Related tasks:**

[Windows](#) Backing up data using the GUI

[Mac OS X](#) [AIX](#) [Linux](#) [Solaris](#) Backing up data using the Java GUI

**Related reference:**

Selective

[Solaris](#)

## Solaris global zone and non-global zones backups

---

For Solaris zones, perform incremental and selective backups of file systems within the zone where these file systems were created.

Treat each non-global zone as a separate system that has its own IBM Spectrum Protect™ node name and run backups from within each of the zones.

If you run incremental or selective backups of non-global zones from the global zone, the global-zone administrator must decide which files in the non-global zone are included or excluded in backups. For example, device, system and kernel files of the non-global zones are not automatically excluded from backups, but they must not be backed up. Restoring such files can make a non-global zone unusable.

[Mac OS X](#) [AIX](#) [Linux](#) [Solaris](#)

## Saving access permissions

---

When you back up your files, the backup-archive client also saves standard UNIX access permissions assigned to the files.

Depending on your operating system, it also saves extended permissions. For example, for files on an AIX® workstation, the client saves access control lists.

It is possible for an authorized user to back up files for another user, but this should not cause ownership conflicts. The backup server properly records that the file belongs to the original owner. The authorized user does not need to grant the original owner access to the backup versions.

[Mac OS X](#) [AIX](#) [Linux](#) [Solaris](#)

## Setting a virtual mount point

---

If you are an authorized user and you want to back up files beginning with a specific directory within a file system, you can define that directory as a virtual mount point.

Defining a virtual mount point within a file system provides a direct path to the files you want to back up, saving processing time. It is more efficient than defining the file system with the domain option and then using an exclude option to exclude the files you do not want to back up. It also allows you to store backups and archives for specific directories in separate storage file spaces.

**Related reference:**

[AIX](#) [Linux](#) [Mac OS X](#) [Solaris](#) Virtualmountpoint

[Mac OS X](#) [AIX](#) [Linux](#) [Solaris](#)

## Backing up data using the Java GUI

---



You can back up specific files, entire directories, or entire file systems from the directory tree.

## About this task

You can locate the files you want to back up by searching or filtering. Filtering displays only the files matching the filter criteria for your backup.

Use the backup-archive client Java™ GUI to back up your data as follows:

## Procedure

1. Click **Backup** in the IBM Spectrum Protect™ window. The Backup window appears.
2. Expand the directory tree if necessary. Click on the selection boxes next to the object or objects you want to back up. To search or filter files, click the **Find** icon on the tool bar.
3. Enter your search criteria in the Find Files (Backup) window.
4. Click the **Search** button. The Matching Files (Backup) window appears.
5. Click the selection boxes next to the files you want to back up and close the Matching Files (Backup) window.
6. Enter your filter criteria in the Find Files (Backup) window.
7. Click the **Filter** button. The Backup window displays the filtered files.
8. Click the selection boxes next to the filtered files or directories you want to back up.
9. Select one of the following backup types from the pull-down menu: (1) To run an incremental backup, click **Incremental (complete)**, (2) To run an incremental-by-date backup, click **Incremental (date only)**, (3) To run a selective backup, click **Always backup**.
10. Click **Backup**. The Backup **Task List** window displays the backup processing status.

## Results

Consider the following items when you back up your data using the Java GUI.

- To modify specific backup options, click the **Options** button. The options you select are effective during the current session *only*.
- IBM Spectrum Protect uses management classes to determine how to manage your backups on the server. Every time you back up a file, the file is assigned a management class. The management class used is either a default selected for you, or one that you assign to the file using an *include* option in the include-exclude options list. Select **Utilities → View Policy Information** from the backup-archive client Java GUI or web client GUI to view the backup policies defined by the IBM Spectrum Protect server for your client node.
- To perform an automatic incremental backup of your default domain, select **Actions → Backup Domain**. Your default domain is set with the *domain* option in your client user-options file (dsm.opt). If you do not have the *domain* option set, the default domain is *all local file systems*.
- You can use the Preferences editor to exclude file systems in your default domain from backup processing.

### Related concepts:

Storage management policies

### Related reference:

Domain

Mac OS X | AIX | Linux | Solaris

## Backing up data using the command line

You can use the incremental or selective commands to perform backups.

The following table shows examples of using these commands to perform different tasks.

Table 1. Command-line backup examples

Task	Command	Considerations
<i>Incremental backups</i>		
Perform an incremental backup of your client domain.	<code>dsmc incremental</code>	See Incremental for more information about the incremental command.



<b>Task</b>	<b>Command</b>	<b>Considerations</b>
Back up the /fs1 and /fs2 file systems in addition to the /home, /usr, and /datasave file systems defined in your client domain.	<code>dsmc incremental -domain="/fs1 /fs2"</code>	See Domain for more information about the domain option.
Back up the /Volumes/fs1 and /Volumes/fs2 file systems in addition to the volumes defined in your client domain.	<code>dsmc incremental -domain="/Volumes/fs1 /Volumes/fs2"</code>	See Domain for more information about the domain option.
Back up all local file systems defined in your client domain except for the /home file system.	<code>dsmc incremental -domain="all-local -/home"</code>	You cannot use the (-) operator in front of the domain keyword all-local. See Domain for more information. For Windows clients, you can also exclude the system state domain from backup processing in this way.
Back up only the /fs1 and /fs2 file systems.	<code>dsmc incremental /fs1 /fs2</code>	None
Back up all files in the /home directory and all its subdirectories.	<code>dsmc incremental /home/ -subdir=yes</code>	See Subdir for more information about the subdir option.
Back up all files in the /Users directory and all its subdirectories.	<code>dsmc incremental /Users/ -subdir=yes</code>	See Subdir for more information about the subdir option.
Assuming that you initiated a snapshot of the /usr file system and mounted the snapshot as /snapshot/day1, run an incremental backup of all files and directories under the local snapshot and manage them on the IBM Spectrum Protect™ server under the file space name /usr.	<code>dsmc incremental /usr -snapshotroot=/snapshot/day1</code>	The backup-archive client considers the snapshotroot value as a file space name. See Snapshotroot for more information.
<i>Incremental-by-date backup</i>		
Perform an incremental-by-date backup of your default client domain.	<code>dsmc incremental -incrbydate</code>	Use the incrbydate option with the incremental command to back up new and changed files with a modification date later than the last incremental backup stored at the server. See Incrbydate for more information about the incrbydate option.
<i>Selective backups</i>		
Back up all files in the /home/proj or /Users/van/Documents directory.	<code>dsmc selective /home/proj/ or dsmc selective /Users/van/Documents/</code>	Use the selective command to back up specific files or directories regardless of whether they have changed since your last incremental backup. You can use wildcards to back up multiple files at once. See Selective for more information about the selective command.

Task	Command	Considerations
Back up all files in the /home/proj directory and all its subdirectories.	<code>dsmc selective /home/proj/ -subdir=yes</code>	<p>If you specify <code>-subdir=yes</code> when backing up a specific path and file, the client recursively backs up all subdirectories under that path, and any instances of the specified file that exist under any of those subdirectories.</p> <p>If a subdirectory is a mounted file system, the client does not back up the files in that subdirectory when you use the <code>subdir=yes</code> option. See <code>Subdir</code> for more information about the <code>subdir</code> option.</p>
Back up all files in the /Users/van/Documents directory and all its subdirectories.	<code>dsmc selective /Users/van/Documents/ -subdir=yes</code>	<p>If you specify <code>-subdir=yes</code> when backing up a specific path and file, the client recursively backs up all subdirectories under that path, and any instances of the specified file that exist under any of those subdirectories.</p> <p>If a subdirectory is a mounted file system, the client does not back up the files in that subdirectory when you use the <code>subdir=yes</code> option. See <code>Subdir</code> for more information about the <code>subdir</code> option.</p>
Back up the /home/dir1/h1.doc and /home/dir1/test.doc files.	<code>dsmc selective /home/dir1/h1.doc /home/dir1/test.doc</code>	If you specify the <code>removeoperandlimit</code> option with the incremental or selective commands, the 20-operand limit is not enforced and is restricted only by available resources or other operating system limits. This allows you to specify more than 20 files on a single command. See <code>Removeoperandlimit</code> for more information about this option.
Back up the /Users/ann/Documents/h1.doc and /Users/ann/Documents/test.doc files.	<code>dsmc selective /Users/ann/Documents/h1.doc /Users/ann/Documents/test.doc</code>	If you specify the <code>removeoperandlimit</code> option with the incremental or selective commands, the 20-operand limit is not enforced and is restricted only by available resources or other operating system limits. This allows you to specify more than 20 files on a single command. See <code>Removeoperandlimit</code> for more information about this option.
Back up a list of files in the /home/filelist.txt file.	<code>selective -filelist=/home/filelist.txt</code>	Use the <code>filelist</code> option to process a list of files. See <code>Filelist</code> for more information.
Back up all files listed in the /Users/filelist.txt file.	<code>dsmc selective -filelist=/Users/filelist.txt</code>	Use the <code>filelist</code> option to process a list of files. See <code>Filelist</code> for more information.
Assuming that you initiated a snapshot of the /usr file system and mounted the snapshot as /snapshot/day1, run a selective backup of the /usr/dir1/sub1 directory tree from the local snapshot and manage it on the IBM Spectrum Protect server under the file space name /usr.	<code>dsmc selective /usr/dir1/sub1/ -subdir=yes -snapshotroot=/snapshot/day1</code>	The client considers the <code>snapshotroot</code> value as a file space name. See <code>Snapshotroot</code> for more information.

**Related reference:**

Incremental  
Selective

Mac OS X    AIX    Linux    Solaris

## Deleting backup data

---

If your administrator has given you authority, you can delete individual backup copies from the IBM Spectrum Protect™ server without deleting the entire file space. To determine if you have this authority, select File > Connection Information from the backup-archive client GUI or web client main menu. Your authority status is provided in the Delete Backup Files field.

### About this task

---

**Important:** When you delete backup files, *you cannot restore them*. Verify that the backup files are no longer needed before you delete them. The client prompts whether you want to continue with the delete. If you specify *yes*, the specified backup files are immediately deleted and removed from IBM Spectrum Protect server storage.

To delete backup copies using the backup-archive client GUI or web client:

### Procedure

---

1. Select **Delete Backup Data** from the **Utilities** menu. The Backup Delete window appears.
2. Expand the Directory tree by clicking the plus sign (+) or folder icon next to the object you want to expand.
3. Click the selection boxes next to objects that you want to delete.
4. Select an item from the drop-down list near the top of the **Backup Delete** window to specify the type of backup delete to perform. You can delete active backup versions, inactive backup versions, or all objects that you have selected in the tree.

### Results

---

Note:

1. A directory is deleted only if you select **Delete All Objects**.
2. To delete backup copies using the command line client, use the delete backup command.

**Related reference:**

Delete Backup



## Deleting file spaces

---

If your IBM Spectrum Protect™ administrator gives you authority, you can delete entire file spaces from the server. When you delete a file space, you delete all the files and images, both backup versions and archive copies, that are contained within the file space. For example, if you delete the `/tmp` file space, you are deleting every backup for every file in that file system and every file you archived from that file system. Carefully consider whether you want to delete a file space.

### About this task

---

You can also delete a file space using the delete filespace command. Use the class option with the delete filespace command to delete NAS file spaces.

You can delete individual backup versions by using the delete backup command.

You can delete file spaces using the backup-archive client GUI or command line clients. To delete NAS file spaces, use the web client or command line client.

To delete a file space using the GUI, perform the following steps:

### Procedure

---

1. Select Utilities > Delete Filespaces from the main window.
2. Click the selection boxes next to the file spaces you want to delete.
3. Click the Delete button. The client prompts you for confirmation before deleting the file space.

**Related reference:**

Class

Delete Backup

Delete Filespace

## Backing up files from one or more file spaces for a group backup (Windows)

Use the backup group command to create and back up a group from a list of files from one or more file space origins to a virtual file space on the IBM Spectrum Protect™ server.

### About this task

A *group backup* creates a consistent point-in-time backup of a group of files that is managed as a single logical entity:

- All objects in the group are assigned to the same management class. Use the include option to bind a group to a management class.
- Existing exclude statements for any files in the group are ignored.
- All objects in the group are exported together.
- All objects in the group are expired together as specified in the management class. No objects in a group are expired until all other objects in the group are expired, even when another group they belong to gets expired.

A group backup can be added to a backup set.

You can perform a full or differential backup by using the mode option.

### Procedure

Enter the backup group command to start a group backup.

For example, to perform a full backup of all the files in the `c:\dir1\filelist1` file to the virtual file space `\virtfs`, containing the group leader `c:\group1` file, enter the following command:

```
dsmc backup group -filelist=c:\dir1\filelist1 -groupname=group1 -virtualfsname=\virtfs -mode=full
```

#### Related concepts:

Restore data from a backup set

#### Related reference:

Backup Group

Include options

Mode

Mac OS X | AIX | Linux | Solaris

## Backing up files from one or more file spaces for a group backup (UNIX and Linux)

You can use the backup group command to create and back up a group containing a list of files from one or more file space origins to a virtual file space on the IBM Spectrum Protect™ server.

**Restriction:** The backup group command does not apply to Mac OS X.

A *group backup* allows you to create a consistent point-in-time backup of a group of files that is managed as a single logical entity:

- All objects in the group are assigned to the same management class.
- Existing *exclude* statements for any files in the group are ignored.
- All objects in the group are exported together.
- All objects in the group are expired together as specified in the management class. No objects in a group are expired until all other objects in the group are expired, even when another group they belong to gets expired.

A group backup can be added to a backup set.

You can perform a full or differential backup using the mode option.

For example, to perform a full backup of all the files named in the `/home/dir1/filelist1` file to the virtual file space `/virtfs` containing the group leader `/home/group1` file, enter:

```
dsmc backup group -filelist=/home/dir1/filelist1 -groupname=group1 -virtualfsname=
/virtfs -mode=full
```

**Related concepts:**

Restore data from a backup set

**Related reference:**

Backup Group

Include options

Mode

Windows

## Backing up data with client-node proxy support (Windows)

---

Backups of multiple nodes that share storage can be consolidated to a common target node name on the IBM Spectrum Protect™ server.

### Before you begin

---

The following considerations apply when you use a proxy node to back up or restore data on other nodes:

- A proxy operation uses the settings for the target node (such as maxnummp and deduplication) and schedules that are defined on the IBM Spectrum Protect server. The IBM Spectrum Protect server node settings and schedules for the agent node are ignored.
- You cannot use asnodename with the backup nas command.
- You cannot use asnodename with the fromnode option.
- If you use asnodename to backup and restore volumes that are in a cluster configuration, do not use clusternode yes.
- You cannot use asnodename to back up or restore system state.
- If an agent node restores data from a backup set, the system state object in the backup set is not restored.
- You can use asnodename with the backup image command, but you must specify the volume by UNC name. You cannot use the drive letter.
- If you use the same asnodename value to back up files from different machines, you need to keep track which files or volumes are backed up from each system so that you can restore them to the correct location.
- All agent nodes in a multiple node environment should be of the same platform type.
- Do not use target nodes as traditional nodes, especially if you encrypt your files before backing them up to the server.

### About this task

---

An *agent node* is a client node which has been granted authority to perform client operations on behalf of a target node.

A *target node* is a client node which grants authority to one (or more) agent nodes to perform client operations on its behalf.

Using an agent node to backup target nodes is useful when the workstation responsible for performing the backup can change over time, such as with a cluster configuration.

The asnodename option allows data to be restored from a different system than the one which performed the backup.

Use the asnodename option with the appropriate command to back up, archive, restore, and retrieve data under the target node name on the IBM Spectrum Protect server. This support is only available with IBM Spectrum Protect Version 5.3 and higher server and client.

### Procedure

---

To enable this option, follow these steps:

1. Install the backup-archive client on all nodes in a shared data environment.
2. Register each node with the IBM Spectrum Protect server, if it does not exist. Register the common target node name to be shared by each of the agent nodes used in your shared data environment.
3. Register each of the nodes in the shared data environment with the IBM Spectrum Protect server. This is the agent node name that is used for authentication purposes. Data will not be stored using the node name when the asnodename option is used.
4. Grant proxy authority to all nodes in the shared environment to access the target node name on the IBM Spectrum Protect server, using the GRANT PROXYNODE command (IBM Spectrum Protect administrator).

5. Use the QUERY PROXYNODE administrative client command to display the client nodes of the authorized user, granted by the GRANT PROXYNODE command.

- **Windows** Enabling multiple node operations from the GUI  
To enable multinode operations in the GUI, use the Preferences editor to specify the name of the target node to which you have been granted proxy authority.
- **Windows** Setting up encryption  
This topic lists the steps that you must follow to set up encryption with the encryptkey option.
- **Windows** Scheduling backups with client-node proxy support  
Multiple nodes can be used to perform backup operations using the scheduler.

**Related reference:**

Asnodename

**Windows** | **Mac OS X** | **AIX** | **Linux** | **Solaris**

## Enabling multiple node operations from the GUI

---

To enable multinode operations in the GUI, use the Preferences editor to specify the name of the target node to which you have been granted proxy authority.

### Procedure

---

1. Verify that the client node has proxy authority to a target node (or authorized to act as the target node) by using the QUERY PROXYNODE administrative client command.
2. Select Edit > Client Preferences to open the preferences window.
3. Select the General tab and fill in the As Node Name field with the name of the target node.
4. Click Apply and then OK to close the preferences window.

### What to do next

---

Perform one of the following steps to verify that your client node is now accessing the server as the target node:

- Open the tree window and check that the target node name specified by the As Node Name field appears.
- Verify the target node name in the Accessing As Node field in the Connection Information window.

To return to single node operation, delete the As Node Name from the Accessing As Node field in the General > Preferences tab.

**Windows**

## Setting up encryption

---

This topic lists the steps that you must follow to set up encryption with the encryptkey option.

### Procedure

---

1. Specify `encryptkey=save` in the options file.
2. Back up at least one file with `asnode=ProxyNodeName` to create a local encryption key on each agent node in the multiple node environment.

### Results

---

Follow these steps to set up encryption with the `encryptkey=prompt` option:

1. Specify `encryptkey=prompt` in the options file.
2. Ensure that users of the agent nodes in the multiple node environment are using the same encryption key.

**Important:**

- If you change the encryption key, you must repeat the previous steps.
- Use the same encryption key for all files backed up in the shared node environment.

**Windows**

## Scheduling backups with client-node proxy support

---

Multiple nodes can be used to perform backup operations using the scheduler.

### About this task

---

When you grant proxy authority to the agent nodes, they perform scheduled backup operation on behalf of the target node. Each agent node must use the `asnodename` option within their schedule to perform multiple node backup for the agent node.

Perform the following steps to enable scheduling of multiple nodes:

1. Ensure that all agent nodes must have proxy authority over the common target node
2. Ensure that all agent nodes must have a schedule defined on the server:

```
def sched domain_name sched_name options='-asnode=target'
```

3. Ensure that each agent node must have its schedule associated with a node:

```
def association domain_name schedule_name <agentnodename>
```

The following examples show the administrative client-server commands using the scheduler on multiple nodes.

- The administrator registers all the nodes to be used, by issuing the following commands:
  - `register node NODE-A`
  - `register node NODE-B`
  - `register node NODE-C`
- The administrator grants proxy authority to each agent node, by issuing the following commands:
  - `grant proxynode target=NODE-Z agent=NODE-A`
  - `grant proxynode target=NODE-Z agent=NODE-B`
  - `grant proxynode target=NODE-Z agent=NODE-C`
- The administrator defines the schedules, by issuing the following commands:
  - `define schedule standard proxy1 description="NODE-A proxy schedule" action=incremental options="-asnode=NODE-Z" objects=C: startdate=05/21/2005 starttime=01:00`
  - `define schedule standard proxy2 description="NODE-B proxy schedule" action=incremental options="-asnode=NODE-Z" objects=D: startdate=05/21/2005 starttime=01:00`
  - `define schedule standard proxy3 description="NODE-C proxy schedule" action=incremental options="-asnode=NODE-Z" objects=E: startdate=05/21/2005 starttime=01:00`

Note: Place the `asnodename` option in the schedule definition only. Do not place it in the client options file, on the command line, or in any other location.

Start the schedules by either configuring a scheduler service, or by using the following client command: `dsmc sched`

You can also use the client acceptor, with `managedservices` set to `schedule` in the systems options file.

Important:

- Each schedule can be started from a different workstation or LPAR.
- After running the schedules, any proxied client can query and restore all the backed up data.
- A proxy operation uses the settings for the target node (such as `maxnummp` and `deduplication`) and schedules that are defined on the IBM Spectrum Protect™ server. The IBM Spectrum Protect server node settings and schedules for the agent node are ignored.

#### Related reference:

Asnodename

Session settings and schedules for a proxy operation

DEFINE SCHEDULE command

Mac OS X | AIX | Linux | Solaris

## Backing up data with client-node proxy support (UNIX and Linux)

---

Backups of multiple nodes that share storage can be consolidated to a common target node name on the IBM Spectrum Protect™ server.

### About this task

---

Consolidating backups from multiple nodes to a common target node name on the server is helpful in configurations where the workstation that is responsible for performing the backups can change over time, such as within a cluster.

An agent node is a client node that is granted authority to perform client operations on behalf of a target node.

A target node is a client node that grants authority to one or more agent nodes to perform client operations on its behalf.

Use the `asnodename` option with the appropriate command to back up, archive, restore, and retrieve data under the target node name on the server.

The `asnodename` option also allows data to be restored from a different system than the one that performed the backup.

Consider the following features when you use a proxy node to back up or restore data on other nodes:

- A proxy operation uses the settings for the target node (such as `maxnummp` and deduplication) and schedules that are defined on the IBM Spectrum Protect server. The IBM Spectrum Protect server node settings and schedules for the agent node are ignored.
- All of the agent nodes in the multiple node environment must be running the same operating system type.
- Do not use target nodes as traditional nodes, especially if you encrypt your files before you back them up to the server.
- You cannot access another node (either from the GUI drop-down or by using the `fromnode` option).
- You cannot perform NAS backup or restore.

## Procedure

---

1. Install the backup-archive client on all nodes in a shared data environment.
2. Register each node with the IBM Spectrum Protect server. Register the common target node name to be shared by each of the agent nodes that are used in your shared data environment.
3. Register each of the nodes in the shared data environment with the IBM Spectrum Protect server. Register the agent node name that is used for authentication purposes. Data is not stored on the server, under that node name, when the `asnodename` option is used.
4. The IBM Spectrum Protect server administrator must grant proxy authority to all nodes in the shared environment to access the target node name by using the `GRANT PROXYNODE` command.
5. Use the `QUERY PROXYNODE` administrative client command to display the client nodes of the authorized user that was granted by the `GRANT PROXYNODE` command.

- **Mac OS X** | **AIX** | **Linux** | **Solaris** Enabling multiple node operations from the GUI

To enable multinode operations in the GUI, use the Preferences editor to specify the name of the target node to which you have been granted proxy authority.

- **Mac OS X** | **AIX** | **Linux** | **Solaris** Setting up encryption

This topic lists the steps that you must follow to set up encryption with the `encryptkey` option.

- **Mac OS X** | **AIX** | **Linux** | **Solaris** Scheduling backups with client-node proxy support

Multiple nodes can be used to perform backup operations using the scheduler.

### Related reference:

`Asnodename`

**Windows** | **Mac OS X** | **AIX** | **Linux** | **Solaris**

## Enabling multiple node operations from the GUI

---

To enable multinode operations in the GUI, use the Preferences editor to specify the name of the target node to which you have been granted proxy authority.

## Procedure

---

1. Verify that the client node has proxy authority to a target node (or authorized to act as the target node) by using the `QUERY PROXYNODE` administrative client command.
2. Select `Edit > Client Preferences` to open the preferences window.
3. Select the `General` tab and fill in the `As Node Name` field with the name of the target node.
4. Click `Apply` and then `OK` to close the preferences window.

## What to do next

---

Perform one of the following steps to verify that your client node is now accessing the server as the target node:



- Open the tree window and check that the target node name specified by the As Node Name field appears.
- Verify the target node name in the Accessing As Node field in the Connection Information window.

To return to single node operation, delete the As Node Name from the Accessing As Node field in the General > Preferences tab.



## Setting up encryption

This topic lists the steps that you must follow to set up encryption with the encryptkey option.

### Procedure

1. Specify encryptkey=save in the options file.
2. Back up at least one file with asnode=ProxyNodeName to create a local encryption key on each agent node in the multiple node environment.

### Results

Follow these steps to set up encryption with the encryptkey=prompt option:

1. Specify encryptkey=prompt in the options file.
2. Ensure that users of the agent nodes in the multiple node environment are using the same encryption key.

Important:

- If you change the encryption key, you must repeat the previous steps.
- Use the same encryption key for all files backed up in the shared node environment.



## Scheduling backups with client-node proxy support

Multiple nodes can be used to perform backup operations using the scheduler.

### About this task

When you grant proxy authority to the agent nodes, they perform scheduled backup operations on behalf of the target node. Each agent node must use the asnodename option within their schedule to perform multiple node backup for the agent node.

Start the schedules using `dsmc sched client` command:

The following examples show the administrative client-server commands using the scheduler on multiple nodes.

- The administrator registers all of the nodes to be used by issuing the following commands:
  - `register node NODE-A`
  - `register node NODE-B`
  - `register node NODE-C`
- The administrator grants proxy authority to each agent node using the following commands:
  - `grant proxynode target=NODE-Z agent=NODE-A`
  - `grant proxynode target=NODE-Z agent=NODE-B`
  - `grant proxynode target=NODE-Z agent=NODE-C`
-  The administrator defines the schedules using the following commands:
  - `define schedule standard proxy1 description="NODE-A proxy schedule" action=incremental options="-asnode=NODE-Z" objects=/Volumes/Xsan1 startdate=05/21/2005 starttime=01:00`
  - `define schedule standard proxy2 description="NODE-B proxy schedule" action=incremental options="-asnode=NODE-Z" objects=/Volumes/Xsan2 startdate=05/21/2005 starttime=01:00`
  - `define schedule standard proxy3 description="NODE-C proxy schedule" action=incremental options="-asnode=NODE-Z" objects=/Volumes/Xsan3 startdate=05/21/2005 starttime=01:00`

Note: Place the asnodename option in the schedule definition only. Do not place it in the client options file, on the command line, or in any other location.

You can also use the client acceptor daemon (dsmcad), with managedservices set to schedule in the systems options file.

Note:

- Each schedule can be started from a different workstation or LPAR.
- After running the schedules, any proxied client can query and restore all of the backed up data.
- A proxy operation uses the settings for the target node (such as maxnummp and deduplication) and schedules that are defined on the IBM Spectrum Protect™ server. The IBM Spectrum Protect server node settings and schedules for the agent node are ignored.
- |          |     |       |         |
|----------|-----|-------|---------|
| Mac OS X | AIX | Linux | Solaris |
|----------|-----|-------|---------|

 Examples of how to schedule a backup of an IBM PowerHA SystemMirror cluster  
This section shows lists some examples of how to back up an IBM® PowerHA® SystemMirror cluster.
- |     |       |
|-----|-------|
| AIX | Linux |
|-----|-------|

 Scheduling a backup of a GPFS file system  
Use the scheduler and proxy relationships to back up a GPFS™ file system.

**Related reference:**

Asnodename

Session settings and schedules for a proxy operation

DEFINE SCHEDULE command

Mac OS X	AIX	Linux	Solaris
----------	-----	-------	---------

## Examples of how to schedule a backup of an IBM PowerHA SystemMirror cluster

---

This section shows lists some examples of how to back up an IBM® PowerHA® SystemMirror cluster.

### About this task

---

Perform the following steps to enable scheduling of multiple nodes:

1. Ensure that all agent nodes must have proxy authority over the common target node
2. Ensure that all agent nodes must have a schedule defined on the server:

```
def sched domain_name sched_name options='-asnode=target'
```

3. Ensure that each agent node must have its schedule associated with a node:

```
def association domain_name schedule_name <agentnodename>
```

In the following examples, IBM PowerHA SystemMirror is configured for two AIX® hosts, *host\_a* and *host\_b*. Along with their own local data, the hosts are sharing disk storage which has two file spaces: */disk1* and */disk2*.

The CLUSTERNODE example shows how the *clusternode* option is used in a current IBM PowerHA SystemMirror environment.

- The administrator defines 3 nodes on the IBM Spectrum Protect™ server: *host\_a*, *host\_b*, *cluster\_group*, using the following commands: (1) REGISTER NODE *host\_a* *mysecretpa5s*, (2) REGISTER NODE *host\_b* *mysecretpa5s*, (3) REGISTER NODE *cluster\_group* *mysecretpa5s*.
- The administrator defines a *dsm.opt* file on *host\_a* and *host\_b* (note that the *opt* files are different on each host), using the following commands: (1) NODENAME *host\_a* (option can be left as default), (2) DOMAIN */home /usr ... etc..*
- The administrator defines a *dsm.opt* file located somewhere on one of the cluster disk groups, for example, */disk1/tsm/dsm.opt*, using the following commands: (1) NODENAME *cluster\_group*, (2) DOMAIN */disk1 /disk2*, (3) CLUSTERNODE YES.
- The administrator defines a schedule on the IBM Spectrum Protect server, using the following command: DEFINE SCHEDULE STANDARD CLUSTER\_BACKUP.
- The administrator defines associations for each of the 3 nodes, using the following command: DEFINE ASSOC STANDARD CLUSTER\_BACKUP *host\_a,host\_b,cluster\_group*. At any one time, there are three instances of the backup-archive client schedule running (with the scheduler for *cluster\_group* being part of the cluster resources that failover whenever the cluster group disk resources failover. Thus, it would be running on either *host\_a* or *host\_b* but not both simultaneously).
- All three node names contain data on the IBM Spectrum Protect server.

The ASNODE example shows a generic solution which could be applied to UNIX cluster solutions to which we do not have support, for example: Veritas Cluster Server for Solaris.

- The administrator defines 3 nodes on the IBM Spectrum Protect server *host\_a,host\_b,cluster\_group*:

```
REGISTER NODE host_a mysecretpa5s
REGISTER NODE host_b mysecretpa5s
REGISTER NODE cluster_group mysecretpa5s
```

- The administrator defines a proxy node relationship between `host_a` and `host_b` to `hacmp_cluster`

```
GRANT PROXYNODE TARGET=cluster_group AGENT=host_a,host_b
```

- The administrator defines a `dsm.opt` file on `host_a` and `host_b` to handle the local file systems:

```
NODENAME      host_a (option can be left as default)
DOMAIN        /home /usr ... etc.
```

```
NODENAME      host_b (option can be left as default)
DOMAIN        /home /usr ... etc.
```

- The administrator defines a `dsm.opt` file on the cluster resource to handle the backup of the clustered resources, e.g. `/disk1/tsm/dsmcluster.opt` (the `nodename` is the default `nodename`, which is either `host_a` or `host_b`, depending on which workstation contains the cluster group at any given time):

```
DOMAIN        /disk1 /disk2
ASNODE        cluster_group
```

- The administrator defines a schedule on the IBM Spectrum Protect server:

```
DEFINE SCHEDULE STANDARD CLUSTER_BACKUP
```

- The administrator defines associations for each one of the 3 nodes.

```
DEFINE ASSOC STANDARD CLUSTER_BACKUP host_a,host_b,cluster_group
```

- At any one time, there are three instances of the backup-archive client schedule running with the scheduler for node `hacmp_cluster` running on either `host_a` or `host_b` but not both (it is included in the cluster resources that would failover). This scheduler would point to the `dsmcluster.opt` that is defined on each host. The three instances would be started as:

```
[host_a]          dsmc sched
[host_b]          dsmc sched
[cluster_group] dsmc sched -optfile=/disk/tsm/dsmcluster.opt
```

- All three node names contain data on the IBM Spectrum Protect server.

For more information about the server scheduler commands, see the server documentation.

AIX | Linux

## Scheduling a backup of a GPFS file system

Use the scheduler and proxy relationships to back up a GPFS™ file system.

### About this task

Assume that three nodes in a GPFS cluster participate in the backup operation. Nodes `node_1`, `node_2`, and `node_3` are used for authentication only. The objects are backed up to file spaces that belong to node `node_gpfs`.

### Procedure

1. Define four nodes on the IBM Spectrum Protect™ server.

```
REGISTER NODE node_1 mysecretpa5s
REGISTER NODE node_2 mysecretpa5s
REGISTER NODE node_3 mysecretpa5s
REGISTER NODE node_gpfs mysecretpa5s
```

2. Define a proxy relationship between the nodes.

```
GRANT PROXYNODE TARGET=node_gpfs AGENT=node_1, node_2, node_3
```

### 3. Define a schedule.

```
DEFINE SCHEDULE STANDARD GPFS_SCHEDULE ACTION=incremental  
OBJECTS="/gpfs"
```

```
DEFINE ASSOCIATION STANDARD GPFS_SCHEDULE node_gpfs
```

### 4. Choose one of the GPFS systems to run the schedule. Specify the nodename and asnodename options in the dsm.sys options file on all systems in the GPFS cluster. The value for the asnodename option must be the same on all systems.

Definitions in the dsm.sys options file on node 1:

```
nodename node_1  
asnodename node_gpfs
```

Definitions in the dsm.sys options file on node 2:

```
nodename node_2  
asnodename node_gpfs
```



Definitions in the dsm.sys options file on node 3:

```
nodename node_3  
asnodename node_gpfs
```

### 5. Start the scheduler on the system that is chosen to run the schedule.

```
DSMC SCHED
```

#### Related information:

- [AIX](#) | [Linux](#)  mmbackup command: IBM Spectrum Protect requirements
- [AIX](#) | [Linux](#)  Guidance for integrating IBM Spectrum Scale AFM with IBM Spectrum Protect
- [AIX](#) | [Linux](#)  Using IBM Spectrum Protect include and exclude options with IBM Spectrum Scale mmbackup command
- [Windows](#)

## Associate a local snapshot with a server file space (Windows)

---

Use the snapshotroot option with the incremental and selective commands in conjunction with a vendor-supplied application that provides a snapshot of a logical volume, to associate the data on the local snapshot with the real file space data that is stored on the IBM Spectrum Protect™ server.

The snapshotroot option does not provide any facilities to take a volume snapshot, only to manage data created by a volume snapshot.

#### Related reference:

Snapshotroot

[Mac OS X](#) | [AIX](#) | [Linux](#) | [Solaris](#)

## Associate a local snapshot with a server file space (UNIX and Linux)

---

Use the snapshotroot option with the incremental and selective commands in conjunction with an independent software vendor application that provides a snapshot of a logical volume, to associate the data on the local snapshot with the real file space data that is stored on the IBM Spectrum Protect™ server.

The snapshotroot option does not provide any facilities to take a volume snapshot, only to manage data created by a volume snapshot.

#### Related reference:

Snapshotroot

[Windows](#)

## Backing up Windows system state

---

The backup-archive client uses VSS to back up all system state components as a single object, to provide a consistent point-in-time snapshot of the system state. System state consists of all bootable system state and system services components.

## About this task

---

The client supports the Microsoft volume shadow copy service (VSS) on the supported Windows clients.

System state is represented by several VSS writers of type "bootable system state" and "system service". Of these, the System Writer is the largest part of the system state in terms of number of files and size of data. By default, the System Writer backup is incremental. You can use the `systemstatebackupmethod` option to perform full backups of the System Writer. For more information, about this option, see `Systemstatebackupmethod`. The client always backs up all other writers in full.

The list of bootable system state and system services components are dynamic and can change depending on service pack and operating system features installed. The client allows for the dynamic discovery and back up of these components.

You must be a member of the Administrators or Backup Operators group to back up system state information.

To back up a system state object using the command line:

1. On the command line, use the **backup systemstate** command to back up all system state or system services components as a single object.
2. Use the **query systemstate** command to display information about a backup of the system state on the IBM Spectrum Protect™ server.

To back up a system state object using the GUI:

1. Click **Backup** from the GUI main window. The Backup window appears.
2. Expand the directory tree by clicking the plus sign (+). To display files in a folder, click the folder icon.
3. Locate the system state node in the directory tree. You can expand the system state node to display the components.
4. Click the selection box next to the system state node to back up the entire system state object. You can back up the system state node only as a single entity because of dependencies among the system state components. By default, all components are selected; you cannot back up individual system state components.
5. Click **Backup**. The Backup Task List window displays the backup processing status. When processing completes, the Backup Report window displays processing details.

System and boot files are backed up as a group only if one of the members of the group (one of the files) changes. If the files have not changed since the last backup, the system and boot files are not redundantly backed up.

By default, system state backups are bound to the default management class. To bind them to a different management class, use the `include.systemstate` option; specify all as the pattern, and specify the name of the new management class.

You can use the `domain` option to exclude the entire system state from domain incremental backup processing.

The system `dllcache` directory is now included in the boot partition backup of Windows systems. When the `dllcache` files are not available when you restore a Windows computer, system recovery might require availability of the operating system installation media. By backing up the `dllcache` directory, you can avoid the need for installation media during system restores.

If you do not want the `dllcache` directory included in the backup of your boot partition, and you understand the limitations of not backing up the `dllcache` directory, then you can use an `exclude.dir` statement to suppress backup of those files. For example:

```
exclude.dir c:\windows\system32\dllcache
```

On Windows clients, backup `systemstate` also backs up ASR data.

### Related tasks:

Restoring Windows system state

### Related reference:

Backup Systemstate

Domain

Exclude options

Include options

Query Systemstate

Restore Systemstate

Windows

---

## Backing up Automated System Recovery files

You can back up Automated System Recovery (ASR) files in preparation for recovering the Windows disk configuration information and system state in case a catastrophic system or hardware failure occurs.

## About this task

---

The backup-archive client backs up ASR data when the backup-archive client backs up the Windows system state.

## Procedure

---

To back up ASR files on Windows operating systems, use the backup systemstate command.

## Results

---

The client generates the ASR files in the \adsm.sys\ASR staging directory on the system drive of your local workstation and stores these files in the ASR file space on the IBM Spectrum Protect™ server.

### Related concepts:

Preparation for Automated System Recovery

### Related tasks:

Restoring Automated System Recovery files

### Related reference:

Backup Systemstate

Windows

## Preparation for Automated System Recovery

---

Specific backups and media are required for Windows Automated System Recovery (ASR).

- **Windows** Creating a client options file for Automated System Recovery  
Before you can recover a Windows computer by using Automated System Recovery (ASR), you must create an options file. The options file is unique for each computer.
- **Windows** Backing up the boot drive and system drive for Automated System Recovery  
Before you can recover your Windows computer by using Automated System Recovery (ASR), you must have a complete backup of the boot drive and system drive.

Windows

## Creating a client options file for Automated System Recovery

---

Before you can recover a Windows computer by using Automated System Recovery (ASR), you must create an options file. The options file is unique for each computer.

## About this task

---

This task assumes that you created a generic bootable WinPE CD or DVD. A generic bootable WinPE CD does not contain the client options file (dsm.opt) because the options file is unique for each computer. This task helps you create a computer-specific options file.

The Windows Preinstallation Environment (WinPE) requires particular options values.

## Procedure

---

1. Find a copy of the client options file. You can find the file in several places:
  - o There is an options file in the installation directory of an installed IBM Spectrum Protect™ client. The default installation location is C:\Program Files\Tivoli\TSM\baclient\dsm.opt. If you have the options file for the computer that you want to restore, this options file requires the fewest modifications.
  - o There is a sample options file in the client installation package. The path in the package is TSM\_BA\_Client\program files\Tivoli\TSM\config\dsm.smp. Rename the file to dsm.opt.
2. Edit dsm.opt.
  - a. Enter a writable location for the error log. The backup-archive client creates several log files. Use the option errorlogname to specify the log file location. For example, in the dsm.opt file, specify errorlogname

```
x:\dsmerror.log.
```

Note: This example uses x: because in WinPE mode, the default system drive is x:.

- b. Enter the client node name with the nodename option.
  - c. Optional: If you plan to restore the system state from files that are stored on the IBM Spectrum Protect server, enter the server connection information. Enter appropriate values for the commmethod and tcpserveraddress options.
  - d. Optional: If you know the password for the node, enter the password with the password option.
3. Copy the dsm.opt file to media that the target computer can read during Automated System Recovery.
  4. Optional: Copy IBM Spectrum Protect client registry information to media that the target computer can read during Automated System Recovery. Use the regedit.exe utility to export IBM Spectrum Protect client registry entries from the HKLM\SOFTWARE\IBM key. For example, from a command prompt window, run this command:

```
regedit /e tsmregistry.out "HKEY_LOCAL_MACHINE\SOFTWARE\IBM"
```

Copy the tsmregistry.out file to media that the target computer can read during ASR.

During ASR, you can import the registry entries from the tsmregistry.out file. The backup-archive client can use the registry entries in the WinPE environment to access backup copies on the IBM Spectrum Protect server.

Note: Saving registry entries is optional because there are other ways to get access to the password-protected IBM Spectrum Protect server. You can access the server with the following methods:

- o If you know the node password, you can type the password when prompted during recovery.
- o Request the IBM Spectrum Protect administrator to change the node password and provide you with the new password at the time of recovery.
- o Provide the password information in the dsm.opt file.

If the files you want to restore are included in a backup set on tape or on a CD or DVD, then you do not need to access the IBM Spectrum Protect server.

## Results

---

You created an options file that contains client configuration information that is unique for each computer. This information complements the generic bootable WinPE CD.

### Related tasks:

Creating a bootable WinPE CD

Windows

## Backing up the boot drive and system drive for Automated System Recovery

---

Before you can recover your Windows computer by using Automated System Recovery (ASR), you must have a complete backup of the boot drive and system drive.

## Procedure

---

1. Perform a full incremental backup of your system and boot drives. Assuming that your system and boot files are on the c: drive, enter the following command:

```
dsmc incremental c:
```

2. Back up the system state. To back up the system state, enter the following command:

```
dsmc backup systemstate
```

To verify that you backed up the system state, enter the following command:

```
dsmc query systemstate
```

You can specify `-showmembers=yes` to display file level detail.

### Related concepts:

Full and partial incremental backup

### Related tasks:

Backing up Windows system state

AIX

Linux

Solaris

Windows

## Image backup

---

From your local workstation, you can back up a logical volume as a single object (image backup) on your system.

The traditional static image backup prevents write access to the volume by other system applications during the operation.

**AIX** | **Linux** | **Solaris** You must be a root user to perform this task, and image backup does not apply to Mac OS X.

**Windows** These volumes can be formatted NTFS or ReFS, or unformatted RAW volumes. If a volume is NTFS-formatted, only those blocks that are used by the file system or smaller than the `imagegapsize` parameter are backed up.

**Windows** Normally you cannot restore an image backup of the system drive over itself since an exclusive lock of the system drive is not possible. However, in a Windows pre-installation environment (WinPE), an image restore of the system drive is possible. For information about restoring data in a WinPE environment, see technote 7005028.

**Windows** You cannot restore an image backup to the volume on which the client is running. Consider installing the backup-archive client on the system drive.

**Windows** Image backup does not guarantee consistency of system objects, such as the Active Directory. System objects can be spread out across multiple volumes, and should be backed up by using the `backup systemstate` command.

An image backup provides the following benefits:

- Backs up file systems that contain a large number of files faster than a full file system incremental backup.
- Improves the speed with which the client restores file systems that contain many small files.
- Conserves resources on the server during backups since only one entry is required for the image.
- Provides a point-in-time picture of your logical volume, which might be useful if your enterprise must recall that information.
- Restores a corrupted file system or raw logical volume. Data is restored to the same state it was when the last logical volume backup was performed.

**AIX** | **Linux** | **Solaris** The traditional static image backup prevents write access to the volume by other system applications during the operation. Use the `dynamicimage` option to back up the volume as is, without remounting it read-only. Corruption of the backup can occur if applications continue to write to the volume while the backup is running. Writing to a volume while an image backup is running can result in inconsistent data and data loss after a restore operation is run. The `dynamicimage` option overrides the copy serialization value in the management class to perform an image backup. After restoring an image backup taken with the `dynamicimage` option, always run the `chkdsk` utility.

**Windows** The traditional offline image backup prevents write access to the volume by other system applications during the operation. When you backup an image by using `snapshotproviderimage=none`, always run the `fsck` utility after you restore the data.

To restore an image backup of a volume, the backup-archive client must be able to obtain an exclusive lock on the volume that is being restored.

**AIX** | **Linux** | **Solaris** Restriction: Do not use dynamic image backups for file systems, because the file system might provide inconsistent data even when there is no write activity. Also, dynamic image backup might result in a fuzzy image, which might not be valid or complete when restored.

**AIX** | **Linux** | **Solaris** If the backup-archive client fails to mount the file system after it restores an image, run `fsck`. However, running `fsck` can affect the integrity of large amounts of data. Do not use dynamic image backup for AIX® JFS2 file systems. The client does not allow dynamic image backup for AIX JFS2 file systems. If you specify `dynamicimage=yes` for a JFS2 file system, the client performs a snapshot-based image backup. If the snapshot cannot be created for some reason, the client instead performs a static image backup.

**AIX** | **Linux** | **Solaris** Attention: To prevent data loss, avoid using the `dynamicimage` option, and ensure that there is no write activity on the volume while the backup is in progress.

**AIX** | **Linux** | **Solaris** For AIX JFS2 file systems, the amount of data that is backed up to the IBM Spectrum Protect™ server during static or snapshot image backup is reduced by backing up only those blocks used by the file system or smaller than the `imagegapsize` option. This method of backing up your data improves the performance of image backup. For more information, see `Imagegapsize`.

**AIX** For AIX clients only: By default, the client performs an online snapshot image backup of JFS2 file systems, during which the volume is available to other system applications.

**Linux** For Linux clients only: By default, the client performs a snapshot image backup of file systems that exist on a logical volume that is created by the Linux Logical Volume Manager. The volume is available to other system applications while the



snapshot image backup is performed.

**Linux** For Linux clients: Image backup of DASD devices with raw-track access mode on Linux on z Systems™ is not supported.

**Windows** If online image support is configured, the client performs an online image backup, during which the volume is available to other system applications. The snapshot provider, as specified by the `snapshotproviderimage` option, maintains a consistent image of a volume during online image backup.

**Windows** You can use the `snapshotproviderimage` option with the `backup image` command or the `include.image` option to specify whether to perform an offline or online image backup.

**AIX** **Linux** **Solaris** Attention: File systems that are managed by IBM Spectrum Protect for Space Management are not enabled for image backup.

- **AIX** **Linux** **Solaris** **Windows** Performing prerequisite tasks before creating an image backup  
This topic lists some items to consider before you perform an image backup.
- **AIX** **Linux** **Solaris** **Windows** Utilizing image backups to perform file system incremental backups  
This topic lists the methods and steps to use image backups to perform efficient incremental backups of your file system.
- **AIX** **Linux** **Solaris** **Windows** Performing an image backup using the GUI  
If the image backup feature is configured, you can create an image backup where the real volume is available to other system applications.
- **AIX** **Linux** **Solaris** **Windows** Performing an image backup using the command line  
Use the `backup image` and `restore image` commands to perform image backup and restore operations on a single volume.

#### Related tasks:

**Windows** Configuring online-image backup support

**AIX** **Linux** **Solaris** Snapshot-based file backup and archive and snapshot-based image backup

#### Related reference:

**Windows** `Snapshotproviderimage`

**AIX** **Linux** **Solaris** **Windows**

## Performing prerequisite tasks before creating an image backup

---

This topic lists some items to consider before you perform an image backup.

### About this task

---

The following items are the image backup considerations.

- **Windows** *To perform an offline or online image backup you must have administrative authority on the system.*
- **Windows** You do not need more than one drive to perform an image backup.
- **AIX** **Linux** **Solaris** Ensure that no other application is using the volume when you run a static image backup. To ensure a consistent image during backup processing, if a file space is detected on the volume the client unmounts and remounts the volume as read only, so that no other applications can write to it. If the volume is in use when the client attempts to unmount, the backup fails. If the client cannot unmount and remount the volume as read only because it is in use, and snapshot image backup is not available, you can use the `dynamicimage` option to force the client to perform an image backup without unmounting and remounting the volume in read-only mode. Set the `dynamicimage` option in an `include.image` statement or from the command line. The backup can be corrupted if applications write to the volume while the backup is in progress. This can be corrected by running `fsck` after a restore to fix any corrupted blocks.

If no file system is detected on the volume being backed up, ensure that all applications writing to the volumes are quiesced. The backup-archive client uses the file system table and mount table to detect the supported file systems.

*Do not* include system files in an image backup because file systems being actively used cannot be unmounted.

For AIX® and Linux only: If you perform an image backup of a mounted file system which is mounted to another mount point and specified in the file system table, then after completing the image backup, all mount options for this file system, except read or write state, is lost.

**Important:** If a mounted file system has nested mount points, unmount them before attempting a backup. Otherwise, the client is unable to unmount the volume. The file system is rendered *busy* if it contains any mounts.

- **Windows** Ensure that no other application is using the volume when you run an offline image backup. To ensure a consistent image during backup processing, the client locks the volume, so that no other applications can write to it. If the

volume is in use when the client attempts to lock the volume, the backup fails. If the client cannot lock a volume because it is in use, you can perform an online image backup.

- Use the `include.image` option to assign a management class to the volume image. If you do not assign a management class, the default management class is used for the image.

**Windows** Note: If the `snapshotproviderimage` option is set to `none`, then the copy serialization parameters set by the management class is used.

- You can exclude a volume from image backup using the `exclude.image` option.

- **AIX** **Linux** **Solaris** You must use the mount point for the file system volume on which you want to perform an image backup. The client will not back up a file system volume without the use of a mount point. Back up file systems using the mounted name. For example, if `/dev/lv01` is formatted as a file system mounted on `/home`, enter this command to perform an image backup of this volume:

```
dsmc backup image /home
```

Back up raw volumes using the device name. For example, if `/dev/lv02` is a raw volume, enter this command to perform an image backup of this volume:

```
dsmc backup image /dev/lv02
```

If you back up a raw volume which is formatted as a file system, ensure that the file system is not mounted and does not have an entry in `/etc/filesystems`.

- **Windows** You must use the mount point or drive letter for the volume on which you want to perform an image backup. The client will not back up a volume without the use of a drive letter or mount point.
- **Windows** Do not include the system drive in an image backup because the client cannot have an exclusive lock of the system drive during the restore and the system drive image cannot be restored to the same location. Image backup does not guarantee consistency of system objects, such as the Active Directory. System objects can be spread out across multiple volumes, and should be backed up using the corresponding backup commands. Because you cannot restore an image backup to the volume from which the client is currently running (or any volume for which an exclusive lock cannot be obtained) you should install your client program on the system drive.

Note: When using WinPE, an image restore of the system drive is possible. For more information, see IBM Spectrum Protect™ Recovery Techniques Using Windows Preinstallation Environment (Windows PE).

- **Windows** If bad disk sectors are detected on the source drive during a LAN-free or LAN-based image backup, data corruption can occur. In this case, bad sectors are skipped when sending image data to the IBM Spectrum Protect server. If bad disk sectors are detected during the image backup, a warning message is issued after the image backup completes.
- **AIX** **Linux** **Solaris** Volume device type support for an image backup  
This topic lists several devices that are supported by the backup image command.

#### Related concepts:

Storage management policies

#### Related reference:

Exclude options

Include options

**Windows** `Snapshotproviderimage`

**AIX** **Linux** **Solaris** **Windows**

## Utilizing image backups to perform file system incremental backups

This topic lists the methods and steps to use image backups to perform efficient incremental backups of your file system.

These backup methods allow you to perform a point-in-time restore of your file systems and improve backup and restore performance. You can perform the backup only on formatted volumes; not on raw logical volumes.

You can use one of the following methods to perform image backups of volumes with mounted file systems.

- **AIX** **Linux** **Solaris** **Windows** Method 1: Using image backups with file system incremental backups  
This topic lists the steps to perform image backups with file system incremental backup.
- **AIX** **Linux** **Solaris** **Windows** Method 2: Using image backups with incremental-by-date image backups  
This topic lists the steps to perform image backups with incremental-by-date image backup.
- **AIX** **Linux** **Solaris** **Windows** Comparing methods 1 and 2  
This topic shows a comparison of methods 1 and 2: (1) Using image backup with file system incremental or (2) Using image backup with incremental-by-date image backup.

**AIX** **Linux** **Solaris** **Windows**

## Method 1: Using image backups with file system incremental backups

---

This topic lists the steps to perform image backups with file system incremental backup.

### About this task

---

### Procedure

---

1. Perform a full incremental backup of the file system. This establishes a baseline for future incremental backups.
2. Perform an image backup of the same file system to make image restores possible.
3. Perform incremental backups of the file system periodically to ensure that the server records additions and deletions accurately.
4. Perform an image backup periodically to ensure faster restore.
5. Restore your data by performing an incremental restore. Ensure that you select the **Image plus incremental directories and files** and **Delete inactive files from local** options in the Restore Options window before beginning the restore. During the restore, the client does the following:

### Results

---

- Restores the most recent image on the server.
- Deletes all of the files restored in the previous step which are inactive on the server. These are files which existed at the time of the image backup, but were subsequently deleted and recorded by a later incremental backup.
- Restores new and changed files from the incremental backups.

Note: If an incremental backup is performed several times after backing up an image, make sure that the backup copy group of the IBM Spectrum Protect™ server has enough versions for existing and deleted files on the server so that the subsequent restore image with incremental and deletefiles options can delete files correctly.

#### Related tasks:

[AIX](#) | [Linux](#) | [Solaris](#) | [Mac OS X](#) Backing up data using the Java GUI

[Windows](#) Backing up data using the GUI

Performing an image backup using the GUI

Restoring an image using the GUI

[AIX](#) | [Linux](#) | [Solaris](#) | [Windows](#)

## Method 2: Using image backups with incremental-by-date image backups

---

This topic lists the steps to perform image backups with incremental-by-date image backup.

### Procedure

---

1. Perform an image backup of the file system.
2. Perform an incremental-by-date image backup of the file system. This sends only those files that were added or changed since the last image backup to the server.
3. Periodically, perform full image backups.
4. Restore your volume by performing an incremental restore. Ensure that you select the **Image plus incremental directories and files** option in the Restore Options window before beginning the restore. This first restores the most recent image and then restores all of the incremental backups performed since that date.

### Results

---

Note: You should perform full image backups periodically in the following cases:

- When a file system changes substantially (more than 40%), as indicated in step 4 of method 1 and step 3 of method 2. On restore, this would provide a file system image close to what existed at the time of the last incremental-by-date image backup and it also improves restore time.
- As appropriate for your environment.

This improves restore time because fewer changes are applied from incremental backups.

The following restrictions apply when using method 2:

- The file system can have no previous full incremental backups.
- Incremental-by-date image backup does not inactivate files on the server; therefore, when you restore an image with the incremental option, files deleted after the original image backup is present after the restore.
- If this is the first image backup for the file system, a full image backup is performed.
- If file systems are running at or near capacity, an out-of-space condition could result during the restore.

**Related tasks:**

Performing an image backup using the GUI

Restoring an image using the GUI

AIX Linux Solaris Windows

## Comparing methods 1 and 2

This topic shows a comparison of methods 1 and 2: (1) Using image backup with file system incremental or (2) Using image backup with incremental-by-date image backup.

To help you decide which method is appropriate for your environment, the following table is a comparison of methods 1 and 2.

Table 1. Comparing incremental image backup methods

Method 1: Using image backup with file system incremental	Method 2: Using image backup with incremental-by-date image backup
Files are expired on the server when they are deleted from the file system. On restore, you have the option to delete files which are expired on server from image.	Files are not expired on server. After the image incremental restore completes, all of the files that are deleted on the file system after the image backup are present after the restore. If file systems are running at or near capacity, an out-of-space condition could result.
Incremental backup time is the same as regular incremental backups.	Incremental image backup is faster because the client does not query the server for each file that is copied.
Restore is much faster compared to a full incremental file system restore.	Restore is much faster compared to a full incremental file system restore.
Directories deleted from the file system after the last image backup are not expired.	Directories and files deleted from the file system after the last full image backup are not expired.

AIX Linux Solaris Windows

## Performing an image backup using the GUI

If the image backup feature is configured, you can create an image backup where the real volume is available to other system applications.

### About this task

A consistent image of the volume is maintained during the image backup.

**Windows** When you perform an image backup using the client GUI image backup option, the backup operation is run according to the snapshotproviderimage setting in your client options file (dsm.opt). If the online image support is configured, the client performs an online image backup, during which the volume is available to other system applications.

**AIX Linux** When you perform an image backup using the backup-archive client GUI image backup option, the backup operation is run according to the setting of the snapshotproviderimage option. The snapshotproviderimage option defaults to an AIX® JFS2 snapshot for AIX and a Linux LVM snapshot for Linux. You can override the default by using the Preferences editor Snapshot tab and the Image Snapshot Preferences.

**Solaris** For Solaris clients, selecting the image backup option performs a static image backup by default. For static image backup, the client unmounts and remounts the volume as read-only, so that no other applications can access it. You can override the default value by using the include.image option and selecting dynamicimage yes. For dynamic image backup, the client performs the image backup without making the file system read-only during the backup.

To create an image backup of your file system or raw logical volume, perform the following steps:

## Procedure

1. Click on the **Backup** button in the IBM Spectrum Protect™ main window. The Backup window appears.
2. Expand the directory tree and select the objects you want to back up. To back up a raw logical volume, locate and expand the RAW directory tree object.
3. Click Backup. The Backup Task List window displays the backup processing status. The Backup Report window displays a detailed status report.

## Results

- **AIX Linux Solaris** To perform a static image backup, select **Image Backup** from the drop-down list.
- **Windows** To perform an offline image backup, select **Image Backup** from the drop-down list.
- **Windows** To perform an online image backup, select **Snapshot Image Backup** from the drop-down list.
- **AIX Linux** For AIX and Linux clients *only*: To perform a snapshot image backup, use the snapshotproviderimage option.
- To perform an incremental-by-date image backup, select **Incremental image (date only)** from the drop-down list.

**AIX Linux Solaris** The following are some items to consider when you perform an snapshot-based image backup:

**Windows** The following are some items to consider when you perform an online image backup:

- To modify specific backup options, click the Options button. The options you select are effective only during the current session.
- **Windows** Because image backup allows you to back up only used blocks in a file system, the stored image size on the IBM Spectrum Protect server could be smaller than the volume size. For online image backups, the stored image can be larger than the file system based on the size of the cache files. To determine the actual stored image size, select View > File Details. The actual stored image size is noted in the Stored Size field.
- To modify specific backup options, click the Options button. The options you select are effective only during the current session.
- **Windows** Because image backup allows you to back up only used blocks in a file system, the stored image size on the IBM Spectrum Protect server could be smaller than the volume size. For online image backups, the stored image can be larger than the file system based on the size of the cache files. To determine the actual stored image size, select View > File Details. The actual stored image size is noted in the Stored Size field.

**Linux** Linux only: The IBM Spectrum Protect Version 5.4 (and newer) client will not recognize any LVM1 volumes for image operations. However, it allows prior image backups of LVM1 volumes to be restored on LVM2 volumes. Table 1 shows the combinations involving the old and new client levels handling LVM1 and LVM2 volumes for different image operations.

**Linux**

Table 1. LVM1 and LVM2 image operation comparisons

IBM Spectrum Protect client version	LVM1 Backup and Restore	LVM2 Backup and Restore	Mixed Volumes	
			Backup: LVM1, Restore: LVM2	Backup: LVM2, Restore: LVM1
V5.3 and prior	YES	Only static image for file system	NO	NO - raw volumes are not supported
V5.4 and beyond	NO Error msg ANS1090E displayed	YES	YES LVM1 vol must have been backed up using prior client	NO Restore to LVM1 vol fails

### Related reference:

Snapshotproviderimage

**AIX Linux Solaris Windows**

## Performing an image backup using the command line

Use the backup image and restore image commands to perform image backup and restore operations on a single volume.

**Windows** You can use the snapshotproviderimage option with the backup image command or the include.image option in your dsm.opt file or on the command line to specify whether to perform an offline or online image backup.

Use the mode option with the backup image command to perform an incremental-by-date image backup that backs up only new and changed files after the last full image backup. However, this only backs up files with a changed date, not files with changed permissions.

**Related reference:**

Backup Image

Mode

Restore Image

 Snapshotproviderimage



## Snapshot-based file backup and archive and snapshot-based image backup

---

For backup-archive clients running on AIX® 5.3 or later JFS2 file systems as root user, snapshot-based image backup is created using snapshots by default.

### About this task

---

Optionally, you can enable snapshot-based file level backup and archive operations by specifying the `snapshotproviderfs` option. If for some reason a snapshot cannot be taken, the client attempts to perform a static image backup or regular file backup.

If you want to specify snapshot-based file backup and archive, set the option `snapshotproviderfs` to `JFS2`. This is applicable to all JFS2 file systems for that client.

Important: Use snapshot-based file backup and archive and snapshot-based image backup for all of your AIX JFS2 file systems.

For example, to turn *on* snapshot-based file backup and archive for all JFS2 file systems on the client, specify the following in the server stanza in the `dsm.sys` file:

```
snapshotproviderfs JFS2
```

To explicitly turn *off* snapshot-based file backup and archive for all JFS2 file systems on the client, specify the following in the server stanza in the `dsm.sys` file:

```
snapshotproviderfs NONE
```

To turn *on* snapshot-based file backup and archive for only one specific JFS2 file system on the client, specify the following in the server stanza in the `dsm.sys` file:

```
snapshotproviderfs NONE  
include.fs /kalafs1 snapshotproviderfs=JFS2
```

To turn *off* snapshot-based file backup and archive for only one specific JFS2 file system on the client, specify the following in the server stanza in the `dsm.sys` file:

```
snapshotproviderfs JFS2  
include.fs /kalafs2 snapshotproviderfs=NONE
```

To turn *on* snapshot-based file backup and archive for only one specific operation on the client, specify the following on the command line:

```
dsmc incr -snapshotproviderfs=JFS2 /kalafs1
```

To turn *off* snapshot-based file backup and archive for only one specific operation on the client, specify the following in the server stanza in the `dsm.sys` file:

```
snapshotproviderfs JFS2
```

Then perform the backup command. For example:

```
dsmc incr -snapshotproviderfs=NONE /kalafs2
```

**Related reference:**

## Protecting Btrfs file systems

---

Btrfs file systems can be included as file specifications for backup and restore commands, archive and retrieve commands, and on backup image and restore image commands. You can also specify Btrfs subvolumes as file specification to the backup and restore, and archive and retrieve functions. You cannot use the backup-archive client image backup or image restore commands on a Btrfs subvolume.

Btrfs file systems are supported on SLES 11 SP2, or later, on IBM®System x, System p, and System z®.

If you want to create a static image backup of the entire Btrfs file system, you must unmount all the subvolumes so the backup-archive client can unmount or mount the Btrfs file system during the backup process. You can avoid the mounting and unmounting requirements if you perform a snapshot-based image backup of the Btrfs file system instead of a static image backup.

Image backup and image restore functionality is not available for Btrfs subvolumes. If you try to back up a subvolume by using the image backup, the following message is displayed:

```
ANS1162E Filesystem could not be mounted
```

You can mount a Btrfs subvolume by using either the subvolume name or the subvolume ID.

On Btrfs file systems, journal backup can be performed both at the file system and the subvolume level. If you perform journal-based backups on a Btrfs file system, the journal that is created is for the entire file system; there is not a separate journal for each subvolume.

Restriction: On Linux systems, some file systems such as ext2, ext3, ext4, btrfs, and xfs use a universally unique identifier (UUID) to identify themselves to the operating system. If you create an image backup of such a volume and you restore it to a different location, you might have two volumes with the same UUID. If you use UUID to define your file systems in `/etc/fstab`, be aware that the backup-archive client might be unable to correctly mount the restored file system because the UUIDs conflict. To avoid this situation, restore the image to its original location. If you must restore it to a different location, change the UUID of either the original or restored volume before you mount the restored file system. Refer to the Linux documentation for instructions on how to change a UUID. You might also need to manually edit the `/etc/fstab` file so the original volume, the restored volume, or both volumes can be mounted.

- **Linux** Backing up and restoring Btrfs file systems  
You can back up or restore, or archive and retrieve, Btrfs file systems by using the backup-archive client incremental, selective, restore, archive, and retrieve commands.
- **Linux** Backing up and restoring Btrfs subvolumes  
You can back up or restore, or archive and retrieve, Btrfs subvolumes by using the backup-archive client incremental, selective, restore, archive, and retrieve commands.

## Backing up and restoring Btrfs file systems

---

You can back up or restore, or archive and retrieve, Btrfs file systems by using the backup-archive client incremental, selective, restore, archive, and retrieve commands.

### About this task

---

If you used a version of the backup-archive client that is older than Version 7.1 to back up a Btrfs file system, the file system type was listed as `Unknown`, in the IBM Spectrum Protect™ server GUI and command output. The `Unknown` file system type is displayed because before IBM Spectrum Protect 7.1, Btrfs file systems were not formally supported. If you use a backup-archive V7.1 client (or newer) to back up that same Btrfs file system, all files that have Access Control Lists (ACLs) and extended attributes (XATTRs) are backed up again, even if their content has not changed since the last backup that was created by the older version of the client. Also, after a Btrfs file system is backed up by the V7.1 (or newer) client, the file system type is correctly shown as `Btrfs` in the IBM Spectrum Protect server GUI and command output.

Even with a V7.1 or newer client, copying a file on a Btrfs file system might cause the file to be included in the next backup operation. For example, if you copy a file by using the `cp` command with the `-p` or `-preserve` options (preserve mode, ownership, and time stamps), and if the file's attributes are changed, the access ACL extended attribute (`system.posix_acl_access`) is

changed. Because an extended attribute is changed, the client backs up the entire file, rather than just updating the attributes for the file.

## Procedure

1. Mount the file system that you want to protect or recover. For example, use the following syntax to mount a file system:  
`mount /dev/sdb1 on /btreefs1 type btrfs (rw)`
2. Protect or recover the file system by performing one of the following operations:

Operation	Command
<b>Back up the file system</b>	<code>dsmc incr /btreefs1</code>
<b>Restore the file system</b>	<code>dsmc restore /btreefs1/ -subdir=yes -replace=yes</code>
<b>Archive the file system</b>	<code>dsmc archive /btreefs1/ -subdir=yes</code>
<b>Retrieve the file system</b>	<code>dsmc retrieve /btreefs1/ -subdir=yes -replace=yes</code>
<b>Back up a file system snapshot</b>	<p>Create the file system snapshot. Use the btrfs subvolume snapshot command. The snapshot directory that is specified in this example is the btreefs1_snap directory on the file system named /btreefs1.</p> <pre>btrfs subvolume snapshot /btreefs1/ /btreefs1/btreefs1_snap</pre> <p>Issue the backup-archive client incremental command. Specify the snapshotroot option and the location of the Btrfs snapshot.</p> <pre>\$DSM_DIR/dsmc incr /btreefs1 -snapshotroot=/btreefs1/btreefs1_snap</pre>
<b>Perform an image backup</b>	<p>All subvolumes must be unmounted before you create an image backup.</p> <pre>dsmc backup image /btreefs1 -snapshotproviderimage=none</pre> <p>To avoid having to unmount the subvolumes, create a snapshot-based image backup.</p> <pre>dsmc backup image /btreefs1</pre>
<b>Restore an image backup</b>	<p>All subvolumes must be unmounted before you restore an image backup.</p> <pre>dsmc restore image /btreefs1</pre>

Linux

## Backing up and restoring Btrfs subvolumes

You can back up or restore, or archive and retrieve, Btrfs subvolumes by using the backup-archive client incremental, selective, restore, archive, and retrieve commands.

### Procedure

1. List the subvolumes and determine their IDs.

```
btrfs subvolume list /btreefs1  
ID 256 top level 5 path @  
ID 262 top level 5 path @/btreefs1_sub1
```

2. Make the directory to use as the mount point for the subvolume.

```
mkdir /btreefs1_sub1
```

3. Mount the subvolume. For example, to mount the subvolume on device sdb1 at /btreefs1\_sub1, use the following syntax:  
`mount -t btrfs -o subvolid=262 /dev/sdb1 /btreefs1_sub1`

Protect or recover the subvolume by using one or more of the following operations:



Operation	Command
<b>Back up a subvolume</b>	Both incremental and selective backups are supported.  <pre>dsmc incr /btreefs1_sub1</pre> <pre>dsmc sel /btreefs1_sub1/ -subdir=yes</pre>
<b>Restore a subvolume</b>	<pre>dsmc restore /btreefs1_sub1/</pre> <pre>-subdir=yes -replace=yes</pre>
<b>Archive a subvolume</b>	<pre>dsmc archive /btreefs1_sub1/</pre> <pre>-subdir=yes</pre>
<b>Retrieve a subvolume</b>	<pre>dsmc retrieve /btreefs1_sub1/</pre> <pre>-subdir=yes -replace=yes</pre>
<b>Back up a Btrfs subvolume snapshot</b>	Create the subvolume snapshot. Use the btrfs subvolume snapshot command. The snapshot directory that is specified in this example is the /btreefs1/btreefs1_sub1_snap directory, for the subvolume named btreefs1_sub1.  <pre>btrfs subvolume snapshot</pre> <pre>/btreefs1/btreefs1_sub1</pre> <pre>/btreefs1/btreefs1_sub1_snap</pre> <p>Issue the backup-archive client incremental command. Specify the snapshot root option and the location of the Btrfs snapshot.</p> <pre>dsmc incr /btreefs1_sub1</pre> <pre>-snapshotroot=/btreefs1</pre> <pre>/btreefs1_sub1_snap</pre>

AIX | Solaris | Windows

## Back up NAS file systems using Network Data Management Protocol

Windows, AIX®, and Solaris backup-archive clients can use Network Data Management Protocol (NDMP) to efficiently back up and restore network attached storage (NAS) file system images. The file system images can be backed up to, or be restored from, automated tape drives or libraries that are locally attached to Network Appliance or EMC Celerra NAS file servers, or to or from tape drives or libraries that are locally attached to the IBM Spectrum Protect™ server.

NDMP support is available only on IBM Spectrum Protect Extended Edition.

For Linux x86\_64 clients, incremental backup can also be used to back up NAS file system snapshots. See the incremental command and snapshotroot, snapdiff, createnewbase, and diffsnapshot options for more information.

After configuring NDMP support, the server connects to the NAS device and uses NDMP to initiate, control, and monitor each backup and restore operation. The NAS device performs outboard data transfer to and from the NAS file system to a locally attached library.

Filer to server data transfer is available for NAS devices that support NDMP Version 4.

The benefits of performing backups using NDMP include the following:

- LAN-free data transfer.
- High performance and scalable backups and restores.
- Backup to local tape devices without network traffic.

The following support is provided:

- Full file system image backup of all files within a NAS file system.
- Differential file system image backup of all files that have changed since the last full image backup.
- Parallel backup and restore operations when processing multiple NAS file systems.
- Choice of interfaces to initiate, monitor, or cancel backup and restore operations:
  - Web client (only for connections to IBM Spectrum Protect Version 8.1.1, V8.1.0, or V7.1.7 or earlier servers)
  - Backup-archive client command interface (only for connections to IBM Spectrum Protect Version 8.1.1, V8.1.0, or V7.1.7 or earlier servers)

- Administrative client command line interface (backup and restore operations can be scheduled using the administrative command scheduler)
- Administrative web client

The following functions are *not* supported:

- Archive and retrieve
- Client scheduling. Use server commands to schedule a NAS backup.
- Detection of damaged files.
- Data-transfer operations for NAS data stored by IBM Spectrum Protect:
  - Migration
  - Reclamation
  - Export
  - Backup set generation
- **AIX** | **Solaris** | **Windows** Backing up NAS file systems with the web client GUI using NDMP protocol  
For both the web client GUI and the client command line interface, you must specify passwordaccess=generate (which is a current web client restriction for the client node) and set authentication=on must be specified at the server.
- **AIX** | **Solaris** | **Windows** Back up NAS file systems using the command line  
You can use the command line to back up NAS file system images.
- **Windows** Methods for backing up and recovering data on NAS file servers accessed by CIFS protocol  
The backup-archive client can process network-attached storage (NAS) file-server data that is accessed by using the Common Internet File System (CIFS) protocol.

**Related concepts:**

NDMP support requirements (Extended Edition only)

**Related reference:**

Diffsnapshot  
Incremental  
Snapdiff  
Snapshotroot

**AIX** | **Solaris** | **Windows**

## Backing up NAS file systems with the web client GUI using NDMP protocol

---

For both the web client GUI and the client command line interface, you must specify passwordaccess=generate (which is a current web client restriction for the client node) and set authentication=on must be specified at the server.

You are always prompted for a user ID and password. To display NAS nodes and perform NAS functions, you must enter an authorized administrative user ID and password. The authorized administrative user ID should have at least client owner authority over both the NAS node and the client workstation node they are using either from command line or from the web.

You can use the toc option with the include.fs.nas option in the client options file to specify whether the client saves Table of Contents (TOC) information for each file system backup. If you save TOC information, you can use the Windows web client to examine the entire file system tree and select files and directories to restore. Creation of a TOC requires that you define the TOCDESTINATION attribute in the backup copy group for the management class to which this backup image is bound. Note that TOC creation requires additional processing, network resources, storage pool space, and possibly a mount point during the backup operation.

The web client interface is available only for connections to the IBM Spectrum Protect Version 8.1.1, V8.1.0, or V7.1.7 or earlier servers.

To back up NAS file systems using the web client GUI:

1. Click Backup from the main window. The Backup window is displayed.
2. Expand the directory tree if necessary.

Note:

- a. The root node called Nodes is not selectable. This node only appears if a NAS plug-in is present on the client workstation.
- b. NAS nodes display on the same level as the client workstation node. Only nodes for which the administrator has authority appear.
- c. You can expand NAS nodes to reveal file spaces, but no further expansion is available (no file names).

3. Click the selection boxes next to the nodes or file systems you want to back up.
4. Click the type of backup you want to perform in the backup type pull-down menu. The NAS backup type list is active only when you first select NAS backup objects. Full backup backs up the entire file system. Differential backs up the changes since the most recent full backup.
5. Click Backup. The NAS Backup Task List window displays the backup processing status and progress bar. The number next to the progress bar indicates the number of bytes backed up so far. After the backup completes, the NAS Backup Report window displays processing details, including the actual size of the backup, including the total bytes backed up.  
Note: If it is necessary to close the web browser session, current NAS operations continue after disconnect. You can use the Dismiss button on the NAS Backup Task List window to quit monitoring processing without ending the current operation.
6. (Optional) To monitor processing of an operation from the GUI main window, open the Actions menu and select IBM Spectrum Protect™ Activities. During a backup, the status bar indicates processing status. A percentage estimate is not displayed for differential backups.

Here are some items to consider when you back up NAS file systems using the web client GUI:

- Workstation and remote (NAS) backups are mutually exclusive in a Backup window. After selecting an item for backup, the next item you select must be of the same type (either NAS or non NAS).
- Details will not appear in the right-frame of the Backup window for NAS nodes or file systems. To view information about objects in a NAS node, highlight the object and select View > File Details from the menu.
- To delete NAS file spaces, select Utilities > Delete Filespaces.
- Backup options do not apply to NAS file spaces and are ignored during a NAS backup operation.

**Related concepts:**

Web client configuration overview  
Restore NAS file systems

**Related reference:**

Toc



## Back up NAS file systems using the command line

You can use the command line to back up NAS file system images.

You can use the command-line client only if you are connecting to the IBM Spectrum Protect™ Version 8.1.1, V8.1.0, and V7.1.7 or earlier servers. For IBM Spectrum Protect V8.1.2 or later servers, use server commands on the administrative command-line client (dsmadm).

Table 1 lists the commands and options that you can use to back up NAS file system images from the command line.

Table 1. NAS options and commands

Option or command	Definition	Page
domain.nas	Use the domain.nas option to specify the volumes to include in your default domain for NAS backups.	Domain.nas
exclude.fs.nas	Use the exclude.fs.nas option to exclude file systems on the NAS file server from an image backup when used with the backup nas command.  <div style="display: flex; justify-content: space-between; align-items: flex-start;"> <div style="width: 40%;"> <p><b>AIX</b>   <b>Solaris</b> This option is for AIX® and Solaris clients only.</p> <p><b>Windows</b> This option is valid for all Windows clients.</p> </div> <div style="width: 55%;"></div> </div>	Exclude options
include.fs.nas	Use the include.fs.nas option to bind a management class to Network Attached Storage (NAS) file systems. You can also specify whether Table of Contents (TOC) information is saved during a NAS file system image backup, using the <b>toc</b> option with the include.fs.nas option in your client options file.  <div style="display: flex; justify-content: space-between; align-items: flex-start;"> <div style="width: 40%;"> <p><b>AIX</b>   <b>Solaris</b> This option is for AIX and Solaris clients only.</p> <p><b>Windows</b> This option is valid for all Windows clients.</p> </div> <div style="width: 55%;"></div> </div>	Include options

Option or command	Definition	Page																	
query node	Use the query node command to display all the nodes for which a particular administrative user ID has authority to perform operations. The administrative user ID should have at least client owner authority over both the NAS node and the client workstation node they are using.	Query Node																	
backup nas	Use the backup nas command to create an image backup of one or more file systems that belong to a Network Attached Storage (NAS) file server.	Backup NAS																	
toc	Use the toc option with the backup nas command or the include.fs.nas option to specify whether Table of Contents (TOC) information is saved for each file system backup.	Toc																	
<table border="1"> <tr> <td>Mac OS X</td> <td>AIX</td> <td>Linux</td> </tr> <tr> <td>Solaris</td> <td>Windows</td> <td>monitor</td> </tr> </table> process	Mac OS X	AIX	Linux	Solaris	Windows	monitor	<table border="1"> <tr> <td>Mac OS X</td> <td>AIX</td> <td>Linux</td> <td>Solaris</td> <td>Windows</td> </tr> </table> Use the monitor process command to display current backup and restore processes for all NAS nodes for which an administrative user has authority. The administrative user can then select one process to monitor.	Mac OS X	AIX	Linux	Solaris	Windows	<table border="1"> <tr> <td>Mac OS X</td> <td>AIX</td> <td>Linux</td> </tr> <tr> <td>Solaris</td> <td>Windows</td> <td>Monitor</td> </tr> </table> Process	Mac OS X	AIX	Linux	Solaris	Windows	Monitor
Mac OS X	AIX	Linux																	
Solaris	Windows	monitor																	
Mac OS X	AIX	Linux	Solaris	Windows															
Mac OS X	AIX	Linux																	
Solaris	Windows	Monitor																	
cancel process	Use the cancel process command to display current backup and restore processes for all NAS nodes for which an administrative user has authority. From the display, the administrative user can select one process to cancel.	Cancel Process																	
query backup	Use the query backup command with the class option to display information about file system images backed up for a NAS file server.	Query Backup																	
query filesystem	Use the query filesystem command with the class option to display a list of file spaces belonging to a NAS node.	Query Filespace																	
delete filesystem	Use the delete filesystem command with the class option to display a list of file spaces belonging to a NAS node so that you can choose one to delete.	Delete Filespace																	

**Windows** A NAS file system specification uses the following conventions:

- NAS nodes represent a new node type. The NAS node name uniquely identifies a NAS file server and its data to IBM Spectrum Protect. You can prefix the NAS node name to the file specification to specify the file server to which the include statement applies. If you do not specify a NAS node name, the file system you specify applies to all NAS file servers.
- Regardless of client platform, NAS file system specifications use the forward slash (/) separator, as in this example:  
/vol/vol0.
- **Windows** NAS file system designations on the command line require brace delimiters {} around the file system names, such as: {/vol/vol0}. Do not use brace delimiters in the option file.

Note: When you initiate a NAS backup operation by using the client command line interface, client GUI, or web client the server starts a process to initiate, control, and monitor the operation. It might take several moments before you notice progress at the client command line interface because the server must perform a mount operation, and other necessary tasks, before data movement occurs.

**Related reference:**

Toc

**Windows**

## Methods for backing up and recovering data on NAS file servers accessed by CIFS protocol

The backup-archive client can process network-attached storage (NAS) file-server data that is accessed by using the Common Internet File System (CIFS) protocol.

You can use the following methods to back up and recover data on NAS devices:

- Use the backup-archive client to back up and restore data, by using CIFS to access files from the backup-archive client. Data can be stored on the IBM Spectrum Protect™ server with file-level granularity, by using the progressive-incremental backup method. The data is stored in the IBM Spectrum Protect storage hierarchy and can be migrated, reclaimed, and backed up to a copy storage pool.

This method increases processor usage when the client accesses individual files. The method requires that the data to flow through the client. This method also requires that the data flows through the IBM Spectrum Protect server unless a LAN-free configuration is used.

- Use the snapdiff option to mitigate the performance problems of CIFS backup. This option stores data with file-level granularity by using progressive incremental backup for CIFS.
- Use a backup-archive client that is running on the NAS device, if you can use external programs with the NAS operating system.

This method decreases processor usage of CIFS. Data can be stored on the IBM Spectrum Protect server with file-level granularity by using progressive-incremental backup. The data is stored in the IBM Spectrum Protect storage hierarchy and can be migrated, reclaimed, and backed up to a copy storage pool. This method requires that data flow through the backup-archive client. This method also requires that the data flows over a network and through the IBM Spectrum Protect server unless a LAN-free configuration is used.

- Use NDMP with the backup-archive client. File systems are backed up as full images (all files) or differential images (all files that changed since the last full backup). Backed up images are stored on a tape device that is accessed by the NAS file server. This method provides high performance because there is no data flow through a backup-archive client or IBM Spectrum Protect server. Data that is backed up to the server by using NDMP cannot be migrated, reclaimed, or backed up to a copy storage pool.

The following limitations exist for NAS file server data when it is accessed by using CIFS:

- File and directory security information might be inaccessible when the Windows account that is performing the backup is not a member of the Domain Administrators group of the domain the NAS file server is a trusted member of. It is also possible that these security access failures might prevent the entire file or directory from being backed up.
- Performance degradation occurs because data is being accessed remotely.
- The mapped drives appear to the client as NTFS file systems, but they might not have full NTFS functionality. For example, the encryption attribute of a file is set, but when the client backs up the file, the backup fails because the volume-level encryption setting indicates that encryption cannot be used for the volume. ReFS file systems also appear to the client as NTFS file systems.

Tip: Use NDMP with the backup-archive client on a NAS file server to back up and restore volumes instead of backing up and restoring the volumes by using remote mapped drives.

#### Related reference:

Snapdiff

Windows

## Support for CDP Persistent Storage Manager

---

Persistent Storage Manager (PSM) is the snapshot technology that is included with a number of Microsoft Server Appliance Kit-based NAS boxes that include the IBM® TotalStorage NAS 200, 300, and 300G.

You can use the backup-archive client to back up the persistent images (PI) of a volume that is produced by PSM. You must first ensure that the volume has a label. You can then use PSM to schedule or create a persistent image with a specific image name, such as `snapshot.daily`, and set the number of images to save to 1. PSM overwrites the PI as needed and you can use the client to incrementally back up the PI. In this case, the client backs up only the files that changed between snapshots. One advantage of backing up a PSM PI rather than the actual volume, is that there are no open files in the PI.

Consider the following items before you use Persistent Storage Manager:

- By default, a PSM schedule uses a variable name (`snapshot.%i`) and keeps a number of images.  
Important: Do not use the client with PSM in this manner. The client considers each image as unique and makes a complete copy of each image.
- The client requires that the volume used to make the PI has a label. If the volume does not have a label, the client does not back up its PI.
- You use the image backup function to back up the original volume that is used to create the PI. However, you cannot use the backup image function to back up the PI.

- To avoid backing up unnecessary files when you back up PSM, include the following entries in your client option file (dsm.opt):

```
exclude.dir "Persistent Storage Manager State"
exclude.file "*.psm"
exclude.file "*.otm"
```

AIX

Linux

Mac OS X

Solaris

## Backup network file systems

You can configure the backup-archive client to protect files that are accessed with either Network File System (NFS) or Common Internet File System (CIFS) protocols.

Backup performance is better when you install the backup-archive client where the file system physically exists. But sometimes it is necessary to access file systems by using NFS or CIFS to back up or recover data on remote shared drives. The backup-archive client on AIX®, Linux, Mac OS X, and Solaris operating systems can back up, archive, restore, and retrieve file data on an NFS or CIFS-mounted shared drive. The operations are valid on all versions of the NFS protocol, including NFS version 2, NFS version 3, and NFS version 4.

The backup-archive can back up and restore access control lists when it is configured to use NFS version 4.

The following restrictions apply when the backup-archive client protects data on network file system volumes:

- Backup-archive clients cannot complete image backups of network file system volumes.
- Backup-archive clients on AIX cannot complete snapshot-based file backups or archive files on network file system volumes.
- Backup-archive clients cannot complete journal-based backups of network file system volumes.
- Backup-archive clients might not be able to back up NetApp volume snapshots if they are accessed by using the NFS protocol. If the NetApp filer provides different device identifiers for its volume snapshots, these snapshots might be excluded from backups. The behavior depends on the OS version, the NetApp filer version, and the settings.
- |          |     |       |         |
|----------|-----|-------|---------|
| Mac OS X | AIX | Linux | Solaris |
|----------|-----|-------|---------|

 Back up NFS file systems with the global namespace feature  
NFS V4 clients can back up NFS file systems that are mounted by using the global namespace feature, which is called a *referral*. All file systems in the global namespace are backed up under a single file space.

AIX

## Back up AIX workload partition file systems

Using the backup-archive client on AIX®, you can back up and restore local partition file data within the global partition by using the local partition name space available within the global partition.

Each workload partition (WPAR) has its own security domain, so only the global root user is guaranteed to have access to all of the data.

The WPARs are partitions that are created entirely in software within a single AIX system image, with the following attributes:

- Usually the WPAR appears to be a complete stand-alone AIX system
- There is no hardware assist or configuration

Workload partitions provide a secure and isolated environment for enterprise applications in terms of process, signal, and file system space. Software running within the context of a workload partition appears to have its own separate instance of AIX.

The following example shows a WPAR configuration from within the global WPAR:

Global partition:

```
System name: shimla
File system: /home /opt
```

WPAR #1 configuration:

```
Name: wpar1
File system: /home; name in global WPAR: /wpars/wpar1/home
```

WPAR #2 configuration:

```
Name: wpar2
File system: /data; name in global WPAR: /wpars/wpar2/data
```

There are two ways to back up WPAR data, as follows:

- Back up all WPAR file systems as the file spaces within the global partition. The file space name must be used to identify the WPAR to which it belongs. All of the data is managed on one node by using one schedule. Using the example configuration, here is a sample `dsm.sys` file with one server stanza for all file systems, both global and local:

```
SErvername  shimla
TCPPort    1500
TCPSeveraddress  server.example.com
nodename   shimla
PasswordAccess  generate
Domain     /wpars/wpar1/home /wpars/wpar2/data /home /opt
```

- Back up each WPAR file system under a different node name. This method provides file space name segregation for each WPAR. Each WPAR must have a separate node name and a scheduler that is running within the global partition. Also, three scheduler services must be set up, each using a different `dsm.opt` file corresponding to the server stanza name. This method allows each WPAR backup operation to be managed independently of the others. Using the example configuration, here is a sample `dsm.sys` file with three server stanzas: one for `wpar1`, one for `wpar2`, and one for global partition `shimla`:

```
SErvername  shimla_wpar1
TCPPort    1500
TCPSeveraddress  server.example.com
nodename   wpar1
PasswordAccess  generate
Domain     /wpars/wpar1/home

SErvername  shimla_wpar2
TCPPort    1500
TCPSeveraddress  server.example.com
nodename   wpar2
PasswordAccess  generate
Domain     /wpars/wpar2/data

SErvername  shimla
TCPPort    1500
TCPSeveraddress  server.example.com
nodename   shimla
PasswordAccess  generate
Domain     /home /opt
```

Solaris

## Backing up Solaris Zettabyte file systems

On Solaris SPARC and Solaris x86 systems, you can backup Zettabyte file systems (ZFS), by using ZFS snapshots. The advantage of this approach, over an ordinary incremental or selective backup, is that the files and folders in a snapshot are always in a read-only state, so they cannot be changed during a backup.

### About this task

You create a ZFS snapshot by using Oracle Solaris ZFS commands. For example:

```
zfs snapshot tank/myZFS@mySnapshot
```

In this example, the ZFS pool name is called `tank` and the ZFS file system name is `myZFS`. Files that belong to this ZFS snapshot are in the subdirectory named `tank/myZFS/.zfs/snapshot/mySnapshot/`.

### Procedure

Use either of these two methods to backup a ZFS snapshot.

- Backup each file of the snapshot by using the `snapshotroot` option. For example:

```
dsmc inc -snapshotroot=/tank/myZFS/.zfs/snapshot/mySnapshot /tank/myZFS
```

This option allows the administrator to replace the current snapshot path with the ZFS file system path, so that the files and folders are backed up under the original file system.

- Backup the complete snapshot by using Oracle Solaris ZFS commands. For example:

```
zfs send tank/myZFS@mySnapshot > /tmpdir/mySnapshotFile
```

The advantage of backing up the complete snapshot is that the full file system can be restored, in a disaster recovery scenario.

**Related concepts:**

Restoring Solaris Zettabyte (ZFS) file systems

**Related reference:**

Snapshotroot

AIX

## AIX JFS2 encrypted file system backup

---

Use AIX® JFS2 Encrypted File System (EFS) to back up files either in clear text or raw format. With clear text format, the file is decrypted by EFS as it is read. With raw format, the data is not decrypted. The default is raw format, but when you set the `efsdecrypt` option to yes, you get clear text backups.

### About this task

---

**Important:** Whenever you run a backup that includes any files encrypted on an EFS, you must ensure that you use the correct specification of the `efsdecrypt` option. If the `efsdecrypt` option value changes between two incremental backups, all encrypted files on EFS file systems are backed up again, even if they have not changed since the last backup. For example, if you are running an incremental backup of encrypted files that were previously backed up as raw, then ensure that `efsdecrypt` is specified as no. If you change `efsdecrypt` to yes, all of the files are backed up again in clear text even if they are unchanged, so ensure that you use this option carefully.

If you attempt to restore an encrypted file to either a work station that does not support EFS, or a file system where EFS is not active, an error message is written and the file is skipped.

Here are some reasons to back up EFS using clear text encryption:

- This type of decryption is useful if you want to use the IBM Spectrum Protect™ backup-archive client encryption or another type of hardware encryption (for tape systems, for example).
- You can use clear text for long term archival of data, because the data is stored independent of the platform or encryption scheme.

Here are some things to consider when backing up a file in clear text:

- The user who invoked the backup-archive client must be able to decrypt it
- The user can have read access to a file, but not have access to the key

In the following scenarios an error message is issued:

### Procedure

---

1. The user is running in root guard mode, and EFS has the concept of two types of root. Root admin is the traditional mode. A root in guard mode will not have access to the unencrypted data, unless the user is the owner or a member of the file group.
2. The user is running with a non-root user ID and attempting an archive of a file to which they have read access, but the user is not the owner or member of the file group. EFS will not allow the data to be decrypted.

### Results

---

Here are some considerations when backing up EFS raw data:

- The backup-archive client will not honor the client encryption setting, which prevents double encryption, but only at the client. The server has no knowledge that the data is encrypted so any encryption done by a tape drive, for example, still occurs.
- The client will not honor the compression setting, so the client will not even try to compress the data.
- The client does not automatically back up or restore the keystore files. When you are restoring encrypted files, you might also have to restore keystores in order to decrypt the data.

**Tips:**

1. To protect the keystore, make sure the contents of `/var/efs` are included in your periodic backups.



- 2. For the keystore data, use IBM Spectrum Protect storage policy with an unlimited number of versions.
- Encrypted file system (EFS) files backed up in raw mode (default) cannot be restored by a backup-archive client prior to V5.5, or by a client on another UNIX platform.

AIX

## Back up AIX JFS2 extended attributes

AIX® Enhanced Journal File System (JFS2) provides backup processing for named extended attributes for all file systems that support named extended attributes.

These extended attributes are automatically backed up with each object that contains extended attributes data, and no additional action is required.

When the file system is defined with the v2 format, the only file system that supports named extended attributes is JFS2. You can use JFS2 for extended attributes for files and directories, but you cannot use JFS2 for extended attributes on symbolic links.

Linux | Windows

## Backing up VMware virtual machines

You can use the backup-archive client to back up and restore a VMware virtual machine (VM). Full backups of the virtual machine operate at a disk image level. Incremental backups copy only the data that is changed since the previous full backup.

 This feature is available only if the client operates as a data mover for IBM Spectrum Protect™ for Virtual Environments: Data Protection for VMware.

**Linux** Table 1 lists the backup and restore capabilities for VMware virtual machines that the backup-archive client can implement on Linux platforms.

Table 1. Backup and restore capabilities for VMware virtual machines on Linux platforms

Capability	Comment
Full VM incremental-forever backup:	<p>A full VM backup is required before you can create incremental backups. If you schedule incremental-forever backups, this backup type is selected automatically for the first backup if a full backup was not already created. Data from incremental backups is combined with data from the full backup to create a synthetic full backup image. Subsequent full VM incremental-forever backups read all used blocks and copy those blocks to the IBM Spectrum Protect server. Each full VM incremental-forever backup reads and copies all of the used blocks, whether the blocks are changed or not since the previous backup. You can still schedule a full VM backup, although a full backup is no longer necessary. For example, you might run a full VM backup to create a backup to a different node name with different retention settings.</p> <p>You cannot use this backup mode to back up a VMware virtual machine if the client is configured to encrypt the backup data.</p>

Capability	Comment
Incremental-forever-incremental VM backup:	<p>Requires you to create a full VM backup one time only. The full VM backup copies all of the used disk blocks owned by a virtual machine to the IBM Spectrum Protect server. After the initial full backup is complete, all subsequent backups of the virtual machine are incremental-forever-incremental backups. Each incremental-forever-incremental backup copies only the blocks that are changed since the previous backup, irrespective of the type of the previous backup. The server uses a grouping technology that associates the changed blocks from the most recent backup with data already stored on the server from previous backups. A new full backup is then effectively created each time changed blocks are copied to the server by an incremental-forever-incremental backup.</p> <p>The incremental-forever-incremental backup mode provides the following benefits:</p> <ul style="list-style-type: none"> <li>• Improves the efficiency of backing up virtual machines.</li> <li>• Simplifies data restore operations.</li> <li>• Optimizes data restore operations.</li> </ul> <p>During a restore operation, you can specify options for point-in-time and point-in-date to recover data. The data is restored from the original full backup and all of the changed blocks that are associated with the data.</p> <p>You cannot use this backup mode to back up a VMware virtual machine if the client is configured to encrypt the backup data.</p>
Item recovery for files and folders from a full backup of the virtual machine:	Provides the capability to recover files and folders from a full backup of a virtual machine. Item recovery is available only with the IBM Spectrum Protect recovery agent.
Full restore of the virtual machine:	Restores all of the file systems, virtual disks, and the virtual machine configuration.

**Windows** Table 2 lists the backup and restore operations for VMware virtual machines that the backup-archive client can implement on Windows platforms.

Restriction: You can complete VMware backup and restore operations with the backup-archive client only on 64-bit Windows operating systems.

Table 2. Backup and restore capabilities for VMware virtual machines on Windows platforms

Capability	Comment
Full VM incremental-forever backup:	<p>Requires the IBM Spectrum Protect for Virtual Environments licensed product.</p> <p>A full VM backup is required before you can create incremental backups. If you schedule incremental-forever backups, this backup type is selected automatically for the first backup if a full backup was not already created. Data from incremental backups is combined with data from the full backup to create a synthetic full backup image. Subsequent full VM incremental-forever backups read all used blocks and copy those blocks to the IBM Spectrum Protect server. Each full VM incremental-forever backup reads and copies all of the used blocks, whether the blocks are changed or not since the previous backup. You can still schedule a full VM backup, although a full backup is no longer necessary. For example, you might run a full VM backup to create a backup to a different node name with different retention settings.</p> <p>You cannot use this backup mode to back up a VMware virtual machine if the client is configured to encrypt the backup data.</p>

Capability	Comment
Incremental-forever-incremental VM backup:	<p>Requires the IBM Spectrum Protect for Virtual Environments licensed product.</p> <p>Requires you to create a full VM backup one time only. The full VM backup copies all of the used disk blocks owned by a virtual machine to the IBM Spectrum Protect server. After the initial full backup is complete, all subsequent backups of the virtual machine are incremental-forever-incremental backups. Each incremental-forever-incremental backup copies only the blocks that are changed since the previous backup, irrespective of the type of the previous backup. The server uses a grouping technology that associates the changed blocks from the most recent backup with data already stored on the server from previous backups. A new full backup is then effectively created each time changed blocks are copied to the server by an incremental-forever-incremental backup.</p> <p>The incremental-forever-incremental backup mode provides the following benefits:</p> <ul style="list-style-type: none"> <li>• Improves the efficiency of backing up virtual machines.</li> <li>• Simplifies data restore operations.</li> <li>• Optimizes data restore operations.</li> </ul> <p>During a restore operation, you can specify options for point-in-time and point-in-date to recover data. The data is restored from the original full backup and all of the changed blocks that are associated with the data.</p> <p>You cannot use this backup mode to back up a VMware virtual machine if the client is configured to encrypt the backup data.</p>
Item recovery for files and folders from a full backup of the virtual machine:	<p>Requires the IBM Spectrum Protect for Virtual Environments licensed product.</p> <p>Provides the capability to recover files and folders from a full backup of a virtual machine. Item recovery is available only with the IBM Spectrum Protect recovery agent.</p>
Full restore of the virtual machine:	Restores all of the file systems, virtual disks, and the virtual machine configuration.
File-level restore of the virtual machine:	<p>The restore approach depends on the type of backup of the virtual machine:</p> <ul style="list-style-type: none"> <li>• If you have a license for IBM Spectrum Protect for Virtual Environments, you can restore files and directories from a full VM image backup.</li> <li>• Backup-archive client users can restore files and directories that are created file-level backups of a virtual machine. You use the restore command to restore individual files from a file-level backup of a virtual machine, not the restore vm command.</li> </ul> <p>Note: File-level backups were created with the version 7.1 or earlier backup-archive clients.</p>

- **Linux | Windows** Preparing the environment for full backups of VMware virtual machines  
Complete the following steps to prepare the VMware environment for backing up full VMware virtual machines. The vStorage backup server can run either a Windows or Linux client.
- **Linux | Windows** Creating full backups for VMware virtual machines  
A full backup of a VMware virtual machine is a backup of an entire virtual machine, including the virtual disks and the virtual machine configuration file. This type of backup is similar to an image backup. To create the full backup, you configure the backup-archive client on the vStorage backup server. The vStorage backup server must run a Windows client or a Linux client.
- **Linux | Windows** Parallel backups of virtual machines  
With parallel backup processing, you can use a single data mover node to back up multiple virtual machines (VMs) at the same time to optimize your backup performance.

**Linux | Windows**

## Preparing the environment for full backups of VMware virtual machines

Complete the following steps to prepare the VMware environment for backing up full VMware virtual machines. The vStorage backup server can run either a Windows or Linux client.

## Before you begin

 This feature is available only if the client operates as a data mover for IBM Spectrum Protect™ for Virtual Environments: Data Protection for VMware.

## Procedure

1. To configure the storage environment for backing up, complete the following steps:
  - a. Configure your storage environment so that the vStorage backup server can access the storage volumes that are in your ESX server farm.
  - b. If you are using network-attached storage (NAS) or direct-attach storage, ensure that the vStorage backup server is accessing the volumes with a network-based transport.
  - c. Optional: For data access, make the following settings:
    - Create storage area network (SAN) zones that your vStorage backup server can use to access the storage logical units (LUNs) that host your VMware datastores.
    - Configure your disk subsystem host mappings so that all ESX servers and the backup proxy can access the same disk volumes.
2. To configure the vStorage backup server, complete the following steps:
  - a. **Linux** Set and export the LD\_LIBRARY\_PATH environment variable to point to the client installation directory. For example:

```
export LD_LIBRARY_PATH=/opt/tivoli/tsm/client/ba/bin
```

- b. **Linux** Add the client installation directory to the path of each account that uses backup-archive client commands, for example, dsmc, dsmcad, or dsmj.
- c. **Windows** When the backup-archive client runs on a vStorage backup server, this client configuration is called the IBM Spectrum Protect *data mover node*. A Windows system that is a data mover must have the 64-bit Windows client installed on it. A data mover node typically uses the SAN to back up and restore data. If you configure the data mover node to directly access the storage volumes, turn off automatic drive letter assignment. If you do not turn off letter assignments, the client on the data mover node might corrupt the Raw Data Mapping (RDM) of the virtual disks. If the RDM of the virtual disks is corrupted, backups fail. Consider the following conditions for restore configurations:

The data mover node is on a Windows Server 2012 or Windows Server 2012 R2 system:

If you plan to use the SAN to restore data, you must set the Windows SAN policy to OnlineAll. Run diskpart.exe and type the following commands to turn off automatic drive letter assignment and set the SAN policy to OnlineAll:

```
diskpart
  automount disable
  automount scrub
  san policy OnlineAll
exit
```

The backup-archive client is installed in a virtual machine on a Windows Server 2012 or Windows Server 2012 R2 system:

If you plan to use the hotadd transport to restore data from dynamically added disks, the SAN policy on that system must also be set to OnlineAll.

Whether the client uses the SAN or hotadd transport, the Windows SAN policy must be set to OnlineAll. If the SAN policy is not set to OnlineAll, restore operations fail, and the following message is returned:

```
ANS9365E VMware vStorage API error.
IBM Spectrum Protect function name: vddksdk Write
IBM Spectrum Protect file : vmvddksk.cpp (2271)
API return code : 1
API error message : Unknown error
ANS0361I DIAG: ANS1111I VmRestoreExtent(): VixDiskLib_Write
FAILURE startSector=512 sectorSize=512 byteOffset=262144,
rc=-1
```

For a description of the vStorage transport settings and how you can override the defaults, see the following topic:

**Linux** | **Windows** | [Vmvstortransport](#)

- d. **Windows** Install the backup-archive client on the vStorage backup server. At the custom setup page of the installation wizard, select VMware vStorage API runtime files.

Important: If you are moving the backup data by using backups that are not in a LAN, the SAN must have separate connections for tape and disk.

3. To modify IBM Spectrum Protect, complete the following steps:

- a. Access the administrative command line on the backup-archive client.
- b. From the backup-archive client on the vStorage backup server, run the following command to register the node:

```
register node my_server_name my_password
```

Where *my\_server\_name* is the full computer name of the vStorage backup server and *my\_password* is the password to access the server.

**Windows** Tip: On Windows systems, you can get the server full computer name by right-clicking on My Computer. Click the Computer Name tab and look at the name listed next to Full computer name.

- c. **Windows** From the backup-archive client on the vStorage backup server, run the following command to register the node:

```
register node my_vm_name my_password
```

Where *my\_vm\_name* is the full name of the virtual machine that you are backing up.

4. **Windows** If you back up a virtual machine where volumes are mounted to directories rather than drive letters, files might not be stored in the correct location. An error might be caused because the mount point does not correspond to the actual mount points of backed up files. An error is caused because the mount points for a virtual machine that is running Windows do not have a drive letter assignment. When you use the VMware vStorage APIs for Data Protection, a *filesystem* name is created that includes a number assignment. The *filesystem* names that are created for the mount point do not correspond to the actual mount points of the backed up file.

To back up or restore files to their original location, use the following steps:

- a. To restore files to their original location, map the drive or assign a drive letter to the mount point from the virtual machine.
- b. If you restore a file that the vStorage API renamed, select a different restore location.
- c. When using mount points without drive letter assignments, use an include or exclude statement for that volume. See the following example of an exclude statement:

```
exclude \\machine\3$\dir1\...\*.doc
```

#### Related tasks:

**Linux** | **Windows** [Creating full backups for VMware virtual machines](#)

#### Related reference:

<b>Linux</b>	<b>Windows</b>	<a href="#">Backup VM</a>
<b>Linux</b>	<b>Windows</b>	<a href="#">Query VM</a>
<b>Linux</b>	<b>Windows</b>	<a href="#">Restore VM</a>
<b>Linux</b>	<b>Windows</b>	<a href="#">Vmchost</a>
<b>Linux</b>	<b>Windows</b>	<a href="#">Vmcpw</a>
<b>Linux</b>	<b>Windows</b>	<a href="#">Vmcuser</a>
<b>Linux</b>	<b>Windows</b>	<a href="#">Vmvstortransport</a>
<b>Linux</b>	<b>Windows</b>	

## Creating full backups for VMware virtual machines

A full backup of a VMware virtual machine is a backup of an entire virtual machine, including the virtual disks and the virtual machine configuration file. This type of backup is similar to an image backup. To create the full backup, you configure the backup-archive client on the vStorage backup server. The vStorage backup server must run a Windows client or a Linux client.

### Before you begin

 This feature is available only if the client operates as a data mover for IBM Spectrum Protect™ for Virtual Environments: Data Protection for VMware.

### Procedure

1. To prepare the environment, complete the steps in the following topic:

Preparing the environment for full backups of VMware virtual machines

2. To configure the backup-archive client on the vStorage backup server, complete the following steps:
  - a. From the welcome page of the backup-archive client GUI, click Edit > Client Preferences.
  - b. Select the VM Backup tab.
  - c. Select VMWare Full VM.
  - d. In the Domain Backup Types list, select Domain Full VM.
  - e. In the Host field, enter either the host name of each ESX server or the host name of the Virtual Center. If you specify the Virtual Center, you can back up virtual machines from any of the VMware servers that are managed by the Virtual Center.
  - f. Enter the user ID and password information for the host that you specify in the Host field.
  - g. Optional: If you want to override the default management class for full virtual machine backups, specify the management class that you want to use.
  - h. In the Datastore Location field, enter the path to the directory where the files are stored.
  - i. Click OK to save your changes.
3. To create a backup of one of the virtual machines, complete the following steps:
  - a. At the command line of the vStorage backup server, run the following command:

```
dsmc backup vm my_vm_name -mode=iffull -vmbackuptype=fullvm
```

Where *my\_vm\_name* is the name of the virtual machine.

- b. Verify that the command is completed without errors. The following message indicates successful completion:

```
Backup VM command complete
Total number of virtual machines backed up successfully: 1
virtual machine vmname backed up to nodename NODE
Total number of virtual machines failed: 0
Total number of virtual machines processed: 1
```

4. **Linux** To verify that you can restore the files for the virtual machine, complete the following steps:
  - a. At the command-line interface of the vStorage backup server, run the following command:

```
dsmc restore vm my_vm_name
```

- b. If errors occur in the restore processing, view the client error log for more information.

Tip: The log file is saved to `/opt/ibm/Tivoli/TSM/baclient/dsmerror.log`

5. **Windows** To verify that you can restore the files for the virtual machine, complete the following steps:
  - a. At the command-line interface of the vStorage backup server, run the following command:

```
dsmc restore vm my_vm_name
```

**Windows** The default location of the restore is in the following directory:

```
c:\mnt\tsmvmbackup\my_vm_name\fullvm\RESTORE_DATE_yyyy_mm_dd[hh_mm_ss].
```

- b. If errors occur in the restore processing, view the client error log for more information.

Tip: The error log is saved to the following file:

```
c:\Program Files\Tivoli\TSM\baclient\dsmerror.log
```

#### Related concepts:

**Linux** | **Windows** Parallel backups of virtual machines

#### Related tasks:

**Linux** | **Windows** Preparing the environment for full backups of VMware virtual machines

#### Related reference:

**Linux** | **Windows** Backup VM  
**Linux** | **Windows** Domain.vmfull  
**Linux** | **Windows** Query VM  
**Linux** | **Windows** Restore VM  
**AIX** | **Linux** | **Solaris** | **Windows** Mode  
**Linux** | **Windows** Vmchost  
**Linux** | **Windows** Vmcpw  
**Linux** | **Windows** Vmcuser  
**Linux** | **Windows** Vmmc  
**Linux** | **Windows** Vmvsstortransport  
**Linux** | **Windows**

## Parallel backups of virtual machines

With parallel backup processing, you can use a single data mover node to back up multiple virtual machines (VMs) at the same time to optimize your backup performance.

 This feature is available only if the client operates as a data mover for IBM Spectrum Protect™ for Virtual Environments.

For information about parallel backup operations, see [Backing up multiple virtual machines in parallel](#).

Windows

## Back up virtual machines on a Hyper-V system

---

You can use the backup-archive client to backup virtual machines that are managed by a Microsoft Hyper-V server.

For information about protecting Hyper-V virtual machines, see [IBM Spectrum Protect™ for Virtual Environments, Data Protection for Microsoft Hyper-V](#).

- **Windows** Hyper-V backup support limitations  
Because of the tight integration of Microsoft Failover Clustering with Cluster Shared Volumes and Hyper-V, the following limitations apply when you are using the backup-archive client.

Linux

Windows

## Back up and archive Tivoli Storage Manager FastBack data

---

Use Tivoli® Storage Manager FastBack to back up and archive the latest snapshots for short-term retention.

Use the archive fastback and backup fastback commands to archive and back up volumes that are specified by the fbpolycname, fbclientname and fbvolumename options for short-term retention.

### Related concepts:

[Installation requirements for backing up and archiving Tivoli Storage Manager FastBack client data](#)

[Configuring the client to back up and archive Tivoli Storage Manager FastBack data](#)

### Related reference:

[Fbclientname](#)

[Fbpolicname](#)

[Fbvolumename](#)

Windows

## Backing up Net Appliance CIFS share definitions

---

Network Appliance (NetApp) CIFS share definitions include share permissions that are set on the file server.

### About this task

---

The Windows client backs up the CIFS share definition under the root directory, the mapped CIFS share, or the UNC name. This support requires that the Net Appliance file server is running DATA ONTAP software, which presents CIFS shares to remote clients as ordinary remote NTFS shares.

The root directory of a CIFS share is backed up with a full progressive incremental backup of the mapped drive/UNC name. See the following two examples:

```
net use x: \\NetAppFiler\CifsShareName
dsmc incr x:

dsmc incr \\NetAppFiler\CifsShareName
```

The following output is displayed when the root directory (and share definition) is backed up:

```
Directory-->          0 \\NetAppFiler\CifsShare\ [Sent]
```

### Related concepts:

[Restore Net Appliance CIFS shares](#)

### Related reference:

[Snapdiff](#)

## Display backup processing status

During a backup, by default the backup-archive client displays the status of each file it attempts to back up.

The client reports the size, path, file name, total number of bytes transferred, and whether the backup attempt was successful for the file. These are also recorded in the `dsmsched.log` file for scheduled commands.

**Mac OS X | AIX | Linux | Solaris** The web client and backup-archive client Java™ GUI provide a Task List window that displays information about files during processing. When a task completes, a Backup Report window displays processing details. Click the Help button in the Backup Report window for context help.

**Windows** The web client and backup-archive client GUI provide a Task List window that displays information about files during processing. When a task completes, a Backup Report window displays processing details. Click the Help button in the Backup Report window for context help.

On the backup-archive command line, the name of each file is displayed after it is sent to the server. The progress indicator shows overall progress.

Table 1 lists some informational messages and meanings.

Table 1. Client command line informational messages

Informational message	Meaning
Directory-->	Indicates the directory that you back up.
<b>Mac OS X   AIX   Linux   Solaris</b> Normal File-->.	<b>Mac OS X   AIX   Linux   Solaris</b> Any file that is not a directory, symbolic link, or special file.
<b>Mac OS X   AIX   Linux   Solaris</b> Special File-->	<b>Mac OS X   AIX   Linux   Solaris</b> Special files define devices for the system or temporary files that are created by processes. There are three basic types of special files: FIFO (first-in, first-out), block, and character. FIFO files are also called pipes. Pipes are created by one process to temporarily allow communication with another process. These files cease to exist when the first process finishes. Block and character files define devices. The client processes only device and named pipe special files. Socket special files are not processed.
<b>Mac OS X   AIX   Linux   Solaris</b> Symbolic Link-->	<b>Mac OS X   AIX   Linux   Solaris</b> Indicates that the client backs up a symbolic link.
Updating-->	Indicates that only the file meta data is sent, not the data itself.
Expiring-->	Indicates an object (file or directory) on the server that no longer exists on the client is expired and made inactive on the server.
Total number of objects inspected:	As indicated. When using journal-based backup, the number of objects that are inspected might be less than the number of objects that are backed up.  When you use the snapshot difference incremental backup, the number of objects that are inspected is zero. The number is zero because the client performs an incremental backup of the files that NetApp reported as changed. The client does not scan the volume looking for files that have changed.
Total number of objects backed up:	As indicated.
Total number of objects encrypted:	This is a count of the objects that were encrypted during backup or archive processing.
Data encryption type:	Specifies the encryption algorithm type (e.g 256-bit AES), if one or more objects are encrypted during backup or archive processing.
Total number of objects updated:	These are files whose attributes, such as file owner or file permissions, have changed.
Total number of objects rebound:	See Bind management classes to files for more information.
Total number of objects deleted:	This is a count of the objects that are deleted from the client workstation after being successfully archived on the server. The count is zero for all backup commands.
Total number of objects expired:	See the section about full and partial incremental backup for more information.



Informational message	Meaning
Total number of objects failed:	Objects can fail for several reasons. Check the <code>dsmerror.log</code> for details.
<b>AIX</b> <b>Linux</b> <b>Windows</b> Total snapshot difference objects:	<b>AIX</b> <b>Linux</b> <b>Windows</b> For snapshot difference incremental backups, this represents the total number of objects backed up and the total number of objects expired.
Total objects deduplicated:	Specifies the number of files that are deduplicated.
<b>AIX</b> <b>Linux</b> <b>Mac OS X</b> <b>Solaris</b> Total number of bytes inspected:	<b>AIX</b> <b>Linux</b> <b>Mac OS X</b> <b>Solaris</b> Specifies the sum of the sizes of the files that are selected for the operation. For example, the total number of bytes that are inspected for this command is the number of bytes that are used on the volume <code>/Volumes/BUILD</code> :  <code>dsmc INCREMENTAL /Volumes/BUILD/* -SU=Yes</code>
Total bytes before deduplication:	Specifies the number of bytes to send to the IBM Spectrum Protect™ server if the client does not eliminate redundant data. Compare this amount with <code>Total bytes after deduplication</code> . Includes metadata size and might be greater than bytes inspected.
Total bytes after deduplication:	Specifies the number of bytes that are sent to the IBM Spectrum Protect server after deduplication of the files on the client computer. Includes metadata size and might be greater than bytes processed.
<b>Windows</b> Total number of bytes inspected:	<b>Windows</b> Specifies the sum of the sizes of the files that are selected for the operation. For example, the total number of bytes inspected for this command is the number of bytes used in the directory <code>C:\Users</code>  <code>dsmc.exe INCREMENTAL C:\Users\* -su=yes</code>
Total number of bytes processed:	Specifies the sum of the sizes of the files that are processed for the operation.
Data transfer time:	The total time to transfer data across the network. Transfer statistics might not match the file statistics if the operation was retried due to a communications failure or session loss. The transfer statistics display the bytes attempted to be transferred across all command attempts.
Network data transfer rate:	The average rate at which the network transfers data between the client and the server. This is calculated by dividing the total number of bytes transferred by the time to transfer the data over the network. The time it takes to process objects is not included in the network transfer rate. Therefore, the network transfer rate is higher than the aggregate transfer rate.

Informational message	Meaning
Aggregate data transfer rate:	<p>The average rate at which IBM Spectrum Protect and the network transfer data between the client and the server. This is calculated by dividing the total number of bytes transferred by the time that elapses from the beginning to the end of the process. Both IBM Spectrum Protect processing and network time are included in the aggregate transfer rate. Therefore, the aggregate transfer rate is lower than the network transfer rate.</p> <p><b>Windows Note:</b> On occasion, the aggregate data transfer rate might be higher than the network data transfer rate. This is because the backup-archive client can have multiple simultaneous sessions with the backup server. If you set the resourceutilization option, the client attempts to improve performance and load balancing by using multiple sessions when it backs up a volume or other set of files. When multiple sessions are open during backup, the data transfer time represents the sum of the times reported by all sessions. In this case, aggregate data transfer time is incorrectly reported as higher. However, when running with a single session, the aggregate data transfer rate should always be reported as lower than the network data transfer rate.</p> <p><b>Mac OS X   AIX   Linux   Solaris</b></p> <p>Note: On occasion, the aggregate data transfer rate might be higher than the network data transfer rate. This is because the backup-archive client can have multiple simultaneous sessions with the backup server. If you set the resourceutilization option, the client attempts to improve performance and load balancing by using multiple sessions when it backs up a file space or other set of files. When multiple sessions are open during backup, the data transfer time represents the sum of the times reported by all sessions. In this case, aggregate data transfer time is incorrectly reported as higher. However, when running with a single session, the aggregate data transfer rate should always be reported as lower than the network data transfer rate.</p>
Objects compressed by:	Specifies the percentage of data sent over the network divided by the original size of the file on disk. For example, if the net data-bytes are 10K and the file is 100K, then Objects compressed by: == (1 - (10240/102400)) x 100 == 90%.
Total number of objects grew:	The total number of files that grew larger as a result of compression.
Deduplication reduction:	Specifies the size of the duplicate extents that were found, divided by the initial file or data size. For example, if the initial object size is 100 MB, after deduplication it is 25 MB. The reduction would be: (1 - 25/100) * 100 = 75%.
Total data reduction ratio:	Adds incremental and compression effects. For example, if the bytes inspected are 100 MB and the bytes sent are 10 MB, the reduction would be: (1 - 10/100) * 100 = 90%
Elapsed processing time:	The active processing time to complete a command. This is calculated by subtracting the starting time of a command process from the ending time of the completed command process.
Total number of bytes transferred:	As indicated.
<b>AIX   Linux   Solaris   Windows</b> LanFree bytes transferred:	<b>AIX   Linux   Solaris   Windows</b> The total number of data bytes transferred during a lan-free operation. If the enablelanfree option is set to <i>no</i> , this line will not appear.
Total number of bytes inspected:	A sum of sizes of files selected for the operation.
Total number of retries:	The total number of retries during a backup operation. Depending on the settings for the serialization attribute and the changingretries option, a file that is opened by another process might not be backed up on the first backup try. The backup-archive client might try to back up a file several times during a backup operation. This message indicates the total retries for all files that are included in the backup operation.

**Windows**

## Backup (Windows): Additional considerations

---

This section discusses additional information to consider when backing up data.

- **Windows** Open files  
Some files on your system might be in use when you try to back them up. These are called *open files* because they are locked by an application for its exclusive use.
- **Windows** Ambiguous file space names in file specifications  
If you have two or more file spaces such that one file space name is the same as the beginning of another file space name, then an ambiguity exists when you try to restore, retrieve, query, or do another operation that requires the file space name as part of the file specification.
- **Windows** Management classes  
IBM Spectrum Protect uses management classes to determine how to manage your backups on the server.
- **Windows** Deleted file systems  
When a file system or drive has been deleted, or it is no longer backed up by the client, the existing backup versions for each file are managed according to the following policy attributes: Number of days to keep inactive backup versions, and number of days to keep the last backup version (if there is no active version).
- **Windows** Removable media backup  
The backup-archive client backs up your removable media (such as tapes, cartridges or diskettes) based on the drive label, not the drive letter.
- **Windows** Fixed drives  
The backup-archive client can back up your fixed drives even if they do not have a label, including drive aliases created with the DOS **subst** command. This applies to both the drive alias and the underlying physical drive, because the alias name and the physical drive label are the same.
- **Windows** NTFS and ReFS file spaces  
When you back up files on NTFS or ReFS partitions, the client also backs up file security information and file descriptors.
- **Windows** Universal Naming Convention names  
A Universal Naming Convention (UNC) name is a network resource name for a share point on a workstation.
- **Windows** Microsoft Dfs file protection methods  
There are some methods that you can use to protect the data in your Microsoft Dfs environment.

**Windows**

## Open files

---

Some files on your system might be in use when you try to back them up. These are called *open files* because they are locked by an application for its exclusive use.

It is not very common for files to be opened in locked mode. An application can open a file in this way to avoid other applications or users from reading or accessing the file, but it can prevent backup programs from reading the file for backup.

You might not always want to use the open file feature to back up open or locked files. Sometimes an application opens a file or group of files in this locked mode to prevent the access of these files in an inconsistent state.

To avoid the increase of processor usage when you create a volume snapshot for each backup, and on platforms where the open file feature is not available or is not in use, consider the following points:

- If the file is unimportant or can be easily rebuilt (a temporary file for example), you might not care if the file is backed up, and might choose to exclude it.
- If the file is important:
  - Ensure the file is closed before backing it up. If backups are run according to a schedule, use the `preschedulecmd` option to enter a command that closes the file. For example, if the open file is a database, issue a command to close the database. You can use the `postschedulecmd` option to restart the application that uses the file after the backup completes. If you are not using a schedule for the backup, close the application that uses the file before you start the backup.
  - The client can back up the file even if it is open and changes during the backup. This is only useful if the file is usable even if it changes during backup. To back up these files, assign a management class with *dynamic* or *shared dynamic* serialization.

Note: If open file support is not configured: While the client attempts to back up open files, this is not always possible. Some files are open exclusively for the application that opened them. If the client encounters such a file, it cannot read it for backup purposes. If you are aware of such file types in your environment, you should exclude them from backup to avoid seeing error messages in the log file.

**Related concepts:**

Display information about management classes and copy groups  
Select a management class for files

Windows

## Ambiguous file space names in file specifications

---

If you have two or more file spaces such that one file space name is the same as the beginning of another file space name, then an ambiguity exists when you try to restore, retrieve, query, or do another operation that requires the file space name as part of the file specification.

For example, consider the following file spaces and the backup copies they contain:

File space name	File name
\\storman\home	amr\project1.doc
\\storman\home\amr	project2.doc

Notice that the name of the first file space, \\storman\home, matches the beginning of the name of the second file space, \\storman\home\amr. When you use the backup-archive command-line client interface to restore or query a file from either of these file spaces, by default the client matches the longest file space name in the file specification, \\storman\home\amr. To work with files in the file space with the shorter name, \\storman\home, use braces around the file space name portion of the file specification.

This means that the following query command finds project2.doc but does not find project1.doc:

```
dsmc query backup "\\storman\home\amr\*"
```

This is because the longer of the two file space names is \\storman\home\amr and that file space contains the backup for project2.doc.

To find project1.doc, enclose the file space name in braces. The following command finds project1.doc but does not find project2.doc:

```
dsmc query backup "{\\storman\home}\amr\*"
```

Similarly, the following command restores project1.doc but does not restore project2.doc:

```
dsmc restore {\\storman\home}\amr\project1.doc
```

Windows

## Management classes

---

IBM Spectrum Protect™ uses management classes to determine how to manage your backups on the server.

Every time you back up a file, the file is assigned a management class. The management class used is either a default selected for you, or one that you assign to the file using an include option in the include-exclude options list. The selected management class must contain a backup copy group for the file to be backed up.

Select **Utilities** → **View Policy Information** from the backup-archive client or web client GUI to view the backup policies defined by the IBM Spectrum Protect server for your client node.

### Related concepts:

Storage management policies

### Related tasks:

Setting the client scheduler process to run as a background task and start automatically at startup

Windows

## Deleted file systems

---

When a file system or drive has been deleted, or it is no longer backed up by the client, the existing backup versions for each file are managed according to the following policy attributes: Number of days to keep inactive backup versions, and number of days to keep the last backup version (if there is no active version).

If you do nothing else, active backup versions remain indefinitely. If you do not need to keep the active versions indefinitely, use the expire command to inactive the active versions.

You can also use the delete backup command to delete individual backup versions, or the delete filespace command to delete the entire file space. Your IBM Spectrum Protect™ server administrator must give you "delete backup" authority to use these commands. If the file space also contains archive versions, you must also have delete archive authority to use delete filespace.

Use the query session command to determine whether you have delete backup and delete archive authority. Alternatively, you can ask your IBM Spectrum Protect server administrator to delete the file space for you.

When you delete a file system, it has no effect on existing archive versions. However, if you no longer require the archive versions, you can use the delete archive or delete filespace commands to delete archives.

#### Related concepts:

Storage management policies

Windows

## Removable media backup

---

The backup-archive client backs up your removable media (such as tapes, cartridges or diskettes) based on the drive label, not the drive letter.

If a drive has no label, the backup does not occur. This use of drive labels permits you to perform such tasks as backing up different diskettes from the a: drive.

For a restore or retrieve, a separate file space for each drive label is maintained. These labels become the file space names on the IBM Spectrum Protect™ server. If you change the label of a drive you already backed up, the client views it as a new drive and does not relate it to your previous drive.

Because the client uses the labels to manage backups and archives of your removable media, you occasionally need to use those labels to locate data when using commands. For example, if you try to restore a file on diskette or DVD-ROM using `d:\projx\file.exe` as a file name, IBM Spectrum Protect substitutes the current label of your d: drive for the d:. If the d: drive label is d-disk, `d:\projx\file.exe` becomes `{d-disk}\projx\file.exe`, and the label is enclosed in braces.

If the label of the d: drive does not match a file space name on the server, IBM Spectrum Protect cannot locate your files using the current d: drive label. However, the client can locate your files if you use the file space name based on the original drive label. A mismatch between a label and a file space name might occur if you label your drives again, or if you access IBM Spectrum Protect from a different workstation than the one from which you backed up the files. If you have not relabeled the drive, and you are at the same workstation where the file was backed up, then you can use the drive letter as a shorthand version of the file space name (drive label).

Windows

## Fixed drives

---

The backup-archive client can back up your fixed drives even if they do not have a label, including drive aliases created with the DOS **subst** command. This applies to both the drive alias and the underlying physical drive, because the alias name and the physical drive label are the same.

Windows

## NTFS and ReFS file spaces

---

When you back up files on NTFS or ReFS partitions, the client also backs up file security information and file descriptors.

The following file descriptors are backed up:

- Owner security information (SID)
- Primary group SID
- Discretionary access-control list
- System access-control list

You must specify a file space name that is mixed case or lowercase text, and enclosed in quotation marks and braces. For example, `{"NTFSDrive"}`. Single quotation marks or double quotation marks are valid in loop mode. For example: `{"NTFSDrive"}` and `'NTFSDrive'` are both valid. In batch mode, only single quotation marks are valid. The single quotation mark requirement is a restriction of the operating system.

## Universal Naming Convention names

---

A Universal Naming Convention (UNC) name is a network resource name for a share point on a workstation.

The resource name includes the workstation name assigned to the workstation and a name you assign to a drive or directory so that it can be shared. The name you assign is also called a *share point name*.

- **Windows** Examples: UNC names in domain lists  
This topic shows some examples of using UNC names to specify a domain list.
- **Windows** Examples: UNC name backup  
You can back up shared files in a network through the use of a UNC name. Some examples of backing up UNC name files are shown.

## Examples: UNC names in domain lists

---

This topic shows some examples of using UNC names to specify a domain list.

### About this task

---

You must specify the following information:

- A drive letter for removable media
- Drive letters or UNC name for local fixed drives
- Drive letters or UNC names for remote mapped drives
- UNC names for remote unmapped drives

Example 1: To specify drive a: containing removable media, enter

```
domain a: \\local\c$
```

Example 2: To specify fixed drive c:, enter

```
domain c: \\remote\share1 \\remote\c$
```

## Examples: UNC name backup

---

You can back up shared files in a network through the use of a UNC name. Some examples of backing up UNC name files are shown.

A UNC name is a network resource name for a share point on a workstation. The resource name includes the workstation name assigned to the workstation and a name you assign to a drive or directory so that it can be shared. The name you assign is also called a share point name.

Using a UNC name permits you to back up specific shared directories to a separate file space. This is useful if, for example, you or an administrator want to back up a small portion of data that you would otherwise be unable to access. Drives are not backed up to a separate file space.

Every local drive is accessible using a UNC name except for drives containing removable media (such as tapes, cartridges or diskettes). Access these drives by using a predefined administrative share name consisting of the workstation name and the local drive letter, followed by \$. For example, to specify a UNC name on the c: drive for workstation *ocean*, enter:

```
\\ocean\c$
```

The \$ sign *must* be included with the drive letter.

To enter a UNC name for workstation *ocean* and share point *wave*, enter:

```
\\ocean\wave
```

When accessing files, you do not need to enter the letter of the drive except for drives containing removable media.

See the following table for examples showing selective backup of files using UNC names. In these examples, assume that:

- The workstation running **dsmc** is `major`.
- Share names `betarc` and `testdir` from workstation `alpha` are mapped to drives `r` and `t`, respectively.

Table 1. UNC examples

Example	Comment
<code>dsmc sel \\alpha\c\$\</code>	name of remote file space is <code>\\alpha\c\$</code>
<code>dsmc sel \\major\c\$\</code>	name of local, fixed file space is <code>\\major\c\$</code>
<code>dsmc sel a:\</code>	name of local, removable file space is volume label of <code>a:</code>
<code>dsmc sel \\alpha\betarc\</code>	name of remote file space is <code>\\alpha\betarc</code>
<code>dsmc sel \\alpha\testdir\</code>	name of remote file space is <code>\\alpha\testdir</code>
<code>dsmc sel d:\</code>	name of local, fixed file space is <code>\\major\d\$</code>
<code>dsmc sel c:\</code>	file space name is <code>\\major\c\$</code>
<code>dsmc sel r:\</code>	file space name is <code>\\alpha\betarc</code>

You can also specify UNC names for files in your include-exclude and domain lists.

**Related tasks:**

Creating an include-exclude list

**Related reference:**

Domain

Windows

## Microsoft Dfs file protection methods

---

There are some methods that you can use to protect the data in your Microsoft Dfs environment.

### About this task

---

Here are the methods you should use to protect your Microsoft Dfs data:

### Procedure

---

1. Back up the Dfs link metadata and the actual data at the share target of each link from the workstation hosting the Dfs root. This method simplifies back up and restore by consolidating all of the IBM Spectrum Protect™ activities on a single workstation. This method has the disadvantage of requiring an additional network transfer during backup to access the data stored at link targets.
2. Back up only the Dfs link metadata that is local to the workstation hosting the Dfs root. Back up the data at the target of each link from the workstation(s) which the data is local too. This method increases back up and restore performance by eliminating the extra network transfer, but requires back up and restore operations to be coordinated among several workstations.

### Results

---

Note:

1. See the product README file for current limitations of this feature.

Files contained on a Dfs server component are accessed using a standard UNC name, for example:

```
\\servername\dfsroot\
```

where `servername` is the name of the host computer and `dfsroot` is the name of the Dfs root.

If you set the `dfsbackupmntpnt` option to `yes` (the default), an incremental backup of a Dfs root does not traverse the Dfs junctions. Only the junction metadata is backed up. This is the setting you should use so that the client can be used to restore Dfs

links.

You can use the `dfsbackupmntpnt` option to specify whether the client sees a Dfs mount point as a Microsoft Dfs junction or as a directory.

**Important:** Restore the Dfs junction metadata first. This recreates the links. Then restore each junction and the data at each junction separately. If you do not restore the junction metadata first, the client creates a directory under the Dfs root using the same name as the junction point and restores the data in that directory.

The following example relates to method 1 above and illustrates how to use the client to back up and restore a Microsoft Dfs environment. Assume the existence of a domain Dfs environment hosted by the workstation `wkst1`:

Dfs root

```
\\wkst1\abc64test
```

Dfs link1

```
\\wkst1\abc64test\tools
```

Dfs link2

```
\\wkst1\abc64test\trees
```

Backup procedure:

1. Set the `dfsbackupmntpnt` option to `yes` in your client options file (`dsm.opt`).
2. Enter the following command to back up link junction information:

```
dsmc inc \\wkst1\abc64test
```

3. Enter the following command to back up data at the tools link:

```
dsmc inc \\wkst1\abc64test\tools
```

4. Enter the following command to back up data at the trees link:

```
dsmc inc \\wkst1\abc64test\trees
```

**Note:** DFS Replication uses staging folders to act as caches for new and changed files to be replicated from sending members to receiving members. If you do not want to backup these files, you can exclude them from your backup using the `exclude.dir` option.

```
exclude.dir x:\...\Dfsrprivate
```

Restore procedure:

1. Manually recreate shares at target workstations only if they no longer exist.
2. Manually recreate the Dfs root using the exact name as it existed at the time of back up.
3. Enter the following command to recover data from the tools link. This step is not necessary if the data still exists at the link target:

```
dsmc restore \\wkst1\abc64test\tools\* -sub=yes
```

4. Enter the following command to recover data from the trees link. This step is not necessary if the data still exists at the link target:

```
dsmc restore \\wkst1\abc64test\trees\* -sub=yes
```

5. Use the Distributed File System management console snap-in to reestablish replication for each link, if necessary.

The following limitations exist for restoring Microsoft Dfs data:

- The client does not restore root of Dfs. To recreate the Dfs tree, manually create the Dfs root first, then start restore to recreate the links.
- The client can back up the Dfs tree (both domain based Dfs and stand alone Dfs) hosted on local workstation only. You cannot back up Dfs if the Dfs host server is not your local workstation.
- The client cannot recreate shared folders on restore. For example, if you delete the junction and the shared folder the junction points to, restoring the Dfs root recreates the Dfs junction, but restoring a junction creates a local folder instead of creating the original backed up shared network folder.
- If a Dfs link is created with replica and the replica share is on a different server, the client does not display the replica data.



- If a Dfs root is added or modified, the client will not back it up. You must specify the Dfs root in the domain option in the client options file (dsm.opt) regardless of whether DOMAIN ALL-LOCAL is specified.

Mac OS X | AIX | Linux | Solaris

## Backup (UNIX and Linux): Additional considerations

There are some special situations that you need to consider before you back up your data.

- **Mac OS X | AIX | Linux | Solaris** Stored files  
When you back up and archive files, IBM Spectrum Protect stores the backups and archives in a file space in storage that has the same name as the file system or virtual mount point from which the files originated.
- **Mac OS X | AIX | Linux | Solaris** Special file systems  
Special file systems contain dynamic information generated by the operating system; they contain no data or files. The backup-archive client ignores special file systems and their contents.
- **Mac OS X | AIX | Linux | Solaris** NFS or virtual mount points  
When files are backed up and archived from a file system or virtual mount point, the client does not follow the nested NFS or virtual mount points (if any are defined on a file system). The nested NFS or virtual mount points will not be backed up or archived.
- **Mac OS X | AIX | Linux | Solaris** Management classes  
IBM Spectrum Protect uses management classes to determine how to manage your backups on the server.
- **Mac OS X | AIX | Linux | Solaris** Back up symbolic links  
The backup-archive client backs up symbolic links differently than it does regular files and directories.
- **Mac OS X | AIX | Linux | Solaris** Hard links  
When you back up files that are hard-linked, the backup-archive client backs up each instance of the linked file.
- **AIX | Linux | Solaris** Sparse files  
Sparse files do not have disk space allocated for every block in the whole address space, leading to holes within the file. Holes are detected by their content, which is always zeros, and these zeros take up space.
- **Mac OS X | AIX | Linux | Solaris** NFS hard and soft mounts  
When the backup-archive client connects to an NFS file system, you can use either a hard mount or a soft mount.
- **Mac OS X | AIX | Linux | Solaris** Deleted file systems  
When a file system or drive has been deleted, or it is no longer backed up by the backup-archive client, the existing backup versions for each file are managed according to the following policy attributes: Number of days to keep inactive backup versions, and number of days to keep the last backup version (if there is no active version)
- **Mac OS X | AIX | Linux | Solaris** Opened files  
The backup-archive client looks for files that have changed between the start and the completion of the backup of the file.
- **Mac OS X | AIX | Linux | Solaris** Wildcard characters  
You can use the operating system wildcard characters in file specifications with the backup-archive client. These characters let you select groups of files that have similar names.

Mac OS X | Mac OS X | AIX | Linux | Solaris

## Stored files

When you back up and archive files, IBM Spectrum Protect™ stores the backups and archives in a file space in storage that has the same name as the file system or virtual mount point from which the files originated.

For example, if you have a file system named `/home`, and you back up a file named `doc1` in the `/home/monnett` directory, IBM Spectrum Protect stores the file in a file space named `/home`. If you later define `/home/monnett` as a virtual mount point, any files you back up from the `/home/monnett` directory, such as `doc2`, are stored in a file space named `/home/monnett`. If you enter this command:

```
dsmc query backup "/home/monnett/*"
```

IBM Spectrum Protect looks for files in the `/home/monnett` file space. It always looks for a file in the file space with the longest name that matches the file specification you include in a command. It locates the file named `doc2` that was backed up after the virtual mount point was defined. However, it does not locate the file named `doc1` because that file was backed up before the virtual mount point was defined and the backup was stored in the `/home` file space.

To list or restore the `doc1` file using a command, you must explicitly specify the file space name by enclosing it in braces. For example:

```
dsmc query backup "{/home}/monnett/*"  
dsmc restore {/home}/monnett/doc1
```

If you subsequently remove the `/home/monnett` virtual mount point, and you then back up additional files in the `/home/monnett` directory, the backups are once again stored in the `/home` file space. For example, if you now back up a file named `doc3` in the `/home/monnett` directory, it is stored in the `/home` file space. It is not stored in the existing `/home/monnett` file space.

However, because the `/home/monnett` file space already exists, when you try to query or restore the `doc3` file, IBM Spectrum Protect looks for the file in the `/home/monnett` file space unless you specify the correct file space name. For example:

```
dsmc query backup "{/home}/monnett/*"  
dsmc restore {/home}/monnett/doc2
```

**Note:** You must explicitly specify the file space name only when there can be more than one resolution to the file specification.

For example, if the following file spaces exist in storage:

```
/home  
/home/monnett  
/home/monnett/project1  
/home/monnett/project1/planning
```

then enter:

```
dsmc query backup "/home/monnett/project1/planning/*"
```

IBM Spectrum Protect looks for files only in the `/home/monnett/project1/planning` file space, even if one or more of the other file spaces contains a path with the same name. But, when you enter one of the following:

```
dsmc query backup "{/home}/monnett/project1/planning/*"  
dsmc query backup "{/home/monnett}/project1/planning/*"  
dsmc query backup "{/home/monnett/project1}/planning/*"
```

IBM Spectrum Protect looks for files only in the `/home` file space, the `/home/monnett` file space, or the `/home/monnett/project1` file space, depending on which form you use.

Mac OS X | AIX | Linux | Solaris

## Special file systems

---

Special file systems contain dynamic information generated by the operating system; they contain no data or files. The backup-archive client ignores special file systems and their contents.

Special file systems include the following:

- the `/proc` file system on most of the UNIX platforms
- the `/dev/fd` file system on Solaris
- the `/dev/pts` on Linux

Mac OS X | AIX | Linux | Solaris

## NFS or virtual mount points

---

When files are backed up and archived from a file system or virtual mount point, the client does not follow the nested NFS or virtual mount points (if any are defined on a file system). The nested NFS or virtual mount points will not be backed up or archived.

Mac OS X | AIX | Linux | Solaris

## Management classes

---

IBM Spectrum Protect™ uses management classes to determine how to manage your backups on the server.

Every time you back up a file, the file is assigned a management class. The management class used is either a default selected for you, or one assigned to the file with an include option in the include-exclude options list. The selected management class must contain a backup copy group in order for the file to be backed up.

Select **Utilities** → **View Policy Information** from the Java™ or web client GUI to view the backup policies defined by the IBM Spectrum Protect server for your client node.

**Related concepts:**

Storage management policies

AIX Linux Solaris

## Back up symbolic links

---

The backup-archive client backs up symbolic links differently than it does regular files and directories.

The way that the client backs up symbolic links depends on options settings, whether the target directory is accessible, and the way you specify objects.

A *UNIX symbolic link* is a file that contains a pointer to another file or directory. The object the symbolic link points to is called the target object.

A symbolic link can be backed up as path information to a target directory, or it can be backed up as a directory. If the symbolic link is backed up as a directory, the files and folders in the target directory can also be backed up.

Note: Symbolic link processing as described here does not apply to Mac OS X. Symbolic links are always backed up as files and are never followed.

- **Mac OS X AIX Linux Solaris** Examples: Incremental or selective backup of symbolic links  
How the client backs up a symbolic link depends on whether the target of the symbolic link is a file or a directory, and how you specify the symbolic link on the incremental or selective backup command.
- **Mac OS X AIX Linux Solaris** Incremental backup of a domain only  
The client backs up a symbolic link during an incremental backup of the domain, if the symbolic link is defined as a virtual mount point and the `followsymbolic` option is set to yes.

**Related reference:**

Archsymlinkasfile

Followsymbolic

Virtualmountpoint

Mac OS X AIX Linux Solaris

## Examples: Incremental or selective backup of symbolic links

---

How the client backs up a symbolic link depends on whether the target of the symbolic link is a file or a directory, and how you specify the symbolic link on the incremental or selective backup command.

If a symbolic link points to a file, the client only backs up the path information. The client does not back up a file that is the target of a symbolic link.

If a symbolic link points to a directory, the backup depends on how the directory is specified on the command.

If a directory is specified with a trailing slash on a selective or incremental backup command, the client saves the symbolic link as a directory, and backs up the contents of the target directory.

If the symbolic link is entered without a trailing slash, or if a symbolic link is not explicitly stated in a backup file specification, the client backs up only the path information to the target directory. The contents of the target directory are not backed up.

In the following examples, assume that `symdir` is a symbolic link to target directory `/fs1/guest/`. `/fs1/guest/` contains these objects:

- `/fs1/guest/file` (a file)
- `/fs1/guest/dir1` (a directory)
- `/fs1/guest/dir1/file1` (a file)

**Example 1**

```
dsmc incr /home/gillis/symdir/
```

In this example, the client backs up the symbolic link as a directory, and backs up the contents of the target directory `/fs1/guest/`. If you specify the `subdir=yes` option, the client backs up subdirectories of `/fs1/guest/`.

#### Example 2

```
dsmc incr /home/gillis/symdir/dir1
```

#### Example 3

```
dsmc incr /home/gillis/symdir/dir1/
```

In Example 2 and Example 3, the client backs up the symbolic link as a directory, and backs up the `/dir1/` subdirectory of the target directory. The trailing slash is relevant only for the symbolic link; it is not relevant for subdirectories of the symbolic link. If you specify the `subdir=yes` option, the client backs up subdirectories of the `/fs1/guest/dir1` directory. Backup copies that are stored on the IBM Spectrum Protect™ server have a path of `/home/gillis/symdir/dir1/file1`.

#### Example 4

```
dsmc incr /home/gillis/symdir
```

In Example 4, because there is no trailing slash after the symbolic link, the client backs up only the path to the target directory. The client does not back up the symbolic link as a directory, and does not back up files nor folders in the target directory.

#### Example 5

```
dsmc incr /home/gillis/
```

In Example 5, because the symbolic link is not explicitly stated in the backup file specification, the client backs up only the path to the target directory. As in example 3, the client does not back up the symbolic link as a directory, and does not back up files nor folders in the target directory.

**Restriction:** If you back up a symbolic link as a directory, a future incremental backup that does not back up that symbolic link as a directory expires that symbolic link as a directory, and expires the files and directories in that directory.

For example, assume that you first back up the symbolic link `symdir` as a directory, and back up the contents of the target directory. The command in example 1 does this. The client creates backup copies with a high-level path `/home/gillis/symdir/`. In this example, the client creates backup copies with these paths:

- `/home/gillis/symdir/`
- `/home/gillis/symdir/file`
- `/home/gillis/symdir/dir1`
- `/home/gillis/symdir/dir1/file1`

The contents of `/home/gillis` are backed up using the following command:

```
dsmc inc /home/gillis/ -subdir=yes
```

This command processes the value `symdir` as a symbolic link and does not process any objects that the symbolic link points to. Hence, the client expires backup copies in the `/home/gillis/symdir/` directory that were created in Example 1.

Mac OS X | AIX | Linux | Solaris

## Incremental backup of a domain only

---

The client backs up a symbolic link during an incremental backup of the domain, if the symbolic link is defined as a virtual mount point and the `followsymbolic` option is set to `yes`.

The client backs up a symbolic link and the target directory when all of the following conditions are true:

- The client performs an incremental backup of the domain.
- **AIX | Linux | Solaris** The symbolic link is defined as a virtual mount point using the `virtualmountpoint` option.
- `followsymbolic=yes`

**AIX | Linux | Solaris** The `virtualmountpoint` and `followsymbolic` options add the symbolic link to the domain. The incremental command backs up the domain, which includes the symbolic link target.

#### Related reference:

`Followsymbolic`

`Virtualmountpoint`

Mac OS X | AIX | Linux | Solaris

## Hard links

---

When you back up files that are hard-linked, the backup-archive client backs up each instance of the linked file.

For example, if you back up two files that are hard-linked, the client backs up the file data twice.

When you restore hard-linked files, the client attempts to reestablish the links. For example, if you had a hard-linked pair of files, and only one of the hard-linked files is on your workstation, when you restore both files, they are hard-linked. The files are also hard-linked even if neither of the files exists at the time of restore, if both of the files are restored together in a single command. The one exception to this procedure occurs if you back up two files that are hard-linked and then break the connection between them on your workstation. If you restore the two files from the server using the standard (or classic) restore process, the client respects the current file system and does not re-establish the hard link.

**Important:** If you do not back up and restore all files that are hard-linked at the same time, problems occur. To ensure that hard-linked files remain synchronized, back up all hard links at the same time and restore those same files together.

AIX Linux Solaris

## Sparse files

---

Sparse files do not have disk space allocated for every block in the whole address space, leading to holes within the file. Holes are detected by their content, which is always zeros, and these zeros take up space.

The default is to restore the sparse file without the holes, which would leave more free disk space. The backup-archive client detects sparse files during a backup operation and marks them as sparse on the IBM Spectrum Protect™ server.

Note: Sparse files do not apply to Mac OS X.

The backup-archive client backs up a sparse file as a regular file if client compression is off.

### Related reference:

Compression

Makesparsefile

Mac OS X Mac OS X AIX Linux Solaris

## NFS hard and soft mounts

---

When the backup-archive client connects to an NFS file system, you can use either a hard mount or a soft mount.

The client uses the `nfstimeout` option value to determine how long to wait for an NFS system call to respond before timing out; this setting applies to hard and soft mounts. The default is 0 seconds. This means that the client uses the default behavior of NFS system calls.

Be aware of the consequences of hard and soft mounts if the mount becomes stale (for example, if the server for the file system is not available).

### Hard mount

If the NFS file system is hard mounted, the NFS daemons try repeatedly to contact the server. The NFS daemon retries will not time out, they affect system performance, and you cannot interrupt them, but control returns to the client when the `nfstimeout` value is reached.

### Soft mount

If the NFS file system is soft mounted, NFS tries repeatedly to contact the server until either:

- A connection is established
- The NFS retry threshold is met
- The `nfstimeout` value is reached

When one of these events occurs, control returns to the calling program.

**Note:** On UNIX and Linux systems, the `nfstimeout` option can fail if the NFS mount is hard. If a hang occurs, deactivate the `nfstimeout` option and mount the NFS file system soft mounted, as follows:

```
mount -o soft,timeo=5,retry=5 machine:/filesystem /mountpoint
```

The parameters are defined as follows:

### soft

Generates a soft mount of the NFS file system. If an error occurs, the `stat()` function returns with an error. If the option `hard` is used, `stat()` does not return until the file system is available.

`timeo=n`

Sets the timeout period for a soft mount error to  $n$  tenths of a second.  
retry= $n$   
Sets the number of times to try the mount, where  $n$  is an integer; the default is 10000.

Mac OS X | AIX | Linux | Solaris

## Deleted file systems

---

When a file system or drive has been deleted, or it is no longer backed up by the backup-archive client, the existing backup versions for each file are managed according to the following policy attributes: Number of days to keep inactive backup versions, and number of days to keep the last backup version (if there is no active version)

If you do nothing else, active backup versions remain indefinitely. If you do not need to keep the active versions indefinitely, use the expire command to inactive the active versions.

If you do not need to keep any of the backup versions, use the delete backup command to delete all backup versions in the file space. Your IBM Spectrum Protect™ server administrator must give you the authority to use this command. Use the query session command to determine whether you have "delete backup" authority. Alternatively, you can ask your IBM Spectrum Protect server administrator to delete the file space for you.

### Related concepts:

Storage management policies

Mac OS X | AIX | Linux | Solaris

## Opened files

---

The backup-archive client looks for files that have changed between the start and the completion of the backup of the file.

Some files on your system might be in use, or open, when you try to back them up. Because an open file can change, a backup action might not reflect the correct contents of the file at a given time.

Consider whether the file is important, and whether you can build the file again. If the file is not important, you might not want to back it up. Or, if the file is important, a root user on your workstation can ensure the file is closed before backup.

If your backups run on a schedule, a root user can use the preschedulecmd option to enter a command to close the file. For example, if the open file is a database, use the quiesce command of the database to shut down the database. A root user can use the postschedulecmd option to restart the application that uses the file after the backup completes. If you are not using a schedule for the backup, ensure that you close the application that uses the file before you start the backup.

The client can back up the file even if it is open and gets changed during the backup. This is only useful if the file is usable even if it changes during backup. To back up these files, assign the files a management class with the serialization *dynamic* or *shared dynamic*.

### Related concepts:

Display information about management classes and copy groups

Select a management class for files

Mac OS X | AIX | Linux | Solaris

## Wildcard characters

---

You can use the operating system wildcard characters in file specifications with the backup-archive client. These characters let you select groups of files that have similar names.

In a command, wildcard characters can only be used in the file name or extension. They cannot be used to specify destination files, file systems, or directories. When using wildcard characters in non-loop mode, as in `dsmc sel "/home/ledger.*"`, enclose the parameter containing the asterisk in quotation marks to ensure the system does not interpret the wildcard character and produce unexpected results. Wildcard character information is covered in the following table.

Important: Use an asterisk (\*) instead of a question mark (?) as a wildcard character when trying to match a pattern on a multibyte code page, to avoid unexpected results.

This table shows some wildcard patterns and how to specify them.

<b>* (Asterisk)</b>	<b>Zero or more characters that match all files:</b>
<b>*.cpp</b>	With a cpp extension
<b>hm*.*</b>	Starting with hm, regardless of extension, but must have the '.' character
<b>hm*</b>	Starting with hm, whether an extension exists or not
<b>*h*.*</b>	With an h somewhere in the file name, regardless of extension, but must have .
<b>? (Question mark)</b>	<b>One character that matches all files with:</b>
<b>?cpp</b>	The extension cpp with one, and only one, character in the file name
<b>hm?.cpp</b>	Three-character names beginning with hm and that have the cpp extension
<b>* ? (Asterisk and question mark)</b>	<b>Asterisk and question mark combinations matching:</b>
<b>??hm.*</b>	All four-character file names ending in hm., no matter what extension they have

In a path name for a file specification, you cannot specify a directory whose name contains an asterisk (\*) or a question mark (?). The client recognizes those characters only as wildcard characters.

## Restoring your data

Use IBM Spectrum Protect™ to restore backup versions of specific files, a group of files with similar names, or entire directories.

You can restore these backup versions if the original files are lost or damaged. Select the files that you want to restore by using a file specification (file path, name, and extension), a directory list, or a subdirectory path to a directory and its subdirectories.

**Windows** Note: When you restore a directory, its modification date and time is set to the date and time of the restore operation, and not to the date and time the directory had when it was backed up. This is because IBM Spectrum Protect restores the directories first, then adds the files to the directories.

All client backup and restore procedures that are referenced by this topic also apply to the web client. However, the web client does not provide a Preferences Editor for setting client options.

**AIX | Linux | Mac OS X | Solaris** Attention: Do not restore operating system files, like base system directories, kernel modules, or patches, to their original location while the file system is running. The operating system might hang or crash.

The following are the primary restore tasks:

- **Windows** Restoring files and directories
- **Windows** Restoring Windows system state
- **Windows** Restoring Automated System Recovery files
- **Windows** Microsoft Dfs tree and file restore
- **AIX | Linux | Solaris | Windows** Restoring an image
- **Mac OS X | AIX | Linux | Solaris | Mac OS X** Restoring data using the GUI
- **Mac OS X | AIX | Linux | Solaris | Mac OS X** Command line restore examples
- Restore data from a backup set
- Restoring data to a point in time
- **AIX | Linux | Solaris | Mac OS X | Windows** Restore NAS file systems
- **Windows** Authorizing another user to restore or retrieve your files
- **Mac OS X | AIX | Linux | Solaris | Mac OS X** Authorizing another user to restore or retrieve your files
- **Windows** Restoring or retrieving files from another client node
- **AIX | Linux | Solaris | Mac OS X** Restoring or retrieving files from another client node
- **Windows** Restoring or retrieving your files to another workstation
- **Mac OS X | AIX | Linux | Solaris | Mac OS X** Restore or retrieve files to another workstation
- **Mac OS X | AIX | Linux | Solaris** Restoring a disk in case of disk loss
- **Windows** Deleting file spaces
- **Mac OS X | AIX | Linux | Solaris | Mac OS X** Deleting file spaces
- **Windows** Restoring data from a VMware backup

**AIX | Linux | Solaris | Mac OS X** Refer to *IBM Spectrum Protect for Space Management for UNIX and Linux* for details about restoring migrated files and the restoremigstate option.



- Windows** Duplicate file names

If you attempt to restore or retrieve a file whose name is the same as the short name of an existing file, a file name collision occurs (existence of duplicate file names).
- Windows** Universal Naming Convention names restore

Using a Universal Naming Convention (UNC) name permits you to restore specific shared files to a separate file space. This is useful if, for example, you or an administrator want to restore a portion of data that you would otherwise be unable to access.
- Windows** Active or inactive backup restore

Your administrator determines how many backup versions IBM Spectrum Protect maintains for each file on your workstation. Having multiple versions of a file permits you to restore older versions if the most recent backup is damaged.
- Windows** Restoring files and directories

You can locate the files you want to restore by searching and filtering.
- Windows** Restoring Windows system state

The Microsoft Volume Shadowcopy Service (VSS) is supported on Windows backup-archive clients. The client uses VSS to restore the system state. The system state restore function is deprecated for online system state restore operations.
- Windows** Restoring Automated System Recovery files

You can restore Automated System Recovery (ASR) files to recover the Windows operating system volume configuration information and system state if a catastrophic system or hardware failure occurs.
- Windows** Restoring the operating system when the computer is working

If your computer is working, you can restore the operating system from backed up files.
- Recovering a computer when the Windows OS is not working

If the computer has a catastrophic hardware or software failure, you can recover a Windows operating system with Automated System Recovery (ASR).
- Windows** Microsoft Dfs tree and file restore

To restore Dfs junctions and the data for each junction, restore the Dfs junction metadata first and then restore each junction separately.
- AIX** **Linux** **Solaris** **Windows** Restoring an image

There are some items to consider before you begin restoring images on your system.
- Restore data from a backup set

Your IBM Spectrum Protect administrator can generate a backup set, which is a collection of your files that reside on the server, onto portable media created on a device using a format that is compatible with the client device.
- Windows** Restore Net Appliance CIFS shares

Restoring the share definition requires restoring the root directory of the share file space, which under most circumstances can be done as follows: `dsmc rest \\NetAppFiler\CifsShareName\ -dironly`.
- Windows** Restoring data from a VMware backup

You can use several methods for restoring data from backups to a VMware virtual machine. The restore method depends on the type of backup and on the version of the backup-archive client software that you use to run the restore.
- Windows** Restore Windows individual Active Directory objects

You can restore individual Active Directory objects to recover from accidental corruption or deletion of Active Directory objects without requiring a shutdown or restart of the Active Directory server.
- Restoring or retrieving data during a failover

When the client fails over to the secondary server, you can restore or retrieve replicated data from the secondary server.
- Windows** Authorizing another user to restore or retrieve your files

You can authorize a user on another node to restore your backup versions or retrieve your archive copies. In this way, you can share files with other people or with other workstations that you use with a different node name.
- Windows** Restoring or retrieving files from another client node

After users grant you access to their files on the server, you can restore or retrieve those files to your local system.
- Windows** Restoring or retrieving your files to another workstation

When you are using a different workstation, you can restore or retrieve files you backed up from your own workstation.
- Windows** Deleting file spaces

If your IBM Spectrum Protect administrator grants you authority, you can delete entire file spaces from the server.
- AIX** **Linux** **Solaris** Restore an image to file

When you back up an image, the backup-archive client backs up the first sector of the volume, but when the data is restored, it skips the first sector to preserve the original logical volume control block of the destination volume.
- AIX** **Linux** Manage GPFS file system data with storage pools

With Global Parallel File Systems (GPFS™) technology, you can manage your data using storage pools. A storage pool is a collection of disks or RAID's with similar properties that are managed together as a group.
- Restoring data to a point in time

Use a *point-in-time* restore to restore files to the state that existed at a specific date and time.
- AIX** Restore AIX encrypted files

When files are backed up in raw format from an AIX® JFS2 Encrypted File System (EFS), you can only restore them to the same or another JFS2 EFS. They cannot be restored to any different file system, or on a different platform.



- **AIX** Restore AIX workload partition file systems  
All the files that are created by the local workload partition (WPAR), and backed up by the backup-archive client that is installed at the global WPAR, can be restored by the client installed at the global WPAR.
- **AIX** | **Solaris** | **Windows** Restore NAS file systems  
You restore NAS file system images using the web client or command line interface. The web client interface is available only for connections to the IBM Spectrum Protect Version 8.1.1, V8.1.0, or V7.1.7 or earlier servers.
- **Mac OS X** | **AIX** | **Linux** | **Solaris** Restore active or inactive backups  
Your administrator determines how many backup versions IBM Spectrum Protect maintains for each file on your workstation.
- **Mac OS X** | **AIX** | **Linux** | **Solaris** Restoring data using the GUI  
This section lists the steps to follow to restore backup versions of individual files or subdirectories.
- **Mac OS X** | **AIX** | **Linux** | **Solaris** Command line restore examples  
This topic lists some examples of restore commands to use for specific tasks.
- **Solaris** Restoring Solaris Zettabyte (ZFS) file systems  
Zettabyte File Systems (ZFS) use storage pools to manage physical storage.
- **Mac OS X** | **AIX** | **Linux** | **Solaris** Additional restore tasks  
This section discusses some advanced considerations for restoring data.

#### Related tasks:

Starting a web client session

**Windows**

## Duplicate file names

If you attempt to restore or retrieve a file whose name is the same as the short name of an existing file, a file name collision occurs (existence of duplicate file names).

An example is when the file *abcdefghijkl.doc* has a short name of *abcdef~1.doc*, and you attempt to restore or retrieve a file explicitly named *abcdef~1.doc* into the same directory. In this case, a collision occurs because the name of the file you are restoring conflicts with the short name for *abcdefghijkl.doc*.

A collision can occur even if the files are restored or retrieved to an empty directory. For example, files *abcdef~1.doc* and *abcdefghijkl.doc* might originally have existed in the directory as *abcdefghijkl.doc* and *abcdef~2.doc*. During the restore, if *abcdefghijkl.doc* is restored first, it is assigned a short name of *abcdef~1.doc* by the Windows operating system. When you restore *abcdef~1.doc*, the duplicate file name situation occurs.

IBM Spectrum Protect™ handles these situations based on the value of the replace option. Use the replace option to specify whether to overwrite an existing file, or to prompt you for your selection when you restore or retrieve files.

If a file name collision occurs, you can do any of the following:

- Restore or retrieve the file with the short file name to a different location.
- Stop the restore or retrieve and change the name of the existing file.
- Disable short file name support on Windows.
- Do not use file names, such as *abcdef~1.doc*, that would conflict with the short file naming convention.

#### Related reference:

Replace

**Windows**

## Universal Naming Convention names restore

Using a Universal Naming Convention (UNC) name permits you to restore specific shared files to a separate file space. This is useful if, for example, you or an administrator want to restore a portion of data that you would otherwise be unable to access.

Except for drives with removable media, every local drive letter is accessible using a local UNC name that includes the workstation name and a designation for the drive letter. For example, to enter a UNC name on drive *c*: for workstation *ocean*, enter:

```
\\ocean\c$
```

The \$ sign *must* be included with the drive letter.

To enter a UNC name for workstation *ocean* and share point *wave*, enter:

\\ocean\wave

When accessing files, you do not need to enter the letter of the drive *except* for drives with removable media.

Windows

## Active or inactive backup restore

---

Your administrator determines how many backup versions IBM Spectrum Protect™ maintains for each file on your workstation. Having multiple versions of a file permits you to restore older versions if the most recent backup is damaged.

The most recent backup version is the *active* version. Any other backup version is an *inactive* version. Every time IBM Spectrum Protect backs up your files, it marks the new backup version as the active backup, and the last active backup becomes an inactive backup. When the maximum number of inactive versions is reached, IBM Spectrum Protect deletes the oldest inactive version.

To restore a backup version that is inactive, you must display both active and inactive versions by clicking on the **View** menu → **Display active/inactive files** item. To display only the active versions (the default), click on the **View** menu → **Display active files only** item. If you try to restore both an active and inactive version of a file at the same time, only the active version is restored.

On the IBM Spectrum Protect command line, use the inactive option to display both active and inactive objects.

### Related reference:

Inactive

Windows

## Restoring files and directories

---

You can locate the files you want to restore by searching and filtering.

Filtering displays only the files that match the filter criteria for your restore operation. Files that do not match the filter criteria do not display. The filter process searches files in the specified directory but does not include subdirectories.

- **Windows** Restoring data by using the GUI  
You can use the client GUI to restore files and directories.
- **Windows** Examples for restoring data using the command line  
You can use the examples in this topic when you need to restore objects from IBM Spectrum Protectserver storage.

Windows

## Restoring data by using the GUI

---

You can use the client GUI to restore files and directories.

### About this task

---

Restriction: The web client GUI cannot browse network resources for a restore operation. No shares are listed if you expand the Network branch. You can restore to a network resource from the web client if the entire file is processed. Specify the shared file system in the domain option in the `dsm.opt` options file. For example, `domain all-local \\server\share`. To complete the restore operation, specify Network Share in the Restore Destination dialog. This processes all file systems that are specified by the domain option. Alternatively, you can use the GUI Client to complete the restore operation.

### Procedure

---

1. Click Restore on the main window. The Restore window appears.
2. Expand the directory tree by clicking the plus (+) sign or the folder icon next to an object in the tree. Select the object that you want to restore. To search or filter files, click the Search icon from the toolbar.
3. Click the selection box for the objects that you want to restore.
4. To modify specific restore options, click the Options button. Any options that you change are effective during the current session only.
5. Click Restore. The Restore Destination window appears. Enter the appropriate information.
6. Click Restore. The Restore Task List window displays the processing status.

### Related tasks:

Backing up data using the GUI

## Examples for restoring data using the command line

You can use the examples in this topic when you need to restore objects from IBM Spectrum Protect™ server storage.

The following table shows how to use some restore commands to restore your objects from IBM Spectrum Protect server storage.

Table 1. Command-line restore examples

Task	Command	Considerations
Restore the most recent backup version of the <code>c:\doc\h1.doc</code> file, even if the backup is inactive.	<code>dsmc restore c:\doc\h1.doc - latest</code>	If the file you are restoring no longer resides on your workstation, and you have run an incremental backup since deleting the file, there is no active backup of the file on the server. In this case, use the latest option to restore the most recent backup version. IBM Spectrum Protect restores the latest backup version, whether it is active or inactive. See Latest for more information.
Display a list of active and inactive backup versions of files from which you can select versions to restore.	<code>dsmc restore c:\project\* -pick - inactive</code>	If you try to restore both an active and inactive version of a file at the same time, only the active version is restored. See Pick and Inactive for more information.
Restore all files with a file extension of <code>.c</code> from the <code>c:\devel\projecta</code> directory.	<code>dsmc restore c:\devel \projecta\*.c</code>	If you do not specify a destination, the files are restored to their original location.
Restore the <code>c:\project\doc\h1.doc</code> file to its original directory.	<code>dsmc restore c:\project\doc\h1.do c</code>	If you do not specify a destination, the files are restored to their original location.
Restore the <code>c:\project\doc\h1.doc</code> file under a new name and directory.	<code>dsmc restore c:\project\doc\h1.do c c:\project\newdoc\h2 .doc</code>	None
Restore the files in the <code>e:</code> drive and all of its subdirectories.	<code>dsmc restore e:\ - subdir=yes</code>	You must use the <code>subdir</code> option to restore directory attributes/permissions. See Subdir for more information about the <code>subdir</code> option.
Restore all files in the <code>c:\mydir</code> directory to their state as of 1:00 PM on August 17, 2002.	<code>dsmc restore - pitd=8/17/2002 - pitt=13:00:00 c:\mydir\</code>	See Pitdate and Pittime for more information about the <code>pitdate</code> and <code>pittime</code> options.

Task	Command	Considerations
Restore the c:\doc\h2.doc file to its original directory on the workstation, named <i>star</i> .	<pre>dsmc restore c:\doc\h2.doc \\star\c\$\  To restore the file to "star" which has been renamed "meteor", enter:  dsmc restore \\star\c\$\ doc\h2.doc \\meteor\c\$\  You could also enter:  dsmc restore \\star\c\$\ doc\h2.doc c:\  This example is valid because if the workstation name is not included in the specification, the local workstation is assumed ("meteor", in this case).</pre>	For the purposes of this manual, the workstation name is part of the file name. Therefore, if you back up files on one workstation and you want to restore them to another workstation, you must specify a destination. This is true even if you are restoring to the same physical workstation, but the workstation has a new name.
Restore a file that was originally backed up from the diskette labeled "workathome" in the a: drive, and restore it to a diskette in the a: drive labeled "extra".	<pre>dsmc restore {workathome}\doc\h2.doc doc a:\doc\h2.doc</pre>	If you are restoring a file to a disk with a different label than the disk from which the file was backed up, you must use the file space name (label) of the backup disk instead of the drive letter.
Restore files specified in the c:\filelist.txt file to the d:\dir directory.	<pre>dsmc restore - filelist=c:\filelist .txt d:\dir\</pre>	See Filelist for more information about restoring a list of files.
Restore all members of the virtfs\group1 group backup stored on the IBM Spectrum Protect server.	<pre>dsmc restore group {virtfs}\group1</pre>	See Restore Group for more information.

- **Windows** Examples: Restoring large amounts of data  
If you need to restore a large number of files, you get faster performance using the command line interface rather than the GUI interface. In addition, you improve performance if you enter multiple restore commands at one time.
- **Windows** Standard query restore, no-query restore, and restartable restore  
This topic describes the standard (or classic) restore method, the no-query restore method, and the restartable restore method.

**Related concepts:**

Using commands

**Related reference:**

Restore

**Windows**

## Examples: Restoring large amounts of data

If you need to restore a large number of files, you get faster performance using the command line interface rather than the GUI interface. In addition, you improve performance if you enter multiple restore commands at one time.

### About this task

For example, to restore all the files in your c: file space, enter:

```
dsmc restore c:\* -subdir=yes -replace=all -tapeprompt=no
```

However, if you enter multiple commands for the root directories in your `c:` file space, you can restore the files faster. For example, enter these commands:

```
dsmc restore c:\users\ -subdir=yes -replace=all -tapeprompt=no  
dsmc restore c:\data1\ -subdir=yes -replace=all -tapeprompt=no  
dsmc restore c:\data2\ -subdir=yes -replace=all -tapeprompt=no
```

Or, if you need to restore files for multiple drives, enter these commands:

```
dsmc restore c:\* -subdir=yes -replace=all -tapeprompt=no  
dsmc restore d:\* -subdir=yes -replace=all -tapeprompt=no  
dsmc restore e:\* -subdir=yes -replace=all -tapeprompt=no
```

You can also use the quiet option with the restore command to save processing time. However, you will not receive informational messages for individual files.

Note: If you already have the appropriate values set for the `subdir`, `replace`, `tapeprompt`, and `quiet` options in your client options file, it is not necessary to include these options in the commands.

When you enter multiple commands to restore your files, you must specify a unique part of the file space in each restore command. Do not use any overlapping file specifications in the commands.

To display a list of the root directories in a file space, use the query backup command. For example:

```
dsmc query backup -dirsonly -subdir=no c:\
```

As a general rule, you can enter two to four restore commands at one time. The maximum number you can run at one time without degrading performance depends on factors such as network utilization and how much memory you have. For example, if `\users` and `\data1` are on the same tape, the restore for `\data1` must wait until the restore for `\users` is complete. However, if `\data2` is on a different tape, and there are at least two tape drives available, the restore for `\data2` can begin at the same time as the restore for `\users`.

The speed at which you can restore the files also depends upon how many tape drives are available and whether your administrator is using collocation to keep file spaces assigned to as few volumes as possible. If your administrator is using collocation, the number of sequential access media mounts required for restore operations is also reduced.

## Standard query restore, no-query restore, and restartable restore

---

This topic describes the standard (or classic) restore method, the no-query restore method, and the restartable restore method.

- **Windows** Standard query restore process  
The standard query restore process is also known as classic restore. This topic explains how standard query restore works.
- **Windows** No-query restore process  
In the no-query restore process, a single restore request is sent to the server instead of querying the server for each object to be restored.
- **Windows** Restartable restore process  
If the restore process stops because of a power outage or network failure, the server records the point at which this occurred.

## Standard query restore process

---

The standard query restore process is also known as classic restore. This topic explains how standard query restore works.

Here is how standard query restore works:

- The client queries the server for a list of files backed up for the client file space you want to restore.
- The server sends a list of backed up files that match the restore criteria. If you want to restore both active and inactive files, the server sends information about all backed up files to the client.
- The list of files returned from the server is sorted in client memory to determine the file restore order and to minimize tape mounts required to perform the restore.
- The client tells the server to restore file data and directory objects.
- The directories and files you want to restore are sent from the server to the client.

## No-query restore process

---

In the no-query restore process, a single restore request is sent to the server instead of querying the server for each object to be restored.

1. The client tells the server that a no-query restore is going to be completed and provides the server with details about file spaces, directories, and files.
2. The server uses a separate table to track entries which guide the restore.
3. The data to be restored is sent to the client. File and directory objects that are stored on disk are sent immediately since sorting for such data is not required before the object is restored.
4. You can use multiple sessions to restore the data. If the data is on multiple tapes, there are multiple mount points available at the server. The combination of using the resourceutilization option and MAXNUMMP allows multiple sessions.

**Windows** When you enter an unrestricted wildcard source file specification on the restore command and do not specify any of the options: inactive, latest, pick, fromdate, or todate, the client uses a *no-query restore* method for restoring files and directories from the server. This method is called no-query restore because instead of querying the server for each object to be restored, a single restore request is sent to the server. In this case, the server returns the files and directories to the client without further action by the client. The client merely accepts the data that comes from the server and restores it to the destination named on the restore command.

**Mac OS X** **AIX** **Linux** **Solaris** When you enter an unrestricted wildcard source file specification on the restore command and do not specify any of the options: inactive, latest, pick, fromdate, todate, the client uses a *no-query restore* method for restoring files and directories from the server. This method is called no-query restore because instead of querying the server for each object to be restored, a single restore request is sent to the server. In this case, the server returns the files and directories to the client without further action by the client. The client merely accepts the data that comes from the server and restores it to the destination named on the restore command.

**Mac OS X** Using the IBM Spectrum Protect™ GUI client, an example of an unrestricted wildcard command would be to select a folder from the restore tree window. An example of a restricted wildcard command would be to select individual files from a folder.

Using the command-line client, an example of an unrestricted wildcard command would be:

**Mac OS X**  
"/Users/user1/Documents/2004/\*"

**Mac OS X** **AIX** **Linux** **Solaris**  
/home/mydocs/2004/\*

**Windows**  
c:\mydocs\2004\\*

An example of a restricted wildcard file specification would be:

**Mac OS X**  
/Users/user1/Documents/2004/sales.\*

**Mac OS X** **AIX** **Linux** **Solaris**  
/home/mydocs/2004/sales.\*

**Windows**  
c:\mydocs\2004\sales.\*

## Restartable restore process

---

If the restore process stops because of a power outage or network failure, the server records the point at which this occurred.

This record is known to the client as a *restartable restore*. It is possible to have more than one restartable restore session. Use the query restore command or choose **restartable restores** from the Actions menu to find out if your client has any restartable restore sessions in the server database.

**Windows** You must complete a restartable restore before attempting further backups of the file system. If you attempt to repeat the restore that was interrupted or try to back up the destination file space, the attempt fails because you did not complete the original restore. You can restart the restore at the point of interruption by entering the restart restore command, or you can delete the restartable restore using the cancel restore command. If you restart the interrupted restore, it restarts with the first transaction, which might consist of one or more files, not completely restored when the interruption occurred. Because of this, you might receive some replace prompts for files from the interrupted transaction which were already restored.

**Mac OS X** **AIX** **Linux** **Solaris** You must complete a restartable restore before attempting further backups of the file system. If you attempt to repeat the restore that was interrupted or try to back up the destination file space, the attempt fails because you did not complete the original restore. You can restart the restore at the point of interruption by entering the restart restore command, or you can delete the restartable restore using the cancel restore command.

From the IBM Spectrum Protect™ GUI **Restartable restores** dialog box you can select the interrupted restore and delete it, or you can choose to restart the restore. If you restart the interrupted restore, it restarts with the first transaction, which might consist of one or more files, not completely restored when the interruption occurred. Because of this, you might receive some replace prompts for files from the interrupted transaction which were already restored.

**Mac OS X** **AIX** **Linux** **Solaris** **Windows** To perform restartable restores using the GUI, follow these steps:

1. Select **Actions** → **Restartable restores** from the main panel.
2. Select the restartable restore session you want to complete.
3. Click the **Restart** button at the bottom of the panel.

**Related reference:**

Resourceutilization

Restore

**Windows**

## Restoring Windows system state

---

The Microsoft Volume Shadowcopy Service (VSS) is supported on Windows backup-archive clients. The client uses VSS to restore the system state. The system state restore function is deprecated for online system state restore operations.

### About this task

---

You can no longer restore the system state on a system that is still online. Instead, use the ASR-based recovery method to restore the system state in offline Windows PE mode. For more information, see the following IBM Spectrum Protect wiki articles:

- Best Practices for Recovering Windows Server 2012 and Windows 8
- Best Practices for Recovering Windows Server 2012 R2 and Windows 8.1

If you try to restore the system state with the `dsmc restore systemstate` command, from the backup-archive client GUI, or from the web client, the following message is displayed:

```
ANS5189E Online SystemState restore has been deprecated. Please use offline
WinPE method for performing system state restore.
```

**Related concepts:**

Recovering a computer when the Windows OS is not working

**Related reference:**

Restore Systemstate

**Windows**

## Restoring Automated System Recovery files

---

You can restore Automated System Recovery (ASR) files to recover the Windows operating system volume configuration information and system state if a catastrophic system or hardware failure occurs.

### Before you begin

---

You must be a member of the Administrators or Backup Operators group to back up and restore ASR files.

### About this task

---

The backup-archive client restores ASR data when the backup-archive client restores the Windows system state.

## Procedure

---

To restore ASR files on Windows operating systems, use the restore systemstate command.

### Related concepts:

Recovering a computer when the Windows OS is not working

Windows

## Restoring the operating system when the computer is working

---

If your computer is working, you can restore the operating system from backed up files.

### About this task

---

If Active Directory is installed, you must be in Active Directory restore mode. When performing an operating system recovery including the system state, use the following restore order. Do not restart the computer between each step, even though you are prompted to do so.

## Procedure

---

1. Restore the system drive. For example: `dsmc restore c:\* -sub=yes -rep=all`.
2. Restore system state. For example: `dsmc restore systemstate`.

Windows

## Recovering a computer when the Windows OS is not working

---

If the computer has a catastrophic hardware or software failure, you can recover a Windows operating system with Automated System Recovery (ASR).

- Creating a bootable WinPE CD  
Before you can recover a Windows computer by using Automated System Recovery (ASR), you must create a bootable Windows Preinstallation Environment (WinPE) CD or DVD.
- Restoring the Windows operating system with Automated System Recovery  
You can restore the Windows operating system of a computer with Automated System Recovery (ASR).

### Related tasks:

Restoring the operating system when the computer is working

Windows

## Creating a bootable WinPE CD

---

Before you can recover a Windows computer by using Automated System Recovery (ASR), you must create a bootable Windows Preinstallation Environment (WinPE) CD or DVD.

### Procedure

---

For instructions that describe how to create a bootable WinPE CD or DVD, see the following IBM Spectrum Protect™ Wiki articles:

- Best Practices for Recovering Windows Server 2012 and Windows 8
- Best Practices for Recovering Windows Server 2012 R2 and Windows 8.1

Windows

## Restoring the Windows operating system with Automated System Recovery

---

You can restore the Windows operating system of a computer with Automated System Recovery (ASR).



## Procedure

---

For instructions that describe how to restore a Windows system by using ASR, see the following IBM Spectrum Protect™ Wiki articles:

- Best Practices for Recovering Windows Server 2012 and Windows 8
- Best Practices for Recovering Windows Server 2012 R2 and Windows 8.1

## What to do next

---

You can now restore other volumes.

### Related tasks:

Creating a bootable WinPE CD

Creating a client options file for Automated System Recovery

### Related reference:

Restore

Restore Systemstate

Windows

## Microsoft Dfs tree and file restore

---

To restore Dfs junctions and the data for each junction, restore the Dfs junction metadata first and then restore each junction separately.

If the junction metadata is not restored, IBM Spectrum Protect™ creates a directory under the Dfs root using the same name as that of the junction point and restores the data in that directory.

### Related tasks:

Microsoft Dfs file protection methods

AIX

Linux

Solaris

Windows

## Restoring an image

---

There are some items to consider before you begin restoring images on your system.

Before you restore an image (offline or online), you must have administrative authority on the system.

Here is a list of items to consider before you restore an image:

- Restoring the image of a volume restores the data to the same state that it was in when you performed your last image backup. Be absolutely sure that you need to restore an image, because it replaces your entire current file system or raw volume with the image on the server.
- **Windows** The image restore operation overwrites the volume label on the destination volume with the one that existed on the source volume.
- Ensure that the volume to which you are restoring the image is at least as large as the image that is being restored.
- **Linux** On Linux systems, some file systems such as ext2, ext3, ext4, btrfs, and xfs use a universally unique identifier (UUID) to identify themselves to the operating system. If you create an image backup of such a volume and you restore it to a different location, you might have two volumes with the same UUID. If you use UUID to define your file systems in `/etc/fstab`, be aware that the backup-archive client might be unable to correctly mount the restored file system because the UUIDs conflict. To avoid this situation, restore the image to its original location. If you must restore it to a different location, change the UUID of either the original or restored volume before you mount the restored file system. Refer to the Linux documentation for instructions on how to change a UUID. You might also need to manually edit the `/etc/fstab` file so the original volume, the restored volume, or both volumes can be mounted.
- **AIX** | **Linux** | **Solaris** The file system or volume you are restoring to must be the same type as the original.
- **Windows** The file system or volume you are restoring to does not have to be the same type as the original. The volume does not even have to be formatted. The image restore process creates the appropriately formatted file system for you.
- Ensure that the target volume of the restore is not in use. The client locks the volume before starting the restore. The client unlocks the volume after the restore completes. If the volume is in use when the client attempts to lock the file system, the restore fails.
- You cannot restore an image to where the IBM Spectrum Protect™ client program is installed.
- **Windows** If you created an image of the system drive, you cannot restore the image to the same location because the client cannot have an exclusive lock of the system drive. Also, because of different system component configurations, the system

image might not be consistent across components (such as Active Directory). Some of these components can be configured to use different volumes where parts are installed on the system drive and others to non-system volumes.

- If you have run progressive incremental backups *and* image backups of your file system, you can perform an incremental image restore of the file system. The process restores individual files after the complete image is restored. The individual files restored are those backed up after the original image. Optionally, if files were deleted after the original backup, the incremental restore can delete those files from the base image.

Deletion of files is performed correctly if the backup copy group of the IBM Spectrum Protect server has enough versions for existing and deleted files. Incremental backups and restores can be performed only on mounted file systems, not on raw logical volumes.

- **AIX Linux Solaris** If for some reason a restored image is corrupted, you can use the `fsck` tool to attempt to repair the image.

You can use the `verifyimage` option with the `restore image` command to specify that you want to enable detection of bad sectors on the destination target volume. If bad sectors are detected on the target volume, the client issues a warning message on the console and in the error log.

If bad sectors are present on the target volume, you can use the `imagetofile` option with the `restore image` command to specify that you want to restore the source image to a file. Later, you can use a data copy utility of your choice to transfer the image from the file to a disk volume.

- **Windows** If for some reason a restored image is corrupted, you should run `chkdsk` to check for and repair any bad sectors (unless the restored volume is RAW).

You can use the `verifyimage` option with the `restore image` command to specify that you want to enable detection of bad sectors on the destination target volume. If bad sectors are detected on the target volume, the client issues a warning message on the console and in the error log.

If bad sectors present on the target volume, you can use the `imagetofile` option with the `restore image` command to specify that you want to restore the source image to a file. Later, you can use a data copy utility of your choice to transfer the image from the file to a disk volume.

- **AIX Linux Solaris Windows** Restoring an image using the GUI  
You can use the GUI to restore an image of your file system or raw logical volume.
- **AIX Linux Solaris Windows** Restoring an image using the command line  
Use the `restore image` command to restore an image using the IBM Spectrum Protect command line client.

#### Related reference:

Imagetofile

Verifyimage

**AIX Linux Solaris Windows**

## Restoring an image using the GUI

---

You can use the GUI to restore an image of your file system or raw logical volume.

### About this task

---

Follow these steps to restore an image of your file system or raw logical volume:

### Procedure

---

1. Click **Restore** from the main window. The Restore window appears.
2. Expand the directory tree.
3. Locate the object in the tree named **Image** and expand it. Click the selection box next to the image you want to restore. You can obtain detailed information about the object by highlighting the object and selecting **View → File Details...** from the main window or click the **View File details** button.
4. **(Optional)** To perform an incremental image restore, click the **Options** button to open the Restore Options window and select the **Image plus incremental directories and files** option. If you want to delete inactive files from your local file system, select the **Delete inactive files from local** check box. Click the **OK** button.
5. **AIX Linux Solaris** Click **Restore**. The Restore Destination window appears. The image can be restored to the volume with the mount point from which it was originally backed up. Alternatively, a different volume can be chosen for the

restore location.

6. **Windows** Click **Restore**. The Restore Destination window appears. The image can be restored to the volume with the drive letter or mount point from which it was originally backed up. Alternatively, a different volume can be chosen for the restore location.
7. Click the **Restore** button to begin the restore. The **Task List** window appears showing the progress of the restore. The Restore Report window displays a detailed status report.

## Results

---

The following are some items to consider when you perform an image restore using the GUI:

- You can select **View** → **File Details** from the main window or click the **View File details** button to display the following statistics about file system images backed up by the client:
  - Image Size - This is the volume size which was backed up.
  - **AIX** | **Linux** | **Solaris** Stored Size - This is the actual image size stored on the server. The stored image on the IBM Spectrum Protect™ server is the same size as the volume capacity.
  - **Windows** Stored Size - This is the actual image size stored on the server. Because image backup allows you to back up only used blocks in a file system, the stored image size on the IBM Spectrum Protect server could be smaller than the volume size. For online image backups, the stored image can be larger than the file system based on the size of the cache files.
  - File system type
  - Backup date and time
  - Management class assigned to image backup
  - Whether the image backup is an active or inactive copy
- To modify specific restore options, click the **Options** button. Any options you change are effective during the current session *only*.
- In the Restore Options window, you can choose to restore the image only or the image and incremental directories files. If you choose **Image Only**, you restore the image from your last image backup only. This is the default.

If you ran incremental-by-date image backup on a volume or image backups on a volume with incrementals, you can choose the **Image plus incremental directories and files** option. If you choose **Image plus incremental directories and files**, you can also select **Delete inactive files from local** to delete the inactive files that are restored to your local file system. If incremental-by-date image backup was the only type of incremental backup you performed on the file system, deletion of files will not occur.

Important: Be absolutely sure that you need to perform an incremental restore because it replaces your entire file system with the image from the server and then restore the files that you backed up using the incremental image backup operation.

**AIX** | **Linux** | **Solaris** | **Windows**

## Restoring an image using the command line

---

Use the restore image command to restore an image using the IBM Spectrum Protect™ command line client.

**Windows** You can use the verifyimage option with the restore image command to specify that you want to enable detection of bad sectors on the destination target volume. If bad sectors are detected on the target volume, IBM Spectrum Protect issues a warning message on the console and in the error log.

**Windows** If bad sectors are present on the target volume, you can use the imagetofile option with the restore image command to specify that you want to restore the source image to a file. Later, you can use a data copy utility of your choice to transfer the image from the file to a disk volume.

### Related reference:

Imagetofile  
Verifyimage

## Restore data from a backup set

---

Your IBM Spectrum Protect™ administrator can generate a backup set, which is a collection of your files that reside on the server, onto portable media created on a device using a format that is compatible with the client device.

You can restore data from a backup set from the IBM Spectrum Protect server, or when the backup set is locally available as a file or on a tape device.

You can restore backup sets from the following locations:

- From the IBM Spectrum Protect server
- From portable media on a device attached to your client workstation
- From a backup set file on your client workstation

Backup sets can provide you with instant archive and rapid recovery capability as described in the following list.

#### Instant archive

This capability allows an administrator to create an archive collection from backup versions already stored on the server.

#### Rapid recovery with local backup sets

Typically, restores are performed from normal file backups that are stored on the IBM Spectrum Protect server outside of backup sets. This restore approach gives you the ability to restore the most recent backup version of every file. It is possible that a backup set does not contain the most recent backup version of your files.

In some cases restoring data from a backup set can be a better option than restoring data from normal backup files on the IBM Spectrum Protect server. Restoring from a backup set can be a better option for the following reasons:

- A backup set restore can provide for a faster recovery because all of the required files for restore are contained together within a smaller number of storage volumes.
- A backup set provides a point-in-time collection of files. You can restore to a point in time rather than restoring what is currently available from a normal file-level restore from the server.
- **Windows** You can perform an ASR restore using a backup set volume.

Restoring a backup set from the IBM Spectrum Protect server provides a larger set of restore options than restoring from a local backup set. However, restoring from a local backup set can be preferable in some cases:

- It is possible that you need to restore your data when a network connection to the IBM Spectrum Protect server is not available. This is possible in a disaster recovery situation.
- The local restore may be faster than restoring over a network connection to your IBM Spectrum Protect server.

A backup set can be restored from the IBM Spectrum Protect server while the backup set volumes are available to the server, or they can be moved to the client system for a local backup set restore. A backup set can be generated with or without a table of contents (TOC), and can contain file data or image data.

**Windows** The backup set can contain system state data.

Your ability to restore data from backup sets is restricted by the location of the backup set and the type of data in the backup set. The command-line client can restore some data that the GUI cannot restore, but the GUI can allow you to browse and choose which objects to restore. Generally, backup sets from the server with a TOC allow more options when restoring. However, local backup sets provide options that are sometimes preferable to restoring from the IBM Spectrum Protect server.

The restrictions for restoring data from backup sets using the GUI are summarized in the following table. Each interior cell represents one combination of data type and backup set location. For each situation, the cell indicates if you can use the GUI to restore only the entire backup set, to select objects within the backup set, or if you cannot use the GUI to restore the backup set.

Table 1. Backup set GUI restore restrictions

Data type in the backup set	Backup set location		
	Local (location=file or location=tape)	IBM Spectrum Protect Server (TOC available)	IBM Spectrum Protect Server (TOC not available)
file	Restore entire backup set only.	Restore entire backup set, or selected objects in the backup set.	Restore entire backup set only.
image	Cannot be restored.	Restore entire backup set, or selected objects in the backup set.	Cannot be restored.
system state	Restore entire backup set only.	Restore entire backup set, or selected objects in the backup set.	Restore entire backup set only.

The restrictions for restoring data from backup sets using the command-line client are summarized in the following table. Each interior cell represents one combination of data type and backup set location. For each situation, the cell lists the restore commands you can use. Except as noted, you can restore specific objects within a backup set, as well as the entire backup set.

Table 2. Backup set command-line restore restrictions

Data type in the backup set	Backup set location		
	Local (location=file or location=tape)	IBM Spectrum Protect Server (TOC available)	IBM Spectrum Protect Server (TOC not available)
file	Commands: restore restore backupset	Commands: restore restore backupset	Commands: restore backupset
image	Cannot be restored	Command: restore image	Cannot be restored
system state	Command: restore backupset	Commands: restore backupset restore systemstate	Command: restore backupset

Restriction: When restoring system state data using the restore backupset command, you cannot specify individual objects. You can only restore the entire system state.

- Restore backup sets: considerations and restrictions  
This topic lists some considerations and restrictions that you must be aware of when restoring backup sets.
- Backup set restore  
IBM Spectrum Protect considers a backup set as one object containing the whole file structure. You can restore the entire backup set or, in some cases, you can select portions. The backup set media is self-describing and contains all the information required to perform a successful restore.
- Restoring backup sets using the GUI  
The client GUI can restore data from a backup set from the server, from a local file, or from a local tape device. You can use the GUI to restore individual files from a backup set from the IBM Spectrum Protect server with a TOC, but not from a local backup set nor from a backup set from the server without a TOC.
- Backup set restores using the client command-line interface  
The client command line interface can restore data from a backup set from the server, from a local file, or from a local tape device. You can use the client command line interface to restore individual files from local backup sets and from backup sets without a TOC.

**Related reference:**

[Mac OS X](#) | [AIX](#) | [Linux](#) | [Solaris](#) | [Windows](#) | Localbackupset

Query Backupset

[Mac OS X](#) | [AIX](#) | [Linux](#) | [Solaris](#) | [Windows](#) | Query Image

Restore

Restore Backupset

[Mac OS X](#) | [AIX](#) | [Linux](#) | [Solaris](#) | [Windows](#) | Restore Image

[Windows](#) | Restore Systemstate

## Restore backup sets: considerations and restrictions

This topic lists some considerations and restrictions that you must be aware of when restoring backup sets.

### Backup set restore considerations

Consider the following when restoring backup sets:

- If the object you want to restore was generated from a client node whose name is different from your current node, specify the original node name with the filespaceparameter on any of the restore commands.
- If you are unable to restore a backup set from portable media, check with your IBM Spectrum Protect™ administrator to ensure that the portable media was created on a device using a compatible format.
- If you use the restore backupset command on the initial command line with the parameter -location=tape or -location=file, the client does not attempt to contact the IBM Spectrum Protect server.
- When restoring a group from a backup set:
  - The entire group, or all groups, in the virtual file space are restored. You cannot restore a single group by specifying the group name, if there are several groups in the same virtual file space. You cannot restore a part of a group by

specifying a file path.

- Specify a group by using the following values:
  - Specify the virtual file space name with the filespace parameter.
  - Use the subdir option to include subdirectories.
- Limited support is provided for restoring backup sets from tape devices attached to the client system. A native device driver provided by the device manufacturer must always be used. The device driver provided by IBM to be used with the IBM Spectrum Protect server cannot be used on the client system for restoring local backup sets.
- **Mac OS X | AIX | Linux | Solaris** If a backup set contains files from several owners, the backup set itself is owned by the root user ID, and non-root user IDs cannot see the backup set. In this case, non-root user IDs can restore their files by obtaining the backup set name from the IBM Spectrum Protect administrator. Non-root users can restore only their own files.
- **Mac OS X | AIX | Linux | Solaris | Windows** To enable the client GUI to restore a backup set from a local device, without requiring a server connection, use the localbackupset option.

## Backup set restore restrictions

---

Be aware of the following restrictions when restoring backup sets:

- A backup set data that was backed up with the API cannot be restored or used.
- **AIX | Linux | Solaris | Windows** You cannot restore image data from a backup set using the restore backupset command. You can restore image data from a backup set only with the restore image command.
- **AIX | Linux | Solaris | Windows** You cannot restore image data from a local backup set (`location=tape` or `location=file`). You can restore image data from a backup set only from the IBM Spectrum Protect server.

## Backup set restore

---

IBM Spectrum Protect™ considers a backup set as one object containing the whole file structure. You can restore the entire backup set or, in some cases, you can select portions. The backup set media is self-describing and contains all the information required to perform a successful restore.

If you are connected to the Tivoli® Storage Manager Version 5.4 or later server, your server administrator can create backup sets that are stacked. Stacked backup sets can contain data from multiple client nodes, and they can contain different types of data for a particular client node. The types of data can be file data or image data.

**Windows** If you have upgraded from Tivoli Storage Manager Express®, some application data is also supported.

Restriction: Image data and application data restore processing is only available when restoring from the server. You cannot restore image data and application data from a client local backup set restore.

When a backup set is stacked, you can only restore data for your own node. Data for all other nodes is skipped. When restoring data from a stacked backup set on a local device, you can only restore file level data for your own client node. It is important that the nodename option is set to match the node name used to generate the backup set for one of the nodes in the stack.

Important: Due to the portability of local backup sets, you must take additional steps to secure your local backup sets on portable media. The backup set media should be physically secured because the backup set can be restored locally without authenticating with the server. Each user has access to all of the data on the stacked backup set, which means that the user has access to data that they do not own, by changing the node name or viewing the backup set in its raw format. Encryption or physical protection of the media are the only methods to ensure that the data is protected.

If you restore backup set data from the server, individual files, directories or entire backup set data can be restored in a single operation from the GUI or the command line. When you restore backup set data locally, the GUI can only display and restore an entire backup set. The command line can be used to restore individual files or directories stored in a backup set locally.

## Restoring backup sets using the GUI

---

The client GUI can restore data from a backup set from the server, from a local file, or from a local tape device. You can use the GUI to restore individual files from a backup set from the IBM Spectrum Protect™ server with a TOC, but not from a local backup set nor from a backup set from the server without a TOC.

### About this task

---

Important: Before you begin a restore operation, be aware that backup sets can contain data for multiple file spaces. If you specify a destination other than the original location, data from *all* file spaces are restored to the location you specify.

To restore a backup set from the GUI, perform the following steps:

1. [Mac OS X](#) | [AIX](#) | [Linux](#) | [Solaris](#) | [Windows](#) Click Restore from the GUI main window. The Restore window appears.
2. Locate the Backup Sets directory tree object and expand it by clicking the plus sign (+) beside it.
  - o [Mac OS X](#) | [AIX](#) | [Linux](#) | [Solaris](#) | [Windows](#) To restore the backup set from a local device, expand the Local object and the Specify backup set location window is displayed. On the window, select File name: or Tape name: from the list and enter the tape or file name location. You can also click the Browse button to open a file selection window and select a backup set.
  - o To restore data from backup set from the server, first expand the Server object and then either Filelevel or Image, depending on the type of restore requested.
3. Click the selection box next to the backup set or directory or file within the backup set that you want to restore.

You can select files from within a backup set if that backup set is from the server and has a table of contents.

4. Click Restore. The Restore Destination window appears. Enter the appropriate information.
5. Click Restore. The Task List window displays the restore processing status.

Note:

- If the object you want to restore is part of a backup set generated on a node, and the node name is changed on the server, any backup set objects that were generated prior to the name change will not match the new node name. Ensure that the node name is the same as the node for which the backup set was generated.
- [Mac OS X](#) | [AIX](#) | [Linux](#) | [Solaris](#) | [Windows](#) The client can be used to restore a backup set on an attached device with or without a server connection. If the server connection fails, a prompt appears to continue for purposes of local backup set restore. Also, the `localbackupset` option can be used to tell the client not to attempt the connection to the server.
- [Mac OS X](#) | [AIX](#) | [Linux](#) | [Solaris](#) | [Windows](#) Certain local devices such as tape devices (tape devices do not apply to Mac OS X) require device drivers to be set up prior to performing a restore. See the device manual for assistance with this task. You also need to know the device address in order to perform the restore.
- [Mac OS X](#) | [AIX](#) | [Linux](#) | [Solaris](#) | [Windows](#) The following features of a backup set restore from the server are not available when restoring locally:
  1. [Mac OS X](#) | [AIX](#) | [Linux](#) | [Solaris](#) | [Windows](#) Image restore.
  2. [Windows](#) Restoring individual system state components.
  3. [Mac OS X](#) | [AIX](#) | [Linux](#) | [Solaris](#) | [Windows](#) The GUI display and restore of individual files and directories. The command line can be used to restore an individual directory or file from a local backup set.
  4. [Windows](#) Application data restore if the server was migrated from the Tivoli® Storage Manager Express® product.

## Backup set restores using the client command-line interface

The client command line interface can restore data from a backup set from the server, from a local file, or from a local tape device. You can use the client command line interface to restore individual files from local backup sets and from backup sets without a TOC.

To restore a backup set from the client command line interface, use the `query backupset` command to display what backup set data is available, then use `restore` commands to restore the data.

You can use the following commands to restore data from backup sets:

- `restore`
- `restore backupset`
- `restore image`
- [Windows](#) `restore systemstate`

Use the appropriate command for the location of the backup set and the data in the backup set. For more information, see Table 2.

### Related reference:

Query Backupset

[AIX](#) | [Linux](#) | [Solaris](#) | [Windows](#) Query Image

Restore

Restore Backupset

[AIX](#) | [Linux](#) | [Solaris](#) | [Windows](#) Restore Image

[Windows](#) Restore Systemstate



## Restore Net Appliance CIFS shares

Restoring the share definition requires restoring the root directory of the share file space, which under most circumstances can be done as follows: `dsmc rest \\NetAppFiler\CifsShareName\ -dirsonly`.

The following output indicates that the root directory (and share definition has been restored):

```
Restoring          0 \\NetAppFiler\CifsShareName\ [Done]
```

If the CIFS share definition is deleted on the Net Appliance file server, the client is unable to directly restore the share definition because the share is no longer accessible.

The share definition can be restored indirectly by creating a temporary local share and restoring the share definition to the temporary share as follows:

```
md c:\tempdir net share tempshare=c:\tempdir
 /remark:"Temporary Share for Restoring Deleted CIFS Share"
net use z: \\LocalMachineName\tempshare
dsmc res \\NetAppFiler\CifsShareName\ z:\ -dirsonly
```

This restores the original share definition (including permissions) on the file server.

Older versions of the IBM Spectrum Protect™ server might have a problem which prevents restoring the root directory and the CIFS share definition. If this problem occurs, it can be circumvented by using by one of the following methods:

1. Use the `DISABLENQR` testflag to restore the root directory as follows:

```
dsmc res \\NetAppFiler\CifsShareName\ -test=disablenqr -dirsonly
```

2. Use the command line client `-pick` option with a restore command and select the root directory:

```
dsmc res \\NetAppFiler\CifsShareName\ -dirsonly -pick
```

### Related tasks:

Backing up Net Appliance CIFS share definitions

Linux | Windows

## Restoring data from a VMware backup

You can use several methods for restoring data from backups to a VMware virtual machine. The restore method depends on the type of backup and on the version of the backup-archive client software that you use to run the restore.

 This feature is available only if the client operates as a data mover for IBM Spectrum Protect™ for Virtual Environments: Data Protection for VMware.

Linux | Windows Full VM restore

Linux | Windows Use the `restore vm` command to restore an entire virtual machine from a full VM backup. When you restore a full VM backup, the restored image replaces the virtual machine or a new virtual machine is created. In a full VM restore, you restore all of the VMware files and the system state on Windows systems. If you have access to IBM Spectrum Protect recovery agent, you can restore individual files.

Linux | Windows Depending on the version of the backup-archive client that is running on the VMware client, use the appropriate method to restore a full VM backup:

Versions of the backup-archive earlier than 6.2.2:

Restore the full VM backup by using VMware Consolidated Backup. For more information, see the following topic:

Restoring full VM backups that were created with VMware Consolidated Backup

Versions of the backup-archive client at 6.2.2 or later:

Restore the full VM backup by using the vStorage API. The IBM Spectrum Protect V6.2.2 or later client can restore full VMware backups that were created with versions of the client that is earlier than V6.2.2. For more information, see the following topic:

Restoring full VM backups



## Windows File-level restore

**Windows** Use the restore command to restore individual files from a file-level VM backup. Use this method when you cannot practically restore an entire VMware image. File-level backups were created with the version 7.1 or earlier backup-archive clients.

The following restrictions apply to file-level restores:

- You can use the file-level restore method only if a file-level backup of the virtual machine exists.
- You cannot restore an entire virtual machine from file-level backups because the restore command does not re-create Windows system states.
- You cannot use this method to restore individual files from a full VM backup of a virtual machine.

**Windows** Depending on the configuration of the virtual machine where you restore the files, use the appropriate method to restore files from a file-level backup:

The backup-archive client is not installed on the VM:

Restore the files from the vStorage backup server that backed up the virtual machine.

The backup-archive client is installed on the VM:

Restore the file from the backup-archive client that is installed on the virtual machine.

For more information, see the following topic:

Scenario: Restoring file-level VM backups

- **Windows** Restoring full VM backups  
You can restore a full VMware backup to re-create all of the files for a VMware virtual machine (VM) directly to the VMware server. This method replaces the deprecated method of restoring backups that were created by using the VMware Consolidated Backup (VCB) tools. This restore method does not require you to use the VMware converter tool before you restore the backup to the VMware server. You cannot use this restore method to restore individual files from a full VM backup.
- **Windows** Scenarios for running full VM instant access and full VM instant restore from the backup-archive client command line  
Full VM instant access and full VM instant restore operations require a license for IBM Spectrum Protect for Virtual Environments. You can perform either of these operations from the backup-archive client command line. Instant access and instant restore operations and options are supported only for VMware virtual machines that are hosted on VMware ESXi 5.1 servers, or later versions.
- **Windows** Scenario: Restoring file-level VM backups  
On Microsoft Windows systems, you can restore specific files from a file-level backup of a VMware virtual machine. A file-level restore is useful for restoring individual files that might be lost or damaged. You cannot use this method to restore files that were part of a full VM backup. Before you can restore files from the off-host backup server onto the VMware virtual machine, the off-host backup server must be configured as a proxy server.
- **Windows** Restoring full VM backups that were created with VMware Consolidated Backup  
You can restore a full VMware backup to re-create all of the files for a VMware virtual machine (VM). Complete these steps to restore full VM backups that were created by using VMware Consolidated Backup (VCB) running on IBM Spectrum Protect Version 6.2.0 or earlier.

Linux | Windows

## Restoring full VM backups

---

You can restore a full VMware backup to re-create all of the files for a VMware virtual machine (VM) directly to the VMware server. This method replaces the deprecated method of restoring backups that were created by using the VMware Consolidated Backup (VCB) tools. This restore method does not require you to use the VMware converter tool before you restore the backup to the VMware server. You cannot use this restore method to restore individual files from a full VM backup.

### Before you begin

---

 This feature is available only if the client operates as a data mover for IBM Spectrum Protect™ for Virtual Environments: Data Protection for VMware.

To restore a full VMware backup that was created by using VCB tools in IBM Spectrum Protect Version 6.2.0 or earlier, see the topic "Restoring full VM backups that were created with VMware Consolidated Backup".

### Procedure

---

1. Depending on the target location for the restore, complete the appropriate step:
  - o If the restore of the full VM backup is going to overwrite the existing VMware virtual machine, delete the existing virtual machine.
  - o If you restore the full VM backup to a new virtual machine, you do not need to delete the existing virtual machine. You can delete the existing virtual machine if you prefer, otherwise proceed to the next step.
2. Query the virtual machine for VMware backups, by completing the following steps:
  - a. From the off-host backup server, run the following command:

```
dsmc q vm *
```

The command lists the available backups, for example:

#	Backup Date	Mgmt Class	Type	A/I	Virtual Machine
1	12/03/2009 03:05:03	DEFAULT	VSTORFULL	A	vm_guest1
2	09/02/2010 10:45:09	DEFAULT	VSTORFULL	A	vm_guest11
3	09/02/2010 09:34:40	DEFAULT	VSTORFULL	A	vm_guest12
4	09/02/2010 10:10:10	DEFAULT	VSTORFULL	A	vm_guest13
5	12/04/2009 20:39:35	DEFAULT	VSTORFULL	A	vm_guest14
6	09/02/2010 11:15:18	DEFAULT	VSTORFULL	A	vm_guest15
7	09/02/2010 02:52:44	DEFAULT	VSTORFULL	A	vm_guest16
8	08/05/2010 04:28:03	DEFAULT	VSTORFULL	A	vm_guest17
9	08/05/2010 05:20:27	DEFAULT	VSTORFULL	A	vm_guest18
10	08/12/2010 04:06:13	DEFAULT	VSTORFULL	A	vm_guest19
11	09/02/2010 00:47:01	DEFAULT	VSTORFULL	A	vm_guest7
12	09/02/2010 01:59:02	DEFAULT	VSTORFULL	A	vm_guest8
13	09/02/2010 05:20:42	DEFAULT	VSTORFULL	A	vm_guest9

ANS1900I Return code is 0.

ANS1901I Highest return code was 0.

- b. From the results that are returned by the query command, identify a virtual machine to restore.
3. Restore the full VMware backup, by using the restore vm command. To restore the backup to a virtual machine with a new name, use the -vmname option. For example, in the following command the virtual machine is restored and a new name is specified for the restored virtual machine:

```
dsmc restore vm my_old_vmname -vmname=new_vm_name -datastore=myPath
```

4. When the restore is complete, the virtual machine is powered off. Start the virtual machine from the VMware vCenter.

Windows

## What to do next

If you are restoring application protection backups, see Shadow copy considerations for restoring an application protection backup from the data mover.

- **Windows** Shadow copy considerations for restoring an application protection backup from the data mover  
For Windows VMware virtual machines (VMs), if you attempt to restore an application protection backup from the data mover, be aware of shadow copy restrictions when you restore the application protection backup.

### Related tasks:

Restoring full VM backups that were created with VMware Consolidated Backup

### Related reference:

**Linux** | **Windows** Query VM

**Linux** | **Windows** Restore VM

INCLUDE.VMSNAPSHOTATTEMPTS

Windows

## Scenarios for running full VM instant access and full VM instant restore from the backup-archive client command line

Full VM instant access and full VM instant restore operations require a license for IBM Spectrum Protect™ for Virtual Environments. You can perform either of these operations from the backup-archive client command line. Instant access and instant restore operations and options are supported only for VMware virtual machines that are hosted on VMware ESXi 5.1 servers, or later versions.

The following scenarios demonstrate the full VM instant access or full VM instant restore operations that you might perform. Before you can complete the operations that are described in the following text, you must configure at least one data mover node on the vStorage backup server so it can protect the virtual machines by starting off host backup and restore operations. The steps for setting up the data mover nodes are described in Setting up the data mover nodes in a vSphere environment.

## Scenario: You want to perform a full VM instant access to verify the integrity of a backed up image of a VMware virtual machine, without actually restoring the virtual machine or disks to the ESXi host

---

The purpose of this goal is to verify that a backed up virtual machine image can be used to successfully restore a system if the virtual machine is deleted or its disks and data are corrupted or otherwise unusable.

For this scenario, assume that an ESX server has a virtual machine named Orion running on it. You want to verify that the backed up image that is stored by the IBM Spectrum Protect server can be used to restore this virtual machine if the current virtual machine fails.

You perform a VM instant access operation, you use the `restore vm` command with inventory location options specified to identify the location for the restored virtual machine. All inventory location options, such as `vmname`, `datacenter`, `host`, and `datastore` can be used in combination with the instant access option (`-VMRESToretype=INSTANTAccess`) to specify the location for the restored (instant access) virtual machine.

Because the Orion virtual machine does exist in the inventory and is running, you must provide a new name for a temporary virtual machine by adding the new name to the `vmname` option. You must also add the `-VMRESToretype=INSTANTAccess` option to the command line to indicate that this is an instant access restore operation.

Entering the following command prepares a virtual machine named "Orion\_verify" so it is available for instant access. You can use this virtual machine to verify that the backed-up image can be restored.

```
dsmc restore vm Orion -vmname=Orion_verify -Host=esxi.example.com  
-datacenter=mydataCenter -VMRESToretype=INSTANTAccess -VMAUTOSTARTvm=YES
```

The `-VMAUTOSTARTvm=YES` option indicates that the virtual machine is started when it is restored. By default, the new virtual machine is not automatically started. With this default setting, you can reconfigure the virtual machine before you start it.

You can also list the versions of a virtual machine that were backed up by using the `inactive` or `pick` options or the `pittime` or `pitdate` options to select an inactive or active backup, from a particular date or time. For example, to display a list of backed up versions of the Orion virtual machine, by using the following command:

```
dsmc restore vm Orion -pick
```

For a virtual machine that is restored by using the `-VMRESToretype=INSTANTAccess` option, temporary data that is created by this virtual machine is stored in a VMware snapshot.

After you restore the temporary virtual machine (Orion\_verify), run verification tools on it to verify the integrity of the disks and data. Use a utility such as `chkdsk`, or a utility or application of your choosing, to verify the virtual disks and data. If the temporary virtual machine passes the integrity checks, you can remove the temporary resources that were created to support the instant access restore operation.

## Scenario: You want to determine whether any temporary (instant access) virtual machines exist, so you can run a clean-up operation to free the resources associated with them

---

Use the `query vm` command with one of the following options that you specify on the command line:

```
-VMRESToretype=INSTANTAccess  
-VMRESToretype=ALLtype
```

Where:

```
-VMRESToretype=INSTANTAccess
```

Displays all temporary virtual machines that are running in instant access mode, created by a `restore vm -VMRESToretype=INSTANTAccess` operation.

```
-VMRESToretype=ALLtype
```

Displays all virtual machines with active instant access or instant restore sessions that were started by a `restore vm` command that uses either the `-VMRESToretype=INSTANTAccess` or `VMRESToretype=-INSTANTRestore` options.

The following examples show the syntax for the various options:

```
query vm * -VMREST=INSTANTA
query vm * -VMREST=ALL
```

You can add a `-Detail` option to each of the `query vm` commands shown to display more information about each of the temporary virtual machines.

```
query vm vmname -VMREST=INSTANTA -Detail
```

To remove the resources that were created for a temporary virtual machine named "Orion\_verify", run the following command:

```
dsmc restore vm Orion -vmname=Orion_verify -VMRESToretype=VMCLeanup
```

The `-VMRESToretype=VMCLeanup` option deletes the temporary virtual machine from the ESXi host, unmounts any iSCSI mounts that were mounted, and clears the iSCSI device list from the ESX host. All temporary data for the temporary virtual machine is deleted from the VMware snapshot.

## Scenario: You want to start an instant restore operation to restore a failed virtual machine to an ESX host, from a backup image created by IBM Spectrum Protect

---

The advantage of a full VM instant restore, as opposed to a classic full VM restore, is that an instant restore operation makes the virtual machine ready for immediate use, as soon as it is started. You do not have to wait for all data to be restored before you can use the virtual machine. During an instant restore operation, the virtual machine uses iSCSI disks until its local disks are fully restored. When the local disks are restored, the virtual machine switches I/O from the iSCSI disks to the local disks, without noticeable interruption of service.

Restore a virtual machine named Orion by using the following command:

```
dsmc restore vm Orion -Host=esxi.example.com -datacenter=mydatacenter
  -VMTEMPDatastore=temp_datastore -VMRESToretype=INSTANTRestore
  -datastore=mydatastore
```

This command specifies the name of the virtual machine to restore, the host and data center to restore it to, and the restore type (`-VMRESToretype=INSTANTRestore`). The `VMTEMPDatastore` option is a mandatory parameter for instant restore operations.

The temporary datastore is used by vMotion to store the configuration of the restored virtual machine during the instant restore process. The name that you specify must be unique. It cannot match the name of any of the original datastores that were used by the virtual machine when it was backed up, and it cannot be the same as the name specified on the optional `-datastore` option. If the `-datastore` option is omitted, the virtual machine files are restored to the datastores that they used when the virtual machine was backed up.

By default, virtual machines that are instantly restored are provisioned with thick disks. You can change this behavior and provision thin disks by adding the `-VMDISKProvision=THIN` option to the command line, or in the client options file.

**Important:** For instant restore operations, ensure that both the temporary datastore that you specify with the `vmtempdatastore` option and the VMware datastore that is specified by the `datastore` option on the restore VM command have enough free storage to save the virtual machine that you are restoring, and the snapshot file that contains changes that were made to the data. If you are restoring a virtual machine and you specify thin or thick provisioning (`-vmdiskprovision=thin` or `-vmdiskprovision=thick`), the datastore that you restore the VM to must have enough free space to accommodate the total capacity of the VM disk, and not just the amount of disk that is used. For example, if a VM has 300 GB total capacity for its disk, you cannot restore that VM to a datastore that has less than 300 GB available, even if only a portion of the total capacity is being used.

- **Windows** Full VM instant restore cleanup and repair scenarios  
When an instant restore operation fails after the VM is powered on, manual cleanup and repair tasks are required.
- **Windows** Recovering from non-standard error conditions  
Problems with iSCSI devices can prevent you from performing an instant access or instant restore operation.

**Windows**

## Full VM instant restore cleanup and repair scenarios

---

When an instant restore operation fails after the VM is powered on, manual cleanup and repair tasks are required.

 This feature is available only if the client operates as a data mover for IBM Spectrum Protect™ for Virtual Environments: Data Protection for VMware.

An instant restore operation that fails with storage vMotion running creates either of the following situations:

- The instant restore operation generates an error message.
- The instant restore operation suspends indefinitely and the VM is not responsive.

To determine the cause of the problem, perform a detailed query of the VM by using the following command:

```
dsmc q vm * -vmrestoretype=instantrestore -detail
```

In the output that is produced by this command, for each VM in the output, look for the line that contains `Action Needed`. Use the following *Action Needed* paragraphs to recover from failed instant restore operation, depending on the `Action Needed` status.

## Action Needed: Cleanup

---

In the output of the `query vm * -vmrestoretype=instantrestore -detail` command, verify that the storage vMotion status is successful (`vMotion Status: Successful`) and that all VM disks are physical disks (`Disk Type: Physical`). This status confirms that the VM was restored and cleanup of orphaned components, such as iSCSI mounts, is needed.

This type of failure occurs as a result of either of the following situations:

- The instant restore failed and Storage vMotion is running. VMware vSphere continues the vMotion process.
- Storage vMotion finished successfully, but the automatic cleanup of the iSCSI mounts fails.

To clean up any orphaned components, run the `restore vm` command with the `-VMRESToretype=VMCleanup` parameter. For example:

```
dsmc restore vm original_vmname -vmname=new_vm_name -VMRESToretype=VMCleanup
```

## Action Needed: Repair

---

In the output of the `query vm * -vmrestoretype=instantrestore -detail` command, verify that the iSCSI device that is attached to the VM is dead (status is `Disk Path: Dead`).

This type of failure occurs as a result of one of the following three situations:

- The VM that is used as a data mover or the physical data mover machine failed.
- A network failure occurred between the data mover and the ESX host or the data mover and the IBM Spectrum Protect server.
- The Data Protection for VMware Recovery Agent Service failed.

The iSCSI device must be returned to an active state before any other instant operation is attempted.

To attempt to recover from a data mover failure, complete the following steps:

1. Investigate that cause of the failure and restart the data mover machine if it does not start automatically. This action starts an automatic recovery of the mounted iSCSI disks.
2. In the output of the `query vm * -vmrestoretype=instantrestore -detail` command, verify that the VM disks are active (`Disk Path: Active`). This status means that the VM was restored and is available for use.
3. Restart storage vMotion in the vSphere client and monitor its progress in the vSphere client status bar.
4. If storage vMotion processing completed successfully, run the `restore vm` command with the `-vmrestoretype=VMCleanup` parameter to clean up the iSCSI disks. For example:

```
dsmc restore vm original_vmname -vmname=new_vm_name -VMRESToretype=VMCleanup
```

To attempt recovery after a network failure, complete the following steps:

1. Repair the network issue so that communication between the data mover and the ESX host, and the data mover and the IBM Spectrum Protect server resumes.
2. In the output of the `query vm * -vmrestoretype=instantrestore -detail` command, verify that the VM disks are active (`Disk Path: Active`). This status means that the VM was restored and is available for use.
3. If the network failure did not cause storage vMotion to time out, no action is required.
4. If the network failure caused storage vMotion to time out, and the error message indicates that the source disk is not responding, restart storage vMotion in the vSphere client. When storage vMotion processing completes, run the `restore vm` command with the `-vmrestoretype=VMCleanup` parameter to clean up the iSCSI disks. For example:

```
dsmc restore vm original_vmname -vmname=new_vm_name -VMRESToretype=VMCleanup
```

To attempt recovery after a Data Protection for VMware Recovery Agent service failure, complete the following steps:

1. Investigate that cause of the failure and restart the Data Protection for VMware Recovery Agent service if it does not start automatically. This action starts an automatic recovery of the mounted iSCSI disks.
2. In the output of the `query vm * -vmrestoretype=instantrestore -detail` command, verify that the VM disks are active (`Disk Path: Active`). This status means that the VM was restored and is available for use.
3. If the Data Protection for VMware Recovery Agent service failure did not cause storage vMotion to time out, no action is required.
4. If the Data Protection for VMware Recovery Agent service failure caused storage vMotion to time out, and the error message indicates that the source disk as not responding, restart storage vMotion in the vSphere client. When storage vMotion processing completes, run the restore vm command with the `-vmrestoretype=VMCleanup` parameter to clean up the iSCSI disks. For example:

```
dsmc restore vm original_vmname -vmname=new_vm_name -VMRESToretype=VMCleanup
```

## Full cleanup

---

If you are not able to recover from a failure and want to remove the VM and its components, run the restore vm with the `-vmrestoretype=VMFULLCleanup` parameter. For example:

```
dsmc restore vm original_vmname -vmname=new_vm_name -VMRESToretype=VMFULLCleanup
```

A VMFULLCleanup operation forces removal of the VM and all of its components, regardless of the state of the virtual machine. Do not start a full clean up operation while vMotion is still migrating a virtual machine.

Windows

## Recovering from non-standard error conditions

---

Problems with iSCSI devices can prevent you from performing an instant access or instant restore operation.

### About this task

---

When an ESX server cannot access a datastore on an iSCSI disk, a VMware message is issued to indicate that a "permanent device loss" error occurred. You should be offered an option to either cancel or retry the iSCSI connection attempt. Choose the option to try the operation again to see whether the error is transient and if recovery is possible. If the retry is not successful, try the following troubleshooting steps. If they are successful, then try the instant restore or instant access operation again.

 This feature is available only if the client operates as a data mover for IBM Spectrum Protect™ for Virtual Environments: Data Protection for VMware.

### Procedure

---

1. Examine the ESX server Task and Event log for an All Paths Down (APD) error. It can take time for this error to display in the logs, but it must be present before you continue to the next steps. If you do not wait for the error before you attempt more troubleshooting, you might bring the ESX server down.
2. Power off the virtual machine.
3. Rescan the HBA. Rescanning the HBA on the ESX server might reactivate the failed device. If VMware kernel locks prevent you from rescanning the HBA, perform the following steps:
  - a. In the vCenter interface, select the ESX host.
  - b. Click Configuration.
  - c. Right click iSCSI Software Adapter and select Properties.
  - d. Click Static Discovery.
  - e. Delete any static addresses and click Close.
  - f. Rescan the HBA.

Windows

## Scenario: Restoring file-level VM backups

---

On Microsoft Windows systems, you can restore specific files from a file-level backup of a VMware virtual machine. A file-level restore is useful for restoring individual files that might be lost or damaged. You cannot use this method to restore files that were

part of a full VM backup. Before you can restore files from the off-host backup server onto the VMware virtual machine, the off-host backup server must be configured as a proxy server.

## Before you begin

File-level backups were created with the version 7.1 or earlier backup-archive clients.

 This feature is available only if the client operates as a data mover for IBM Spectrum Protect™ for Virtual Environments: Data Protection for VMware.

**Important:** Use the restore command to run a file-level restore. Do not use the restore vm command.

The following assumptions are made for this scenario of a file-level restore:

- The goal is to restore files that were previously backed up to the IBM Spectrum Protect server.
- The files were previously backed up on a VMware virtual machine called Orion, with the host name orion. For this scenario, the Orion VM fails and some of the files must be restored.
- Files on Orion were backed up to file spaces that match the lowercase form of the computer host name. The file space names are expressed in Universal Naming Convention (UNC) format, for example:
  - Files that are backed up from the C: drive on Orion, are stored in the \\orion\c\$ file space.
  - If Orion has a D: drive, files that are backed up from that drive are stored in the \\orion\d\$ file space.
- In this scenario, the files are restored from the C:\mydocs directory that was on Orion to the C:\restore\_temp directory on a different computer. The computer that you restore file to can be another VMware virtual machine or a physical computer.
- The computer that runs the restore has a different host name and node name than the virtual machine Orion. During the restore, you must specify the source file specification in the complete UNC format and use one of the following parameters to access Orion:

-virtualnodename

Specifies the client node for which you are restoring a backup. Use this parameter if you are restoring files to the computer where you are currently logged on.

-asnodename

Specifies the client node for which you are restoring a backup. Use this parameter if you are restoring files to a computer for which you have proxy authority.

Complete the following steps to run a file-level restore for the computer Orion:

## Procedure

1. Query the IBM Spectrum Protect server to determine the file spaces that are registered for Orion:

```
dsmc query filespace -virtualnode=orion
```

2. Restore files for the Orion file space, by running one of the following commands:

Restore files to the computer where you are currently logged on:

Assume that you are currently logged on to the computer called Orion. Run one of the following commands:

- a. If you know the password for the node that you are restoring, use the -virtualnodename option in the restore command. For example, run the following command to restore the files to Orion:

```
dsmc restore \\orion\c$\mydocs\ c:\restore_temp\ -sub=yes  
-virtualnodename=orion
```

- b. If you have proxy authority, you can restore files on behalf of the target node. Proxy authority must be granted from the agent node, in other words the node of the computer that the restore is run from. You must know the password for the agent node so that you can access the target node. For example, run the following command to restore the files to Orion:

```
dsmc restore \\orion\c$\mydocs\ c:\restore_temp\ -sub=yes  
-asnodename=orion
```

Table 1. Components for the restore command when you restore files to the same computer

Command component	Description
-------------------	-------------



Command component	Description
\\orion\c\$\mydocs\	Source file specification on the IBM Spectrum Protect server. This location contains the backed up files that you are restoring. The files are backed up for the <code>orion</code> VM, so the file specification must be in UNC format.
c:\restore_temp\	Destination file specification on the computer where you are currently logged on. The files are restored to this location.
-sub=yes	Specifies that all subdirectories in the source file specification are included when you run the restore operation.
-virtualnodename=orion	Notifies the IBM Spectrum Protect server that the backup is running from the node <code>orion</code> .
-asnodename=orion	Notifies the IBM Spectrum Protect server that the backup is running from the node <code>orion</code> .

Restore files to a different computer:

To restore the files from the IBM Spectrum Protect server to a computer other than the one you are logged on to, run the following command. You can use this command only if you are logged in with authority to write to the remote computer as controlled by the operating system.

```
dsmc restore \\orion\c$\mydocs\ \\orion\c$\restore_temp\ -sub=yes
-virtualnode=orion
```

Table 2. Components for the restore command when you restore files to a different computer

Command component	Description
\\orion\c\$\mydocs\	Identifies the source file specification on the IBM Spectrum Protect server. This location contains the backed up files that you are restoring. The files are backed up for the <code>orion</code> VM, so the file specification must be in UNC format.
\\orion\c\$\restore_temp\	Identifies the destination file specification on a computer other than the computer where you are logged on. The You are restoring the files to the <code>orion</code> VM over the network, by using a Microsoft feature that identifies network locations in UNC notation.
-sub=yes	Specifies that all subdirectories in the source file specification are included when you run the restore operation.
-virtualnodename=orion	Notifies the IBM Spectrum Protect server that the backup is running from the node <code>orion</code> .

**Related concepts:**

Restoring data from a VMware backup

**Related tasks:**

Restoring full VM backups that were created with VMware Consolidated Backup

Restoring full VM backups

**Related reference:**

Linux	Windows	Query Filespace
Linux	Windows	Restore
Windows		

## Restoring full VM backups that were created with VMware Consolidated Backup

You can restore a full VMware backup to re-create all of the files for a VMware virtual machine (VM). Complete these steps to restore full VM backups that were created by using VMware Consolidated Backup (VCB) running on IBM Spectrum Protect™ Version 6.2.0 or earlier.



## Before you begin

To restore a full VMware backup that was created by using IBM Spectrum Protect Version 6.2.2 or later, see the topic "Restoring full VM backups".

 This feature is available only if the client operates as a data mover for IBM Spectrum Protect for Virtual Environments: Data Protection for VMware.

## Procedure

1. Depending on the target location for the restore, complete the appropriate step:
  - o If the restore of the full VM backup is going to overwrite the existing VMware virtual machine, delete the existing virtual machine.
  - o If you restore the full VM backup to a new virtual machine, you do not need to delete the existing virtual machine. You can delete the existing virtual machine, otherwise proceed to the next step.
2. Query the virtual machine for full VMware backups, by completing the following steps:
  - a. From the off-host backup server, run the following command:

```
dsmc q vm *
```

The command lists the available backups, for example:

#	Backup Date	Mgmt Class	Type	A/I	Virtual Machine
1	12/03/2009 03:05:03	DEFAULT	VMFULL	A	vm_guest1
2	09/02/2010 10:45:09	DEFAULT	VMFULL	A	vm_guest11
3	09/02/2010 09:34:40	DEFAULT	VMFULL	A	vm_guest12
4	09/02/2010 10:10:10	DEFAULT	VMFULL	A	vm_guest13
5	12/04/2009 20:39:35	DEFAULT	VMFULL	A	vm_guest14
6	09/02/2010 11:15:18	DEFAULT	VMFULL	A	vm_guest15
7	09/02/2010 02:52:44	DEFAULT	VMFULL	A	vm_guest16
8	08/05/2010 04:28:03	DEFAULT	VMFULL	A	vm_guest17
9	08/05/2010 05:20:27	DEFAULT	VMFULL	A	vm_guest18
10	08/12/2010 04:06:13	DEFAULT	VMFULL	A	vm_guest19
11	09/02/2010 00:47:01	DEFAULT	VMFULL	A	vm_guest7
12	09/02/2010 01:59:02	DEFAULT	VMFULL	A	vm_guest8
13	09/02/2010 05:20:42	DEFAULT	VMFULL	A	vm_guest9

```
ANS1900I Return code is 0.
```

```
ANS1901I Highest return code was 0.
```

- b. From the results that are returned by the query command, identify a virtual machine to restore.
3. Restore the full VMware backup, by using the restore vm command. To restore a virtual machine from a specific point in time, include the `-pitdate` and `-pittime` options, for example:

```
dsmc restore vm my_vm_name destination -pitdate=date -pittime=hh:mm:ss
```

Where:

*my\_vm\_name*

Name of the virtual machine that you are restoring.

*destination*

Directory location for the restored vmdk file.

*-pitdate*

Date that the backup was created.

*-pittime*

Time that the backup was created.

4. When the restore is completed, the following message is returned. Enter Y.

```
Virtual Infrastructure Client or VMware Converter tool  
can be used to redefine virtual machine to the VMware Virtual Center Inventory.
```

```
Would you like to launch VMware Converter now? (Yes (Y)/No (N))
```

Tip: If you enter N, the command-line returns without opening the VMware Converter. However, you must convert the image before the image can be restored.

5. To convert the restored VCB image into a virtual machine on a VMware server by using the VMware vCenter Converter tool, complete following steps:

- a. From the Windows Start menu, open the Converter tool.
  - b. From the Converter tool, click Convert Machine.
  - c. In the Virtual machine file field, enter the location of the restored .vmx file.  
Tip: The .vmx file is restored to the directory specified by the `vmbackdir` option of the `restore vm` command.
  - d. Follow the remaining steps in the wizard to convert the full VM backup.
6. When the restore is complete, the virtual machine is powered off. Start the virtual machine from the VMware vCenter.

**Related tasks:**

Restoring full VM backups

**Related reference:**

Linux	Windows	Query VM
Linux	Windows	Restore VM
Windows		

## Restore Windows individual Active Directory objects

---

You can restore individual Active Directory objects to recover from accidental corruption or deletion of Active Directory objects without requiring a shutdown or restart of the Active Directory server.

On the Windows Server client, use the `restore adobjects` command to restore local, deleted Active Directory objects (tombstone objects). You can also restore individual Active Directory objects from system state backups on the IBM Spectrum Protect™ server.

- **Windows** Reanimate tombstone objects or restoring from a system state backup  
Tombstone reanimation is a process to restore an object that had been deleted from the Active Directory. When an object is deleted from Active Directory, it is not physically erased, but only marked as deleted. It is then possible to reanimate (restore) the object.
- **Windows** Restoring Active Directory objects using the GUI and command line  
To restore individual Active Directory objects, you must run the backup-archive client on a domain controller and your user account must be a member of the Administrators group. The Active Directory objects are not displayed in the directory tree if your user account is not a member of the Administrators group.
- **Windows** Restrictions and limitations when restoring Active Directory objects  
There are some restrictions and limitations to be aware of when restoring Active Directory objects.
- **Windows** Preserve attributes in tombstone objects  
To specify an attribute to be preserved in the tombstone object, first locate this attribute in the Active Directory schema, then update the `searchFlags` attribute of the schema object.
- **Windows** Modifying the client acceptor and agent services to use the web client  
You cannot restore individual Active Directory objects using the web client by default. The web client services (client acceptor and agent) run under the Local System account by default. The Local System account does not have enough privileges to restore Active Directory objects.

**Related tasks:**

Restoring Windows system state

**Related reference:**

Restore Adobjects

Windows
---------

## Reanimate tombstone objects or restoring from a system state backup

---

Tombstone reanimation is a process to restore an object that had been deleted from the Active Directory. When an object is deleted from Active Directory, it is not physically erased, but only marked as deleted. It is then possible to reanimate (restore) the object.

When an object is reanimated, not all object attributes are preserved. When an object becomes a tombstone object, many attributes are automatically stripped from it, and the stripped attributes are lost. It is possible, however, to change the Active Directory schema so that more attributes are preserved when the object is deleted.

User-group links are not preserved in tombstones. For example, when a user object is reanimated, the user account is not a member of any group. All of this information must be recreated manually by the Active Directory administrator.

When an Active Directory object is restored from a system state backup on the IBM Spectrum Protect™ server, virtually all of its attributes and its group membership are restored. This is the best restore option using a Windows Server domain controller. When an object is restored from the server:

- The Active Directory database is extracted from a system state backup and restored into a temporary location.
- The restored database is opened.
- Select which objects you want to restore. For each object:
  - A search for the matching tombstone is performed. The Globally Unique Identifier (GUID) of the restored object is used to search for the tombstone.
  - If the matching tombstone is found, it is reanimated. In this case, the restored object retains the original Globally Unique Identifier (GUID) and the Security Identifier (SID).
  - If the matching tombstone is not found, a new object is created in the database. In this case, the new object has a new GUID and a new SID that are different than the original object.
- Missing attributes are copied from the backup into the reanimated or recreated object. Existing attributes that have been changed since the backup was taken are updated to match the value in the backup. New attributes that have been added since the backup was taken are removed.
- Group membership is restored.

Although all attributes that can be set and the group links are recreated, the restored objects might not be immediately available after the restore operation. An Active Directory administrator might have to manually update the restored objects in order to make them available. Make sure to read Restrictions and limitations when restoring Active Directory objects before performing the restore.

**Related concepts:**

Preserve attributes in tombstone objects

Restoring your data

Restrictions and limitations when restoring Active Directory objects

**Related tasks:**

Restoring Windows system state

**Related reference:**

Restore Adobjects

 Windows

## Restoring Active Directory objects using the GUI and command line

---

To restore individual Active Directory objects, you must run the backup-archive client on a domain controller and your user account must be a member of the Administrators group. The Active Directory objects are not displayed in the directory tree if your user account is not a member of the Administrators group.

You can restore active directory objects or tombstone objects using either the GUI or the command line.

To restore individual objects from the GUI:

1. Click Restore in the IBM Spectrum Protect™ window. The Restore window opens.
2. Expand the directory tree if necessary. To expand an object in the tree, click the plus sign (+) next to the object.
3. Locate the Active Directory node in the directory tree. Expand it to reveal Local Deleted Objects. The Server object is also available.
  - To restore tombstone objects, expand Local Deleted Objects, navigate to the tombstone objects that you want to restore, and select the tombstone objects.
  - To restore Active Directory objects that are backed up to the IBM Spectrum Protect server:
    - a. Expand the Server object. A window opens displaying a list of system state backups (with different time stamps) on the server.
    - b. Select a system state backup from the list. The Active Directory database from that system state is restored in the background, and the tree is populated with Active Directory objects.
    - c. Navigate to the Active Directory objects that you want to restore and select the Active Directory objects.

Tip: To see the attributes for an Active Directory object, keep expanding each Active Directory object in the tree until you reach the one you want. The attributes for an object are displayed in the display area that is adjacent to the tree. You can search or filter the tree for an Active Directory object based on its name.
4. Click Restore to begin the restore operation. The Task List window opens and shows the progress of the restore operation.

On the command line, use the query adobjects command to query and the restore adobjects command to restore individual Active Directory objects.

**Related reference:**

Query Adobjects

Restore Adobjects

 Windows

# Restrictions and limitations when restoring Active Directory objects

---

There are some restrictions and limitations to be aware of when restoring Active Directory objects.

Understand the following restrictions before restoring objects:

- Do not restore the Active Directory as part of a system-state restore operation, unless it is intended to be used for a disaster recovery-level restore operation of the full Active Directory. This type of restore operation requires the Active Directory Server to be stopped and restarted.
- You cannot perform a point-in-time restore of tombstone objects. You can perform a point-in-time restore of Active Directory objects that are backed up to the server.
- You cannot restore Active Directory objects from backup sets.

Understand the following limitations before restoring objects:

- Restoring Active Directory objects from the IBM Spectrum Protect™ server requires temporary space on your local hard disk drive. You can use the `stagingdirectory` option to specify a directory on your local hard disk for storing temporary data from the server. Depending on the size of the temporary data, network bandwidth, and both client and server performance, this operation can take anywhere from 20 seconds to over an hour. There might be a delay in refreshing the Restore window when displaying the Active Directory tree.
- User passwords cannot be restored by default. A restored user object is disabled until the administrator resets the password and re-enables the account. Also, if an account was deleted from the domain and is then restored by the backup-archive client, it must be manually joined to the domain after the restore operation. Otherwise, users on the target computer cannot log on to the domain.

In order to have a user or a computer object fully operational after restore, you must modify schema attribute *Unicode-Pwd* as described in **Preserve attributes in tombstone objects**.

- The Active Directory schema is not recreated when the Active Directory object is restored. If the schema was modified after the backup, the restored object might no longer be compatible with the new schema, and some Active Directory object attributes might no longer be valid. The client issues a warning message if some attributes cannot be restored.
- Group Policy Objects and their links to organizational units (OU) cannot be restored.
- Local policies for restored Active Directory objects are not restored.
- When you restore an object from the IBM Spectrum Protect server, if the target object already exists in the Active Directory and you replace it with its backup version, the object is not deleted and recreated. The existing object is used as a base, and its attributes are overwritten by the backup version. Some attributes, such as the GUID and the SID, stay with the existing object and are not overwritten by the backup version.
- If there are multiple tombstone objects for the same container, reanimate them from the backup-archive client command line using the object GUID, in which case the command-line client only reanimates the container object and not its children. In the backup-archive client GUI, the entire container can be selected to reanimate.
- When you restore an object from the IBM Spectrum Protect server, if the live Active Directory object exists and has the *prevent deletion* bit on, the client can modify the attributes of the object. However, if there is a tombstone object of the same name but a different object GUID, the Directory Services returns the *access denied* error.
- When you restore an object from the IBM Spectrum Protect server and the container of the object has been renamed, the client recreates the container using the original name at the time of the backup. When restoring a tombstone object, the client restores it to the renamed container because the *lastKnownParent* attribute of the tombstone object has been updated to reflect the new container name.

## Related concepts:

Preserve attributes in tombstone objects

Restoring your data

## Related reference:

Restore Adobjects

Stagingdirectory

Windows

---

## Preserve attributes in tombstone objects

---

To specify an attribute to be preserved in the tombstone object, first locate this attribute in the Active Directory schema, then update the *searchFlags* attribute of the schema object.

There is vendor-acquired software (for example, ADSI Edit) that allows you to update the *searchFlags* attribute of the schema object.

Usually none of the bits in the *searchFlags* bit mask are set (the value is 0). Set *searchFlags* to 8 (0x00000008) if you want Active Directory to save the particular attribute in the tombstone object when the original object is deleted.

**Related concepts:**

Restoring your data

**Related reference:**

Restore Adobjects

Windows

## Modifying the client acceptor and agent services to use the web client

---

You cannot restore individual Active Directory objects using the web client by default. The web client services (client acceptor and agent) run under the Local System account by default. The Local System account does not have enough privileges to restore Active Directory objects.

To enable this restore operation in the web client, follow these steps:

1. Modify the client acceptor and agent services to use an administrative account such as *Administrator* when logging on to Windows.
2. You can edit the properties for the client acceptor and agent services (typically called TSM Client Acceptor and TSM Remote Client Agent) in the Control Panel.
3. Modify the client acceptor and the agent services in the Login Options page of the IBM Spectrum Protect™ configuration wizard when you set up the web client

If the web client is already set up, follow these steps:

1. Click Start.
2. Click Control Panel → Administrative Tools → Services.
3. Select the scheduler service from the list of Windows services.
4. Click the Log On tab.
5. Click This Account in the *Login As* section.
6. Enter an administrative account, or click Browse to locate the domain account.
7. Enter the password for the domain account.
8. Click OK and then click Start.

**Related reference:**

Restore Adobjects

## Restoring or retrieving data during a failover

---

When the client fails over to the secondary server, you can restore or retrieve replicated data from the secondary server.

### Before you begin

---

Before you begin to restore or retrieve data during a failover:

- Ensure that the client is configured for automated client failover.
- Ensure that you are connected to an IBM Spectrum Protect™ server that replicates client nodes. For more information about failover requirements, see Requirements for automated client failover.

Restriction: In failover mode, you cannot back up or archive data to the secondary server.

### Procedure

---

To restore or retrieve data during a failover, complete the following steps:

1. Verify the replication status of the client data on the secondary server. The replication status indicates whether the most recent backup was replicated to the secondary server.
2. Restore or retrieve your data as you would normally do from the client GUI or from the command-line interface.  
Tip: Restartable restore operations function as expected when you are connected to the secondary server. However, restore operations that are interrupted when the primary server goes down cannot be restarted after the client fails over. You must run the whole restore operation again after the client fails over to the secondary server.

## Results

---

If the replicated data on the secondary server is not current, you are prompted to continue or to stop the restore or retrieve operation.

For example, to restore the build.sh directory at the command-line interface, you issue the following command:

**AIX**  
**Linux** | **Mac OS X** | **Solaris**

```
dsmc res /build.sh
```

**Windows**

```
dsmc res C:\build.sh
```

The following output is displayed:

```
IBM Spectrum Protect
Command Line Backup-Archive Client Interface
  Client Version 8, Release 1, Level 0.0
  Client date/time: 11/16/2016 12:05:35
(c) Copyright by IBM Corporation and other(s) 1990, 2016. All Rights Reserved.
```

```
Node Name: MY_NODE_NAME
ANS2106I Connection to primary IBM Spectrum Protect server 192.0.2.1 failed
```

```
ANS2107I Attempting to connect to secondary server TARGET at
192.0.2.9 : 1501
```

```
Node Name: MY_NODE_NAME
Session established with server TARGET: Windows
  Server Version 8, Release 1, Level 0.0
  Server date/time: 11/16/2016 12:05:35  Last access: 11/15/2016 14:13:32
```

```
Session established in failover mode to secondary server
ANS2108I Connected to secondary server TARGET.
Restore function invoked.
```

```
ANS2120W The last store operation date reported by the server TARGET of
05/16/2013 22:38:23 does not match the last store operation date of
05/21/2013 21:32:20 stored by the client.
Continue (Yes (Y)/No (N))
```

If you respond with **N**, the following message is displayed:

```
ANS1074W The operation was stopped by the user.
```

If you respond with **Y**, restore processing continues as normal, but the data that you restore might not be the most current.

### Related concepts:

Automated client failover configuration and use

### Related tasks:

Determining the status of replicated client data

**Windows**

## Authorizing another user to restore or retrieve your files

---

You can authorize a user on another node to restore your backup versions or retrieve your archive copies. In this way, you can share files with other people or with other workstations that you use with a different node name.

### About this task

---

You can also authorize other nodes to access the automated system recovery (ASR) file space.

Another node can be used to create the ASR diskette so that the workstation can be recovered using ASR and the backup-archive client. Use the other node if a problem occurs with the workstation and the ASR diskette of the workstation is not available.

To authorize another node to restore or retrieve your files:

### Procedure

---

1. Click **Utilities** → **Node Access List** from the main window.
2. In the **Node Access List** window, click the **Add** button.
3. In the **Add Access Rule** window, select an item in the **Permit Access** field to specify the type of data that the other user can access. You can select either **Backed up Objects** or **Archived Objects**.
4. Type the node name of the user in the **Grant Access to Node** field. Type the node name of the host workstation of the user in the **Grant Access to Node** field.
5. Type the user ID on the host workstation in the **User** field.
6. In the **Filespace and Directory** field, select the file space and the directory that the user can access. You can select one file space and one directory at a time. If you want to give the user access to another file space or directory, you must create another access rule.
7. If you want to limit the user to specific files in the directory, type the name or pattern of the files on the server that the other user can access in the **Filename** field. You can make only one entry in the **Filename** field. It can either be a single file name or a pattern that matches one or more files. You can use a wildcard character as part of the pattern. Your entry must match files that have been stored on the server.
8. If you want to give access to all files that match the file name specification within the selected directory including its subdirectories, click **Include subdirectories**.
9. Click **OK** to save the access rule and close the **Add Access Rule** window.
10. The access rule that you created is displayed in the list box in the **Node Access List** window. When you have finished working with the **Node Access List** window, click **OK**. If you do not want to save your changes, click **Cancel** or close the window.

## Results

---

For example, to give the node user2 access to all backup files and subdirectories under the d:\user1 directory, create a rule with the following values:

```
Permit Access to: Backed up Objects
Grant Access to Node: user2
Filespace and Directory: d:\user1
Filename: *
Include subdirectories: Selected
```

The node you are authorizing must be registered with your IBM Spectrum Protect™ server.

On the command line of the client, use the set access command to authorize another node to restore or retrieve your files. You can also use the query access command to see your current list, and delete access to delete nodes from the list.

### Related reference:

Delete Access  
Query Access  
Set Access

Windows

## Restoring or retrieving files from another client node

---

After users grant you access to their files on the server, you can restore or retrieve those files to your local system.

### About this task

---

You can display file spaces for another user on the server, restore the backup versions of files for another user, or retrieve the archive copies for another user to your local file system, by following these steps:

### Procedure

---

1. Click **Utilities** from the main window.
2. Click **Access Another Node**.
3. Type the node name of the host workstation of the user in the **Node name** field and click **Set**.

## Results

---

If you are using commands, use the fromnode option to indicate the node. You must also use the file space name, rather than the drive letter, to select the restore-retrieve drive that you want to access. Include the file space name in braces and specify it as you

would specify a drive letter. For example, to restore the files from the cougar node \projx directory on the d-disk file space to your own \projx directory, enter:

```
dsmc restore -fromnode=cougar \\cougar\d$\projx\* d:\projx\
```

Use the query filespace command to display a list of file spaces. For example, to display a list of the file spaces of cougar, enter:

```
dsmc query filespace -fromnode=cougar
```

**Important:** The backup-archive client can use file space information when restoring files. The file space information can contain the name of the computer from which the files were backed up. If you restore files from another client node and do not specify a destination for the restored files, the client uses the file space information to restore the files. In this case, the client attempts to restore the files to the drive on the original computer. If the restoring computer has access to the drive of the original computer, you can restore files to the original drive. If the restoring computer cannot access the drive of the original computer, the client returns a network error message. If you want to restore the original directory structure but on a different computer, specify only the target drive when you restore the files. This is true when restoring files from another node and when retrieving files from another node.

**Related reference:**

Fromnode

Restore

Retrieve

Windows

## Restoring or retrieving your files to another workstation

---

When you are using a different workstation, you can restore or retrieve files you backed up from your own workstation.

Your backup versions and archive copies are stored according to your node, not your specific workstation. Your IBM Spectrum Protect™ password protects your data.

To restore or retrieve files to another workstation, use the virtualnodename option to specify the node name of the workstation from which you backed up the files. You can use the virtualnodename option when starting IBM Spectrum Protect or place the option in your client options file, dsm.opt, on the workstation. If you are using a workstation other than your own, use the virtualnodename option with the dsm command. For example, if your node name is cougar, enter:

```
start dsm -virtualnodename=cougar
```

You can then restore or retrieve files as if you were working from your original workstation.

You can also use virtualnodename option on commands. For example, to restore your \projx files to your local c:\myfiles directory, enter:

```
dsmc restore -virtualnodename=cougar \\cougar\d$\projx\*.* c:\myfiles\
```

If you do not want to restore or retrieve the files to the same directory name on the alternate workstation, enter a different destination.

## Restoring or retrieving files to another type of workstation

---

You can restore or retrieve files from one system type to another. This is called *cross-client restore*.

**Restriction:** You must have the appropriate permissions to access the file space of the other workstation.

NTFS and ReFS drives permit file and directory names that are longer than those permitted on FAT drives. If you are recovering files to a FAT drive with long file names, specify a destination file specification for each file.

When you use the Windows client to recover files with long names to an NTFS or ReFS file system, the long names are preserved, even if you are recovering the file to a different type of drive than the source drive.

**Related tasks:**

Authorizing another user to restore or retrieve your files

Restoring or retrieving files from another client node

Windows

## Deleting file spaces

---



If your IBM Spectrum Protect™ administrator grants you authority, you can delete entire file spaces from the server.

## About this task

---

You cannot delete individual backup copies that are kept on the server. When you delete a file space, you delete all the files, both backup copies and archive copies, that are contained within the file space. For example, if you delete the file space for your C drive, you are deleting every backup copy for every file on that disk and every file that you archived from that disk.

Attention: Carefully consider what you are doing before you delete a file space.

You can delete file spaces using the GUI or the command-line client. To delete network-attached storage (NAS) file spaces, use the web client or command-line client.

To delete a file space using the GUI client, perform the following steps:

## Procedure

---

1. From the main window, click **Utilities** → **Delete Filespaces**.
2. Select the file spaces you want to delete.
3. Click **Delete**. The client prompts you for confirmation before deleting the file space.

## Results

---

You can also delete a file space using the delete filesystem command. Use the class option with the delete filesystem command to delete NAS file spaces.

### Related reference:

Class

Delete Filespace



## Restore an image to file

---

When you back up an image, the backup-archive client backs up the first sector of the volume, but when the data is restored, it skips the first sector to preserve the original logical volume control block of the destination volume.

When you restore an image to file, entire volume contents, including the first sector, are restored to the file.

AIX® LVM volumes from original volume groups contain the Logical Volume Control Block (LVCB) on the first sector (512 bytes) of the volume. The LVCB contains volume specific meta-data that should be preserved by applications using the volume.

When you copy the file, containing the image, onto an LVM volume from the original volume group, you need to skip the LVCB from both the file and destination volume. The following dd command can be used for this purpose.

```
dd if=<filename> of=/dev/<vol> bs=512 skip=1 seek=1
```

The dd command sets the block size to 512 bytes, which makes copying very slow. It is better to use `bs=1m` or similar. Here is an alternative way to copy image data:

1. Save the original first sector to a file:

```
dd if=/dev/<vol> of=firstblk.tmp bs=512 count=1
```

2. Copy the restored image:

```
dd if=<filename> of=/dev/<vol> bs=1m
```

3. Restore the original first sector:

```
dd if=firstblk.tmp of=/dev/<vol> bs=512 count=1
```

With the introduction of big and scalable volume group formats on AIX, it is possible that the first sector of the logical volume cannot contain LVCB and is available for the data. If you use big or scalable volume groups on your system, and need to restore the whole volume including the first sector, restore the volume to file and then copy it to a destination volume. The following **dd** command can be used for this purpose.

```
dd if=<filename> of=/dev/<vol> bs=1m
```

**Related concepts:**

Restoring an image using the command line

**Related tasks:**

Restoring an image using the GUI

[AIX](#)[Linux](#)

## Manage GPFS file system data with storage pools

---

With Global Parallel File Systems (GPFS™) technology, you can manage your data using storage pools. A storage pool is a collection of disks or RAIDs with similar properties that are managed together as a group.

The group under which the storage pools are managed together is the file system. The automated placement and management of files on the storage pool level is done by policies. A policy is a set of rules that describes the life cycle of user data, based on the attributes of the file.

When a file is created, the placement policy determines the initial location of the data of the file and assigns the file to a storage pool. All data written to that file is placed in the assigned storage pool. The management policy determines file management operation, such as migration and deletion. The files within a GPFS file system are distributed over different storage pools, depending on the enabled placement and migration policies.

During restore, the files are placed on the correct storage pool. The IBM Spectrum Protect™ server is not aware of pool-to-pool migrations, so the files are placed on the storage pool from where the backup has taken place. The policy engine replaces the files based on migration policies.

If a storage pool ID is stored in the extended attributes of the file, and that storage pool is available, the file is always placed in that storage pool. If the storage pool is not available, the file is placed according to the placement policy. If the placement policy does not match the file, the file is placed in the system pool.

GPFS handles the placement of files after a restore as follows:

- The file is placed in the pool that can be selected by matching the saved file attributes to a RESTORE rule
- The file is placed in the pool that it was in when it was backed up
- The file is placed based on the current placement policy
- The file is placed in the system storage pool

The GPFS RESTORE rule allows you to match files against their saved attributes rather than the current file attributes. If the file attributes do not match, GPFS tries to restore the file in the sequence described above.

For more information about the GPFS RESTORE rule, read the GPFS documentation about policies and rules.

The following restrictions apply:

- The restore of stub files does not work with multiple storage pools, or with files that have ACLs
- Unlink of filesets are not allowed
- The `ctime` option of GPFS should be set to no (default), to prevent unwanted Backup-Archive backups of files after GPFS file migration from pool to pool

For information about using storage pools, see the IBM Spectrum Protect server documentation.

**Related concepts:**

Data storage in storage pools

**Related information:**[AIX](#)[Linux](#)

GPFS product information

[AIX](#)[Linux](#)

mmbackup command: IBM Spectrum Protect requirements

[AIX](#)[Linux](#)

Using IBM Spectrum Protect include and exclude options with IBM Spectrum Scale mmbackup command

## Restoring data to a point in time

---

Use a *point-in-time* restore to restore files to the state that existed at a specific date and time.

### About this task

---

A point-in-time restore can eliminate the effect of data corruption by restoring data from a time prior to known corruption, or recover a basic configuration to a prior condition.

**Mac OS X** | **AIX** | **Linux** | **Solaris** You can perform a point-in-time restore of a file space, directory, or file.

**AIX** | **Linux** | **Solaris** You can also perform a point-in-time restore of image backups.

**Windows** You can perform a point-in-time restore of system state data, a file space, a directory, or a file. You can also perform a point-in-time restore of image backups.

Perform incremental backups to support a point-in-time restore. During an incremental backup, the backup-archive client notifies the server when files are deleted from a client file space or directory. Selective and incremental-by-date backups do not notify the server about deleted files. Run incremental backups at a frequency consistent with possible restore requirements.

If you request a point-in-time restore with a date and time that is before the oldest version maintained by the IBM Spectrum Protect™ server, the object is not restored to your system. Files that were deleted from your workstation before the point-in-time specified are not restored.

Note:

1. Your administrator must define copy group settings that maintain enough inactive versions of a file to guarantee that you can restore that file to a specific date and time. If enough versions are not maintained, the client might not be able to restore all objects to the point-in-time you specify.
2. If you delete a file or directory, the next time you run an incremental backup, the active backup version becomes inactive and the oldest versions that exceed the number specified by the *versions data deleted* attribute of the management class are deleted.

When you perform a point-in-time restore, consider the following information:

- The client restores file versions from the most recent backup before the specified point-in-time date. Ensure the point-in-time that you specify is not the same as the date and time this backup was performed.
- If the date and time you specify for the object you are trying to restore is earlier than the oldest version that exists on the server, the client cannot restore that object.
- Point-in-time restore restores files that were deleted from the client workstation after the point-in-time date but not files that were deleted before this date.
- The client cannot restore a file that was created after the point-in-time date and time. When a point-in-time restore runs, files that were created on the client after the point-in-time date are not deleted.

## Procedure

---

To perform a point-in-time restore by using the client GUI, complete the following steps:

1. Click the Restore button in the main window. The Restore window appears.
2. Click the Point-in-Time button from the Restore window. The Point in Time Restore window appears.
3. Select the Use a Point-in-Time Date selection box. Select the date and time and click OK. The point in time that you specified appears in the Point in Time display field in the Restore window.
4. Display the objects that you want to restore. You can search for an object by name, filter the directory tree, or work with the directories in the directory tree.
5. Click the selection boxes next to the objects you want to restore.
6. Click the Restore button. The Restore Destination window is displayed. Enter the appropriate information.
7. Click the Restore button to start the restore. The Restore Task List window displays the restore processing status.

## Results

---

Note: If there are no backup versions of a directory for the point-in-time you specify, files within that directory are not restorable from the GUI. However, you can restore these files from the command line.

You can start point-in-time restore from the command-line client by using the `pitdate` and `pittime` options with the `query backup` and `restore` commands. For example, when you use the `pitdate` and `pittime` options with the `query backup` command, you establish the point-in-time for which file information is returned. When you use `pitdate` and `pittime` with the `restore` command, the date and time values you specify establish the point-in-time for which files are returned. If you specify `pitdate` without a `pittime` value, `pittime` defaults to 23:59:59. If you specify `pittime` without a `pitdate` value, it is ignored.

### Related concepts:

Storage management policies

**Related reference:**

AIX	Linux	Solaris	Windows	Backup Image
AIX				

## Restore AIX encrypted files

---

When files are backed up in raw format from an AIX® JFS2 Encrypted File System (EFS), you can only restore them to the same or another JFS2 EFS. They cannot be restored to any different file system, or on a different platform.

When EFS files are backed up in clear text, then you can restore them anywhere. If you restore them to a JFS2 EFS, they are automatically re-encrypted only if the directory to which they are restored has the AIX "EFS inheritance" option set.

After restoring a file that was backed up in raw format, you might find that the file cannot be decrypted. The encryption key originally used for the file might no longer be available in the keystore of the user. In this case, you must restore the keystore used at the time of backup.

For information on backing up EFS data, refer to AIX JFS2 encrypted file system backup.

AIX

## Restore AIX® workload partition file systems

---

All the files that are created by the local workload partition (WPAR), and backed up by the backup-archive client that is installed at the global WPAR, can be restored by the client installed at the global WPAR.

Here are some global partition and WPAR configuration examples:

Global partition:

```
system name: shimla
file system: /home /opt
```

WPAR #1 configuration:

```
name: wpar1
file system: /home; name in global WPAR: /wpars/wpar1/home
```

WPAR #2 configuration:

```
name: wpar2
file system: /data; name in global WPAR: /wpars/wpar2/data
```

There are two ways to restore WPAR data, depending on the method used to back up the WPAR data files:

- Restore all WPAR file systems as the file spaces within the global partition. The file space name must be used to identify the WPAR to which it belongs. All of the data is managed on one node using one schedule. Using the example configuration mentioned previously, here is a sample `dsm.sys` file with one server stanza for all file systems, both global and local:

```
SErvername shimla
TCPPort 1500
TCPServeraddress server.example.com
nodename shimla
PasswordAccess generate
Domain /wpars/wpar1/home /wpars/wpar2/data /home /opt
```

Use the following command to restore each file space:

```
dsmc restore /wpars/wpar1/home/*
dsmc restore /wpars/wpar2/data/*
dsmc restore /home/*
dsmc restore /opt/
```

- Restore each WPAR file system from a different node name, if it is backed up under a different node name. Each WPAR must have a separate node name and a scheduler running within the global partition. Also, three scheduler services must be set up, each using a different `dsm.opt` file corresponding to the server stanza name. This method allows each WPAR restore operation to be managed independent of the others. Using the example configuration mentioned previously, here is a sample `dsm.sys` file with three server stanzas: one for `wpar1`, one for `wpar2`, and one for global partition `shimla`:

```

SErvername  shimla_wpar1
TCPPort    1500
TCPSeveraddress  server.example.com
nodename   wpar1
PasswordAccess  generate
Domain     /wpars/wpar1/home

SErvername  shimla_wpar2
TCPPort    1500
TCPSeveraddress  server.example.com
nodename   wpar2
PasswordAccess  generate
Domain     /wpars/wpar2/data

SErvername  shimla
TCPPort    1500
TCPSeveraddress  server.example.com
nodename   shimla
PasswordAccess  generate
Domain     /home /opt

```

Table 1. Sample WPAR restore commands with `dsm.opt` file

In <code>dsm.opt</code> file	Sample restore command
servername shimla_wpar1	dsmc restore /wpars/wpar1/home/*
servername shimla_wpar2	dsmc restore /wpars/wpar2/data/*
servername shimla	dsmc restore /home/* dsmc restore /opt/*

AIX Solaris Windows

## Restore NAS file systems

You restore NAS file system images using the web client or command line interface. The web client interface is available only for connections to the IBM Spectrum Protect Version 8.1.1, V8.1.0, or V7.1.7 or earlier servers.

You can restore full or differential NAS file system images that were backed up previously. If you restore a differential image, IBM Spectrum Protect™ automatically restores the full backup image first, followed by the differential image. It is not necessary for a client node to mount a NAS file system to perform backup or restore operations on that file system.

- AIX Solaris Windows** Restoring NAS file systems using the web client  
This section lists the steps to follow to restore NAS file systems using the web client GUI.
- Windows** Restoring NAS files and directories using the web client  
You can use the `toc` option with the `include.fs.nas` option in your client options file to specify whether the client saves Table of Contents (TOC) information for each file system backup.
- AIX Solaris Windows** Options and commands to restore NAS file systems from the command line  
This topic lists some examples of options and commands you can use to restore NAS file system images from the command line.

### Related concepts:

Web client configuration overview

AIX Solaris Windows

## Restoring NAS file systems using the web client

This section lists the steps to follow to restore NAS file systems using the web client GUI.

### Before you begin

The web client interface is available only for connections to the IBM Spectrum Protect Version 8.1.1, V8.1.0, or V7.1.7 or earlier servers.

## Procedure

---

1. Click the **Restore** button from the main window. The Restore window appears.
2. Expand the directory tree if necessary. To expand a node in the tree, click the plus sign (+) next to an object in the tree. Nodes shown are those that have been backed up and to which your administrator has authority. The root node called **Nodes** is not selectable. This node only appears if a NAS plug-in is present on the client workstation. NAS nodes display on the same level as the node of the client workstation. Only nodes to which the administrator has authority appear.
3. Expand the NAS node to reveal the Image object.
4. Expand the Image object to display volumes that you can restore. You cannot expand Volume objects.
5. Click the selection boxes next to the volumes under the Image object that you want to restore. If you want to restore a NAS image that was backed up on a particular date, click the **Point In Time** button. After you select a date, the last object that was backed up on or prior to that date appears, including any inactive objects. If you want to display all images (including active images and inactive images), before you select them, select **View** → **Display active/inactive files** from the menu bar.
6. Click **Restore**. The Restore Destination window appears. Enter the information in the Restore Destination window. If you choose to restore to a different destination, you can only restore one volume at a time to a different destination. You can restore NAS file system images to any volume on the NAS file server from which they were backed up. You cannot restore images to another NAS file server.
7. Click **Restore**. The NAS Restore **Task List** window displays the restore processing status and progress bar. If there is a number next to the progress bar, it indicates the size of the restore, if known. After the restore completes, the NAS Restore Report window displays processing details. If you must close the web browser session, current NAS operations continue after you disconnect. You can use the **Dismiss** button on the NAS Restore **Task List** window to quit monitoring processes without ending the current operation.
8. (Optional) To monitor processing of an operation, select the Actions > IBM Spectrum Protect™ Activities from the main window.

## Results

---

Considerations:

- Workstation and remote (NAS) backups are mutually exclusive in a Restore window. After selecting an item for restore, the next item you select must be of the same type (either NAS or non NAS).
- Details will not appear in the right-frame of the Restore window for NAS nodes or images. To view information about a NAS image, highlight the NAS image and select View > File Details from the menu.
- To delete NAS file spaces, select Utilities > Delete Filespaces. You can delete both workstation and remote objects.

Windows

## Restoring NAS files and directories using the web client

---

You can use the toc option with the include.fs.nas option in your client options file to specify whether the client saves Table of Contents (TOC) information for each file system backup.

### About this task

---

If you save TOC information, you can use web client to examine the entire file system tree and select files and directories to restore. Creation of a TOC requires that you define the TOCDESTINATION attribute in the backup copy group for the management class to which this backup image is bound. Note that TOC creation requires additional processing, network resources, storage pool space, and possibly a mount point during the backup operation. If you do not save TOC information, you can still restore individual files or directory trees using the RESTORE NODE server command, provided that you know the fully qualified name of each file or directory and the image in which that object was backed up.

To restore NAS files and directories:

## Procedure

---

1. Click Restore from the main window. The Restore window appears.
2. Expand the directory tree if necessary. To expand a node in the tree, click the plus sign (+) next to an object in the tree. Nodes shown are those that have been backed up and to which your administrator has authority. The root node called

- Nodes is not selectable. This node only appears if a NAS plug-in is present on the client workstation. NAS nodes appear on the same level as the node of the client workstation. Only nodes to which the administrator has authority appear.
3. Expand the NAS node to display the File Level object.
  4. Expand the File Level object to display the volumes, directories, and files that were last backed up. When you expand the volume object, and complete TOC information is available on the server for the latest backup, the Load Table of Contents dialog appears. If complete TOC information is not available for the latest backup, no objects appear below the volume object. The next step explains how to display objects from backups other than the latest backup. Complete TOC information is provided if you performed either of the following operations: (1) A differential image backup with TOC information and its corresponding full image backup with TOC information, or (2) A full image backup with TOC information.
  5. Click the selection boxes next to the directories or files that you want to restore.
    - a. If you want to restore files from a NAS image that was backed up on a particular date or display files from several older versions, highlight the volume you want to restore and click the Point In Time button.
    - b. If you select Use a Point in Time Date in the Point in Time Restore windows, files from the image backed up on that date, and if it is a differential image, files from its corresponding full image appear under the File Level object.
    - c. If you click Use Selected Images in the Point in Time Restore window, the Selected Images window appears for you to select images. The contents of the selected images appear in the File Level object.
  6. Click Restore. The Restore Destination window appears. Enter the information in the Restore Destination window. If you choose to restore to a different destination, you can only restore one volume at a time to a different destination.
  7. Click Restore. The NAS Restore Task List window displays the restore processing status and progress bar. If there is a number next to the progress bar, it indicates the size of the restore, if known. After the restore completes, the NAS Restore Report window displays processing details. If you must close the web browser session, current NAS operations continue after you disconnect. You can use the Dismiss button on the NAS Restore Task List window to quit monitoring processes without ending the current operation.
  8. (Optional) To monitor processing of an operation, select the Actions > IBM Spectrum Protect™ Activities from the main window.

## Results

### Considerations:

- Workstation and remote (NAS) backups are mutually exclusive in a Restore window. After selecting an item for restore, the next item you select must be of the same type either (either workstation or NAS).
- To view information about objects in a NAS node, highlight the object and select View > File Details from the menu.
- To delete NAS file spaces, select Utilities > Delete Filespaces. You can delete both workstation and remote objects.

### Related reference:

Toc



## Options and commands to restore NAS file systems from the command line

This topic lists some examples of options and commands you can use to restore NAS file system images from the command line.

Table 1. NAS options and commands

Option or command	Definition	Page
query node	Displays all the nodes for which a particular administrative user ID has authority to perform operations. The administrative user ID should have at least client owner authority over both the NAS node and the client workstation node they are using either from command line or from the web client.	Query Node
query backup	Use the query backup command with the class option to display information about file system images backed up for a NAS file server.	Query Backup
query filesystem	Use the query filesystem command with the <b>class</b> option to display a list of file spaces belonging to a NAS node.	Query Filespace
restore nas	Restores the image of a file system belonging to a Network Attached Storage (NAS) file server.	Restore NAS

Option or command	Definition	Page
<a href="#">AIX</a>   <a href="#">Solaris</a>   <a href="#">Windows</a> monitor process	<a href="#">AIX</a>   <a href="#">Solaris</a>   <a href="#">Windows</a> Displays current backup and restore processes for all NAS nodes for which an administrative user has authority. The administrative user can then select one process to monitor.	<a href="#">AIX</a>   <a href="#">Solaris</a>   <a href="#">Windows</a> Monitor Process
cancel process	Displays current backup and restore processes for all NAS nodes for which an administrative user has authority. From the display, the administrative user can select one process to cancel.	Cancel Process
delete filespace	Use the delete filespace with the class option to display a list of file spaces belonging to a NAS node so that you can choose one to delete.	Delete Filespace

[AIX](#) | [Solaris](#) Regardless of client platform, NAS file system specifications use the forward slash (/) separator, as in this example: /vol/vol10.

[Windows](#) A NAS file system specification uses the following conventions:

[Windows](#)

- Regardless of client platform, NAS file system specifications use the forward slash (/) separator, as in this example:  
/vol/vol10.
- NAS file system designations on the command line require brace delimiters {} around the file system names, such as:  
{/vol/vol10}.

Note: When you initiate a NAS restore operation using the command line client or the web client, the server starts a process to initiate, control, and monitor the operation. It might take several moments before you notice progress at the client command line interface because the server must perform a mount and other necessary tasks before data movement occurs. The IBM Spectrum Protect command line client might display an `Interrupted ...` message when the mount occurs. You can ignore this message.

[Mac OS X](#) | [Mac OS X](#) | [AIX](#) | [Linux](#) | [Solaris](#)

## Restore active or inactive backups

Your administrator determines how many backup versions IBM Spectrum Protect™ maintains for each file on your workstation.

Having multiple versions of a file permits you to restore older versions if the most recent backup is damaged. The most recent backup version is the *active* version. Any other backup version is an *inactive* version.

Every time IBM Spectrum Protect backs up your files, it marks the new backup version as the active backup, and the last active backup becomes an inactive backup. When the maximum number of inactive versions is reached, IBM Spectrum Protect deletes the oldest inactive version.

To restore a backup version that is inactive, you must display both active and inactive versions by clicking on the **View** menu → **Display active/inactive files** item. To display only the active versions (the default), click on the **View** menu → **Display active files only** item. If you try to restore more than one version at a time, only the active version is restored.

On the IBM Spectrum Protect command line, use the inactive option to display both active and inactive objects.

### Related reference:

Inactive

[Mac OS X](#) | [Mac OS X](#) | [AIX](#) | [Linux](#) | [Solaris](#)

## Restoring data using the GUI

This section lists the steps to follow to restore backup versions of individual files or subdirectories.

### Procedure

1. Click **Restore** from the main window. The Restore window appears.
2. Expand the directory tree. Select the selection boxes next to the files or directories you want to restore. To search or filter files, click the **Find** icon on the tool bar.
3. Enter your search criteria in the Find Files (Restore) window.



4. Click the **Search** button. The Matching Files (Restore) window appears.
5. Click the selection boxes next to the files you want to restore and close the Matching Files (Restore) window.
6. Enter your filter criteria in the Find Files (Restore) window.
7. Click the **Filter** button. The Restore window displays the filtered files.
8. Click the selection boxes next to the filtered files or directories you want to restore.
9. To modify specific restore options, click the **Options** button. Any options you change are effective during the current session *only*.
10. Click **Restore**. The Restore Destination window appears. Enter the information in the Restore Destination window.
11. Click **Restore**. The Restore **Task List** window displays the restore processing status.

## Results

Note: On Mac OS X, consider the following items when restoring data using the GUI:

1. When IBM Spectrum Protect™ Tools for Administrators is used to start the client, the client is running with a UID of zero. This means that if you create a folder to restore your files to, that folder is owned by root. To access the files you must change the permissions of the folder. You can change the folder owner from a terminal window using the sudo **chown** command. See your operating system documentation for more information on how to accomplish this.
2. When restoring files with the replace option set to *no*, existing files will not be overwritten, but existing directories are overwritten. To leave existing directories intact during a restore operation, select the **Options** button ⇒ **All selected files and directories** dropdown menu ⇒ **Files only** option.
3. When folders are restored from a UFS or HFSX file system to a HFS file system and they differ only in case, the client restores the contents of both folders to one folder.

Mac OS X | Mac OS X | AIX | Linux | Solaris

## Command line restore examples

This topic lists some examples of restore commands to use for specific tasks.

The following table shows examples of how to use the restore command to restore objects from IBM Spectrum Protect™ server storage.

Table 1. Command-line restore examples

Task	Command	Considerations
Restore the most recent backup version of the /Users/monnett/Documents/h1.doc file, even if the backup is inactive.	<code>dsmc restore /Users/monnett/Documents/h1.doc -latest</code>	If the file you are restoring no longer resides on your workstation, and you have run an incremental backup since deleting the file, there is no active backup of the file on the server. In this case, use the latest option to restore the most recent backup version. IBM Spectrum Protect restores the latest backup version, whether it is active or inactive. See Latest for more information.
Display a list of active and inactive backup versions of files from which you can select versions to restore.	<code>dsmc restore "/Users/monnett/Documents/*"-pick -inactive</code>	If you try to restore both an active and inactive version of a file at the same time, only the active version is restored. See Pick and Inactive for more information.
Restore the /Users/monnett/Documents/h1.doc file to its original directory.	<code>dsmc restore /Users/monnett/Documents/h1.doc</code>	If you do not specify a destination, the files are restored to their original location.
Restore the /Users/monnett/Documents/h1.doc file under a new name and directory.	<code>dsmc restore /Users/monnett/Documents/h1.doc /Users/gordon/Documents/h2.doc</code>	None
Restore the files in the /Users directory and all of its subdirectories.	<code>dsmc restore /Users/ -subdir=yes</code>	When restoring a specific path and file, IBM Spectrum Protect recursively restores <i>all</i> subdirectories under that path, and any instances of the specified file that exist under <i>any</i> of those subdirectories. See Subdir for more information about the <b>subdir</b> option.

Task	Command	Considerations
Restore all files in the /Users/gordon/Documents directory to their state as of 1:00 PM on August 17, 2003.	<code>dsmc restore -pitd=8/17/2003 -pitt=13:00:00 /Users/gordon/Documents/</code>	See Pitdate and Pittime for more information about the pitdate and pittime options.
Restore all files from the /Users/mike/Documents directory that end with .bak to the /Users/mike/projectn/ directory.	<code>dsmc restore "/Users/mike/Documents/*.bak" /Users/mike/projectn/</code>	If the destination is a directory, specify the delimiter (/) as the last character of the destination. If you omit the delimiter and your specified source is a directory or a file spec with a wildcard, you receive an error. If the projectn directory does not exist, it is created.
Restore files specified in the restorelist.txt file to a different location.	<code>dsmc restore -filelist=/Users/user2/Documents/restorelist.txt /Users/NewRestoreLocation/</code>	See Filelist for more information about restoring a list of files.

- Mac OS X AIX Linux Solaris
 Examples: Command line restores for large amounts of data  
 If you need to restore a large number of files, you can get faster performance by using the restore command instead of the GUI. In addition, you can improve performance by entering multiple restore commands at one time.
- Mac OS X AIX Linux Solaris
 Standard query restore, no-query restore, and restartable restore  
 This topic describes the standard (or classic) restore method, the no-query restore method, and the restartable restore method.

#### Related reference:

Restore

Mac OS X Mac OS X AIX Linux Solaris

## Examples: Command line restores for large amounts of data

If you need to restore a large number of files, you can get faster performance by using the restore command instead of the GUI. In addition, you can improve performance by entering multiple restore commands at one time.

For example, to restore all the files in your /home file system, enter:

```
dsmc restore /home/ -subdir=yes -replace=all -tapeprompt=no
```

However, if you enter multiple commands for the directories in the /home file space, you can restore the files faster.

For example, you could enter these commands:

```
dsmc restore /home/monnett/ -subdir=yes -replace=all -tapeprompt=no
dsmc restore /home/gillis/ -subdir=yes -replace=all -tapeprompt=no
dsmc restore /home/stewart/ -subdir=yes -replace=all -tapeprompt=no
```

You can also use the quiet option with the restore commands to save processing time. However, you will not receive informational messages for individual files.

**Note:** If you already have the appropriate values set for the subdir, replace, tapeprompt, and quiet options in your client user-options file, you do not need to include those options in the commands.

When you enter multiple commands to restore your files, you must specify a unique part of the file space in each restore command. Be sure you do not use any overlapping file specifications in the commands.

To display a list of the directories in a file space, use the query backup command. For example:

```
dsmc query backup -dirsonly -subdir=no /Users/
```

As a general rule, you can enter from two to four restore commands at one time. The maximum number you can run at one time without degrading performance depends on factors such as how much memory you have and network utilization.

The speed at which you can restore the files also depends on how many tape drives are available on the server, and whether your administrator is using collocation to keep file spaces assigned to as few volumes as possible.

For example, if `/Users/user1` and `/Users/user2` are on the same tape, the restore for `/Users/user2` must wait until the restore for `/Users/user1` is complete. However, if `/Users/user3` is on a different tape, and there are at least two tape drives available, the restore for `/Users/user3` can begin at the same time as the restore for `/Users/user1`.

Set the system `ulimit` values to unlimited (`-1`) if you are restoring very large (2 GB) files with HSM or the backup-archive client. The client can restore these large files with enough system resources. If the `ulimits` are set to lower values, there might be restore failures.

## Standard query restore, no-query restore, and restartable restore

---

This topic describes the standard (or classic) restore method, the no-query restore method, and the restartable restore method.

- **Mac OS X | AIX | Linux | Solaris** Standard query restore process  
The standard query restore process is also known as classic restore. This topic explains how standard query restore works.
- **Mac OS X | AIX | Linux | Solaris** No-query restore process  
In the no-query restore process, a single restore request is sent to the server instead of querying the server for each object to be restored.
- **Mac OS X | AIX | Linux | Solaris** Restartable restore process  
If the restore process stops because of a power outage or network failure, the server records the point at which this occurred.

## Standard query restore process

---

The standard query restore process is also known as classic restore. This topic explains how standard query restore works.

Here is how standard query restore works:

- The client queries the server for a list of files backed up for the client file space you want to restore.
- The server sends a list of backed up files that match the restore criteria. If you want to restore both active and inactive files, the server sends information about all backed up files to the client.
- The list of files returned from the server is sorted in client memory to determine the file restore order and to minimize tape mounts required to perform the restore.
- The client tells the server to restore file data and directory objects.
- The directories and files you want to restore are sent from the server to the client.

## No-query restore process

---

In the no-query restore process, a single restore request is sent to the server instead of querying the server for each object to be restored.

1. The client tells the server that a no-query restore is going to be completed and provides the server with details about file spaces, directories, and files.
2. The server uses a separate table to track entries which guide the restore.
3. The data to be restored is sent to the client. File and directory objects that are stored on disk are sent immediately since sorting for such data is not required before the object is restored.
4. You can use multiple sessions to restore the data. If the data is on multiple tapes, there are multiple mount points available at the server. The combination of using the `resourceutilization` option and `MAXNUMMP` allows multiple sessions.

**Windows** When you enter an unrestricted wildcard source file specification on the restore command and do not specify any of the options: `inactive`, `latest`, `pick`, `fromdate`, or `todate`, the client uses a *no-query restore* method for restoring files and directories from the server. This method is called no-query restore because instead of querying the server for each object to be restored, a single restore request is sent to the server. In this case, the server returns the files and directories to the client without further action by the client. The client merely accepts the data that comes from the server and restores it to the destination named on the restore command.

**Mac OS X | AIX | Linux | Solaris** When you enter an unrestricted wildcard source file specification on the restore command and do not specify any of the options: `inactive`, `latest`, `pick`, `fromdate`, `todate`, the client uses a *no-query restore* method for restoring files and directories from the server. This method is called no-query restore because instead of querying the server for each object to be restored, a single restore request is sent to the server. In this case, the server returns the files and directories to the client without further action by the client. The client merely accepts the data that comes from the server and restores it to the destination named on the restore command.

**Mac OS X** Using the IBM Spectrum Protect™ GUI client, an example of an unrestricted wildcard command would be to select a folder from the restore tree window. An example of a restricted wildcard command would be to select individual files from a folder.

Using the command-line client, an example of an unrestricted wildcard command would be:

**Mac OS X**  
"/Users/user1/Documents/2004/\*"

**Mac OS X** | **AIX** | **Linux** | **Solaris**  
/home/mydocs/2004/\*

**Windows**  
c:\mydocs\2004\\*

An example of a restricted wildcard file specification would be:

**Mac OS X**  
/Users/user1/Documents/2004/sales.\*

**Mac OS X** | **AIX** | **Linux** | **Solaris**  
/home/mydocs/2004/sales.\*

**Windows**  
c:\mydocs\2004\sales.\*

## Restartable restore process

If the restore process stops because of a power outage or network failure, the server records the point at which this occurred.

This record is known to the client as a *restartable restore*. It is possible to have more than one restartable restore session. Use the query restore command or choose **restartable restores** from the Actions menu to find out if your client has any restartable restore sessions in the server database.

**Windows** You must complete a restartable restore before attempting further backups of the file system. If you attempt to repeat the restore that was interrupted or try to back up the destination file space, the attempt fails because you did not complete the original restore. You can restart the restore at the point of interruption by entering the restart restore command, or you can delete the restartable restore using the cancel restore command. If you restart the interrupted restore, it restarts with the first transaction, which might consist of one or more files, not completely restored when the interruption occurred. Because of this, you might receive some replace prompts for files from the interrupted transaction which were already restored.

**Mac OS X** | **AIX** | **Linux** | **Solaris** You must complete a restartable restore before attempting further backups of the file system. If you attempt to repeat the restore that was interrupted or try to back up the destination file space, the attempt fails because you did not complete the original restore. You can restart the restore at the point of interruption by entering the restart restore command, or you can delete the restartable restore using the cancel restore command.

From the IBM Spectrum Protect™ GUI **Restartable restores** dialog box you can select the interrupted restore and delete it, or you can choose to restart the restore. If you restart the interrupted restore, it restarts with the first transaction, which might consist of one or more files, not completely restored when the interruption occurred. Because of this, you might receive some replace prompts for files from the interrupted transaction which were already restored.

**Mac OS X** | **AIX** | **Linux** | **Solaris** | **Windows** To perform restartable restores using the GUI, follow these steps:

1. Select **Actions** → **Restartable restores** from the main panel.
2. Select the restartable restore session you want to complete.
3. Click the **Restart** button at the bottom of the panel.

### Related reference:

Resourceutilization

Restore

**Solaris**

## Restoring Solaris Zettabyte (ZFS) file systems

Zettabyte File Systems (ZFS) use storage pools to manage physical storage.

How you restore a ZFS file system depends on how it was backed up.

- If you backed up all files and folders as separate objects, you can restore them by performing a file-level restore. For example:

```
dsmc restore /tank/myZFS/ -subdir=yes -replace=all
```

Do not perform a file-level restore operation in a disaster recovery scenario. Even though you successfully restore all system files and folders from a backup-archive client-created backup, the restored system might be unstable or fail.

- If you backed up an entire ZFS snapshot as a single file, you need to restore the snapshot file from the server into a temporary location. For example:

```
dsmc restore /tmpdir/mySnapshotfile
```

You can then restore the file system from the snapshot file by using the Oracle Solaris ZFS commands. For example:

```
zfs receive tank/myZFS@mySnapshot < /tmpdir/mySnapshotFile
```

The advantage of restoring ZFS from a snapshot file is that the full file system can be restored, in a disaster recovery scenario.

For detailed information about restoring data on ZFS file systems, see the product documentation that is available from Oracle. If you are restoring a ZFS root pool, see the topics that describe how to re-create your root pool and recover root pool snapshots.

#### Related tasks:

Backing up Solaris Zettabyte file systems

Mac OS X | AIX | Linux | Solaris

## Additional restore tasks

---

This section discusses some advanced considerations for restoring data.

- **Mac OS X | AIX | Linux | Solaris** Authorizing another user to restore or retrieve your files  
You can authorize another user on the same workstation or a different workstation to restore backup versions or retrieve archive copies of your files.
- **Mac OS X | AIX | Linux | Solaris** Restoring or retrieving files from another client node  
After users grant you access to their files on the server, you can restore or retrieve those files to your local system.
- **Mac OS X | AIX | Linux | Solaris** Restore or retrieve files to another workstation  
From a different workstation, you can restore or retrieve files you have already backed up from your own workstation. You must know the IBM Spectrum Protect password assigned to your node.
- **Mac OS X | AIX | Linux | Solaris** Restoring a disk in case of disk loss  
You can only recover your files if you can run the client. If the disk that contains the client is lost (from theft or hardware failure, for example), you must reinstall the client before you can recover your files. If you also lose the disk that contains the operating system and communication software, you must recover them before you can connect to the IBM Spectrum Protect server.
- **Mac OS X | AIX | Linux | Solaris** Deleting file spaces  
If your IBM Spectrum Protect administrator gives you authority, you can delete entire file spaces from the server.
- **Linux** Enable SELinux to restore files on the Red Hat Enterprise Linux 5 client  
If you are a non-root user, and you are trying to restore files on the Red Hat Enterprise Linux 5 client, you must first enable SELinux.

Mac OS X | Mac OS X | AIX | Linux | Solaris

## Authorizing another user to restore or retrieve your files

---

You can authorize another user on the same workstation or a different workstation to restore backup versions or retrieve archive copies of your files.

### About this task

---

This permits you to share files with other people or with other workstations that you use with a different node name. To authorize a user on another workstation to restore or retrieve your files, the other workstation must be running one of the UNIX clients and must be registered with your server.

**Mac OS X** Note: Mac OS X can *only* restore Mac OS X nodes.

To authorize another user to restore or retrieve your files:

## Procedure

---

1. Click **Utilities** → **Node Access List** from the main window. The Node Access List window appears.
2. Click the **Add** button. The Add Access Rule window appears.
3. In the Add Access Rule window, select an item in the Permit Access to field to specify the type of data that the other user can access. You can select either Backed up Objects or Archived Objects.
4. In the Grant Access to Node field, type the node name of the host workstation of the user that can access your data.
5. In the User field, type the name of the user on a node who can access your data.
6. In the Filespace and Directory field, select the file space and the directory that the user can access. You can select one file space and one directory at a time. If you want to give the user access to another file space or directory, you must create another access rule.
7. If you want to limit the user to specific files in the directory, type the name or pattern of the files on the server that the other user can access in the Filename field. You can make only one entry in the Filename field. It can either be a single file name or a pattern which matches one or more files. You can use a wildcard character as part of the pattern. Your entry must match files that have been stored on the server.
8. For the Java™ GUI: If you want to give access to all files that match the file name specification within the selected directory including its subdirectories, click **Include subdirectories**.
9. Click the **OK** button to save the access rule and close the Add Access Rule window.
10. The access rule that you created is displayed in the list box in the Node Access List window. When you have finished working with the Node Access List window, click the **OK** button. If you do not want to save your changes, click **Cancel** or close the window.

## Results

---

In the client command line interface, use the set access command to authorize another node to restore or retrieve your files. You can also use the query access command to see your current list, and delete access to delete nodes from the list.

### Related reference:

Delete Access

Query Access

Set Access

**Mac OS X** | **AIX** | **Linux** | **Solaris**

## Restoring or retrieving files from another client node

---

After users grant you access to their files on the server, you can restore or retrieve those files to your local system.

### About this task

---

You can display file spaces of another user on the server, restore the backup versions of another user, or retrieve the archive copies of another user to your local file system:

## Procedure

---

1. Click **Utilities** from the main window.
2. Click **Access Another Node**. The Access Another Node window appears.
3. Type the node name of the host workstation of the user in the Node name field. Type the user name in the User name field.
4. Click the **Set** button.

## Results

---

If you are using commands, use the fromnode and fromowner options to indicate the node name and the name of the user who owns the files.

For example, to restore files to one of your own file systems that were backed up from a workstation named `Node1` and owned by a user named `Ann`, enter:

```
dsmc restore -fromn=node1 -fromo=ann "/home/proj/*" /home/gillis/
```

Use the query filespace command to get a list of file spaces. For example, to get a list of file spaces owned by `Ann` on `Node1`, enter:

```
dsmc query filespace -fromn=node1 -fromo=ann
```

**Related reference:**

Fromnode

Query Filespace

Restore

Retrieve

Mac OS X | Mac OS X | AIX | Linux | Solaris

## Restore or retrieve files to another workstation

---

From a different workstation, you can restore or retrieve files you have already backed up from your own workstation. You must know the IBM Spectrum Protect™ password assigned to your node.

To restore or retrieve files to another workstation, use the `virtualnodename` option to specify the node name of the workstation from which you backed up the files. The `virtualnodename` option cannot be set to the hostname of the workstation. You can use the `virtualnodename` option when you start IBM Spectrum Protect or you can add the `virtualnodename` option to your client user options file `dsm.opt`. Use the `virtualnodename` option on the **dsmj** command if you are borrowing the workstation of another user and you do not want to update their client user-options file.

IBM Spectrum Protect prompts you for the password for your original node. After you enter the correct password, all file systems from your original workstation appear in the Restore or Retrieve window. You can restore or retrieve files as if you were working on your own workstation.

**Important:** When you use this method to access files, you have access to all files backed up and archived from your workstation. You are considered a virtual root user.

You can use the `virtualnodename` option in a command. For example, to restore your **projx** files, enter:

```
dsmc restore -virtualnodename=nodeone "/home/monnett/projx/*"
```

If you do not want to restore or retrieve the files to the same directory name on the alternate workstation, enter a different destination.

The considerations for retrieving files are the same as restoring files.

Mac OS X | AIX | Linux | Solaris

## Restoring a disk in case of disk loss

---

You can only recover your files if you can run the client. If the disk that contains the client is lost (from theft or hardware failure, for example), you must reinstall the client before you can recover your files. If you also lose the disk that contains the operating system and communication software, you must recover them before you can connect to the IBM Spectrum Protect™ server.

### About this task

---

To protect yourself against these kinds of losses, you need to put together a set of installation media that you can use to restore your system to a state that lets you contact the server and begin recovering data. The installation media should contain:

### Procedure

---

1. A startable operating system that lets you perform basic functions.
2. A correctly configured communication program that lets you establish communications with the server.
3. A client with appropriate customized options files. You can use the client command line interface to complete this task.

### Results

---

The communication package you use determines what files you need. Consult your operating system and communication software manuals to set up your installation media.

If you also have the IBM Spectrum Protect for Space Management installed on your workstation, your installation media should include the HSM command line client.

Note: Your administrator can schedule restore operations, which can be very useful when you need to restore a large number of files.

**Related concepts:**

AIX	Linux	↳ Backup and restore on space managed file systems		
Mac OS X	Mac OS X	AIX	Linux	Solaris

## Deleting file spaces

---

If your IBM Spectrum Protect™ administrator gives you authority, you can delete entire file spaces from the server.

### About this task

---

When you delete a file space, you delete all the files and images, both backup versions and archive copies, that are contained within the file space. For example, if you delete the file space for your `/home/monnet` file system, you are deleting every backup for every file in that file system and every file you archived from that file system. **Carefully consider whether you want to delete a file space.** You must be an authorized user to perform this task.

You can delete individual backup versions by using the delete backup command.

You can delete file spaces using the backup-archive client GUI or client command line interface. To delete NAS file spaces, use the web client or client command line interface.

To delete a file space using the GUI, perform the following steps:

### Procedure

---

1. Select **Utilities** → **Delete Filespaces** from the main window.
2. Click the selection boxes next to the file spaces you want to delete.
3. Click the **Delete** button. The client prompts you for confirmation before deleting the file space.

### Results

---

You can also delete a file space using the delete filespace command. Use the **class** option with the delete filespace command to delete NAS file spaces.

**Related reference:**

Class  
Delete Backup  
Delete Filespace

Linux

## Enable SELinux to restore files on the Red Hat Enterprise Linux 5 client

---

If you are a non-root user, and you are trying to restore files on the Red Hat Enterprise Linux 5 client, you must first enable SELinux.

If you do not enable SELinux, you will have problems if you restore files that have modified extended attributes.

## Archive and retrieve data with backup-archive clients

---

If you want to save a copy of a file to long-term storage on the IBM Spectrum Protect™ server for archival purposes, use the *archive* function.

### About this task

---



If the original file was ever damaged or lost, use the *retrieve* function to recover the archive copy from the server.

- **Windows** Archive and retrieve your data (Windows)  
You can archive infrequently used files to the IBM Spectrum Protect server and retrieve them when necessary. Archiving and retrieving files is similar to backing up and restoring files.
- **Mac OS X** | **AIX** | **Linux** | **Solaris** Archive and retrieve your data (UNIX and Linux)  
You can archive infrequently used files to the IBM Spectrum Protect server and retrieve them when necessary. Archiving and retrieving files is similar to backing up and restoring files. Many of the windows and concepts are similar.

**Windows**

## Archive and retrieve your data (Windows)

---

You can archive infrequently used files to the IBM Spectrum Protect™ server and retrieve them when necessary. Archiving and retrieving files is similar to backing up and restoring files.

Unless otherwise specified, references to Windows refer to all supported Windows operating systems.

All the primary archive and retrieve procedures also apply to the web client, except for the following functions:

- Preferences editor
- Setup wizard

You can complete the following primary archive and retrieve tasks:

- Archiving data with the GUI
- Archive data examples by using the command line
- Deleting archive data
- Retrieving archives with the GUI
- Retrieve archive copies by using the command line
- **Windows** Archive files  
To archive files, select the files that you want to archive. You can select the files by name or description, or select them from a directory tree.
- **Windows** Retrieve archives  
Select the Retrieve function to recover an archive copy of a file or a directory.

### Related concepts:

When to back up and when to archive files

### Related tasks:

Starting a web client session

**Windows**

## Archive files

---

To archive files, select the files that you want to archive. You can select the files by name or description, or select them from a directory tree.

Your administrator might set up schedules to automatically archive certain files on your workstation. The following sections contain information about how to archive files without using a schedule.

You must assign an archive description for all archived files. An archive description identifies data through a meaningful description that you can use later to identify files and directories. You can enter as many as 254 characters to describe your archived data. If you do not enter a description, the following default archive description is assigned:

```
Archive Date: mm/dd/yyyy
```

where mm/dd/yyyy is the current date.

When you select the archive function from the backup-archive GUI, a list of all previously used archive descriptions are displayed. You can assign these archive descriptions to future archives.

Incremental backup might recall migrated files, while selective backup and archive always recall migrated files, if you do not use the skipmigrated option.

- **Windows** Snapshot backup or archive with open file support  
If open file support has been configured, the backup-archive client runs a snapshot backup or archive of files that are locked (or "in use") by other applications.
- **Windows** Archiving data with the GUI  
You can archive specific files or entire directories from a directory tree. You can also assign a unique description for each group of files you archive (archive package).
- **Windows** Archive data examples by using the command line  
You can archive data when you want to preserve copies of files in their current state, either for later use or for historical or legal purposes.
- **Windows** Archiving data with client node proxy  
Archives of multiple nodes that share storage can be consolidated to a common target node name on the IBM Spectrum Protect server.
- **Windows** Deleting archive data  
You can delete individual archive objects from the IBM Spectrum Protect server, without having to delete the entire file space to which they belong.

**Related concepts:**

**Windows**  Options for backing up migrated files: skipmigrated, checkreparsecontent, stagingdirectory

**Related tasks:**

Setting the client scheduler process to run as a background task and start automatically at startup

**Windows**

## Snapshot backup or archive with open file support

---

If open file support has been configured, the backup-archive client runs a snapshot backup or archive of files that are locked (or "in use") by other applications.

The snapshot allows the archive to be taken from a point-in-time copy that matches the file system at the time the snapshot is taken. Subsequent changes to the file system are not included in the archive. You can set the snapshotproviderfs parameter of the include.fs option to none to specify which drives do not use open file support.

Note:

1. You can use the include.fs option to set snapshot options on a per file system basis.
2. Open file support is only available for local fixed volumes (mounted to either drive letters or volume mount points) formatted with FAT, FAT32, NTFS, or ReFS file systems. This support includes SAN-attached volumes that meet these requirements.
3. If the client is unable to create a snapshot, failover to non-OFS backup occurs; the same backup support that would be done if the OFS feature was not installed.
4. To enable open file support in a cluster environment all workstations in the cluster should have the OFS feature configured.
5. When using the open file support feature with VSS, the client adds the snapshot volume name to the path of the objects being processed. The snapshot volume name can be up to 1024 bytes. The complete path (snapshot volume name plus object path) can be 8192 bytes or less.

For information about open file support restrictions and issues, search for *TSM Client Open File Support (OFS)* at the IBM® support website.

**Related concepts:**

Processing options

**Related tasks:**

Configuring Open File Support

**Windows**

## Archiving data with the GUI

---

You can archive specific files or entire directories from a directory tree. You can also assign a unique description for each group of files you archive (archive package).

### About this task

---

To archive your files, complete the following steps:

## Procedure

1. Click Archive in the GUI main window. The Archive window displays.
2. Expand the directory tree by clicking the plus sign (+) or a folder icon in the tree. To search or filter files, click the Search icon from the toolbar.
3. Enter a description, accept the default description, or select an existing description for your archive package in the Description field.
4. To modify specific archive options, click Options. Any options that you change are effective during the current session only.
5. Click Archive. The Archive Status window displays the progress of the archive operation.

Windows

## Archive data examples by using the command line

You can archive data when you want to preserve copies of files in their current state, either for later use or for historical or legal purposes.

You can archive a single file, a group of files, or all the files in a directory or subdirectory. After you archive a file, you can delete the original file from your workstation. Use the archive command to archive files.

The following table shows examples of how to use the archive command to archive objects.

Table 1. Command-line archive examples

Task	Command	Considerations
Archive all files in the c:\plan\proj1 directory with a file extension of .txt.	<code>dsmc archive c:\plan\proj1\*.txt</code>	Use wildcards to archive more than one file at a time.
Archive all files in the c:\small\testdir directory and delete the files on your workstation.	<code>dsmc archive c:\small\testdir\* -deletefiles</code>	Retrieve the archived files to your workstation whenever you need them again. For more information about the deletefiles option, see Deletefiles.
Archive the c:\proj1\h1.doc file and the c:\proj2\h2.doc file	<code>dsmc archive c:\proj1\h1.doc c:\proj2\h2.doc</code>	You can specify as many files to be archived as the resources and operating system limits permit. Separate the files to be archived with a space. For more information about the filelist option, see Filelist.
Archive a list of files in the c:\filelist.txt file.	<code>dsmc archive -filelist=c:\filelist.txt</code>	Use the filelist option to process a list of files. For more information about the filelist option, see Filelist.
Archive the a:\ch1.doc file and assign a description to the archive.	<code>dsmc archive a:\ch1.doc -description="Chapter 1, first version"</code>	If you do not specify a description with the archive command, the default is Archive Date:x, where x is the current system date. For more information about the description option, see Description.
Archive all the files in the d:\proj directory and its subdirectories.	<code>dsmc archive d:\proj\ -subdir=yes</code>	For more information about the subdir option, see Subdir.
Use the v2archive option with the archive command to archive only files in the c:\relx\dir1 directory.	<code>dsmc archive c:\relx\dir1\ -v2archive</code>	IBM Spectrum Protect™ archives only files in the c:\relx\dir1 directory. Directories that exist in the path are not processed. For more information about the v2archive option, see V2archive.
Use the archmc option with the archive command to specify the available management class for the policy domain to which you want to bind your archived files.	<code>dsmc archive -archmc=RET2YRS c:\plan \proj1\ budget.jan\*</code>	For more information about the archmc option, see Archmc. For more information about management classes, see Storage management policies .

Task	Command	Considerations
Assume that you initiated a snapshot of the C:\ drive and mounted the snapshot as the logical volume \\florence\c\$\snapshots\snapshot.0. You archive the c:\dir1\sub1 directory tree from the local snapshot and manage it on the IBM Spectrum Protect server under the file space name C:\.	<pre>dsmc archive c:\dir1\sub1\* -subdir=yes -snapshotroot=\\ florence\c\$\snapshots\snapshot.0</pre>	For more information, see Snapshotroot.

- Windows Associate a local snapshot with a server file space (Windows)
  - You can associate the data on the local snapshot with the real file space data that is stored on the IBM Spectrum Protect server.

**Related reference:**

Archive

Windows

## Archiving data with client node proxy

---

Archives of multiple nodes that share storage can be consolidated to a common target node name on the IBM Spectrum Protect™ server.

### About this task

---

This is useful when the workstation responsible for performing the archive can change over time, such as with a cluster. The asnodename option also allows data to be restored from a different system than the one that performed the backup. Use the asnodename option with the appropriate command to back up, archive, restore, and retrieve data under the target node name on the IBM Spectrum Protect server.

Tivoli® Storage Manager FastBack clients are also backed up using client node proxy.

To enable this option, follow these steps:

1. Install the backup-archive client on all nodes in a shared data environment.
2. Register each node with the IBM Spectrum Protect server, if it does not exist. Register the common target node name to be shared by each of the agent nodes used in your shared data environment.
3. Register each of the nodes in the shared data environment with the IBM Spectrum Protect server. This is the agent node name that is used for authentication purposes. Data is not stored using the node name when the asnodename option is used.
4. The IBM Spectrum Protect administrator must grant proxy authority to all nodes in the shared environment to access the target node name on the IBM Spectrum Protect server, using the GRANT PROXYNODE server command.
5. Use the QUERY PROXYNODE administrative client command to display the client nodes of the authorized user, granted by the GRANT PROXYNODE command.

Follow these steps to set up encryption with the encryptkey=save option:

### Procedure

---

1. Specify encryptkey=save in the options file.
2. Back up at least one file with asnode=ProxyNodeName to create a local encryption key on each agent node in the multiple node environment.

### Results

---

Follow these steps to set up encryption with the encryptkey=prompt option:

1. Specify encryptkey=prompt in the options file.
  2. Ensure that users of the agent nodes in the multiple node environment are using the same encryption key.
- If you change the encryption key, you must repeat the previous steps.

- Use the same encryption key for all files backed up in the shared node environment.

Follow these steps to enable multinode operation from the GUI:

1. Verify that the client node has proxy authority to a target node (or authorized to act as the target node) using the QUERY PROXYNODE administrative client command.
2. Select Edit > Preferences to open the preferences window.
3. Select the General tab and fill in the As Node Name field with the name of the proxy authorized target node.
4. Click Apply and then OK to close the preferences window.

Follow these steps to verify that your client node is now accessing the server as the target node:

1. Open the tree window and check that the target node name specified by the As Node Name field appears, or
2. Verify the target node name in the Accessing As Node field in the Connection Information window.

To return to single node operation, delete the As Node Name from the Accessing As Node field in the General > Preferences tab.

#### Considerations for a proxied session:

- A proxy operation uses the settings for the target node (such as maxnummp and deduplication) and schedules that are defined on the IBM Spectrum Protect server. The IBM Spectrum Protect server node settings and schedules for the agent node are ignored.
- All agent nodes in the multiple node environment must be of the same platform type.
- Do not use target nodes as traditional nodes. Use them only for multiple node processing.
- You cannot perform a system object or system state backup or restore.
- You cannot access another node (either from GUI drop down or use of the fromnode option).
- You cannot use the clusternode option.
- You cannot perform NAS backup or restore.

#### Related reference:

Asnodename

Session settings and schedules for a proxy operation

Windows

## Deleting archive data

---

You can delete individual archive objects from the IBM Spectrum Protect™ server, without having to delete the entire file space to which they belong.

### Before you begin

---

Your IBM Spectrum Protect administrator must grant you the authority to delete archived objects. To determine whether you have this authority, select File > Connection Information from the backup-archive client GUI or from the main menu in the web client. Your archive delete authority status is listed in the `Delete Archive Files` field. If this field shows `No`, you cannot delete archived objects unless your administrator grants you the authority to delete them.

### Procedure

---

To delete an archived object from the server, perform the following steps in the web client or GUI. As an alternative to using the web client or GUI, you can also delete archived objects from the command line by using the delete archive command.

1. Select Delete Archive Data from the Utilities menu.
2. In the Archive Delete window, expand the directory tree by clicking the plus sign (+) or folder icon next to the object you want to expand. Objects on the tree are grouped by archive package description.
3. Select the archived objects that you want to delete.
4. Click Delete. The client prompts you for confirmation before it starts to delete the selected objects. The Archive Delete Task List window shows the progress of the delete operation.

#### Related reference:

Delete Archive

Windows

## Retrieve archives

---

Select the Retrieve function to recover an archive copy of a file or a directory.

Note: When you retrieve a directory, its modification date and time is set to the date and time of the retrieve, not to the date and time the directory had when it was archived. This is because a retrieve operation retrieves the directories first, and then adds the files to the directories.

You can also retrieve archive copies from the directory tree, filter the directory tree, and retrieve archive copies of files owned by someone else. To do any of these, click the Retrieve button on the main window of the backup-archive client GUI and follow the directions provided in the task help of the GUI.

Important: When you retrieve a file without any specifications, and more than one version of the archive copy exists on the server, all of the copies are retrieved. After the first copy is retrieved, the second copy is retrieved. If there is an existing copy on your client workstation, you are prompted to replace, skip, or cancel.

- **Windows** Retrieving archives with the GUI  
You can retrieve your archived files with the backup-archive client GUI.
- **Windows** Retrieve archive copies by using the command line  
You retrieve a file when you want to return an archive copy from the server to your workstation. Some examples of how to retrieve archived files by using the command line are shown.

**Related concepts:**

Duplicate file names

**Windows**

## Retrieving archives with the GUI

---

You can retrieve your archived files with the backup-archive client GUI.

### Procedure

---

1. Click Retrieve on the GUI main window. The Retrieve window displays.
2. Expand the directory tree by clicking the plus sign (+) or the folder icon next to an object you want to expand. To search or filter files, click the Search icon from the toolbar.
3. Enter your search criteria in the Find Files window.
4. Click Search. The Matching Files window displays.
5. Click the selection boxes of the files that you want to retrieve and close the Matching Files window.
6. Enter your filter criteria in the Find Files window.
7. Click Filter. The Retrieve window displays the filtered files.
8. Click the selection boxes of the filtered files or directories that you want to retrieve.
9. To modify specific retrieve options, click Options. Any options that you change are effective during the current session only.
10. Click Retrieve. The Retrieve Destination window displays. You can retrieve files to a directory or drive other than the one from where they were originally archived. You can also select how much of the parent directory structure is re-created at the retrieve location.
11. Click Retrieve. The Retrieve Status window displays the processing status.

**Windows**

## Retrieve archive copies by using the command line

---

You retrieve a file when you want to return an archive copy from the server to your workstation. Some examples of how to retrieve archived files by using the command line are shown.

You can retrieve a single file, a group of files, or all the files in a directory or subdirectory. When you retrieve a file, the IBM Spectrum Protect™ server sends you a copy of that file. The archived file remains in storage.

Use the retrieve command to retrieve files. The following table shows examples of using the retrieve command.

Table 1. Command line examples of retrieving archives

Task	Command	Considerations
Retrieve the c:\doc\h2.doc file to its original directory.	<code>dsmc retrieve c:\doc\h2.doc</code>	If you do not specify a destination, the files are retrieved to their original location.

Task	Command	Considerations
Retrieve the c:\doc\h2.doc file under a new name and directory.	<pre>dsmc retrieve c:\doc\h2.doc c:\proj2\h3.doc</pre>	None
Retrieve all files that are archived with a specific description to a directory named retr1 at a new location	<pre>dsmc retrieve c:\* d:\retr1\ -sub=yes - desc="My first archive"</pre>	None
Retrieve all files from the c:\projecta directory that end with the characters .bak to the c:\projectn directory.	<pre>dsmc retrieve c:\projecta\*.bak c:\projectn</pre>	None
Use the pick option display a list of archives from which you can select files to retrieve.	<pre>dsmc retrieve c:\project\* -pick</pre>	For more information about the pick option, see Pick.
Retrieve a file that is originally archived from the diskette that is labeled <i>workathome</i> on the a: drive, to a diskette in the a: drive labeled <i>extra</i> .	<pre>dsmc retrieve {workathome}\doc\h2.doc c a:\doc\h2.doc</pre>	If you are retrieving a file to a disk that has a different label other than the disk from which the file was archived, use the file space name (label) of the archive disk rather than the drive letter.
Retrieve the c:\doc\h2.doc file to its original directory on the workstation, named <i>star</i> .	<pre>dsmc retrieve c:\doc\h2.doc \\star\c\$\</pre> <p>To retrieve the file to <i>star</i>, which was renamed <i>meteor</i>, enter:</p> <pre>dsmc retrieve \\star\c\$\ doc\h2.doc \\meteor\c\$\</pre> <p>You can also enter:</p> <pre>dsmc retrieve \\star\c\$\ doc\h2.doc c:\</pre> <p>This example is valid because if the workstation name is not included in the specification, the local workstation is assumed (<i>meteor</i>, in this case).</p>	For the purposes of this manual, the workstation name is part of the file name. Therefore, if you archive files on one workstation and you want to retrieve them to another workstation, you must specify a destination. This requirement is true even if you are retrieving to the same physical workstation, but the workstation has a new name.

**Related reference:**

Retrieve



## Archive and retrieve your data (UNIX and Linux)

You can archive infrequently used files to the IBM Spectrum Protect™ server and retrieve them when necessary. Archiving and retrieving files is similar to backing up and restoring files. Many of the windows and concepts are similar.

All the primary archive and retrieve procedures in this topic also apply to the web client, except for the Preferences editor procedures.

You can complete the following primary archive and retrieve tasks:

- Archiving data with the GUI
- Archive data examples by using the command line
- Deleting archive data
- Retrieving data with the GUI
- Retrieve data examples by using the command line

- **Mac OS X | AIX | Linux | Solaris** Archive files

To archive files, you must specifically select the files to archive. You can select the files by using a file specification or by selecting them from a directory tree.

- **Mac OS X | AIX | Linux | Solaris** Retrieve archives

Retrieve a file when you want to return an archive copy from the server to your workstation.

**Related concepts:**

Backing up your data

**Related tasks:**

Starting a web client session

**Mac OS X | AIX | Linux | Solaris**

## Archive files

---

To archive files, you must specifically select the files to archive. You can select the files by using a file specification or by selecting them from a directory tree.

Your administrator might set up schedules to archive certain files on your workstation automatically. The following sections cover how to archive files without using a schedule.

- **Mac OS X | AIX | Linux | Solaris** Archiving data with the GUI

You can archive a file or a group of files by using file names. You can select files that match your search criteria by using a directory tree.

- **Mac OS X | AIX | Linux | Solaris** Archive data examples by using the command line

You request archive services when you want to preserve copies of files in their current state, either for later use or for historical or legal purposes. Examples of archiving data by using the command line are shown.

- **Mac OS X | AIX | Linux | Solaris** Archiving data with client node proxy

Archives of multiple nodes that share storage can be consolidated to a common target node name on the IBM Spectrum Protect server.

- **Mac OS X | AIX | Linux | Solaris** Deleting archive data

You can delete individual archive objects from the IBM Spectrum Protect server, without having to delete the entire file space to which they belong.

- **Mac OS X | AIX | Linux | Solaris** Advanced archive tasks

Access permissions, symbolic links, and hard links are advanced functions to consider when you archive data.

**Related tasks:**

Setting the client scheduler process to run as a background task and start automatically at startup

**Mac OS X | AIX | Linux | Solaris**

## Archiving data with the GUI

---

You can archive a file or a group of files by using file names. You can select files that match your search criteria by using a directory tree.

### Procedure

---

Archive files with the following procedure.

1. Click Archive from the main window.
2. In the Archive window, expand the directory tree by clicking the plus sign (+) or the folder icon next to an object in the tree. To search or filter files, click the Search icon from the toolbar.
3. Enter your search criteria in the Find Files window.
4. Click Search.
5. In the Matching Files window, click the selection boxes next to the files you want to archive and close the Matching Files window.
6. Enter your filter criteria in the Find Files window.



7. Click Filter. The Archive window displays the filtered files.
8. Click the selection boxes next to the filtered files or directories that you want to archive.
9. Enter the description, accept the default description, or select an existing description for your archive package in the Description box. The maximum length of a description is 254 characters. When an existing archive description is used, the files or directories that are selected are added to the archive package. All archived packages with the same description are grouped for retrieves, queries, and deletions.
10. To modify specific archive options, click Options. Any options that you change are effective during the current session only.
11. Click Archive. The archive Task List window displays the archive processing status.

Mac OS X | AIX | Linux | Solaris

## Archive data examples by using the command line

You request archive services when you want to preserve copies of files in their current state, either for later use or for historical or legal purposes. Examples of archiving data by using the command line are shown.

You can archive a single file, a group of files, or all the files in a directory or subdirectory. After you archive a file, you can choose to delete the original file from your workstation.

The following table shows examples of using the archive command to archive objects.

Table 1. Command line archive examples

Task	Command	Considerations
Archive all files in the <code>/home/proj1</code> directory with a file extension of <code>.txt</code> .	<code>dsmc archive "/home/proj1/*.*.txt"</code>	Use wildcards to archive more than one file at a time.
Archive all files in the <code>/home/jones/proj/</code> directory and delete the files on your workstation.	<code>dsmc archive /home/jones/proj/ -deletfiles</code>	Retrieve the archived files to your workstation whenever you need them again. For more information about the <code>deletfiles</code> option, see <a href="#">Deletfiles</a> .
Archive the <code>/home/jones/h1.doc</code> and <code>/home/jones/test.doc</code> files.	<code>dsmc archive /home/jones/h1.doc /home/jones/test.doc</code>	If you specify the <code>removeoperandlimit</code> option with the archive command, the 20-operand limit is not enforced and is restricted only by available resources or other operating system limits. With this option, you can specify more than 20 files on a single command. For more information about this option, see <a href="#">Removeoperandlimit</a> .
Archive a list of files in the <code>/home/avi/filelist.txt</code> file.	<code>dsmc archive -filelist=/home/avi/filelist.txt</code>	Use the <code>filelist</code> option to process a list of files. For more information, see <a href="#">Filelist</a> .
Archive the <code>/home/jones/ch1.doc</code> file and assign a description to the archive.	<code>dsmc archive /home/jones/ch1.doc -description="Chapter 1, first version"</code>	If you do not specify a description with the archive command, the default is <code>Archive Date:x</code> , where <code>x</code> is the current system date. For more information about the description option, see <a href="#">Description</a> .
Archive all of the files in the <code>/home/jones/proj/</code> directory and its subdirectories.	<code>dsmc archive /home/jones/proj/ -subdir=yes</code>	For more information about the <code>subdir</code> option, see <a href="#">Subdir</a> .
Use the <code>v2archive</code> option with the archive command to archive only files in the <code>/home/relx/dir1</code> directory, but not the <code>relx</code> or <code>dir1</code> directories.	<code>dsmc archive "/home/relx/dir1/" -v2archive</code>	The backup-archive client archives only files in the <code>/home/relx/dir1</code> directory. Directories that exist in the path are not processed. For more information about the <code>v2archive</code> option, see <a href="#">V2archive</a> .
Use the <code>archmc</code> option with the archive command to specify the available management class for your policy domain to which you want to bind your archived files.	<code>dsmc archive -archmc=ret2yrs /home/plan/proj1/budget.jan</code>	For more information about the <code>archmc</code> option, see <a href="#">Archmc</a> . For more information about management classes, see <a href="#">Storage management policies</a> .

Task	Command	Considerations
Assume that you initiated a snapshot of the /usr file system and mounted the snapshot as /snapshot/day1. You archive the /usr/dir1/sub1 directory tree from the local snapshot and manage it on the IBM Spectrum Protect™ server under the file space name /usr.	<pre>dsmc archive /usr/dir1/sub1/ - subdir=yes - snapshotroot =/snapshot/day1</pre>	The client considers the snapshotroot value as a file space name. For more information, see Snapshotroot.

- Mac OS X AIX Linux Solaris Associate a local snapshot with a server file space  
 To associate data on the local snapshot with the real file space data that is stored on the IBM Spectrum Protect server, use the snapshotroot option.

**Related reference:**

Archive

Mac OS X AIX Linux Solaris

## Archiving data with client node proxy

Archives of multiple nodes that share storage can be consolidated to a common target node name on the IBM Spectrum Protect™ server.

### Before you begin

All agent nodes in the multiple node environment should be of the same platform type. Do not use target nodes as traditional nodes. Use them only for multiple node processing.

Consider the following features of a proxied session:

- A proxy operation uses the settings for the target node (such as maxnummp and deduplication) and schedules that are defined on the IBM Spectrum Protect server. The IBM Spectrum Protect server node settings and schedules for the agent node are ignored.
- You cannot perform a system state or system services backup or restore.
- You cannot access another node (either from the GUI drop down or use of the fromnode option).
- You cannot perform a NAS backup or restore.

### About this task

Consolidating archived files to a common target node name on the server is useful when the workstation responsible for performing the archive can change over time, such as with a Xsan or cluster. The asnodename option also allows data to be restored from a different system than the one which performed the backup. Use the asnodename option with the appropriate command to back up, archive, restore, and retrieve data under the target node name on the IBM Spectrum Protect server. This support is only available with IBM Spectrum Protect V5.3 and higher.

Linux Tivoli® Storage Manager FastBack clients are also backed up using client node proxy.

Configuring your environment for proxied operations is a multiple step procedure that involves setting options and commands on the backup-archive client and on the server.

### Procedure

Perform steps 1 through 5 to install the client and grant proxy authority to the nodes that can perform archive procedures on behalf of another node.

1. Install the backup-archive client on all nodes in a shared data environment.
2. Register each node with the IBM Spectrum Protect server, if it does not exist. Register the common target node name to be shared by each of the agent nodes used in your shared data environment.
3. Register each of the nodes in the shared data environment with the IBM Spectrum Protect server. This is the agent node name that is used for authentication purposes. Data is not stored using the node name when the asnodename option is used.
4. Grant proxy authority to all nodes in the shared environment to access the target node name on the IBM Spectrum Protect server, using the GRANT PROXYNODE command (IBM Spectrum Protect administrator).

5. Use the QUERY PROXYNODE administrative client command to display the client nodes of the authorized user, granted by the GRANT PROXYNODE command.

Step 6 sets ensures that archived files are encrypted on the server.

6. Set the encryptkey option in the options file.

Specify encryptkey=save in the options file to save the encryption key in the IBM Spectrum Protect password file. Back up at least one file with asnode=ProxyNodeName to create a local encryption key on each agent node in the multiple node environment.

Specify encryptkey=prompt in the options file if you want the node users to manage the encryption key. Ensure that users of the agent nodes in the multiple node environment are using the same encryption key.

Repeat this step if you change the encryption key. Use the same encryption key for all files that are backed up, in the shared environment.

Perform steps 7 to step 10 to enable multinode operation, from the GUI.

7. Verify that the client node has proxy authority to a target node (or authorized to act as the target node) using the QUERY PROXYNODE administrative client command.
8. Select Edit > Preferences to open the preferences window.
9. Select the General tab and fill in the As Node Name field with the name of the proxy authorized target node.
10. Click Apply and then OK to close the preferences window.

Perform step 11 to verify that your client node is now accessing the server as the target node.

11. Open the tree window and verify that the target node name specified by the As Node Name field is displayed. Alternatively, you can verify that the target node name shows in the Accessing As Node field in the Connection Information window.
12. Optional: To return to single node operation, delete the As Node Name from the Accessing As Node field in the General > Preferences tab.

**Related reference:**

Asnodename

Session settings and schedules for a proxy operation

Mac OS X | AIX | Linux | Solaris

## Deleting archive data

---

You can delete individual archive objects from the IBM Spectrum Protect™ server, without having to delete the entire file space to which they belong.

### Before you begin

---

Your IBM Spectrum Protect administrator must grant you the authority to delete archived objects. To determine whether you have this authority, select File > Connection Information from the backup-archive client GUI or from the main menu in the web client. Your archive delete authority status is listed in the `Delete Archive Files` field. If this field shows `No`, you cannot delete archived objects unless your administrator grants you the authority to delete them.

### Procedure

---

To delete an archived object from the server, perform the following steps in the web client or GUI. As an alternative to using the web client or GUI, you can also delete archived objects from the command line by using the delete archive command.

1. Select Delete Archive Data from the Utilities menu.
2. In the Archive Delete window, expand the directory tree by clicking the plus sign (+) or folder icon next to the object you want to expand. Objects on the tree are grouped by archive package description.
3. Select the archived objects that you want to delete.
4. Click Delete. The client prompts you for confirmation before it starts to delete the selected objects. The Archive Delete Task List window shows the progress of the delete operation.

**Related reference:**

Delete Archive

Mac OS X | AIX | Linux | Solaris

## Advanced archive tasks

Access permissions, symbolic links, and hard links are advanced functions to consider when you archive data.

- **Mac OS X | AIX | Linux | Solaris** Access permissions  
When you archive a file, the client saves standard UNIX access permissions that are assigned to the file.
- **Mac OS X | AIX | Linux | Solaris** Archive and retrieve symbolic links  
The backup-archive client archives and retrieves symbolic links differently than it does regular files and directories.
- **Mac OS X | AIX | Linux | Solaris** Hard links  
When you archive files that are hard-linked, the backup-archive client archives each instance of the linked file.

**Mac OS X | AIX | Linux | Solaris**

## Access permissions

When you archive a file, the client saves standard UNIX access permissions that are assigned to the file.

Depending on your operating system, it also saves extended permissions. For example, for files on an AIX® workstation, the client saves access control lists.

If you are a user, and you archive a file to which you have read access, you own the archived copy of the file. You are the only user who can retrieve the archived file unless you grant access to another user.

**Mac OS X | AIX | Linux | Solaris**

## Archive and retrieve symbolic links

The backup-archive client archives and retrieves symbolic links differently than it does regular files and directories.

The way that the client archives and retrieves symbolic links depends on options settings, whether the target directory is accessible, and the way you specify objects.

A *UNIX symbolic link* is a file that contains a pointer to another file or directory. The object the symbolic link points to is called the *target object*.

A symbolic link can be backed up as path information to a target directory, or it can be backed up as a directory. If the symbolic link is backed up as a directory, the files and folders in the target directory can also be backed up.

What you restore depends on how the symbolic link was backed up, the scope of the restore, the setting of the `followsymbolic` option, and whether the target directory is accessible at the time of restore.

For more information on how symbolic links are handled during archive, see the `archsymblinksasfile` option.

Note: Symbolic link processing as described here does not apply to Mac OS X. Symbolic links are always archived as files and are never followed.

The following table shows symbolic link archive and retrieve functions and the action taken:

Table 1. Symbolic link management table for archive and retrieve

Function	Action taken
Archive of a file link.	Archives the file to which the symbolic link points.
Archive of a directory link.	Archives the directory and its contents.
Archive of a file with <code>subdir=yes</code> .	Archives the file, directory path and all like-named files in the subtree.
Archive of a directory with <code>subdir=yes</code> .	Archives the directory, its contents, and contents of subdirectories.
Archive of a symbolic link that points to a file or directory that does not exist.	Archives the symbolic link.
Retrieve a symbolic link that points to file; the file and link exist.	Replaces the file if <code>replace=y</code> is set.

Function	Action taken
Retrieve a symbolic link that points to file; the symbolic link no longer exists.	Retrieves the file replacing the file name with the symbolic link name and places it in the directory where the symbolic link resided.
Retrieve a symbolic link that points to a directory; the symbolic link and directory no longer exist.	A directory is created in the directory where the symbolic link resides, and all files and subdirectories are restored to that directory. The symbolic link name is used as the new directory name.
Retrieve a symbolic link that points to a directory; the symbolic link and directory still exist.	The directory is not retrieved as long as the symbolic link exists.

**Related reference:**

AIX	Linux	Solaris	Archsymlinkasfile
Mac OS X	AIX	Linux	Solaris

## Hard links

When you archive files that are hard-linked, the backup-archive client archives each instance of the linked file.

For example, if you archive two files that are hard-linked, the client archives the file data twice.

When you retrieve hard-linked files, the client reestablishes the links. For example, if you had a hard-linked pair of files, and only one of the hard-linked files is on your workstation, when you retrieve both files, they are hard-linked. The only exception to this procedure occurs if you archive two files that are hard-linked and then break the connection between them on your workstation. If you retrieve the two files from the server, the client respects the current file system and does not retrieve the hard link.

Tip: If you do not archive and retrieve all files that are hard-linked at the same time, problems can occur. To ensure that hard-linked files remain synchronized, archive all hard links at the same time and retrieve those same files together.

Mac OS X	AIX	Linux	Solaris
----------	-----	-------	---------

## Retrieve archives

Retrieve a file when you want to return an archive copy from the server to your workstation.

Many of the advanced considerations for retrieving files are the same as for restoring files.

Important: When you retrieve a file without any specifications, and more than one version of the archive copy exists on the server, the client retrieves all of the copies. After the first copy is retrieved, the second copy is retrieved. If there is an existing copy on your client workstation, you are prompted to replace, skip, or cancel.

- |          |     |       |         |
|----------|-----|-------|---------|
| Mac OS X | AIX | Linux | Solaris |
|----------|-----|-------|---------|

 Retrieving data with the GUI  
 You can retrieve an archived file with the GUI.
- |          |     |       |         |
|----------|-----|-------|---------|
| Mac OS X | AIX | Linux | Solaris |
|----------|-----|-------|---------|

 Retrieve data examples by using the command line  
 You can retrieve a single file, a group of files, or all the files in a directory or subdirectory.
- |          |     |       |         |
|----------|-----|-------|---------|
| Mac OS X | AIX | Linux | Solaris |
|----------|-----|-------|---------|

 Archive management classes  
 The backup-archive client checks the include options in your include-exclude options list to determine which management class to assign to your archived files.

**Related concepts:**

Restore or retrieve files to another workstation

**Related tasks:**

Authorizing another user to restore or retrieve your files

Restoring or retrieving files from another client node

Mac OS X	AIX	Linux	Solaris
----------	-----	-------	---------

## Retrieving data with the GUI

You can retrieve an archived file with the GUI.

### Procedure

1. Click Retrieve from the client Java™ GUI main window. The Retrieve window displays.
2. Expand the directory tree by clicking the plus sign (+) or the folder icon next to an object that you want to expand. To search or filter files, click the Search icon from the toolbar.
3. Enter your search criteria in the Find Files window.
4. Click Search. The Matching Files window displays.
5. Click the selection boxes next to the files that you want to retrieve and close the Matching Files window.
6. Enter your filter criteria in the Find Files window.
7. Click Filter. The Retrieve window displays the filtered files.
8. Click the selection boxes of the filtered files or directories that you want to retrieve.
9. To modify specific retrieve options, click Options. Any options that you change are effective during the current session only.
10. Click Retrieve. The Retrieve Destination window displays. Enter the appropriate information in the Retrieve Destination window.
11. Click Retrieve. The Task List window displays the retrieve processing status.

Mac OS X   AIX   Linux   Solaris

## Retrieve data examples by using the command line

You can retrieve a single file, a group of files, or all the files in a directory or subdirectory.

When you retrieve a file, a copy of that file is sent from the IBM Spectrum Protect™ server. The archived file remains in storage.

Use the retrieve command to retrieve files from storage to your workstation. The following table shows examples of using the retrieve command.

Table 1. Command line examples of retrieving archives

Task	Command	Considerations
Retrieve the <code>/home/jones/h1.doc</code> file to its original directory.	<code>dsmc retrieve /home/jones/h1.doc</code>	If you do not specify a destination, the files are retrieved to their original location.
Retrieve the <code>/home/jones/h1.doc</code> file with a new name and directory.	<code>dsmc retrieve /home/jones/h1.doc /home/smith/h2.doc</code>	None.
Retrieve all files from the <code>/home/jones</code> directory that end with the characters <code>.bak</code> to the <code>/home/smith</code> directory.	<code>dsmc retrieve "/home/jones/*.bak" /home/smith/</code>	None.
Retrieve the <code>/home/jones/ch1.doc</code> file and assign a description.	<code>dsmc retrieve /home/jones/ch1.doc -description="Chapter 1, first version"</code>	If you do not specify a description with the retrieve command, the default is <code>Retrieve Date:x</code> , where <code>x</code> is the current system date.
Use the pick option to display a list of archives from which you can select files to retrieve.	<code>dsmc retrieve "/home/jones/*" -pick</code>	None.
Retrieve a list of files that are specified in the <code>retrievelist.txt</code> file to their original directory.	<code>dsmc retrieve -filelist=/home/dir2/retrievelist.txt</code>	None.

### Related reference:

Retrieve  
Description  
Filelist  
Pick

Mac OS X   AIX   Linux   Solaris

## Archive management classes

The backup-archive client checks the include options in your include-exclude options list to determine which management class to assign to your archived files.

If you do not assign a management class to a file with the include option, the client assigns the default management class to the file. The client can archive only a file if the selected management class contains an archive copy group.

You can override the default management class by using the `archmc` option, or by clicking Options in the Archive window in the GUI, clicking Override include/exclude list, and then selecting the management class.

You can also add include-exclude statements in the backup-archive client Java™ GUI or web client directory tree. Then, you can use the Utilities Preview Include-Exclude function to preview the include-exclude list before you send data to the server.

**Related concepts:**

Assign a management class to files

Display information about management classes and copy groups

**Related reference:**

Preview Archive

Preview Backup

## Schedule operations for backup-archive clients

---

You can schedule backup operations that protect client data to ensure that the operations run on a regular basis.

### About this task

---

The client scheduler is available to interact with the IBM Spectrum Protect™ server's central scheduler to automatically back up your data.

- IBM Spectrum Protect scheduler overview  
The IBM Spectrum Protect central scheduler allows client operations to occur automatically at specified times.
- Client return codes  
The backup-archive command-line interface and the scheduler exit with return codes that accurately reflect the success or failure of the client operation.

## IBM Spectrum Protect scheduler overview

---

The IBM Spectrum Protect™ central scheduler allows client operations to occur automatically at specified times.

To understand scheduling with IBM Spectrum Protect, several terms need to be defined:

**schedule definition**

A schedule definition on the IBM Spectrum Protect server specifies critical properties of an automated activity, including the type of action, the time the action should take place, and how frequently the action takes place. Numerous other properties can be set for a schedule. For information about the DEFINE SCHEDULE, see the IBM Spectrum Protect server documentation.

**schedule association**

A schedule association is an assignment to a specific schedule definition for a client node. Multiple schedule associations allow single schedule definitions to be used by many client nodes. Because schedule definitions are included with specific policy domains, it is only possible for nodes that are defined to a certain policy domain to be associated with schedules defined in that domain.

**scheduled event**

A scheduled event is a specific occurrence of when a schedule is run for a node. The following conditions must be met before automatic scheduled events take place for a client:

- A schedule definition must exist for a specific policy domain.
- A schedule association must exist for the required node, which belongs to that policy domain.
- The client scheduler process must be running on the client system.

**AIX** | **Linux** | **Mac OS X** | **Solaris** When creating a schedule definition on the IBM Spectrum Protect server, schedule actions that you can take include incremental, selective, archive, restore, retrieve, image backup (does not apply to Mac OS X), image restore (does not apply to Mac OS X), command, and macro. The scheduled action that is most frequently used is incremental with the objects parameter left undefined. With this setting, the backup-archive client performs a domain incremental backup of all file systems defined by the client domain option. A schedule definition using the command action allows an operating system command or shell script to be executed. When automating tasks for IBM Spectrum Protect for Data Protection clients, you must use command action schedule definitions, which invoke the command-line utilities for those applications.

**Windows** When creating a schedule definition on the IBM Spectrum Protect server, schedule actions that you can take include incremental, selective, archive, restore, retrieve, imagerestore, command, and macro. The scheduled action that is

most frequently used is incremental with the objects parameter left undefined. With this setting, the IBM Spectrum Protect client performs a domain incremental backup of all drives defined by the client domain option. A schedule definition using the command action allows an operating system command or shell script to be executed. When automating tasks for IBM Spectrum Protect for Data Protection clients, you must use command action schedule definitions, which invoke the command-line utilities for those applications.

The schedule *startup window* indicates the acceptable time period for a scheduled event to start. The startup window is defined by these schedule definition parameters: startdate, starttime, durunits, and duration. The startdate and starttime options define the beginning of the startup window for the very first scheduled event. The beginning of the startup windows for subsequent scheduled events vary depending on the period and perunit values of the schedule definition. The duration and durunits parameters define the length of the startup window. The schedule action is required to start within the startup window. To illustrate, consider the results of the following schedule definition:

```
define schedule standard test1 action=incremental starttime=12:00:00 period=1
perunits=hour dur=30 duru=minutes
```

Event	Window start	Window end	Actual start (just an example, times vary)
1	12:00:00	12:30:00	12:05:33
2	13:00:00	13:30:00	13:15:02
3	14:00:00	14:30:00	14:02:00
and so on			

The variation in actual start times is a result of the randomization feature provided by the IBM Spectrum Protect central scheduler which helps to balance the load of scheduled sessions on the IBM Spectrum Protect server.

- **Examples: Blank spaces in file names in schedule definitions**  
When you define or update a schedule objects parameter or the schedule options parameter with file specifications that contain blank spaces, put quotation marks (") around each file specification that contains blanks, then add single quotes (') around the entire specification.
- **Preferential start times for certain nodes**  
Occasionally, you might want to ensure that a particular node begins its scheduled activity as close as possible to the defined start time of the schedule. The need for this typically arises when prompted mode scheduling is in use.
- **Scheduler processing options**  
Scheduler processing options determine what operations are performed when a scheduler job is started.
- **Client-acceptor scheduler services versus the traditional scheduler services**  
You can configure the IBM Spectrum Protect client to manage the scheduler process using the IBM Spectrum Protect client acceptor daemon.
- **Setting the client scheduler process to run as a background task and start automatically at startup**  
You can configure the IBM Spectrum Protect client scheduler to run as a background system task that starts automatically when your system is started.
- **Examples: Display information about scheduled work**  
Schedules can be classic or enhanced, depending on how the interval to the next execution is defined.
- **Display information about completed work**  
When you run the schedule command in the foreground, your screen displays output from the scheduled commands.
- **Specify scheduling options**  
You can modify scheduling options in the client options file or the graphical user interface (GUI).
- **AIX Linux Solaris Mac OS X Scheduler options for commands**  
The scheduler executes commands under a user ID of 0 (root); however, some commands might need to be executed under a user ID other than 0.
- **Enable or disable scheduled commands**  
You can use the schedcmddisabled option to disable the scheduling of commands by the server.
- **Windows Change processing options used by the scheduler service**  
When you configure the IBM Spectrum Protect central-scheduling services (the scheduler, the client acceptor, or the remote client agent), some of the processing options that you specify are defined in the Windows registry.
- **Manage multiple schedule requirements on one system**  
In certain situations it is preferable to have more than one scheduled activity for each client system.

## Examples: Blank spaces in file names in schedule definitions



When you define or update a schedule objects parameter or the schedule options parameter with file specifications that contain blank spaces, put quotation marks (") around each file specification that contains blanks, then add single quotes (') around the entire specification.

**AIX** | **Linux** | **Mac OS X** | **Solaris** The following examples show how to delimit schedule object parameters when file specifications contain space characters:

```
objects="/home/proj1/Some file.doc"
objects="/home/proj1/Some file.doc" "/home/Another file.txt" /home/noblanks.txt'
objects="/home/My Directory With Blank Spaces/"
objects="/Users/user1/Documents/Some file.doc"
objects="/Users/user1/Documents/Some file.doc"
"/Users/user5/Documents/Another file.txt" /Users/user3/Documents/noblanks.txt'
objects="/Users/user1/My Directory With Blank Spaces/"
```

This syntax ensures that a file specification containing a space, such as /home/proj1/Some file.doc, is treated as a single file name, and not as two separate files (/home/proj1/Some, and file.doc).

**AIX** | **Linux** | **Mac OS X** | **Solaris** The following examples show how to delimit schedule options parameters when file specifications contain space characters:

```
options='-preschedulecmd="/home/me/my files/bin/myscript"
-postschedulecmd="/home/me/my files/bin/mypostsript" -quiet'
options='-presched="/home/me/my files/bin/precmd" -postsched=finish'
```

**Windows** The following examples show how to delimit schedule object parameters when file specifications contain space characters:

```
objects="c:\home\proj1\Some file.doc"
objects="c:\home\proj1\Some file.doc" "c:\home\Another file.txt"
c:\home\noblanks.txt'
objects="c:\home\My Directory With Blank Spaces/"
objects="c:\Users\user1\Documents\Some file.doc"
objects="c:\Users\user1\Documents\Some file.doc"
"c:\Users\user5\Documents\ Another file.txt" c:\Users\user3\Documents\noblanks.txt'
objects="c:\Users\user1\My Directory With Blank Spaces/"
```

This syntax ensures that a file specification containing a space, such as c:\home\proj1\Some file.doc, is treated as a single file name, and not as two separate files (c:\home\proj1\Some, and file.doc)

**Windows** The following examples show how to delimit schedule options parameters when file specifications contain space characters:

```
options='-preschedulecmd="c:\home\me\my files\bin\myscript"
-postschedulecmd="c:\home\me\my files\bin\mypostsript" -quiet'
options='-presched="c:\home\me\my files\bin\precmd" -postsched=finish'
```

You can also refer to the objects and options parameter information for the DEFINE SCHEDULE and UPDATE SCHEDULE commands. For descriptions of these commands and parameters, see the IBM Spectrum Protect™ server documentation..

#### **Related concepts:**

Specifying input strings that contain blank spaces or quotation marks

## **Preferential start times for certain nodes**

---

Occasionally, you might want to ensure that a particular node begins its scheduled activity as close as possible to the defined start time of the schedule. The need for this typically arises when prompted mode scheduling is in use.

Depending on the number of client nodes associated with the schedule and where the node is in the prompting sequence, the node might be prompted significantly later than the start time for the schedule.

In this case, you can perform the following steps:

1. Copy the schedule to a new schedule with a different name (or define a new schedule with the preferred attributes).
2. Set the new schedule priority attribute so that it has a higher priority than the original schedule.
3. Delete the association for the node from the original schedule, then associate the node to the new schedule.

Now the IBM Spectrum Protect™ server processes the new schedule first.

## Scheduler processing options

Scheduler processing options determine what operations are performed when a scheduler job is started.

You can define most of these scheduler processing options in the client options file. However, some of these options can be set on the IBM Spectrum Protect™ server, so they affect all clients.

The following table shows which options are defined by the client and server, and which options are overridden by the server. An X in a column indicates where the option can be specified.

Option	Client defined	Server defined	Server global override
manageservices	X		
maxcmdretries	X		SET MAXCMDRETRIES command
maxschedsessions		X	
postschedulecmd, postnschedulecmd	X		
preschedulecmd, prenschedulecmd	X		
queryschedperiod	X		SET QUERYSCHEDPERIOD command
randomize		X	
retryperiod	X		SET RETRYPERIOD command
schedcmddisabled	X		
schedlogname	X		
schedlogretention	X		
schedmode	X		SET SCHEDMODES command
sessioninitiation	X	X	UPDATE NODE command
tcpclientaddress	X	X (also defined on server when sessioninit=serveronly as part of the node definition)	
tcpclientport	X	X (also defined on server when sessioninit=serveronly as part of the node definition)	

**Windows** Client defined options are defined in the dsm.opt file. The IBM Spectrum Protect server can also define some options in a client options set, or as part of the options parameter of the schedule definition. The IBM Spectrum Protect server can also set some options globally for all clients. By default, the client setting for these options is honored. If the global override on the IBM Spectrum Protect server is set, the client setting for the option is ignored. Defining client options as part of the schedule definition is useful if you want to use specific options for a scheduled action that differ from the option settings normally used by the client node, or are different for each schedule the node executes.

**AIX | Linux | Solaris | Mac OS X** Client defined options are defined in the dsm.sys or dsm.opt file, depending on the option and platform. The IBM Spectrum Protect server can also define some options in a client options set, or as part of the options parameter of the schedule definition. The IBM Spectrum Protect server can also set some options globally for all clients. By default, the client setting for these options is honored. If the global override on the IBM Spectrum Protect server is set, the client setting for the option is ignored. Defining client options as part of the schedule definition is useful if you want to use specific options for a scheduled action that differ from the option settings normally used by the client node, or are different for each schedule the node executes.

The schedmode option controls the communication interaction between the IBM Spectrum Protect client and server. There are two variations on the schedule mode: *client polling* and *server prompted*. These variations are explained in the IBM Spectrum

Protect server documentation.

- Evaluate schedule return codes in schedule scripts  
You can use environment variables to determine the current IBM Spectrum Protect return code before you run a script by using either the `preschedulecmd` or `postschedulecmd` client options.
- Return codes from `preschedulecmd` and `postschedulecmd` scripts  
The return codes that you might see when you use the `preschedulecmd` and `postschedulecmd` options are described.

## Evaluate schedule return codes in schedule scripts

---

You can use environment variables to determine the current IBM Spectrum Protect™ return code before you run a script by using either the `preschedulecmd` or `postschedulecmd` client options.

**AIX** | **Linux** | **Solaris** | **Mac OS X** | **Windows** IBM Spectrum Protect provides the current value of the return code in the environment variable called `TSM_PRE_CMD_RC`. The `TSM_PRE_CMD_RC` variable is the current value of the IBM Spectrum Protect return code before you run a schedule script. The value of the `TSM_PRE_CMD_RC` variable is not necessarily the same as the return code issued by IBM Spectrum Protect following the execution of the schedule script. The `TSM_PRE_CMD_RC` variable can be used in schedule scripts to determine the current state of the schedule.

The `TSM_PRE_CMD_RC` variable is set on each of the following schedule options: `preschedule`, `prenschedule`, `postschedule`, and `postnschedule`. `TSM_PRE_CMD_RC` affects those schedules that have the `ACTION=COMMAND` option specified.

An example of the `TSM_PRE_CMD_RC` variable in use:

```
AIX | Linux | Solaris | Mac OS X | Windows  
if [[ -n ${TSM_PRE_CMD_RC} ]] ; then  
    if [[ ${TSM_PRE_CMD_RC} == 0 ]] ; then  
        echo "The TSM_PRE_CMD_RC is 0"  
    elif [[ ${TSM_PRE_CMD_RC} == 4 ]] ; then  
        echo "The TSM_PRE_CMD_RC is 4"  
    elif [[ ${TSM_PRE_CMD_RC} == 8 ]] ; then  
        echo "The TSM_PRE_CMD_RC is 8"  
    elif [[ ${TSM_PRE_CMD_RC} == 12 ]] ; then  
        echo "The TSM_PRE_CMD_RC is 12"  
        else  
            echo "The TSM_PRE_CMD_RC is an unexpected value: ${TSM_PRE_CMD_RC}"  
        fi  
    fi  
else  
    echo "The TSM_PRE_CMD_RC is not set"  
fi
```

## Return codes from `preschedulecmd` and `postschedulecmd` scripts

---

The return codes that you might see when you use the `preschedulecmd` and `postschedulecmd` options are described.

- AIX** | **Linux** | **Solaris** | **Mac OS X** | **Windows**
- If the command specified by the `preschedulecmd` option ends with a nonzero return code, IBM Spectrum Protect™ assumes that the command failed. In this case, the scheduled event and any `postschedulecmd` or `postnschedulecmd` command cannot run. The administrative query event command with `format=detailed` option shows that the event failed with return code 12.
  - If the command specified by the `postschedulecmd` option ends with a nonzero return code, IBM Spectrum Protect considers the command to be failed. The administrative query event command with `format=detailed` option shows that the event completed with return code 8. The exception is if the scheduled operation completed with a higher return code, in which case the higher return code takes precedence. Therefore, if the scheduled operation completes with return code 0 or 4 and the `postschedulecmd` command fails, the administrative query event command shows that the event completed with return code 8. If the scheduled operation completes with return code 12, that return code takes precedence, and query event shows that the event failed with return code 12.

AIX	Linux	Solaris	Mac OS X
-----	-------	---------	----------

When you interpret the return code from a command, IBM Spectrum Protect considers 0 to mean success, and anything else to mean failure. While this behavior is widely accepted in the industry, it is not 100% guaranteed. For example, the developer of the widget command might exit with return code 3, if widget ran successfully. Therefore, it is possible that the preschedulecmd or postschedulecmd command might end with a nonzero return code and still be successful. To prevent IBM Spectrum Protect from treating such commands as failed, you can wrap these commands in a script, and code the script so that it interprets the command return codes correctly. The script exits with return code 0 if the command was successful; otherwise it exits with a nonzero return code. The logic for a script running widget might look like this example:

**Windows** When you interpret the return code from a command, IBM Spectrum Protect considers 0 to mean success, and anything else to mean failure. While this behavior is widely accepted in the industry, it is not 100% guaranteed. For example, the developer of the widget.exe command might exit with return code 3, if widget.exe ran successfully. Therefore, it is possible that the preschedulecmd or postschedulecmd command might end with a nonzero return code and still be successful. To prevent IBM Spectrum Protect from treating such commands as failed, you can wrap these commands in a script, and code the script so that it interprets the command return codes correctly. The script should exit with return code 0 if the command was successful; otherwise it should exit with a nonzero return code. The logic for a script that runs widget.exe might look like this example:

AIX	Linux	Solaris	Mac OS X
-----	-------	---------	----------

```
run 'widget'
  if lastcc == 3
    exit 0
  else
    exit 1
```

**Windows**

```
run 'widget.exe'
  if lastcc == 3
    exit 0
  else
    exit 1
```

**Related reference:**

AIX	Linux	Solaris	Mac OS X	Windows	Postschedulecmd/Postnschedulecmd
AIX	Linux	Solaris	Mac OS X	Windows	Preschedulecmd/Prenschedulecmd

## Client-acceptor scheduler services versus the traditional scheduler services

You can configure the IBM Spectrum Protect™ client to manage the scheduler process using the IBM Spectrum Protect client acceptor daemon.

The client acceptor daemon provides a light-weight timer which automatically starts and stops the scheduler process as needed. Alternatively, the traditional method keeps the IBM Spectrum Protect scheduler process running continuously. Generally, using the client acceptor daemon to manage the scheduler is the preferred method.

The following information is a comparison of the client acceptor daemon-managed services and the traditional scheduler services methods.

Client acceptor daemon-managed services

- Defined using the managedservices schedule option and started with client acceptor daemon services (dsmcad).
- The client acceptor daemon starts and stops the scheduler process as needed for each scheduled action.
- Requires fewer system resources when idle.
- IBM Spectrum Protect client options and IBM Spectrum Protect server override options are refreshed each time the client acceptor daemon services start a scheduled backup.
- Cannot be used with SESSIONINITiation=SERVEROnly backups.

IBM Spectrum Protect traditional scheduler services

- Started with command `dsmc sched` command.
- Remains active, even after scheduled backup is complete.
- Requires higher use of system resources when idle.
- IBM Spectrum Protect client options and IBM Spectrum Protect server override options are only processed once when `dsmc sched` is started; if you delete an option from a client options set, you must restart the scheduler so the scheduler is made aware of the deletion.

**Tip:** Restart the traditional scheduler periodically to free system resources previously used by system calls.

## Setting the client scheduler process to run as a background task and start automatically at startup

You can configure the IBM Spectrum Protect™ client scheduler to run as a background system task that starts automatically when your system is started.

### About this task

You can complete this task whether you use the client acceptor to manage the scheduler or whether you use the traditional method to start the scheduler client scheduler.

**AIX** | **Linux** | **Solaris** | **Mac OS X** When you are running a client acceptor-managed schedule, set the client acceptor process to start automatically at startup time; not the scheduler process. For the traditional method, set the scheduler process to start automatically at startup time.

**AIX** | **Linux** | **Solaris** | **Mac OS X** You can configure the client acceptor to run as a background system task that starts automatically when your system is started. To configure the client acceptor to manage scheduled backups, you use the `manageservices` option to specify whether the client acceptor manages only the scheduler, only the web client, or both the scheduler and web client. The method for setting up the client acceptor as a system task varies for each platform.

For the scheduler to start unattended, you must enable the client to store its password by setting the `passwordaccess` option to `generate`, and store the password by running a simple client command such as `dsmc query session`. For testing purposes, you can always start the scheduler in the foreground by running `dsmc sched` from a command prompt (without a `manageservices` stanza set).

**AIX** | **Linux** | **Solaris** | **Mac OS X** To start the scheduler automatically at startup time, use either the client acceptor-managed method or the traditional method.

**AIX** | **Linux** | **Solaris** | **Mac OS X**

#### Client acceptor-managed method

1. In your `dsm.sys` file, set the `manageservices` option to `schedule` or `schedule webclient`.
2. Start the client acceptor.

- a. **AIX** | **Solaris**

On AIX® and Solaris clients, add the following entry into the system startup file (`/etc/inittab` for most platforms):

```
tsm::once:/usr/bin/dsmcad > /dev/null 2>&1 # TSM Client
Acceptor Daemon
```

- b. **Linux**

On Linux clients, the installation program creates a startup script for the client acceptor (`dsmcad`) in `/etc/init.d`. The client acceptor (`dsmcad`) must be started before it can manage scheduler tasks, or manage the web client. As root, use the following command to start, stop, or restart the client acceptor, or check its status:

```
>>-service dsmcad--start---+-----><
      +-stop----+
      +-restart--+
      '-status--'
```

To enable the client acceptor to start automatically after a system restart, add the service as follows, at a shell prompt:

```
# chkconfig --add dsmcad
```

If the Linux operating system runs the `systemd` initialization service, complete the following steps to start the `dsmcad` and to run it at system start time:

- i. Copy the provided `systemd` unit file `/opt/tivoli/tsm/client/ba/bin/dsmcad.service` to the `/etc/systemd/system/` directory.

ii. Run the following command to refresh the `systemd` unit list:

```
systemctl daemon-reload
```

iii. Run the following command to start the client acceptor at system start time:

```
systemctl enable dsmcad.service
```

iv. Run the following command to start the client acceptor:

```
systemctl start dsmcad.service
```

- c. **Mac OS X** On Mac OS X, the client acceptor must be installed as a Startup Item. A system administrator must use the IBM Spectrum Protect Tools for Administrators to install and start the client acceptor. To start, stop, or restart the client acceptor, use the following command:

```
>>-sudo /sbin/SystemStarter---+start---+---dsmcad-----<<
                                     +-stop----+
                                     '-restart-'
```

3. In your `dsm.sys` file, set the `passwordaccess` option to generate.
4. Run a command like `dsmc query sess` to store the node password.

AIX	Linux	Solaris	Mac OS X	Traditional method:
AIX	Linux	Solaris	Mac OS X	

1. Set the `managedservices` option.

- o **AIX** **Linux** **Solaris** On AIX, Linux, and Solaris clients, either remove the option entirely (it defaults to `webclient`) or set it to `webclient`.
- o **Mac OS X** On Mac OS X clients, set the `managedservices` option to either `webclient` or `none`. Do not set the option to `schedule`.

2. On AIX, Linux, and Solaris, add the following entry into the system startup file, for example, `/etc/inittab`, where it is supported:

```
tsmsched::once:/usr/bin/dsmc sched > /dev/null 2>&1 # TSM scheduler
```

3. In your `dsm.sys` file, set the `passwordaccess` option to generate.
4. Run a command like `dsmc query sess` to store the node password.
5. To start the client scheduler on your client node and connect to the server schedule, enter the following command:

```
dsmc schedule
```

If the current directory is not in your `PATH` environment variable, enter the following command:

```
./dsmc schedule
```

When you start the client scheduler, it runs continuously until you close the window, end the process, or log off your system.

To run the `schedule` command in the background and to keep the client scheduler running, even if you log off your system, enter the following command:

```
nohup dsmc schedule 2> /dev/null &
```

**Windows** On Windows platforms, the scheduler and the client acceptor run as services. You can create and manage these services by using either the setup wizard or the IBM Spectrum Protect Client Service Configuration Utility, `dsmcutil.exe`.

**Windows**

- To start the setup wizard, select `Utilities > Setup Wizard` in the backup-archive GUI and select a `Help me configure` option for the appropriate service. Follow the prompts to install, configure, and start the service.
- To start the Client Service Configuration Utility, open a command prompt window and issue the following command to change to the directory that contains `dsmcutil.exe`:

```
cd /d "c:\program files\tivoli\tsm\baclient"
```

Use `dsmcutil` to manage the client acceptor service or the scheduler service. Full documentation on how to use `dsmcutil` is available by entering `dsmcutil help`.

**Windows** The client scheduler can be managed by the client acceptor. When setting up scheduler services to run with client acceptor management, two services must be created: the scheduler service and the client acceptor service. When you install the client acceptor service with `dsmcutil.exe`, use the `/cadschedname:` parameter to identify which scheduler service the client acceptor manages. If you use the setup wizard to install the scheduler, you can select the Use the client acceptor to manage the scheduler check box, which automatically creates both services and associates them.

**Windows** Using the Client Service Configuration Utility, you can use either of the following methods:

**Windows**

#### Client acceptor-managed method

1. In your client options file (`dsm.opt`), either set the `managedservices` option to `schedule` or `schedule webclient`.
2. In your client options file (`dsm.opt`), set the `passwordaccess` option to `generate`.
3. Create the scheduler service:

```
dsmcutil inst /name:"TSM Client Scheduler" /node:tsmclient1  
/password:secret /autostart:no /startnow:no
```

4. Create the client acceptor and associate scheduler service with the client acceptor:

```
dsmcutil inst CAD /name:"TSM Client Acceptor" /cadschedname:  
"TSM Client Scheduler" /node:tsmclient1 /password:secret /autostart:yes
```

5. Manually start the client acceptor service:

```
net start "TSM Client Acceptor"
```

#### Traditional method

1. In your client options file (`dsm.opt`), either remove the `managedservices` entirely (it defaults to `webclient`) or set it to `webclient`.
2. In your client options file (`dsm.opt`), set the `passwordaccess` option to `generate`.
3. Create the scheduler service:

```
dsmcutil inst /name:"TSM Client Scheduler" /node:tsmclient1  
/password:secret /autostart:yes
```

**Windows** To increase the reliability of the client scheduler service on Windows, set the services to automatically recover from a failure as follows:

**Windows**

- Start the Windows services management console (Start > Settings > Control Panel > Administrative Tools > Services)
- Right-click the TSM Client Scheduler service and select Properties.
- Click the Recovery tab.
- Define the recovery action as Restart the service for first, second, and subsequent failures.

**Windows** If you are using the client acceptor to manage the scheduler, you must set the recovery properties for the TSM Client Acceptor service, but leave the recovery settings for the TSM Client Scheduler service as Take No Action for the first, second, and subsequent failures. The same recovery settings can also be defined to increase the reliability of the TSM Journal Service.

#### Related reference:

Cadlistenonport

## Examples: Display information about scheduled work

Schedules can be classic or enhanced, depending on how the interval to the next execution is defined.

Classic schedules allow the period to be as small as an hour. Enhanced schedules allow actions to be executed on specific days.

To view schedules that are defined for your client node, enter: **AIX** **Linux** **Solaris** **Mac OS X** **Windows**

```
dsmc query schedule
```

The backup-archive client displays detailed information about all scheduled work for your client node. Table 1 displays sample classic query schedule output.

Table 1. Sample classic query schedule output

AIX	Linux	Solaris	Mac OS X
<pre> Schedule Name: DAILY_INC   Description: Daily System-wide backup Schedule Style: Classic   Action: Incremental   Options: QUIET   Objects:   Priority: 1 Next Execution: 30 minutes   Duration: 4 Hours   Period: 1 Day   Day of Week: Any   Month:   Day of Month: Week of Month:   Expire: Never  Schedule Name: WEEKLY_INC   Description: Weekly backup for project files Schedule Style: Classic   Action: Incremental   Options: QUIET   Objects: /proj   Priority: 1 Next Execution: 60 minutes   Duration: 8 Hours   Period: 7 Days   Day of Week: Friday   Month:   Day of Month: Week of Month:   Expire: Never </pre>			
<b>Windows</b>			
<pre> Schedule Name: DAILY_INC   Description: Daily System-wide backup Schedule Style: Classic   Action: Incremental   Options: QUIET   Objects:   Priority: 1 Next Execution: 30 minutes   Duration: 4 Hours   Period: 1 Day   Day of Week: Any   Month:   Day of Month: Week of Month:   Expire: Never  Schedule Name: WEEKLY_INC   Description: Weekly backup for project files Schedule Style: Classic   Action: Incremental   Options: QUIET   Objects: e: f:   Priority: 1 Next Execution: 60 minutes   Duration: 8 Hours   Period: 7 Days   Day of Week: Friday   Month:   Day of Month: Week of Month:   Expire: Never </pre>			

**AIX** | **Linux** | **Solaris** | **Mac OS X** The schedule name, **WEEKLY\_INC**, starts a weekly incremental backup in the /proj file system.

**Windows** The schedule name, **WEEKLY\_INC**, starts a weekly incremental backup on the e: and f: drives.



The schedule name, **DAILY\_INC**, starts a daily incremental backup. The next incremental backup starts in 30 minutes. Because no objects are listed, the client runs the incremental backup on your default domain. The schedule has no expiration date.

To more accurately determine the status of scheduled events, the query schedule output for an enhanced schedule, on IBM Spectrum Protect™ Version 5.3 client and above, includes new fields. These fields are always displayed, even if it is a classic schedule or a version 5.3 client session with a pre-version 5.3 server, but the new fields are blank. Note that for a down-level (prior to version 5.3) client, the server reports the period as indefinite and the day of week as an illegal day. Table 2 displays sample enhanced query schedule output.

Table 2. Sample enhanced query schedule output

AIX	Linux	Solaris	Mac OS X
<pre>Schedule Name: QUARTERLY_FULL Description: Quarterly full backup Schedule Style: Enhanced Action: Selective Options: subdir=yes Objects: /* /Volumes/fs2/* Priority: 5 Next Execution: 1744 Hours and 26 Minutes Duration: 1 Day Period: Day of Week: Friday Month: March, June, September, December Day of Month: Any Week of Month: Last Expire: Never</pre>			
Windows			
<pre>Schedule Name: QUARTERLY_FULL Description: Quarterly full backup Schedule Style: Enhanced Action: Selective Options: subdir=yes Objects: \* \volumes\fs2\* Priority: 5 Next Execution: 1744 Hours and 26 Minutes Duration: 1 Day Period: Day of Week: Friday Month: March, June, September, December Day of Month: Any Week of Month: Last Expire: Never</pre>			

## Display information about completed work

When you run the schedule command in the foreground, your screen displays output from the scheduled commands.

Output is also directed to the `dsmsched.log` file in the installation directory unless you change the directory and file name using the `shedlogname` option.

**AIX** **Linux** **Solaris** **Mac OS X** When you run the schedule command in the background, output from scheduled commands is directed to the `dsmsched.log` file in the current directory, or to the path and file name that you specified. The `dsmsched.log` cannot be a symbolic link.

**Mac OS X** Note: On Mac OS X, by default the log can be found in one of these locations:

```
~/Library/Logs/tivoli/tsm
/Library/Logs/tivoli/tsm
```

**Windows** When you run the schedule command as a service, output from scheduled commands displays in the application event log. Output is also directed to the `dsmsched.log` file in the current directory unless you change the path and file name using the `shedlogname` option. The amount of detail is determined by whether `verbose` or `quiet` is set in the `dsm.opt` file. The scheduler service also posts messages to the Windows event log.

After scheduled work is performed, check the schedule log to verify that all work completed successfully.

When a scheduled command is processed the schedule log contains the following entry:

Scheduled event *eventname* completed successfully

If the scheduled event does not complete successfully, you receive a message similar to the following:

```
ANS1512E Scheduled event eventname failed. Return code = code.
```

The client indicates whether IBM Spectrum Protect™ successfully issued the scheduled command associated with the *eventname* (action=command). No attempt is made to determine the success or failure of the command. You can assess the status of the command by evaluating the return code from the scheduled command in the schedule log. The schedule log entry for the return code of the command is prefaced with the following text:

```
Finished command. Return code is:
```

The schedule log continues to grow unless you prune it using the schedlogretention option or specify a maximum size using the schedlogmax option.

- Examples: event logs  
The scheduler service logs information into the application event log and provides an event identification (event ID) number for each event in the log. This topic shows examples of events that are logged to the application event log.

**Related concepts:**

Specify scheduling options

## Specify scheduling options

---

You can modify scheduling options in the client options file or the graphical user interface (GUI).

However, if your administrator specifies a value for these options, that value overrides the value in your client.

**Related concepts:**

Scheduling options



## Scheduler options for commands

---

The scheduler executes commands under a user ID of 0 (root); however, some commands might need to be executed under a user ID other than 0.

In this case, your IBM Spectrum Protect™ administrator can define schedules for commands that are executed under a user ID different from the scheduler user ID using the schedcmduser server option.

The schedcmduser option specifies the name of a valid user on the system where a scheduled command is executed. This option can only be defined by the IBM Spectrum Protect server administrator. If this option is specified, the command is executed with the authorization of the specified user. Otherwise, it is executed with the scheduler authorization.

```
>>-SCHEDCMDUser----user_name-----<<
```

user\_name

Specifies the name of a valid user on the system where a scheduled command is executed.

Note: The schedcmduser option does *not* affect the user ID used for the pre-schedule and post-schedule commands. Pre-schedule and post-schedule always run as root (user ID 0).

## Enable or disable scheduled commands

---

You can use the schedcmddisabled option to disable the scheduling of commands by the server.

Commands are scheduled by using the action=*command* option on the DEFINE SCHEDULE server command.

The schedcmddisabled option does not disable the preschedulecmd and postschedulecmd commands. However, you can specify preschedulecmd or postschedulecmd with a blank or a null string to disable the scheduling of these commands.

You can use the `schedrestretrdisabled` option to prevent the IBM Spectrum Protect™ server administrator from executing restore or retrieve schedule operations.

You can use the `srvprepostscheddisabled` option to prevent the IBM Spectrum Protect server administrator from executing pre-schedule and post-schedule commands when performing scheduled operations.

**AIX** | **Linux** | **Solaris** | **Mac OS X** | **Windows** You can use the `srvprepostsnapdisabled` option to prevent the IBM Spectrum Protect server administrator from executing pre-snapshot and post-snapshot commands when performing scheduled image snapshot backup operations.

**Related reference:**

Schedcmddisabled

Schedrestretrdisabled

Srvprepostscheddisabled

**AIX** | **Linux** | **Solaris** | **Mac OS X** | **Windows** Srvprepostsnapdisabled  
**Windows**

## Change processing options used by the scheduler service

---

When you configure the IBM Spectrum Protect™ central-scheduling services (the scheduler, the client acceptor, or the remote client agent), some of the processing options that you specify are defined in the Windows registry.

The following options can also be specified in the client options file (`dsm.opt`).

- `nodename`
- `httpport`
- `tcpserveraddress`
- `tcpport`
- `webports`

When the client scheduler runs as a foreground process using the `dsmc sched` command, the options in the client options file are used. However, when the scheduler runs as a Windows service, the options in the registry are used instead. If you are using the scheduler service and change an option in the `dsm.opt` file, you must update the corresponding value in the registry as well.

To update the Windows registry value:

Use the Setup wizard in the client GUI. For more information, see [Configuring the scheduler](#).

Alternatively, you can use the `dsmcutil` utility to change the registry value. For example: `dsmcutil update scheduler /name: <service name> /node: <new node name> /password: <new node password>`.

**Note:** After updating the registry, you must restart the scheduler service for the changes to take effect. If you are using client acceptor daemon-managed scheduling this is not necessary because the scheduler is restarted by the client acceptor daemon for each backup.

## Manage multiple schedule requirements on one system

---

In certain situations it is preferable to have more than one scheduled activity for each client system.

### About this task

---

Normally, you can do this by associating a node with more than one schedule definition. This is the standard method of running multiple schedules on one system.

You must ensure that the schedule windows for each schedule do not overlap. A single client scheduler process is not capable of executing multiple scheduled actions simultaneously, so if there is overlap, the second schedule to start is missed if the first schedule does not complete before the end of the startup window of the second schedule.

**AIX** | **Linux** | **Solaris** | **Mac OS X** Suppose that most of the file systems on your client system must be backed up daily, and that one file system containing critical data must be backed up hourly. In this case, you would need to define two schedules to handle this requirement. To avoid conflict between the hourly and daily backup schedule, the *starttime* of each schedule needs to be varied.

**Windows** Suppose that most of the drives on your client system must be backed up daily, and that one drive containing critical data must be backed up hourly. In this case, you would need to define two schedules to handle this requirement. To avoid conflict between the hourly and daily backup schedule, the *starttime* of each schedule needs to be varied.

In certain cases, it is necessary to run more than one scheduler process on a system. Multiple processes require a separate options file for each process and must contain the following information:

- Define a unique node name for each process
- Specify unique schedule and error logs for each process
- When running in prompted mode, you must use the `tcpclientport` option to specify a unique port for each process.

**Windows** Note: When the scheduler runs as a service, processing options specified in the Windows registry override the same options specified in the client options file.

The advantages of using multiple schedule processes:

- You can run more than one scheduled backup at the same time.
- You can specify different backup criteria for each schedule started, with the client option file or IBM Spectrum Protect™ server override options.

The disadvantages of using multiple schedule processes:

- A unique file space for each node name on the IBM Spectrum Protect server is created.
- When restoring the data, you must use the same node name associated with the backup.

**AIX** **Linux** **Solaris** **Mac OS X** Multiple schedule processes can run on UNIX and Linux platforms with either the client acceptor daemon-managed method, or the traditional method of running the scheduler. In either case, there are certain setup requirements:

**AIX** **Linux** **Solaris** **Mac OS X**

- Each process must run using a different node name.
- You must create multiple stanzas in the `dsm.sys` file for each scheduler process. In each stanza, you must define a unique node name, along with unique values for the options `errorlogname` and `schedlogname`. You might also choose to define customized domain, include, and exclude statements for each stanza.
- In your `dsm.sys` file, set the `passwordaccess` option to generate in each stanza. The password must be generated for each node name that is running a scheduler process, by running a command such as `dsmc query sess`.
- If running with the `schedmode` option set to `prompt`, you should set a unique `tcpclientport` value for each stanza.

**AIX** **Linux** **Solaris** **Mac OS X** You must start each `dsmc sched` command or instance with the `-servername` option to reference its unique stanza name in `dsm.sys`. For `dsmcad`, it is necessary to define the environment variable `DSM_CONFIG` for each instance of `dsmcad` to reference its unique option file.

**AIX** **Linux** **Solaris** **Mac OS X** The following is an example configuration of two schedule processes managed by the client acceptor daemon in the `dsm.sys` file. Note that you must use full paths for the log file names to avoid the files being written in the root directory):

```
servername tsml_sched1
    nodename      aixsvt01_sched1
    tcpserv       firebat
    tcpclientport 1507
    passwordaccess generate
    domain        /svt1
    schedmode     prompted
    schedlogname  /tsm/dsmsched1.log
    errorlogname  /tsm/dsmerror1.log
    managedservices schedule
```

```
servername tsml_sched2
    nodename      aixsvt01_sched2
    tcpserv       firebat
    tcpclientport 1508
    passwordaccess generate
    domain        /svt1
    schedmode     prompted
    schedlogname  /tsm/dsmsched2.log
    errorlogname  /tsm/dsmerror2.log
    managedservices schedule
```

**AIX** **Linux** **Solaris** **Mac OS X** Contents of `/test/dsm.opt1`:

**AIX** **Linux** **Solaris** **Mac OS X**

```
servername tsml_sched1
```

AIX Linux Solaris Mac OS X Contents of /test/dsm.opt2:

AIX Linux Solaris Mac OS X

```
servername tsm1_sched2
```

Mac OS X Open two shell command windows:

Mac OS X

- In shell command window 1, enter:

```
export DSM_CONFIG=/test/dsm.opt1
sudo dsmcad
```

- In shell command window 2, enter:

```
export DSM_CONFIG=/test/dsm.opt2
sudo dsmcad
```

AIX Linux Solaris Mac OS X **Note:** You should enter these commands into a shell script if you intend to have the dsmcad processes started directly from /etc/inittab so that the proper DSM\_CONFIG variable can be set prior to launching dsmcad.

Windows You must create a separate service for each schedule process. If you are using the client acceptor daemon to manage the scheduler, a client acceptor daemon service and schedule service are required for each schedule. The following is an example of setting up two schedule processes to be managed by the client acceptor daemon:

```
dsmcutil inst /name:"TSM Client Scheduler1"
/optfile:"c:\program files\tivoli\tsm\baclient\dsm.opt1"
/node:tsmcli_sched1 /password:secret /autostart:no /startnow:no

dsmcutil inst CAD /name:"TSM Client Acceptor1"
/optfile:"c:\program files\tivoli\tsm\baclient\dsm.opt1"
/cadschedname:"TSM Client Scheduler1" /node:tsmcli_sched1 /password:secret
/autostart:yes

dsmcutil inst /name:"TSM Client Scheduler2"
/optfile:"c:\program files\tivoli\tsm\baclient\dsm.opt2"
/node:tsmcli_sched2 /password:secret /autostart:no /startnow:no

dsmcutil inst CAD /name:"TSM Client Acceptor2"
/optfile:"c:\program files\tivoli\tsm\baclient\dsm.opt2"
/cadschedname:"TSM Client Scheduler2" /node:tsmcli_sched2 /password:secret
/autostart:yes
```

Windows Unique option files are required for each schedule instance, and must be identified at the time of service creation:

Option file #1 (c:\program files\tivoli\tsm\baclient\dsm.opt1)

```
tcps          tsmserve1.example.com
nodename      tsmcli_sched1
passwordaccess generate
schedlogname  "c:\program files\tivoli\tsm\baclient\dsmsched1.log"
errorlogname  "c:\program files\tivoli\tsm\baclient\dsmerror1.log"
schedmode    prompted
tcpclientport 1507
domain        h:
managementservices schedule
```

Option file #2 (c:\program files\tivoli\tsm\baclient\dsm.opt2)

```
tcps          tsmserve1.example.com
nodename      tsmcli_sched2
passwordaccess generate
schedlogname  "c:\program files\tivoli\tsm\baclient\dsmsched2.log"
errorlogname  "c:\program files\tivoli\tsm\baclient\dsmerror2.log"
schedmode    prompted
tcpclientport 1508
domain        i:
managementservices schedule
```

**Related concepts:**

## Client return codes

The backup-archive command-line interface and the scheduler exit with return codes that accurately reflect the success or failure of the client operation.

Scripts, batch files, and other automation facilities can use the return code from the command-line interface. For operations that use the IBM Spectrum Protect™ scheduler, the return codes are shown in the output of the QUERY EVENT administrative command.

In general, the return code is related to the highest severity message during the client operation.

- If the highest severity message is informational (ANSnnnnI), then the return code is 0.
- If the highest severity message is a warning (ANSnnnnW), then the return code is 8.
- If the highest severity message is an error (ANSnnnnE or ANSnnnnS), then the return code is 12.

An exception to these rules is made when warning or error messages indicate that individual files could not be processed. For files that cannot be processed, the return code is 4. Examine the dserror.log file to determine the cause of errors that occur during client operations. Errors that occur during scheduled events are recorded in the dsmsched.log file.

Table 1 describes the return codes and their meanings.

Table 1. Client return codes and their meanings

Code	Explanation
0	All operations completed successfully.
4	The operation completed successfully, but some files were not processed. There were no other errors or warnings. This return code is common. Files are not processed for various reasons; the following reasons are the most common. <ul style="list-style-type: none"> <li>• The file satisfies an entry in an exclude list. Excluded files generate log entries only during selective backups.</li> <li>• The file was in use by another application and could not be accessed by the client.</li> <li>• The file changed during the operation to an extent prohibited by the copy serialization attribute. See Copy serialization attribute.</li> </ul>
<b>Windows</b> 12	<b>Windows</b> The operation completed with at least one error message (except for error messages for skipped files). For scheduled events, the status is <i>Failed</i> . Review the dserror.log file (and dsmsched.log for scheduled events) to determine what error messages were issued and to assess their impact on the operation. Generally, this return code means that the error was severe enough to prevent the successful completion of the operation. For example, an error that prevents an entire drive from being processed yields return code 12.
<b>AIX</b> <b>Linux</b> <b>Solaris</b> <b>Mac OS X</b> 12	<b>AIX</b>   <b>Linux</b>   <b>Solaris</b>   <b>Mac OS X</b> The operation completed with at least one error message (except for error messages for skipped files). For scheduled events, the status is <i>Failed</i> . Review the dserror.log file (and dsmsched.log for scheduled events) to determine what error messages were issued and to assess their impact on the operation. Generally, this return code means that the error was severe enough to prevent the successful completion of the operation. For example, an error that prevents an entire file system or file specification from being processed yields return code 12.
<i>other</i>	For scheduled operations where the scheduled action is <i>COMMAND</i> , the return code is the return code from the command that was run. If the return code is 0, the status of the scheduled operation is <i>Completed</i> . If the return code is nonzero, then the status is <i>Failed</i> .  Some commands might issue a nonzero return code to indicate success. For these commands, you can avoid a <i>Failed</i> status by wrapping the command in a script that starts the command, interprets the results, and exits. The script should produce return code 0 if the command was successful, or a nonzero return code if the command failed. Then, ask your IBM Spectrum Protect server administrator to modify the schedule definition to run your script instead of the command.

The return code for a client macro is the highest return code that is issued among the individual commands that comprise the macro. For example, suppose a macro consists of these commands:

```
AIX | Linux | Solaris | Mac OS X
selective "/home/devel/*" -subdir=yes
incremental "/home/devel/TestDriver/*" -subdir=yes
archive "/home/plan/proj1/*" -subdir=yes
```

```
Windows
selective c:\MyTools\* -subdir=yes
incremental c:\MyPrograms\TestDriver\* -subdir=yes
archive e:\TSM\* -subdir=yes
```

If the first command completes with return code 0, and the second command completes with return code 8, and the third command completed with return code 4, the return code for the macro is 8.

For more information about the QUERY EVENT command, see the IBM Spectrum Protect server documentation.

#### Related concepts:

Scheduler options for commands

## Storage management policies

Storage management policies are rules your administrator defines in order to manage your backups and archives on the server.

Your data is associated (or bound) to these policies; then when the data is backed up or archived, it is managed according to policy criteria. Policy criteria include a policy domain, a policy set, a management class, and a copy group.

Policies determine:

- Whether a file is eligible for backup or archive services.
- How many backup versions to keep.
- How long to keep inactive backup versions and archive copies.
- Where to place the copies in storage.
- For incremental backup, policies also determine:
  - How frequently a file can be backed up.
  - Whether a file must change before it is backed up again.

```
AIX | Linux | Solaris | Mac OS X
```

If you have the IBM Spectrum Protect™ for Space Management client installed, your administrator also defines rules that determine whether files are eligible for migration from your local file systems to storage.

This topic explains:

- Policy criteria (policy domains, policy sets, copy groups, and management classes).
- How to display policies.
- How your data is associated with policies.
- Policy domains and policy sets  
A *policy domain* is a group of clients with similar requirements for backing up and archiving data.
- Management classes and copy groups  
A *management class* is a collection of backup and archive copy groups that establishes and contains specific storage management requirements for backing up and archiving data.
- Display information about management classes and copy groups  
You can display policy information with the command-line interface or with a graphical user interface.
- Select a management class for files  
If the default management class meets the backup and archive requirements for all the files on your workstation, it is not necessary to take any action to associate your files with that management class. This is done automatically when you back up or archive your files.
- Assign a management class to files  
A management class defines when your files are included in a backup, how long they are kept on the server, and how many versions of the file the server should keep.
- Override the management class for archived files  
When you archive a file, you can override the assigned management class using the a graphical user interface (GUI), or by using the archmc option on the archive command.

- Select a management class for directories  
If the management class in your active policy set containing the longest "Retain only version" (REONLY) setting meets your backup requirements for directories, it might not be necessary to take any action to associate directories with that management class. The management class association is done automatically when it backs up your directories.
- Bind management classes to files  
*Binding* associates a file with a management class.
- Rebind backup versions of files  
*Rebinding* associates a file or a logical volume image with a new management class.
- Retention grace period  
IBM Spectrum Protect also provides a *backup retention grace period* and an *archive retention grace period* to help protect your backup and archive data when it is unable to rebind a file to an appropriate management class.
- Event-based policy retention protection  
All management classes with an archive copy group must specify a retention period, for example, the number of days that an archived object is stored on the server before being deleted.

## Policy domains and policy sets

---

A *policy domain* is a group of clients with similar requirements for backing up and archiving data.

Policy domains contain one or more policy sets. An administrator uses policy domains to manage a group of client nodes in a logical way.

For example, a policy domain might include:

- A department, such as Accounting.
- A physical location, such as a particular building or floor.
- A local area network, such as all clients associated with a particular file server.

IBM Spectrum Protect™ includes a default policy domain named *Standard*. At first, your client node might be associated with the default policy domain. However, your administrator can define additional policy domains if there are groups of users with unique backup and archive requirements.

A *policy set* is a group of one or more management classes. Each policy domain can hold many policy sets. The administrator uses a policy set to implement different management classes based on business and user needs. Only one of these policy sets can be active at a time. This is called the *active policy set*. Each policy set contains a *default management class* and any number of additional management classes.

## Management classes and copy groups

---

A *management class* is a collection of backup and archive copy groups that establishes and contains specific storage management requirements for backing up and archiving data.

An administrator can establish separate management classes to meet the backup and archive requirements for different kinds of data, such as:

- System data that is critical for the business.
- Application data that changes frequently.
- Report data that Management reviews monthly.
- Legal information that must be retained indefinitely, requiring a large amount of disk space.

**AIX** | **Linux** | **Solaris** | **Mac OS X** | Note: If you have the IBM Spectrum Protect™ for Space Management installed, it can also contain specific requirements for migrating files to storage.

**AIX** | **Linux** | **Solaris** | **Mac OS X** | **Windows** | Most of the work you do with storage management policies is with management classes. Each file and directory that you back up, and each file that you archive, is associated with (or *bound to*) a management class, as follows:

- If your data is not associated with a management class, IBM Spectrum Protect uses the default management class in the active policy set.
- When backing up directories, you can specify a management class with an *include* statement or the *dirmc* option. If you do not specify a management class, IBM Spectrum Protect uses the management class in the active policy set specifying the longest "Retain Only" retention period. If there are multiple management classes that meet this criteria, IBM Spectrum Protect uses the last one found, in alphabetical order.



- For archiving directories, you can specify a management class with an *include.archive* statement or the *archmc* option. If you do not specify a management class, the server assigns the default management class to the archived directory. If the default management class has no archive copy group, the server assigns the management class that currently has the archive copy group with the shortest retention time.

You can use *include* statements in your include-exclude list to associate files with management classes. In your client options file, you can associate directories with a management class, using the *dirmc* option.

Within a management class, the specific backup and archive requirements are in *copy groups*. Copy groups define the specific storage management attributes that describe how the server manages backed up or archived data. Copy groups include both *backup copy groups* and *archive copy groups*. A management class can have one backup copy group, one archive copy group, both, or neither.

A *backup copy group* contains attributes that are used during the backup process to determine:

- How many days must elapse before a file is backed up again.
- How a file is processed during a backup if it is in use.

It also contains attributes to manage the backup versions of your files on the server. These attributes control:

- On which media type the server stores backup versions of your files and directories.
- How many backup versions the server keeps of your files and directories.
- How long the server keeps backup versions of your files and directories.
- How long the server keeps inactive backup versions.
- How long the last remaining inactive version of a file is kept.

An *archive copy group* contains attributes that control:

- Whether a file is archived if it is in use
- On which media type the server stores archived copies of your files
- How long the server keeps archived copies of your files

**Related concepts:**

Select a management class for files  
Retention grace period

## Display information about management classes and copy groups

You can display policy information with the command-line interface or with a graphical user interface.

On a graphical user interface, click **View policy information** from the Utilities menu. The **Policy information** window displays the available management classes. On a command line, use the query *mgmtclass* command to view the available management classes. The *detail* option provides more information.

Table 1 shows the default values for the backup and archive copy groups in the standard management class.

Table 1. Default attribute values in the standard management class

Attribute	Backup default	Archive default
Copy group name	Standard	Standard
Copy type	Backup	Archive
Copy frequency	0 days	CMD (Command)
Versions data exists	Two versions	Does not apply
Versions data deleted	One version	Does not apply
Retain extra versions	30 days	Does not apply
Retain only version	60 days	Does not apply
Copy serialization	Shared static	Shared static
Copy mode	Modified	Absolute
Copy destination	Backuppool	Archivepool
Retain versions	Does not apply	365 days

Attribute	Backup default	Archive default
Lan free	Destination	No
Deduplication enabled	No	No

- Copy group name attribute  
The *copy group name* attribute is the name of the copy group. The default value for both backup and archive is *standard*.
- Copy type attribute  
The *copy type* attribute is the type of the copy group. The value for backup is always *backup*, and the value for archive is always *archive*.
- Copy frequency attribute  
The *copy frequency* attribute is the minimum number of days that must elapse between successive incremental backups. Use this attribute during a full incremental backup.
- Versions data exists attribute  
The *versions data exists* attribute specifies the maximum number of different backup versions retained for files and directories.
- Versions data deleted attribute  
The *versions data deleted* attribute specifies the maximum number of different backup versions retained for files and directories that you deleted.
- Retain extra versions attribute  
The *retain extra versions* attribute specifies how many days all but the most recent backup version is retained.
- Retain only version attribute  
The *retain only version* attribute specifies the number of days the last remaining inactive version of a file or directory is retained.
- Copy serialization attribute  
The copy serialization attribute determines whether a file can be in use during a backup or archive, and what to do if it is.
- Copy mode parameter  
The copy mode parameter determines whether a file or directory is considered for incremental backup regardless of whether it changed or not since the last backup.
- Copy destination attribute  
The *copy destination* attribute names the destination where backups or archives are stored.
- Retain versions attribute  
The *retain versions* attribute specifies the number of days an archived file remains in storage.
- Deduplicate data attribute  
The *deduplicate data* attribute specifies whether redundant data is transferred to the IBM Spectrum Protect™ server during backup and archive processing.

## Copy group name attribute

---

The *copy group name* attribute is the name of the copy group. The default value for both backup and archive is *standard*.

## Copy type attribute

---

The *copy type* attribute is the type of the copy group. The value for backup is always *backup*, and the value for archive is always *archive*.

## Copy frequency attribute

---

The *copy frequency* attribute is the minimum number of days that must elapse between successive incremental backups. Use this attribute during a full incremental backup.

Copy frequency works with the mode parameter. For example, if *frequency=0* and *mode=modified*, a file or directory is backed up only if it changed since the last incremental backup. If *frequency=0* and *mode=absolute*, an object is backed up every time you run an incremental backup against it. If *frequency=0* and *mode=absolute*, changes and number of days since the last backup do not affect the current backup operation. The frequency attribute is not checked for selective backups.

For archive copy groups, copy frequency is always CMD (command). There is no restriction on how often you archive an object.

**AIX** | **Windows** Copy frequency is ignored during a journal-based backup.

**Windows** Journal-based incremental backup differs from the traditional full incremental backup because IBM Spectrum Protect™ does not enforce non-default copy frequencies (other than 0).

## Versions data exists attribute

---

The *versions data exists* attribute specifies the maximum number of different backup versions retained for files and directories.

If you select a management class that permits more than one backup version, the most recent version is called the *active* version. All other versions are called *inactive* versions. If the maximum number of versions permitted is five, and you run a backup that creates a sixth version, the oldest version is deleted from server storage.

## Versions data deleted attribute

---

The *versions data deleted* attribute specifies the maximum number of different backup versions retained for files and directories that you deleted.

This parameter is ignored until you delete the file or directory.

If you delete the file or directory, the next time you run an incremental backup, the active backup version is changed to inactive. The IBM Spectrum Protect™ server deletes the oldest versions in excess of the number specified by this parameter.

The expiration date for the remaining versions is based on the *retain extra versions* and *retain only version* parameters.

## Retain extra versions attribute

---

The *retain extra versions* attribute specifies how many days all but the most recent backup version is retained.

The most recent version is the active version, and active versions are never erased. If *Nolimit* is specified, then extra versions are kept until the number of backup versions exceeds the *versions data exists* or *versions data deleted* parameter settings. In this case, the oldest extra version is deleted immediately.

## Retain only version attribute

---

The *retain only version* attribute specifies the number of days the last remaining inactive version of a file or directory is retained.

If *Nolimit* is specified, the last version is retained indefinitely.

This parameter goes into effect during the next incremental backup after a file is deleted from the client system. Any subsequent updates to this parameter will not affect files that are already inactive. For example: If this parameter is set to 10 days when a file is inactivated during an incremental backup, the file is deleted from the server in 10 days.

## Copy serialization attribute

---

The copy serialization attribute determines whether a file can be in use during a backup or archive, and what to do if it is.

The value for this attribute can be one of the following:

- **Static.** A file or directory must not be modified during a backup or archive. If the object is changed during a backup or archive attempt, it is not backed up or archived.
- **Shared static.** A file or directory must not be modified during backup or archive. The client attempts to perform a backup or archive as many as four additional times, depending on the value specified on the *changingretries* option in your options file. If the object is changed during every backup or archive attempt, it is not backed up or archived.
- **Dynamic.** A file or directory is backed up or archived on the first attempt regardless of whether it changes during a backup or archive.
- **Shared dynamic.** A file or directory is backed up or archived regardless of whether it changes during a backup or archive. The client attempts to back up or archive as many as four additional times. The number of attempts depend on the value that was specified on the *changingretries* option in your options file, without the file changing during the attempt. The file is backed up or archived on the last try even if it has changed.

If you select a management class that permits a file to be backed up or archived while it is in use, the backup version or archived copy that is stored on the server might be a fuzzy copy. A *fuzzy copy* is a backup version or archived copy that does

not accurately reflect what is currently in the file. It might contain some, but not all, of the changes. If that is not acceptable, select a management class that creates a backup version or archive copy only if the file does not change during a backup or archive. When you use static serialization, applications cannot open a file for write access while the file is being backed up.

If you restore or retrieve a file that contains a fuzzy copy, the file might not be usable. Do not use dynamic or shared dynamic serialization to back up files unless you are certain that a fuzzy copy that is restored is usable.

Important: Be careful when you select a management class containing a copy group that specifies shared dynamic or serialization dynamic backup.

**Related concepts:**

**Windows** Open file support for backup operations

**Related tasks:**

**Windows** Configuring Open File Support

**Related reference:**

Snapshotproviderimage

## Copy mode parameter

---

The copy mode parameter determines whether a file or directory is considered for incremental backup regardless of whether it changed or not since the last backup.

The client does not check the mode parameter when it runs selective backups.

The value for this parameter can be one of the following settings:

modified

The object is considered for incremental backup only if it has changed since the last backup. An object is considered changed if any of the following conditions are true:

- The date or time of the last modification is different.
- The size is different.
- **Windows** The attributes, except for the archive attribute, are different.
- If only the metadata changes (such as access permissions), the client might back up only the metadata.
- **AIX** **Linux** **Solaris** **Mac OS X** The owner is different.

absolute

The object is considered for incremental backup regardless of whether it changed since the last backup. For archive copy groups, the mode is always absolute, indicating that an object is archived regardless of whether it changed since the last archive request.

## Copy destination attribute

---

The *copy destination* attribute names the destination where backups or archives are stored.

The destination can be either a storage pool of disk devices or a storage pool of devices that support removable media, such as tape.

## Retain versions attribute

---

The *retain versions* attribute specifies the number of days an archived file remains in storage.

When the specified number of days elapse for an archived copy of a file, it is deleted from server storage.

## Deduplicate data attribute

---

The *deduplicate data* attribute specifies whether redundant data is transferred to the IBM Spectrum Protect™ server during backup and archive processing.

**Related concepts:**

Client-side data deduplication

**Related reference:**

Deduplication  
Enablededupcache  
Exclude options

## Select a management class for files

---

If the default management class meets the backup and archive requirements for all the files on your workstation, it is not necessary to take any action to associate your files with that management class. This is done automatically when you back up or archive your files.

When selecting a different management class for your files, consider these questions:

- Does the management class contain a backup copy group?

If you attempt to back up a file associated with a management class that does not contain a backup copy group, the file is not backed up.

- Does the management class contain an archive copy group?

You cannot archive a file associated with a management class that does not contain an archive copy group.

- Does the backup copy group contain attributes that back up your files often enough?

Mode and frequency work together to control how often a file is backed up when you use incremental backup. These attributes are not checked for selective backup.

- What serialization method does the copy group use?

The serialization method determines how IBM Spectrum Protect™ functions when a file changes while it is being backed up.

- Does the backup copy group specify an adequate number of backup versions to keep, along with an adequate length of time to keep them?
- Does the archive copy group specify an adequate length of time to keep archived copies of files?

**Related concepts:**

Copy serialization attribute

## Assign a management class to files

---

A management class defines when your files are included in a backup, how long they are kept on the server, and how many versions of the file the server should keep.

The server administrator selects a default management class. You can specify your own management class to override the default management class.

To assign a management class other than the default to directories, use the `dirmc` option in your options file.

You can assign a management class for a file or file group by using an include statement in your options file. You can also assign a management class by using an include statement in include-exclude file specified by the `inclexcl` option. Management class names are not case-sensitive.

Using the command-line client, to associate all files in the `costs` directory with the management class named `budget`, you would enter:

```
AIX | Linux | Solaris | Mac OS X
include /home/proj2/costs/* budget
```

**Windows**

```
include c:\adsm\proj2\costs\* budget
```

To specify a management class named `managall` to use for all files to which you do not explicitly assign a management class, enter the following:

```
AIX | Linux | Solaris | Mac OS X
```

```
include /.../* managall
```

#### Windows

```
include ?:\...*\* managall
```

The following examples show how to assign a management class to files:

#### AIX

#### Linux

#### Solaris

#### Mac OS X

```
exclude /.../*.sno
include /home/winter/.../*.ice      mcweekly
include /home/winter/december/*.ice mcdaily
include /home/winter/january/*.ice  mcmmonthly
include /home/winter/february/white.sno
```

#### Windows

```
exclude ?:\...*\*.sno
include c:\winter\...*\*.ice      mcweekly
include c:\winter\december\*.ice  mcdaily
include c:\winter\january\*.ice   mcmmonthly
include c:\winter\february\white.sno
```

Processing follows these steps:

1. The file `white.sno` in the february directory in the winter directory is backed up following bottom-up processing rules. Because you did not specify a management class on this statement, the file is assigned to the default management class.
2. Any file with an extension of `ice` in the january directory is assigned to the management class named `mcmmonthly`.
3. Any file with an extension of `ice` in the december directory is assigned to the management class named `mcdaily`.
4. Any other files with an extension of `ice` in any directory under the winter directory are assigned to the management class named `mcweekly`.
5. Any file with an extension of `sno` in any directory is excluded from backup. The exception to this rule is `white.sno` in the february directory, which is in the winter directory.

To specify your own default management class `mgmt_class_name` for files that are not explicitly included, put the following statement at the top of your include list:

#### AIX

#### Linux

#### Solaris

#### Mac OS X

```
include /.../* mgmt_class_name
```

#### Windows

```
include ?:\...*\* mgmt_class_name
```

#### AIX

#### Linux

#### Solaris

#### Mac OS X

When you archive a file using the graphical user interface, you can select a different management class to override the management class assigned to the file.

#### Related reference:

Dirmc

Include options

## Override the management class for archived files

When you archive a file, you can override the assigned management class using the a graphical user interface (GUI), or by using the `archmc` option on the archive command.

Overriding the management class using the GUI is equivalent to using the `archmc` option on the archive command. To use the GUI, press the **Options** button on the archive tree to override the management class and select a different management class.

On the command line, to associate the file `budget.jan` with the management class **ret2yrs**, enter this command:

#### AIX

#### Linux

#### Solaris

#### Mac OS X

```
dsmc archive -archmc=ret2yrs /home/jones/budget.jan
```

#### Windows

```
dsmc archive -archmc=ret2yrs c:\plan\proj1\budget.jan
```

## Select a management class for directories

---

If the management class in your active policy set containing the longest "Retain only version" (REONLY) setting meets your backup requirements for directories, it might not be necessary to take any action to associate directories with that management class. The management class association is done automatically when it backs up your directories.

If there is more than one management class with the longest REONLY setting, the IBM Spectrum Protect™ client selects the management class whose name is last in alphabetical order.

If the default management class does not meet your requirements, select a management class with an adequate retention period specified by the retain only version parameter. For example, if the management class happens to back up data directly to tape, but you want your directory backups to go to disk, you must choose a different management class. You should keep directories at least as long as you keep the files associated with those directories.

For backup directories, use the `dirmc` option to specify the management class to which directories are bound.

For archive directories, use the `archmc` option with the archive command.

You can use these methods to view the available management classes and their attributes:

- GUI or web client: Select View Policy Information from the Utilities menu.
- Command-line client: Run `dsmc query mgmtclass -detail`.

Note: During expiration processing on the IBM Spectrum Protect server, if an archived directory is eligible for expiration, the server checks if any existing archived files require the archived directory to remain. If so, the archived directory is not expired and the backup-archive client updates the insert date on the archived directory to ensure that the directory is not expired before the files under it.

## Bind management classes to files

---

*Binding* associates a file with a management class.

When you back up a file for the first time, IBM Spectrum Protect™ binds it to either the default management class or the management class specified in your include-exclude list.

If the backup copy group for the management class specifies keeping multiple backup versions of the file, and you request multiple backups, the server always has one active backup version (the current version) and one or more inactive backup versions of the file. All backup versions of a file are bound to the same management class and are managed based on the attributes in the backup copy group.

When you archive a file for the first time, IBM Spectrum Protect binds it to the default management class, to the management class specified in your include-exclude list, or to a management class you specify when modifying your archive options during an archive.

Archived files are never rebound to a different management class. If you change the management class for a file using an `include.archive` statement, the `archmc` option, or through the backup-archive client GUI, any previous copies of the file that you archived remain bound to the management class specified when you archived them.

If a file is deleted on the client system then that inactive objects of the file are not rebound.

For information about how to associate files and directories with management classes, see the IBM Spectrum Protect server documentation.

## Rebind backup versions of files

---

*Rebinding* associates a file or a logical volume image with a new management class.

Backups of files are bound again to a different management class in the following conditions. In each condition, the files (active and inactive) are not bound again until the next backup.

- You specify a different management class in an Include statement to change the management class for the file. The backups are managed based on the old management class until you run another backup.

- Your administrator deletes the management class from your active policy set. The default management class is used to manage the backup versions when you back up the file again.
- Your administrator assigns your client node to a different policy domain and the active policy set in that domain does not have a management class with the same name. The default management class for the new policy domain is used to manage the backup versions.

For information about how to associate files and directories with management classes, see the IBM Spectrum Protect™ server documentation.

## Retention grace period

---

IBM Spectrum Protect™ also provides a *backup retention grace period* and an *archive retention grace period* to help protect your backup and archive data when it is unable to rebind a file to an appropriate management class.

The backup retention grace period is in the following cases:

- You change the management class for a file, but neither the default management class nor the new management class contain a backup copy group.
- The management class to which a file is bound no longer exists, and the default management class does not contain a backup copy group.

The backup retention grace period, defined in your policy domain, starts when you run an incremental backup. The default is 30 days. However, your administrator can lengthen or shorten this period.

When the IBM Spectrum Protect server manages a file using the backup retention grace period, it does not create any new backup versions of the file. All existing backup versions of the file expire 30 days (or the number of days specified in your policy domain) from the day they are marked inactive.

Archive copies are never rebound because each archive operation creates a different archive copy. Archive copies remain bound to the management class name specified when the user archived them. If the management class to which an archive copy is bound no longer exists or no longer contains an archive copy group, the server uses the default management class. If you later change or replace the default management class, the server uses the updated default management class to manage the archive copy. If the default management class does not contain an archive copy group, the server uses the archive retention grace period specified for the policy domain.

## Event-based policy retention protection

---

All management classes with an archive copy group must specify a retention period, for example, the number of days that an archived object is stored on the server before being deleted.

Event-based policy provides the option of beginning the retention period either at the time the object is archived or at a later date when an activation event is sent to the server for that object.

Setting the copy group value `RETINIT=CREATE` starts the data retention period when the file is archived. Using the copy group value `RETINIT=EVENT` starts the data retention period when the server is notified that the event has occurred.

The following example demonstrates this concept:

The user has two files, `create.file` and `event.file`. The user has available two management classes; `CREATE`, with `RETINIT=CREATE`, and `EVENT`, with `RETINIT=EVENT`. Both management classes have a 60-day retention period. The user, on the same day, archives both files:

```
dsmc archive create.file -archmc=CREATE
dsmc archive event.file -archmc=EVENT
```

Ten days later, the user issues the set event `-type=hold` command for the `create.file` file, so the file cannot be deleted. On the same day the user issues the set event `-type=activate` for the `event.file` file. At this time, `create.file` has 50 days left on its retention period, and `event.file` has 60 days. If no other action is taken, `create.file` remains on the server forever, and `event.file` is expired 70 days after it was created (60 days after its event occurred). However, if 20 days after the initial archive, the user issues set event `-type=release` for the `create.file` file. Thirty days of its retention period have passed, so the file is expired in 30 days (the hold does not extend the retention period).

For information about the `RETINIT` copy group value, see the IBM Spectrum Protect™ server documentation.



- Archive files on a data retention server  
Up to this point, there is no difference between archiving files on a normal server or a data retention server.

**Related reference:**  
Set Event

## Backup-archive client options and commands

---

Use the client options to tailor backup-archive client processing to meet your needs. Use the client command-line interface (CLI) as an alternative to the graphical user interface (GUI). Reference information for the client options, commands, and other supplemental information is provided.

- Reading syntax diagrams  
To read a syntax diagram for entering a command, follow the path of the line. Read from left to right and from top to bottom.
- Processing options  
You can use defaults for processing client options or you can tailor the processing options to meet your specific needs. Read about an overview of processing options and explore the options reference that provides detailed information about each option.
- Using commands  
The backup-archive client provides a command-line interface (CLI) that you can use as an alternative to the graphical user interface (GUI). This topic describes how to start or end a client command session and how to enter commands.
- **Windows** IBM Spectrum Protect Client Service Configuration Utility  
The following client services can be installed when you install the backup-archive client, or when you use the IBM Spectrum Protect Client Service Configuration Utility after the backup-archive client is installed:

**Related concepts:**

Installing the IBM Spectrum Protect backup-archive clients (UNIX, Linux, and Windows)

**Related tasks:**

Configuring backup-archive clients

Back up and restore data with backup-archive clients

Archive and retrieve data with backup-archive clients

## Reading syntax diagrams

---

To read a syntax diagram for entering a command, follow the path of the line. Read from left to right and from top to bottom.

- The ►►—— symbol indicates the beginning of a syntax diagram.
- The ——► symbol at the end of a line indicates that the syntax diagram continues on the next line.
- The ►—— symbol at the beginning of a line indicates that a syntax diagram continues from the previous line.
- The ——►◀ symbol indicates the end of a syntax diagram.

Syntax items, such as a keyword or a variable, can be:

- On the line (required element)
- Above the line (default element)
- Below the line (optional element)

## Symbols

---

Enter these symbols *exactly* as they appear in the syntax diagram.

- \* Asterisk
- {} Braces
- : Colon
- , Comma
- = Equal Sign
- - Hyphen
- () Parentheses
- . Period
- Space
- " quotation mark

- 'single quotation mark

## Variables

---

Italicized lowercase items such as `<var_name>` indicate variables. In this example, you can specify a `<var_name>` when you enter the `cmd_name` command.

```
>>-cmd_name--<var_name>-----><
```

## Repetition

---

An arrow returning to the left means that the item can be repeated. A character within the arrow means that you must separate repeated items with that character.

```

. ,-----
v |
>>--repeat-+-----><

```

A footnote (1) by the arrow refers to a limit that tells how many times the item can be repeated.

```

. ,-----
v (1) |
>>-----repeat-+-----><

```

Notes:

1. Specify repeat up to 5 times.

## Required choices

---

When two or more items are in a stack and one of them is on the line, you *must* specify one item.

In this example, you must choose A, B, or C.

```
>>-cmd_name--+A+-----><
                +-B-+
                '-C-'
```

## Optional choices

---

When an item is *below* the line, that item is optional. In the first example, you can select A or nothing at all.

```
>>-cmd_name--+---+-----><
                '-A-'
```

When two or more items are in a stack below the line, all of them are optional. In the second example, you can choose A, B, C, or nothing at all.

```
>>-cmd_name--+---+-----><
                +-A-+
                +-B-+
                '-C-'
```

## Repeatable choices

---

A stack of items followed by an arrow returning to the left indicates that you can select more than one item, or in some cases, repeat a single item.

In this example, you can select any combination of A, B, or C.

```
      . -A- .  
      V     |  
>>-cmd_name-----+-----><  
                    +-B-+  
                    '-C-'
```

## Defaults

---

Defaults are above the line. The default is selected unless you override it, or you can select the default explicitly. To override the default, include an option from the stack below the line.

In this example, A is the default. Select either B or C to override A.

```
      . -A- .  
>>-cmd_name-----+-----><  
                    +-B-+  
                    '-C-'
```

## Processing options

---

You can use defaults for processing client options or you can tailor the processing options to meet your specific needs. Read about an overview of processing options and explore the options reference that provides detailed information about each option.

- Processing options overview  
IBM Spectrum Protect™ uses *processing options* to control communications, backup-archive processing, and other types of processing.
- Communication options  
You use communication options to specify how your client node communicates with the IBM Spectrum Protect server. This topic provides information about the types of communication options you can use.
- |     |       |          |         |
|-----|-------|----------|---------|
| AIX | Linux | Mac OS X | Solaris |
|-----|-------|----------|---------|

 Server options  
Use the servername option in your dsm.sys file to begin a group of options (stanzas) used to connect to the IBM Spectrum Protect server.
- Backup and archive processing options  
You can specify client options to control some aspects of backup and archive processing.
- Restore and retrieve processing options  
You can use client options to control some aspects of restore and retrieve processing.
- Scheduling options  
This topic discusses the options that you can use to regulate central scheduling. The backup-archive client uses scheduling options only when the Scheduler is running.
- Format and language options  
Format and language options allow you to select different formats for date, time and numbers for different languages.
- Command processing options  
This topic explains the options that you can use with the backup-archive client commands.
- Authorization options  
Authorization options control access to the IBM Spectrum Protect server.
- Error processing options  
Error processing options specify the name of the error log file and how the backup-archive client treats the entries in the log file.
- Transaction processing options  
Transaction processing options control how transactions are processed between the IBM Spectrum Protect client and server.
- Web client options  
Several backup-archive client options are used to configure the IBM Spectrum Protect web client.
- Using options with commands  
You can override some of the options in your client options file (dsm.opt) file by entering them with appropriate backup-archive client commands.
- Client options reference  
The following sections contain detailed information about each of the IBM Spectrum Protect processing options.

**Related concepts:**

Using options with commands

**Related reference:**

Reading syntax diagrams

## Processing options overview

---

IBM Spectrum Protect™ uses *processing options* to control communications, backup-archive processing, and other types of processing.

**Windows** You can specify processing options in the client options file (dsm.opt) or on the command line.

**AIX** **Linux** **Solaris** **Mac OS X** You can specify processing options in the client system-options file (dsm.sys), client user-options file (dsm.opt), or on the command line.

You can set the following types of options:

- Communication options
- **Windows** Node options
- **AIX** **Linux** **Solaris** **Mac OS X** Server and node options
- Backup and archive processing options
- Restore and retrieve processing options
- Scheduling options
- **Windows** Format and language options
- **AIX** **Linux** **Solaris** **Mac OS X** Format options
- Command processing options
- Authorization options
- Error processing options
- Transaction processing option
- Web client options
- Diagnostics options

The backup-archive client also includes a group of client command options that you can enter only on the command line with specific commands. You can override some of the options in your options file by entering them with appropriate backup-archive commands.

**Windows** Note: Some of the processing options that are used by the IBM Spectrum Protect central scheduler are defined in the Windows registry when the schedule services are configured. These options can also be specified in the client options file. When the scheduler runs as a service, processing options that are specified in the registry override the same options that are specified in the client options file.

**Related concepts:**

Entering options with a command

**Related tasks:**

**Mac OS X** **AIX** **Linux** **Solaris** **Mac OS X** Creating and modifying the client system-options file

**Windows** Creating and modifying the client options file

## Communication options

---

You use communication options to specify how your client node communicates with the IBM Spectrum Protect™ server. This topic provides information about the types of communication options you can use.

**AIX** **Linux** **Mac OS X** **Solaris** For UNIX and Linux use one of the following communication protocols:

- TCP/IP
- **AIX** **Linux** Shared memory (AIX®, Linux)

**Windows** For all Windows clients, use one of the following protocols:

**Windows**

- TCP/IP
- Named pipes
- Shared memory

**AIX** | **Linux** | **Solaris** | **Mac OS X** | **Windows** Use the commmethod option to specify the communication protocol.

Ask your IBM Spectrum Protect administrator for assistance in setting your communication options.

- TCP/IP options  
To use the TCP/IP communication protocol, you must include the tcpserveraddress option in your client options file.
- **Windows** Named Pipes option  
This topic provides information about the namedpipename communication option.
- **AIX** | **Linux** | **Solaris** | **Mac OS X** | **Windows** Shared memory options  
This topic provides information on the shared memory options that you can use.

**Related reference:**  
Commmethod

## TCP/IP options

To use the TCP/IP communication protocol, you must include the tcpserveraddress option in your client options file.

The other TCP/IP options have default values that you can modify if you want to change the default value. This topic provides information about the types of communication options you can use.

Table 1. TCP/IP options

Option	Description
httpport	Specifies a TCP/IP port address for the web client.
lanfreetcpport	Specifies the TCP/IP port number where the IBM Spectrum Protect™ storage agent is listening.
lanfreetcpserveraddress	Specifies the TCP/IP address for the IBM Spectrum Protect storage agent.
tcpbuffsize	Specifies the size, in kilobytes, of the internal TCP/IP communication buffer.
<b>Windows</b> tcpnodelay	<b>Windows</b> Specifies whether the server or client disables the delay of sending successive small packets on the network.
<b>AIX</b>   <b>Linux</b>   <b>Solaris</b>   <b>Mac OS X</b> tcpnodelay	<b>AIX</b>   <b>Linux</b>   <b>Solaris</b>   <b>Mac OS X</b> Specifies whether the server or client disables the delay of sending successive small packets on the network. This option is for all UNIX clients.
tcpadminport	Specifies a separate TCP/IP port number on which the server is waiting for requests for administrative client sessions, allowing secure administrative sessions within a private network.
tcpcadaddress	Specifies a TCP/IP address for dsmdad.
tcpport	Specifies the TCP/IP port address for an IBM Spectrum Protect server.
tcpserveraddress	Specifies the TCP/IP address for an IBM Spectrum Protect server.
tcpwindowsize	Specifies the size, in kilobytes, of the TCP/IP sliding window for your client node.
<b>AIX</b>   <b>Linux</b>   <b>Solaris</b>   <b>Mac OS X</b> webports	<b>AIX</b>   <b>Linux</b>   <b>Solaris</b>   <b>Mac OS X</b> Enables the use of the web client outside a firewall by specifying the TCP/IP port number used by the client acceptor daemon and the web client agent service (web client agent service does not apply to Mac OS X) for communications with the web GUI.
<b>Windows</b> webports	<b>Windows</b> Enables the use of the web client outside a firewall by specifying the TCP/IP port number used by the client acceptor service and the web client agent service for communications with the web GUI.

**Related reference:**  
Nfstimeout  
**Windows**

## Named Pipes option

This topic provides information about the namedpipename communication option.

Table 1. Named Pipes communication option

Option	Description
namedpipename Namedpipename	Specifies the name of a named pipe to use for communications between a client and IBM Spectrum Protect™ server on the same Windows server domain.

AIX Linux Solaris Mac OS X Windows

## Shared memory options

This topic provides information on the shared memory options that you can use.

Table 1. Shared memory communication options

Option	Description
lanfreeshmport Lanfreeshmport	Specifies the unique number that is used by the client and the storage agent to identify shared memory area used for communications.
lanfreeshmport Shmport	Specifies the unique number that is used by the client and the server to identify shared memory area used for communications.

AIX Linux Solaris Mac OS X

## Server options

Use the servername option in your dsm.sys file to begin a group of options (stanzas) used to connect to the IBM Spectrum Protect™ server.

You can set up multiple groups of stanzas in the dsm.sys file to connect to different servers. Each servername stanza must have listed below it all client option stanzas required to establish communication with a server. The stanza list can also contain other options for backup-archive operations.

*If your client system-options file contains only one stanza* - Your client node contacts the server you specify in that stanza for all services.

*If your client system-options file contains more than one stanza* - You can specify a default server with the defaultserver option. If you do not specify a default server, IBM Spectrum Protect contacts the server you specify in the first stanza of your dsm.sys file.

Place the defaultserver option at the beginning of your dsm.sys file before any server stanzas. See Defaultserver for more information.

Use the servername option in the client user-options file (dsm.opt) or on the command line to specify a server to contact for backup-archive services. This overrides the default server specified in your (dsm.sys) file.

**Note:** You cannot override the migration server specified in the client system-options file.

Table 1 shows a sample dsm.sys file.

Table 1. Sample client system-options file

<b>Sample dsm.sys file</b>
----------------------------

Sample dsm.sys file	
DEFAULTServer	server2
SERvername	server1
NODename	node1
COMMMethod	TCPip
TCPPort	1500
TCPServeraddress	node.domain.company.com
PASSWORDAccess	generate
GROups	system adsm
USERS	ashton stewart kaitlin
INCLExcl	/adm/adsm/backup1.excl
SERvername	server2
COMMMethod	SHAREdmem
shmpoort	1520
PASSWORDAccess	prompt
GROups	system adsm
USERS	danielle derek brant
INCLExcl	/adm/adsm/backup2.excl

## Backup and archive processing options

You can specify client options to control some aspects of backup and archive processing.

Table 1. Backup and archive processing options

Option	Description
<b>AIX</b>   <b>Linux</b> afmskipuncachedfiles	<b>AIX</b>   <b>Linux</b> Use the afmskipuncachedfiles option to specify whether uncached and dirty files in General Parallel File System (GPFS™) Active File Management file sets are processed for backup, archive, and migration operations.
archmc	Use the archmc option with the archive command to specify the available management class for your policy domain to which you want to bind your archived files.
<b>AIX</b>   <b>Linux</b>   <b>Solaris</b>   <b>Mac OS X</b> archsymlinkasfile	<b>AIX</b>   <b>Linux</b>   <b>Solaris</b>   <b>Mac OS X</b> Specifies whether you want the client to follow a symbolic link and archive the file or directory to which it points, or archive the symbolic link only.
asnodename	Use the asnodename option to allow agent nodes to back up or restore data on behalf of another node (the target node). This option enables concurrent operations from multiple nodes to store data to the same target node and file space in parallel.
<b>AIX</b>   <b>Linux</b>   <b>Solaris</b>   <b>Mac OS X</b> automount	<b>AIX</b>   <b>Linux</b>   <b>Solaris</b>   <b>Mac OS X</b> Use this option with the domain option to specify all automounted file systems that the client tries to mount at the following points in time: <ul style="list-style-type: none"> <li>• When the backup-archive client starts</li> <li>• When the backup is started</li> <li>• When the backup-archive client reaches an automounted file system during backup</li> </ul>
autofsrename	Specifies whether to rename an existing file space on a Unicode-enabled server so a Unicode-enabled file space can be created for the current operation.
<b>Windows</b> backmc	<b>Windows</b> Specifies the management class to apply to the backup fastback subcommand for retention purposes.

Option	Description
changingretries	Specifies the number of times the client attempts to back up or archive a file that is in use.
<b>Windows</b> class	<b>Windows</b> Specifies whether to list the NAS or client Application Server objects during a query backup, query filesystem, or delete filesystem operation.
compressalways	The compressalways option specifies whether to continue compressing an object if it grows during compression. Use this option with the compression option.
compression	The compression option compresses files before you send them to the server. Compressing your files reduces data storage for backup versions and archive copies of your files.
<b>AIX</b>   <b>Linux</b>   <b>Windows</b> createnewbase Createnewbase	<b>AIX</b>   <b>Linux</b>   <b>Windows</b> The createnewbase option creates a base snapshot and uses it as a source to run a full incremental. Setting this option ensures the backup of any files that might have been skipped during the snapshot difference incremental.
deduplication Deduplication	Specifies whether to eliminate redundant data on the client side when the client transfers data to the IBM Spectrum Protect server during backup or archive processing.
dedupcachepath Dedupcachepath	Specifies the location where the client-side data deduplication cache database is created, if the enablededupcache=yes option is set during backup or archive processing.
dedupcachesize Dedupcachesize	Determines the maximum size of the data deduplication cache file.
enablededupcache Enablededupcache	Specifies whether you want to enable client-side data deduplication cache, so that the backup-archive client gets the changed data from the cache.
deletefiles	Use the deletefiles option with the archive command to delete files from your workstation after you archive them.  <b>AIX</b>   <b>Linux</b>   <b>Solaris</b>   <b>Windows</b> You can also use this option with the restore image command and the incremental option to delete files from the restored image if they were deleted after the image was created.
description	The description option assigns or specifies a description for files when the client performs archive, delete, retrieve, query archive, or query backupset operations.
detail	Use the detail option to list management class, file space, backup, and archive information, depending on the command with which it is used.
<b>Linux</b>   <b>AIX</b>   <b>Windows</b> diffsnapshot	<b>Linux</b>   <b>AIX</b>   <b>Windows</b> Use the diffsnapshot option to determine whether the client creates a differential snapshot.
dirmc	Specifies the management class to use for directories. If you do not specify this option, the client uses the management class in the active policy set of your policy domain with the longest retention period.



Option	Description
dirsonly	Backs up, restores, archives, retrieves, or queries directories only.
diskcachelocation	Specifies the location where the disk cache database is created if the option <code>memoryefficient=diskcachemethod</code> option is set during an incremental backup.
<b>AIX</b>   <b>Linux</b>   <b>Solaris</b>   <b>Mac OS X</b> domain	<b>AIX</b>   <b>Linux</b>   <b>Solaris</b>   <b>Mac OS X</b> Specifies the file systems to include in your default client domain for an incremental backup.
<b>Windows</b> domain	<b>Windows</b> Specifies the drives to include in your default client domain for an incremental backup.
<b>AIX</b>   <b>Linux</b>   <b>Solaris</b> domain.image	<b>AIX</b>   <b>Linux</b>   <b>Solaris</b> Specifies the mounted file systems and raw logical volumes that you want to include in your client domain for an image backup. This option is for AIX®, Linux x86_64, Linux on POWER®, and Solaris only.
<b>Windows</b> domain.image	<b>Windows</b> Specifies the file systems and raw logical volumes that you want to include in your client domain for an image backup. This option is valid for Windows clients.
<b>AIX</b>   <b>Solaris</b>   <b>Windows</b> domain.nas	<b>AIX</b>   <b>Solaris</b>   <b>Windows</b> Specifies the volumes to include in your default domain for NAS image backups.
<b>Linux</b>   <b>Windows</b> domain.vmfull Domain.vmfull	<b>Linux</b>   <b>Windows</b> Specifies the virtual machines to include in full image backups of VMware virtual machines.
<b>AIX</b> efsdecrypt	<b>AIX</b> Specifies whether files encrypted by an AIX Encrypted File System (EFS) are read in encrypted or decrypted format.
enablearchiveretentionprotection	Allows the client to connect to a data retention server.
<b>AIX</b>   <b>Linux</b>   <b>Solaris</b>   <b>Windows</b> enablelanfree Enablelanfree	<b>AIX</b>   <b>Linux</b>   <b>Solaris</b>   <b>Windows</b> Specifies whether to enable an available LAN-free path to a storage area network (SAN) attached storage device.
<b>Windows</b> exclude exclude.backup exclude.file exclude.file.backup	<b>Windows</b> Use these options to exclude a file or group of files from backup services.
<b>AIX</b>   <b>Linux</b>   <b>Solaris</b>   <b>Mac OS X</b> exclude exclude.backup exclude.file exclude.file.backup	<b>AIX</b>   <b>Linux</b>   <b>Solaris</b>   <b>Mac OS X</b> Use these options to exclude a file or group of files from backup services and space management services (if the HSM client is installed). The <code>exclude.backup</code> option excludes only files from normal backup, but not from HSM.
encryptiontype	Select AES-256 or AES-128 bit data encryption. AES 256-bit data encryption provides the highest level of data encryption.
encryptkey	Specifies whether to save the encryption key password locally when the client performs a backup-archive operation or whether to prompt for the encryption key password.

Option	Description
exclude.archive	Excludes a file or a group of files that match the pattern from archive services only.
<b>AIX</b>   <b>Linux</b>   <b>Solaris</b>   <b>Mac OS X</b> exclude.attribute.symlink	<b>AIX</b>   <b>Linux</b>   <b>Solaris</b>   <b>Mac OS X</b> Excludes a file or a group of files that are symbolic links or aliases (aliases apply to Mac OS X) from backup processing only.
exclude.compression	Excludes files from compression processing if you set the compression option to yes. This option applies to backups and archives.
exclude.dir	Excludes a directory, its files, and all its subdirectories and their files from backup processing.
exclude.encrypt	Excludes specified files from encryption processing.
<b>AIX</b>   <b>Linux</b>   <b>Solaris</b>   <b>Mac OS X</b> exclude.fs	<b>AIX</b>   <b>Linux</b>   <b>Solaris</b>   <b>Mac OS X</b> Excludes file spaces that match a pattern. This option is valid for all UNIX clients.
<b>AIX</b>   <b>Solaris</b> exclude.fs.nas	<b>AIX</b>   <b>Solaris</b> Excludes file systems on the NAS file server from an image backup when used with the backup nas command. This option is for AIX and Solaris clients only.
<b>Windows</b> exclude.fs.nas	<b>Windows</b> Excludes file systems on the NAS file server from an image backup when used with the backup nas command.
<b>AIX</b>   <b>Linux</b>   <b>Solaris</b> exclude.image	<b>AIX</b>   <b>Linux</b>   <b>Solaris</b> Excludes mounted file systems and raw logical volumes that match the specified pattern from full image backup operations. This option is valid only for AIX, Solaris, and all Linux clients.
<b>Windows</b> exclude.image	<b>Windows</b> Excludes mounted file systems and raw logical volumes that match the specified pattern from full image backup operations. Incremental image backup operations are unaffected by exclude.image.
<b>Linux</b>   <b>Windows</b> fbbranch	<b>Linux</b>   <b>Windows</b> Specifies the branch ID of the remote FastBack server to back up or archive.
<b>Linux</b>   <b>Windows</b> fbclientname	<b>Linux</b>   <b>Windows</b> Specifies the name of one or more FastBack clients to back up from the backup proxy.
<b>Linux</b>   <b>Windows</b> fbpolicyname	<b>Linux</b>   <b>Windows</b> Specifies the name of one or more Tivoli® Storage Manager FastBack policies that you want to back up from the backup proxy.
<b>Linux</b>   <b>Windows</b> fbreposlocation	<b>Linux</b>   <b>Windows</b> Specifies the location of the Tivoli Storage Manager FastBack repository for the IBM Spectrum Protect client proxy to connect to issue MOUNT DUMP, MOUNT ADD, and MOUNT DEL commands.
<b>Linux</b>   <b>Windows</b> fbserver	<b>Linux</b>   <b>Windows</b> Specifies host name of the FastBack server workstation or the FastBack Disaster Recovery Hub workstation that owns the repository that is specified by the fbreposlocation option.
<b>Linux</b>   <b>Windows</b> fbvolumename	<b>Linux</b>   <b>Windows</b> Specifies the name of one or more Tivoli Storage Manager FastBack volumes to back up from the backup proxy.

Option	Description
filelist	Specifies a list of files to be processed for the command. The client opens the designated file list and processes the files that are listed within according to the command.
filesonly	Backs up, restores, retrieves, or queries files only.
groupname	Use this option with the backup group command to specify the fully qualified name of the group leader for a group.
ieobjtype Ieobjtype	Specifies an object type for a client-side data deduplication operation. This option is used with the include.dedup and exclude.dedup options.
<b>AIX</b> imagegapsize	<b>AIX</b> Specifies the minimum size of empty regions on a volume that you want to skip during image backup. This option is valid for AIX JFS2 clients.
<b>Windows</b> imagegapsize	<b>Windows</b> Specifies the minimum size of empty regions on a volume that you want to skip during backup. This option is valid for all Windows clients.
incllexcl	Specifies the path and file name of an include-exclude options file.
include include.backup include.file	Use these options to include files or assign management classes for backup processing.
include.archive	Includes files or assigns management classes for archive processing.
<b>AIX</b>   <b>Linux</b>   <b>Solaris</b>   <b>Mac OS X</b> include.attribute.symlink	<b>AIX</b>   <b>Linux</b>   <b>Solaris</b>   <b>Mac OS X</b> Includes a file or a group of files that are symbolic links or aliases (aliases apply to Mac OS X) within broad group of excluded files for backup processing only.
include.compression	Includes files for compression processing if you set the compression option to yes. This option applies to backups and archives.
include.encrypt	Includes the specified files for encryption processing. By default, the client does not perform encryption processing.
<b>AIX</b>   <b>Linux</b>   <b>Solaris</b>   <b>Mac OS X</b> include.fs	<b>AIX</b>   <b>Linux</b>   <b>Solaris</b>   <b>Mac OS X</b> Use the include.fs option to control how the client processes your file space for incremental backup.
<b>Windows</b> include.fs	<b>Windows</b> Use the include.fs option to specify processing options for a file system. Use the include.fs option to specify which drives use open file support and to control how full file space incremental backups are processed.
<b>AIX</b>   <b>Solaris</b> include.fs.nas	<b>AIX</b>   <b>Solaris</b> Use the include.fs.nas option to bind a management class to Network Attached Storage (NAS) file systems. You can also specify whether the client saves Table of Contents (TOC) information during a NAS file system image backup by using the toc option with the include.fs.nas option in your dsm.sys file. For more information, see Toc. This option is valid for AIX and Solaris clients only.

Option	Description
<p><b>Windows</b></p> <p>include.fs.nas</p>	<p><b>Windows</b> Use the include.fs.nas option to bind a management class to Network Attached Storage (NAS) file systems. You can also specify whether the client saves Table of Contents (TOC) information during a NAS file system image backup, by using the toc option with the include.fs.nas option in your client options file (dsm.opt). For more information, see Toc.</p>
<p><b>AIX</b>   <b>Linux</b>   <b>Solaris</b></p> <p>include.image</p>	<p><b>AIX</b>   <b>Linux</b>   <b>Solaris</b> Specifies a file system or logical volume to be included for image backup processing. This option also provides a way to specify an explicit management class assignment for a specified file system or logical volume. The backup image command ignores all other include options. This option is valid for AIX, Solaris, and all Linux clients.</p>
<p><b>Windows</b></p> <p>include.image</p>	<p><b>Windows</b> Specifies a file system or logical volume to be included for image backup processing. This option also provides a way to specify an explicit management class assignment for a specified file system or logical volume. The backup image command ignores all other include options. Use the include.fs option to specify which drives use open file support and to control how full file space incremental backups are processed.</p>
<p><b>Windows</b></p> <p>include.systemstate</p>	<p><b>Windows</b> Assigns management classes for backup of the Windows system state. The default is to bind the system object to the default management class.</p>
<p>incrbydate</p>	<p>Use with the incremental command to request an incremental backup by date.</p>
<p><b>AIX</b>   <b>Linux</b>   <b>Solaris</b></p> <p>incremental</p>	<p><b>AIX</b>   <b>Linux</b>   <b>Solaris</b> Use with the restore image command to ensure that any changes that were made to the base image are also applied to the restored image. This option is valid for AIX, Solaris, and all Linux clients.</p>
<p><b>Windows</b></p> <p>incremental</p>	<p><b>Windows</b> Use with the restore image command to ensure that any changes that were made to the base image are also applied to the restored image.</p>
<p><b>Windows</b></p> <p>incrthreshold</p>	<p><b>Windows</b> The incrthreshold option specifies the threshold value for the number of directories in any journaled file space that might have active objects on the server, but no equivalent object on the workstation.</p>
<p>memoryefficientbackup</p>	<p>Specifies a memory-saving backup algorithm for incremental backups when used with the incremental command.</p>

Option	Description
mode	<p>Use the mode option with these commands, as follows:</p> <p><b>AIX</b>   <b>Linux</b>   <b>Solaris</b>   <b>Windows</b> backup image  <b>AIX</b>   <b>Linux</b>   <b>Solaris</b>   <b>Windows</b> To specify whether to perform a selective or incremental image backup of client file systems.</p> <p><b>AIX</b>   <b>Solaris</b>   <b>Windows</b> backup nas  <b>AIX</b>   <b>Solaris</b>   <b>Windows</b> To specify whether to perform a full or differential image backup of NAS file systems.</p> <p>backup group  To specify whether to perform a full or differential group backup that contains a list of files from one or more file space origins.</p> <p><b>Linux</b> backup vm  <b>Linux</b> To specify whether to perform a selective or incremental backup of VMware systems.</p> <p><b>Windows</b> backup vm  <b>Windows</b> To specify whether to perform a full or incremental backup of a VMware virtual machine when vmbackuptype=fullvm, and when you have installed IBM Spectrum Protect for Virtual Environments.</p>
<p><b>AIX</b>   <b>Solaris</b>   <b>Windows</b></p> monitor	<p><b>AIX</b>   <b>Solaris</b>   <b>Windows</b> Specifies whether you want to monitor an image backup of file systems that belong to a Network Attached Storage (NAS) file server.</p>
<p><b>Mac OS X</b></p> noprompt	<p><b>Mac OS X</b> Suppresses the confirmation prompt that is presented by the delete group, delete archive, expire, and set event commands.</p>
<p><b>AIX</b>   <b>Linux</b>   <b>Solaris</b>   <b>Windows</b></p> noprompt	<p><b>AIX</b>   <b>Linux</b>   <b>Solaris</b>   <b>Windows</b> Suppresses the confirmation prompt that is presented by the delete group, delete archive, expire, restore image, and set event commands.</p>
<p><b>AIX</b>   <b>Linux</b></p> nojournal	<p><b>AIX</b>   <b>Linux</b> Use this option with the incremental command to specify that you want to perform the traditional full incremental backup, instead of the default journal-based backup.</p>
<p><b>Windows</b></p> nojournal	<p><b>Windows</b> Use this option with the incremental command to specify that you want to perform the traditional full incremental backup, instead of the default journal-based backup.</p>
<p><b>Windows</b></p> optfile	<p><b>Windows</b> Specifies the client options file you want to use when you start a backup-archive client session.</p>
<p><b>AIX</b>   <b>Linux</b>   <b>Solaris</b>   <b>Mac OS X</b></p> optfile	<p><b>AIX</b>   <b>Linux</b>   <b>Solaris</b>   <b>Mac OS X</b> Specifies the client user-options file that you want to use when you start a backup-archive client session.</p>
<p><b>AIX</b>   <b>Linux</b></p> postsnapshotcmd	<p><b>AIX</b>   <b>Linux</b> During a snapshot-based backup, this option allows you to manually open an application after the snapshot is created. This option is valid only for AIX JFS2 or Linux LVM snapshot-based operations.</p>

Option	Description
<p><b>Windows</b></p> <p>postsnapshotcmd</p>	<p><b>Windows</b> During an online image backup or open file support operation, this option allows you to manually open an application after the snapshot provider starts a snapshot. This option is only valid if the OFS or online image support is enabled.</p>
<p><b>AIX   Linux   Solaris   Windows</b></p> <p>preservelastaccessdate</p>	<p><b>AIX   Linux   Solaris   Windows</b> Use this option during a backup or archive operation to specify whether to reset the last access date of any specified files to their original value after a backup or archive operation. By default, the client does not reset the last access date of any backed up or archived files to their original value before the backup or archive operation.</p>
<p><b>AIX   Linux</b></p> <p>presnapshotcmd</p>	<p><b>AIX   Linux</b> During a snapshot-based backup operation, this option allows you to manually quiesce an application before the snapshot is created. This option is valid only for AIX JFS2 or Linux LVM snapshot-based operations.</p>
<p><b>Windows</b></p> <p>presnapshotcmd</p>	<p><b>Windows</b> During an online image backup or open file support operation, this option allows you to manually quiesce an application before the snapshot provider starts a snapshot. This option is only valid if the OFS or online image support is enabled.</p>
<p><b>AIX   Linux   Solaris   Mac OS X</b></p> <p>removeoperandlimit</p>	<p><b>AIX   Linux   Solaris   Mac OS X</b> Specifies that the client removes the 20-operand limit. If you specify the removeoperandlimit option with the incremental, selective, or archive commands, the 20-operand limit is not enforced and is restricted only by available resources or other operating system limits.</p>
<p><b>Windows</b></p> <p>resetarchiveattribute</p>	<p><b>Windows</b> Specifies whether the client resets the Windows archive attribute on files that are successfully backed up to the IBM Spectrum Protect server. This option is valid for all Windows clients.</p>
<p><b>AIX   Linux   Solaris   Mac OS X</b></p> <p>skipacl</p>	<p><b>AIX   Linux   Solaris   Mac OS X</b> Specifies whether to skip ACL processing completely.</p>
<p><b>AIX   Linux   Solaris   Mac OS X</b></p> <p>skipaclupdatecheck</p>	<p><b>AIX   Linux   Solaris   Mac OS X</b> Specifies whether to perform checksum and size comparisons before and after backup and during incremental processing.</p>
<p><b>Windows</b></p> <p>skipntpermissions</p>	<p><b>Windows</b> Specifies whether to back up, archive, retrieve, or restore Windows security information.</p>
<p><b>Windows</b></p> <p>skipntsecuritycrc</p>	<p><b>Windows</b> Specifies whether to compute the security CRC for permission comparison during subsequent backups. Use this option on all Windows clients.</p>
<p><b>AIX   Linux   Windows</b></p> <p>snapdiff</p>	<p><b>AIX   Linux   Windows</b> Specifies an incremental backup of the files reported as changed by NetApp, instead of scanning the volume and looking for files that have changed. Use this option with a NAS full volume incremental backup.</p>

Option	Description
<p><b>AIX</b>   <b>Linux</b></p> <p>snapshotcachesize</p>	<p><b>AIX</b>   <b>Linux</b>   <b>Linux</b> and AIX only: Use this option to specify an appropriate snapshot size so that all original data blocks can be stored during file modification and deletion. A snapshot size of 100 percent ensures a valid snapshot. The default value is 100 percent.</p>
<p><b>AIX</b></p> <p>snapshotproviderfs</p>	<p><b>AIX</b> Use the snapshotproviderfs option to enable snapshot-based file backup and archive operations, and to specify a snapshot provider. You must be a root user to perform a snapshot-based file backup or archive operation. If you are not a root user, the operation fails with an error message.</p>
<p><b>Windows</b></p> <p>snapshotproviderfs</p>	<p><b>Windows</b> Use the snapshotproviderfs option to enable snapshot-based file backup and archive operations, and to specify a snapshot provider.</p>
<p><b>AIX</b>   <b>Linux</b>   <b>Solaris</b></p> <p>snapshotproviderimage</p>	<p><b>AIX</b>   <b>Linux</b>   <b>Solaris</b> Use the snapshotproviderimage option to enable snapshot-based image backup, and to specify a snapshot provider. You must be a root user to perform a snapshot-based image backup operation. If you are not a root user, the operation fails with an error message.</p>
<p><b>Windows</b></p> <p>snapshotproviderimage</p>	<p><b>Windows</b> Use the snapshotproviderimage option to enable snapshot-based online image backup, and to specify a snapshot provider.</p>
<p><b>Windows</b></p> <p>snapshotroot</p>	<p><b>Windows</b> Use the snapshotroot option with the incremental, selective, or archive commands with an independent software vendor application that provides a snapshot of a logical volume, to associate the data on the local snapshot with the real file space data that is stored on the IBM Spectrum Protect server.</p>
<p><b>AIX</b>   <b>Linux</b>   <b>Solaris</b>   <b>Mac OS X</b></p> <p>snapshotroot</p>	<p><b>AIX</b>   <b>Linux</b>   <b>Solaris</b>   <b>Mac OS X</b> Use the snapshotroot option with the incremental, selective, or archive commands with an independent software vendor application that provides a snapshot of a logical volume, to associate the data on the local snapshot with the real file space data that is stored on the IBM Spectrum Protect server. This option is valid for all UNIX and Linux clients.</p>
<p>subdir</p>	<p>Specifies whether to include subdirectories of a named directory.</p>
<p>tapeprompt</p>	<p>Specifies whether you want the client to wait for a tape mount if it is required for a backup, archive, restore, or retrieve process, or to be prompted for a choice.</p>
<p><b>AIX</b>   <b>Solaris</b>   <b>Windows</b></p> <p>toc</p>	<p><b>AIX</b>   <b>Solaris</b>   <b>Windows</b> Use the toc option with the backup nas command or the include.fs.nas option to specify whether the client saves Table of Contents (TOC) information for each file system backup. If you save TOC information, you can use the QUERY TOC server command to determine the contents of a file system backup with the RESTORE NODE server command to restore individual files or directory trees. You can also use the web client to examine the entire file system tree and select files and directories to restore.</p>

Option	Description
type	Use the type option with the query node command to specify the type of node to query.
v2archive	Use the v2archive option with the archive command to archive only files to the server. The client does not process directories that exist in the path of the source file specification.
virtualfsname (does not apply to Mac OS X)	Use this option with the backup group command to specify the name of the container for the group on which you want to perform the operation.
<b>AIX</b>   <b>Linux</b>   <b>Solaris</b> virtualmountpoint	<b>AIX</b>   <b>Linux</b>   <b>Solaris</b> Defines a virtual mount point for a file system if you want to consider files for backup that begin with a specific directory within that file system.
<b>Linux</b>   <b>Windows</b> vmchost	<b>Linux</b>   <b>Windows</b> Used with the backup VM, restore VM, or query VM commands to specify the host name of the VMware VirtualCenter or ESX server where the commands are directed.
<b>Linux</b>   <b>Windows</b> vmcpw	<b>Linux</b>   <b>Windows</b> Used with the backup VM, restore VM, or query VM commands to specify the password of the VirtualCenter or ESX user that is specified with the vmcuser option.
<b>Linux</b>   <b>Windows</b> vmcuser	<b>Linux</b>   <b>Windows</b> Used with the backup VM, restore VM, or query VM commands to specify the user name for the VMware VirtualCenter or ESX server where the commands are directed.
<b>Linux</b>   <b>Windows</b> vmmaxvirtualdisks	<b>Linux</b>   <b>Windows</b> Used with the backup VM command to specify the maximum size of the VMware virtual machine disks (VMDKs) to include in a backup operation.
<b>Linux</b>   <b>Windows</b> vmskipmaxvirtualdisks	<b>Linux</b>   <b>Windows</b> Used with the backup VM command to specify how the backup operation processes VMware virtual machine disks (VMDKs) that exceed the maximum disk size. In V7.1.3 and earlier, the vmskipmaxvirtualdisks option was named vmskipmaxvmdks.
<b>Linux</b>   <b>Windows</b>	<b>Linux</b>   <b>Windows</b>

**Windows** The following options are backup-archive client options that apply only to IBM Spectrum Protect HSM for Windows migrated files.

**Windows**

- Restorecheckstubaccess
- Restoremigstate
- Skipmigrated

**Related concepts:**

**Windows**  Options for backing up migrated files: skipmigrated, checkreparsecontent, stagingdirectory

**Windows**  Options for restoring migrated files: restorecheckstubaccess, restoremigstate

## Restore and retrieve processing options

You can use client options to control some aspects of restore and retrieve processing.

Table 1 lists the restore and retrieve processing options that are available.



Table 1. Restore and retrieve processing options

Option	Description
<b>Windows</b> asrmode	<b>Windows</b> Use this option with the restore, and restore systemstate commands to specify whether to perform a restore operation in system ASR recovery mode. This option is used in the context of restore commands that are generated in the asr.sif file by the backup asr command only. Do not use this option outside the context of ASR recovery mode.
<b>Windows</b> backupsetname	<b>Windows</b> The backupsetname option specifies either the name of the backup set, or the name of the file or tape device that contains the backup set. This option is used with the location option.
dirsonly	Qualifies the operation (backup, archive, restore, retrieve) to process directories alone.
disablenqr	Specifies whether the backup-archive client can use the no-query restore method for restoring files and directories from the server.
filelist	Specifies a file that contains a list of files to be processed by the specified command.
filesonly	Qualifies the operation (backup, archive, restore, retrieve) to process files alone.
<b>AIX</b> <b>Linux</b> <b>Solaris</b> <b>Mac OS X</b> followsymbolic	<b>AIX</b> <b>Linux</b> <b>Solaris</b> <b>Mac OS X</b> Specifies whether you want to restore files to symbolic links or use a symbolic link as a virtual mount point.
fromdate	Use the fromdate option with the fromtime option to specify a date and time from which you want to search for backups or archives during a restore, retrieve, or query operation.
fromnode	Permits one node to perform commands for another node. A user on another node must use the set access command to give you permission to query, restore, or retrieve files or images for the other node.
<b>AIX</b> <b>Linux</b> <b>Solaris</b> <b>Mac OS X</b> fromowner	<b>AIX</b> <b>Linux</b> <b>Solaris</b> <b>Mac OS X</b> Displays file spaces for an alternative owner. Also specifies an alternative owner from which to restore or retrieve files.
fromtime	Use the fromtime option with the fromdate option to specify a beginning time from which you want to search for backups or archives during a restore, retrieve, or query operation.
ifnewer	Replaces an existing file with the latest backup version only if the backup version is newer than the existing file.
<b>AIX</b> <b>Linux</b> <b>Solaris</b> imagetofile	<b>AIX</b> <b>Linux</b> <b>Solaris</b> Use the imagetofile option with the restore image command to specify that you want to restore the source image to a file. You might need to restore the image to a file in the event of bad sectors present on the target volume, or if you want to do some manipulations with the image data. This option is valid for AIX®, Linux, and Solaris clients.
<b>Windows</b> imagetofile	<b>Windows</b> Use the imagetofile option with the restore image command to specify that you want to restore the source image to a file. You might need to restore the image to a file in the event of bad sectors present on the target volume, or if you want to do some manipulations with the image data.
inactive	Displays a list of active and inactive files when used with the pick option.
latest	Restores the most recent backup version of a file whether it is active or inactive.
localbackupset	Specifies whether the backup-archive client GUI bypasses initial logon with the server to restore a local backup set on a stand-alone workstation.

Option	Description
<p><b>AIX</b> <b>Linux</b> <b>Solaris</b> <b>Windows</b> <code>makesparsefile</code></p> <p>(does not apply to Mac OS X)</p>	<p><b>AIX</b> <b>Linux</b> <b>Solaris</b> <b>Windows</b> Use the <code>makesparsefile</code> option with the <code>restore</code> or <code>retrieve</code> commands to specify how sparse files are re-created.</p>
<p><b>AIX</b> <b>Linux</b> <b>Solaris</b> <b>Windows</b> <code>monitor</code></p>	<p><b>AIX</b> <b>Linux</b> <b>Solaris</b> <b>Windows</b> Specifies whether you want to monitor an image restore of one or more file systems that belong to a network-attached storage (NAS) file server.</p>
<p><b>Mac OS X</b> <code>noprompt</code></p>	<p><b>Mac OS X</b> suppresses the confirmation prompt that is presented by the <code>delete</code> group, <code>delete archive</code>, <code>expire</code>, and <code>set event</code> commands.</p>
<p><b>AIX</b> <b>Linux</b> <b>Solaris</b> <b>Windows</b> <code>noprompt</code></p>	<p><b>AIX</b> <b>Linux</b> <b>Solaris</b> <b>Windows</b> suppresses the confirmation prompt that is presented by the <code>delete</code> group, <code>delete archive</code>, <code>expire</code>, <code>restore image</code>, and <code>set event</code> commands.</p>
<p><b>Windows</b> <code>optfile</code></p>	<p><b>Windows</b> Specifies the client options file you want to use when you start a backup-archive client session.</p>
<p><b>AIX</b> <b>Linux</b> <b>Solaris</b> <b>Mac OS X</b> <code>optfile</code></p>	<p><b>AIX</b> <b>Linux</b> <b>Solaris</b> <b>Mac OS X</b> Specifies the client user-options file that you want to use when you start a backup-archive client session.</p>
<p><code>pick</code></p>	<p>Creates a list of backup versions, images, or archive copies that match the file specification you enter. From the list, you can select the versions to process. Include the <code>inactive</code> option to view both active and inactive objects.</p>
<p><code>pitdate</code></p>	<p>Use the <code>pitdate</code> option with the <code>pittime</code> option to establish a point in time for which you want to display or restore the latest version of your backups.</p>
<p><code>pittime</code></p>	<p>Use the <code>pittime</code> option with the <code>pitdate</code> option to establish a point in time for which you want to display or restore the latest version of your backups.</p>
<p><code>preservepath</code></p>	<p>Specifies how much of the source path to reproduce as part of the target directory path when you restore or retrieve files to a new location.</p>
<p><code>replace</code></p>	<p>Specifies whether to overwrite an existing file, or to prompt you for your selection when you restore or retrieve files.</p>
<p><b>AIX</b> <b>Linux</b> <b>Solaris</b> <b>Windows</b> <code>showmembers</code> (does not apply to Mac OS X)</p>	<p><b>AIX</b> <b>Linux</b> <b>Solaris</b> <b>Windows</b> Displays all members of a group.</p>
<p><code>subdir</code></p>	<p>Specifies whether you want to include subdirectories of a named directory.</p>
<p><code>tapeprompt</code></p>	<p>Specifies whether you want the backup-archive client to wait for a tape that is required for a restore or retrieve to be mounted, or to prompt you for your choice.</p>
<p><code>todate</code></p>	<p>Use the <code>todate</code> option with the <code>totime</code> option to specify an ending date and time to which you want to search for backups or archives during a restore, retrieve, or query operation.</p>
<p><code>totime</code></p>	<p>Use the <code>totime</code> option with the <code>todate</code> option to specify an ending date and time to which you want to search for backups or archives during a restore, retrieve, or query operation.</p>
<p><code>type</code></p>	<p>Use the <code>type</code> option with the <code>query node</code> command to specify the type of node to query.</p>
<p><b>AIX</b> <b>Linux</b> <b>Solaris</b> <code>verifyimage</code></p>	<p><b>AIX</b> <b>Linux</b> <b>Solaris</b> Use the <code>verifyimage</code> option with the <code>restore image</code> command to specify that you want to enable detection of bad sectors on the destination target volume. If bad sectors are detected on the target volume, the client issues a warning message on the console and in the error log.</p>

Option	Description
<b>Windows</b> verifyimage	<b>Windows</b> Use the verifyimage option with the restore image command to specify that you want to enable detection of bad sectors on the destination target volume. If bad sectors are detected on the target volume, the client issues a warning message on the console and in the error log.

The following options are backup-archive client options that apply to IBM Spectrum Protect™ HSM for Windows migrated files. For more information about these options, see the IBM® Knowledge Center topics at [http://www.ibm.com/support/knowledgecenter/SSERFH\\_8.1.2/hsmwin/welcome.html](http://www.ibm.com/support/knowledgecenter/SSERFH_8.1.2/hsmwin/welcome.html).

- Checkreparsecontent
- Restorecheckstubaccess
- Restoremigstate
- Skipmigrated

The following options are backup-archive client options that apply to IBM Spectrum Protect for Space Management migrated files. For more information about these options, see the IBM Knowledge Center topics at [http://www.ibm.com/support/knowledgecenter/SSERBH\\_8.1.2/hsmul/welcome.html](http://www.ibm.com/support/knowledgecenter/SSERBH_8.1.2/hsmul/welcome.html).

- Restoremigstate
- Skipmigrated

## Scheduling options

This topic discusses the options that you can use to regulate central scheduling. The backup-archive client uses scheduling options only when the Scheduler is running.

Table 1 lists the scheduling options that are available.

Table 1. Scheduling options

Option	Description
cadlistenonport	Specifies whether to open listening ports for the client acceptor when the client acceptor is used to manage schedules in polling mode.
managedservices	Specifies whether the client acceptor manages the web client, the scheduler, or both.
maxcmdretries	Specifies the maximum number of times the client scheduler attempts to process a scheduled command that fails.
<b>Mac OS X</b>   <b>AIX</b>   <b>Linux</b>   <b>Solaris</b>   <b>Mac OS X</b>   <b>Windows</b> postschedulecmd/postnschedulecmd	<b>Mac OS X</b>   <b>AIX</b>   <b>Linux</b>   <b>Solaris</b>   <b>Mac OS X</b>   <b>Windows</b> Specifies a command to process after running a schedule.
<b>Mac OS X</b>   <b>AIX</b>   <b>Linux</b>   <b>Solaris</b>   <b>Mac OS X</b>   <b>Windows</b> preschedulecmd/prenschedulecmd	<b>Mac OS X</b>   <b>AIX</b>   <b>Linux</b>   <b>Solaris</b>   <b>Mac OS X</b>   <b>Windows</b> Specifies a command to process before running a schedule.
querschedperiod	Specifies the number of hours the client scheduler waits between attempts to contact the server for scheduled work.
retryperiod	Specifies the number of minutes the client scheduler waits between attempts to process a scheduled command that fails or between unsuccessful attempts to report results to the server.
<b>Windows</b> runasservice	<b>Windows</b> Forces the client command process to continue running, even if the account that started the client logs off. Use this option on all Windows clients.
schedcmddisabled	Specifies whether to disable the scheduling of generic commands specified by your IBM Spectrum Protect™ administrator.

Option	Description
<b>AIX</b>   Linux   Solaris   Mac OS X schedcmduser (server defined only)	<b>AIX</b>   Linux   Solaris   Mac OS X The scheduler executes commands under a uid of 0, however, there might be some users who have a different user ID. In this case, your IBM Spectrum Protect administrator can define schedules and allow these schedules to be executed under a uid other than 0, using this option. The IBM Spectrum Protect Client API does not support this option.
schedlogmax Schedlogmax	Specifies the maximum size of the scheduler log and web client log, in megabytes.
schedlogname Schedlogname	Specifies the path and file name where you want to store schedule log information.
schedlogretention	Specifies the number of days to keep log file entries in the schedule log and the web client log, and whether to save pruned entries.
schedmode	Specifies which schedule mode to use, <i>polling</i> or <i>prompted</i> .
schedrestretrdisabled	Specifies whether to prevent the IBM Spectrum Protect Server administrator from executing restore or retrieve schedule operations.
sessioninitiation	Use the sessioninitiation option to control whether the server or client initiates sessions through a firewall. The default is that the client can initiate sessions.
srvprepostscheddisabled	Specifies whether to prevent the IBM Spectrum Protect Server administrator from executing pre-schedule and post-schedule commands when performing scheduled operations.
<b>AIX</b>   Linux   Solaris   Windows srvprepostsnapdisabled	<b>AIX</b>   Linux   Solaris   Windows Specifies whether to prevent the IBM Spectrum Protect Server administrator from executing pre-snapshot and post-snapshot commands when performing scheduled image snapshot backup operations.
tcpclientaddress	Specifies a TCP/IP address if your client node has more than one address, and you want the server to contact an address other than the one that was used to make the first server contact. The server uses this address when it begins the server prompted scheduled operation. See schedmode prompted (Schedmode) for details.
tcpclientport	Specifies a TCP/IP port number for the server to contact the client when the server begins the server prompted scheduled operation. See schedmode prompted (Schedmode) for details.

## Format and language options

Format and language options allow you to select different formats for date, time and numbers for different languages.

**AIX** | Linux | Solaris | Mac OS X Format options allow you to select different formats for date, time, and numbers.

Table 1. Format and language options

Option	Description
dateformat	Specifies the format for displaying dates.
<b>Windows</b> language	<b>Windows</b> Specifies the language used for messages.
numberformat	Specifies the format for displaying numbers.
timeformat	Specifies the format for displaying time.

## Command processing options

This topic explains the options that you can use with the backup-archive client commands.

Command processing options allow you to control some of the formatting of data on your terminal screen.

Table 1. Command processing options

Option	Description
quiet	Limits the number of messages that are displayed on your screen during processing. This option can be overridden by the server.
scrolllines	Specifies the number of lines of information that are displayed on your screen at one time. Use this option only when scrollprompt is set to yes.
scrollprompt	Specifies whether you want the backup-archive client to stop and wait after displaying the number of lines of information you specified with the scrolllines option, or scroll through and stop at the end of the information list.
setwindowtitle	Specifies whether to display the IBM Spectrum Protect™ server name and host server name in the title of the administrative client command window.
verbose	Specifies that processing information should be displayed on your screen. The alternative is quiet. This option can be overridden by the server.

## Authorization options

Authorization options control access to the IBM Spectrum Protect™ server.

Table 1 lists the authorization options that are available.

Table 1. Authorization options

Option	Description										
<table border="1"> <tr> <td>AIX</td> <td>Linux</td> <td>Mac OS X</td> <td>Solaris</td> <td>Windows</td> </tr> </table> autodeploy	AIX	Linux	Mac OS X	Solaris	Windows	<table border="1"> <tr> <td>AIX</td> <td>Linux</td> <td>Mac OS X</td> <td>Solaris</td> <td>Windows</td> </tr> </table> Specifies whether you want to enable or disable an automatic deployment of the client if a restart is required.	AIX	Linux	Mac OS X	Solaris	Windows
AIX	Linux	Mac OS X	Solaris	Windows							
AIX	Linux	Mac OS X	Solaris	Windows							
<table border="1"> <tr> <td>AIX</td> <td>Linux</td> <td>Solaris</td> <td>Mac OS X</td> </tr> </table> groups	AIX	Linux	Solaris	Mac OS X	<table border="1"> <tr> <td>AIX</td> <td>Linux</td> <td>Solaris</td> <td>Mac OS X</td> </tr> </table> Specifies the groups on your workstation that you want to authorize to request IBM Spectrum Protect services from the server.	AIX	Linux	Solaris	Mac OS X		
AIX	Linux	Solaris	Mac OS X								
AIX	Linux	Solaris	Mac OS X								
password	Specifies the IBM Spectrum Protect password.										
passwordaccess	Specifies whether you want to use a generated password or be prompted for a password each time you start the client.										
<table border="1"> <tr> <td>AIX</td> <td>Linux</td> <td>Solaris</td> <td>Mac OS X</td> </tr> </table> passworddir	AIX	Linux	Solaris	Mac OS X	<table border="1"> <tr> <td>AIX</td> <td>Linux</td> <td>Solaris</td> <td>Mac OS X</td> </tr> </table> Specifies the directory in which you want to store the automatically generated password for your client node. The encryption key and password are encrypted and stored in the TSM.sth file.	AIX	Linux	Solaris	Mac OS X		
AIX	Linux	Solaris	Mac OS X								
AIX	Linux	Solaris	Mac OS X								
revokeremoteaccess	Restricts an administrator with client access privileges from accessing your workstation through the web client.										
<table border="1"> <tr> <td>AIX</td> <td>Linux</td> <td>Solaris</td> <td>Mac OS X</td> </tr> </table> users	AIX	Linux	Solaris	Mac OS X	<table border="1"> <tr> <td>AIX</td> <td>Linux</td> <td>Solaris</td> <td>Mac OS X</td> </tr> </table> Authorizes specific users on your workstation to request services from a server.	AIX	Linux	Solaris	Mac OS X		
AIX	Linux	Solaris	Mac OS X								
AIX	Linux	Solaris	Mac OS X								

## Error processing options

Error processing options specify the name of the error log file and how the backup-archive client treats the entries in the log file.

Table 1 lists the error processing options that are available.

Table 1. Error processing options

Option	Description
--------	-------------

Option	Description
errorlogmax	Specifies the maximum size of the error log, in megabytes.
errorlogname Errorlogname	Specifies the fully qualified path and file name of the file where you want to store information about errors that occur during processing.
errorlogretention	Specifies how many days to maintain error log entries before pruning, and whether to save the pruned entries.

## Transaction processing options

Transaction processing options control how transactions are processed between the IBM Spectrum Protect™ client and server.

Table 1 lists the transaction processing options that are available.

Table 1. Transaction processing options

Option	Description													
collocatebyfilespec	Specifies that you want the backup-archive client to use only one server session to send objects generated from one file specification. Setting the collocatebyfilespec option to <i>yes</i> eliminates interspersing of files from different file specifications, by limiting the client to one server session per file specification. Therefore, if you store the data to tape, files for each file specification are stored together on one tape (unless another tape is required for more capacity).													
commrestartduration	Specifies the maximum number of minutes you want the client to try to reconnect to the IBM Spectrum Protect server after a communication error occurs.													
commrestartinterval	Specifies the number of seconds you want the client to wait between attempts to reconnect to the IBM Spectrum Protect server after a communication error occurs.													
diskbuffsize	Specifies the maximum disk I/O buffer size (in kilobytes) that the client can use when reading files.													
<table border="1"> <tr> <td>AIX</td> <td>Linux</td> <td>Solaris</td> <td>Mac OS X</td> </tr> <tr> <td>Windows</td> <td colspan="3">largecommbuffers</td> </tr> </table>	AIX	Linux	Solaris	Mac OS X	Windows	largecommbuffers			<table border="1"> <tr> <td>AIX</td> <td>Linux</td> <td>Solaris</td> <td>Mac OS X</td> <td>Windows</td> </tr> </table> <p>This option has been replaced by the diskbuffsize option. At this time, largecommbuffers is still accepted by the backup-archive client in order to ease the transition to the new option. However, the value specified by largecommbuffers is ignored in favor of the diskbuffsize setting. Important: Discontinue the use of largecommbuffers because future releases of the client might not accept this option.</p>	AIX	Linux	Solaris	Mac OS X	Windows
AIX	Linux	Solaris	Mac OS X											
Windows	largecommbuffers													
AIX	Linux	Solaris	Mac OS X	Windows										
<table border="1"> <tr> <td>AIX</td> <td>Linux</td> <td>Solaris</td> <td>Mac OS X</td> </tr> </table> <table border="1"> <tr> <td>Windows</td> <td>resourceutilization</td> </tr> </table>	AIX	Linux	Solaris	Mac OS X	Windows	resourceutilization	<table border="1"> <tr> <td>AIX</td> <td>Linux</td> <td>Solaris</td> <td>Mac OS X</td> </tr> </table> <p>Specifies the number of seconds the server waits for a status system call on an NFS file system before it times out.</p> <table border="1"> <tr> <td>Windows</td> <td>Use the resourceutilization option in your client options file dsm.opt to regulate the level of resources the IBM Spectrum Protect server and client can use during processing.</td> </tr> </table>	AIX	Linux	Solaris	Mac OS X	Windows	Use the resourceutilization option in your client options file dsm.opt to regulate the level of resources the IBM Spectrum Protect server and client can use during processing.	
AIX	Linux	Solaris	Mac OS X											
Windows	resourceutilization													
AIX	Linux	Solaris	Mac OS X											
Windows	Use the resourceutilization option in your client options file dsm.opt to regulate the level of resources the IBM Spectrum Protect server and client can use during processing.													
<table border="1"> <tr> <td>AIX</td> <td>Linux</td> <td>Solaris</td> <td>Mac OS X</td> </tr> </table> <table border="1"> <tr> <td>AIX</td> <td>Linux</td> <td>Solaris</td> <td>Mac OS X</td> </tr> </table>	AIX	Linux	Solaris	Mac OS X	AIX	Linux	Solaris	Mac OS X	<table border="1"> <tr> <td>AIX</td> <td>Linux</td> <td>Solaris</td> <td>Mac OS X</td> </tr> </table> <p>Use the resourceutilization option in your dsm.sys file to regulate the level of resources the IBM Spectrum Protect server and client can use during processing.</p>	AIX	Linux	Solaris	Mac OS X	
AIX	Linux	Solaris	Mac OS X											
AIX	Linux	Solaris	Mac OS X											
AIX	Linux	Solaris	Mac OS X											
txnbytelimit	Specifies the number of kilobytes the client program buffers before it sends a transaction to the server.													
<table border="1"> <tr> <td>Windows</td> <td>usedirectory</td> </tr> </table>	Windows	usedirectory	<table border="1"> <tr> <td>Windows</td> <td>Provides a convenient way to simplify client communication configuration by overriding commmethod parameters set in the client options file and instead querying the Active Directory for the communication method and server with which to connect.</td> </tr> </table>	Windows	Provides a convenient way to simplify client communication configuration by overriding commmethod parameters set in the client options file and instead querying the Active Directory for the communication method and server with which to connect.									
Windows	usedirectory													
Windows	Provides a convenient way to simplify client communication configuration by overriding commmethod parameters set in the client options file and instead querying the Active Directory for the communication method and server with which to connect.													

## Web client options

Several backup-archive client options are used to configure the IBM Spectrum Protect™ web client.

Table 1 lists the web client options that are available.

Table 1. Web client options

Option	Description
httpport	Specifies a TCP/IP port address for the web client.
<b>AIX</b>   <b>Linux</b>   <b>Solaris</b>   <b>Mac OS X</b> managedservices	<b>AIX</b>   <b>Linux</b>   <b>Solaris</b>   <b>Mac OS X</b> Specifies whether the client acceptor daemon manages the web client, the scheduler, or both.
<b>Windows</b> managedservices	<b>Windows</b> Specifies whether the client acceptor service manages the web client, the scheduler, or both.
revokeremoteaccess	Restricts administrator access on a client workstation through the web client.
<b>AIX</b>   <b>Linux</b>   <b>Solaris</b>   <b>Mac OS X</b> webports	<b>AIX</b>   <b>Linux</b>   <b>Solaris</b>   <b>Mac OS X</b> Enables the use of the web client outside a firewall by specifying the TCP/IP port number used by the client acceptor daemon and the web Client Agent service for communications with the web client.
<b>Windows</b> webports	<b>Windows</b> Enables the use of the web client outside a firewall by specifying the TCP/IP port number used by the client acceptor service and the web Client Agent service for communications with the web client.

## Using options with commands

You can override some of the options in your client options file (dsm.opt) file by entering them with appropriate backup-archive client commands.

**AIX** | **Linux** | **Solaris** | **Mac OS X** You can override some of the options in your dsm.sys file or client user-options file (dsm.opt) by entering them with appropriate backup-archive client commands.

The client processes options in the following order (precedence):

1. Options defined on the server with server-enforced client options. The server overrides client values.
  2. Options entered locally on the command line.
  3. Options defined on the server for a schedule using the options parameters.
  4. Options entered locally in the options file.
  5. Options received from the server with client option sets not set as forced by the server. The server *does not* override client values if not forced.
  6. Default option values.
- Entering options with a command  
You must follow the general rules for entering options with a command.
  - Initial command-line-only options  
A subset of client options is valid on the initial command line only. Many of these options establish the runtime environment, such as the commethod and optfile options. Options in this category are not valid in interactive, macro, or scheduler modes. They generate an error and cause processing to stop.
  - Client options that can be set by the IBM Spectrum Protect server  
Some client options can be set by the IBM Spectrum Protect™ server.

## Entering options with a command

You must follow the general rules for entering options with a command.

- Enter a command, a dash (-), the option name, an equal sign (=), and the option value or parameter. Do not include spaces on either side of the = sign.

Here are examples of this syntax on different clients:

**AIX** | **Linux** | **Solaris** | **Mac OS X**  
`dsmc archive -description="year end 1999" /home/`

**Windows**  
`dsmc archive -description="Project A" c:\devel\proj1\*`

- For options that do not include parameters, enter a command, a dash (-), and the option name. For example,

```
dsmc incremental -quiet
```

Note: Use a leading dash (-) to indicate that the following text is the name of an option. If an object name begins with a dash, you must surround it in either single quotation marks (') or quotation marks ("). Most operating system command line processors strip the quotation marks before the command-line arguments are submitted to the IBM Spectrum Protect™ client application. In such cases, by using escape characters or doubling the quotation marks allows the client to receive the quoted object name. In loop mode, surround such objects in either single quotation marks (') or quotation marks (").

- Enter either the option name, or an abbreviation for the option name. For example, to enter the latest option, enter either -lat or -latest. The capital letters in the syntax of each option indicate the minimum abbreviation for that option name.
- Enter options before or after command parameters. For example, you can enter the option before or after a file specification:

```
dsmc selective -subdir=yes "/home/devel/proj1/*"
dsmc selective "/home/devel/proj1/*" -subdir=yes
```

#### Windows

```
dsmc selective -subdir=yes c:\devel\proj1\*
dsmc selective c:\devel\proj1\* -subdir=yes
```

- When you enter several options on a command, separate them with a blank space.
- Enclose the value in quotation marks (" ") if the option value that you enter contains a blank space. For example:

```
AIX Linux Solaris Mac OS X
```

```
dsmc archive -description="Project A" "/home/devel/proj1/*"
```

#### Windows

```
dsmc archive -description="Project A" c:\devel\proj1\*
```

- Most options that you enter on the command line override the value that is set in the preferences file. However, when you use the domain option with the incremental command, it adds to the domain specified in your client options file rather than overriding the current value.

- **AIX Solaris Mac OS X** On AIX®, Solaris, Linux on z, and Mac: The maximum number of characters for a file name is 255. The maximum combined length of the file name and path name is 1024 characters. The Unicode representation of a character can occupy several bytes, so the maximum number of characters that a file name might contain can vary.
- **Linux** On Linux: The maximum length for a file name is 255 bytes. The maximum combined length of both the file name and path name is 4096 bytes. This length matches the PATH\_MAX that is supported by the operating system. The Unicode representation of a character can occupy several bytes, so the maximum number of characters that comprises a path and file name can vary. The actual limitation is the number of bytes in the path and file components, which might or might not correspond to an equal number of characters.

**Linux** On Linux: For archive or retrieve operations, the maximum length that you can specify for a path and file name (combined) remains at 1024 bytes.

- **Windows** The maximum number of bytes for a file name and file path is 6255 combined. However, the file name itself cannot exceed 255 bytes and the path that leads to the file cannot exceed 6000 bytes. Furthermore, directory names (including the directory delimiter) within a path are limited to 255 bytes. The Unicode representation of a character can occupy several bytes, so the maximum number of characters that a file name might contain can vary.
- **Mac OS X** For Mac OS X, the maximum length of a file name is limited to 504 bytes (not characters). The Unicode representation of a character can occupy several bytes, so the maximum number of characters that a file name contains can vary.

## Initial command-line-only options

A subset of client options is valid on the initial command line only. Many of these options establish the runtime environment, such as the commmethod and optfile options. Options in this category are not valid in interactive, macro, or scheduler modes. They generate an error and cause processing to stop.

Table 1 lists the options that are valid only on the initial command line.

Table 1. Options that are valid on the initial command line only

Options valid on the initial command line
---



Options valid on the initial command line	
<ul style="list-style-type: none"> <li>• <b>Windows</b> asrmode</li> <li>• <b>Windows</b> backupregistry</li> <li>• commmethod</li> <li>• <b>Windows</b> computername</li> <li>• deduplication</li> <li>• diskbuffsize</li> <li>• editor</li> <li>• enablededupcache</li> <li>• <b>AIX</b>   <b>Linux</b>   <b>Solaris</b>   <b>Windows</b> enablelanfree</li> <li>• errorlogmax</li> <li>• errorlogname</li> <li>• errorlogretention</li> <li>• <b>Windows</b> incrthreshold</li> <li>• <b>AIX</b>   <b>Linux</b>   <b>Solaris</b>   <b>Windows</b> lanfreecommmethod</li> <li>• <b>AIX</b>   <b>Linux</b>   <b>Solaris</b>   <b>Windows</b> lanfreeshmport</li> <li>• <b>AIX</b>   <b>Linux</b>   <b>Solaris</b>   <b>Windows</b> lanfreetcpport</li> <li>• maxcmdretries</li> <li>• <b>Windows</b> namedpipename</li> <li>• <b>AIX</b>   <b>Linux</b>   <b>Solaris</b>   <b>Mac OS X</b> nfstimeout</li> <li>• nodename</li> <li>• optfile</li> <li>• password</li> <li>• postschedulecmd/postnschedulecmd (can be included in the schedule definition)</li> <li>• <b>Windows</b> postsnapshotcmd</li> </ul>	<ul style="list-style-type: none"> <li>• preschedulecmd/prenschedulecmd (can be included in the schedule definition)</li> <li>• <b>Windows</b> presnapshotcmd</li> <li>• querieschedperiod</li> <li>• resourceutilization</li> <li>• retryperiod</li> <li>• <b>Windows</b> runasservice</li> <li>• schedlogmax</li> <li>• schedlogname</li> <li>• schedlogretention</li> <li>• schedmode</li> <li>• <b>AIX</b>   <b>Linux</b>   <b>Solaris</b>   <b>Mac OS X</b> servername</li> <li>• sessioninitiation</li> <li>• setwindowtitle</li> <li>• tcpbuffsize</li> <li>• tcpcadaddress</li> <li>• tcpclientaddress</li> <li>• tcpclientport</li> <li>• <b>Windows</b> tcpport</li> <li>• <b>Windows</b> tcpserveraddress</li> <li>• tcpwindowsize</li> <li>• txnbytelimit</li> <li>• <b>Windows</b> usedirectory</li> <li>• virtualnodename</li> </ul>

## Client options that can be set by the IBM Spectrum Protect server

Some client options can be set by the IBM Spectrum Protect™ server.

Table 1 lists the options that can be set by the server.

Table 1. Options that can be set by the IBM Spectrum Protect server

Options that can be set by the IBM Spectrum Protect server	
--	--

Options that can be set by the IBM Spectrum Protect server	
<ul style="list-style-type: none"> <li>• <span style="background-color: #800040; color: white; padding: 2px;">AIX</span> <span style="background-color: #800040; color: white; padding: 2px;">Linux</span> Afmskipuncachedfiles</li> <li>• <span style="background-color: #800040; color: white; padding: 2px;">AIX</span> <span style="background-color: #800040; color: white; padding: 2px;">Linux</span> <span style="background-color: #800040; color: white; padding: 2px;">Solaris</span> Archsymlinkasfile</li> <li>• <span style="background-color: #800040; color: white; padding: 2px;">Windows</span> Casesensitiveaware</li> <li>• Changingretries</li> <li>• Collocatebyfilespec</li> <li>• Compressalways</li> <li>• Compression</li> <li>• Deduplication</li> <li>• Dirmc</li> <li>• Disablenqr</li> <li>• Diskcachelocation</li> <li>• Domain</li> <li>• <span style="background-color: #800040; color: white; padding: 2px;">AIX</span> <span style="background-color: #800040; color: white; padding: 2px;">Linux</span> <span style="background-color: #800040; color: white; padding: 2px;">Solaris</span> <span style="background-color: #800040; color: white; padding: 2px;">Windows</span> Domain.image</li> <li>• <span style="background-color: #800040; color: white; padding: 2px;">AIX</span> <span style="background-color: #800040; color: white; padding: 2px;">Linux</span> <span style="background-color: #800040; color: white; padding: 2px;">Solaris</span> <span style="background-color: #800040; color: white; padding: 2px;">Mac OS X</span> <span style="background-color: #800040; color: white; padding: 2px;">Windows</span> Domain.nas</li> <li>• <span style="background-color: #800040; color: white; padding: 2px;">AIX</span> <span style="background-color: #800040; color: white; padding: 2px;">Linux</span> <span style="background-color: #800040; color: white; padding: 2px;">Solaris</span> <span style="background-color: #800040; color: white; padding: 2px;">Mac OS X</span> <span style="background-color: #800040; color: white; padding: 2px;">Windows</span></li> <li>Encryptiontype</li> <li>• Encryptkey</li> <li>• <span style="background-color: #800040; color: white; padding: 2px;">AIX</span> <span style="background-color: #800040; color: white; padding: 2px;">Linux</span> <span style="background-color: #800040; color: white; padding: 2px;">Solaris</span> <span style="background-color: #800040; color: white; padding: 2px;">Mac OS X</span> <span style="background-color: #800040; color: white; padding: 2px;">Windows</span> Exclude options</li> <li>• Inclexcl</li> <li>• <span style="background-color: #800040; color: white; padding: 2px;">AIX</span> <span style="background-color: #800040; color: white; padding: 2px;">Linux</span> <span style="background-color: #800040; color: white; padding: 2px;">Solaris</span> <span style="background-color: #800040; color: white; padding: 2px;">Mac OS X</span> <span style="background-color: #800040; color: white; padding: 2px;">Windows</span> Include options</li> <li>• maxcandprocs</li> <li>• maxmigrators</li> <li>• Memoryefficientbackup</li> <li>• <span style="background-color: #800040; color: white; padding: 2px;">AIX</span> <span style="background-color: #800040; color: white; padding: 2px;">Linux</span> <span style="background-color: #800040; color: white; padding: 2px;">Solaris</span> <span style="background-color: #800040; color: white; padding: 2px;">Mac OS X</span> Nfstimeout</li> <li>• Postschedulecmd/Postnschedulecmd</li> <li>• <span style="background-color: #800040; color: white; padding: 2px;">AIX</span> <span style="background-color: #800040; color: white; padding: 2px;">Linux</span> <span style="background-color: #800040; color: white; padding: 2px;">Solaris</span> <span style="background-color: #800040; color: white; padding: 2px;">Mac OS X</span> <span style="background-color: #800040; color: white; padding: 2px;">Windows</span></li> <li>Postsnapshotcmd</li> <li>• Preschedulecmd/Prenschedulecmd</li> <li>• <span style="background-color: #800040; color: white; padding: 2px;">AIX</span> <span style="background-color: #800040; color: white; padding: 2px;">Linux</span> <span style="background-color: #800040; color: white; padding: 2px;">Solaris</span> <span style="background-color: #800040; color: white; padding: 2px;">Mac OS X</span> <span style="background-color: #800040; color: white; padding: 2px;">Windows</span></li> <li>Preservelastaccessdate</li> <li>• <span style="background-color: #800040; color: white; padding: 2px;">AIX</span> <span style="background-color: #800040; color: white; padding: 2px;">Linux</span> <span style="background-color: #800040; color: white; padding: 2px;">Solaris</span> <span style="background-color: #800040; color: white; padding: 2px;">Mac OS X</span> <span style="background-color: #800040; color: white; padding: 2px;">Windows</span></li> <li>Presnapshotcmd</li> </ul>	<ul style="list-style-type: none"> <li>• Queryschedperiod</li> <li>• Quiet</li> <li>• <span style="background-color: #800040; color: white; padding: 2px;">Windows</span> Resetarchiveattribute</li> <li>• Resourceutilization</li> <li>• Retryperiod</li> <li>• Schedmode</li> <li>• Scrolllines</li> <li>• Scrollprompt</li> <li>• <span style="background-color: #800040; color: white; padding: 2px;">AIX</span> <span style="background-color: #800040; color: white; padding: 2px;">Linux</span> Snapshotcachesize</li> <li>• <span style="background-color: #800040; color: white; padding: 2px;">AIX</span> <span style="background-color: #800040; color: white; padding: 2px;">Windows</span> Snapshotproviderfs</li> <li>• <span style="background-color: #800040; color: white; padding: 2px;">AIX</span> <span style="background-color: #800040; color: white; padding: 2px;">Linux</span> <span style="background-color: #800040; color: white; padding: 2px;">Windows</span></li> <li>Snapshotproviderimage</li> <li>• <span style="background-color: #800040; color: white; padding: 2px;">AIX</span> <span style="background-color: #800040; color: white; padding: 2px;">Linux</span> <span style="background-color: #800040; color: white; padding: 2px;">Windows</span> Stagingdirectory</li> <li>• Subdir</li> <li>• Tapeprompt</li> <li>• Txnbytelimit</li> <li>• Verbose</li> <li>• <span style="background-color: #800040; color: white; padding: 2px;">Linux</span> <span style="background-color: #800040; color: white; padding: 2px;">Windows</span> Vmchost</li> <li>• <span style="background-color: #800040; color: white; padding: 2px;">Linux</span> <span style="background-color: #800040; color: white; padding: 2px;">Windows</span> Vmcuser</li> <li>• <span style="background-color: #800040; color: white; padding: 2px;">Linux</span> <span style="background-color: #800040; color: white; padding: 2px;">Windows</span></li> <li>Vmprocessvmwithindependent</li> <li>• <span style="background-color: #800040; color: white; padding: 2px;">Linux</span> <span style="background-color: #800040; color: white; padding: 2px;">Windows</span> Vmprocessvmwithprdm</li> </ul>

Note:

1. See IBM Spectrum Protect for Mail: Data Protection for Microsoft Exchange Server product documentation on IBM® Knowledge Center at <http://www.ibm.com/support/knowledgecenter/SSERBW/welcome>.

#### Related tasks:

Controlling client operations through client option sets

## Client options reference

The following sections contain detailed information about each of the IBM Spectrum Protect™ processing options.

Information for each option includes the following information:

- A description
- A syntax diagram
- Detailed descriptions of the parameters
- Examples of using the option in the client options file (if applicable)
- Examples of using the option on the command line (if applicable)

Options with a command-line example of **Does not apply** cannot be used with command line or scheduled commands.

Mac OS X Note:

1. Do not enclose an option value with single or quotation marks, unless the value is a file specification that contains spaces or wildcard characters. For example, the following option is not valid:

passwordaccess "generate"

2. **AIX Linux Mac OS X Solaris** All options in the dsm.sys file, except for the defaultserver option, must be placed within a server stanza. A server stanza is a collection of options statements in dsm.sys that begins with a SERVERName option and ends either at the next SERVERName option or the end of the file.
- **Absolute**  
Use the absolute option with the incremental command to force a backup of all files and directories that match the file specification or domain, even if the objects were not changed since the last incremental backup.
  - **Windows Adlocation**  
You can use the adlocation option with the query adobjects or restore adobjects commands to indicate whether the Active Directory objects are to be queried or restored from the local Active Directory Deleted Objects container or from a system state backup on the IBM Spectrum Protect server.
  - **AIX Linux Afmskipuncachedfiles**  
The afmskipuncachedfiles option specifies whether uncached and dirty files in General Parallel File System (GPFS™) Active File Management file sets are processed for backup, archive, and migration operations.
  - **Archmc**  
Use the archmc option with the archive command to specify the available management class for your policy domain to which you want to bind your archived files and directories.
  - **AIX Linux Solaris Archsymlinkasfile**  
The archsymlinkasfile option specifies whether the backup-archive client follows a symbolic link and archives the file or directory to which it points, or archives the symbolic link only. Use this option with the archive command.
  - **AIX Linux Solaris Mac OS X Asnodename**  
Use the asnodename option to allow agent nodes to back up or restore data on behalf of another node (the target node). This enables concurrent operations from multiple nodes to store data to the same target node and file space in parallel.
  - **Windows Asnodename**  
Use the asnodename option to allow an agent node to back up, archive, restore, retrieve, and query data on behalf of a target node.
  - **Windows Asrmode**  
Use the asrmode option with the restore and restore systemstate commands to specify whether to perform a restore operation in system ASR recovery mode.
  - **Auditlogging**  
Use the auditlogging option to generate an audit log that contains an entry for each file that is processed during an incremental, selective, archive, restore, or retrieve operation.
  - **Auditlogname**  
The auditlogname option specifies the path and file name where you want to store audit log information. This option applies when audit logging is enabled.
  - **AIX Linux Mac OS X Solaris Windows Autodeploy**  
Use the autodeploy option to enable or disable an automatic deployment of the client if a restart is required.
  - **Autofsrename**  
The autofsrename option renames an existing file space that is not Unicode-enabled on the IBM Spectrum Protect server so that a Unicode-enabled file space with the original name can be created for the current operation.
  - **AIX Linux Solaris Automount**  
The automount option adds an automounted file system into the domain by mounting it. Use this option with the domain option.
  - **Linux Windows Backmc**  
The backmc option specifies the management class to apply to the backup fastback command for retention purposes.
  - **Backupsetname**  
The backupsetname option specifies the name of a backup set from the IBM Spectrum Protect server.
  - **Basesnapshotname**  
The basesnapshotname option specifies the snapshot to use as the base snapshot, when you perform a snapshot differential (snapdiff) backup of a NetApp filer volume. If you specify this option, you must also use the snapdiff option or an error occurs. If basesnapshotname is not specified, the useexistingbase option selects the most recent snapshot on the filer volume as the base snapshot.
  - **Cadlistenonport**  
The cadlistenonport option specifies whether to open a listening port for the client acceptor.
  - **Windows Casesensitiveaware**  
The casesensitiveaware option specifies whether the Windows backup-archive client attempts to filter out file and directory objects that have name conflicts that are caused by different capitalization of the object names.
  - **Changingretries**  
The changingretries option specifies how many additional times you want the client to attempt to back up or archive a file that is in use. Use this option with the archive, incremental, and selective commands.

- **AIX | Solaris | Windows** **Class**  
The class option specifies whether to display a list of NAS or client objects when using the delete filespace, query backup, and query filespace commands.
- **Windows** **Clientview**  
The clientview option is available to users who have upgraded from the IBM® Tivoli® Storage Manager Express® backup client to the enterprise backup-archive client.
- **Windows** **Clusterdiskonly**  
The clusterdiskonly option specifies whether the backup-archive client allows the backup of only clustered disks in specific environments.
- **Windows** **Clusternode**  
The clusternode option specifies how the backup-archive client manages cluster drives.
- **Collocatebyfilespec**  
Use the collocatebyfilespec option to specify whether the backup-archive client uses only one server session to send objects generated from one file specification.
- **Commmethod**  
The commmethod option specifies the communication method you use to provide connectivity for client-server communication.
- **Commrestartduration**  
The commrestartduration option specifies the maximum number of minutes you want the client to try to reconnect to the IBM Spectrum Protect server after a communication error occurs.
- **Commrestartinterval**  
The commrestartinterval option specifies the number of seconds you want the client to wait between attempts to reconnect to the IBM Spectrum Protect server after a communication error occurs.
- **Compressalways**  
The compressalways option specifies whether to continue compressing an object if it grows during compression.
- **Compression**  
The compression option compresses files before you send them to the server.
- **Console**  
Use the console option with the query systeminfo command to output information to the console.
- **Createnewbase**  
The createnewbase option creates a base snapshot and uses it as a source to run a full incremental backup.
- **Datacenter**  
Specifies the target location of the data center that will contain the restored machine data.
- **Datastore**  
Specifies the datastore target to be used during VMware restore operation.
- **Dateformat**  
The dateformat option specifies the format you want to use to display or enter dates.
- **AIX | Linux | Solaris | Mac OS X | Windows** **Dedupcachepath**  
Use the dedupcachepath option to specify the location where the client-side data deduplication cache database is created.
- **AIX | Linux | Solaris | Mac OS X | Windows** **Dedupcachesize**  
Use the dedupcachesize option to determine the maximum size of the data deduplication cache file. When the cache file reaches its maximum size, the contents of the cache are deleted and new entries are added.
- **AIX | Linux | Solaris | Mac OS X | Windows** **Deduplication**  
Use the deduplication option to specify whether to enable redundant client-side data elimination when data is transferred to the IBM Spectrum Protect server during backup and archive processing.
- **AIX | Linux | Solaris | Mac OS X** **Defaultserver**  
Use the defaultserver option to specify the name of the IBM Spectrum Protect server to contact for backup-archive services if more than one server is defined in the dsm.sys file.
- **Deletefiles**  
Use the deletefiles option with the archive command to delete files from your workstation after you archive them.
- **Description**  
The description option assigns or specifies a description for files when performing archive, delete archive, retrieve, query archive, or query backupset.
- **Detail**  
Use the detail option to display management class, file space, backup, archive information, and additional information, depending on the command with which it is used.
- **Diffsnapshot**  
The diffsnapshot option controls whether the backup-archive client creates the differential snapshot when it runs a snapshot difference incremental backup.
- **Diffsnapshotname**  
The diffsnapshotname option allows you to specify which differential snapshot, on the target filer volume, to use during a snapshot differential backup. This option is only specified if you also specify diffsnapshot=latest.

- **Dirmc**  
The dirmc option specifies the management class you want to use for directories.
- **Dirsonly**  
The dirsonly option processes directories *only*. The client does not process files.
- **Disablenqr**  
The disablenqr option specifies whether the backup-archive client can use the no-query restore method for restoring files and directories from the server.
- **Diskbuffsize**  
The diskbuffsize option specifies the maximum disk I/O buffer size (in kilobytes) that the client can use when reading files. The diskbuffsize option replaces the largecommbuffers option.
- **Diskcachelocation**  
The diskcachelocation option specifies the location where the disk cache database is created if the option memoryefficientbackup=diskcachemethod is set during an incremental backup.
- **Domain**  
The domain option specifies what you want to include for incremental backup.
- **AIX Linux Solaris Windows Domain.image**  
The domain.image option specifies what you want to include in your client domain for an image backup.
- **AIX Solaris Windows Domain.nas**  
The domain.nas option specifies the volumes to include in your NAS image backups.
- **Linux Windows Domain.vmfull**  
The domain.vmfull option specifies the virtual machines (VMs) to include in your full virtual machine image backup operations.
- **Linux Dontload**  
x86\_64 Linux clients can use the dontload option to suppress specific plug-in libraries from being loaded when the backup-archive client is started.
- **AIX Linux Solaris Dynamicimage**  
Use the dynamicimage option with the backup image command or the include.image option to specify that you want to perform a dynamic image backup.
- **AIX Efsdecrypt**  
The efsdecrypt option allows you to control whether or not files encrypted by an AIX® Encrypted File System (EFS) are read in encrypted or decrypted format.
- **Windows Enable8dot3namesupport**  
The enable8dot3namesupport option specifies whether the client backs up and restores short 8.3 names for files that have long names on NTFS file systems.
- **Enablearchiveretentionprotection**  
The enablearchiveretentionprotection option allows the client to connect to the IBM Spectrum Protect for Data Retention server. This ensures that archive objects will not be deleted from the server until policy-based retention requirements for that object have been satisfied.
- **AIX Linux Solaris Mac OS X Windows Enablededupcache**  
Use the enablededupcache option to specify whether you want to use a cache during client-side data deduplication. Using a local cache can reduce network traffic between the IBM Spectrum Protect server and the client.
- **Enableinstrumentation**  
By default, instrumentation data is automatically collected by the backup-archive client and IBM Spectrum Protect API to identify performance bottlenecks during backup and restore processing. To disable or later enable instrumentation, use the enableinstrumentation option.
- **AIX Linux Solaris Windows Enablelanfree**  
The enablelanfree option specifies whether to enable an available LAN-free path to a storage area network (SAN) attached storage device.
- **AIX Linux Solaris Mac OS X Windows Encryptiontype**  
Use the encryptiontype option to specify the algorithm for data encryption.
- **Encryptkey**  
The backup-archive client supports the option to encrypt files that are being backed up or archived to the IBM Spectrum Protect server. This option is enabled with the include.encrypt option.
- **Errorlogmax**  
The errorlogmax option specifies the maximum size of the error log, in megabytes. The default name for the error log is dsmerror.log.
- **Errorlogname**  
This option specifies the fully qualified path and file name of the file that contains the error messages.
- **Errorlogretention**  
The errorlogretention option specifies how many days to maintain error log entries before pruning, and whether to save the pruned entries in other files.

- Exclude options  
Use the exclude options to exclude objects from backup, image, or archive services.
- **Linux** **Windows** **Fbbranch**  
Use the fbbranch option with the backup fastback or archive fastback commands.
- **Linux** **Windows** **Fbclientname**  
Use the fbclientname option with the backup fastback or archive fastback commands.
- **Linux** **Windows** **Fbpolicyname**  
Use the fbpolicyname option with the backup fastback or archive fastback commands.
- **Linux** **Windows** **Fbreposlocation**  
Use the fbreposlocation option with the backup fastback or archive fastback commands.
- **Linux** **Windows** **Fbserver**  
Use the fbserver option with the backup fastback or archive fastback commands.
- **Linux** **Windows** **Fbvolumename**  
Use the fbvolumename option with the backup fastback or archive fastback commands.
- Filelist  
Use the filelist option to process a list of files.
- Filename  
Use the filename option with the query systeminfo command to specify a file name in which to store information.
- Filesonly  
The filesonly option restricts backup, restore, retrieve, or query processing to files *only*.
- **AIX** **Linux** **Solaris** **Followsymbolic**  
During a backup operation, the followsymbolic option specifies whether you want to use a symbolic link as a virtual mount point. During a restore or retrieve operation, the followsymbolic option specifies how the backup-archive client restores a directory whose name matches a symbolic link on the restore target file system.
- Forcefailover  
The forcefailover option enables the client to immediately fail over to the secondary server.
- Fromdate  
Use the fromdate option with the fromtime option to specify a date and time from which you want to search for backups or archives during a restore, retrieve, or query operation.
- Fromnode  
The fromnode option permits one node to perform commands for another node. A user on another node must use the set access command to permit you to query, restore, or retrieve files for the other node.
- **AIX** **Linux** **Solaris** **Mac OS X** **Fromowner**  
The fromowner option specifies an alternate owner from which to restore backup versions or archived files or images. The owner must give access to another to use the files or images.
- Fromtime  
Use the fromtime option with the fromdate option to specify a beginning time from which you want to search for backups or archives during a restore, retrieve, or query operation.
- Groupname  
Use the groupname option with the backup group command to specify the name for a group. You can only perform operations on new groups or the current active version of the group.
- **AIX** **Linux** **Solaris** **Mac OS X** **Groups (deprecated)**  
This option is deprecated.
- Host  
The host option specifies the target ESX server location where the new virtual machine is created during a VMware restore operation.
- Httpport  
The httpport option specifies a TCP/IP port address for the web client.
- Hsmreparsetag  
The hsmreparsetag option specifies a unique reparse tag that is created by an HSM product installed on your system.
- **AIX** **Linux** **Solaris** **Mac OS X** **Windows** **Ieobjtype**  
Use the ieobjtype option to specify an object type for a client-side data deduplication operation within include-exclude statements.
- Ifnewer  
The ifnewer option replaces an existing file with the latest backup version only if the backup version is newer than the existing file.
- **AIX** **Windows** **Imagegapsize**  
Use the imagegapsize option with the backup image command, in the options file, or with the include.image option to specify the minimum size of empty regions on a volume that you want to skip during image backup.
- **AIX** **Linux** **Solaris** **Windows** **Imagetofile**  
Use the imagetofile option with the restore image command to specify that you want to restore the source image to a file.

- Inactive  
Use the inactive option to display both active and inactive objects.
- Inclexcl  
The inclexcl option specifies the path and file name of an include-exclude options file.
- Include options  
The include options specify objects that you want to include for backup and archive services.
- Incrbydate  
Use the incrbydate option with the incremental command to back up new and changed files with a modification date later than the last incremental backup stored at the server, unless you exclude the file from backup.
- **AIX** **Linux** **Solaris** **Windows** Incremental  
Use the incremental option with the restore image command to ensure that any changes that were made to the base image are also applied to the restored image.
- **Windows** Incrthreshold  
The incrthreshold option specifies the threshold value for the number of directories in any journaled file space that might have active objects on the server, but no equivalent object on the workstation.
- Instrlogmax  
The instrlogmax option specifies the maximum size of the instrumentation log (dsminstr.log), in MB. Performance data for the client is collected in the dsminstr.log file during backup or restore processing when the enableinstrumentation option is set to yes.
- Instrlogname  
The instrlogname option specifies the path and file name where you want to store performance information that the backup-archive client collects.
- **Windows** Journalpipe  
The journalpipe option specifies the pipe name of a journal daemon session manager to which the backup clients attach.
- **AIX** **Linux** **Solaris** **Windows** Lanfreecommmethod  
The lanfreecommmethod option specifies the communications protocol between the IBM Spectrum Protect client and Storage Agent. This enables processing between the client and the SAN-attached storage device.
- **AIX** **Solaris** **Windows** Lanfreeshmport  
Use the lanfreeshmport option when lanfreecommmethod=SHAREdmem is specified for communication between the backup-archive client and the storage agent. This enables processing between the client and the SAN-attached storage device.
- **AIX** **Linux** **Solaris** **Windows** Lanfreetcport  
The lanfreetcport option specifies the TCP/IP port number where the IBM Spectrum Protect Storage Agent is listening.
- **AIX** **Linux** **Mac OS X** **Solaris** **Windows** Lanfreessl  
Use the lanfreessl option to enable Secure Sockets Layer (SSL), to provide secure client and Storage Agent communications. This option is deprecated if you are connecting to an IBM Spectrum Protect server V8.1.2 and later.
- **AIX** **Linux** **Solaris** **Windows** Lanfreetcserveraddress  
The lanfreetcserveraddress option specifies the TCP/IP address for the IBM Spectrum Protect Storage Agent.
- **Windows** Language  
The language option specifies the national language in which to present client messages.
- Latest  
Use the latest option to restore the most recent backup version of a file, even if the backup is inactive.
- **AIX** **Linux** **Solaris** **Mac OS X** **Windows** Localbackupset  
The localbackupset option specifies whether the backup-archive client GUI bypasses initial logon with the IBM Spectrum Protect server to restore a local backup set on a standalone workstation.
- **AIX** **Linux** **Solaris** Makesparsefile  
Use the makesparsefile option with the restore or retrieve commands to specify how sparse files are recreated.
- Managedservices  
The managedservices option specifies whether the IBM Spectrum Protect client acceptor service manages the scheduler, the web client, or both.
- Maxcmdretries  
The maxcmdretries option specifies the maximum number of times the client scheduler (on your workstation) attempts to process a scheduled command that fails.
- Mbjrefreshtresh  
The mbjrefreshtresh (megablock object refresh threshold) option is a number defining a threshold. When the number of IBM Spectrum Protect objects that are needed to describe any 128 MB megablock exceeds this value, the entire megablock is refreshed and the objects that were used to represent this area, in previous backups, are expired.
- Mbpctrefreshtresh  
The mbpctrefreshtresh (megablock percentage refresh threshold) option is a number defining a threshold. When the percentage of IBM Spectrum Protect objects that are needed to describe any 128 MB megablock exceeds this value, the entire megablock is refreshed and the objects that were used to represent this area, in previous backups, are expired.

- **Memoryefficientbackup**  
The memoryefficientbackup option specifies the memory-conserving algorithm to use for processing full file space backups.
- **Mode**  
Use the mode option to specify the backup mode to use when performing specific backup operations.
- **AIX Solaris Windows Monitor**  
The monitor option specifies whether to monitor an image backup or restore of file systems belonging to a Network Attached Storage (NAS) file server.
- **Windows Myprimaryserver**  
The myprimaryserver option specifies the primary server name that the client uses to log on to the secondary server in failover mode.
- **Myreplicationserver**  
The myreplicationserver option specifies which secondary server stanza that the client uses during a failover.
- **Windows Namedpipename**  
The namedpipename option specifies the name of a named pipe to use for communications between a client and a server on the same Windows server domain.
- **AIX Solaris Windows Nasnodename**  
The nasnodename option specifies the node name for the NAS file server when processing NAS file systems. The client prompts you for an administrator ID.
- **AIX Linux Solaris Mac OS X Nfstimeout**  
The nfstimeout option specifies the number of seconds the client waits for a status system call on an NFS file system before it times out.
- **Nodename**  
Use the nodename option in your client options file to identify your workstation to the server. You can use different node names to identify multiple operating systems on your workstation.
- **Windows Nojournal**  
Use the nojournal option with the incremental command to specify that you want to perform a traditional full incremental backup, instead of the default journal-based backup.
- **AIX Nojournal**  
Use the nojournal option with the incremental command to specify that you want to perform a traditional full incremental backup, instead of the default journal-based backup.
- **Noprompt**  
The noprompt option suppresses the confirmation prompt that is presented by the delete group, delete archive, expire, restore image, and set event commands.
- **Nrtablepath**  
The nrtablepath option specifies the location of the node replication table on the client. The backup-archive client uses this table to store information about each backup or archive operation to the IBM Spectrum Protect server.
- **Numberformat**  
The numberformat option specifies the format you want to use to display numbers.
- **Optfile**  
The optfile option specifies the client options file to use when you start a backup-archive client session.
- **Password**  
The password option specifies a password for IBM Spectrum Protect.
- **Passwordaccess**  
The passwordaccess option specifies whether you want to generate your password automatically or set as a user prompt.
- **AIX Linux Solaris Mac OS X Passworddir**  
The passworddir option specifies the directory location in which to store an encrypted password file.
- **Pick**  
The pick option creates a list of backup versions or archive copies that match the file specification you enter.
- **Pitdate**  
Use the pitdate option with the pittime option to establish a point in time to display or restore the latest version of your backups.
- **Pittime**  
Use the pittime option with the pitdate option to establish a point in time to display or restore the latest version of your backups.
- **AIX Linux Solaris Mac OS X Windows Postschedulecmd/Postnschedulecmd**  
The postschedulecmd/postnschedulecmd option specifies a command that the client program processes after it runs a schedule.
- **AIX Linux Windows Postsnapshotcmd**  
The postsnapshotcmd option allows you to run operating system shell commands or scripts after the backup-archive client starts a snapshot during a snapshot-based backup operation.



- **AIX Linux Solaris Mac OS X Windows** Preschedulecmd/Prenschedulecmd  
The preschedulecmd option specifies a command that the client program processes before it runs a schedule.
- **AIX Linux Solaris Windows** Preservelastaccessdate  
Use the preservelastaccessdate option to specify whether a backup or archive operation changes the last access time.
- Preservepath  
The preservepath option specifies how much of the source path to reproduce as part of the target directory path when you restore or retrieve files to a new location.
- **AIX Linux Windows** Presnapshotcmd  
The presnapshotcmd option allows you to run operating system commands before the backup-archive client starts a snapshot.
- Queryschedperiod  
The queryschedperiod option specifies the number of hours you want the client scheduler to wait between attempts to contact the server for scheduled work.
- Querysummary  
The querysummary option provides statistics about files, directories and objects that are returned by the query backup or query archive commands.
- Quiet  
The quiet option limits the number of messages that are displayed on your screen during processing..
- Quotesareliteral  
The quotesareliteral option specifies whether single quotation marks (') or double quotation marks (") are interpreted literally, when they are included in a file list specification on a filelist option.
- **AIX Linux Solaris Mac OS X** Removeoperandlimit  
The removeoperandlimit option specifies that the client removes the 20-operand limit.
- Replace  
The replace option specifies whether to overwrite existing files on your workstation, or to prompt you for your selection when you restore or retrieve files.
- Replserverguid  
The replserverguid option specifies the globally unique identifier (GUID) that is used when the client connects to the secondary server during failover. The GUID is used to validate the secondary server to ensure that it is the expected server.
- Replservername  
The replservername option specifies the name of the secondary server that the client connects to during a failover.
- Replsslport  
The replsslport option specifies the TCP/IP port on the secondary server that is SSL-enabled. The replsslport option is used when the client connects to the secondary server during a failover. This option is deprecated if you are connecting to an IBM Spectrum Protect server V8.1.2 and later.
- Repltcpport  
The repltcpport option specifies the TCP/IP port on the secondary server to be used when the client connects to the secondary server during a failover.
- Repltcpserveraddress  
The repltcpserveraddress option specifies the TCP/IP address of the secondary server to be used when the client connects to the secondary server during a failover.
- **Windows** Resetarchiveattribute  
Use the resetarchiveattribute option to specify whether the backup-archive client resets the Windows archive attribute on files that are successfully backed up to the IBM Spectrum Protect server.
- Resourceutilization  
Use the resourceutilization option in your option file to regulate the level of resources the IBM Spectrum Protect server and client can use during processing.
- Retryperiod  
The retryperiod option specifies the number of minutes the client scheduler waits between attempts to process a scheduled command that fails, or between unsuccessful attempts to report results to the server. Use this option only when the scheduler is running.
- Revokeremoteaccess  
The revokeremoteaccess option restricts an administrator with client access privilege from accessing a client workstation that is running the web client.
- **Windows** Runasservice  
The runasservice option forces the client command process to continue running, even if the account that started the client logs off.
- Schedcmddisabled  
The schedcmddisabled option specifies whether to disable the scheduling of commands by the server action=command option on the define schedule server command.
- Schedcmdexception  
The schedcmdexception option is used in conjunction with the schedcmddisabled option to disable the scheduling of

commands by the server action=command option on the DEFINE SCHEDULE server command, except for specific command strings.

- **Schedgroup**  
The schedgroup option assigns a schedule to a group.
- **Schedlogmax**  
The schedlogmax option specifies the maximum size of the schedule log (dsmsched.log) and web client log (dsmwebcl.log), in megabytes.
- **Schedlogname**  
The schedlogname option specifies the path and file name where you want to store schedule log information.
- **Schedlogretention**  
The schedlogretention option specifies the number of days to keep entries in the schedule log (dsmsched.log) and the web client log (dsmwebcl.log), and whether to save the pruned entries in another file.
- **Schedmode**  
The schedmode option specifies whether you want to use the polling mode (your client node periodically queries the server for scheduled work), or the prompted mode (the server contacts your client node when it is time to start a scheduled operation).
- **Schedrestretrdisabled**  
The schedrestretrdisabled option specifies whether to disable the execution of restore or retrieve schedule operations.
- **Scrolllines**  
The scrolllines option specifies the number of lines of information that are displayed on your screen at one time.
- **Scrollprompt**  
The scrollprompt option specifies whether you want the backup-archive client to stop and wait after displaying the number of lines of information you specified with the scrolllines option, or scroll through and stop at the end of the information list.
- **AIX Linux Solaris Mac OS X Servername**  
In your dsm.sys file, the servername option specifies the name you want to use to identify a server and to begin a stanza containing options for that server. You can name and specify options for more than one server.
- **Sessioninitiation**  
Use the sessioninitiation option to control whether the server or client initiates sessions through a firewall. The default is that the client initiates sessions. You can use this option with the schedule command.
- **Setwindowtitle**  
Use the setwindowtitle option to modify the title of the administrative client command window during processing.
- **AIX Linux Solaris Windows Shmport**  
The shmport option specifies the TCP/IP port address of a server when using shared memory. All shared memory communications start with a TCP/IP connection.
- **AIX Linux Solaris Windows Showmembers**  
Use the showmembers option to display all members of a group.
- **AIX Linux Solaris Mac OS X Skipacl**  
The skipacl option allows you to include or exclude access control list (ACL) data during a backup or archive operation; by default, ACL data is included.
- **AIX Linux Solaris Mac OS X Skipaclupdatecheck**  
The skipaclupdatecheck option disables checksum and size comparisons of ACL data.
- **Windows Skipmissingsyswfiles**  
Use the skipmissingsyswfiles option to specify whether the backup-archive client skips certain missing VSS writer files and continues the system state backup.
- **Windows Skipntpermissions**  
The skipntpermissions option bypasses processing of Windows file system security information.
- **Windows Skipntsecuritycrc**  
The skipntsecuritycrc option controls the computation of the security cyclic redundancy check (CRC) for a comparison of Windows NTFS or ReFS security information during an incremental or selective backup, archive, restore, or retrieve operation.
- **Windows Skipsystemexclude**  
Use the skipsystemexclude option to specify how to process exclude statements for certain operating system files that the IBM Spectrum Protect for Virtual Environments client skips by default.
- **Linux Windows Snapdiff**  
Using the snapdiff option with the incremental command streamlines the incremental backup process. The command runs an incremental backup of the files that were reported as changed by NetApp instead of scanning all of the volume for changed files.
- **Linux Windows Snapdiffchangelogdir**  
The snapdiffchangelogdir option defines the location where the client stores persistent change logs that are used for snapshot differential backup operations.
- **Linux Windows Snapdiffhttps**  
Specify the snapdiffhttps option to use a secure HTTPS connection for communicating with a NetApp filer during a

snapshot differential backup.

- **AIX Linux** Snapshotcachesize  
Use the snapshotcachesize option to specify an appropriate size to create the snapshot.
- **AIX Windows** Snapshotproviderfs  
Use the snapshotproviderfs option to enable snapshot-based file backup and archive operations, and to specify a snapshot provider.
- **AIX Linux Windows** Snapshotproviderimage  
Use the snapshotproviderimage option to enable snapshot-based image backup, and to specify a snapshot provider.
- **AIX Linux Solaris Windows** Snapshotroot  
Use the snapshotroot option with the incremental, selective, or archive commands with an independent software vendor application that provides a snapshot of a logical volume, to associate the data on the local snapshot with the real file space data that is stored on the IBM Spectrum Protect server.
- Srvoptsetencryptiondisabled  
The srvoptsetencryptiondisabled option allows the client to ignore encryption options in a client options set from the IBM Spectrum Protect server.
- Srvprepostscheddisabled  
The srvprepostscheddisabled option specifies whether to prevent the pre-schedule and post-schedule commands specified by the IBM Spectrum Protect administrator from executing on the client system, when performing scheduled operations.
- **Linux Windows** Srvprepostsnapdisabled  
The srvprepostsnapdisabled option specifies whether to prevent the pre-snapshot and post-snapshot commands specified by the IBM Spectrum Protect administrator from executing on the client system, when performing scheduled image snapshot backup operations.
- **AIX Linux Solaris Windows** Ssl  
Use the ssl option to enable Secure Sockets Layer (SSL) to provide secure client and server communications. When the backup-archive client communicates with an IBM Spectrum Protect server V8.1.1 and earlier V8 levels, and V7.1.7 and earlier levels, it determines whether SSL is enabled. When the backup-archive client communicates with an IBM Spectrum Protect server V8.1.2 and later, SSL is always used and this option controls whether object data is encrypted or not. For performance reasons, it might be desirable to not encrypt the object data.
- **AIX Linux Mac OS X Solaris Windows** Sslacceptcertfromserv  
Use the sslacceptcertfromserv option to control whether the backup-archive client or the API application accept and trust the IBM Spectrum Protect server's Secure Sockets Layer (SSL) public certificate the first time they connect. This option applies only the first time that the backup-archive client or the API application connects to the IBM Spectrum Protect server. When the SSL public certificate is accepted, future changes to the certificate are not automatically accepted, and must be manually imported to the backup-archive client. You can use this option to connect only to an IBM Spectrum Protect server V8.1.2 and later.
- **AIX Linux Mac OS X Solaris Windows** Ssldisablelegacytls  
Use the ssldisablelegacytls option to disallow the use of SSL protocols that are lower than TLS 1.2.
- Sslfipsmode  
The sslfipsmode option specifies whether the client uses SSL Federal Information Processing Standards (FIPS) mode for Secure Sockets Layer (SSL) communications with the server. The default is no.
- **AIX Linux Mac OS X Solaris Windows** Sslrequired  
The sslrequired option specifies the conditions when SSL is or is not required when the client logs on to the IBM Spectrum Protect server or storage agents. To actually enable SSL so client-to-server and client-to-storage-agent communications are secure, you must set the client ssl option to yes. When communicating with the IBM Spectrum Protect server V8.1.2 and later, this option no longer applies since SSL is always used.
- **AIX Windows** Stagingdirectory  
The stagingdirectory option defines the location where the client stores any data that it generates to perform its operations. The data is deleted when processing is complete.
- Subdir  
The subdir option specifies whether you want to include subdirectories of named directories for processing.
- **Windows** Systemstatebackupmethod  
Use the systemstatebackupmethod option to specify which backup method to use to back up the system writer portion of the system state data. The method you select is used when you backup the system state data.
- Tapeprompt  
The tapeprompt option specifies whether you want the backup-archive client to wait for a tape mount if it is required for a backup, archive, restore, or retrieve process, or to be prompted for a choice.
- **AIX Linux Solaris Mac OS X Windows** Tcadminport  
Use the tcadminport option to specify a separate TCP/IP port number on which the server waits for requests for administrative client sessions, allowing secure administrative sessions within a private network.
- Tcpcbuffersize  
The tcpcbuffersize option specifies the size of the internal TCP/IP communication buffer used to transfer data between the

client node and server. Although it uses more memory, a larger buffer can improve communication performance.

- **Tpcaddress**  
The `tpcaddress` option specifies a TCP/IP address for `dsmcad`. Normally, this option is not needed. Use this option only if your client node has more than one TCP/IP address, or if TCP/IP is not the default communication method.
- **Tpclientaddress**  
The `tpclientaddress` option specifies a TCP/IP address if your client node has more than one address, and you want the server to contact an address other than the one that was used to make the first server contact.
- **Tpclientport**  
The `tpclientport` option specifies a TCP/IP port number for the server to contact the client when the server begins the server prompted scheduled operation.
- **Tcpnodelay**  
The `tcpnodelay` option specifies whether the client disables the delay of sending successive small packets on the network, per transaction.
- **Tcpport**  
The `tcpport` option specifies a TCP/IP port address for the IBM Spectrum Protect server. You can obtain this address from your administrator.
- **Tcpserveraddress**  
The `tcpserveraddress` option specifies the TCP/IP address for the IBM Spectrum Protect server. You can obtain this server address from your administrator.
- **Tcpwindowsize**  
Use the `tcpwindowsize` option to specify, in kilobytes, the size you want to use for the TCP/IP sliding window for your client node.
- **Timeformat**  
The `timeformat` option specifies the format in which you want to display and enter system time.
- **AIX Solaris Windows Toc**  
Use the `toc` option with the `backup nas` command or the `include.fs.nas` option to specify whether the backup-archive client saves table of contents (TOC) information for each file system backup.
- **Todate**  
Use the `todate` option with the `totime` option to specify an ending date and time to which you want to search for backups or archives during a restore, retrieve, or query operation.
- **Totime**  
Use the `totime` option with the `todate` option to specify an ending date and time to which you want to search for backups or archives during a restore, retrieve, or query operation. The backup-archive client ignores this option if you do not specify the `todate` option.
- **Txnbytelimit**  
The `txnbytelimit` option specifies the number of kilobytes the client program buffers before it sends a transaction to the server.
- **Type**  
Use the `type` option with the `query node` command to specify the type of node to query. Use this option with the `set event` command to activate, hold, or release.
- **Updatectime**  
Use the `updatectime` option to check the change time (ctime) attribute during an incremental backup operation.
- **Windows Usedirectory**  
The `usedirectory` option queries the Active Directory for the communication method and server with which to connect.
- **Useexistingbase**  
The `useexistingbase` option is used when you back up snapshots that are on NetApp filer volumes. The `useexistingbase` option indicates that the latest snapshot that exists on the volume being backed up, is to be used as the base snapshot, during a snapshot differential backup operation.
- **Usereplicationfailover**  
The `usereplicationfailover` option specifies whether automated client failover occurs on a client node.
- **AIX Linux Solaris Mac OS X Users (deprecated)**  
This option is deprecated.
- **V2archive**  
Use the `v2archive` option with the `archive` command to archive only files to the server.
- **Verbose**  
The `verbose` option specifies that you want to display detailed processing information on your screen. This is the default.
- **AIX Linux Solaris Windows Verifyimage**  
Use the `verifyimage` option with the `restore image` command to specify that you want to enable detection of bad sectors on the destination target volume.
- **Virtualfsname**  
Use the `virtualfsname` option with the `backup group` command to specify the name of the virtual file space for the group on which you want to perform the operation. The `virtualfsname` cannot be the same as an existing file space name.

- **AIX** | **Linux** | **Solaris** | **Mac OS X** **Virtualmountpoint**  
The virtualmountpoint option defines a virtual mount point for a file system if you want to consider files for backup that begin with a specific directory within that file system.
- **Virtualnodename**  
The virtualnodename option specifies the node name of your workstation when you want to restore or retrieve files to a different workstation.
- **Windows** **Vmautostartvm**  
Use the vmautostartvm option with the restore VM vmrestoretype=instantaccess command to specify whether the VM created during instant access processing is automatically powered on.
- **Linux** | **Windows** **Vmbackdir**  
The vmbackdir option specifies the temporary disk location where the client saves control files that are created during full VM backup and restore operations of virtual machines.
- **Linux** | **Windows** **Vmbackuplocation**  
Use the vmbackuplocation option with the backup vm or restore vm commands to specify the backup location for virtual machine backup and restore operations.
- **Linux** | **Windows** **Vmbackupmailboxhistory**  
The vmbackupmailboxhistory option specifies whether mailbox history is automatically uploaded with the virtual machine (VM) backup if IBM Spectrum Protect for Mail: Data Protection for Microsoft Exchange Server is detected on a VM.
- **Linux** | **Windows** **Vmbackuptype**  
Use the vmbackuptype option with the backup VM or restore VM command to specify to specify the type of virtual machine backup or restore to complete. You can also use this option on query VM commands to filter the query results to include only virtual machines that were backed up by a specific backup type. For examples, see the query VM command description.
- **Linux** | **Windows** **Vmchost**  
Use the vmchost option with the backup VM, restore VM, or query VM commands to specify the host name of the VMware VirtualCenter or ESX server that you want to backup, restore, or query.
- **Linux** | **Windows** **Vmcpw**  
Use the vmcpw option with the backup VM, restore VM, or query VM commands to specify the password for the VMware VirtualCenter or the ESX user ID that is specified with the vmcuser option.
- **Vmctlmc**  
This option specifies the management class to use when backing up virtual machine control files.
- **Linux** | **Windows** **Vmcuser**  
Use the vmcuser option with the backup VM, restore VM, or query VM commands to specify the user name of the VMware VirtualCenter or ESX server that you want to backup, restore, or query.
- **Linux** | **Windows** **Vmdatstorethreshold**  
Use the vmdatstorethreshold option to set the threshold percentage of space usage for each VMware datastore of a virtual machine.
- **Linux** | **Windows** **Vmdefaultdvportgroup**  
Use this option to specify the port group for the NICs to use during restore vm operations for a virtual machine that was connected to a distributed virtual port group when it was backed up, but the target host for the restore operation does not contain a similar distributed virtual port group.
- **Linux** | **Windows** **Vmdefaultdvswitch**  
Use this option to specify the distributed virtual switch (dvSwitch) that contains the port group that you set on the vmdefaultdvportgroup option. The option has no effect unless you also specify the vmdefaultdvportgroup option.
- **Linux** | **Windows** **Vmdefaultnetwork**  
Use this option to specify the network for NICs to use during a restore vm operation, for a virtual machine that had been connected to a distributed virtual port group when it was backed up, but the target host for the restore operation does not have any distributed switch port groups configured.
- **Windows** **Vmdiskprovision**  
Use the vmdiskprovision option to specify a provisioning policy for the virtual disk file that is used to restore VMware virtual machine data. This option is valid only for restore vm operations where vmrestoretype=instantrestore is specified.
- **Vmenabletemplatebackups**  
The vmenabletemplatebackups option specifies whether the client backs up VMware template virtual machines when it protects virtual machines in a vCenter server. VMware templates virtual machines cannot be backed up when they are in an ESXi host because ESXi does not support templates.
- **Windows** **Vmexpireprotect**  
Use this option to protect virtual machine snapshots so that they cannot be expired while an instant restore or instant access operation of VMware VMs or while a file-level restore of a VMware VM is in progress. Use this option to protect virtual machine snapshots so that they cannot be expired while an instant restore or instant access operation of Hyper-V VMs or while a file-level restore of a Hyper-V VM is in progress.
- **Vmiscsadapter**  
This option specifies which iSCSI adapter, on the ESX host, to use for instant restore and instant access operations for

VMware virtual machines.

- **Windows** `Vmiscsiserveraddress`  
Use the `vmiscsiserveraddress` option with the `restore VM` command to specify the host name or the IP address of the iSCSI server that provides the iSCSI targets for instant restore and instant access operations.
- `Vmlimitperdatastore`  
The `vmlimitperdatastore` option specifies the number of virtual machines (VMs) and virtual disks in a datastore that can be processed in parallel during an optimized backup operation.
- `Vmlimitperhost`  
The `vmlimitperhost` option specifies the number of virtual machines (VMs) and virtual disks in a host that can be processed in parallel during an optimized backup operation.
- **Windows** `Vmplist`  
The `vmplist` option is deprecated for Hyper-V backup operations. To specify one or more Hyper-V virtual machines (VMs) to include in Data Protection for Microsoft Hyper-V backup operations, use the `domain.vmfull` option or specify the VMs when you run the `backup vm` command.
- `Vmmaxbackupsessions`  
The `vmmaxbackupsessions` option specifies the maximum number IBM Spectrum Protect server sessions that move virtual machine (VM) data to the server that can be included in an optimized backup operation.
- `Vmmaxparallel`  
The `vmmaxparallel` option is used to configure optimized backups of several virtual machines by using a single instance of the backup-archive client. This option specifies the maximum number of virtual machines that can be backed up to the IBM Spectrum Protect server at any one time.
- **Windows** `Vmmaxpersnapshot`  
Use the `vmmaxpersnapshot` option to specify the maximum number of virtual machines (VMs) to include in a Hyper-V snapshot. The VMs in the snapshot are backed up to the IBM Spectrum Protect server.
- `Vmmaxrestoresessions`  
The `vmmaxrestoresessions` option specifies the maximum number of IBM Spectrum Protect server sessions that can be included in an optimized restore operation for a virtual machine (VM).
- `Vmmaxrestoreparalleldisks`  
The `vmmaxrestoreparalleldisks` option enables an IBM Spectrum Protect client to restore multiple virtual disks at the same time.
- **Windows** `Vmmaxsnapshotretry`  
Use the `vmmaxsnapshotretry` option to specify the maximum number of times to retry a snapshot operation of a virtual machine (VM) if the initial snapshot fails with a recoverable condition.
- `Vmmaxvirtualdisks`  
The `vmmaxvirtualdisks` option specifies the maximum size of the VMware virtual machine disks (VMDKs) to include in a backup operation.
- **Linux** | **Windows** `Vmmc`  
Use the `vmmc` option to store virtual machine backups by using a management class other than the default management class. For VMware VM backups, the `vmmc` option is valid only if the `vmbackuptype=fullvm` option is set.
- `Vmmountage`  
Use the `vmmountage` option with the `restore VM "*" -vmrestoretype=mountcleanupall` command to specify the number of hours that a VM file level restore mount must be active to be cleaned up.
- **Linux** | **Windows** `Vmnoprmdisks`  
This option enables the client to restore configuration information for the pRDM volumes that are associated with a VMware virtual machine, even if the LUNs that were associated with the volumes cannot be found. Because pRDM volumes are not included in virtual machine snapshot, only the configuration information can be restored, and not the data that was on the volumes.
- **Linux** | **Windows** `Vmnovrmdisks`  
This option enables the client to restore configuration information and data for vRDM volumes that are associated with a VMware virtual machine, even if the LUNs that were associated with the volumes cannot be found.
- **Linux** | **Windows** `Vmpreferdagpassive`  
The `vmpreferdagpassive` option specifies whether to back up an active copy or passive copy of a database that is part of a Microsoft Exchange Server Database Availability Group (DAG).
- **Linux** | **Windows** `Vmprocessvmwithindependent`  
Use this option to control whether full VMware virtual machine backups are processed if the machine is provisioned with one or more independent disk volumes.
- `Vmprocessvmwithphysdisks`  
Use the `vmprocessvmwithphysdisks` option to control whether Hyper-V RCT virtual machine (VM) backups are processed if the VM has one or more physical disks (pass-through disks) provisioned.
- **Linux** | **Windows** `Vmprocessvmwithprdm`  
Use this option to control whether full VMware virtual machine backups are processed if the virtual machine has one or more raw device mapping (RDM) volumes provisioned in physical-compatibility mode (pRDM).



- **Windows** `Vmrestoretype`  
Use the `vmrestoretype` option with the query VM or restore VM commands to specify the type of restore operation to perform or query.
- **Windows** | **Linux** `Vmskipctlcompression`  
Use the `vmskipctlcompression` option for VM backups to specify whether control files (\*.ctl) are compressed during VM backup. The option does not affect the compression of data files (\*.dat)
- `Vmskipmaxvirtualdisks`  
The `vmskipmaxvirtualdisks` option specifies how the backup operation processes VMware virtual machine disks (VMDKs) that exceed the maximum disk size.
- `Vmskipmaxvmdks`  
The `vmskipmaxvmdks` option specifies how the backup operation processes VMware virtual machine disks (VMDKs) that exceed the maximum disk size.
- `Vmskipphysdisks`  
Use the `vmskipphysdisks` option to restore configuration information for physical disks (pass-through disks) that are associated with a Hyper-V virtual machine (VM), if the logical unit numbers (LUNs) that are associated with the volumes on the physical disks are available.
- **Windows** `Vmstoragetype`  
Use the `vmstoragetype` option with the restore VM command to specify the storage device type from which the snapshot is mounted with IBM Spectrum Protect recovery agent.
- **Linux** | **Windows** `Vmtagdatamover`  
Use the `vmtagdatamover` option to enable tagging support in the backup-archive client (data mover). When this option is enabled, the client manages backups of virtual machines in VMware inventory objects according to the data protection tags that are set by the IBM Spectrum Protect vSphere Client plug-in of the vSphere Web Client, or set with tools such as VMware vSphere PowerCLI Version 5.5 R2 or later.
- **Linux** | **Windows** `Vmtagdefaultdatamover`  
Use the `vmtagdefaultdatamover` option to protect virtual machines, defined in a schedule, that do not have an assigned or inherited `Data Mover` category and tag.
- **Windows** `Vmtempdatastore`  
Use the `vmtempdatastore` option with the restore VM command to define a temporary datastore on the ESX host for an instant restore operation.
- `Vmverifyifaction`  
Use this option to specify the action to perform if the data mover detects integrity problems with the latest CTL and bitmap files for a virtual machine.
- `Vmverifyiflatest`  
This option applies only to VMware virtual machine (VM) backup operations that use the incremental-forever-incremental backup mode (that is, a backup `vm` command with `-mode=IFIncremental` specified). If this `vmverifyiflatest` option is enabled, the data mover runs an integrity check on the CTL and bitmap files that were created on the server during the last backup, if the last backup was an incremental-forever-incremental backup.
- **Linux** | **Windows** `Vmvstortransport`  
The `vmvstortransport` option specifies the preferred transports order (hierarchy) to use when backing up or restoring VMware virtual machines. If you do not include a given transport using this option, that transport is excluded and is not used to transfer data.
- **Windows** `Vssaltstagingdir`  
The `vssaltstagingdir` option specifies the fully qualified path that contains the system exclude cache and temporary data for VSS snapshot operation.
- **Windows** `Vssusesystemprovider`  
The `vssusesystemprovider` option specifies whether to use the Windows system provider, or to let Windows decide the most suitable provider to use.
- **Linux** | **Windows** `Vmtimeout`  
`VMTIMEOut` specifies the maximum time, in seconds, to wait before abandoning a backup `vm` operation, when the `INCLUDE.VMTSMVSS` option is used to provide application protection. To use this option, the IBM Spectrum Protect for Virtual Environments license must be installed.
- `Webports`  
The `webports` option enables the use of the web client outside a firewall.
- `Wildcard sareliteral`  
The `wildcardsareliteral` option specifies whether question marks (?) and asterisks (\*) are interpreted literally, when they are included in a file list specification on a `filelist` option.

Use the absolute option with the incremental command to force a backup of all files and directories that match the file specification or domain, even if the objects were not changed since the last incremental backup.

This option overrides the management class copy group mode parameter for backup copy groups; it does not affect the frequency parameter or any other backup copy group parameters. This option does not override exclude statements, so objects that are excluded from backup are not eligible for backup even when the absolute option is specified.

Important: Before you use the absolute option, consider the following effects that this option can have on backup and IBM Spectrum Protect™ server operations:

- Backups consume more server storage and database resources.
- Backups consume more network bandwidth.
- Server operations, such as inventory expiration, storage pool backup, storage pool migration, reclamation, and node replication, require more time to complete. Data deduplication might help mitigate some of these effects, but it does not avoid the processing that is required to reconstitute the deduplicated data back to its original form when the storage pool is migrated or backed up to non-deduplicated storage.

This option is valid only as a command-line parameter for the incremental command when you are performing the following operations:

- Full or partial progressive incremental backups of file systems or disk drives.
- Snapshot differential backups when createnewbase=yes is also specified.

To force a full backup of a file system that uses journal-based backup, specify both the nojournal and absolute options on the incremental command.

**Windows** During a domain incremental backup, where systemstate is specified as part of the domain, the absolute option does not force a full backup of system state objects. To force a domain incremental backup operation to create a full backup of system state objects, you must add systemstatebackupmethod full to the client options file.

To use the absolute option on scheduled incremental backups, the IBM Spectrum Protect server administrator must create a separate backup schedule that includes the absolute option on the schedule's options parameter.

## Supported Clients

---

This option is valid for all clients as a command-line parameter for the incremental command. This option cannot be added to a client option set on the IBM Spectrum Protect server.

## Syntax

---

```
>>-ABSolute-----<<
```

## Parameters

---

There are no parameters for this option.

## Examples

---

Command line:

**AIX** | **Linux** | **Mac OS X** | **Solaris**

```
dsmc incr -absolute "/Users/sparky/source/*.c"
```

**Windows**

```
dsmc incr -absolute c:\foo\*.c
```

**Windows**

## Adlocation

---

You can use the adlocation option with the query adobjects or restore adobjects commands to indicate whether the Active Directory objects are to be queried or restored from the local Active Directory Deleted Objects container or from a system state



backup on the IBM Spectrum Protect™ server.

## Supported Clients

---

This option is valid for supported Windows Server clients. The IBM Spectrum Protect API does not support this option.

## Syntax

---

```
                .-local--.  
>>-ADLOCation--+-----+-----><  
                '-server-'
```

## Parameters

---

server

Specifies that the Active Directory objects are to be queried or restored from a system state backup on the IBM Spectrum Protect server. Valid for all supported Windows server clients.

local

Specifies that the Active Directory objects are to be queried or restored from the local Active Directory Deleted Objects container. This is the default.

## Example

---

Command line:

```
query adobjects "cn=Jim Smith" -adlocation=server
```

AIX

Linux

## Afmskipuncachedfiles

---

The `afmskipuncachedfiles` option specifies whether uncached and dirty files in General Parallel File System (GPFS™) Active File Management file sets are processed for backup, archive, and migration operations.

GPFS Active File Management and *uncached* and *dirty* file states are explained in GPFS product information.

Running HSM on GPFS file systems that use Active File Management file sets is explained in Guidance for integrating IBM Spectrum Scale AFM with IBM Spectrum Protect .

If you back up, archive, or migrate files from a file system that contains Active File Management file sets, set `afmskipuncachedfiles=yes`.

Restriction: If Active File Management is running in Local Update (LU) mode, the `afmskipuncachedfiles` option in the cache file set must be set to No.

## Supported Clients

---

This option is valid for backup-archive clients that run on AIX® and Linux systems.

## Options File

---

Place this option in the `dsm.sys` file before any server stanzas.

## Syntax

---

```
                .-NO--.  
>>-AFMSKIPUNCACHEDFILES--+-----+-----><  
                '-YES-'
```

## Parameters

---

NO

The Active File Management file state is ignored during backup, archive, and migration operations. Migration operations on uncached or dirty files fail and yield error message ANS9525E. Backup and archive operations on uncached files require Active File Management fetch operations. The fetch operations can cause significant network traffic between the Active File Management home and cache. This parameter is the default.

YES

Uncached or dirty files in Active File Management file sets are skipped during backup, archive, and migration processing.

## Archmc

---

Use the archmc option with the archive command to specify the available management class for your policy domain to which you want to bind your archived files and directories.

When you archive a file, you can override the assigned management class using the archmc option on the archive command or by using the web client. Overriding the management class using the web client is equivalent to using the archmc option on the archive command.

If you do not use the archmc option, the server binds archived directories to the default management class. If the default management class has no archive copy group, the server binds archived directories to the management class with the shortest retention period.

AIX Linux Solaris Mac OS X Windows

## Supported Clients

---

AIX Linux Solaris Mac OS X This option is valid for all UNIX and Linux clients. The IBM Spectrum Protect™ API does not support this option.

Windows This option is valid for all Windows clients. The IBM Spectrum Protect API does not support this option.

## Syntax

---

```
>>-ARCHMc = -managementclass-----<<
```

## Parameters

---

managementclass

Specifies an available management class in the active policy set of your policy domain. This management class overrides the default management class and any include statements for the files and directories you are archiving.

## Examples

---

Command line:

Mac OS X  
dsmc archive -archmc=ret2yrs /Users/van/Documents/budget.jan

AIX Linux Solaris Mac OS X  
dsmc archive -archmc=ret2yrs /home/plan/proj1/budget.jan

Windows  
dsmc archive -archmc=ret2yrs c:\plan\proj1\budget.jan\\*

AIX Linux Solaris

## Archsymlinkasfile

---

The archsymlinkasfile option specifies whether the backup-archive client follows a symbolic link and archives the file or directory to which it points, or archives the symbolic link only. Use this option with the archive command.

## Supported Clients

---

This option is valid for all UNIX clients except Mac OS X. The server can also define this option.

## Options File

---

Place this option in the client user options file (dsm.opt).

## Syntax

---

```
                .-Yes-.  
>>-ARCHSYMLinkasfile---+-----+----->>  
                '-No--'
```

## Parameters

---

Yes

Specifies that the client follows a symbolic link and archives the associated file or directory. This is the default.

No

Specifies that the client archives the symbolic link and not the associated file or directory.

## Examples

---

Options file:

```
archsymbllinkasfile no
```

Command line:

```
-archsymbll=no
```



## Asnodename

---

Use the `asnodename` option to allow agent nodes to back up or restore data on behalf of another node (the target node). This enables concurrent operations from multiple nodes to store data to the same target node and file space in parallel.

Your client node must be granted access to the target node by the IBM Spectrum Protect™ server administrative client `grant proxynode` command, and you must be a root user to use the `asnodename` option.

When the IBM Spectrum Protect administrator grants a node proxy authority, and you use the `asnodename` option to become that node, you can query and restore all files as if you had root authority.

An agent node is a client node that has been granted authority to perform client operations on behalf of a target node.

A target node is a client node that grants authority to one or more agent nodes to perform client operations on its behalf.

A proxy operation uses the settings for the target node (such as `maxnummp` and deduplication) and schedules that are defined on the server. The IBM Spectrum Protect server node settings and schedules for the agent node are ignored.

For example, you can use the following command to back up shared data for file space stored under the node name `MyCluster`:

```
/cluster1/mydata  
dsmc incremental /Users -asnodename=MyCluster
```

You can also use the `asnodename` option to restore data under another node name on the server. You can only restore the data that you own.

The `asnodename` option differs from the `nodename` option as follows:

- When using the `nodename` option, you must enter the password for the node name you specify.
- When using the `asnodename` option, you must enter the password for your client agent node to access the data stored for the client target node.

**Restrictions:** You cannot use the `asnodename` option with `-fromnode` and you cannot perform NAS backup using `asnodename`. Also, `asnodename` can be used for clustered systems, although no specific cluster software is supported.

## Supported Clients

This option is valid for all UNIX and Linux clients.

## Options File

Place this option in the `dsm.sys` file *within* a server stanza. You can set this option on the **General** tab of the Preferences editor.

## Syntax

```
>>-ASNODENAME- --targetnode-----<<
```

## Parameters

`targetnode`

Specifies the node name on the IBM Spectrum Protect server under which you want to back up or restore data.

## Examples

Options file:

```
asnodename mycluster
```

Command line:

```
-asnodename=mycluster
```

This option is not valid in interactive mode, but it can be defined in the options portion of a schedule definition.

- AIX** | **Linux** | **Solaris** | **Mac OS X** Session settings and schedules for a proxy operation  
A proxy operation occurs when an agent node uses the `asnodename target_node_name` option to complete operations on behalf of the specified target node.

**Windows**

## Asnodename

Use the `asnodename` option to allow an agent node to back up, archive, restore, retrieve, and query data on behalf of a target node.

An *agent node* is a client node that the IBM Spectrum Protect™ administrator grants the authority to perform client operations on behalf of a *target node*. The target node is the client node that the agent node performs the actions for. The administrator uses the `grant proxynode` command on the IBM Spectrum Protect server to grant this authority.

Agent nodes can be used to distribute the workload of backing up a computer's volumes, across multiple client systems. Each system that is involved in the backup uses its own agent node name, but the backup data is stored in a common file space that is owned by the target node.

For example, assume that you plan to back up four volumes that belong to a node that is named SCORPIO, but the backup operation takes too long to run. You can distribute part of the workload to three other machines: TAURUS, ARIES, and LEO. SCORPIO and the three other machines each back up one of SCORPIO's volumes. Each node that is involved in the backup connects to the server by using its own agent node name, and each node specifies a unique value for the `asnodename` option. Do not use a computer name or cluster name for the `asnodename` value. The following table illustrates an example configuration.

Table 1. Setting the value of the `asnodename` option to distribute backups.

Host name	NODENAME option value	ASNODENAME option value	Volume backed up	Server file space name
SCORPIO	SCORPIO	TARGET_SCORPIO	\\scorpio\r\$	\\target_scorpio\r\$
TAURUS	TAURUS	TARGET_SCORPIO	\\scorpio\s\$	\\target_scorpio\s\$
ARIES	ARIES	TARGET_SCORPIO	\\scorpio\t\$	\\target_scorpio\t\$
LEO	LEO	TARGET_SCORPIO	\\scorpio\u\$	\\target_scorpio\u\$

To create the relationships between the target node and the proxy nodes, the IBM Spectrum Protect server administrator needs to take the following actions:

1. Register nodes SCORPIO, TAURUS, ARIES, LEO, and TARGET\_SCORPIO.
2. Grant nodes SCORPIO, TAURUS, ARIES, and LEO proxy authority to node TARGET\_SCORPIO

When you back up or archive data without the `asnodename` option, the backed up data is stored in a file space on the server that matches the UNC name of the drive on which the original data exists.

When you use the `asnodename` option to back up data on behalf of a target node, the data is stored in a file space that is owned by the target node. However, instead of using the host name in the file space name, the target node name is used in the file space name. For example, if node TAURUS backs up data on SCORPIO's S drive and sets the `asnodename` option value to `-asnodename=target_scorprio`, the backup data is stored in a file space named `\\target_scorprio\s$`. The file space is owned by the TARGET\_SCORPIO node.

When you restore or retrieve data, the default behavior is to restore or retrieve the data to a location that matches the file space name.

Continuing with the preceding example, if node SCORPIO uses `-asnodename=target_scorprio` to restore data from `\\target_scorprio\s$`, the client attempts to restore the data to the S drive on a computer named TARGET\_SCORPIO. This operation does not produce the expected result because, in this sample configuration, there is no computer that is named TARGET\_SCORPIO.

In the following example, the restore command is entered on the SCORPIO node. The command restores all files and subdirectories from the `Users\andy\education` directory in the `\\target_scorprio\s$` file space to the S drive on the computer that is named SCORPIO:

```
dsmc restore \\target_scorprio\s$\users\andy\education\* s:\
-subdir=yes -asnodename=target_scorprio
```

The following considerations apply when you use a proxy node to back up or restore data on other nodes:

- A proxy operation uses the settings for the target node (such as `maxnummp` and `deduplication`) and schedules that are defined on the IBM Spectrum Protect server. The IBM Spectrum Protect server node settings and schedules for the agent node are ignored.
- You cannot use `asnodename` with the `backup nas` command.
- You cannot use `asnodename` with the `fromnode` option.
- If you use `asnodename` to backup and restore volumes that are in a cluster configuration, do not use `clusternode yes`.
- You cannot use `asnodename` to back up or restore system state.
- If an agent node restores data from a backup set, the system state object in the backup set is not restored.
- You can use `asnodename` with the `backup image` command, but you must specify the volume by UNC name. You cannot use the drive letter.
- If you use the same `asnodename` value to back up files from different machines, you need to keep track which files or volumes are backed up from each system so that you can restore them to the correct location.
- All agent nodes in a multiple node environment should be of the same platform type.
- Do not use target nodes as traditional nodes, especially if you encrypt your files before backing them up to the server.

## Supported Clients

---

This option is valid for all Windows clients.

## Options File

---

Place this option in the `dsm.opt` file. You can set this option on the General tab of the Preferences editor.

## Syntax

---

```
>>-ASNODENAME- --targetnode-----><
```

## Parameters

---

`targetnode`

Specifies the node name on the IBM Spectrum Protect server under which you want to back up or restore data.

## Examples

---

Options file:

```
asnodename target_scorpio
```

Command line:

This command backs up the entire F: drive to a server file space named \\target\_scorpio\f\$.

```
dsmc incremental f: -asnodename=target_scorpio
```

This option is not valid in interactive mode, but it can be defined in the options portion of a schedule definition.

- **Windows** Session settings and schedules for a proxy operation  
A proxy operation occurs when an agent node uses the `asnodename target_node_name` option to complete operations on behalf of the specified target node.

**Windows**

## Asrmode

---

Use the `asrmode` option with the `restore` and `restore systemstate` commands to specify whether to perform a restore operation in system ASR recovery mode.

This option is used in the context of restore commands generated in the `asr.sif` file by the backup `asr` command only.

## Supported Clients

---

This option is valid for supported Windows clients that are running in a Windows Preinstallation Environment; both BIOS and UEFI boot architectures are supported.

## Syntax

---

```
>>-ASRMODE = -+-----+----->>  
              +-No--+  
              '-Yes-'
```

## Parameters

---

No

Specifies that the client does not perform the restore operation in system ASR recovery mode.

Yes

Specifies that the client performs the restore operation in ASR recovery mode. This is the default for Windows clients during ASR recovery. These clients are running in Windows Preinstallation Environment (WinPE) during ASR recovery.

## Examples

---

Command line:

```
restore systemstate -asrmode=yes  
restore systemstate -asrmode=yes -inactive -pick
```

This option is valid for an interactive session, but cannot be changed by entering the option while running an interactive session.

## Auditlogging

---

Use the `auditlogging` option to generate an audit log that contains an entry for each file that is processed during an incremental, selective, archive, restore, or retrieve operation.

The audit log can be configured to capture either a basic level of information or a more inclusive (full) level of information.

The basic level of the audit logging feature captures the information that is in the schedule log and it records information that a file has been backed up, archived, updated, restored, retrieved, expired, deleted, skipped or failed during an incremental backup, selective backup, archive, restore or retrieve operation. In addition, the basic level of audit logging captures the input command for commands run through the backup-archive command line or scheduler clients.

The full level of audit logging records an action for each file that is processed by the backup-archive client. In addition to all of the events recorded by the basic level of audit logging, the full level of audit logging records information for a file that has been excluded or not sent during a progressive incremental backup operation because the file had not changed.

The following is an example of the messages that are issued when the audit log is configured to capture the basic level of information:

AIX	Linux	Solaris	Mac OS X
-----	-------	---------	----------

```
04/21/07 15:25:05 ANS1650I Command:
  sel /home/spike/test/*
04/21/07 15:25:05 ANS1651I Backed Up:
  /home/spike/test/file.txt
04/21/07 15:25:05 ANS1652I Archived:
  /home/spike/test/file.txt
04/21/07 15:25:05 ANS1653I Updated:
  /home/spike/test/file.txt
04/21/07 15:25:05 ANS1654E Failed:
  /home/spike/test/file.txt
04/21/07 15:25:05 ANS1655I Restored:
  /home/spike/test/file.txt
04/21/07 15:25:05 ANS1656I Retrieved:
  /home/spike/test/file.txt
04/21/07 15:25:05 ANS1657I Expired:
  /home/spike/test/file.txt
04/21/07 15:25:05 ANS1658I Deleted:
  /home/spike/test/file.txt
04/21/07 15:25:05 ANS1659I Skipped:
  /home/spike/test/file.txt
```

Windows
---------

```
04/21/07 15:25:05 ANS1650I Command:
  sel c:\test\file.txt
04/21/07 15:25:05 ANS1651I Backed Up:
  \\spike\c$\test\file.txt
04/21/07 15:25:05 ANS1652I Archived:
  \\spike\c$\test\file.txt
04/21/07 15:25:05 ANS1653I Updated:
  \\spike\c$\test\file.txt
04/21/07 15:25:05 ANS1654E Failed:
  \\spike\c$\test\file.txt
04/21/07 15:25:05 ANS1655I Restored:
  \\spike\c$\test\file.txt
04/21/07 15:25:05 ANS1656I Retrieved:
  \\spike\c$\test\file.txt
04/21/07 15:25:05 ANS1657I Expired:
  \\spike\c$\test\file.txt
04/21/07 15:25:05 ANS1658I Deleted:
  \\spike\c$\test\file.txt
04/21/07 15:25:05 ANS1659I Skipped:
  \\spike\c$\test\file.txt
```

AIX	Linux	Solaris	Mac OS X
-----	-------	---------	----------

The following messages can be issued when the audit log is configured to capture the full level of information (in addition to all messages issued for the basic level of audit logging):

AIX	Linux	Solaris	Mac OS X
-----	-------	---------	----------

```
04/21/07 15:25:05 ANS1660I Excluded:
  /home/spike/test/file.txt
04/21/07 15:25:05 ANS1661I Unchanged:
  /home/spike/test/file.txt
```

Windows
---------

The following is an example of the messages that are issued when the audit log is configured to capture the full level of information (in addition to all messages issued for the basic level of audit logging):

Windows
---------

```
04/21/07 15:25:05 ANS1660I Excluded:
  \\spike\c$\test\file.txt
04/21/07 15:25:05 ANS1661I Unchanged:
  \\spike\c$\test\file.txt
```

The audit log is not a substitute or a replacement for the standard error log (`dsmerror.log`) or for the schedule log (`dsmsched.log`). If an error occurs that prevents a file from being processed, a message indicating that an error has occurred is written to the audit log, but the message will not indicate the nature of the error. For problem diagnostics the standard error log must still be used.

The audit log entries only contain a time stamp and object name. There is no information to distinguish between files and directories or any information about the size of an object.

**Mac OS X** The Mac OS X backup-archive client creates the audit log as a Unicode (UTF-16) file.

**Windows** When using the Windows backup-archive client, all object names are written in the UNC format. The Windows backup-archive client creates the audit log as a Unicode file.

By default, the name of the audit log is `dsmaudit.log` and it is contained in the same directory as the error log, `dsmerror.log`. The name and location of the audit log can be configured using the `auditlogname` option. There are no parameters to control the size of the audit log or to prune the audit log. The `auditlogname` option cannot be set as an option in an IBM Spectrum Protect™ server client options set.

**Mac OS X** The auditlogging command is supported with backup commands that interact with file-level objects such as backup groups.

**AIX** | **Linux** | **Solaris** The auditlogging command is not supported with backup commands which interact with image-level objects such as backup image or restore image. The auditlogging command is supported with backup commands that interact with file-level objects such as backup groups.

**Windows** The auditlogging command is not supported with backup commands which interact with image-level objects such as backup image or restore image. The auditlogging command is supported with backup commands that interact with file-level objects such as backup groups, and backup systemstate.

If you have enabled audit logging for an operation and there is a failure trying to write to the audit log (for example, the disk on which the audit log resides is out of space), the audit logging is disabled for the rest of the operation and the return code for the operation is set to 12, regardless of the outcome of the operation.

## Supported Clients

---

This option is valid for all clients.

## Options File

---

**Windows** Place this option in the `dsm.opt` file.

**AIX** | **Linux** | **Solaris** | **Mac OS X** Place this option in the client system-options file (`dsm.sys`) within a server stanza.

## Syntax

---

```
                .-off--.
>>-AUDITLOGGing--+-----+----->>
                +-basic+
                '-full--'
```

## Parameters

---

- `off`  
Specifies that the audit logging facility is not engaged. This is the default.
- `basic`  
Specifies that the audit log captures a basic level of information.
- `full`  
Specifies that the audit log captures a more extensive level of information.



## Examples

---

Run an incremental backup with audit logging enabled.

Command line:

```
dsmc i -auditlogging=basic
```

Back up a list of files using the maximum level of auditing, which enables a separate application, such as a Perl script, to verify the results.

### Windows

```
dsmc i -filelist=file.lst -auditlogging=full  
-auditlogname="c:\program files\tivoli\tsm\baclient\  
temp_audit001.log"
```

## Auditlogname

---

The `auditlogname` option specifies the path and file name where you want to store audit log information. This option applies when audit logging is enabled.

## Supported Clients

---

This option is valid for all clients.

## Options File

---

**Windows** Place this option in the `dsm.opt` file.

**AIX** | **Linux** | **Solaris** | **Mac OS X** Place this option in the client system-options file (`dsm.sys`) within a server stanza.

## Syntax

---

```
>>-AUDITLOGName--filespec-----<<
```

## Parameters

---

`filespec`

Specifies the path and file name where you want the backup-archive client to store audit log information.

If you specify a file name only, the file is stored in your current directory. The default is the installation directory with a file name of `dsmaudit.log`. The `dsmaudit.log` file cannot be a symbolic link.

**Windows** In Uniform Naming Convention (UNC) format, the path must contain a drive letter. In the following example, the path contains the drive letter `D$`: `\\computer7\D$\logs\tsmaudit.log`.

## Examples

---

Run an incremental backup with audit logging enabled.

**AIX** | **Linux** | **Solaris** | **Mac OS X** Sample output

**AIX** | **Linux** | **Solaris** | **Mac OS X** The following is a sample execution and output file:

```
> dsmc inc /SMSVT/mfs1 -auditlogging=full  
-auditlogname=/home/cliv3/audit.log  
IBM Spectrum Protect  
Command Line Backup-Archive Client Interface  
Client Version 8, Release 1, Level 0.0  
Client date/time: 11/16/2016 12:05:35  
(c) Copyright by IBM Corporation and other(s) 1990, 2016.  
All Rights Reserved.  
  
Node Name: NAXOS_CLUSTER
```

Session established with server  
ODINHSMSERV: AIX-RS/6000  
Server Version 8, Release 1, Level 0.0  
Server date/time: 11/16/2016 12:05:35  
Last access: 11/15/2016 12:01:57

Incremental backup of volume '/SMSVT/mfs1'  
Directory--> 4,096 /SMSVT  
/mfs1/ [Sent]  
Normal File--> 32,768 /SMSVT  
/mfs1/test0 [Sent]  
Normal File--> 32,768 /SMSVT  
/mfs1/test1 [Sent]  
Normal File--> 32,768 /SMSVT  
/mfs1/test2 [Sent]  
Normal File--> 32,768 /SMSVT  
/mfs1/test3 [Sent]  
Normal File--> 32,768 /SMSVT  
/mfs1/test4 [Sent]  
Normal File--> 32,768 /SMSVT  
/mfs1/test5 [Sent]  
Normal File--> 32,768 /SMSVT  
/mfs1/test6 [Sent]  
Normal File--> 32,768 /SMSVT  
/mfs1/test7 [Sent]  
Normal File--> 32,768 /SMSVT  
/mfs1/test8 [Sent]  
Normal File--> 32,768 /SMSVT  
/mfs1/test9 [Sent]  
Successful incremental backup of '/SMSVT/mfs1'

Total number of objects inspected: 11  
Total number of objects backed up: 11  
Total number of objects updated: 0  
Total number of objects rebound: 0  
Total number of objects deleted: 0  
Total number of objects expired: 0  
Total number of objects failed: 0  
Total number of bytes transferred: 320.31 KB  
Data transfer time: 0.01 sec  
Network data transfer rate: 17,141.84 KB/sec  
Aggregate data transfer rate: 297.43 KB/sec  
Objects compressed by: 0%  
Elapsed processing time: 00:00:01

**The following are the audit log contents:**

07/03/07 12:05:14 ANS1650I Command:  
inc /SMSVT/mfs1  
07/03/07 12:05:15 ANS1651I Backed Up:  
/SMSVT/mfs1/  
07/03/07 12:05:15 ANS1651I Backed Up:  
/SMSVT/mfs1/test0  
07/03/07 12:05:15 ANS1651I Backed Up:  
/SMSVT/mfs1/test1  
07/03/07 12:05:15 ANS1651I Backed Up:  
/SMSVT/mfs1/test2  
07/03/07 12:05:15 ANS1651I Backed Up:  
/SMSVT/mfs1/test3  
07/03/07 12:05:15 ANS1651I Backed Up:  
/SMSVT/mfs1/test4  
07/03/07 12:05:15 ANS1651I Backed Up:  
/SMSVT/mfs1/test5  
07/03/07 12:05:15 ANS1651I Backed Up:  
/SMSVT/mfs1/test6  
07/03/07 12:05:15 ANS1651I Backed Up:  
/SMSVT/mfs1/test7  
07/03/07 12:05:15 ANS1651I Backed Up:  
/SMSVT/mfs1/test8  
07/03/07 12:05:15 ANS1651I Backed Up:  
/SMSVT/mfs1/test9

**Windows** Options file:

**Windows** Store the audit log in a non-default path.

```
auditlogname c:\mypath\myaudit.log
```

**Windows** Command line:

**Windows** Back up a list of files using the maximum level of auditing, which would enable a separate application, such as a Perl script, to verify the results:

```
dsmsc i -filelist=file.lst -auditlogging=full  
-auditlogname="c:\program files\tivoli\tsm\baclient\  
temp_audit001.log"
```

**Windows** Sample output

**Windows** The following is a sample execution and output file:

```
C:\Program Files\Tivoli\TSM\baclient>dsmsc i  
c:\test\* -sub=yes -auditlogging=full  
IBM Spectrum Protect  
Command Line Backup-Archive Client Interface  
Client Version 8, Release 1, Level 0.0  
Client date/time: 11/16/2016 12:05:35  
(c) Copyright by IBM Corporation and other(s) 1990, 2016.  
All Rights Reserved.
```

```
Node Name: PATMOS  
Session established with server PATMOS_5331: Windows  
Server Version 8, Release 1, Level 0.0  
Server date/time: 11/16/2016 12:05:35  
Last access: 11/15/2016 15:52:06
```

```
Incremental backup of volume 'c:\test\*'  
Normal File--> 1,048,576 \\patmos\c$\test  
 \dir1\file1 [Sent]  
Normal File--> 1,048,576 \\patmos\c$\test  
 \dir1\file2 [Sent]  
Normal File--> 1,024 \\patmos\c$\test  
 \dir1\file3 [Sent]  
Normal File--> 1,048,576 \\patmos\c$\test  
 \dir2\file1 [Sent]  
Normal File--> 1,048,576 \\patmos\c$\test  
 \dir2\file2 [Sent]  
Normal File--> 1,024 \\patmos\c$\test  
 \dir2\file3 [Sent]  
Successful incremental backup of '\\patmos\c$\test\*'
```

```
Total number of objects inspected: 12  
Total number of objects backed up: 6  
Total number of objects updated: 0  
Total number of objects rebound: 0  
Total number of objects deleted: 0  
Total number of objects expired: 0  
Total number of objects failed: 0  
Total number of bytes transferred: 400.85 KB  
Data transfer time: 0.00 sec  
Network data transfer rate: 0.00 KB/sec  
Aggregate data transfer rate: 382.85 KB/sec  
Objects compressed by: 91%  
Elapsed processing time: 00:00:01  
ANS1900I Return code is 0.  
ANS1901I Highest return code was 0.
```

The following are the audit log contents:

```
04/21/2007 15:52:25 ANS1650I Command:  
 i c:\test\*  
04/21/2007 15:52:26 ANS1661I Unchanged:  
 \\patmos\c$\test  
04/21/2007 15:52:26 ANS1661I Unchanged:  
 \\patmos\c$\test\dir1  
04/21/2007 15:52:26 ANS1661I Unchanged:  
 \\patmos\c$\test\dir2  
04/21/2007 15:52:26 ANS1661I Unchanged:  
 \\patmos\c$\test\file1  
04/21/2007 15:52:26 ANS1661I Unchanged:  
 \\patmos\c$\test\file2  
04/21/2007 15:52:26 ANS1661I Unchanged:
```

```

    \\patmos\c$\test\file3
04/21/2007 15:52:26 ANSI651I Backed Up:
    \\patmos\c$\test\dir1\file1
04/21/2007 15:52:26 ANSI651I Backed Up:
    \\patmos\c$\test\dir1\file2
04/21/2007 15:52:26 ANSI651I Backed Up:
    \\patmos\c$\test\dir1\file3
04/21/2007 15:52:26 ANSI651I Backed Up:
    \\patmos\c$\test\dir2\file1
04/21/2007 15:52:26 ANSI651I Backed Up:
    \\patmos\c$\test\dir2\file2
04/21/2007 15:52:26 ANSI651I Backed Up:
    \\patmos\c$\test\dir2\file3

```

## Autodeploy

---

Use the autodeploy option to enable or disable an automatic deployment of the client if a restart is required.

## Supported Clients

---

**AIX** | **Linux** | **Mac OS X** | **Solaris** This option is valid for AIX®, Linux, Mac, and Solaris clients.

**Windows** This option is valid for Windows clients

## Options File

---

You can set this option by including it in your client options file. You can also set it using the Java GUI by clicking Edit > Client Preferences and selecting the appropriate option on the General tab.

**Windows**

## Syntax

---

```

    .-Yes-----
>>-AUTODEPLOY--+-----><
    +-No-----+
    '-NOReboot-'

```

**Windows**

## Parameters

---

Yes

Specifies that the client is automatically deployed from the server. Yes is the default.

Important:

- When you set autodeploy to yes, if a restart of the client workstation is required to complete the deployment, you cannot disable the restart. The client workstation will be restarted. If it is important that the workstation is not automatically restarted, set autodeploy to noreboot. The deployment will be canceled if a restart is required. The current client is not affected.
- If a restart is required, the deployment manager initiates a restart for the client computer and exits. However, it is possible that you cancel or interrupt the restart. Since the deployment manager is already terminated, a message is not sent to the server to indicate the failure of the restart. The deployment result is still successful. You must restart the computer so that the new client deployment completes.

No

Specifies that the client is not automatically deployed from the server.

NOReboot

Specifies that the deployment manager never automatically restarts the client computer, even if a restart is required. If a restart is required, allowing automatic deployment to many machines with the NOReboot parameter can result in only a partial update of, potentially, many clients.

To alleviate this problem, the deployment manager tries to detect if a restart is required. If a restart is required, the deployment manager cancels the deployment before the new client installation. This guarantees that the client computer

still has a working backup-archive client, and the new client deployment can be rescheduled.

There are rare cases where the deployment manager cannot detect the restart; for example, if client processes are started from a script. In these cases, the new client installation will continue, but a manual restart of the client computer is required.

AIX Linux Mac OS X Solaris

## Syntax

```
>>--AUTODEPLOY--+-Yes-+-----+-----><
                  '-No--'
```

AIX Linux Mac OS X Solaris

## Parameters

Yes

Specifies that the client is automatically deployed from the server. Yes is the default.

No

Specifies that the client is not automatically deployed from the server.

## Examples

AIX Linux Mac OS X Solaris Windows

Options file:

```
autodeploy no
```

Command line:

Does not apply.

Windows

Options file:

```
autodeploy noreboot
```

Command line:

Does not apply.

AIX Linux Mac OS X Solaris Windows

Important: Use `schedmode` prompted with the `autodeploy` option, to enable the scheduler to process the client deployment schedule immediately.

### Related concepts:

Automatic backup-archive client deployment

## Autofsrename

The `autofsrename` option renames an existing file space that is not Unicode-enabled on the IBM Spectrum Protect™ server so that a Unicode-enabled file space with the original name can be created for the current operation.

**Mac OS X** When you specify `autofsrename yes` in your client options file, and the server value of `autofsrename` is set to `client`, the IBM Spectrum Protect server generates a unique name by appending `_OLD` to the file space name you specify in the current operation. For example, the server renames the file space `Jaguar` to `Jaguar_OLD`. If the new file space name is too long, the suffix replaces the last characters of the file space name. For example, the `mylongfilesystemname` file space name is renamed to:

```
mylongfilesystem_OLD
```

**Mac OS X** If the new file space name already exists on the server, the server renames the new file space `Jaguar_OLDx`, where `x` is a unique number.

**Mac OS X** The server creates new Unicode-enabled file spaces that contain only the data specified in the current operation. For example, assume that `Jaguar` is the name of your startup disk and you archive all of the `.log` files in the `/Users/user5/Documents` directory. Before the archive takes place, the server renames the file space to `Jaguar_OLD`. The archive places the data specified in the current operation into the Unicode-enabled file space named `Jaguar`. The new Unicode-enabled file space now contains only the `/Users/user5/logs` directory and the `*.log` files specified in the operation. The server stores all subsequent full and partial incremental, selective backup, and archive data in the new Unicode-enabled file spaces.

**Mac OS X** For example, assume that `Jaguar` is the name of your startup disk and you archive all of the `.log` files in the `/Users/user5/Documents` directory. Before the archive takes place, the server renames the file space to `Jaguar_OLD`. The archive places the data specified in the current operation into the Unicode-enabled file space named `Jaguar`. The new Unicode-enabled file space now contains only the `/Users/user5/logs` directory and the `*.log` files specified in the operation. All subsequent full and partial incremental, selective backup, and archive data are stored in the new Unicode-enabled file spaces.

**Windows** When you specify `autofsrename yes` in your client options file, and the server value of `autofsrename` is set to `client`, the IBM Spectrum Protect server generates a unique name by appending `_OLD` to the file space name you specify in the current operation. For example, the server renames the file space `\\your-node-name\h$` to `\\your-node-name\h$_OLD`. If the new file space name is too long, the suffix replaces the last characters of the file space name, as follows:

```
\\your-node-name_OLD
```

**Windows** If the new file space name already exists on the server, the server renames the new file space `\\your-node-name_OLDx`, where `x` is a unique number.

**Windows** The server creates new Unicode-enabled file spaces that contain only the data specified in the current operation. For example, to archive files from your `H:` disk named `\\your-node\h$`, issue the following archive command:

```
arc h:\logs\*.log
```

**Windows** Before the archive takes place, the server renames the file space to `\\your-node\h$_OLD`. The archive places the data specified in the current operation into the Unicode-enabled file space named `\\your-node\h$`. The new Unicode-enabled file space now contains only the `\logs` directory and the `*.log` files specified in the operation. All subsequent full and partial incremental, selective backup, and archive data are stored in the new Unicode-enabled file spaces.

Renamed file spaces remain on the server as stabilized file spaces. *These file spaces contain all the original data, which you can restore as long as they remain on the server.*

Note: When an existing file space is renamed during Unicode conversion, any access rules defined for the file space remain applicable to the original file space. New access rules must be defined to apply to the new Unicode file space.

After installation, perform a full incremental backup and rename all existing file spaces that are not Unicode-enabled and back up the files and directories within them under the new Unicode-enabled file spaces. This operation requires increased processing time and storage on the server.

File spaces that are not Unicode-enabled can be viewed in the character set of the locale from which the files were backed up. A workstation running in a different locale might be unable to view or restore from these file spaces. Unicode-enabled file spaces that are backed up in one locale are visible in all other locales, provided that the workstation has the proper fonts installed.

**Windows** To restore or retrieve from a file space that is not Unicode-enabled, specify the source on the server and the destination on the client. See

**Mac OS X** The server can define the `autofsrename` option and override the `autofsrename` setting on the client.

## Supported Clients

---

**Mac OS X** This option is valid for Mac OS X only. The server can define the `autofsrename` option and override the `autofsrename` setting on the client. The IBM Spectrum Protect API does not support this option.

**Windows** This option is valid for all Windows clients. The server can define the `autofsrename` option and override the `autofsrename` setting on the client. The IBM Spectrum Protect API does not support this option.

## Options File

---

**Mac OS X** Place this option in the client system-options file (`dsm.sys`) within a server stanza. You can set this option on the General tab, Rename non-Unicode files during backup/archive drop-down list box of the Preferences editor.

**Windows** Place this option in the client options file (dsm.opt) file. You can set this option on the General tab, Rename non-Unicode filesystems during backup/archive drop-down list box of the Preferences editor.

## Syntax

---

```
.-Prompt-.
>>-AUTOfsrename-----+-----><
+-Yes-----+
'-No-----'
```

## Parameters

---

### Yes

Specifies that the IBM Spectrum Protectserver automatically renames all file spaces that are not Unicode-enabled in the current backup or archive operation.

### No

Specifies that the server does not rename file spaces that are not Unicode-enabled in the current backup or archive operation.

### Prompt

Specifies that you are prompted whether to rename the file spaces that are not Unicode-enabled in the current operation. This is the default.

### Considerations:

- This option applies only when the server sets the autofsrename option to `client`.
- When the client scheduler is running, the default behavior is to not prompt you. The next interactive session prompts you to rename the file space.
- The client prompts you *only* one time per file space. If you specify `no` at the prompt, the client cannot rename the file spaces later. However, the IBM Spectrum Protect administrator can rename the file spaces on the server.
- **Mac OS X | Windows** When backing up files to a file space that is not Unicode-enabled, the Unicode-enabled client skips the files and directories with names containing characters from a code page that is different from the current locale.
- **Mac OS X | Windows** If files and directories with names containing characters from a code page other than the current locale were previously backed up with a client that was not Unicode-enabled, they might be expired. The Unicode-enabled client expires these files if you do not migrate the file space to a Unicode-enabled file space. You can back up and archive these files to a Unicode-enabled file space.

## Examples

---

### Options file:

```
autofsrename yes
```

**AIX | Linux | Solaris**

## Automount

---

The automount option adds an automounted file system into the domain by mounting it. Use this option with the domain option.

Use this option to specify all automounted file systems that the backup-archive client tries to mount at the following points in time:

- When the client starts
- When the backup is started
- When the the client has reached an automounted file system during backup

Mount the file system before the client does a backup of that file system. If the file system is always mounted before the backup is done, it is unnecessary to explicitly specify an automounted file system in the automount option. However, add this file system in the automount option to ensure that the file system has been mounted at all the points in time mentioned previously. The automounted file systems are remounted if they have gone offline in the meantime during a backup.

## Supported Clients

---

This option is valid for all UNIX platforms except Mac OS X. The IBM Spectrum Protect™ API does not support this option.

## Options File

---

Place this option in the client user options file (dsm.opt).

## Syntax

---

```
      .- -----  
      |  
      v  
>>-AUTOMount----- --file spacename+-----><
```

## Parameters

---

file spacename

Specifies one or more fully qualified automounted file systems that are mounted and added into the domain.

## Examples

---

Options file:

```
automount /home/Fred /home/Sam
```

Command line:

Does not apply.

Linux | Windows

## Backmc

---

The backmc option specifies the management class to apply to the backup fastback command for retention purposes.

Use the backmc option with the backup fastback command.

If you back up an object more than once and specify a different management class for each backup, all backup versions of the object are rebound to the last management class specified.

## Supported Clients

---

Linux This option is valid for Linux x86\_64 clients.

Windows This option is valid for all Windows clients.

## Options File

---

None. You can specify this option only on the command line or on the scheduler.

## Syntax

---

```
>>-BACKMc=--management_class_name-----><
```

## Parameters

---

management\_class\_name

Specifies the management class name.

## Examples

---

Command line:

```
dsmc backup fastback -fbpolicyname=policy1 -fbserver=server1 -backmc=ret2yrs
```

## Backupsetname

---



The backupsetname option specifies the name of a backup set from the IBM Spectrum Protect™ server.

You can use backupsetname option with the following commands:

- query backup
- query filesystem
- **Windows** query image
- **AIX** **Linux** **Solaris** query image
- **Windows** query systemstate
- **Windows** restore image
- **AIX** **Linux** **Solaris** restore image

Note: The following commands take backupsetname as a positional parameter. The backupsetname positional parameter behaves differently from the backupsetname option. See the command explanations for a discussion of how the backupsetname positional parameter affects each of these commands:

- query backupset
- restore
- restore backupset

## Supported Clients

---

**AIX** **Linux** **Solaris** This option is valid for all UNIX and Linux clients. The IBM Spectrum Protect API does not support this option.

**Windows** This option is valid for all clients. The IBM Spectrum Protect API does not support this option.

## Options File

---

None. You can specify this option only on the command line.

## Syntax

---

```
>>-BACKUPSETName--backupsetname-----><
```

## Parameters

---

backupsetname

Specifies the name of a backup set from the IBM Spectrum Protect server. You cannot use wildcards.

## Examples

---

Command line:

```
Mac OS X  
dsmc query backup /Volumes/bkSets/file.1  
-backupsetname=YEAR_END_ACCOUNTING.12345678  
AIX Linux Solaris Mac OS X  
dsmc query backup /usr/projects -subdir=yes  
-backupsetname=YEAR_END_ACCOUNTING.12345678  
AIX Linux Solaris  
dsmc restore image /home/proj  
-backupsetname=ACCOUNTING_2007.12345678  
AIX Linux Solaris Windows  
dsmc query image -backupsetname=WEEKLY_BSET.21435678  
Windows  
dsmc query backup c:\* -subdir=yes  
-backupsetname=weekly_accounting_data.32145678
```

Windows

```
dsmc restore image e:  
-backupsetname=weekly_backup_data.12345678
```

Linux Windows

## Basesnapshotname

---

The basesnapshotname option specifies the snapshot to use as the base snapshot, when you perform a snapshot differential (snapdiff) backup of a NetApp filer volume. If you specify this option, you must also use the snapdiff option or an error occurs. If basesnapshotname is not specified, the useexistingbase option selects the most recent snapshot on the filer volume as the base snapshot.

If the specified snapshot cannot be found, an error is reported and the backup operation fails.

## Supported Clients

---

Linux This option can be used with supported x86\_64 Linux clients.

Windows This option can be used with supported Windows clients.

## Options File

---

This option can be specified in the client options file or on the command line.

## Syntax

---

```
>>-BASESNAPSHOTName-- --snapshot_name-----<<
```

## Parameters

---

### *snapshot\_name*

Specifies the name of an existing snapshot to use as the base snapshot. The name specified can be a snapshot name, such as vol1\_snap, or it can be the name of a scheduled NetApp backup that has a name like nightly.x, where x is the sequence number (where nightly.0 is the oldest snapshot).

You can also use a pattern with wildcard characters to select a snapshot. The wildcard characters can be either of the following:

- \*  
An asterisk (\*) matches any character.
- ?  
A question mark (?) matches a single character.

The wildcards are useful if your snapshots follow a pattern, such as including the date or data and time as part of the snapshot name. For example, a snapshot created on November 12 2012 at 11:10:00 AM could be saved as UserDataVol\_121103111000\_snapshot. The most recent snapshot that matches the pattern is selected as the existing base. For example, if there are two saved snapshots (UserDataVol\_121103111000\_snapshot and UserDataVol\_121103231000\_snapshot, the UserDataVol\_121103231100\_snapshot is selected because it is 12 hours newer than the other snapshot.

```
-basesnapshotname="UserDataVol_*_snapshot"
```

Question marks work well for scheduled backups that follow a consistent name pattern. This syntax selects the latest "nightly" backup as the snapshot to use as the existing base.

```
-basenameshotname="nightly.?"
```

## Examples

---

Options file:

```
basesnapshotname nightly.?
```

```
basesnapshotname volum_base_snap
```

Command line:

```
dsmc incr \\DRFiler\UserDataVol_Mirror_Share -snapdiff  
-useexistingbase -basesnapshotname="nightly.?"
```

**Related reference:**

Useexistingbase

## Cadlistenonport

---

The cadlistenonport option specifies whether to open a listening port for the client acceptor.

When a listening port is open, it can accept any inbound connections. However, the port is not used when the client acceptor manages only the scheduler and the scheduler runs in polling mode. You can use this option to prevent the acceptor from opening the unused port.

The default setting for this option is yes. Use cadlistenonport no only when managementservices schedule and schedmode polling are used.

## Supported Clients

---

This option is valid for all clients. The IBM Spectrum Protect™ API does not support this option.

## Options File

---

**AIX** **Linux** **Mac OS X** **Solaris** Place this option in the client system-options file (dsm.sys) within a server stanza.

**Windows** Place this option in the client options file (dsm.opt).

## Syntax

---

```
>>-CADLISTENONPort-+-Yes-  
                    |-----|-----<<  
                    '-No--'
```

## Parameters

---

Yes

Specifies that the client acceptor opens a listening port. This parameter is the default.

No

Specifies that the client acceptor does not open a listening port. Use this setting when you use the client acceptor only to manage the scheduler in polling mode.

This setting effectively disables other client features that depend on the client acceptor, such as web client backup and restore operations, IBM Spectrum Protect for Virtual Environments: Data Protection for VMware vSphere GUI operations, and IBM Spectrum Protect Snapshot backup and restore operations.

## Example

---

Options file:

```
cadlistenonport no
```

Command line:

Does not apply.

**Related reference:**

Managementservices

Schedmode

**Windows**

## Casesensitiveaware

---

The casesensitiveaware option specifies whether the Windows backup-archive client attempts to filter out file and directory objects that have name conflicts that are caused by different capitalization of the object names.

NTFS and ReFS volumes are case-sensitive and allow case-sensitive file names to be stored. Although the Windows operating system is not case-sensitive, applications such as Windows Services for UNIX (SFU) uses POSIX conventions and allow case-sensitive file names. SFU is typically included with Windows operating systems such as Windows Powered OS and Windows Storage Server. These operating systems are typically deployed on hardware (for example, NAS hardware) which is acting as a dedicated file server in a heterogeneous environment.

If there are UNIX clients that store files on NTFS or ReFS volumes in these Windows file server environments, use the casesensitiveaware option. If this option is not used in these environments, unpredictable results occur during backup and archive operations if case-sensitive file name conflicts are encountered. For homogeneous Windows file server environments, the casesensitiveaware option is not necessary.

For example, if there is a set of objects that are called 'MyWork.xls', 'MYWORK.xls', and 'mywork.xls', because the Windows operating system is not case-sensitive, applications cannot distinguish between two objects named 'mywork.xls' and 'MyWork.xls'

For this reason, the Windows backup-archive client cannot guarantee the restore integrity of such objects. When a name casing conflict arises, the backup-archive client can guarantee only the restore integrity of the first file in an alphabetical sort. On an ASCII-based operating system such as Windows, this means that capital letters come first, alphabetically, before their lowercase counterparts, so 'MySwork.xls' would alphabetically precede 'mywork.xls'.

In this example, if the casesensitiveaware option is used, only 'MyWork.xls' is processed. An error message is issued for 'mywork.xls' and it is skipped. If 'mywork.xls' is a directory, then the directory subtree 'mywork.xls' would be skipped. In all cases, messages are written to both the local error log and to the IBM Spectrum Protect™ server console to indicate the exact file names of the objects that are skipped.

## Supported Clients

---

This option is valid for all Windows clients. The server can also define this option.

## Options File

---

Place this option in the client options file (dsm.opt).

## Syntax

---

```
>>-CASESENSITIVEAware-+-No-- .  
                        +-----+-----<<-><  
                        '-Yes-'
```

## Parameters

---

- yes  
Specifies that the client will attempt to identify object names which differ in casing only and filter out objects which have casing conflicts and cannot be guaranteed to be restored properly.
- no  
Specifies that the client will not attempt to identify object names which differ in casing only. This is the default.

## Changingretries

---

The changingretries option specifies how many additional times you want the client to attempt to back up or archive a file that is in use. Use this option with the archive, incremental, and selective commands.

This option is applied only when copy serialization, an attribute in a management class copy group, is shared static or shared dynamic.

With shared static serialization, if a file is open during an operation, the operation repeats the number of times that you specify. If the file is open during each attempt, the operation does not complete.

**AIX** **Linux** **Solaris** **Mac OS X** With shared dynamic serialization, if a file is open during an operation, the operation repeats the number of times that you specify. The backup or archive occurs during the last attempt whether the file is open or not.

**Windows** With shared dynamic serialization, if a file is open during an operation, the operation repeats the number of times that you specify. The backup or archive occurs during the last attempt whether the file is open or not. Open file support can be used to back up files that are locked or in use.

**AIX** **Linux** **Solaris** **Mac OS X** **Windows**

## Supported Clients

---

**AIX** **Linux** **Solaris** **Mac OS X** This option is valid for all UNIX and Linux clients. The server can also define this option. The IBM Spectrum Protect™ API does not support this option.

**Windows** This option is valid for all Windows clients. The server can also define this option. The IBM Spectrum Protect API does not support this option.

## Options File

---

**AIX** **Linux** **Solaris** **Mac OS X** Place this option in the client system-options file (dsm.sys) within a server stanza. You can set this option on the Backup tab, Number of retries if file is in use field of the Preferences editor.

**Windows** Place this option in the client options file (dsm.opt). You can set this option on the Backup tab, Number of retries if file is in use field of the Preferences editor.

## Syntax

---

```
>>-CHAngingretries- numberretries-----><
```

## Parameters

---

**numberretries**

Specifies the number of times a backup or archive operation is attempted if the file is in use. The range of values is zero through 4; the default is 4.

## Examples

---

Options file:

```
changingretries 3
```

Command line:

```
-cha=3
```

**AIX** **Linux** **Solaris** **Windows**

## Class

---

The class option specifies whether to display a list of NAS or client objects when using the delete filespace, query backup, and query filespace commands.

For example, to display a list of the file spaces belonging to a NAS node, enter the following command:

```
query filespace -class=nas
```

## Supported Clients

---

**AIX** **Solaris** This option is valid only for AIX®, Linux, and Oracle Solaris clients. The IBM Spectrum Protect™ API does not support this option.

**Windows** This option is valid for all Windows clients. The IBM Spectrum Protect API does not support this option.

## Options File

---

None. You can specify this option only on the command line.

## Syntax

---

```
>>-CLASS = .-client-.
             +-----+----->>
             '-nas----'
```

## Parameters

---

client

Specifies that you want to display a list of file spaces for a client node. This is the default.

nas

Specifies that you want to display a list of file spaces for a NAS node.

## Examples

---

None. You can specify this option only on the command line.

Command line:

```
q backup -nasnodename=nodename -class=nas
```

Windows

## Clientview

---

The clientview option is available to users who have upgraded from the IBM® Tivoli® Storage Manager Express® backup client to the enterprise backup-archive client.

You must be connected to the Tivoli Storage Manager Version 5.4 or higher server to use this option. The clientview option allows you to choose either the express view or the standard view of the client graphical user interface (GUI).

## Supported Clients

---

This option is valid for all Windows clients.

## Options File

---

Place this option in the dsm.opt file. To switch to the Express view:

1. In the backup-archive client GUI, select Edit > Preference from the menu bar.
2. From the General tab of the Preferences editor, in the Client View field, click Express.
3. Click OK to save your change.

To switch to the Standard view:

1. In the backup-archive client GUI, click Modify Settings.
2. From the General tab of the Preferences Editor, in the Client View field, click Standard.
3. Click OK to save your change.

## Syntax

---

```
>>-CLIENTVIEW = .-standard-.
                  +-----+----->>
                  '-express--'
```

## Parameters

---

standard

Specifies that the standard, or enterprise, view of the backup-archive client GUI should be used. The standard view contains the advanced features of the backup-archive client GUI. This is the default.

express

Specifies that the express view of the backup-archive client GUI should be used. The express view contains the same features as the Express backup client GUI.

Windows

## Clusterdiskonly

---

The clusterdiskonly option specifies whether the backup-archive client allows the backup of only clustered disks in specific environments.

The backup-archive client allows for the backup of only clustered disks when the client is running in the following environments:

- In a Microsoft Cluster Server (MSCS)
- When failover clustering is employed on a supported Windows Server client
- In a VERITAS Cluster Server (VCS) environment, when you set clusternode yes

The backup-archive client previously allowed only backups and restores of data on clustered drives that were mounted as a drive letter.

It is common to find clustered drives that are mounted as volume mount points. Windows Server operating systems allow users to surpass the 26-drive-letter limitation by allowing volume mount points to be defined on a clustered server. The client can protect data on cluster disks that are mounted as drive letters on Windows Server OS computers. The client can also protect data on cluster disks that are mounted as volume mount points. The backup-archive client can automatically determine whether a volume that is using a volume mount point is a cluster volume.

When you set clusterdiskonly yes, the backup-archive client continues to segregate local drives from cluster drives when it evaluates the ALL-LOCAL domain option. When clusterdiskonly no is specified, you must explicitly define the backup domains. When clusterdiskonly no is specified, the backup-archive client also bypasses enumeration of cluster resources to determine which resources represent cluster drives.

## Supported Clients

---

This option is valid for all supported Windows Server clients.

## Options File

---

Place this option in the client options file (dsm.opt).

## Syntax

---

```
>>-CLUSTERDISKOnly-+-Yes-+-----+----->>  
                    '-No--'
```

## Parameters

---

Yes

Specifies that the client allows only the processing of cluster drives. Yes is the default.

No

Specifies that the client allows the processing of any disk when clusternode yes is set.

## Examples

---

Scenario 1: Back up a node that manages the local (non-clustered) drives and the system state information

This is the node that is dedicated to the restoration of the physical system if a hardware failure occurs. There are no clustered drives that are mounted as volume mount points.

Options file:

```
CLUSTERNODE NO (default)
CLUSTERDISKONLY YES (default)
DOMAIN ALL-LOCAL (default)
EXCLUDE c:\...\file.txt
```

Scenario 1b: Back up a node that manages the local (non-clustered) drives and the system state information and bypass enumeration of cluster resources

This is a scenario similar to scenario 1, which can be deployed if the backup-archive client takes an inappropriate amount of time during startup processing. During initialization of the backup-archive client, all of the cluster resources are enumerated to determine which resources represent cluster disk devices. This processing can be skipped by setting clusterdiskonly no.

Options file:

```
CLUSTERNODE NO (default)
CLUSTERDISKONLY NO
DOMAIN C: D: (local drives must be explicitly enumerated)
EXCLUDE c:\...\file.txt
```

Scenario 2: Back up a node that manages the clustered drives within a cluster resource group and bypass enumeration of cluster resources

This is a scenario that can be deployed if the backup-archive client takes an inappropriate amount of time during startup processing. During initialization of the backup-archive client, all of the cluster resources are enumerated to determine which resources represent cluster disk devices. This processing can be skipped by setting clusterdiskonly no.

Options file:

```
CLUSTERNODE YES
CLUSTERDISKONLY NO
DOMAIN f: g:
EXCLUDE f:\...\file.txt
```

Scenario 3: Back up a node that manages the clustered drives within a cluster resource group, by using volume mount points as cluster resources

In this scenario, it is assumed that the node is responsible for backing up a cluster resource group that has two drives, f: and f:\mnt. There are clustered drives that are mounted as volume mount points (Windows Server operating systems). Ensure that you define the incremental processing domain as only the volumes within a cluster resource group. If you have multiple cluster resource groups, assign a unique client node to manage each cluster resource group.

Options file

```
CLUSTERNODE YES
CLUSTERDISKONLY YES
DOMAIN f: f:\mnt
EXCLUDE f:\mnt\...\file.txt
```

Table 1 lists the clusternode and clusterdiskonly combinations.

Table 1. Clusternode and clusterdiskonly combinations

Clusternode	Clusterdiskonly	When to use
no	yes	This is the default behavior if nothing is specified; since the clusterdiskonly option is set to clusterdiskonly yes, the cluster disk map is built. This combination is used for backing up local drives.
yes	yes	This is the default way to run in a cluster node to back up cluster disks, including disks that are exposed as mount points; the cluster disk map is built.
yes	no	For clients that run on Windows Server operating systems, you must specify clusterdiskonly no only if you want to bypass cluster volume enumeration for performance reasons.

Windows

## Clusternode



The `clusternode` option specifies how the backup-archive client manages cluster drives.

**Windows** The backup-archive client manages clustered drives in the following environments:

- A Microsoft Cluster Server (MSCS)
- Failover Clustering on Windows Server systems
- VERITAS Cluster Server (VCS)

When the `clusternode yes` is set, only shared cluster drives are available for backup and archive processing. When you set `clusternode yes`, the node name defaults to the cluster name.

**Windows** To back up local drives or Windows Server system state, you must set `clusternode no`.

**Note:** You must set the `clusternode yes` for all IBM Spectrum Protect™-managed cluster operations. Inconsistent use of the `clusternode` option for a given IBM Spectrum Protect cluster node name can cause the cluster node name encrypted password to be invalidated, and prompt the user to reenter the password during the next IBM Spectrum Protect program invocation.

Use the `optfile` option to properly call the correct (cluster) `dsm.opt` for all IBM Spectrum Protect programs to ensure proper functionality for cluster related operations. See the `optfile` option description for more information.

**Windows**

## Supported Clients

---

This option is valid for Windows Server operating system clients.

## Options File

---

Place this option in the client options file (`dsm.opt`).

## Syntax

---

```
>>-CLUSTERnode-+-No--+-+-----+----->>  
                '-Yes-'
```

## Parameters

---

**Windows** Yes

**Windows** Specifies that you want the client to manage cluster drives in the following environments:

- A MSCS
- Failover Clustering on Windows Server systems
- VCS

No

Specifies that you want to back up local disks. This is the default.

## Examples

---

Options file:

```
cluster no
```

Command line:

```
-cluster=yes
```

This option is valid only on the initial command line. It is not valid in interactive mode.

## Collocatebyfilespec

---

Use the `collocatebyfilespec` option to specify whether the backup-archive client uses only one server session to send objects generated from one file specification.

Setting the `collocatebyfilespec` option to `yes` attempts to eliminate interspersing of files from different file specifications, by limiting the client to one server session per file specification. Therefore, if you store the data to tape, files for each file specification are stored together on one tape (unless another tape is required for more capacity).

Considerations:

- Use the `collocatebyfilespec` option only if the storage pool is going directly to tape. If you use this option going to a disk storage pool, you could affect some load balancing, and therefore, performance.

AIX Linux Solaris Mac OS X Windows

## Supported Clients

---

AIX Linux Solaris Mac OS X This option is valid for all UNIX and Linux clients. The server can also define this option.

Windows This option is valid for all Windows clients. The server can also define this option.

## Options File

---

AIX Linux Solaris Mac OS X Place this option in the client user-options file (`dsm.opt`).

Windows Place this option in the client options file (`dsm.opt`).

## Syntax

---

```
>>-COLlocatebyfilespec-----><
      .-No--.
      '-Yes-'
```

## Parameters

---

Yes

Specifies that you want the client to use only one server session to send objects generated from one file specification. Therefore, if you store the data to tape, files for each file specification are stored together on one tape, unless another tape is required for more capacity. Restore performance can increase as a result.

No

Specifies that the client can (depending on the execution dynamics and on the setting of the `resourceutilization` option of 3 or higher) use more than one server session to send the files from one file specification. This is the default.

Backup performance might increase as a result. If the files are backed up to tape, files are stored on multiple tapes. Generally, the files specified in the file specification are still contiguous.

## Examples

---

Options file:

```
collocatebyfilespec yes
```

Command line:

```
-collocatebyfilespec=yes
```

This option is valid only on the initial command line. It is not valid in interactive mode.

## Commethod

---

The `commethod` option specifies the communication method you use to provide connectivity for client-server communication.

## Supported Clients

---

This option is valid for all clients.

## Options File

---

**AIX** **Linux** **Solaris** **Mac OS X** Place this option in the client system-options file (dsm.sys) within a server stanza. You can set this option on the Communication tab of the Preferences editor.

**Windows** Place this option in the client options file (dsm.opt). You can set this option on the Communication tab of the Preferences editor.

**AIX** **Linux** **Solaris** **Mac OS X**

## Syntax

---

```
      .-TCPIP-----.  
>>-COMMethod+-----><  
      +-SHAREdmem-+  
      '-V6TCPIP---'
```

**Windows**

## Syntax

---

```
      .-TCPIP-----.  
>>-COMMethod+-----><  
      +-SHAREdmem--+  
      +-V6TCPIP-----+  
      '-NAMedpipes-'
```

## Parameters

---

### TCPip

The Transmission Control Protocol/Internet Protocol (TCP/IP) communication method. This is the default.

### V6Tcpi

Indicates that either TCP/IP V4 or V6 should be used, depending on the system configuration and the results of a domain name service lookup. A valid DNS environment must be available.

**Windows** **NAMedpipes**

**Windows** The interprocess communication method that permits message data streams to pass between a client and a server. Use this communication method with an IBM Spectrum Protect™ server that is running on the same workstation as the client.

**AIX** **Linux** **Solaris** **SHAREdmem**

**AIX** **Linux** **Solaris** Use the shared memory communication method when the client and server are running on the same system. This provides better performance than the TCP/IP protocol.

**AIX** **Linux** **Solaris** This option is valid for AIX®, Linux, and Oracle Solaris clients.

When specifying this communication method on AIX, the client can be logged in as root or non-root, as long as the server is running as root. If the server is not running as root, the user ID running the client must match the user ID running the server.

**Important:** When using commmethod sharedmem on Linux, you might receive error message: ANR8294W Shared Memory Session unable to initialize on the server or storage agent console. By default, Linux is not set up with sufficient system resources to create the message queues. You must increase the kernel parameter, MSGMNI, to 128 (the default is 16). You can modify this parameter by performing the following command:

```
echo 128 > /proc/sys/kernel/msgmni
```

To enable this parameter to remain persistent after rebooting the system, you can instead add the following line to the file /etc/sysctl.conf, then reboot the system:

```
kernel.msgmni=128
```

To view the current ipc settings, run this command:

```
ipcs -l
```

Now look at the max queues system wide value. The default is 16.

**Windows** SHAREdmem

**Windows** Use the shared memory communication method when the client and server are running on the same system. This provides better performance than the TCP/IP protocol.

Note: Use of this communication method requires that both client and server run under the same Windows account.

## Examples

---

Options file:

Use only TCP/IP V4.

```
commmethod tcpip
```

Use both TCP/IP V4 and V6, depending on how the system is configured, and the results of a domain name service lookup.

```
commmethod V6Tcpip
```

Note: The dsmc schedule command cannot be used when both SCHEDMODE prompt and commmethod V6Tcpip are specified.

Command line:

```
-commm=tcpip
```

```
-commm=V6Tcpip
```

This option is valid only on the initial command line. It is not valid in interactive mode.

## Commrestartduration

---

The commrestartduration option specifies the maximum number of minutes you want the client to try to reconnect to the IBM Spectrum Protect™ server after a communication error occurs.

Note: A scheduled event continues if the client reconnects with the server before the commrestartduration value elapses, even if the startup window of the event has elapsed.

You can use the commrestartduration option and the commrestartinterval in busy or unstable network environments to decrease connection failures.

**AIX** | **Linux** | **Solaris** | **Mac OS X** | **Windows**

## Supported Clients

---

This option is valid for all clients.

## Options File

---

**AIX** | **Linux** | **Solaris** | **Mac OS X** Place this option in the client system-options file (dsm.sys) within a server stanza. You can set this option on the Communication tab, Common Options section of the Preferences editor.

**Windows** Place this option in the client options file (dsm.opt). You can set this option on the Communication tab, Common Options section of the Preferences editor.

## Syntax

---

```
>>-COMMRESTARTDuration- minutes-----<<
```

## Parameters

---

minutes

The maximum number of minutes you want the client to attempt to reconnect with a server after a communication failure occurs. The range of values is zero through 9999; the default is 60.

## Examples

---

Options file:  
    commrestartduration 90  
Command line:  
    Does not apply.

## Commrestartinterval

---

The commrestartinterval option specifies the number of seconds you want the client to wait between attempts to reconnect to the IBM Spectrum Protect™ server after a communication error occurs.

Note: Use this option only when commrestartduration is a value greater than zero.

You can use the commrestartduration option and the commrestartinterval in busy or unstable network environments to decrease connection failures.

**AIX** | **Linux** | **Solaris** | **Mac OS X** | **Windows**

## Supported Clients

---

This option is valid for all clients.

## Options File

---

**AIX** | **Linux** | **Solaris** | **Mac OS X** Place this option in the client system-options file (dsm.sys) within a server stanza. You can set this option on the Communication tab, Common Options section of the Preferences editor.

**Windows** Place this option in the client options file (dsm.opt). You can set this option on the Communication tab, Common Options section of the Preferences editor.

## Syntax

---

```
>>-COMMRESTARTInterval- seconds-----<<
```

## Parameters

---

seconds  
    The number of seconds you want the client to wait between attempts to reconnect with a server after a communication failure occurs. The range of values is zero through 65535; the default is 15.

## Examples

---

Options file:  
    commrestartinterval 30  
Command line:  
    Does not apply.

## Compressalways

---

The compressalways option specifies whether to continue compressing an object if it grows during compression.

Use this option with the compression option, and with the archive, incremental, and selective commands.

The compressalways option is ignored when client-side deduplication is enabled.

**AIX** | **Linux** | **Solaris** | **Mac OS X** | **Windows**

## Supported Clients

---

This option is valid for all clients. The server can also define this option.

## Options File

---

**AIX** | **Linux** | **Solaris** | **Mac OS X** Place this option in the client user-options file (dsm.opt). You can set this option on the Backup tab, Continue Compressing if Object Grows check box of the Preferences editor.

**Windows** Place this option in the client options file (dsm.opt). You can set this option on the Backup tab, Continue Compressing if Object Grows check box of the Preferences editor.

## Syntax

---

```
>>-COMPRESSAlways--+-Yes-+-----+----->>  
                    '-No--'
```

## Parameters

---

Yes

File compression continues even if the file grows as a result of compression. This is the default.

No

Backup-archive client objects are resent uncompressed if they grow during compression. API behavior depends on the application. Application backups might fail.

## Examples

---

Options file:

```
compressalways yes
```

Command line:

```
-compressa=no
```

This option is valid only on the initial command line. It is not valid in interactive mode.

## Compression

---

The compression option compresses files before you send them to the server.

Compressing your files reduces data storage for backup versions and archive copies of your files. It can, however, affect IBM Spectrum Protect™ throughput. A fast processor on a slow network connection benefits from compression, but a slow processor on a fast network connection does not.

Use the compression option with the archive, incremental, and selective commands.

**AIX** | **Linux** | **Solaris** The backup image command uses the compression option value specified in the dsm.sys file. This option is valid on the initial command line and in interactive mode. The server can also define this option which overrides the client value.

**Windows** The backup image command uses the compression option value specified in the dsm.opt file. This option is valid on the initial command line and in interactive mode. The server can also define this option which overrides the client value.

The backup-archive client backs up a sparse file as a regular file if client compression is off. Set compression yes to enable file compression when backing up sparse files to minimize network transaction time and maximize server storage space.

If you set compressalways yes, compression continues even if the file size increases. To stop compression if the file size grows, and resend the file uncompressed, set compressalways no.

If you set compression yes, you can control compression processing in the following ways:

- **Windows** Use the exclude.compression option in your client options file (dsm.opt) to exclude specific files or groups of files from compression processing.
- **AIX** | **Linux** | **Solaris** | **Mac OS X** Use the exclude.compression option in your client system-options file (dsm.sys) to exclude specific files or groups of files from compression processing.
- **Windows** Use the include.compression option in your client options file (dsm.opt) to include files within a broad group of excluded files for compression processing.

- **AIX** | **Linux** | **Solaris** | **Mac OS X** Use the `include.compression` option in your client system-options file (`dsm.sys`) to include files within a broad group of excluded files for compression processing.

This option controls compression only if your administrator specifies that your client node can compress files before sending them to the server.

The type of compression that the client uses is determined by the combination of compression and client-side data deduplication that is used during backup or archive processing. The following types of compression are used:

#### LZ4

A faster and more efficient compression method that the client uses when client-deduplicated data is sent to an LZ4-compatible container storage pool on the IBM Spectrum Protect server. The server must be at version 7.1.5 or later, and must use container storage pools. Client-side LZ4 compression is used only when client-side data deduplication is enabled.

#### LZW

A traditional type of compression that the client uses in any of the following situations:

- Client-deduplicated data is sent to traditional (non-container) storage pools on the server.
- The client data does not undergo client-side data deduplication. (Does not apply to Data Protection for VMware and Data Protection for Microsoft Hyper-V, in which only client-deduplicated data can be compressed.)
- The client data undergoes only traditional server-side data deduplication. (Does not apply to Data Protection for VMware and Data Protection for Microsoft Hyper-V, in which only client-deduplicated data can be compressed.)

#### None

The object is not compressed by the client. The object is not compressed because the compression option is set to `no`, or the option is not specified during backup or archive processing. Although the object is not compressed by the client, it might be compressed by the server.

You do not need to set the compression type. It is determined by the backup-archive client at the time of backup or archive processing.

## Supported Clients

---

This option is valid for all clients. The server can also define this option.

## Options File

---

**AIX** | **Linux** | **Mac OS X** | **Solaris** Place this option in the `dsm.sys` file within a server stanza. You can set this option on the Backup tab, Compress objects check box of the Preferences editor.

**Windows** Place this option in the client options file (`dsm.opt`). You can set this option on the Backup tab, Compress objects check box of the Preferences editor.

## Syntax

---

```
>>-COMPRESSIon--+-No-- .  
                  |-----+-----><  
                  '-Yes-'
```

## Parameters

---

- No  
Files are not compressed before they are sent to the server. This is the default.
- Yes  
Files are compressed before they are sent to the server.

## Examples

---

Options file:  
    compression yes

Command line:  
    -compressi=no

This option is valid only on the initial command line. It is not valid in interactive mode.

**Related reference:**

- Deduplication
- Exclude options
- Include options

## Console

---

Use the console option with the query systeminfo command to output information to the console.

- DSMOPTFILE - The contents of the dsm.opt file.
- **AIX** | **Linux** | **Solaris** | **Mac OS X** DSMSYSFILE - The contents of the dsm.sys file.
- ENV - Environment variables.
- ERRORLOG - The IBM Spectrum Protect™ error log file.
- FILE - Attributes for the file name that you specify.
- **Windows** FILESNOTTOBACKUP - Enumeration of Windows Registry key:

```
HKEY_LOCAL_MACHINE\  
  SYSTEM\  
    CurrentControlSet\  
      BackupRestore\  
        FilesNotToBackup
```

This key specifies those files that backup products should not back up. The query inclexcl command indicates that these files are excluded per the operating system.

- INCLEXCL - Compiles a list of include-exclude in the order in which they are processed during backup and archive operations.
- **Windows** KEYSNOTTORESTORE - Enumeration of Windows Registry key:

```
HKEY_LOCAL_MACHINE\  
  SYSTEM\  
    ControlSet001\  
      BackupRestore\  
        KeysNotToRestore
```

This key specifies those Windows Registry keys that backup products should not restore.

- **Windows** MSINFO - Windows system information (output from MSINFO32.EXE).
- OPTIONS - Compiled options.
- **Windows** OSINFO - Name and version of the client operating system
- **AIX** | **Linux** | **Solaris** | **Mac OS X** OSINFO - Name and version of the client operating system (includes ULIMIT information for UNIX and Linux).
- POLICY - Policy set dump.
- **Windows** REGISTRY - Windows IBM Spectrum Protect-related Windows Registry entries.
- SCHEDLOG - The contents of the IBM Spectrum Protect schedule log (usually dsmsched.log).
- **Windows** SFP - The list of files protected by Windows System File Protection, and for each file, indicates whether that file exists. These files are backed up as part of the SYSFILES system object.
- **Windows** SFP=*filename* - Indicates whether the specified file (*filename*) is protected by Windows System File Protection.

For example:

```
SFP=C:\WINNT\SYSTEM32\MSVCRT.DLL
```

- **Windows** SYSTEMSTATE - Windows system state information.
- **AIX** CLUSTER - AIX® cluster information.
- **Windows** CLUSTER - Windows cluster information.

**AIX** | **Linux** | **Solaris** | **Mac OS X** | **Windows**

## Supported Clients

---

This option is valid for all clients.

## Syntax

---

```
>>-CONsole-----<<
```



## Parameters

---

There are no parameters for this option.

## Examples

---

Command line:

```
query systeminfo dsmdptfile errorlog -console
```

**Linux** | **Windows**

## Createnewbase

---

The createnewbase option creates a base snapshot and uses it as a source to run a full incremental backup.

Some files might not be backed up when the snapshot difference incremental backup command is run. If the files are skipped, you can run a snapshot difference incremental backup with the createnewbase option to back up these files. See Snapdiff for a list of reasons why a file might not be backed up when the snapshot difference command is run.

One reason that a file can be skipped during backup processing is because the file name is not supported by NetApp Data ONTAP. NetApp Data ONTAP Versions 8.0 and versions lower than 7.3.3 only support file names that are within the 7 bit ASCII character set. NetApp Data ONTAP Version 7.3.3 and versions greater than 8.0.0 support Unicode file names. If you upgraded NetApp Data ONTAP from a version that does not support Unicode file names to a version that does support Unicode file names, run a full incremental backup with the createnewbase=migrate option.

## Supported Clients

---

This option is valid for the following clients:

- **Windows** All Windows clients
- **Linux** Linux x86\_64 clients

Enter the createnewbase option on the command line. Specify this option with the snapdiff option.

## Syntax

---

```
>>-Createnewbase--+-No-----.  
+-----+-----><  
+-Yes-----+  
+-IGNore--+  
'-MIGRate-'
```

## Parameters

---

No

Specifies that a snapshot difference incremental is run. If the backup-archive client detects that the NetApp Data ONTAP file server has been migrated from a version that does not support Unicode file names to a file server that does, a warning message is recorded to the error log and the IBM Spectrum Protect™ server activity log. The warning message indicates that you must run a full incremental backup and logs a return code of 8 even if the operation completed successfully. This parameter is the default value.

Yes

Specifies that a full incremental is run by creating a new base snapshot and is using it to run a scan-based incremental backup. Use this option to back up any file changes that might not have been detected by the snapshot difference API. If the operation finished successfully, the command ends with a return code of 0.

Do not set createnewbase=yes for any schedule that runs a daily snapshot difference backup. Instead, create a separate, monthly schedule that has the createnewbase=yes option.

IGNore

Specifies that a snapshot difference incremental backup is run when the backup-archive client detects that the NetApp Data ONTAP file server was upgraded to support Unicode file names.

The ignore option is different from the no parameter because the ignore option suppresses the warning message. Instead, an informational message is recorded in the error log and the IBM Spectrum Protect activity log that informs you to run a full incremental backup.

If the command finishes successfully, it returns a code of 0.

Use the ignore option if you have upgraded the NetApp Data ONTAP file server to support Unicode but you have not yet run a full incremental backup. This option is used only when the backup-archive client has detected that the file server was migrated and a full incremental has not yet been run. The option is ignored for all other times.

#### MIGRate

Specifies that if the NetApp Data ONTAP file server was upgraded to a version that supports Unicode file names, a base snapshot is taken and a scan-based incremental backup is run. The migrate option is different from the yes option because the migrate option creates a base snapshot only when the client detects that the NetApp Data ONTAP file server version was updated. The yes option creates a base snapshot every time the command is run.

After the incremental backup finishes, no additional migration-related messages are recorded to the error log or the IBM Spectrum Protect server activity log. When the operation finishes, the command ends with a return code of 0.

Use the migrate option if you have upgraded the NetApp Data ONTAP file server to support Unicode but you have not yet run a full incremental backup. The migrate option is ignored if the NetApp Data ONTAP file server has not been upgraded.

## Examples

---

Command line:

```
dsmc incremental -snapdiff -createnewbase=yes /net/home1
```

Linux | Windows

## Datcenter

---

Specifies the target location of the data center that will contain the restored machine data.

Use this option on restore vm commands.

If folders are used within virtual center to organize datacenters, then the folder name needs to be included in the datacenter specification, separated by a slash.

If you are restoring through a ESX server rather than a virtual center, the -datacenter=ha-datacenter option should be used.

The default target location is the datacenter which the virtual machine was stored at the time of backup.

 This feature is available only if the client operates as a data mover for IBM Spectrum Protect™ for Virtual Environments: Data Protection for VMware.

## Examples

---

Restore a virtual machine to USEast datacenter which is organized under a folder named Production in the virtual center.

```
dsmc restore vm my_vm -datacenter=Production/USEast
```

Restore a virtual machine backup taken from a virtual center, but using a ESX server at the time of restore.

```
restore vm my_vm -datacenter=ha-datacenter
```

Restore the virtual machine into the USWest datacenter.

```
restore vm my_vm -datacenter=USWest
```

Linux | Windows

## Datastore

---

Specifies the datastore target to be used during VMware restore operation.

 This feature is available only if the client operates as a data mover for IBM Spectrum Protect™ for Virtual Environments: Data Protection for VMware.

## Example

---

Restore the virtual machine to a datastore named ds8k\_prod1:

```
restore vm my_vm -datastore=ds8k_prod1
```

## Dateformat

---

The dateformat option specifies the format you want to use to display or enter dates.

**Windows** Use this option if you want to change the default date format for the language of the message repository you are using.

**AIX** | **Linux** | **Solaris** | **Mac OS X** | **Windows** By default, the backup-archive and administrative clients obtain format information from the locale definition in effect at the time you start the client. Consult the documentation on your local system for details about setting up your locale definition.

Note:

1. The dateformat option does not affect the web client. The web client uses the date format for the locale that the browser is running in. If the browser is not running in a locale that is supported, the web client uses the date format for US English.
2. When you change the date format and use the schedlogretention option to prune the schedule log, the client removes all entries in the schedule log with a different date format when pruning the log. When you change the date format and use the errorlogretention option to prune the error log, the client removes all entries in the error log with a different date when pruning the log. When changing the date format, copy the schedule log and error log if you want to preserve log entries that contain a different date format.

You can use the dateformat option with the following commands.

- delete archive
- delete backup
- expire
- query archive
- **Windows** query asr
- query backup
- query filespace
- **AIX** | **Linux** | **Solaris** query image
- **Windows** query image
- **Windows** query systemstate
- restore
- **AIX** | **Linux** | **Solaris** restore image
- **Windows** restore image
- **AIX** | **Linux** | **Solaris** | **Mac OS X** restore nas
- **Windows** restore nas
- retrieve
- **Windows** restore registry
- set event

When you include the dateformat option with a command, it must precede the fromdate, pitdate, and todate options.

## Supported Clients

---

This option is valid for all clients.

## Options File

---

**AIX** | **Linux** | **Solaris** | **Mac OS X** Place this option in the client user-options file (dsm.opt). You can set this option on the Regional Settings tab, Date Format drop-down list of the Preferences editor.

**Windows** Place this option in the client options file (dsm.opt). You can set this option on the Regional Settings tab, Date Format drop-down list of the Preferences editor.

## Syntax

---

```
>>-DATEformat-- --format_number-----><
```

## Parameters

---

### format\_number

Displays the date using one of the following formats. Select the number that corresponds to the date format you want to use:

AIX	Linux	Solaris	0
-----	-------	---------	---

AIX	Linux	Solaris
-----	-------	---------

 Use the locale-specified date format (does not apply to Mac OS X).

AIX	Solaris
-----	---------

 For AIX® and Solaris: This is the default if the locale-specified date format consists of digits and separator characters.

1

MM/DD/YYYY

AIX	Solaris
-----	---------

 For AIX and Solaris: This is the default if the locale-specified date format consists of anything but digits and separator characters.

AIX	Linux	Solaris	Windows
-----	-------	---------	---------

 This is the default for the following available translations:

AIX	Linux	Solaris	Windows
-----	-------	---------	---------

- US English
- Chinese (Traditional)
- Korean

2

DD-MM-YYYY

AIX	Linux	Solaris	Windows
-----	-------	---------	---------

 This is the default for the following available translations:

AIX	Linux	Solaris	Windows
-----	-------	---------	---------

- Brazilian Portuguese
- Italian

3

YYYY-MM-DD

AIX	Linux	Solaris	Windows
-----	-------	---------	---------

 This is the default for the following available translations:

AIX	Linux	Solaris	Windows
-----	-------	---------	---------

- Japanese
- Chinese (Simplified)
- Polish

4

DD.MM.YYYY

AIX	Linux	Solaris	Windows
-----	-------	---------	---------

 This is the default for the following available translations:

AIX	Linux	Solaris	Windows
-----	-------	---------	---------

- German
- French
- Spanish
- Czech
- Russian

5

YYYY.MM.DD

AIX	Linux	Solaris	Windows
-----	-------	---------	---------

 This is the default for the following available translations:

AIX	Linux	Solaris	Windows
-----	-------	---------	---------

- Hungarian

6	YYYY/MM/DD
7	DD/MM/YYYY

## Examples

Options file:  
 dateformat 3  
 Command line:  
 -date=3

This option is valid on the initial command line and in interactive mode. If you use this option in interactive mode, it affects only the command with which it is specified. When that command completes, the value reverts to the value at the beginning of the interactive session. This is the value from the `dsm.opt` file unless overridden by the initial command line or by an option forced by the server.

## Additional considerations for specifying time and date formats

The date or time format you specify with this option must be used when using options that take date and time as input. Examples are: `totime`, `fromtime`, `today`, `fromdate`, and `pittime`.

For example, if you specify the `timeformat` option as `TIMEFORMAT 4`, the value that you provide on the `fromtime` or `totime` option must be specified as a time such as `12:24:00pm`. Specifying `13:24:00` would not be valid because `TIMEFORMAT 4` requires an hour integer that is 12 or less. If you want to specify up to 24 hour values on an option, and if you want to use commas as separators, you must specify `TIMEFORMAT 2`.

AIX Linux Mac OS X Solaris

## Configuring date and time formats in the system locale configuration file

You can specify date and time formats by configuring them in your system's locale file. If you specify time and date formats in the locale file, they must be defined using a subset of number-producing format specifiers that are supported by the C language `strftime()` function. You can use the following specifiers to set date and time formats in configuration settings for your locale.

### Date specifiers

- `%Y` - the year, in four digits. For example, 2011.
- `%y` - the year, last two digits only. For example, 11 not 2011.
- `%m` - the month, as a decimal number (1-12).
- `%d` - the day of the month (1-31).

In the date specifiers, you can specify only one year specifier. Do not specify both `%Y` and `%y`. The E modifier (a capital E) can precede the date specifiers to produce the locale's alternative form for the year, month, or day. If no alternative form exists, the E modifier is ignored. Separate the specifiers with a single 7-bit ASCII character. Commonly used separators include colons (:), commas (,), periods (.), hyphens (-), or forward slash (/) characters. Do not use multibyte characters as separators.

### Time specifiers

- `%H` - the hour, in 24-hour form (00-23).
- `%I` - the hour, in 12-hour form (00-12).
- `%M` - minutes after the hour (00-59).
- `%S` - seconds after the minute (00-59)
- `%p` - adds the AM (before noon) or PM (after noon) indicator.

In the time specifiers, you can specify only one hour specifier. Do not specify both `%I` and `%H`.

The O modifier (a capital O) can precede the time specifiers to produce the locale's alternative form for the hour, minutes, or seconds. The O modifier cannot precede the `%p` specifier. Separate the specifiers with a single 7-bit ASCII character. Commonly used separators include colons (:), commas (,), or periods (.). Do not use multibyte characters as separators. Do not specify a separator between the `%p` specifier and the separator that precedes or follows it.

Time format examples, configured in the locale settings

**AIX** | **Linux** | **Mac OS X** | **Solaris** To set a particular time format, edit the configuration file for your locale and modify the `t_fmt` line to support your needs. Whatever time format you select applies both to output and to input. After the locale configuration file has been edited, the `localedef` command must be run to create the final locale file.

Table 1. Sample time format settings in the locale configuration (`t_fmt` line)

Example	Result
"%H:%M:%S"	Displays time in the form <i>hh:mm:ss</i> with <i>hh</i> ranging from 0 through 23.
"%H,%M,%S"	Displays time in the form <i>hh,mm,ss</i> with <i>hh</i> ranging from 0 through 23.
"%I,%M,13p"	Displays time in the form <i>hh,mm,ssA/P</i> with <i>hh</i> ranging from 1 through 12 and <i>A/P</i> is the local abbreviation for ante-meridian (AM in English) or post-meridian (PM in English).

Date format examples, configured in the locale settings

**AIX** | **Linux** | **Mac OS X** | **Solaris** To set a particular date format, edit the configuration file and modify the `d_fmt` line as needed to support your needs. Whatever date format you select applies both to output and to input.

Table 2. Sample date format settings in the locale configuration (`d_fmt` line)

Example	Result
"%m/%d/%y"	Displays the date in the form MM/DD/YY.
"%d.%m.%Y"	Displays the date in the form DD.MM.YYYY.

## Dedupcachepath

Use the `dedupcachepath` option to specify the location where the client-side data deduplication cache database is created.

This option is ignored if the `enablededupcache=no` option is set during backup or archive processing.

## Supported Clients

This option is valid for all clients. This option is also valid for the IBM Spectrum Protect™ API.

## Options File

**AIX** | **Linux** | **Solaris** | **Mac OS X** Place this option in the system-options file (`dsm.sys`). You can set this option on the Deduplication Cache Location field of the Preferences editor. The option can be set in the client option set on the IBM Spectrum Protect server.

**Windows** Place this option in the client options file (`dsm.opt`). You can set this option on the Deduplication > Deduplication Cache Location text box of the Preferences editor. The option can be set in the client option set on the IBM Spectrum Protect server.

## Syntax

```
>>-DEDUPCACHEPath--path-----<<
```

## Parameters

`path`

Specifies the location where the client-side data deduplication cache database is created if the `enablededupcache` option is set to `yes`. The default location is to create the data deduplication cache file in the backup-archive client or API installation directory.

**Windows** In Uniform Naming Convention (UNC) format, the path must contain a drive letter. In the following UNC format example, the path contains the drive letter `D$`: `\\computer7\D$\stgmgr\dedupecache`.

## Examples

---

Options file:

```
AIX      Linux   Mac OS X Solaris dedupcachepath /volumes/temp
Windows dedupcachepath c:\logs\dedup\
```

Command line:

Does not apply.

**Related reference:**

Enablededupcache

## Dedupcachesize

---

Use the dedupcachesize option to determine the maximum size of the data deduplication cache file. When the cache file reaches its maximum size, the contents of the cache are deleted and new entries are added.

## Supported Clients

---

This option is valid for all clients. This option is also valid for the IBM Spectrum Protect™ API.

## Options File

---

```
AIX      Linux   Solaris Mac OS X
```

Place this option in the system-options file (dsm.sys). You can set this option on the Deduplication > Deduplication Cache > Maximum Size field of the Preferences editor. The option can be set in the client option set on the IBM Spectrum Protect server.

```
Windows
```

Place this option in the client options file (dsm.opt). You can set this option on the Deduplication > Deduplication Cache > Maximum Size field of the Preferences editor. The option can be set in the client option set on IBM Spectrum Protect server.

## Syntax

---

```
>>-DEDUPCACHESize--dedupcachesize-----<<
```

## Parameters

---

dedupcachesize

Specifies the maximum size, in megabytes, of the data deduplication cache file. The range of values is 1 - 2048; the default is 256.

## Examples

---

Options file:

```
dedupcachesize 1024
```

Command line:

Does not apply.

**Related reference:**

Deduplication

## Deduplication

---

Use the deduplication option to specify whether to enable redundant client-side data elimination when data is transferred to the IBM Spectrum Protect™ server during backup and archive processing.

Data deduplication is disabled if the enablelanfree option is set. Backup-archive client encrypted files are excluded from client-side data deduplication. Files from encrypted file systems are also excluded.

To support client-side data deduplication, the following criteria must be met:

- Client-side data deduplication for the node is enabled on the server.

- The storage pool destination for the data must be a storage pool that is enabled for data deduplication. The storage pool must have a device type of "file".
- A file can be excluded from client-side data deduplication processing (by default all files are included).
- The server can limit the maximum transaction size for data deduplication by setting the CLIENTDEDUPTXNLIMIT option on the server. For more information about the option, refer to the IBM Spectrum Protect server documentation.
- The file size must be larger than 2 KB.

## Supported Clients

---

This option is valid for all clients; it can also be used by the IBM Spectrum Protect API.

## Options File

---

**AIX** **Linux** **Solaris** **Mac OS X** Place this option in the system-options file (dsm.sys) within a server stanza. You can set this option by selecting the Deduplication > Enable Deduplication check box of the Preferences editor. The option can be set in the client option set on the IBM Spectrum Protect server.

**Windows** Place this option in the client options file (dsm.opt). You can set this option by selecting the Deduplication > Enable Deduplication check box of the Preferences editor. The option can be set in the client option set on IBM Spectrum Protect server.

## Syntax

---

```

>>-DEDUPLICATION-+-No-- .
                  +-Yes- '-----><

```

## Parameters

---

- No  
Specifies that you do not want to enable client-side data deduplication for backup and archive processing. No is the default.
- Yes  
Specifies that you want to enable client-side data deduplication for backup and archive processing.

## Examples

---

Options file:  
deduplication yes

Command line:  
-deduplication=yes

This option is valid only on the initial command line. It is not valid in interactive mode.

### Related reference:

Include options  
Exclude options

**AIX** **Linux** **Solaris** **Mac OS X**

## Defaultserver

---

Use the defaultserver option to specify the name of the IBM Spectrum Protect™ server to contact for backup-archive services if more than one server is defined in the dsm.sys file.

By default, the backup-archive contacts the server defined by the first stanza in the dsm.sys file. This option is only used if the servename option is not specified in the client user-options file (dsm.opt).

If you have the HSM client installed on your workstation, and you do not specify a migration server with the migrateserver option, use this option to specify the server to which you want to migrate files. For more information, see the IBM Spectrum Protect for Space Management product documentation on IBM Knowledge Center at <http://www.ibm.com/support/knowledgecenter/SSERBH/welcome>.

## Supported Clients

---



This option is valid for all UNIX clients.

## Options File

---

Place this option *at the beginning* of the dsm.sys file *before* any server stanzas.

## Syntax

---

```
>>-DEFAULTServer-- --servername-----><
```

## Parameters

---

servername

Specifies the name of the default server to which you back up or archive files. The server to which files are migrated from your local file systems can also be specified with this option.

## Examples

---

Options file:

defaults server\_a

Command line:

Does not apply.

## Deletefiles

---

Use the deletefiles option with the archive command to delete files from your workstation after you archive them.

**AIX** | **Linux** | **Solaris** | **Windows** You can also use this option with the restore image command and the incremental option to delete files from the restored image if they were deleted after the image was created. Deletion of files is performed correctly if the backup copy group of the IBM Spectrum Protect™ server has enough versions for existing and deleted files.

## Supported Clients

---

This option is valid for all clients. The IBM Spectrum Protect API does not support this option.

## Syntax

---

```
>>-DELetefiles-----><
```

## Parameters

---

There are no parameters for this option.

## Examples

---

Command line:

**Mac OS X**

```
dsmc archive "/Users/dgordon/Documents/*.c" -deletefiles
```

**AIX** | **Linux** | **Solaris**

```
dsmc archive "/home/foo/*.c" -deletefiles  
dsmc restore image /local/data -incremental -deletefiles
```

**Windows**

```
dsmc archive c:\foo\*.c -deletefiles  
dsmc rest image c: -incre -deletefiles
```

## Description

---

The description option assigns or specifies a description for files when performing archive, delete archive, retrieve, query archive, or query backupset.

For example, if you want to archive a file named budget.jan and assign to it the description "2002 Budget for Proj 1", you would enter:

```
AIX Linux Solaris Mac OS X
dsmc archive -des="2003 Budget for Proj 1" /home/plan/
proj1/budget.jan
```

### Windows

```
dsmc archive -des="2003 Budget for Proj 1" c:\plan\proj1\
budget.jan
```

Note:

1. The maximum length of a description is 254 characters.
2. Enclose the value in quotation marks (" ") if the option value that you enter contains a blank space.

Use the description option with the following commands:

- archive
- delete archive
- query archive
- query backupset
- retrieve

```
AIX Linux Solaris Mac OS X Windows
```

## Supported Clients

---

This option is valid for all clients. The IBM Spectrum Protect™ API does not support this option.

## Syntax

---

```
>>-DEscription = - --description-----<<
```

## Parameters

---

description

Assigns a description to the file you are archiving. If you do not specify a description with the archive command, the default is Archive Date:x, where x is the current system date. Note that the date is always 10 characters long. If your date format uses a two digit year, there are two blank spaces at the end of the date. For example, a default description using a four-digit year might be "Archive Date: 2002/05/03", and the same default with a two-digit year might be "Archive Date: 02/05/03 " (note the two spaces at the end). When retrieving files using the two-digit year description, you can enter the -description option string in either of the following ways:

```
-description="ArchiveDate: 02/05/03 "
or
-description="ArchiveDate: 02/05/03*"
```

If you use the archive command to archive more than one file, the description you enter applies to each file. For example, to archive a group of files and assign the same description, *Project X*, to each file, you would enter:

### Mac OS X

```
dsmc archive -description="Project X" "/Users/van/Documents/*.x"
```

```
AIX Linux Solaris Mac OS X
```

```
dsmc archive -description="Project X" "/home/allproj/*.x"
```

### Windows

```
dsmc archive -description="Project X" c:\allproj\*.x
```

You can then use the description to retrieve all of the files.

## Examples

---

Command line:

**Mac OS X**

```
dsmc archive "/Users/van/Documents/*.prj" -des="2003 Budget for Proj 1"
```

**AIX** | **Linux** | **Solaris** | **Mac OS X**

```
dsmc archive "/home/foo/*.prj" -des="2003 Budget for Proj 1"  
dsmc query backupset -loc=server -descr="My Laptop"
```

**Windows**

```
dsmc archive -des="2003 Budget for Proj 1" c:\foo\ *.prj
```

## Detail

---

Use the detail option to display management class, file space, backup, archive information, and additional information, depending on the command with which it is used.

Use the detail option with the query mgmtclass command to display detailed information about each management class in your active policy set. If you do not use the detail option, only the management class name and a brief description are displayed on the screen. If you specify the detail option, information about attributes in each copy group contained in each management class is displayed on the screen. A management class can contain a backup copy group, an archive copy group, both, or neither.

**AIX** | **Linux** | **Solaris** | **Mac OS X** | **Windows**

A Unicode-enabled file space might not display correctly if the server cannot display the Unicode name. In this case, use the file space identifier (fsID) of the file space to identify these file spaces on the server. Use the detail option with the delete filespace and query filespace commands to determine the fsID of a file space. The fsID also appears in the file information dialog in the backup-archive client and web client GUIs.

Use the detail option with the query backup and query archive commands to display these attributes of the file that you specify:

- Last modification date
- Last access date
- Compression
- Encryption type
- Client-side data deduplication
- Whether the HSM client migrated or premigrated the file

**Windows**

Use the detail option with the query adobjects command to display detailed information about Active Directory objects, including all of their attributes.

**Windows**

Use the detail option with the query adobjects command to display detailed information about Active Directory objects, including all of their attributes.

**Linux** | **Windows**

Use the detail with the query vm command to display the following statistics:

- The average number of IBM Spectrum Protect™ objects that are needed to describe a single megablock, across all megablocks in a backup.
- The average number of IBM Spectrum Protect objects that are needed to describe a single megablock, for all megablocks in a filespace.
- The ratio of the amount of data, reported by Change Block Tracking, versus the amount of data that was actually backed up, in a specific backup.
- The ratio of the amount of data, reported by Change Block Tracking, versus the amount of data that was actually backed up, for all backups in this filespace.
- The number of backups that were created since the last full backup was created from the production disks.

The values returned on query vm can help you fine tune the heuristics (see the Mbojrefreshthresh and Mbpctrefreshthresh options) to fine tune the values trigger for megablock refreshes.

Use the detail option with the following commands:

- delete filespace
- incremental

- **Windows** query adobjects
- query archive
- query backup
- query filespace
- query inclexcl
- query mgmtclass
- **Windows** query systemstate
- **Linux** **Windows** query vm

**AIX** | **Linux** | **Solaris** | **Mac OS X** | **Windows**

## Supported Clients

---

This option is valid for all clients. This option is not set in the client options file; use it by adding it to the command line when you enter any of the commands that support it. The IBM Spectrum Protect API does not support this option.

## Syntax

---

```
>>-DETail-----<<
```

## Parameters

---

There are no parameters for this option.

## Examples

---

Command line:

```
dsmc query mgmtclass -detail
dsmc query filespace -detail
dsmc query backup file1 -detail
```

**Windows**

```
dsmc query systemstate -detail
```

**Linux** | **Windows**

```
dsmc query vm -detail
```

**Linux** | **Windows**

## Diffsnapshot

---

The diffsnapshot option controls whether the backup-archive client creates the differential snapshot when it runs a snapshot difference incremental backup.

If the differential snapshot is not created by the client, the latest snapshot found on the volume is used as the differential snapshot and as the source for the backup operation.

The default value is to create the differential snapshot. This option is ignored the first time that the snapdiff option is used. The first time the snapdiff option is used on a volume, a snapshot must be created and used as the source for a full incremental backup. Snapshots that are created by the backup-archive client are deleted by the client after the next snapshot difference incremental backup is complete.

**Linux**

Snapshots can be created with the Network Appliance FilerView tool. Use the latest parameter if you want the client to use the most recent snapshot that was created with this or any other method. Snapshots that are created by methods outside of IBM Spectrum Protect™ are never deleted by the client.

**Windows**

Snapshots can be created with the Network Appliance FilerView tool. Use the latest parameter if you want the client to use the most recent snapshot that was created. Whatever method is used to create named snapshots, snapshot names that differ

only by case will not work properly with the `snappdiff` option. Snapshots that are created by the client will not have the casing problem. Snapshots that are created by methods outside of IBM Spectrum Protect are never deleted by the client.

## Supported Clients

---

**Windows** This option is valid for all Windows clients.

**Linux** This option is valid for Linux x86\_64 clients.

## Syntax

---

```
                .-create-.  
>>-DIFFSNAPSHOT-+-----+----->>  
                '-latest-'
```

## Parameters

---

`create`

Specifies that you want to create a new, persistent, snapshot to use as the source snapshot. This value is the default.

`latest`

Specifies that you want to use the latest snapshot that is found on the file server as the source snapshot.

## Examples

---

**Linux** Command line:

**Linux** Perform a snapshot difference incremental backup of an NFS mounted file system `/vol/vol1` hosted on the file server `homestore.example.com`, where `/net/home1` is the mount point of `/vol/vol1`.

```
Linux incremental -snappdiff -diffsnapshot=latest /net/home1
```

The `-diffsnapshot` option value of `latest` means that the operation uses the latest snapshot (the active snapshot).

**Windows** Command line:

**Windows** Perform a `snappdiff` incremental backup from a snapshot that was taken of a network share `//homestore.example.com/vol/vol1` mounted on drive `H:`, where `homestore.example.com` is a file server.

```
Windows incremental -snappdiff H:
```

**Windows** Perform a `snappdiff` incremental backup from a snapshot that was taken of a network share `//homestore.example.com/vol/vol1` mounted on drive `H:`, where `homestore.example.com` is a file server. The `-diffsnapshot` option value of `LATEST` means the operation uses the latest snapshot (the active snapshot) for volume `H:`.

```
Windows incremental -snappdiff H: -diffsnapshot=latest
```

**Linux** | **Windows**

## Diffsnapshotname

---

The `diffsnapshotname` option allows you to specify which differential snapshot, on the target filer volume, to use during a snapshot differential backup. This option is only specified if you also specify `diffsnapshot=latest`.

If this option is not specified, `diffsnapshot=latest` selects the most recent existing snapshot on the filer volume and uses it as the differential snapshot.

## Supported Clients

---

**Linux** This option can be used with supported x86\_64 Linux clients.

**Windows** This option can be used with supported Windows clients.

## Options File

---

This option can be specified in the client options file or on the command line.

## Syntax

---

```
>>-DIFFSNAPSHOTName-- --snapshot_name-----><
```

## Parameters

---

### *snapshot\_name*

Specifies the name of an existing snapshot to use as the differential snapshot.

You can also use a pattern with wildcard characters to select a snapshot. Wildcards can be either of the following characters:

\*

An asterisk (\*) matches any character.

?

A question mark (?) matches a single character.

The most recent snapshot that matches the wildcard pattern is selected as the differential snapshot.

## Examples

---

Options file:

```
diffsnapshotname volume_base_snap
```

```
diffsnapshotname nightly.?
```

Command line:

```
dsmc incr \\DRFiler\UserDataVol_Mirror_Share -snapdiff  
-useexistingbase -basenameshotname="nightly.?"  
-diffsnapshot=latest -diffsnapshotname="nightly.?"
```

### **Related reference:**

Useexistingbase

Basesnapshotname

## Dirmc

---

The dirmc option specifies the management class you want to use for directories.

If you do not specify this option to associate a management class with directories, the client program uses the management class in the active policy set of your policy domain with the longest retention period. Select a management class for individual directories that retains directories at least as long as it retains the files associated with them.

If you specify a management class with this option, all directories specified in a backup operation are bound to that management class.

The dirmc option specifies the management class of directories that you back up and it does not affect archived directories. Use the archmc option with the archive command to specify the available management class for your policy domain to which you want to bind your archived directories and files. If you do not use the archmc option, the server binds archived directories to the default management class. If the default management class has no archive copy group, the server binds archived directories to the management class with the shortest retention period.

Important: Only extended attributes and ACLs are stored in storage pools. The directory information, other than extended attributes and ACLs, remains in the database. On Windows systems, directories occupy storage pool space.

AIX	Linux	Solaris	Mac OS X	Windows
-----	-------	---------	----------	---------

## Supported Clients

---

This option is valid for all clients. The server can also define this option.

## Options File

---

AIX	Linux	Solaris	Mac OS X
-----	-------	---------	----------

Place this option in the dsm.sys file within a server stanza. You can set this option on the Backup tab, Directory Management Class section in the Preferences editor.

**Windows** Place this option in the client options file (dsm.opt). You can set this option on the Backup tab, Directory Management Class section in the Preferences editor.

## Syntax

---

```
>>-DIRMc-- --mgmtclassname-----><
```

## Parameters

---

mgmtclassname

Specifies the name of the management class that you want to associate with directories. The client uses the management class name that you specify for all of the directories that you back up. If you do not specify this option, the client associates the management class with the longest retention period with directories.

## Examples

---

Options file:

```
dirm managdir
```

Command line

Does not apply.

## Dirsonly

---

The dirsonly option processes directories *only*. The client does not process files.

Use the dirsonly option with the following commands:

- archive
- incremental
- query archive
- query backup
- restore
- restore backupset
- retrieve
- selective

## Supported Clients

---

This option is valid for all clients. The IBM Spectrum Protect™ API does not support this option.

## Syntax

---

```
>>-Dirsonly-----><
```

## Parameters

---

There are no parameters for this option.

## Examples

---

**Mac OS X** Command line:

```
Mac OS X dsmc query backup -dirsonly "/Users/*"
```

**AIX** | **Linux** | **Solaris** | **Mac OS X** Command line:

```
AIX | Linux | Solaris | Mac OS X dsmc query backup -dirsonly "*" 
```

**Windows** Command line:

```
Windows dsmc query backup -dirsonly c:*
```

## Disablenqr

---

The `disablenqr` option specifies whether the backup-archive client can use the no-query restore method for restoring files and directories from the server.

If you set the `disablenqr` option to `no` (the default), the client can use the no-query restore process.

If you set the `disablenqr` option to `yes`, the client can use only the standard restore process (also known as "classic restore").

Note: There is no option or value to specify that the client can use only the no-query restore method.

## Supported Clients

---

This option is valid for all clients. The IBM Spectrum Protect™ API does not support this option. The server can also define this option.

## Options File

---

Place this option in the `dsm.opt` file.

## Syntax

---

```
..-No--.  
>>-DISABLENQR-----<<  
'-Yes-'
```

## Parameters

---

No

Specifies that the client can use the no-query restore method. This is the default.

Yes

Specifies that the client uses only the standard restore method. The no-query restore method is not allowed.

## Examples

---

Options file:

```
disablenqr yes
```

Command line

```
-disablenqr=yes
```

## Diskbuffsize

---

The `diskbuffsize` option specifies the maximum disk I/O buffer size (in kilobytes) that the client can use when reading files. The `diskbuffsize` option replaces the `largecommbuffers` option.

**Windows** Optimal backup, archive migration client performance can usually be achieved if the value for this option is equal to or smaller than the amount of file read ahead provided by the client file system. A larger buffer requires more memory and it might not improve performance.

**AIX** | **Linux** | **Solaris** | **Mac OS X** Optimal backup, archive, or HSM migration client performance can usually be achieved if the value for this option is equal to or smaller than the amount of file read ahead provided by the client file system. A larger buffer requires more memory and it might not improve performance.

Important: Use the default setting, unless otherwise directed by IBM® support personnel.

**AIX** | **Linux** | **Mac OS X** | **Solaris** | **Windows**

## Supported Clients

---

This option is valid for all clients.



## Options File

---

**Windows** Place this option in the client options file (dsm.opt).

**AIX** | **Linux** | **Solaris** | **Mac OS X** Place this option in the client system-options file (dsm.sys) within a server stanza.

## Syntax

---

```
>>-DISKBufferSize-- --size-----><
```

## Parameters

---

**Windows** size

**Windows** Specifies the maximum disk I/O buffer size (in kilobytes) that the client uses when reading files. The range of values is 16 through 1023; the default is 32.

**AIX** | **Linux** | **Mac OS X** | **Solaris** size

**AIX** | **Linux** | **Mac OS X** | **Solaris** Specifies the maximum disk I/O buffer size (in kilobytes) that the client uses when reading files. The range of values is 16 through 1023; the default is 32. For AIX®: If enablelanfree no is set, the default setting for diskbuffersize is 256.

## Examples

---

Options file:

```
diskbuffersize 64
```

Command line:

```
Does not apply.
```

## Diskcachelocation

---

The diskcachelocation option specifies the location where the disk cache database is created if the option memoryefficientbackup=diskcachemethod is set during an incremental backup.

You can specify the diskcachelocation option in your option file, or with the include.fs option. If the diskcachelocation option appears in the option file, its value is used for all file systems not represented by an include.fs option containing the diskcachelocation option.

The disk cache is a temporary file which is deleted after the incremental command is run. Use this option to select one of the following:

1. A location that has more free disk space if, when you are using memoryefficientbackup=diskcachemethod, you get the message that the disk cache file cannot be created because you do not have enough disk space.
2. A location on a different physical volume to reduce contention for the disk access mechanism, and therefore improve performance.

Important: For performance reasons, do not use a remote drive for diskcachelocation.

**Mac OS X** | **AIX** | **Linux** | **Solaris** The actual amount of disk space required for the disk cache file created by disk cache incremental backups depends on the number of files and directories included in the backup and on the average length of the files and directories to be backed up. For UNIX and Linux, estimate 1 byte per character in the path name. For Mac OS X, estimate 4 bytes per character in the path name. For example, if there are 1 000 000 files and directories to be backed up and the average path length is 200 characters, then the database occupies approximately 200 MB for UNIX and Linux, and 800 MB for Mac OS X clients. Another way to estimate for planning purposes is to multiply the number of files and directories by the length of the longest path to establish a maximum database size.

**Windows** The actual amount of disk space required for the disk cache file created by disk cache incremental backups depends on the number of files and directories included in the backup and on the average length of the files and directories to be backed up. Estimate 2 bytes per character in the path name. For example, if there are 1 000 000 files and directories to be backed up and the average path length is 200 characters, then the database occupies approximately 400 MB. Another way to estimate for planning purposes is to multiply the number of files and directories by the length of the longest path to establish a maximum database size.

**AIX** | **Linux** | **Solaris** | **Mac OS X** A second disk cache file is created for the list of migrated files when backing up an HSM managed file system. The combined disk cache files, created by disk cache incremental backups and HSM managed file system backups, can require above 400 MB of disk space for each million files being backed up. The disk cache file can become very large. Large file support must be enabled on the file system that is being used for the disk cache file.

## Supported Clients

---

This option is valid for all clients. The server can also define this option.

## Options File

---

**Windows** Place this option in the client options file (dsm.opt).

**AIX** | **Linux** | **Solaris** | **Mac OS X** Place this option in the dsm.sys file within a server stanza.

## Syntax

---

```
>>-DISKCACHELocation-- --path-----<<
```

## Parameters

---

path

Specifies the location where the disk cache database is created if `memoryefficientbackup=diskcachemethod`. The default location is to create the disk cache file in the root of the file space being processed.

**Windows** In Uniform Naming Convention (UNC) format, the path must contain a drive letter. In the following UNC format example, the path contains the drive letter D\$: `\\computer7\D$\temp\diskcache`.

## Examples

---

**AIX** | **Linux** | **Solaris** | **Mac OS X** Options file:  
**AIX** | **Linux** | **Solaris** | **Mac OS X**

```
diskcachelocation /home  
diskcachelocation /Volumes/hfs2
```

**Windows** Options file:  
**Windows**

```
diskcachelocation c:\temp  
diskcachelocation c:\tivoli\data
```

Command line:

Does not apply.

## Domain

---

The domain option specifies what you want to include for incremental backup.

Domain objects are backed up only if you start the incremental command without a file specification.

**AIX** | **Linux** | **Mac OS X** | **Solaris** The backup-archive client uses the domain value in the following situations to determine which file systems to process during an incremental backup:

- When you run an incremental backup by using the incremental command, and you do not specify which file systems to process.
- When your IBM Spectrum Protect™ administrator defines a schedule to run an incremental backup for you, but does not specify which file systems to process.
- When you select the Backup Domain action from the backup-archive client GUI

**Windows** The backup-archive client uses the domain value in the following situations to determine which drives to process during an incremental backup:

- When you run an incremental backup by using the incremental command, and you do not specify which drives to process.
- When your IBM Spectrum Protect administrator defines a schedule to run an incremental backup for you, but does not specify which drives to process.
- When you select the Backup Domain action from the backup-archive client GUI

You can define the domain option in the following locations:

- In an options file.
- On the command line, when entered with a client command.
- In a client option set, which is defined on the server with the `define clientopt` command.
- As an option on a scheduled command, which is defined on the server with the `define schedule` command.

If any of these sources contain a domain definition, the client backs up that domain. If more than one source specifies a domain, the client backs up all specified domains. The same domain object can be defined more than once, but the effect is the same as defining it only once. If you do not specify a domain, the client backs up the default domain, as described in the `all-local` parameter.

You can exclude objects from the domain by specifying the exclusion operator (-) before the object. If any domain definition excludes an object, that object is excluded from the domain, even if another definition includes the object. You cannot use the domain exclusion operator (-) in front of any domain keyword that begins with `all-`.

If a domain statement excludes one or more objects and no domain statement includes any objects, the result is an empty domain (nothing is backed up). You must specify the objects to include in the domain if any domain statements exclude objects.

**AIX | Linux | Mac OS X | Solaris** Example 1: This example uses one domain statement to back up all local file systems except for `/fs1`:

```
domain all-local -/fs1
```

Example 2: This example uses multiple domain statements to back up all local file systems except for `/fs1`:

```
domain all-local domain -/fs1
```

Example 3: This example excludes `/fs1` during a backup operation. If no other domain statement is used, the result is an empty domain. Nothing is backed up.

```
domain -/fs1
```

**Windows** Example 1: This example uses one domain statement to back up all local file systems except for the system state:

```
domain all-local -systemstate
```

Example 2: This example uses multiple domain statements to back up all local file systems except for the system state:

```
domain all-local domain -systemstate
```

Example 3: This example excludes the system state from a backup operation. If no other domain statement is used, the result is an empty domain. Nothing is backed up.

```
domain -systemstate
```

If you start the incremental command with a file specification, the client ignores any domain definitions and backs up only the file specification.

**AIX | Linux | Mac OS X | Solaris** You can include a virtual mount point in your client domain.

**AIX | Linux** Important: If you are running GPFS™ for AIX® or GPFS for Linux x86\_64 in a multinode cluster, and all nodes share a mounted GPFS file system, the client processes this file system as a local file system. The client backs up the file system on each node during an incremental backup. To avoid this situation, you can do one of the following tasks:

- Explicitly configure the domain statement in the client user options file (`dsm.opt`) to list the file systems you want that node to back up.
- **AIX | Linux** Set the `exclude.fs` option in the client system-options file to exclude the GPFS file system from backup services.

**AIX | Linux | Mac OS X | Solaris**

## Automounted file systems

When you perform a backup with the domain option set to all-local, files that are handled by automounter and loopback file systems are not backed up.

If you back up a file system with the domain option set to all-local, any subdirectories that are mount points for an automounted file system (AutoFS) are excluded from a backup operation. Any files that exist on the server for the automounted subdirectory are expired.

When you perform a backup with the domain option set to all-lofs, all explicit loopback file systems (LOFS) are backed up and all automounted file systems are excluded. For loop devices and local file systems that are handled by automounter, set the domain option to all-auto-lofs.

Use the automount option with the domain parameters, all-auto-nfs, and all-auto-lofs to specify one or more automounted file systems to be mounted and added into the domain. If you specify the automount option, automounted file systems are remounted if they go offline during the execution of the incremental command.

Virtual mount points cannot be used with automounted file systems.

**AIX** **Linux** **Mac OS X** **Solaris**

**Linux** Important: On some Linux distributions, automounted file system mount points or maps of file system type (AutoFS) might not be listed in the current mount table. As a result, the automounted files systems, which are unmounted during backup or archive processing, might be incorrectly processed and stored as part of a wrong domain (for example, as part of domain all-local, all-nfs, or all-lofs, depending on the actual file system type). Therefore, in such Linux distribution environments, you must specify the appropriate automount option setting to correctly process your domain option setting at all points in time.

**Mac OS X** For Mac OS X, automounted file systems are not supported. If an automounted file system is part of a domain statement, the backup fails and no files in the automounted file system are processed. Back up and restore the automounted file system from the host system. Do not back up or restore the automounted file system over a network connection.

## Supported Clients

This option is valid for all clients. The server can also define this option. The IBM Spectrum Protect API does not support this option.

## Options File

**Windows** Place this option in the options file, dsm.opt. You can set this option on the Backup tab, Domain for Backup section of the Preferences editor.

**Mac OS X** **AIX** **Linux** **Solaris** **Mac OS X** Place this option in the options file, dsm.opt or dsm.sys. In the dsm.sys file, you must place this option within a server stanza. You can set this option on the Backup tab, Domain for Backup section of the Preferences editor.

**AIX** **Linux** **Mac OS X** **Solaris**

## Syntax

```
.-----  
v .-all-local----- |  
>>-DOMain-----+-----+-----><  
+-domain-----+  
+- -domain-----+  
+-all-lofs-----+  
+-all-nfs-----+  
+-all-auto-nfs--+  
'-all-auto-lofs-'
```

**Windows**

## Syntax

```
.-----  
v .-all-local----- |  
>>-DOMain-----+-----+-----><  
+-object-----+
```

```
+- -object-----+
+-systemstate----+
'- -systemstate-'
```

## Parameters

all-local

**Windows**

Back up all local volumes on the system, and the Windows system state. This is the default setting. Local volumes are defined as volumes that are formatted with a supported file system (ReFS, NTFS, FAT32, or FAT) on a direct-attached storage device, including SAN and iSCSI attached storage. Directories that are mapped to drive letters by using the Windows subst command are included in a backup if the mapped directory is on a local disk.

**Windows**

The following types of volumes are not included when all-local is specified:

- Network attached volumes, including CIFS shares that are mapped to drive letters.
- Removable volumes, including CD/DVD drives, USB thumb drives, and floppy diskette drives. Some USB-attached hard disks are included in the all-local domain if Windows does not classify them as a removable storage device.

**AIX**

**Linux**

**Mac OS X**

**Solaris**

Backs up all local file systems except LOFS file systems and LOFS through automounter. This parameter is the default. The /tmp directory is not included.

**AIX**

**Linux**

**Mac OS X**

**Solaris**

*domain*

**AIX**

**Linux**

**Mac OS X**

**Solaris**

Defines the file systems to include in your default client domain.

When you use *domain* with the incremental command, it processes these file systems in addition to those file systems you specify in your default client domain.

**AIX**

**Linux**

**Mac OS X**

**Solaris**

*-domain*

**AIX**

**Linux**

**Mac OS X**

**Solaris**

Defines the file systems to exclude in your default client domain.

**AIX**

**Linux**

**Solaris**

*all-lofs*

**AIX**

**Linux**

**Solaris**

Backs up all loopback file systems, except those file systems that are handled by automounter. This parameter is not supported on Mac OS X.

**AIX**

**Linux**

**Solaris**

*all-nfs*

**AIX**

**Linux**

**Solaris**

Backs up all network file systems, except those file systems that are handled by automounter. This parameter is not supported on Mac OS X.

**AIX**

**Linux**

**Solaris**

*all-auto-nfs*

**AIX**

**Linux**

**Solaris**

Backs up all network file systems (but not local file systems) which are handled by automounter. This parameter is not supported on Mac OS X.

**AIX**

**Linux**

**Solaris**

*all-auto-lofs*

**AIX**

**Linux**

**Solaris**

Backs up all loop devices and local file systems that are handled through automounter. This parameter is not supported on Mac OS X.

object

Specifies the domain objects to include in the domain.

An object name must be enclosed in quotation marks if the name includes any spaces.

-object

Specifies the domain objects to exclude from the domain.

An object name must be enclosed in quotation marks if the name includes any spaces.

**Windows**

*systemstate*

**Windows**

Back up the Windows system state. The systemstate domain is included in the all-local domain.

**Windows**

*-systemstate*

**Windows**

Exclude system state from backup processing.

## Examples

Options file:

An options file can contain more than one domain statement. However, each of the domain statements is an example of a single statement in an options file.

**Mac OS X**

```
domain all-local
domain all-local -/Volumes/volume2
domain all-local '-/Volumes/Macintosh HD'
```

**AIX** | **Linux** | **Solaris**

```
domain /tst /datasave /joe
"domain all-local"
domain ALL-LOCAL -/home
domain ALL-NFS -/mount/nfs1
```

**Windows**

```
domain c: d: e:
domain c: systemstate
domain ALL-LOCAL -systemstate
domain ALL-LOCAL -c:
domain ALL-LOCAL -\\florence\e$
```

A single domain statement can list one or more objects for the domain. You can use more than one domain statement. The following two examples from two options files yield the same domain result:

Example 1

```
...
domain fs1
domain all-local
domain -fs3
...
```

Example 2

```
...
domain all-local fs1 -fs3
...
```

Command line:

**Mac OS X**

```
-domain="/ /Volumes/volume2"
-domain="all-local -/Volumes/volume2"
```

**AIX** | **Linux** | **Mac OS X** | **Solaris**

```
-domain="/fs1 /fs2"
-domain=/tmp
-domain="ALL-LOCAL -/home"
```

**Windows**

```
-domain="c: d:"
-domain="ALL-LOCAL -c: -systemstate"
```

## Domain definition interaction

**AIX** | **Linux** | **Mac OS X** | **Solaris**

Domain can be defined in several sources, and the result is a summation of all domain definitions. As an example of the interaction of domain definitions, consider how domain definitions from several sources yield different backup results. In the table, *FS* followed by a number (for example, FS1) is a file system. This table shows only commands that are entered on the command line. For scheduled commands, the command-line column is not relevant, and options from the scheduled command must be considered.

**Windows**

Domain can be defined in several sources, and the result is a summation of all domain definitions. As an example of the interaction of domain definitions, consider how domain definitions from several sources yield different backup results. In the table, *FS* followed by a number (for example, FS1) is a drive. This table shows only commands that are entered on the command line. For scheduled commands, the command-line column is not relevant, and options from the scheduled command must be considered.

Table 1. Interaction of domain definitions from several sources

Options file	Command line	Client option set	Objects backed up using the incremental command
domain FS1	incremental -domain=FS2	domain FS3	FS1 FS2 FS3

Options file	Command line	Client option set	Objects backed up using the incremental command
domain FS1	incremental	domain FS3	FS1 FS3
	incremental -domain=FS2		FS2
	incremental -domain=FS2	domain FS3	FS2 FS3
	incremental	domain FS3	FS3
	incremental		all-local
domain all-local	incremental	domain FS3	all-local + FS3
domain all-local domain -FS1	incremental		all-local, but not FS1
domain -FS1	incremental		none
domain FS1 FS3	incremental	domain -FS3	FS1
domain all-local	incremental	domain -FS3	all-local, but not FS3
	incremental FS1 - domain=all-local		FS1
	incremental FS1	domain all-local	FS1
domain -FS1	incremental FS1		FS1

AIX Linux Solaris Windows

## Domain.image

The domain.image option specifies what you want to include in your client domain for an image backup.

**Windows** Raw logical volumes must be named explicitly.

If you do not specify a file system with the backup image command, the file systems you specify with the domain.image option are backed up.

When you specify a file system with the backup image command, the domain.image option is ignored.

If you do not use the domain.image option to specify file systems in your client options file, and you do not specify a file system with the backup image command, a message is issued and no backup occurs.

## Supported Clients

**AIX Linux Solaris** This option is valid for AIX®, Linux x86\_64, Linux on POWER®, and Solaris. The server can also define this option. The IBM Spectrum Protect™ API does not support this option.

This option is valid for all supported Windows clients. The server can also define this option. The IBM Spectrum Protect API does not support this option.

## Options File

**AIX Linux Solaris** Place this option in the client system-options file (dsm.sys) within a server stanza. You can set this option in the Backup > Domain for Backup box in the Preferences editor.

**Windows** Place this option in the client options file (dsm.opt). You can set this option in the Backup > Domain for Backup box in the Preferences editor.

## Syntax

```

      .- - - - - .
      |           |
>>-DOMAIN.IMAGE-+-----+----->>
                  '-domain-'

```

## Parameters

---

domain

Defines the file systems or raw logical volumes to include in your default client image domain.

## Examples

---

**AIX** | **Linux** | **Solaris** Options file:  
domain.image /fs1 /fs2

**Windows** Options file:  
domain.image d: e: f: domain.image f:\mnt\raw\rawmnt1 f:\mnt\fs\fsmnt1

Command line:  
Does not apply.

**AIX** | **Solaris** | **Windows**

## Domain.nas

---

The domain.nas option specifies the volumes to include in your NAS image backups.

You can specify all-nas to include all the mounted file systems on the NAS file server, except those you exclude with the exclude.fs.nas option.

The backup-archive client uses your domain for NAS image backups when you run a backup nas command and you do not specify which volumes to process.

**AIX** | **Solaris** When you use this option in your client system options file (dsm.sys), the domain.nas option defines your default domain for NAS image backups. When you perform a NAS file system image backup using the backup nas command, the client adds the volumes that you specify on the command line to the volumes defined in your dsm.sys file. For example, if you enter domain.nas nas1/vol/vol0 nas1/vol/vol1 in your dsm.sys file and you enter dsmc backup nas - nasnodename=nas1 /vol/vol2 on the command line, the client backs up the vol/vol0, vol/vol1, and vol/vol2 volumes on node nas1.

**AIX** | **Solaris** If you set the domain.nas option to all-nas in the dsm.opt file, the client backs up all mounted volumes on the NAS file server. When performing a backup, if you use a file specification and set the domain.nas option to all-nas in the dsm.sys file, all-nas takes precedence.

**Windows** When you use this option in your client system options file (dsm.opt), the domain.nas option defines your default domain for NAS image backups.

**Windows** When you perform a NAS file system image backup using the backup nas command, the client adds volumes that you specify on the command line to the volumes defined in your dsm.opt file. For example, if you enter domain.nas nas1/vol/vol0 nas1/vol/vol1 in your dsm.opt file and you enter dsmc backup nas -nasnodename=nas1 /vol/vol2 on the command line, the client backs up the vol/vol0, vol/vol1, and vol/vol2 volumes on node nas1.

**Windows** If you set the domain.nas option to all-nas in the dsm.opt file, the client backs up all mounted volumes on the NAS file server. When performing a backup, if you use a file specification and set the domain.nas option to all-nas in the dsm.opt file, all-nas takes precedence.

## Supported Clients

---

**AIX** | **Solaris** This option is only valid for AIX® and Solaris clients. The server can also define this option.

**Windows** This option is valid for all Windows clients. The server can also define this option.

## Options File

---

**AIX** | **Solaris** Place this option in the client system-options file (dsm.sys) within a server stanza.

**Windows** Place this option in the client options file (dsm.opt).

## Syntax

---



```

      .- ----- .
      V .-all-nas- . |
>>-DOMAIN.Nas-----+-----+-----+----->>
      '-domain--'

```

## Parameters

---

### domain

Defines the volumes you want to process. You cannot exclude volumes by specifying the dash (-) operator.

### all-nas

Processes all mounted volumes on the NAS file server, except those you exclude with the `exclude.fs.nas` option. This is the default. If there is no `domain.nas` statement in the `dsm.opt` file and no volumes specified on the command line, the client backs up all mounted volumes on the NAS server.

## Examples

---

### Options file:

```

domain.nas nas1/vol/vol0 nas1/vol/vol1
domain.nas all-nas

```

### Command line:

Does not apply.

Linux | Windows

## Domain.vmfull

---

The `domain.vmfull` option specifies the virtual machines (VMs) to include in your full virtual machine image backup operations.

 This feature is available only if the client operates as a data mover for IBM Spectrum Protect™ for Virtual Environments.

This option applies to both VMware and Microsoft Hyper-V virtual machine disks.

Linux | Windows

## Domain.vmfull for VMware virtual machines

---

For VMware virtual machine backups, the `domain.vmfull` option works with the `vmchost` option. The `vmchost` option identifies the vCenter server or ESX server that contains the virtual machines that you want to protect. The `domain.vmfull` parameters are used to narrow the focus of an operation to a subset of the virtual machines that are running on the system that is identified by `vmchost`.

You can specify which virtual machines are to be processed by using any of the following techniques:

- Use the `VM=` option and specify the name of a virtual machine.
- Provide a comma-separated list of virtual machine names.
- Use wildcard syntax to process virtual machines that match the name pattern.
- Use one of the following domain-level parameters:
  - `all-vm`
  - `all-windows`
  - `schedule-tag`
  - `vmhost`
  - `vmfolder`
  - `vmhostcluster`
  - `vmdatastore`
  - `vmresourcepool`
  - `vmhostfolder`
  - `vmdatacenter`

When you use domain-level parameters, virtual machines that are created in the domain are automatically included when the next backup occurs. For example, if you use the `vmfolder` parameter to back up all virtual machines included in a folder, any new virtual

machines that get added to that folder are included in the next backup. The same is true of pattern-matched names that are included in a wildcard match.

The virtual machines that are specified on the `domain.vmfull` option are processed only when the `backup vm` command is entered without specifying a virtual machine or a list of virtual machines on the command line.

## Supported Clients

**Linux** This option can be used with supported x86\_64 Linux clients.

**Windows** This option can be used with supported Windows clients.

The server can also define this option.

## Options file

Set this option in the client options, by using the command line, or by using the VM Backup tab of the Preferences editor.

Restriction: The following parameters cannot be set in the Preferences Editor. Include this setting in the options file, or on the command line when you run a `backup vm` command:

- `vmname:vmdk=vmdk_label`
- `schedule-tag`
- `vmresourcepool`
- `vmhostfolder`
- `vmdatacenter`

## Syntax for VMware virtual machines

```
.-;-----  
V .-vmname1, vmname2----- . |  
>>-DOMAIN.VMFull-----+>>  
+-VM=vmname1, vmname2-----+  
+- -VM=vmname1, vmname2-----+  
+-ALL-VM-----+  
+-ALL-WINDOWS-----+  
+-SCHEDULE-TAG-----+  
+-VMHost=srv1, srv2-----+  
+-VMFolder=foldername1, foldername2-----+  
+-VMHOSTCLUSTER=cluster1, cluster2-----+  
+-VMDATASTORE=datastore1, datastore2-----+  
+-VMRESOURCEPOOL=resourcepool1, resourcepool2-+  
+-VMHOSTFOLDER=hostfolder1, hostfolder2-----+  
'-VMDATACENTER=datacenter1, datacenter2-----'
```

Syntax rules: Multiple keywords must be separated by a semicolon. Do not include any spaces after the semicolons. Multiple virtual machine or domain names must be separated by commas, with no space characters. For examples, see `vm=vmname`. The rule about multiple virtual machine or domain names does not apply if you are using the "Schedule-Tag" keyword.

## Parameters

### *vmname*

Specifies the virtual machine name that you want to process. The name is the virtual machine display name. You can specify a list of virtual machine host names by separating the names with commas (`vm1, vm2, vm5`).

### *vm=vmname*

The `vm=` keyword specifies that the next set of values is a list of virtual machine names. The `vm=` keyword is the default and is not required.

In this example, `vm=` is not specified and commas are used to separate the machine names.

```
domain.vmfull my_vm1,my_vm2
```

If you specify multiple keywords, such as `vm=` and `vmfolder=`, the values that the keywords refer to must be separated by semicolons, with no intervening space characters:

```
domain.vmfull vm=my_vm1;vm=my_vm2  
domain.vmfull vm=my_vm1;vmfolder=folder1;vmfolder=folder2
```

Wildcard characters can be used to select virtual machine names that match a pattern. An asterisk (\*) matches any sequence of characters. A question mark (?) matches any single character, for example:

- Exclude all files that have "test" in the host name: `-vm=*test*`
- Include all virtual machines with names such as: "test20", "test25", "test29", "test2A": `vm=test2?`

You can exclude a virtual machine from a backup operation by specifying the exclude operator (-) before the `vm=` keyword. For example, `-vm` is used to exclude a particular machine, or machines, from a domain level backup, such as, ALL-Windows, ALL-VM, and VMFolder. If "vm1" is the name of a virtual machine in a folder that is named "accountingDept", you can back up all of the virtual machines in the folder, but prevent the virtual machine "vm1" from being backed up. Set the following option:

```
domain.vmfull VMFolder=accountingDept;-vm=vm1
```

You cannot use the exclude operator (-) to exclude a domain, such as ALL-VM, ALL-Windows, or VMFolder. The exclude operator works only at the virtual machine name level.

*vmname:vmdk=vmdk\_label*

The `:vmdk=` keyword applies only to VMware virtual machines and its use requires a license for IBM Spectrum Protect for Virtual Environments: Data Protection for VMware.

This option is typically used to exclude disks (see the `:-vmdk` syntax) from being backed up. You can also include virtual machine disks by using the `INCLUDE.VMDISK` option or exclude virtual machine disks by using the `EXCLUDE.VMDISK` option.

The virtual disks within a virtual machine have disk labels that uniquely identify each virtual disk. You use the `:vmdk=` keyword to specify the labels of the virtual disks that you want to be included in a Backup VM operation. If you do not specify `:vmdk=` and a disk label, all virtual disks in the virtual machine are backed up.

Assume that there is a virtual machine named "my\_vm\_example". This virtual machine has four disks (labeled `Hard Disk 1`, `Hard Disk 2`, `Hard Disk 3`, `Hard Disk 4`). To include only `Hard Disk 2` and `Hard Disk 3` in a backup, add the `:vmdk=` keyword and disk label for those disks. Quotation marks are necessary around the parameters because the disk labels contain space characters. For example:

```
domain.vmfull "my_vm_example:vmdk=Hard Disk 2:vmdk=Hard Disk 3"
```

This next example backs up `Hard Disk 1` and `Hard Disk 2` on `VM1`, and `Hard Disk 3` and `Hard Disk 4` on `VM2`. A comma is used to separate the virtual machine information.

```
domain.vmfull "vm1:vmdk=Hard Disk 1:vmdk=Hard Disk 2",  
"vm2:vmdk=Hard Disk 3:vmdk=Hard Disk 4"
```

Similar to the `-vm=` keyword, you can also use the exclusion operator (-) with `:vmdk=` to exclude disks from a backup operation.

To back up a virtual machine (`vm1`) and exclude disks 3 and 4, use the following syntax:

```
domain.vmfull "vm1:-vmdk=Hard Disk 3:-vmdk=Hard Disk 4"
```

To back up two virtual machines, `vm1` and `vm2`, and exclude the first two disks on each machine, use the following syntax:

```
domain.vmfull "vm1 :-vmdk=Hard Disk 1:-vmdk=Hard Disk 2",  
"vm2:-vmdk=Hard Disk 1:-vmdk=Hard Disk 2"
```

You can include one or more disks on a `domain.vmfull` statement. You can exclude one or more disks on a `domain.vmfull` statement. You can mix include and exclude disks on the same statement. For example, the following statement is valid:

```
domain.vmfull  
"vm1:vmdk=Hard Disk 1:-vmdk=Hard Disk 2:vmdk=Hard Disk 3:vmdk:Hard Disk 4"
```

If an include statement is present, all other disks in the virtual machine are excluded from a backup operation, unless the other disks are also specified in an include statement. For example, the following statement excludes all hard disks on `vm1`, except for `Hard Disk 1`:

```
domain.vmfull "vm1:vmdk=Hard Disk 1"
```

Both of the following exclude `Hard Disk 4` from a backup of `vm1`:

```
domain.vmfull "vm1:vmdk=Hard Disk 1:vmdk=Hard Disk 2:vmdk=Hard Disk 3"  
domain.vmfull "vm1:-vmdk=Hard Disk 4"
```

#### all-vm

For VMware virtual machines. This option processes all virtual machines that are defined to the Virtual Center or to the ESX server that is specified on the `vmchost` option.

#### all-windows

For VMware virtual machines. This option processes all virtual machines that are defined to the Virtual Center or to the ESX server that is specified on the `vmchost` option. The virtual machines must also have a guest operating system type of Windows.

#### schedule-tag

For scheduled backups of VMware virtual machines. This option processes all virtual machines that are defined to the Virtual Center server that is specified on the `vmchost` option.

The IBM Spectrum Protect server administrator can add this option to a schedule definition to indicate that the schedule is compatible with the `Schedule (IBM Spectrum Protect)` category and tag. Virtual machines in VMware objects that are assigned with the `Schedule` tag are backed up according to the schedule.

Requirement: To be compatible for tagging, the `-domain.vmfull` option must contain no additional domain-level parameters other than the `Schedule-Tag` parameter in the schedule definition. Otherwise, the `Schedule (IBM Spectrum Protect)` tag is ignored. The option is case insensitive and must contain no spaces. Quotation marks that enclose the `Schedule-Tag` parameter are optional. Virtual machines in VMware containers that are tagged with incompatible schedules are not backed up.

For more information about the `Schedule` tag, see "Supported data protection tags."

#### vmhost=*hostname*

For VMware virtual machines. This option processes all virtual machines that are defined to the Virtual Center or to the ESX server that is specified on the `vmchost` option. The host name that you specify must match the fully qualified host name or IP address, as it is specified in the vCenter server Hosts and Clusters view.

All virtual machines that are added to this host are automatically included in backup and restore processing. To be included, the virtual machines must also be running on the ESX server that is specified by the host name; they cannot be powered off.

This parameter can include multiple ESX servers that are separated by commas. When the Virtual Center contains multiple ESX servers, this option does not determine the ESX server from which a snapshot is taken. The ESX server from which a snapshot is taken is determined by the VMware VirtualCenter web service.

When you connect directly to an ESXi or ESX host, the `vmchost` option applies only if the `vmhost` is the server that you connect to. If it is not, a warning level message is sent to the console and is recorded in the `dsmerror.log` file; it is also recorded as a server event message.

If the `vmenabletemplatebackups` option is set to yes, and VM templates are part of the domain, they are included in the backup.

Restriction: VMware templates for virtual machines cannot be backed up when they are in an ESX or ESXi host because ESX and ESXi hosts do not support templates.

#### vmfolder=*foldername*

For VMware virtual machines. This option processes all virtual machines that are defined to the Virtual Center or to the ESX server that is specified on the `vmchost` option. The virtual machines must also exist in the VMware folder that is specified by the folder name. Folder name can include multiple VMware folders that are separated by commas.

#### vmhostcluster=*hostclustername*

For VMware virtual machines. This option processes all virtual machines that are defined to the Virtual Center or to the ESX server that is specified on the `vmchost` option. The virtual machines must also be running on the ESX host cluster that is specified by the host cluster name. To include more than one host cluster name, separate the cluster names with commas:  
`VMHOSTCLUSTER=cluster1,cluster2`.

If the `vmenabletemplatebackups` option is set to yes, and VM templates are part of the domain, they are included in the backup. A VMware host cluster is not available if you connect directly to an ESXi or ESX host. If you connect directly to an ESXi/ESX host and a domain is processed that includes a host cluster, a warning level message is sent to the console and is recorded in the `dsmerror.log` file; it is also recorded as a server event message.

#### vmdatastore=*datastorename*

For VMware virtual machines. This option processes all virtual machines that are defined to the Virtual Center or to the ESX server that is specified on the `vmchost` option. The configured datastore location for a virtual machine must match the datastore name that is specified by `datastorename`. The datastore name can include multiple datastores that are separated by commas: `VMDATASTORE=datastore1,datastore2`

Virtual machines can have their disk (vmdk files) on more than one datastore; but there is only one default datastore location. This default datastore location is defined in the virtual machine configuration and is always where the virtual machine configuration file (.vmx file) is located. When a machine is selected for backup by using a domain keyword, the virtual machine configuration file, and all of the virtual machine's disks are included in the backup, including the disks that are on a different datastore than the one specified as the domain.

`vmresourcepool=resourcepoolname`

For VMware virtual machines. This option processes all virtual machines that are defined to the Virtual Center server that is specified on the `vmchost` option. The virtual machines must also exist in the VMware resource pool that is specified by the resource pool name. The resource pool name can include multiple resource pools that are separated by commas, for example: `VMRESOURCEPOOL=resourcepool1,resourcepool2`

`vmhostfolder=hostfoldername`

For VMware virtual machines. This option processes all virtual machines that are defined to the Virtual Center server that is specified on the `vmchost` option. The virtual machines must also exist in the VMware host folder that is specified by the host folder name. The host folder name can include multiple VMware host folders that are separated by commas, for example: `VMHOSTFOLDER=hostfolder1,hostfolder2`

`vmdatacenter=datacentername`

For VMware virtual machines. This option processes all virtual machines that are defined to the Virtual Center server that is specified on the `vmchost` option. The virtual machines must also exist in the VMware datacenter that is specified by the datacenter name. The datacenter name can include multiple datacenters that are separated by commas, for example: `VMDATACENTER=datacenter1,datacenter2`

**Tip:** If you specify more than one container type, for example, `vmfolder=folder1` and `vmhostcluster=cluster2`, all virtual machines that are contained in `folder1` and `cluster2` are protected. The virtual machines do not have to be in both `folder1` and `cluster2`.

You can specify the virtual machines as shown in this example:

```
domain.vmfull=vmfolder=folder1;vmhostcluster=cluster2
```

## Examples for VMware virtual machines

---

Options file:

Include all virtual machines in full VM backup operations.

```
domain.vmfull all-vm
```

Include all virtual machines in full VM backup operations, except for the ones that have a name suffix of `_test`.

```
domain.vmfull all-vm;-vm=*_test
```

Include all virtual machines that have Windows as the operating system, in full VM backup operations.

```
domain.vmfull all-windows
```

Include all virtual machines in cluster servers 1, 2, and 3 in full VM backup operations.

```
domain.vmfull vmhostcluster=cluster1,cluster2,cluster3
```

Include all virtual machine data in `datastore1` in full VM backup operations.

```
domain.vmfull vmdatastore=datastore1
```

Include all virtual machines in full VM backup operations, but exclude virtual machines `testvm1` and `testvm2`.

```
domain.vmfull all-vm;-VM=testvm1,testvm2
```

Include the virtual machines that are defined in the VM folders that are named `lab1` and `lab2` in full VM backup operations.

```
domain.vmfull vmfolder=lab1,lab2
```

Include all virtual machines on the ESX hosts named "brovar", "doomzoo", and "kepler" in full VM backup operations.

```
domain.vmfull vmhost=brovar.example.com,  
doomzoo.example.com,kepler.example.com
```

Include the virtual machines in VMware resource pools `resourcepool_A` and `resourcepool_B` in full VM backup operations.

```
domain.vmfull vmresourcepool=resourcepool_A,resourcepool_B
```

Include the virtual machines that are defined in the VMware host folders named `hostfolder1` and `hostfolder2` in full VM backup operations.

```
domain.vmfull vmhostfolder=hostfolder1,hostfolder2
```

Include all virtual machines in VMware datacenter `dc1` in full VM backup operations.

```
domain.vmfull vmdatacenter=dc1
```

### Windows

## Domain.vmfull for Microsoft Hyper-V virtual machines

For Hyper-V VM backups, use the `domain.vmfull` option to specify which Hyper-V VMs are processed when you run a backup `vm` command, without specifying any Hyper-V VM names.

You can specify which VMs to process by using any of the following techniques:

- Use the `VM=` option and specify the name of a virtual machine.
- Provide a comma-separated list of virtual machine names.
- Use wildcard syntax to process virtual machines that match the name pattern.
- Use the `vmname:vhdX=` option to specify the VM hard disk (VHDX) to include or exclude during the Hyper-V RCT backup operation of a VM.
- Use the all-vm domain-level parameter. You can also include one or more virtual machines by using the `VM=` keyword, or exclude VMs by using the `-VM=` syntax.

The virtual machines that are specified on the `domain.vmfull` option are processed only when the backup `vm` command is entered without specifying a virtual machine or a list of virtual machines on the command line.

Attention: For Microsoft Hyper-V operations, the only valid domain-level parameter for the `domain.vmfull` option is `all-vm`. You can also include one or more virtual machines by using the `VM=` keyword, or exclude virtual machines by using the `-VM=` syntax.

## Supported Clients

This option can be used with supported Windows clients. This option can also be defined on the server.

## Options file

Set this option in the client options, by using the command line, or by using the VM Backup tab of the Preferences editor.

Restriction: The `vmname:vhdX=vhdX_location` parameter cannot be set in the Preferences Editor. Include this setting in the options file, or on the command line when you run a backup `vm` command:

## Syntax for Microsoft Hyper-V virtual machines

```
.-;-----  
V .-vmname1,vmname2----- |  
>>-DOMAIN.VMFull-----+----->>  
+-VM=vmname1,vmname2-----+  
+- -VM=vmname1,vmname2-----+  
+-vmname:vhdX=disk_location---+  
+- -vmname:vhdX=disk_location--+  
'-ALL-VM-----'
```

Syntax rules: Multiple keywords must be separated by a semicolon. There cannot be any spaces after the semicolons. Multiple machine or domain names must be separated by commas, with no space characters. For examples, see `vm=vmname`.

## Parameters

### *vmname*

Defines the virtual machine name that you want to process. You can supply a list of virtual machine host names by separating the names with commas (`vm1, VM2, vm5`). The names are case-sensitive and must match the capitalization that is shown on the Hyper-V host in the Hyper-V Manager > Virtual Machines view.

`vm=vmname`

The `vm=` keyword specifies that the next set of values is a list of virtual machine names. The `vm=` keyword is the default and is not required.

In this example, `vm=` is not specified and commas are used to separate the machine names.

```
domain.vmfull my_vm1,my_vm2
```

If you specify multiple keywords, such as `vm=` and `-vm=`, the values that the keywords refer to must be separated by semicolons, with no intervening space characters:

```
domain.vmfull vm=my_vm1;vm=my_vm2
domain.vmfull -vm=my_vm3;-vm=my_vm4
```

Wildcard characters can be used to select virtual machine names that match a pattern. An asterisk (\*) matches any sequence of characters. A question mark (?) matches any single character, for example:

- Exclude all files that have "test" in the host name: `-vm=*test*`
- Include all virtual machines with names such as: "test20", "test25", "test29", "test2A":

```
vm=test2?
```

You can exclude a virtual machine from a backup operation by specifying the exclude operator (-) before the `vm=` keyword. For example, `-vm` is used to exclude a particular machine, or machines, from a domain level backup, such as, ALL-VM. If "vm1" is the name of a virtual machine, you can back up all of the virtual machines in the domain, but prevent the virtual machine "vm1" from being backed up. Set the following option:

```
domain.vmfull all-vm;-vm=vm1
```

You cannot use the exclude operator (-) to exclude a domain, such as ALL-VM. The exclude operator works only at the virtual machine name level.

#### *vmname:vhd*x=vhd\_x\_location

This option specifies the location of the virtual machine hard disk (VHDX) to include in Hyper-V RCT virtual machine backup operations on the Windows Server 2016 operating system.

The *vmname* variable specifies the name of the virtual machine to back up. Wildcard characters can be used to select virtual machine names that match a pattern. An asterisk (\*) matches any sequence of characters. A question mark (?) matches any single character.

The *:vhd*x=*disk\_location* keyword specifies the location of the virtual machine disk to include in the backup operation. The disk location specified by the *disk\_location* variable must begin with "SCSI" or "IDE" followed by the controller number and device location number. For example:

```
domain.vmfull "vm1:VHDX=IDE 1 0"
domain.vmfull "vm*:VHDX=SCSI 0 1"
domain.vmfull "vm?:VHDX=SCSI 0 1"
```

You can exclude a virtual machine disk from backup operations by specifying the exclude operator (-) before the *vhd*x= keyword. For example, use `-vhd`x= to exclude a VM disk from the backup operation of a virtual machine. For example:

```
domain.vmfull "vm1:-VHDX=IDE 1 0"
```

If you specify multiple virtual machine disks to include or exclude, the *vhd*x= or `-vhd`x= keyword and associated values must be separated by colons, with no intervening space characters. For example:

```
domain.vmfull "vm1:vhd
```

If you specify multiple virtual machine names and virtual machine disks, the VM name and associated values must be separated by semicolons, with no intervening space characters. For example:

```
domain.vmfull "vm1:VHDX=IDE 1 0:VHDX=SCSI 0 1;vm2:VHDX=IDE 1 0:VHDX=SCSI 0 1"
domain.vmfull "vm1:-VHDX=IDE 1 0:-VHDX=SCSI 0 1;vm2:-VHDX=IDE 1 0:-VHDX=SCSI 0 1"
```

#### all-vm

This option specifies that a backup `vm` operation processes all Hyper-V virtual machines that are known to the Hyper-V host.

## Examples for Microsoft Hyper-V virtual machines

---

#### Options file:

Include all virtual machines in full VM backup operations.

```
domain.vmfull all-vm
```

Include all virtual machines in full VM backup operations, except for the ones that have a name suffix of `_test`.

```
domain.vmfull all-vm;-vm=*_test
```

Include all virtual machines in full VM backup operations, but exclude virtual machines `testvm1` and `testvm2`.

```
domain.vmfull all-vm;-VM=testvm1,testvm2
```

Include IDE disks (with controller 1 and disk location 0) and SCSI disks (with controller 0 and disk location 1) in Hyper-V RCT backup operations of virtual machines `vm1` and `vm2`.

```
domain.vmfull "vm1:VHDX=IDE 1 0:VHDX=SCSI 0 1;vm2:VHDX=IDE 1 0:VHDX=SCSI 0 1"
```

Restriction: You cannot use the `all-vm` option together with the `vmname:-vhdX=` option in the options file or on the command line.

Linux

## Dontload

---

x86\_64 Linux clients can use the `dontload` option to suppress specific plug-in libraries from being loaded when the backup-archive client is started.

The `TIVsm_BAhdw.x86_64` package provided in Linux x86\_64 distributions contains software that is required to support snapshot incremental backups for NetAPP and N-Series file servers. When this package is installed on a Linux x86\_64 system that is used to perform data mover operations for a virtual machine, the files in this package cause all VMware backup operations to fail. When these failures occur, the following message is displayed:

```
ANS8811E
```

```
VMware operations cannot be run when the hardware plug-in product TIVsm-BAhdw is installed and loaded. Either uninstall the hardware product TIVsm-BAhdw, or set the option DONTLOAD PIHDW in the options file to prevent the hardware plug-in from being loaded.
```

Use this option to prevent the plug-in library from being loaded into RAM when the client is started. Alternatively, you can uninstall the `TIVsm_BAhdw` package if it is not needed for snapshot operations.

## Supported Clients

---

This option is only valid for Linux x86\_64 clients.

## Options File

---

Place this option in the client `system-options` file (`dsm.sys`) within a server stanza.

## Syntax

---

```
>>-DONTLoad----PIHDW-----><
```

## Parameters

---

PIHDW

Specifies that the hardware plug-in (`TIVsm-BAhdw`) is not loaded into RAM when the client is started. Use this option on backup-archive clients that have the hardware plug-in installed, to prevent the plug-in from causing failures when performing backup-archive operations on VMware virtual machines. There is no default for the `dontload` option. To determine whether the plug-in is installed, enter the following command and examine the output.

```
rpm -q -a | grep TIV
```

If the output contains a package starting with `"TIVsm-BAhdw"` (followed by a version string), the hardware plug-in package is installed.



## Examples

---

Options file:

```
DONTLoad PIHDW
```

Command line:

Does not apply. Do not use this option on the command line.

**Related reference:**

Backup VM

Restore VM

AIX

Linux

Solaris

## Dynamicimage

---

Use the `dynamicimage` option with the `backup image` command or the `include.image` option to specify that you want to perform a dynamic image backup.

## Supported Clients

---

This option is valid for AIX®, Solaris, and all Linux clients. The IBM Spectrum Protect™ API does not support this option.

## Options File

---

Place the `include.image` statement containing the `dynamicimage` value in the server stanza in your system-options file, `dsm.sys`. You can also set this option using the Preferences editor.

## Syntax

---

```
>>-DYNAMICImage-- --value-----<<
```

## Parameters

---

value

Specifies one of the following values:

yes

Use this option only if the volume cannot be unmounted and remounted as read-only. The client backs up the volume as is without remounting it as read-only. Corruption of the backup can occur if applications write to the volume while the backup is in progress. In this case, run `fsck` after a restore and manually mount the file system in order to regain access to the volume. This option is valid for AIX, Solaris, and all Linux clients.

Note: This option is not allowed for AIX JFS2 file systems.

no

Use this option if you do not want to perform a dynamic image backup. This is the default. The default behavior depends on the platform and file system type. For platforms and file systems that support snapshot, namely AIX JFS2 file systems and LINUX LVM file systems, the default is snapshot-based image backup. For all other UNIX platforms and file systems, the default is static image backup.

## Examples

---

Options file:

```
include.image /kalafsl dynamicimage=yes
```

Command line on backup image:

```
dynamicimage=yes
```

AIX

## Efsdecrypt

---

The `efsdecrypt` option allows you to control whether or not files encrypted by an AIX® Encrypted File System (EFS) are read in encrypted or decrypted format.

The `efsdecrypt` option default is `no`, which is to back up the encrypted or raw data. If you specify `yes`, the files are backed up as clear text, which means that they are backed up as normal files, as if the files existed in unencrypted form on the file system.

**Important:** Whenever you run a backup that includes any files encrypted on an EFS, you must ensure that you use the correct specification of the `efsdecrypt` option. If the `efsdecrypt` option value changes between two incremental backups, all encrypted files on EFS file systems are backed up again, even if they have not changed since the last backup. For example, if you are running an incremental backup of encrypted files that were previously backed up as "raw," then ensure that `efsdecrypt` is specified as `no`. If you change `efsdecrypt` to `yes`, all the files are backed up again in clear text even if they are unchanged, so ensure that you use this option carefully.

Note: This is a global option that is applied to the complete backup. Two separate invocations of the client are required to back up some encrypted files as raw data and others as clear text.

## Supported Clients

---

This option is valid for AIX clients.

## Options File

---

Place this option in the `dsm.sys` file or the client user-options file (`dsm.opt`). In the `dsm.sys` file, you must place this option within a server stanza.

## Syntax

---

```
..-No--.  
>>-EFSDecrypt--+-+-----+----->>  
                  '-Yes-'
```

## Parameters

---

- No  
Encrypted files are read in encrypted or raw data format, and IBM Spectrum Protect™ encryption and compression is forced off. This is the default.
- Yes  
Encrypted files are read in decrypted or clear text format.

## Examples

---

```
Options file:  
  EFSDecrypt yes  
Command line:  
  -EFSDecrypt=no
```

Windows

## Enable8dot3namesupport

---

The `enable8dot3namesupport` option specifies whether the client backs up and restores short 8.3 names for files that have long names on NTFS file systems.

## Supported Clients

---

This option is valid for all Windows clients.

A file with a long file name might not have a short 8.3 name if short name generation is disabled on the Windows system. This option is effective only for NTFS file systems.

## Options File

---

Place this option in the client options file (dsm.opt). You can set this option on the General tab of the Preferences editor.

## Syntax

---

```
>>-ENABLE8DOT3NAMESupport-----<<  
      .-No--.  
      '-Yes-'
```

## Parameters

---

No

Short 8.3 names for files with long file names are not backed up or restored. This is the default.

Yes

Short 8.3 names for files with long file names are backed up and restored.

Each short name uses up to 14 additional bytes in the server database. Although this is a small number, if there are many files with short 8.3 names on many Windows systems, this can increase the size of the IBM Spectrum Protect™ server database.

**Important:** Consult with your IBM Spectrum Protect server administrator before you use this option.

The first backup that runs with this option causes all files that have short 8.3 names to be updated on the IBM Spectrum Protect server, even if the files have not otherwise changed. This is because the client is adding the short 8.3 names to the active backup versions.

If this option is enabled for restore, the client attempts to set the short 8.3 name for restored files, even if short name generation is disabled on the Windows system. The client must run under a Windows account that possesses the SE\_RESTORE\_NAME privilege in order for this option to be effective. See your system administrator if you have questions about account privileges.

During restore, the short 8.3 name of a file is not restored if another object in the same directory already has the same short 8.3 name. In this case, the file is restored and an informational message is logged indicating that the short name could not be set. If the file must be restored with its original short name, you must resolve the conflict with the existing file, and then try the restore again.

**Important:** This parameter can cause unexpected results in some cases. For example, if the short name of a file changes between the last time the file was backed up and the time it is restored, and there is a link or registry entry that refers to the newer short name, then restoring the file with the older short name invalidates the references to the newer short name.

## Examples

---

Options file:

```
enable8dot3namesupport yes
```

Command line:

```
-enable8dot3namesupport=yes
```

## Enablearchiveretentionprotection

---

The enablearchiveretentionprotection option allows the client to connect to the IBM Spectrum Protect™ for Data Retention server. This ensures that archive objects will not be deleted from the server until policy-based retention requirements for that object have been satisfied.

This option is ignored if the client connects to a server that is not retention protection enabled. If the option is no (the default) and an attempt is made to connect to a data retention server, the connection is refused.

The data retention server is specially configured for this task, so normal backup or restore processing is rejected by the server. When the client is connected to a data retention server, the following commands will not be available. If you attempt to use these commands, a message is displayed indicating that they are not valid with this server.

- incremental
- backup (all subcommands)
- selective
- restore (all subcommands except restore backupset -location=file or -location=tape)

Note: restore backupset -location=file or -location=tape do not connect to any server (except the virtual one) and thus will not be blocked under any circumstances.

- restart restore
- delete backup
- delete group
- expire
- All queries *except*:
  - query access
  - query archive
  - query filespace
  - query inclexcl
  - query managementclass
  - query node
  - query options
  - query schedule
  - query session
  - query systeminfo
  - query tracestatus

## Supported Clients

---

This option is valid for all clients.

## Options File

---

**Windows** This option is valid only in client options file (dsm.opt) and is not valid in a client option set from the server. It is not valid on any command line.

**AIX | Linux | Solaris | Mac OS X** This option is valid only in the dsm.sys file *within* a server stanza and is not valid in a client option set from the server. It is not valid on any command line.

## Syntax

---

```
>>>-ENABLEARCHIVERETENTIONProtection-----<<<  
      .-No--.  
      '-Yes-'
```

## Parameters

---

- No  
The data retention server connection is refused. This is the default.
- Yes  
The client connects to a data retention server.

## Enablededupcache

---

Use the enablededupcache option to specify whether you want to use a cache during client-side data deduplication. Using a local cache can reduce network traffic between the IBM Spectrum Protect™ server and the client.

When you perform a backup or archive operation with the data deduplication cache enabled, the specification of data extents that are backed up or archived are saved to the cache database. The next time you run a backup or archive, the client queries the data deduplication cache and identifies the extents of data that have been previously saved to the server. Data extents that are identical to data extents on the server are not resent to the server.

If the server and the cache are not synchronized, the cache is removed and a new one is created.

Only one process can access the distributed data deduplication cache at a time. Concurrent backup instances on a workstation, that use the same server and storage pool, must either use unique node names or unique cache specifications. In this way, all the instances can use a local cache and optimize the client-side data deduplication.

## Supported Clients

---

This option is valid for all clients. The IBM Spectrum Protect API also supports this option.

## Options File

---

**AIX** | **Linux** | **Solaris** | **Mac OS X** Place this option in the system-options file (dsm.sys) within a server stanza. You can set this option on the Deduplication > Enable Deduplication Cache check box of the Preferences editor. The option can be set in the client option set on the IBM Spectrum Protect server.

**Windows** Place this option in the client options file (dsm.opt). You can set this option on the Deduplication > Enable Deduplication Cache check box of the Preferences editor. The option can be set in the client option set on the IBM Spectrum Protect server.

## Syntax

---

```
>>-ENABLEDEDUPCache--+-Yes*--
                        |-----|----->>
                        '-No---'
```

## Parameters

---

Yes

Specifies that you want to enable data deduplication cache. If data deduplication is not enabled, this setting is not valid. Yes is the default for the backup-archive client. No is the default for the IBM Spectrum Protect API.

No

Specifies that you do not want to enable data deduplication cache.

## Examples

---

Options file:

```
enablededupcache no
```

Command line:

```
-enablededupcache=no
```

This option is valid only on the initial command line. It is not valid in interactive mode.

**Related reference:**

Deduplication

Dedupcachepath

Dedupcachesize

## Enableinstrumentation

---

By default, instrumentation data is automatically collected by the backup-archive client and IBM Spectrum Protect™ API to identify performance bottlenecks during backup and restore processing. To disable or later enable instrumentation, use the enableinstrumentation option.

With this option enabled, you do not have to wait for a customer service representative to direct you to collect performance data when a problem occurs. Instead, the data can be collected whenever you run a backup or restore operation. This feature can be helpful because you do not have to re-create the problem just to collect performance data. The information is already collected by the client.

This option replaces the -TESTFLAG=instrument:detail, -TESTFLAG=instrument:API, and -TESTFLAG=instrument:detail/API options that are used in previous versions of the client and API.

For each process, the following types of performance instrumentation data are collected:

- The activity names for each thread (such as File I/O, Data Verb, Compression, and Transaction), the average elapsed time per activity, and the frequency of the activity.
- The total activity time of each thread.
- The command that was issued and the options that were used.

- The summary of the backup, restore, or query command.

By default, the performance data is stored in the instrumentation log file (dsminstr.log) in the directory that is specified by the DSM\_LOG environment variable (or the DSMI\_LOG environment variable for API-dependent products such as IBM Spectrum Protect for Databases: Data Protection for Microsoft SQL Server and IBM Spectrum Protect for Mail: Data Protection for Microsoft Exchange Server). If you did not set the DSM\_LOG environment variable, the instrumentation log file is stored in the current directory (the directory where you issued the dsmc command).

You can optionally change the name and location of the instrumentation log file by using the instrlogname option. You can also control the size of the log file by specifying the instrlogmax option.

Performance data is not collected for the backup-archive client GUI or web client GUI.

Performance data is collected for the following products when the enableinstrumentation option is specified in the client options file:

- Scheduled file-level backup operations with the backup-archive client
- IBM Spectrum Protect for Virtual Environments: Data Protection for VMware backups
- IBM Spectrum Protect for Virtual Environments: Data Protection for Microsoft Hyper-V backups
- IBM Spectrum Protect for Databases: Data Protection for Microsoft SQL Server backups
- IBM Spectrum Protect for Mail: Data Protection for Microsoft Exchange Server backups

Performance data is also collected during archive and retrieve processing.

## Supported Clients

---

This option is valid for all clients and the IBM Spectrum Protect API.

## Options File

---

**AIX** **Linux** **Solaris** **Mac OS X** Place this option in the client system-options file (dsm.sys) within a server stanza. The option can be set in the client option set on the IBM Spectrum Protect server.

**Windows** Place this option in the client options file (dsm.opt). The option can be set in the client option set on IBM Spectrum Protect server.

Tip: This option is enabled by default, so typically, you do not need to place this option in the client options file unless you need to disable the option.

## Syntax

---

```

>>-ENABLEINSTRUMENTATION--+-Yes-
                               |-----|
                               '-No--'

```

## Parameters

---

Yes

Specifies that you want to collect performance data during backup and restore operations. The default value is Yes, which means that performance data is collected even if you do not specify this option.

By default, the performance data is stored in the instrumentation log file (dsminstr.log) in the directory that is specified by the DSM\_LOG environment variable. If you did not set the DSM\_LOG environment variable, the instrumentation log file is stored in the current directory (the directory where you issued the dsmc command). If the file does not exist, the client creates the file and adds performance data to the file.

No

Specifies that you do not want to collect performance data during backup and restore operations. If the instrumentation log exists, no more data is added to the file.

## Examples

---

Options file:

```
enableinstrumentation yes
```

Command line:

**AIX** | **Linux** | **Mac OS X** | **Solaris**

```
dsmc sel /home/mydir/* -subdir=yes -enableinstrumentation=yes
```

**Windows**

```
dsmc sel c:\mydir\* -subdir=yes -enableinstrumentation=yes
```

This option is valid only on the initial command line. It is not valid in interactive mode.

**Related tasks:**

Collecting client instrumentation data

Collecting API instrumentation data

**Related reference:**

Instrlogmax

Instrlogname

**AIX** | **Linux** | **Solaris** | **Windows**

## Enablelanfree

---

The enablelanfree option specifies whether to enable an available LAN-free path to a storage area network (SAN) attached storage device.

A LAN-free path allows backup, restore, archive, and retrieve processing between the backup-archive client and the SAN-attached storage device.

To support LAN-free data movement you must install and configure the IBM Spectrum Protect™ for SAN storage agent on the client workstation.

Note:

1. If you place the enablelanfree option in the client option file (dsm.opt), but zero (0) bytes were transferred through the SAN during an operation, ensure that you bind the data to a LAN-free enabled management class.
2. To restore backup sets in a SAN environment, see for more information.
3. When a LAN-free path is enabled, the SAN Storage Agent settings override the client tcpserveraddress, tcpport, and ssl options. This override action occurs to ensure that both the client and the Storage Agent use the same server communication options.

## Supported Clients

---

**AIX** | **Linux** | **Solaris** This option is valid only for AIX®, Linux x86\_64, Linux on POWER®, and Oracle Solaris clients.

**Windows** This option is valid for all Windows clients.

## Options File

---

**AIX** | **Linux** | **Solaris** Place this option in the dsm.sys file within a server stanza. You can also set this option by selecting the Enable Lanfree check box on the General tab in the Preferences editor.

**Windows** Place this option in the client options file (dsm.opt). You can also set this option by selecting the Enable Lanfree check box on the General tab in the Preferences editor.

## Syntax

---

```
>>-ENABLELanfree--+-No-->>
                    '-Yes-'<<
```

## Parameters

---

Yes

Specifies that you want to enable an available LAN-free path to a SAN-attached storage device.

No

Specifies that you do not want to enable a LAN-free path to a SAN-attached storage device. This is the default.

## Examples

---

Options file:

```
enablelanfree yes
```

Command line:

```
-enablelanfree=yes
```

This option is valid only on the initial command line. It is not valid in interactive mode.

AIX Linux Solaris Mac OS X Windows

## Encryptiontype

---

Use the encryptiontype option to specify the algorithm for data encryption.

The encryptiontype affects only backup and archive operations. The data that you include is stored in encrypted form, and encryption does not affect the amount of data that is sent or received. During restore and retrieve operations the encrypted data is decrypted with the proper encryption algorithm, regardless of the setting for this option.

AIX Linux Solaris Mac OS X Windows

## Supported Clients

---

This option is valid for all clients.

## Options File

---

**AIX Linux Solaris Mac OS X** Place this option in the client system-options file (dsm.sys) within a server stanza. You can also set this option on the Authorization tab of the Preferences editor. The server can override this.

**Windows** Place this option in the client options file (dsm.opt). You can also set this option on the Authorization tab of the Preferences editor. The server can override this.

## Syntax

---

```
>>-ENCRYPTIONtype--+-AES128-+----->>  
                        '-AES256-'
```

## Parameters

---

AES128

AES 128-bit data encryption. AES 128-bit is the default.

AES256

AES 256-bit data encryption. AES 256-bit data encryption provides the highest level of data encryption available in backup and archive operations.

## Examples

---

Options file:

```
encryptiontype aes128
```

Command line:

Does not apply.

## Encryptkey

---

The backup-archive client supports the option to encrypt files that are being backed up or archived to the IBM Spectrum Protect™ server. This option is enabled with the include.encrypt option.



All files matching the pattern on the include.encrypt specification are encrypted before the data is sent to the server. There are three options for managing the key used to encrypt the files (prompt, save, and generate). All three options can be used with either the backup-archive client or the IBM Spectrum Protect API.

**Windows** The encryption key password is case-sensitive and can be up to 63 characters in length and include the following characters:

**AIX** | **Linux** | **Mac OS X** | **Solaris** The encryption key password is case-sensitive and can be up to 64 characters in length and include the following characters:

A-Z

Any letter, A through Z, uppercase or lowercase. You cannot specify national language characters.

0-9

Any number, 0 through 9

+

Plus

.

Period

\_

Underscore

-

Hyphen

&

Ampersand

Note:

1. The API has an alternate way of specifying `encryptkey=generate`; the previous `enableclientencryptkey=yes` option can also be specified to request generate encryption processing.
2. The `enableclientencryptkey=yes` API option is still supported, so it is possible when using the API to specify two conflicting options. For example, `enableclientencryptkey=yes` and `encryptkey=prompt` or `encryptkey=save`.
3. When conflicting values are specified, the API returns an error message.

**AIX** | **Linux** | **Solaris** | **Mac OS X** Attention: When using the prompt option, your encryption key is not saved in the IBM Spectrum Protect password file on UNIX. If you forget the key, your data cannot be recovered.

**Windows** Attention: When using the prompt option, your encryption key is not saved in the Windows Registry. If you forget the key, your data cannot be recovered.

## Supported Clients

---

This option is valid for all clients. The server can also define this option.

## Options File

---

**AIX** | **Linux** | **Solaris** | **Mac OS X** Place this option in the client system-options file (`dsm.sys`) within a server stanza. You can set this option on the Authorization tab, Encryption Key Password section of the Preferences editor.

**Windows** Place this option in the client options file (`dsm.opt`). You can set this option on the Authorization tab, Encryption Key Password section of the Preferences editor.

## Syntax

---

```
>>-ENCRYPTKey-- .-save----->>
+-----+
+-prompt---+
'-generate-'
```

## Parameters

---

save

The encryption key password is saved in the backup-archive client password file. A prompt is issued for an initial encryption key password, and after the initial prompt, the saved encryption key password in the password file is used for the backups

and archives of files matching the include.encrypt specification. The key is retrieved from the password file on restore and retrieve operations.

**Windows** The password can be up to 63 bytes in length.

**AIX Linux Mac OS X Solaris** The password can be up to 64 bytes in length.

When the save option is specified for an API application, the initial key password must be provided by the application using the API in the dsmInitEx function call. The API itself does not issue a prompt to the user but relies on the application to prompt the user as necessary.

This parameter is the default.

Note: The following restrictions apply:

- This option can only be used when passwordaccess generate is also specified.
- The root user or an authorized user must specify the initial encryption key password.

prompt

The management of the encryption key password is provided by the user. The user is prompted for the encryption key password when the client begins a backup or archive. A prompt for the same password is issued when restoring or retrieving the encrypted file.

**Windows** This password can be up to 63 bytes in length.

**AIX Linux Mac OS X Solaris** This password can be up to 64 bytes in length.

When the prompt option is specified for an API application, the key password must be provided by the application using the API in the dsmInitEx function call. The API itself does not issue a prompt to the user but relies on the application to prompt the user as necessary.

generate

An encryption key password is dynamically generated when the client begins a backup or archive. This generated key password is used for the backups of files matching the include.encrypt specification. The generated key password, in an encrypted form, is kept on the IBM Spectrum Protect server. The key password is returned to the client to enable the file to be decrypted on restore and retrieve operations.

## Examples

---

Options file:

```
encryptkey prompt
```

Command line:

Does not apply.

## Errorlogmax

---

The errorlogmax option specifies the maximum size of the error log, in megabytes. The default name for the error log is dsmerror.log.

Log wrapping is controlled by the errorlogmax option. If errorlogmax is set to zero (0), the size of the log is unlimited; logged entries never "wrap" and begin overwriting earlier logged entries. If errorlogmax is not set to zero, the newest log entries overwrite the oldest log entries after the log file reaches its maximum size.

Log pruning is controlled by the errorlogretention option. Pruned logs do not wrap. Instead, log entries that are older than the number of days specified by the errorlogretention option are removed from the log file.

If you change from log wrapping (errorlogmax option) to log pruning (errorlogretention option), all existing log entries are retained and the log is pruned using the new errorlogretention criteria. Pruned log entries are saved in a file called dsmerlog.pru.

If you change from using log pruning (errorlogretention option) to using log wrapping (errorlogmax option), all records in the existing log are copied to the dsmerlog.pru log file, the existing log is emptied, and logging begins using the new log wrapping criteria.

If you simply change the value of the errorlogmax option, the existing log is extended or shortened to accommodate the new size. If the value is reduced, the oldest entries are deleted to reduce the file to the new size.

If neither `errorlogmax` nor `errorlogretention` is specified, the error log can grow without any limit on its size. You must manually manage the log contents to prevent the log from depleting disk resources. When the log has been created with neither option specified, if you later issue a command and specify the `errorlogretention` option, the log is pruned using the retention value specified. When the log has been created with neither option specified, if you later issue a command and specify the `errorlogmax` option, the existing log is treated as if it was a pruned log. That is, the content of the `dsmerror.log` file is copied to a file called `dsmerlog.pru` and new log entries are created in `dsmerror.log` and the log is wrapped when it reaches its maximum size.

Note: If you specify a non-zero value for `errorlogmax` (which enables log wrapping), you cannot use the `errorlogretention` option to create pruned logs. Logs can be pruned or wrapped, but not both.

Logs created with the `errorlogmax` option contain a log header record that contains information similar to this example record:

```
LOGHEADERREC 661 104857600 IBM Spectrum Protect 8.1.0 Fri Dec 9 06:46:53 2011
```

Note that the dates and time stamps in the `LOGHEADERREC` text are not translated or formatted using the settings specified on the `dateformat` or `timeformat` options.

AIX Linux Solaris Mac OS X Windows

## Supported Clients

---

This option is valid for all clients.

## Options File

---

AIX Linux Solaris Mac OS X Place this option in the client system-options file (`dsm.sys`) within a server stanza.

Windows Place this option in the client options file (`dsm.opt`).

AIX Linux Solaris Mac OS X Windows You can also set this option on the Client preferences tab in the GUI, by selecting `Enable error log file wrapping` and by specifying a non-zero maximum size for the log file. To prevent log file wrapping, set the maximum size to zero. When the maximum wrapping is set to zero, clearing or setting the `Enable error log file wrapping` option has no effect; log wrapping does not occur if the maximum size is set to zero.

## Syntax

---

```
>>-ERRORLOGMAX-- --size-----><
```

## Parameters

---

`size`

Specifies the maximum size, in megabytes, for the log file. The range of values is 0 to 2047; the default is 0, which disables log file wrapping and allows the log file to grow indefinitely.

## Examples

---

Options file:

```
errorlogmax 2000
```

Command line:

```
-errorlogmax=2000
```

This option is valid only on the initial command line. It is not valid in interactive mode.

## Errorlogname

---

This option specifies the fully qualified path and file name of the file that contains the error messages.

AIX Linux Solaris Mac OS X The value for this option overrides the `DSM_LOG` environment variable. The `dsmwebcl.log` and `dsmsched.log` files are created in the same directory as the error log file you specify with the `errorlogname` option.

Mac OS X For Mac OS X, the default location is one of the following:

~/Library/Logs/tivoli/tsm/  
~/Library/Logs/tivoli/tsm/

**Mac OS X** The dsmerror.log cannot be a symbolic link.

**Windows** The value for this option overrides the DSM\_LOG environment variable. The dsmwebcl.log and dsmsched.log files are created in the same directory as the error log file you specify with the errorlogname option.

**AIX** | **Linux** | **Solaris** | **Mac OS X** | **Windows**

## Supported Clients

---

This option is valid for all clients.

## Options File

---

**AIX** | **Linux** | **Solaris** | **Mac OS X** Place this option in the client system-options file (dsm.sys) within a server stanza. You can set this option on the General tab, Select Error Log button of the Preferences editor.

**Windows** Place this option in the client options file (dsm.opt). You can set this option on the General tab, Select Error Log button of the Preferences editor.

## Syntax

---

```
>>-ERRORLOGName-- --filespec-----><
```

## Parameters

---

filespec

The fully qualified path and file name in which to store error log information. If any part of the path you specify does not exist, the client attempts to create it.

**AIX** | **Linux** | **Solaris** | **Mac OS X** The dsmerror.log file cannot be a symbolic link.

## Examples

---

**AIX** | **Linux** | **Solaris** | **Mac OS X** Options file:

**AIX** | **Linux** | **Solaris** | **Mac OS X** errorlogname /tmp/tsmerror.log

**Windows** Options file:

**Windows** errorlogname c:\temp\dsmerror.log

**AIX** | **Linux** | **Solaris** | **Mac OS X** Command line:

**AIX** | **Linux** | **Solaris** | **Mac OS X** -errorlogname=/tmp/tsmerror.log

**Windows** Command line:

**Windows** -errorlogname=c:\temp\dsmerror.log

This option is valid only on the initial command line. It is not valid in interactive mode.

**Windows** The location of the log file specified using the Client Service Configuration Utility or the client configuration wizard overrides the location specified in the client options file (dsm.opt).

## Errorlogretention

---

The errorlogretention option specifies how many days to maintain error log entries before pruning, and whether to save the pruned entries in other files.

The error log is pruned when the first error is written to the log after a client session is started. If the only session you run is the client scheduler, and you run it twenty-four hours a day, the error log might not be pruned according to your expectations. Stop the session and start it again to allow the scheduler to prune the error log.

If you change from log pruning (errorlogretention option) to log wrapping (errorlogmax option), all records in the existing log are copied to the dsmerlog.pru log file, the existing log is emptied, and logging begins using the new log wrapping criteria.

If you change from log wrapping (errorlogmax option) to log pruning (errorlogretention option), all existing log entries are retained and the log is pruned using the new errorlogretention criteria. Pruned log entries are saved in a file called dsmerlog.pru.

If neither errologmax nor errorlogretention is specified, the error log can grow without any limit on its size. You must manually manage the log contents to prevent the log from depleting disk resources. When the log has been created with neither option specified, if you later issue a command and specify the errorlogretention option, the log is pruned using the retention value specified. When the log has been created with neither option specified, if you later issue a command and specify the errorlogmax option, the existing log is treated as if it was a pruned log. That is, the content of the dsmerlog.log file is copied to a file called dsmerlog.pru and new log entries are created in dsmerlog.log and the log is wrapped when it reaches its maximum size.

Note: If you specify errorlogretention option to create pruned logs, you cannot specify the errorlogmax option. Logs can be pruned or wrapped, but not both.

AIX Linux Solaris Mac OS X Windows

## Supported Clients

---

This option is valid for all clients.

## Options File

---

AIX Linux Solaris Mac OS X Place this option in the client system-options file (dsm.sys) within a server stanza.

Windows Place this option in the client options file (dsm.opt).

AIX Linux Mac OS X Solaris Windows You can also set this option on the Client preferences tab in the GUI, by selecting Prune old entries and by specifying a value for Prune entries older than. Selecting the Save pruned entries option saves the pruned log entries in the dsmerlog.pru log file.

## Syntax

---

```
      .-N----.  .-D-.  
>>-ERRORLOGRetention--+-----+-----+-----+----->>  
      '-days-'  '-S-'
```

## Parameters

---

N or days

Specifies how long to wait before pruning the error log.

N

Do not prune the error log. This permits the error log to grow indefinitely. This is the default.

days

The number of days to keep log file entries before pruning the log. The range of values is zero through 9999.

D or S

Specifies whether to save the pruned entries. Enter a space or comma to separate this parameter from the previous one.

D

Discard the error log entries when you prune the log. This is the default.

S

Save the error log entries when you prune the log.

The pruned entries are copied from the error log to the dsmerlog.pru file located in the same directory as the dsmerlog.log file.

## Examples

---

Options file:

Prune log entries from the dsmerlog.log file that are older than 365 days and save the pruned entries in dsmerlog.pru.

```
errorlogretention 365 S
```

Command line:

```
-errorlogr=365,S
```

Options file:

Prune log entries from the dsmerror.log file that are older than 365 days and do not save the pruned entries.

```
errorlogretention 365 D
```

This option is valid only on the initial command line. It is not valid in interactive mode.

## Exclude options

---

Use the exclude options to exclude objects from backup, image, or archive services.

**Windows** For example, you might want to exclude this type of information:

- All temporary files
- Any local caches of network files
- All files that contain compiled object code that you can easily reproduce using other methods
- Your operating system files

**AIX** | **Linux** | **Solaris** | **Mac OS X** For example, you might want to exclude this type of information:

- All temporary files
- Any local caches of network files
- All files that contain compiled object code that you can easily reproduce using other methods
- Your operating system files

You can exclude specific files from encryption processing during a backup.

**Windows** You can exclude remotely accessed files by specifying Universal Naming Convention (UNC) names in your exclude statement.

Note:

1. **Windows** When you exclude a file that was previously included, existing backup versions become inactive during the next incremental backup.
2. **AIX** | **Linux** | **Solaris** | **Mac OS X** With the exception of `exclude.fs`, when you exclude a file that was previously included, existing backup versions become inactive during the next incremental backup.
3. **Windows** The exclude statements are not case sensitive.
4. The server can define exclude options with the `inlexcl` option.
5. **Windows** As with other include-exclude statements, you can use the `inlexcl` option to specify a file that can be in Unicode format, containing exclude statements with file names in Unicode.

**AIX** | **Linux** | **Solaris** | **Windows** Exclude any system files or images that could corrupt the operating system when recovered. Also exclude the directory containing the IBM Spectrum Protect™ client files.

**AIX** | **Linux** | **Solaris** | **Mac OS X** To exclude an entire directory called `/any/test`, enter the following:

**Windows** To exclude an entire directory called `any\test`, enter the following:

```
AIX | Linux | Solaris | Mac OS X  
exclude.dir /any/test
```

```
Windows  
exclude.dir c:\any\test
```

**Windows** To exclude subdirectories that begin with `test` under the `any` directory, enter the following:

**AIX** | **Linux** | **Solaris** | **Mac OS X** To exclude subdirectories that begin with `test` under the `/any` directory, enter the following:

```
AIX | Linux | Solaris | Mac OS X  
exclude.dir /any/test*
```

```
Windows
```

```
exclude.dir c:\any\test*
```

**Windows** Note: Defining an exclude statement without using a drive letter, such as `exclude.dir code`, excludes the `code` directory on any drive from processing.

AIX Linux Solaris Mac OS X Windows

## Supported Clients

This option is valid for all clients.

## Options File

**AIX Linux Solaris Mac OS X** Place this option in the client system-options file (`dsm.sys`) within a server stanza. You can set these options on the Include-Exclude tab, Define Include-Exclude Options section of the Preferences editor.

**Windows** Place these options in the client options file (`dsm.opt`). You can set these options on the Include-Exclude tab, Define Include-Exclude Options section of the Preferences editor.

## Syntax

```
>>-options-- --pattern-----<<
```

**Windows** `exclude`, `exclude.backup`, `exclude.file`, `exclude.file.backup`

**Windows** Use these options to exclude a file or group of files from backup services.

**AIX Linux Solaris Mac OS X** `exclude`, `exclude.backup`, `exclude.file`, `exclude.file.backup`

**AIX Linux Solaris Mac OS X** Use these options to exclude a file or group of files from backup services and space management services (if the HSM client is installed). The `exclude.backup` option only excludes files from normal backup, but not from HSM.

`exclude.archive`

Excludes a file or a group of files that match the pattern from archive services *only*.

**AIX Linux Solaris Mac OS X** `exclude.attribute.symlink`

**AIX Linux Solaris Mac OS X** Excludes a file or a group of files that are symbolic links or aliases (aliases apply to Mac OS X) from backup processing only.

**Mac OS X** Note: For Mac OS X aliases are excluded.

`exclude.compression`

Excludes files from compression processing if the compression option is set to yes. This option applies to backups and archives.

**AIX Linux Solaris Mac OS X Windows** `exclude.dedup`

**AIX Linux Solaris Mac OS X Windows** Excludes files from client-side data deduplication. To control a client-side data deduplication operation, specify `ieobjtype` as the value of the `exclude.dedup` option.

Valid `ieobjtype` parameters are:

- File
- **AIX Linux Solaris Mac OS X** Image
- **Windows** SYSTEMState
- **Windows** Asr

The default is File.

**AIX Linux Solaris Mac OS X** `exclude.dir`

**AIX Linux Solaris Mac OS X** Excludes a directory, its files, and all its subdirectories and their files from backup processing. For example, the statement `exclude.dir /test/dan/data1` excludes the `/test/dan/data1` directory, its files, and all its subdirectories and their files.

If you exclude a directory that was previously included, the server expires existing backup versions of the files and directories beneath it during the next incremental backup. Use this option to exclude a portion of your data that has no underlying files to back up.

Note: Avoid performing a selective backup, or a partial incremental backup, of an individual file within an excluded directory. The next time that you perform an incremental backup, any files backed up in this manner is expired.

**Windows** `exclude.dir`

**Windows** Excludes a directory, its files, and all its subdirectories and their files from backup processing. For example, the statement `exclude.dir c:\test\dan\data1` excludes the `c:\test\dan\data1` directory, its files, and all its subdirectories and their files.

If you exclude a directory that was previously included, the server expires existing backup versions of the files and directories beneath it during the next incremental backup. Use this option to exclude a portion of your data that has no underlying files to back up.

Note: Avoid performing a selective backup, or a partial incremental backup, of an individual file within an excluded directory. The next time that you perform an incremental backup, any files backed up in this manner is expired.

Note: Defining an exclude statement without using a drive letter, such as `exclude.dir code`, excludes the `code` directory on any drive from processing.

**exclude.encrypt**

Excludes the specified files from encryption processing. This option does not affect whether files are excluded from backup or archive processing, only whether they are excluded from encryption processing.

**AIX Linux Solaris Mac OS X** `exclude.fs`

**AIX Linux Solaris Mac OS X** Excludes file systems that match the specified pattern from backup, incremental image backup, and archive operations. If files from the excluded file systems were ever backed up, then management class rebinding and deleted file expiration does not occur. However, existing backup versions remain on the server subject to associated management class settings. The files that were previously archived from the excluded file system remain on the server as archive copies.

**AIX Linux Solaris Mac OS X** The `exclude.fs` option does NOT prevent the backup or archive of any virtual mount points that are subdirectories of the excluded file system.

**AIX Linux Solaris** Use `exclude.image` to exclude file systems from full image backup operations.

**AIX Solaris** `exclude.fs.nas`

**AIX Solaris** Excludes file systems on the NAS file server from an image backup when used with the `backup nas` command. The NAS node name must be prefixed to the file system name, for example: `netappsj1/vol/vol11`. To apply the exclude to all NAS nodes, replace the NAS node name with a wildcard, for example: `*/vol/vol11`. The `backup nas` command ignores all other exclude statements including `exclude.fs` and `exclude.dir` statements. This option is valid for AIX® and Solaris clients *only*.

**Windows** `exclude.fs.nas`

**Windows** Excludes file systems on the NAS file server from an image backup when used with the `backup nas` command. The NAS node name must be prefixed to the file system name, for example: `netappsj1/vol/vol11`. To apply the exclude to all NAS nodes, replace the NAS node name with a wildcard, for example: `*/vol/vol11`. The `backup nas` command ignores all other exclude statements including `exclude.dir` statements. This option is valid for all Windows clients.

**AIX Linux Solaris** `exclude.image`

**AIX Linux Solaris** Excludes mounted file systems and raw logical volumes that match the specified pattern from full image backup operations. This option is valid for AIX, all Linux clients, and Solaris only. Use `exclude.fs` to exclude file systems from incremental image backup operations.  
Restriction: This option does not apply to Mac OS X.

**Windows**  
Table 1. System services components and corresponding keywords

Component	Keyword
Background Intelligent Transfer Service	BITS
Event log	EVENTLOG
Removable Storage Management	RSM
Cluster Database	CLUSTERDB
Remote Storage Service	RSS
Terminal Server Licensing	TLS
Windows Management Instrumentation	WMI
Internet Information Services (IIS) metabase	IIS
DHCP database	DHCP
Wins database	WINSDB



## Parameters

**AIX** | **Linux** | **Solaris** | **Mac OS X** pattern

**AIX** | **Linux** | **Solaris** | **Mac OS X** Specifies the file or group of files that you want to exclude.

Note: For NAS file systems: You must prefix the NAS node name to the file specification to specify the file server to which the exclude statement applies. If you do not specify a NAS node name, the file system identified refers to the NAS node name specified in the client system-options file (dsm.sys) or on the command line.

If the pattern begins with a single or double quote or contains any embedded blanks or equal signs, you must surround the value in either single (') or double (") quotation marks. The opening and closing quotation marks must be the same type of quotation marks.

**AIX** | **Linux** | **Solaris** For the exclude.image option, the pattern is the name of a mounted file system or raw logical volume.

**Windows** pattern

**Windows** Specifies the file or group of files that you want to exclude.

Note: For NAS file systems: You must prefix the NAS node name to the file specification to specify the file server to which the exclude statement applies. If you do not specify a NAS node name, the file system identified refers to the NAS node name specified in the client options file (dsm.opt) or on the command line.

If the pattern begins with a single or double quote or contains any embedded blanks or equal signs, you must surround the value in either single (') or double (") quotation marks. The opening and closing quotation marks must be the same type of quotation marks.

- For the exclude.image option, the pattern is the name of a file system or raw logical volume.

## Examples

Options file:

**AIX** | **Linux** | **Solaris** | **Mac OS X**

```
exclude /unix/  
exclude ../../core  
exclude /home/jones/proj1/*  
exclude.archive ../../core  
exclude.backup /home/jones/proj1/devplan/  
exclude.dir /home/jones/tmp  
exclude.backup /users/home1/file1  
exclude.image /usr/*/*  
exclude.encrypt /users/home2/file1  
exclude.compression /home/gordon/proj1/*  
exclude.fs.nas netappsj/vol/vol0  
exclude.attribute.symlink ../../*  
exclude.dedup /Users/Administrator/Documents/Important/../../*
```

**Windows**

```
exclude ?:\...\swapper.dat  
exclude "?:\ea data. sf"  
exclude ?:\io.sys  
exclude ?:\...\spart.par  
exclude c:\*\budget.fin  
exclude c:\devel\*  
exclude.dir c:\home\jodda  
exclude.archive c:\home\*.obj  
exclude.encrypt c:\system32\mydocs\*  
exclude.compression c:\test\file.txt  
  
exclude.fs.nas netappsj/vol/vol0  
exclude.dedup c:\Users\Administrator\Documents\Important\../../*  
exclude.dedup e:\*\* ieobjtype=image  
exclude.dedup ALL ieobjtype=systemstate  
exclude.dedup ALL ieobjtype=ASR
```

Command line:

Does not apply.

- **AIX** | **Linux** | **Solaris** | **Mac OS X** Controlling symbolic link and alias processing  
The backup-archive client treats symbolic links and aliases (aliases apply to Mac OS X only) as actual files and backs them up. However, the file referenced by the symbolic link is not backed up. In some cases symbolic links can be easily recreated and need not be backed up.
- Controlling compression processing  
This topic lists some items to consider if you want to exclude specific files or groups of files from compression processing during a backup or archive operation.
- **AIX** | **Linux** | **Solaris** | **Mac OS X** | **Windows** Processing NAS file systems  
Use the `exclude.fs.nas` option to exclude file systems from NAS image backup processing.
- **Linux** | **Windows** Virtual machine exclude options  
Virtual machine include and exclude options influence the behavior of backup and restore operations for virtual machines. These options are processed before any command-line options are processed, so that options on the command line can override options specified on any of the virtual machine include options or virtual machine exclude options. See the individual option descriptions for information about the options.

**AIX** | **Linux** | **Mac OS X** | **Solaris**

## Controlling symbolic link and alias processing

The backup-archive client treats symbolic links and aliases (aliases apply to Mac OS X only) as actual files and backs them up. However, the file referenced by the symbolic link is not backed up. In some cases symbolic links can be easily recreated and need not be backed up.

In addition, backing up these symbolic links can increase backup processing time and occupy a substantial amount of space on the IBM Spectrum Protect™ server. You can use the `exclude.attribute.symlink` option to exclude a file or a group of files that are symbolic links from backup processing. If necessary, you can use the `include.attribute.symlink` option to include symbolic links within broad group of excluded files for backup processing.

For example, to exclude all symbolic links from backup processing, except those that exist under the `/home/spike` directory, enter these statements in your `dsm.sys` file:

```
exclude.attribute.symlink /.../*
include.attribute.symlink /home/spike/.../*
```

### Related reference:

Include options

## Controlling compression processing

This topic lists some items to consider if you want to exclude specific files or groups of files from compression processing during a backup or archive operation.

- Remember that the backup-archive client compares the files it processes against the patterns specified in the include-exclude statements, reading from the bottom to the top of the options file.
- **AIX** | **Linux** | **Solaris** | **Mac OS X** The client processes `exclude.fs`, `exclude.dir`, and other include-exclude statements first. The client then considers any `exclude.compression` statements. For example, consider the following include-exclude list:

```
exclude /home/jones/proj1/*.*
exclude.compression /home/jones/proj1/file.txt
include /home/jones/proj1/file.txt
```

The client examines the statements (reading from bottom to top) and determines that the `/home/jones/proj1/file.txt` file is a candidate for backup, but is not a candidate for compression processing.

- **Windows** The client processes `exclude.dir` and other include-exclude statements first. The client then considers any `exclude.compression` statements. For example, consider the following include-exclude list:

```
exclude c:\test\*.*
exclude.compression c:\test\file.txt
include c:\test\file.txt
```

The client examines the statements (reading from bottom to top) and determines that the `c:\test\file.txt` file is a candidate for backup, but is not a candidate for compression processing.

- Include-exclude compression processing is valid only for backup and archive processing. The `exclude.compression` option does not affect whether files are excluded from backup or archive processing, only whether they are excluded from compression processing.

**Related reference:**

Compression

AIX | Linux | Solaris | Mac OS X | Windows

## Processing NAS file systems

Use the `exclude.fs.nas` option to exclude file systems from NAS image backup processing.

Linux | Windows Note: The `exclude.fs.nas` option does not apply to a snapshot difference incremental backup.

A NAS file system specification uses the following conventions:

- NAS nodes represent a unique node type. The NAS node name uniquely identifies a NAS file server and its data to the backup-archive client. You can prefix the NAS node name to the file specification to specify the file server to which the exclude statement applies. If you do not specify a NAS node name, the file system identified applies to all NAS file servers.
- Regardless of the client platform, NAS file system specifications use the forward slash (/) separator, as in this example: `/vol/vol10`.

For example, to exclude `/vol/vol11` from backup services on all NAS nodes, specify the following exclude statement:

```
exclude.fs.nas */vol/vol11
```

Linux | Windows

## Virtual machine exclude options

Virtual machine include and exclude options influence the behavior of backup and restore operations for virtual machines. These options are processed before any command-line options are processed, so that options on the command line can override options specified on any of the virtual machine include options or virtual machine exclude options. See the individual option descriptions for information about the options.

 This feature is available only if the client operates as a data mover for IBM Spectrum Protect™ for Virtual Environments.

- Linux | Windows `Exclude.vmdisk`  
The `EXCLUDE.VMDISK` option excludes a virtual machine disk from backup operations.

**Related reference:**

`Exclude.vmdisk`

Linux | Windows

## Fbbranch

Use the `fbbranch` option with the backup fastback or archive fastback commands.

The `fbbranch` option specifies the branch ID of the remote FastBack server to back up or archive. The `fbbranch` option is only required when the backup-archive client is installed on the FastBack Disaster Recovery Hub or when a dedicated proxy is connecting to a replicated FastBack Disaster Recovery Hub repository. Do not specify the `fbbranch` option when the backup-archive client is installed on the FastBack server.

## Supported Clients

Linux This option is valid for Linux x86\_64 clients.

Windows This option is valid for all Windows clients.

## Options File

Linux None. You can specify this option only on the command line. The server can also define or override this option.

Windows None. You can specify this option only on the command line. The server can also define or override this option.

## Syntax

---

```
>>-FBBranch=--branch_ID-----><
```

## Parameters

---

branch\_ID

Specifies the FastBack server branch ID. The value is part of the disaster recovery configuration of the FastBack server.

## Examples

---

Command line:

```
-FBBranch=oracle
```

On a backup-archive client that is installed on the FastBack Disaster Recovery Hub:

```
dsmc backup fastback -fbpolicyname=policy1 -fbserver=myFbServer  
-fbbranch=oracle
```

Command line:

On a backup-archive client that is connecting to a repository on a remote FastBack Disaster Recovery Hub:

```
dsmc backup fastback -fbpolicyname=policy1 -fbserver=server1  
-Fbreposlocation=\\myDrHub.company.com\REP  
-fbbranch=oracle
```

If the fbbranch option is specified on a backup-archive client workstation that is installed on the FastBack server, the fbbranch option is ignored.

Linux | Windows

## Fbclientname

---

Use the fbclientname option with the backup fastback or archive fastback commands.

The fbclientname option is the name of one or more comma-separated FastBack clients to back up or archive from the backup proxy. The values for the fbclientname option are invalid if more than one policy is specified in the fbpolicyname option.

You cannot include spaces in the fbclientname option values.

If you do not specify any values for the fbvolumename option, all the volumes from all the FastBack clients in the policy that is specified are backed up. If you specify multiple FastBack clients in the fbclientname option, you cannot specify values for the fbvolumename option.

## Supported Clients

---

Linux This option is valid for Linux x86\_64 clients.

Windows This option is valid for all Windows clients.

## Options File

---

Linux None. You can specify this option only on the command line.

Windows None. You can specify this option only on the command line. The server can also define or override this option.

## Syntax

---

```
          .,-----.  
          v         |  
>>-FBClientname----client_name+-----><
```

## Parameters

---

client\_name

Specifies the name of one or more FastBack clients. You can specify up to 10 FastBack client names.

Important:

When specifying the archive fastback or backup fastback command:

1. At least one FBpolicyName is always required.
2. You can specify up to 10 values for FBPolicyName, if no values are specified for both FBClientName and FBVolumeName.
3. When you specify a FBClientName value, there must be only one value for FBPolicyName.
4. You can specify up to 10 values for FBClientName if only one PolicyName is specified, and no values for FBVolumeName are specified.
5. When you specify the FBVolumeName option, you can have only one FBPolicy, and only one FBClientName specified.
6. You can specify multiple FBVolumeNames if condition 5 is satisfied.
7. You must always specify the FBReposLocation option for Linux.

## Examples

---

**Linux** Command line:

**Linux**

```
dsmc backup fastback -fbpolicyname=Policy1
-fbclientname=fbclient1,fbclient2
-fbserver=myFbServer
-fbreposlocation=/mnt/FBLocation
```

Backs up all volumes for FastBack clients fbclient1 and fbclient2 that are found in policy Policy1.

**Windows** Command line:

**Windows**

```
dsmc backup fastback -fbpolicyname=Policy1
-fbclientname=fbclient1,fbclient2
-fbserver=myFbServer
-fbreposlocation=\\myFbServer.company.com\REP
```

Backs up all volumes for FastBack clients fbclient1 and fbclient2 that are found in policy Policy1.

**Windows** Command line:

**Windows**

```
dsmc backup fastback -fbpolicyname=Policy1
-fbclientname=fbclient1
-fbvolume=c:,f: -fbserver=myFbServer
-fbreposlocation=\\myFbServer.company.com\REP
```

Backs up volumes C:\ and F:\ for FastBack client fbclient1 found in policy Policy1.

**Windows** Command line:

**Windows**

```
dsmc backup fastback -fbpolicyname=Policy1
-fbclientname=fbWindowsClient,fbLinuxClient
-fbserver=myFbServer
-fbreposlocation=\\myFbServer.company.com\REP
```

Backs up all volumes for FastBack client fbWindowsClient found in policy Policy1.

The volumes for Linux FastBack client fbLinuxClient will not be backed up from the Windows backup-archive client. To back up or archive volumes from a Linux FastBack client, use the Linux backup-archive client.

**Linux** | **Windows**

## Fbpolicyname

---

Use the fbpolicyname option with the backup fastback or archive fastback commands.

The `fbpolicyname` option is the name of one or more comma-separated FastBack policies that you want to back up or archive from the backup proxy. You must specify at least one policy name. Specify multiple policy names using a comma-delimited list of policies. There is no default value.

If one or more FB policy names contain spaces, you must specify them within quotation marks. Here is an example: "FB Policy NAME1, FBPolicy Name 2".

If you do not specify any values for the `fbclientname` and `fbvolumename` options, all the volumes from all the FastBack clients in the policies that are specified are backed up. If you specify multiple policies in the `fbpolicyname` option, you cannot specify values for the `fbclientname` and `fbvolumename` options.

**Windows** If a policy specification contains both Windows and Linux FastBack clients, only the Windows volumes will be backed up or archived to the IBM Spectrum Protect™ server by the Windows backup-archive client.

**Linux** If a policy specification contains both Windows and Linux FastBack clients, only the Linux volumes will be backed up or archived to the IBM Spectrum Protect server by the Linux backup-archive client.

At least one snapshot should exist in the FastBack repository for the FastBack policies being archived or backed up prior to issuing the `dsmc` command

## Supported Clients

---

**Linux** This option is valid for Linux x86\_64 clients.

**Windows** This option is valid for all Windows clients.

## Options File

---

**Linux** None. You can specify this option only on the command line.

**Windows** None. You can specify this option only on the command line. The server can also define or override this option.

## Syntax

---

```

      .,-----
      v         |
>>-FBPolicyname---policy_name+-----><
```

## Parameters

---

`policy_name`  
Specifies the name of the FastBack policies. You can specify up to 10 FastBack policy names.

Important:

When specifying the archive fastback or backup fastback command:

1. At least one `FBpolicyName` is always required.
2. You can specify up to 10 values for `FBPolicyName`, if no values are specified for both `FBClientName` and `FBVolumeName`.
3. When you specify a `FBClientName` value, there must be only one value for `FBPolicyName`.
4. You can specify up to 10 values for `FBClientName` if only one `PolicyName` is specified, and no values for `FBVolumeName` are specified.
5. When you specify the `FBVolumeName` option, you can have only one `FBPolicy`, and only one `FBClientName` specified. You must specify exactly one `FBClientName`. It cannot be omitted.
6. You can specify multiple `FBVolumeNames` if condition 5 is satisfied.
7. You must always specify the `FBReposLocation` option for Linux.

## Examples

---

Command line:

```
dsmc backup fastback -fbpolicyname=Policy1,Policy2,Policy3
-fbserver=myFbServer
```

```
-fbreposlocation=\\myFbServer.company.com\REP
```

Backs up all volumes for all FastBack clients found in policies Policy1, Policy2 and Policy3.

To specify policies with spaces, enclose them in double quotation marks, for example:

```
-fbpolicyname="Policy 1,Policy2,Policy3"
```

Linux Windows

## Fbreposlocation

Use the fbreposlocation option with the backup fastback or archive fastback commands.

The fbreposlocation option specifies the location of the Tivoli® Storage Manager FastBack repository for the backup-archive client proxy to connect to issue Tivoli Storage Manager FastBack shell commands necessary to mount appropriate snapshots.

**Linux** This option is required on Linux systems. There is no default location.

**Linux** If you specify the fbreposlocation option for a snapshot on the FastBack server, use the server\_name@WORKGROUP format.

**Linux** There are two ways to specify the FastBack repository location on the FastBack Disaster Recovery Hub:

- Specify the complete repository location via the option `-fbreposlocation=\\DR_Hub\rep_server`. When using this format, DR\_Hub is the FastBack Disaster Recovery Hub machine name and rep\_server is the name of the replicated FastBack server repository on the DR Hub.
- Specify the repository location using a combination of the `-fbreposlocation=` and `-fbbranch` options. When using this format, specify the DR Hub repository the location via the option `-fbreposlocation=DR_Hub@WORKGROUP`, and specify the name of the replicated FastBack server repository on the DR Hub using the `-fbbranch` option.

**Windows** On Windows systems, you do not need to specify the fbreposlocation option when the backup-archive client is installed on a DR Hub server or the FastBack server workstation. When the backup-archive client is installed on a dedicated client proxy, the repository location fbreposlocation option is required.

**Windows** If you specify the fbreposlocation option for the FastBack Disaster Recovery Hub, specify only the base directory of the DR Hub repository with this option. Then use the fbbranch option to indicate the Branch ID of the server to back up. If you specify the fbreposlocation option for the FastBack server, use the format `\\<fbserver>\REP`. In this case, do not use the fbbranch option.

**Linux** If you use the format `-fbr=\\<fbserver>\REP`, specify two backslashes before `<fbserver>` and one backslash before REP when using the backup-archive client in interactive mode. If you are using this format as a Linux command `dsmc backup fastback -fbr=\\<fbserver>\REP`, you must specify four backslashes before `<fbserver>` and two backslashes before REP. This is because the Linux shell interprets a backslash as an escape character; the first backslash is treated as an escape character for the following backslash.

## Supported Clients

**Linux** This option is valid for Linux x86\_64 clients.

**Windows** This option is valid for all Windows clients.

## Options File

None. You can specify this option only on the command line. The server can also define or override this option.

## Syntax

```
>>-FBReposlocation--repository_location-----<<
```

## Parameters

repository\_location

Specifies the Tivoli Storage Manager FastBack repository location.

## Examples

---

**Linux** Command line:

**Linux**

```
dsmc backup fastback -fbpolicyname=Policy1  
-fbclientname=fbclient1,fbclient2 -fbserver=myFbDrHub  
-fbreposlocation=\\myFbDrHub\rep_myFbServer
```

Note: Because Linux is supported only as a dedicated proxy configuration, a repository location is always required on Linux.

**Linux** Command line:

**Linux**

```
dsmc backup fastback -fbpolicyname=Policy1  
-fbclientname=fbclient1,fbclient2 -fbserver=myFbDrHub  
-fbreposlocation=myFbDrHub -fbbranch=rep_myFbServer
```

Note: Because Linux is supported only as a dedicated proxy configuration, a repository location is always required on Linux.

**Windows** Command line:

**Windows**

The `fbreposlocation` option is only required on a dedicated proxy machine. If the `fbreposlocation` option is specified on a machine where the FastBack server or FastBack Disaster Recovery Hub is installed, it is ignored.

Use this command when the IBM Spectrum Protect™ dedicated proxy client is connecting to a remote Tivoli Storage Manager FastBack server repository:

```
dsmc backup fastback -fbpolicyname="Policy 1" -fbserver=myFbServer  
-fbreposlocation=\\myFbServer.company.com\REP
```

A repository location is required.

`myFbServer` is the short host name of the machine where the FastBack server is installed.

**Windows** Command line:

**Windows**

Use this command when the IBM Spectrum Protect dedicated proxy client is connecting to a remote repository on the FastBack Disaster Recovery Hub:

```
dsmc backup fastback -fbpolicyname="Policy 1" -fbserver=myFbServer  
-fbreposlocation=\\myfbdrhub.company.com\REP  
-fbbranch=aFbServerBranch
```

A repository location is required.

The `myFbServer` parameter specifies the short host name of the FastBack Server whose FastBack branch is specified using the `FBBBranch` option.

The `fbbranch` option specifies the branch ID of the FastBack server on the disaster recovery hub.

**Linux**

**Windows**

## Fbserver

---

Use the `fbserver` option with the `backup fastback` or `archive fastback` commands.

The `fbserver` option specifies the short host name of the Tivoli® Storage Manager FastBack server workstation that owns the repository specified by the `fbreposlocation` option. For a DR Hub, the `fbserver` option specifies the short name of the FastBack server workstation whose branch repository the backup-archive client is connecting to.

The `fbserver` option is a key to retrieving the necessary user credentials required to connect to the FastBack server repository or the DR Hub server repository for mount processing.

## Supported Clients

---

**Linux**

This option is valid for Linux x86\_64 clients.



**Windows** This option is valid for all Windows clients.

## Options File

---

**Linux** None. You can specify this option only on the command line.

**Windows** None. You can specify this option only on the command line. The server can also define or override this option.

## Syntax

---

```
>>- -FBServer-- --server_name-----<<
```

## Parameters

---

server\_name

Specifies the short hostname of the machine on which the FastBack server is installed.

## Examples

---

**Linux** Command line:

**Linux** The backup-archive client is installed on a Linux proxy client machine. Use this command to archive all FastBack volumes for all Linux FastBack clients that are defined for FastBack policy1:

```
dsmc archive fastback -fbpolicyname=Policy1  
-fbserver=myfbserver  
-fbreposlocation=myfbserver@WORKGROUP
```

The repository location is required. If you do not provide the repository location, the command will fail.

The FastBack server name, -myfbserver, is the short host name of the FastBack server where the repository is located.

**Linux** Command line:

**Linux** The repository, rep\_server1, is located on the FastBack Disaster Recovery Hub, myFbDrHub.

```
dsmc archive fastback -fbpolicyname="Policy 1"  
-fbserver=myFbDrHub  
-fbreposlocation=\\myFbDrHub\rep_server1
```

The FastBack server name, -myFbDrHub is the short host name of the FastBack Disaster Recovery Hub server where the repository is located

The -fbreposlocation specifies the location of the repository. The repository location is required. If you do not provide the repository location, the command fails.

-fbserver should point to the short host name of the FastBack DR hub in this case.

**Linux** Command line:

**Linux** Archive all volumes protected by FastBack policy named policy1 from the FastBack server named basil:

```
dsmc archive fastback -Fbpolicyname=policy1  
-FBServer=basil -ARCHMC="my_tsm_mgmt_class"  
-fbreposlocation=basil@WORKGROUP
```

**Windows** Command line:

**Windows** The IBM Spectrum Protect™ backup-archive client is running on the FastBack server machine whose short name is myFbServer:

```
dsmc archive fastback -fbpolicyname=Policy1 -fbserver=myFbServer
```

**Windows** Command line:

**Windows** The IBM Spectrum Protect backup-archive client is running on the FastBack Disaster Recovery Hub machine and is connecting to the FastBack Server branch repository branch1. The short host name of the FastBack server is myFbServer:

```
dsmc archive fastback -fbpolicyname=Policy1 -fbserver=myFbServer  
-fbbranch=branch1
```

**Windows** Command line:

**Windows** The backup-archive client is running on a dedicated proxy machine and is connecting to a remote FastBack server repository. The FastBack server is installed on a machine whose short name is myFbServerMachine:

```
dsmc archive fastback -fbpolicyname=Policy1 -fbserver=myFbServerMachine  
-fbrepositlocation=\\myFbServerMachine.company.com\Rep
```

**Windows** Command line:

**Windows** The backup-archive client is running on a dedicated proxy machine and is connecting to a remote FastBack repository on the FastBack DR Hub. The FastBack Server with branch ID branch1 is installed on a machine whose short name is myFbServer.

```
dsmc backup fastback -fbpolicyname=Policy1 -fbserver=myFbServer  
-fbrepositlocation=\\myDrHubMachine.company.com\Rep  
-fbbranch=branch1
```

**Linux** | **Windows**

## Fbvolumename

---

Use the fbvolumename option with the backup fastback or archive fastback commands.

The fbvolumename option is the name of one or more comma-separated Tivoli® Storage Manager FastBack volumes to back up or archive from the backup proxy. Values for the fbvolumename option are not valid if more than one FastBack client is specified in the fbclientname option.

If you specify multiple FastBack clients in the fbclientname option, you cannot specify values for the fbvolumename option.

## Supported Clients

---

**Linux** This option is valid for Linux x86\_64 clients.

**Windows** This option is valid for all Windows clients.

## Options File

---

**Linux** None. You can specify this option only on the command line.

**Windows** None. You can specify this option only on the command line. The server can also define or override this option.

## Syntax

---

```
      .-.-.-.-.-  
      v         |  
>>-FBVolumename----volume_name-+-----<<
```

## Parameters

---

volume\_name

Specifies the name of the Tivoli Storage Manager FastBack volumes. You can specify up to 10 FastBack volume names.

Important:

When specifying the archive fastback or backup fastback command:

1. At least one FBpolicyName is always required.
2. You can specify up to 10 values for FBPolicyName, if no values are specified for both FBClientName and FBVolumeName.
3. When you specify a FBClientName value, there must be only one value for FBPolicyName.
4. You can specify up to 10 values for FBClientName if only one PolicyName is specified, and no values for FBVolumeName are specified.
5. When you specify the FBVolumeName option, you can have only one FBPolicy, and only one FBClientName specified. You must specify exactly one FBClientName. It cannot be omitted.
6. You can specify multiple FBVolumeNames if condition 5 is satisfied.

7. **Linux** You must specify the FBReposLocation option.

## Examples

---

**Linux** Command line:

**Linux**

```
dsmc backup fastback -fbpolicyname=Policy1 -fbclientname=client1  
-fbvolumename=data1,data2 -fbserver=myFbDrHub  
-fbreposlocation=\\myFbDrHub\rep_server1
```

Backs up volumes data1 and data2 from FastBack client client1 found in policy Policy1.

**Windows** Command line:

**Windows**

```
dsmc backup fastback -fbpolicyname=Policy1 -fbclientname=client1  
-fbvolumename=c:,f: -fbserver=myFbServer  
-fbreposlocation=\\myFbServer.company.com\REP
```

Backs up volumes C:\ and F:\ from FastBack client Client1, found in policy Policy1.

**Windows** Command line:

**Windows**

```
dsmc archive fastback -fbpolicyname=Policy1 -fbclientname=client1  
-fbvolumename=c:,f: -fbserver=myFbServer  
-fbreposlocation=\\myFbServer.company.com\REP
```

Archives volumes C: and F: from FastBack client Client1, found in policy Policy1.

## Filelist

---

Use the filelist option to process a list of files.

You can use the filelist option with the following commands:

- archive
- **Windows** backup group
- **AIX** | **Linux** | **Solaris** | **Mac OS X** backup group
- delete archive
- delete backup
- expire
- incremental
- query archive
- query backup
- restore
- retrieve
- selective

The backup-archive client opens the file you specify with this option and processes the list of files within according to the specific command. Except for the restore and retrieve commands, when you use the filelist option, the client ignores all other file specifications on the command line.

The files (entries) listed in the filelist must adhere to the following rules:

- Each entry must be a fully-qualified or a relative path to a file or directory. Note that if you include a directory in a filelist entry, the directory is backed up, but the contents of the directory are not.
- Each path must be specified on a single line. A line can contain only one path.
- Paths must not contain control characters, such as 0x18 (CTRL-X), 0x19 (CTRL-Y) and 0x0A (newline).
- By default, paths must not contain wildcard characters. Do not include asterisk (\*) or question marks (?) in a path. This restriction can be overridden if you enable the option named wildcardsareliteral. For more information about that option, see Wildcardsareliteral.
- **Mac OS X** | **Windows** The filelist can be an MBCS file or a Unicode file with all Unicode entries. For Mac OS X, the filelist can be encoded in the current operating system language or UTF-16.
- If it is set, the client option called quotesareliteral allows quotation marks in a file specification to be interpreted literally, as quotation marks and not as delimiters. For more information about that option, see Quotesareliteral. If quotesareliteral

and wildcards are literal are not set, quotation mark and wildcard processing works as described in the following list:

- If a path or file name contains a space, enclose the entire path in quotation marks (") or single quotation marks ('). For example "C:\My Documents\spreadsheet.xls" or 'C:\My documents\spreadsheet.xls'.
- If a path contains one or more single quotation marks ('), enclose the entire entry in quotation marks ("). If a path contains one or more quotation marks, enclose the entire path in single quotation marks. File list processing does not support paths that include a mix of quotation marks and single quotation marks.

The following examples illustrate the correct and incorrect use of quotation marks and single quotation marks in paths.

This path example contains a single quotation mark, so the path must be enclosed in quotation marks:

```
"/home/gatzby/mydir/gatzby's_report.out"
```

This path example contains quotation marks, so it must be enclosed in single quotation marks:

```
'/home/gatzby/mydir/"top10".out'
```

This path example contains a space character, so it must be enclosed in either quotation marks or single quotation marks:

```
"/home/gatzby/mydir/top 10.out"
```

or

```
'/home/gatzby/mydir/top 10.out'
```

This path example is not supported for filelist processing because it contains unmatched delimiters (" and '):

```
/home/gatzby/mydir/andy's_"top 10" report.out
```

These paths are not supported for filelist processing because they contain wildcard characters:

```
/home/gatzby*  
/home/*/20??.txt
```

- Any IBM Spectrum Protect™ filelist entry that does not comply with these rules is ignored.

**AIX** **Linux** **Mac OS X** **Solaris** **Windows** The following are examples of valid paths in a filelist:

**AIX** **Linux** **Solaris** **Mac OS X**

```
/home/dir/file1  
/usr/tivoli/file2  
/usr/avi/dir1  
/fs1/dir2/file3  
"/fs2/Ha Ha Ha/file.txt"  
"/fs3/file.txt"
```

**Windows**

```
c:\myfiles\directory\file1  
c:\tivoli\mydir\yourfile.doc  
..\notes\avi\dir1  
..\fs1\dir2\file3  
"d:\fs2\Ha Ha Ha\file.txt"  
"d:\fs3\file.txt"
```

To override standard processing of quotation marks and wildcard characters, see `Quotesareliteral` and `Wildcardsareliteral`.

You can use the `filelist` option during an open file support operation. In this case, the client processes the entries in the filelist from the virtual volume instead of the real volume.

If an entry in the filelist indicates a directory, only that directory is processed and not the files within the directory.

If the file name (the `filelistspec`) you specify with the `filelist` option does not exist, the command fails. The client skips any entries in the filelist that are not valid files or directories. The client logs errors and processing continues to the next entry.

**AIX** **Linux** **Solaris** **Mac OS X** Use file specifications with the `restore` and `retrieve` commands to denote the destination for the restored filelist entries. For example, in the following `restore` command, the file specification `/user/record/` represents the restore destination for all entries in the filelist.

```
restore -filelist=/home/dir/file3 /usr/record/
```

**AIX** | **Linux** | **Solaris** | **Mac OS X** However, in the following selective command, the file specification `/usr/record/` is ignored.

```
selective -filelist=/home/dir/file3 /usr/record/
```

**Windows** Use file specifications with the restore and retrieve commands to denote the destination for the restored filelist entries. For example, in the following restore command, `d:\dir\` represents the restore destination for all entries in the filelist.

```
restore -filelist=c:\filelist.txt d:\dir\
```

**Windows** However, in the following selective command, the file specification `d:\dir\` is ignored.

```
selective -filelist=c:\filelist.txt d:\dir\
```

If you specify a directory in a filelist for the delete archive or delete backup command, the directory is not deleted. filelists that you use with the delete archive or delete backup command should not include directories.

The entries in the list are processed in the order they appear in the filelist. For optimal processing performance, pre-sort the filelist by file space name and path.

Note: The client might back up a directory twice if the following conditions exist:

- The filelist contains an entry for the directory
- The filelist contains one or more entries for files within that directory
- No backup of the directory exists

**AIX** | **Linux** | **Solaris** | **Mac OS X** For example, your filelist includes the entries `/home/dir/file1` and `/home/dir`. If the `/dir` directory does not exist on the server, the `/home/dir` directory is sent to the server a second time.

**Windows** For example, your filelist includes the entries `c:\dir0\myfile` and `c:\dir0`. If the `\dir0` directory does not exist on the server, the `c:\dir0` directory is sent to the server a second time.

**AIX** | **Linux** | **Solaris** | **Mac OS X** | **Windows**

## Supported Clients

---

This option is valid for all clients. The IBM Spectrum Protect API does not support this option.

## Syntax

---

```
>>-FILEList = - --filelistspec-----<<
```

## Parameters

---

filelistspec

Specifies the location and name of the file that contains the list of files to process with the command.

Note: When you specify the filelist option on the command line, the subdir option is ignored.

## Examples

---

**AIX** | **Linux** | **Solaris** | **Mac OS X** Command line:

**AIX** | **Linux** | **Solaris** | **Mac OS X** `sel -filelist=/home/avi/filelist.txt`

**Windows** Command line:

**Windows** `sel -filelist=c:\avi\filelist.txt`

## Filename

---

Use the filename option with the query systeminfo command to specify a file name in which to store information.

You can store information gathered from one or more of the following items:

- DSMOPTFILE - The contents of the dsm.opt file.

- **AIX** | **Linux** | **Solaris** | **Mac OS X** | **DSMSYSFILE** - The contents of the dsm.sys file.
- **AIX** | **Linux** | **Solaris** | **Mac OS X** | **Windows** | **ENV** - Environment variables.
- **ERRORLOG** - The IBM Spectrum Protect™ error log file.
- **FILE** - Attributes for the file name that you specify.
- **Windows** | **FILESNOTTOBACKUP** - Enumeration of Windows Registry key:

```
HKEY_LOCAL_MACHINE\
  SYSTEM\
    CurrentControlSet\
      BackupRestore\
        FilesNotToBackup
```

This key specifies those files that back up products should not back up. The query `inclexcl` command indicates that these files are excluded per the operating system.

- **INCLEXCL** - Compiles a list of include-exclude in the order in which they are processed during backup and archive operations.
- **Windows** | **KEYSNOTTORESTORE** - Enumeration of Windows Registry key:

```
HKEY_LOCAL_MACHINE\
  SYSTEM\
    ControlSet001\
      BackupRestore\
        KeysNotToRestore
```

This key specifies those Windows Registry keys that back up products should not restore.

- **Windows** | **MSINFO** - Windows system information (output from MSINFO32.EXE).
- **OPTIONS** - Compiled options.
- **Windows** | **OSINFO** - Name and version of the client operating system.
- **AIX** | **Linux** | **Solaris** | **Mac OS X** | **OSINFO** - Name and version of the client operating system (includes `ULIMIT` information for UNIX and Linux).
- **POLICY** - Policy set dump.
- **Windows** | **REGISTRY** - IBM Spectrum Protect-related Windows Registry entries.
- **SCHEDLOG** - The contents of the schedule log (usually `dsmsched.log`).
- **Windows** | **SFP** - The list of files protected by Windows System File Protection, and for each file, indicates whether that file exists. These files are backed up as part of the `SYSFILES` system object.
- **Windows** | **SFP=*filename*** - Indicates whether the specified file (*filename*) is protected by Windows System File Protection. For example:

```
SFP=C:\WINNT\SYSTEM32\MSVCRT.DLL
```

- **Windows** | **SYSTEMSTATE** - Windows system state information.
- **AIX** | **CLUSTER** - AIX® cluster information.
- **Windows** | **CLUSTER** - Windows cluster information.

Note: The query `systeminfo` command is intended primarily as an aid for IBM® support to assist in diagnosing problems, although users who are familiar with the concepts addressed by this information might also find it useful. If you use the console option, no special formatting of the output is performed to accommodate screen height or width. Therefore, the console output might be difficult to read due to length and line-wrapping. In this case, use the `filename` option with the query `systeminfo` command to allow the output to be written to a file that can subsequently be submitted to IBM support.

**AIX** | **Linux** | **Solaris** | **Mac OS X** | **Windows**

## Supported Clients

---

This option is valid for all clients.

## Syntax

---

```
>>-FILENAME = - --outputfilename----->>
```

## Parameters

---

`outputfilename`

Specifies a file name in which to store the information. If you do not specify a file name, by default the information is stored in the `dsminfo.txt` file.

## Examples

---

Command line:

```
query systeminfo dsmdptfile errorlog -filename=tsminfo.txt
```

## Filesonly

---

The filesonly option restricts backup, restore, retrieve, or query processing to files *only*.

You cannot restore or retrieve directories from the IBM Spectrum Protect™ server when using the filesonly option with the restore or retrieve commands. However, directories with default attributes are created, if required, as placeholders for files that you restore or retrieve.

You can also use the filesonly option with the following commands:

- archive
- incremental
- query archive
- query backup
- restore
- restore backupset
- restore group
- retrieve
- selective

AIX	Linux	Solaris	Mac OS X	Windows
-----	-------	---------	----------	---------

## Supported Clients

---

This option is valid for all clients. The IBM Spectrum Protect API does not support this option.

## Syntax

---

```
>>-FILESOnly-----<<
```

## Parameters

---

There are no parameters for this option.

## Examples

---

AIX	Linux	Solaris	Mac OS X	Windows
-----	-------	---------	----------	---------

Command line:

AIX	Linux	Solaris	Mac OS X	Windows
-----	-------	---------	----------	---------

```
dsmd incremental -filesonly
```

AIX	Linux	Solaris
-----	-------	---------

## Followsymbolic

---

During a backup operation, the followsymbolic option specifies whether you want to use a symbolic link as a virtual mount point. During a restore or retrieve operation, the followsymbolic option specifies how the backup-archive client restores a directory whose name matches a symbolic link on the restore target file system.

For backup operations, the followsymbolic option can influence the virtualmountpoint option setting. If you use the virtualmountpoint option to specify a symbolic link as a virtual mount point, you must also set the followsymbolic option.

During restore and retrieve operations, followsymbolic can influence how the client handles a symbolic link on the file system. Set followsymbolic only when the client attempts to restore a directory whose name matches a symbolic link on the restore target file system.

If you specify `followsymbolic=no` (the default), the client does not restore the contents of the directory, but returns this error message:

ANS4029E Error processing 'filesystem name path-name file-name':  
unable to build a directory path; a file exists with the same name  
as a directory.

If you specify `followsymbolic=yes`, the client restores the contents of the directory to the target of the symbolic link.

For example, assume the client backed up a file with this path: `/fs1/dir1/subdir1/file1`. Assume also that a symbolic link `/fs1/dir1`, that exists on the restore target file system, links to the directory `/fs88/dir88/subdir88`. Restore the file with the command:

```
restore /fs1/dir1/subdir1/file1
```

If you specify `followsymbolic=no`, the client does not restore the file, but returns the preceding error message. If you specify `followsymbolic=yes`, the client restores `file1` to the `/fs88/dir88/subdir88/subdir1/file1` directory.

If you restore a symbolic link (not a directory) whose name matches a symbolic link on the restore target file system, the client restores the symbolic link.

If a symbolic link is used as a virtual mount point, the path to the link target must be specified by using an absolute file path.

Use this option with the `restore` and `retrieve` commands, or in the client user-options file (`dsm.opt`).

---

## Supported Clients

This option is valid for all UNIX clients except Mac OS X.

---

## Options File

Place this option in the client options file (`dsm.opt`).

---

## Syntax

```
                .-No--.  
>>-FOLlowsymbolic-----<<  
                '-Yes-'
```

---

## Parameters

No

Do not back up a virtual mount point that is a symbolic link. Do not restore a directory if the restore target file system contains a symbolic link with matching name. This is the default.

Yes

Restore the contents of a directory to the target of a symbolic link.

---

## Examples

Options file:

```
followsymbolic Yes
```

Command line:

```
-fol=Yes
```

---

## Forcefailover

The `forcefailover` option enables the client to immediately fail over to the secondary server.

You can use the `forcefailover` option to immediately connect to the secondary server, even if the primary server is still online. For example, you can use this option to verify that the backup-archive client is failing over to the expected secondary server.

Do not edit this option during normal operations.

---

## Supported Clients

This option is valid for all clients.



## Options File

---

**AIX** | **Linux** | **Solaris** | **Mac OS X** Place this option in the client-system options file (dsm.sys).

**Windows** Place this option in the client options file (dsm.opt).

## Syntax

---

```
>>-FORCEFAILOVER-----><
      .-No--
      |-----|
      '-Yes-'
```

## Parameters

---

Yes

Specifies that the client immediately connects to the secondary server.

No

Specifies that the client fails over to the secondary server during the next logon if the primary server is unavailable. This value is the default.

## Examples

---

Options file:

```
FORCEFAILOVER yes
```

Command line:

```
-FORCEFAILOVER=yes
```

### Related concepts:

Automated client failover configuration and use

### Related tasks:

Configuring the client for automated failover

## Fromdate

---

Use the fromdate option with the fromtime option to specify a date and time from which you want to search for backups or archives during a restore, retrieve, or query operation.

Files that were backed up or archived before this date and time are not included, although older directories might be included, if necessary, to restore or retrieve the files.

Use the fromdate option with the following commands:

- delete backup
- query archive
- query backup
- restore
- restore group
- retrieve

**AIX** | **Linux** | **Solaris** | **Mac OS X** | **Windows**

## Supported Clients

---

This option is valid for all clients. The IBM Spectrum Protect™ API does not support this option.

## Syntax

---

```
>>-FROMDate = - --date-----><
```

## Parameters

---

date

Specifies the date from which you want to search for backup copies or archived files. Enter the date in the format you selected with the dateformat option.

When you include dateformat with a command, it must precede the fromdate, pitdate, and todate options.

## Examples

```
Mac OS X Command line:
Mac OS X dsmc query backup -fromdate=12/11/2003 "/Users/van/Documents/*"
AIX Linux Solaris Mac OS X Command line:
AIX Linux Solaris Mac OS X dsmc query backup -fromdate=12/11/2003 /home/dilbert/*
Windows Command line:
Windows dsmc query backup -fromdate=12/11/2003 c:\Windows\Program Files\*.exe
```

## Fromnode

The fromnode option permits one node to perform commands for another node. A user on another node must use the set access command to permit you to query, restore, or retrieve files for the other node.

Use the fromnode option with the following commands:

- query archive
- query backup
- query filespace
- Windows query group
- AIX Linux Solaris query image
- query mgmtclass
- restore
- restore group
- AIX Linux Solaris Windows restore image
- retrieve

```
AIX Linux Solaris Mac OS X Windows
```

## Supported Clients

This option is valid for all clients.

## Syntax

```
>>-FROMNode = - --node-----<<
```

## Parameters

node

Specifies the node name on a workstation or a file server whose backup copies or archived files you want to access.

## Examples

```
Mac OS X Command line:
Mac OS X dsmc query archive -fromnode=bob -subdir=yes "/Users/van/Documents/*"
AIX Linux Solaris Mac OS X Command line:
AIX Linux Solaris Mac OS X dsmc query archive -fromnode=bob -subdir=yes "/home/jones/*"
Windows Command line:
Windows dsmc query archive -fromnode=bob -subdir=yes d:\
```

Windows Note: The backup-archive client can use file space information when restoring files. The file space information can contain the name of the computer from which the files were backed up. If you restore from another backup-archive client node and do not specify a destination for the restored files, the client uses the file space information to restore the files. In such a case,

the client attempts to restore the files to the file system on the original computer. If the restoring computer has access to the file system of the original computer, you can restore files to the original file system. If the restoring computer can not access the file system of the original computer, the client can return a network error message. If you want to restore the original directory structure but on a different computer, specify only the target file system when you restore. This is true when restoring files from another node and when retrieving files from another node.

AIX Linux Solaris Mac OS X

## Fromowner

---

The `fromowner` option specifies an alternate owner from which to restore backup versions or archived files or images. The owner must give access to another to use the files or images.

For example, to restore files from the `/home/devel/proja` directory belonging to `usermike` on system **puma**, and place the restored files in a directory you own named `/home/id/proja`, enter the following command:

```
dsmc restore -fromowner=usermike -fromnode=puma /home/devel/proja/  
/home/id/proja/
```

**Mac OS X** Note: Archiving image restores does not apply to Mac OS X operating systems.

Non-root users can specify `fromowner=root` to access files owned by the root user if the root user has granted them access.

**Note:** If you specify the `fromowner` option without the `fromnode` option, the active user must be on the same node as the `fromowner` user.

Use the `fromowner` option with the following commands:

- query archive
- query backup
- query group
- query image
- restore
- restore image
- restore group
- retrieve

## Supported Clients

---

This option is valid for all UNIX and Linux clients.

## Syntax

---

```
>>-FROMOwner = - --owner-----><
```

## Parameters

---

`owner`  
Name of an alternate owner.

## Examples

---

Command line:  
`dsmc query archive "/home/id/proja/*" -fromowner=mark`

## Fromtime

---

Use the `fromtime` option with the `fromdate` option to specify a beginning time from which you want to search for backups or archives during a restore, retrieve, or query operation.

The backup-archive client ignores this option if you do not specify the `fromdate` option.

Use the fromtime option with the following commands:

- delete backup
- query archive
- query backup
- restore
- restore group
- retrieve

AIX Linux Solaris Mac OS X Windows

## Supported Clients

---

This option is valid for all clients. The IBM Spectrum Protect™ API does not support this option.

## Syntax

---

```
>>-FROMTime = - --time-----<<
```

## Parameters

---

time

Specifies a beginning time on a specific date from which you want to search for backed up or archived files. If you do not specify a time, the time defaults to 00:00:00. Specify the time in the format you selected with the timeformat option.

When you include the timeformat option in a command, it must precede the fromtime, pittime, and totime options.

## Examples

---

AIX Linux Solaris Mac OS X Command line:

```
AIX Linux Solaris Mac OS X dsmc q b -timeformat=4 -fromt=11:59AM -fromd=06/30/2003 -  
tot=11:59PM -tod=06/30/2003 /home/*
```

Windows Command line:

```
Windows dsmc q b -timeformat=4 -fromt=11:59AM -fromd=06/30/2003 -tot=11:59PM -tod=06/30/2003  
c:\*
```

## Groupname

---

Use the groupname option with the backup group command to specify the name for a group. You can only perform operations on new groups or the current active version of the group.

AIX Linux Solaris Windows

## Supported Clients

---

AIX Linux Solaris This option is valid for all UNIX and Linux clients except Mac OS X.

Windows This option is valid for all Windows clients.

## Syntax

---

```
>>-GROUPName = - --name-----<<
```

## Parameters

---

name

Specifies the name of the group which contains the files backed up using the filelist option. Directory delimiters are not allowed in the group name since the group name is not a file specification, but a name field.

## Examples

---

Command line:

AIX Linux Solaris

```
backup group -filelist=/home/dir1/filelist1 -groupname=group1  
-virtualfsname=/virtfs -mode=full
```

Windows

```
backup group -filelist=c:\dir1\filelist1 -groupname=group1  
-virtualfsname=\virtfs -mode=full
```

AIX Linux Solaris Mac OS X

## Groups (deprecated)

---

This option is deprecated.

Linux Windows

## Host

---

The host option specifies the target ESX server location where the new virtual machine is created during a VMware restore operation.

Use this option on restore vm commands to specify the ESX host server to restore the data to.



This feature is available only if the client operates as a data mover for IBM Spectrum Protect™ for Virtual Environments: Data Protection for VMware.

## Example

---

Restore the virtual machine to the ESX server named vmesxbld1.

```
restore vm -host=vmesxbld1.us.acme.com
```

## Httpport

---

The httpport option specifies a TCP/IP port address for the web client.

AIX Linux Solaris Mac OS X Windows

## Supported Clients

---

This option is valid for all clients. The IBM Spectrum Protect™ API does not support this option.

## Options File

---

AIX Linux Solaris Mac OS X

Place this option in the client system-options file (dsm.sys) within a server stanza. You can set this option on the Web Client tab, in the HTTP Port field of the Preferences editor.

Windows

Place this option in the client system options file (dsm.opt). You can set this option on the Web Client tab, in the HTTP Port field of the Preferences editor.

## Syntax

---

```
>>-HTTPport-- --port_address-----<<
```

## Parameters

---

port\_address

Specifies the TCP/IP port address that is used to communicate with the web client. The range of values is 1000 through 32767; the default is 1581.

## Examples

---

Options file:

```
httpport 1502
```

**Windows** Command line:

**Windows**

```
-httpport=1502
```

**AIX** | **Linux** | **Solaris** | **Mac OS X** Command line:

**AIX** | **Linux** | **Solaris** | **Mac OS X** Does not apply.

## Hsmreparsetag

---

The hsmreparsetag option specifies a unique reparse tag that is created by an HSM product installed on your system.

Many HSM products use reparse points to retrieve or recall migrated files. After a file is migrated, a small stub file, with the same name as the original file, is left on the file system. The stub file is a reparse point that triggers a recall of the original file when a user or application accesses the stub file. The reparse point includes a unique identifier called a *reparse tag* to identify which HSM product migrated the file.

If the IBM Spectrum Protect™ backup-archive client does not recognize the reparse tag in a stub file, the Backup-Archive Client causes the HSM product to recall the original file. You can prevent files from being recalled if you specify the reparse tag with the hsmreparsetag option.

The backup-archive client recognizes the reparse tag of HSM products from the following companies:

- International Business Machines Corp.
- Wisdata System Co. Ltd.
- BridgeHead Software Ltd.
- CommVault Systems, Inc.
- Data Storage Group, Inc.
- Enigma Data Solutions, Ltd.
- Enterprise Data Solutions, Inc.
- Global 360
- GRAU DATA AG
- Hermes Software GmbH
- Hewlett Packard Company
- International Communication Products Engineering GmbH
- KOM Networks
- Memory-Tech Corporation
- Moonwalk Universal
- Pointsoft Australia Pty. Ltd.
- Symantec Corporation

If the HSM product you use is not in the preceding list, use the hsmreparsetag option to specify the reparse tag. Ask your HSM product vendor for the reparse tag used by the product.

## Supported clients

---

This option is valid for all Windows clients.

## Option file

---

Place this option in the client options file (dsm.opt).

## Syntax

---

```
>>----HSMREPARSETAG----reparse_tag_value-----<<
```

## Parameters

---

reparse\_tag\_value

A decimal (base 10) or hexadecimal (base 16) value that specifies the reparse tag.

## Examples

---

Options file:

Specify an HSM reparse tag in decimal format:

```
hsmreparsetag 22
```

Specify an HSM reparse tag in hexadecimal format:

```
hsmreparsetag 0x16
```

Command line:

Does not apply.

## Ieobjtype

---

Use the `ieobjtype` option to specify an object type for a client-side data deduplication operation within include-exclude statements.

The `ieobjtype` option is an additional parameter to the `include.dedup` or `exclude.dedup` options.

## Supported Clients

---

This option is valid for all clients. The IBM Spectrum Protect™ API also supports this option.

## Options File

---

**AIX** | **Linux** | **Solaris** | **Mac OS X** Place this option in the system-options file (`dsm.sys`). You can set this option on the Include/Exclude tab of the Preferences editor. The option can be set in the client option set on the IBM Spectrum Protect server.

**Windows** Place this option in the client options file (`dsm.opt`). You can set this option on the Include/Exclude tab of the Preferences editor. The option can be set in the client option set on IBM Spectrum Protect server.

## Syntax

---

```
.-File-----.  
>>-IEObjtype--+-Image-----+----->>  
+-SYSTEMState-+  
'-Asr-----'
```

## Parameters

---

File

Specifies that you want to include files for, or exclude files from, client-side data deduplication processing. File is the default.

Image

Specifies that you want to include images for, or exclude images from, client-side data deduplication processing.

**Windows** System State

**Windows** Specifies that you want to include system state for, or exclude system state from, client-side data deduplication processing.

**Windows** Asr

**Windows** Specifies that you want to include automatic system recovery objects for, or exclude ASR objects from, client-side data deduplication processing.

## Examples

---

Options file:

Windows	exclude.dedup e:\*\* ieobjtype=image			
AIX	Linux	Mac OS X	Solaris	exclude.dedup /home/*/* ieobjtype=image

Command line:

Does not apply.

### Related reference:

Exclude options

Include options

## Ifnewer

---

The ifnewer option replaces an existing file with the latest backup version only if the backup version is newer than the existing file.

Only active backups are considered unless you also use the inactive or latest options.

**Note:** Directory entries are replaced with the latest backup version, whether the backup version is older or newer than the existing version.

Use the ifnewer option with the following commands:

- restore
- restore backupset
- restore group
- retrieve

Note: This option is ignored if the replace option is set to No.

## Supported Clients

---

This option is valid for all clients. The IBM Spectrum Protect™ API does not support this option.

## Syntax

---

```
>>-IFNewer-----<<
```

## Parameters

---

There are no parameters for this option.

## Examples

---

AIX	Linux	Mac OS X	Solaris	Command line:				
AIX	Linux	Mac OS X	Solaris	Mac OS X	dsmc restore "/Users/grover/Documents/*" -sub=y -rep=y -ifnewer			
AIX	Linux	Mac OS X	Solaris	AIX	Linux	Mac OS X	Solaris	dsmc restore "/home/grover/*" -sub=y -rep=y -ifnewer
Windows	Command line:							
Windows	dsmc restore -ifnewer d:\logs\*.log							
AIX	Linux	Windows						

## Imagegapsize

---

Use the imagegapsize option with the backup image command, in the options file, or with the include.image option to specify the minimum size of empty regions on a volume that you want to skip during image backup.

Use this option for LAN-based and LAN-free image backup.



For example, if you specify a gap size of 10, this means that an empty region on the disk that is larger than 10 KB in size is not backed up. Gaps that are exactly 10 KB are backed up. Empty regions that are exactly 10 KB and that are smaller than 10 KB are backed up, even though they do not contain data. However, an empty region that is smaller than 10 KB is backed up, even though it does not contain data. A smaller image gap size means less data needs to be transferred, but with potentially decreased throughput. A larger image gap size results in more data being transferred, but with potentially better throughput.

**Windows** Place the `include.image` statement containing the `imagegapsize` value in your `dsm.opt` file.

## Supported Clients

**AIX** **Linux** This option is valid for AIX®, Linux, and JFS2 clients only. The IBM Spectrum Protect™ API does not support this option.

**Windows** This option is valid for all Windows clients. The IBM Spectrum Protect API does not support this option.

## Options File

**AIX** Place this option in the server stanza of the client systems options file (`dsm.sys`), or in the `include.image` statement in the `dsm.sys` file.

**Windows** Place this option in the client options file (`dsm.opt`).

## Syntax

```
>>-IMAGEGapsize-- --size----->>
```

## Parameters

**AIX** `size`

**AIX** Specifies the minimum size of empty regions in an AIX JFS2 file system that should be skipped during an image backup. You can specify `k` (kilobytes) `m` (megabytes) or `g` (gigabytes) qualifiers with the value. Without a qualifier, the value is interpreted in kilobytes. Valid values are 0 through 4294967295 KB. If you specify a value of 0, all blocks, including unused blocks at the end of the volume, is backed up. If you specify any value other than 0, unused blocks at the end of the volume are not backed up. For LAN-based and LAN-free image backup the default value is 32 KB. This option is applicable to both static and snapshot-based image backup.

Note: This option is valid for AIX JFS2 file systems. If you specify an `imagegapsize` that is greater than 0 for a file system other than AIX JFS2, you get a warning message.

**Windows** `size`

**Windows** Specifies the minimum size of empty regions in a formatted logical volume that should be skipped during an image backup. You can specify `k` (kilobytes) `m` (megabytes) or `g` (gigabytes) qualifiers with the value. Without a qualifier, the value is interpreted in KB. Valid values are 0 through 4294967295 KB. If you specify a value of 0, all blocks, including unused blocks at the end of the volume, is backed up. If you specify any value other than 0, unused blocks at the end of the volume are not backed up. For LAN-based and LAN-free image backup the default value is 32 KB.

Note: Because of operating system limitations, use this option for NTFS file systems only. If you specify an `imagegapsize` that is greater than 0 for a file system other than NTFS, you get a warning message.

## Examples

**AIX** Options file:

**AIX** Add the following to the server stanza in the `dsm.sys` file: `imagegapsize 1m`

Include-exclude list example: `include.image /kalafs1 imagegapsize=-128k`

**Windows** Options file:

**Windows** `imagegapsize 1m`

Include-exclude list example: `include.image h: MYMC imagegapsize=1m`

Command line:

`-imagegapsize=64k`

**AIX** **Linux** **Solaris** **Windows**

## Imagetofile

---

Use the `imagetofile` option with the `restore image` command to specify that you want to restore the source image to a file.

You might need to restore the image to a file if bad sectors are present on the target volume, or if you want to manipulate the image data. Later, you can use a data copy utility of your choice to transfer the image from the file to a disk volume.

**Linux** Linux supports mounting an image file as a logical volume, so you can get access to file data within the image. The following are some examples:

**AIX** | **Linux** | **Solaris**

- The file system `/usr` has been backed up by the backup-archive client. The following command restores the file system image to the file `/home/usr.img`:

```
# dsmc restore image /usr /home/usr.img -imagetofile
```

- To mount the image file at the `/mnt/usr` directory, the following mount command can be executed:

```
# mount /home/usr.img /mnt/usr -o loop=/dev/loop0
```

**AIX** | **Linux** | **Solaris**

Now the image contents are available from `/mnt/usr` as if a regular file system was mounted at that directory.

## Supported Clients

---

**AIX** | **Linux** | **Solaris**

This option is valid only for AIX®, Oracle Solaris, and all Linux clients. The IBM Spectrum Protect™ API does not support this option.

**Windows**

This option is valid for all Windows clients. The IBM Spectrum Protect API does not support this option.

## Syntax

---

```
>>-IMAGETOfile-----<<
```

## Parameters

---

There are no parameters for this option.

## Examples

---

**AIX** | **Linux** | **Solaris**

Command line:

**AIX** | **Linux** | **Solaris**

```
dsmc restore image /usr /home/usr.img -imagetofile
```

**Windows**

Command line:

**Windows**

```
dsmc restore image d: e:\diskD.img -imagetofile
```

## Inactive

---

Use the `inactive` option to display both active and inactive objects.

You can use the `inactive` option with the following commands:

- delete group
- **Windows** query asr
- query backup
- **AIX** | **Linux** | **Solaris** | **Mac OS X** query group
- **AIX** | **Linux** | **Solaris** | **Windows** query image
- **AIX** | **Linux** | **Solaris** | **Mac OS X** | **Windows** query nas
- **Windows** query systemstate
- **Windows** query vm (vmbackuptype=fullvm and vmbackuptype=hypervfull)
- restore
- **AIX** | **Linux** | **Solaris** | **Mac OS X** | **Windows** restore group

- **AIX** | **Linux** | **Solaris** | **Windows** restore image
- **AIX** | **Linux** | **Solaris** | **Mac OS X** | **Windows** restore nas
- **Windows** restore vm (vmbackuptype=fullvm and vmbackuptype=hypervfull)

**AIX** | **Linux** | **Solaris** | **Mac OS X** | **Windows** Important: When using the inactive option during a restore operation, also use the pick or some other filtering option because, unlike the latest option, all versions are restored in an indeterminate order. This option is implicit when pitdate is used.

## Supported Clients

This option is valid for all clients. The IBM Spectrum Protect™ API does not support this option.

## Syntax

```
>>-INActive-----<<
```

## Parameters

There are no parameters for this option.

## Examples

**Mac OS X** Command line:  
**Mac OS X** dsmc restore "/Users/zoe/Documents/\*" -inactive -pick

**AIX** | **Linux** | **Solaris** | **Mac OS X** Command line:  
**AIX** | **Linux** | **Solaris** | **Mac OS X** dsmc restore "/home/zoe/\*" -inactive -pick

**Windows** Command line:  
**Windows** dsmc restore -inactive c:\id\projecta\ -pick

## Inclxcl

The inclxcl option specifies the path and file name of an include-exclude options file.

Multiple inclxcl statements are permitted. However, you must specify this option for each include-exclude file.

**Windows** Ensure that you store your include-exclude options file in a directory to which all users have read access.

**AIX** | **Linux** | **Solaris** | **Mac OS X** Ensure that you store your include-exclude options file in a directory to which all users have read access, such as /etc.

When processing occurs, the include-exclude statements within the include-exclude file are placed in the list position occupied by the inclxcl option, in the same order, and processed accordingly.

**AIX** | **Linux** | **Solaris** | **Mac OS X** If you have the HSM client installed on your workstation, you can use an include-exclude options file to exclude files from backup and space management, from backup only or from space management only.

**AIX** | **Linux** | **Solaris** | **Mac OS X** | **Windows**

## Supported Clients

This option is valid for all clients. The server can also define this option.

## Options File

**AIX** | **Linux** | **Solaris** | **Mac OS X** Place this option in the dsm.sys file *within* a server stanza. You can set this option on the Include-Exclude tab of the Preferences editor.

**Windows** Place this option in the client options file (dsm.opt). You can set this option on the Include-Exclude tab of the Preferences editor.

## Syntax

```
>>-INCLExcl-- --filespec-----><
```

## Parameters

---

filespec

Specifies the path and file name of *one* include-exclude options file.

## Examples

---

Options file:

**Mac OS X**  
INCLExcl /Users/user1/Documents/backup.excl

**AIX** | **Linux** | **Solaris** | **Mac OS X**  
inclxcl /usr/dsm/backup.excl  
inclxcl /etc/inclxcl.def

**Windows**  
inclxcl c:\dsm\backup.excl

Command line:

Does not apply.

- Considerations for Unicode-enabled clients  
An include-exclude file can be in Unicode or non-Unicode format.

## Include options

---

The include options specify objects that you want to include for backup and archive services.

The include options specify any of the following:

- **Mac OS X** Objects within a broad group of excluded objects that you want to include for backup and archive services.
- **AIX** | **Linux** | **Solaris** Objects within a broad group of excluded objects that you want to include for backup, archive, image, and space management services.
- **Windows** Objects within a broad group of excluded objects that you want to include for backup, archive, and image services.
- Files that are included for backup or archive processing that you want to include for encryption processing.
- Files that are included for backup or archive processing that you also want to include for compression processing.
- Objects to which you want to assign a specific management class.
- A management class to assign to all objects to which you do not explicitly assign a management class.
- File spaces to which you want to assign memory-efficient backup processing
- File spaces where you want to use the diskcachelocation option to cause specific file systems to use different, specific locations for their disk cache.

If you do not assign a specific management class to objects, the default management class in the active policy set of your policy domain is used. Use the query mgmtclass command to display information about the management classes available in your active policy set.

**Windows** You can include remotely accessed files by specifying Universal Naming Convention (UNC) names in your include statement.

Remember: The backup-archive client compares the files it processes against the patterns specified in the include-exclude statements, reading from the bottom to the top of the options file.

Note:

1. **Windows** The exclude.dir statement overrides all include statements that match the pattern.
2. **AIX** | **Linux** | **Solaris** | **Mac OS X** The exclude.fs and exclude.dir statements override all include statements that match the pattern.
3. **Windows** The include statements are not case-sensitive.
4. The server can also define these options with the inclxcl option.

## Supported Clients

This option is valid for all clients. The server can also define include.fs.nas.

## Options File

**AIX** **Linux** **Solaris** **Mac OS X** Place this option in the client system-options file (dsm.sys) within a server stanza. You can set these options on the Include-Exclude tab in the Preferences editor.

**Windows** Place these options in the client options file (dsm.opt). You can set these options on the Include-Exclude tab in the Preferences editor.

## Syntax

```
>>-options-- --pattern-- +-----+-----><
                          '- --optional_parameter-'
```

include, include.backup, include.file

Use these options to include files or assign management classes for backup processing.

The include option affects archive and backup processing. If you want to assign different management classes for archive and backup processing, always specify include.archive and include.backup with their own management classes. In this example, the `archmc` management class is assigned when an archive operation is performed. The management class is assigned when an archive operation is performed because include.backup is used only for backup processing, and not for archive processing.

```
include.archive /home/test/* archmc
include.backup /home/test/*
```

**Windows**

```
include.archive c:\test\*\ archmc
include.backup c:\test\*
```

include.archive

Includes files or assigns management classes for archive processing.

**Mac OS X** **AIX** **Linux** **Solaris** **Mac OS X** include.attribute.symlink  
**Mac OS X** **AIX** **Linux** **Solaris** **Mac OS X**

Includes a file or a group of files that are symbolic links or aliases, within a broad group of excluded files for backup processing only.

**Mac OS X** Note: For Mac OS X, aliases are included.

include.compression

Includes files for compression processing if you set the compression option to yes. This option applies to backups and archives.

**AIX** **Linux** **Solaris** **Mac OS X** **Windows** include.dedup

**AIX** **Linux** **Solaris** **Mac OS X** **Windows** Includes files for client-side data deduplication. To control a client-side data deduplication operation, specify `ieobjtype` as the value of the include.dedup option. By default, all data deduplication-eligible objects are included for client-side data deduplication.

Valid `ieobjtype` parameters are:

- File
- Image
- **Windows** SYSTEMState
- **Windows** Asr

The default is File.

include.encrypt

Includes the specified files for encryption processing. By default, the client does not perform encryption processing.

Notes:

1. The include.encrypt option is the only way to enable encryption on the backup-archive client. If no include.encrypt statements are used, encryption does not occur.

- Encryption is not compatible with client-side deduplication. Files that are included for encryption are not deduplicated by client-side deduplication.
- Encryption is not compatible with VMware virtual machine backups that use the incremental forever backup modes (MODE=IFIncremental and MODE=IFFull). If the client is configured for encryption, you cannot use incremental forever backup.
- Encryption is not compatible with the IBM Spectrum Protect™ for Virtual Environments Data Protection for VMware Recovery Agent. If the client is configured for encryption, you can use the client to restore backups that were created with the full or incremental backup modes (MODE=Full and MODE=Incremental). However, you cannot use the Recover Agent to restore the encrypted backups. Backups that were created with the full or incremental mode were created with the version 7.1 or earlier client.

AIX	Linux	Solaris	include.fs
AIX	Linux	Solaris	

**AIX** For AIX® JFS2 file systems: Use the snapshotcachesize option in the dsm.sys file or with the include.fs option, to specify an appropriate snapshot size so that all old data blocks can be stored while the snapshot-based file backup or archive occurs.

To control how the client processes your file space for incremental backup, you can specify these additional options in your dsm.sys file, as values of the include.fs option: diskcachelocation and memoryefficientbackup.

Each of the include.fs, memoryefficientbackup and diskcachelocation options must be on the same line in the options file.

```
include.fs /home
    memoryefficientbackup=diskcachemethod
    diskcachelocation=/usr
include.fs /usr
    memoryefficientbackup=diskcachemethod
    diskcachelocation=/home
include.fs /Volumes/hfs3
    memoryefficientbackup=diskcachemethod
    diskcachelocation=/Volumes/hfs2
AIX JFS2 filesystems only: include.fs
    /kalafsl snapshotproviderfs=JFS2
```

If these options appear both in the options file and an include.fs option, the include.fs values are used for the specified file space in place of any values in an option file or on the command line.

Windows	include.fs
---------	------------

**Windows** If open file support has been configured, the client performs a snapshot backup or archive of files that are locked (or in use) by other applications. The snapshot allows the backup to be taken from a point-in-time copy that matches the file system at the time the snapshot is taken. Subsequent changes to the file system are not included in the backup. You can set the snapshotproviderfs parameter of the include.fs option to none to specify which drives do not use open file support.

To control how the client processes your file space for incremental backup, you can specify these additional options in your dsm.opt file as values of the include.fs option: diskcachelocation and memoryefficientbackup.

```
include.fs d: memoryefficientbackup=diskcachem
    diskcachelocation=e:\temp
include.fs e: memoryefficientbackup=diskcachem
    diskcachelocation=c:\temp
```

If these options appear both in the options file and an include.fs option, the include.fs values are used for the specified file space in place of any values in an option file or on the command line.

AIX	Solaris	include.fs.nas
-----	---------	----------------

**AIX** **Solaris** Use the include.fs.nas option to bind a management class to Network Attached Storage (NAS) file systems. You can also specify whether the client saves Table of Contents (TOC) information during a NAS file system image backup, using the toc option with the include.fs.nas option in your dsm.sys file. This option is only valid for AIX and Solaris clients.

Windows	include.fs.nas
---------	----------------

**Windows** Use the include.fs.nas option to bind a management class to Network Attached Storage (NAS) file systems. You can also specify whether the client saves Table of Contents (TOC) information during a NAS file system image backup, using the toc option with the include.fs.nas option in your client options file (dsm.opt).

AIX	Linux	Solaris	include.image
-----	-------	---------	---------------

**AIX** **Linux** **Solaris** Includes a file space or logical volume, or assigns a management class when used with the backup image command. The backup image command ignores all other include options.

**Linux** For Linux x86\_64 clients: Use the snapshotcachesize option in these situations:

- With the backup image command
- In the dsm.sys file
- With the include.image option

Using the snapshotcachesize option in these situations lets you specify an appropriate snapshot size, so that all old data blocks can be stored while the image backup occurs.

A snapshot size of 100 percent ensures a valid snapshot.

**AIX** For AIX JFS2 file systems: Use the snapshotcachesize option in these situations:

- With the backup image command
- In the dsm.sys file
- With the include.image option

Using the snapshotcachesize option in these situations lets you specify an appropriate snapshot size, so that all old data blocks can be stored while the image backup occurs.

**AIX** **Linux** **Solaris** This option is valid for AIX, Linux, and Oracle Solaris clients.

**Windows** include.image

**Windows** Includes a file space or logical volume, or assigns a management class when used with the backup image command. The backup image command ignores all other include options.

By default, the client performs an offline image backup. To enable and control an online image operation, you can specify these options in your dsm.opt file as values of the include.image option: snapshotproviderimage, presnapshotcmd, postsnapshotcmd.

**Windows** include.systemstate

**Windows** This option binds system state backups to the specified management class. If you specify this option, specify all as the pattern. If you do not specify this option system state backups are bound to the default management class.

## Parameters

---

pattern

Specifies the objects to include for backup or archive processing or to assign a specific management class.

**AIX** **Linux** **Solaris** Note: For NAS file systems: You must prefix the NAS node name to the file specification to specify the file server to which the include statement applies. If you do not specify a NAS node name, the file system identified refers to the NAS node name specified in the client system-options file (dsm.sys) or on the command line.

**Windows** Note: For NAS file systems: You must prefix the NAS node name to the file specification to specify the file server to which the include statement applies. If you do not specify a NAS node name, the file system identified refers to the NAS node name specified in the client options file (dsm.opt) or on the command line.

If the pattern begins with a single or double quotation mark, or contains any embedded blanks or equal signs, you must surround the value in either single (') or double (") quotation marks. The opening and closing quotation marks must be the same type of quotation marks.

**AIX** **Linux** **Solaris** For the include.image option, the pattern is the name of a mounted file system or raw logical volume.

**Windows** For the include.image option, the pattern is the name of a file system or raw logical volume.

**Windows**  
Note: When you specify include.systemstate, the only valid pattern is all.

## optional\_parameter

---

management\_class\_name

Specifies the name of the management class to assign to the objects. If a management class is not specified, the default management class is used. To associate a management class with a backup group on an include statement, use the following syntax:

**AIX** **Linux** **Mac OS X** **Solaris**

```
include virtual_filespace_name\group_name management_class_name
```

**Windows**

```
include virtual_filespace_name/group_name management_class_name
```

where:

*virtual\_filespace\_name*

Specifies the name of the IBM Spectrum Protect server virtual filespace that you associated with the group, on the Backup Group command.

*group\_name*

Is the name of the group that you created when you ran the Backup Group command.

*management\_class\_name*

Is the name of the management class to associate with the files in the group.

For example, a group named MyGroup is stored in a virtual file space called MyVirtualFileSpace. To associate a management class, named TEST, with the group, use the following syntax:

```
include MyVirtualFileSpace/MyGroup TEST
```

```
include MyVirtualFileSpace/MyGroup TEST
```

**Windows**

```
include MyVirtualFileSpace\MyGroup TEST
```

Table 1. Other optional parameters

optional_parameter	Use with option
ieobjtype	include.dedup
memoryefficientbackup	include.fs
diskcachelocation	include.fs
<b>AIX</b> <b>Linux</b> <b>Solaris</b> dynamicimage	<b>AIX</b> <b>Linux</b> <b>Solaris</b> include.image
<b>AIX</b> <b>Linux</b> <b>Windows</b> postsnapshotcmd	<b>AIX</b> <b>Linux</b> <b>Windows</b> include.image
<b>AIX</b> <b>Linux</b> <b>Windows</b> presnapshotcmd	<b>AIX</b> <b>Linux</b> <b>Windows</b> include.image
<b>AIX</b> <b>Linux</b> snapshotcachesize	<b>AIX</b> <b>Linux</b> include.image
<b>AIX</b> <b>Windows</b> snapshotproviderfs	<b>AIX</b> <b>Windows</b> include.image
<b>AIX</b> <b>Linux</b> <b>Windows</b> snapshotproviderimage	<b>AIX</b> <b>Linux</b> <b>Windows</b> include.image

## Examples

---

Options file:

```
AIX Linux Solaris
include /home/proj/text/devel.*
include /home/proj/text/* textfiles
include * managall
include /WAS_ND_NDNODE mgmtclass
include /WAS_APPNODE mgmtclass
include.image /home
include.archive /home/proj/text/
* myarchiveclass
include.backup /home/proj/text/
* mybackupclass
include.compression /home/proj/text/
devel.*
include.encrypt /home/proj/gordon/*
include.fs.nas netappsj/vol/vol0
homemgmtclass
```

```
AIX Linux Mac OS X Solaris
```



```
include.dedup /Users/Administrator/Documents/Important/.../*
```

#### AIX

AIX only:

```
include.image /home
  MGMTCLASSNAME
  snapshotproviderimage=JFS2
  snapshotcachesize=40
include.image /home
  snapshotproviderimage=NONE
include.fs /kalafs1
  snapshotproviderfs=JFS2
```

#### Linux

LINUX only:

```
include.image /home
  snapshotproviderimage=LINUX_LVM
include.image /myfs1 dynamicimage=yes
include.image /home MGMTCLASSNAME
  snapshotproviderimage=NONE
include.image /myfs1 dynamicimage=yes
include.attribute.symlink /home/spike/.../*
include.fs /usr
  memoryefficientbackup=diskcachemethod
```

#### Windows

Windows only:

```
include c:\proj\text\devel.*
include c:\proj\text\* textfiles
include ?:\* managall
include WAS_ND_NDNODE mgmtclass
include WAS_APPNODE mgmtclass
include.backup c:\win98\system\* mybackupclass
include.archive c:\win98\system\* myarchiveclass
include.encrypt c:\win98\proj\gordon\*
include.compress c:\test\file.txt

include.image h: MGMTCLASSNAME
  snapshotproviderimage=vss

include.image x:
  snapshotproviderimage=none
include.image y:
  snapshotproviderimage=vss
include.image z: MGMTCLASSNAME
  snapshotproviderimage=none
include.fs c:
  snapshotproviderfs=vss

include.systemstate ALL mgmtc3
include.dedup c:\Users\Administrator\Documents\Important\...*\*
include.dedup e:\*\* ieobjtype=image
include.dedup ALL ieobjtype=systemstate
include.dedup ALL ieobjtype=ASR
```

#### Windows

To encrypt all files on all drives:

```
include.encrypt ?:\...\*
```

Command line:

Does not apply.

- **AIX** | **Linux** | **Solaris** | **Mac OS X** Controlling symbolic link and alias processing  
IBM Spectrum Protect treats symbolic links and aliases (aliases apply to Mac OS X only) as actual files and backs them up. However, the file referenced by the symbolic link is not backed up.
- **Windows** Compression and encryption processing  
Consider the following information if you want to include specific files or groups of files for compression and encryption during a backup or archive operation.

- [AIX](#) [Linux](#) [Solaris](#) Compression and encryption backup processing  
This topic lists some items to consider if you want to include specific files or groups of files for compression and encryption processing during a backup or archive operation.
- [AIX](#) [Linux](#) [Solaris](#) [Mac OS X](#) [Windows](#) Processing NAS file systems  
Use the `include.fs.nas` option to bind a management class to NAS file systems and to control whether Table of Contents information is saved for the file system backup.
- [Linux](#) [Windows](#) Virtual machine include options  
Virtual machine include and exclude options influence the behavior of backup and restore operations for virtual machines. These options are processed before any command-line options are processed, so that options on the command line can override options specified on any of the virtual machine include options or virtual machine exclude options. See the individual option descriptions for information about the options.

**Related concepts:**

[Windows](#) Exclude files with UNC names

**Related tasks:**

[Windows](#) Configuring Open File Support

**Related reference:**

[AIX](#) [Linux](#) [Solaris](#) [Mac OS X](#) Snapshotcachesize

[AIX](#) [Linux](#) [Solaris](#) [Mac OS X](#) Toc

**Related information:**

[AIX](#) [Linux](#) [mmbackup command: IBM Spectrum Protect requirements](#)

[AIX](#) [Linux](#) [Guidance for integrating IBM Spectrum Scale AFM with IBM Spectrum Protect](#)

[AIX](#) [Linux](#) [Using IBM Spectrum Protect include and exclude options with IBM Spectrum Scale mmbackup command](#)

[AIX](#) [Linux](#) [Solaris](#) [Mac OS X](#)

## Controlling symbolic link and alias processing

IBM Spectrum Protect™ treats symbolic links and aliases (aliases apply to Mac OS X only) as actual files and backs them up. However, the file referenced by the symbolic link is not backed up.

In some cases symbolic links and aliases can be easily recreated and need not be backed up. In addition, backing up these symbolic links or aliases can increase backup processing time and occupy a substantial amount of space on the IBM Spectrum Protect server.

You can use the `exclude.attribute.symlink` option to exclude a file or a group of files that are symbolic links or aliases from backup processing. If necessary, you can use the `include.attribute.symlink` option to include symbolic links or aliases within broad group of excluded files for backup processing. For example, to exclude all symbolic links or aliases from backup processing, except those that exist under the `/home/spike` directory, enter these statements in your `dsm.sys` file:

```
exclude.attribute.symlink ../../*
include.attribute.symlink /home/spike/../../*
```

**Related reference:**

Exclude options

[Windows](#)

## Compression and encryption processing

Consider the following information if you want to include specific files or groups of files for compression and encryption during a backup or archive operation.

- You must set the compression option to `yes` to enable compression processing. If you do not specify the compression option or you set the compression option to `no`, the backup-archive client does not perform compression processing.
- The client processes `exclude.dir` and other include-exclude statements first. The client then considers any `include.compression` and `include.encrypt` statements. For example, consider the following include-exclude list:

```
exclude c:\test\file.txt
include.compression c:\test\file.txt
include.encrypt c:\test\file.txt
```

The client examines the `exclude c:\test\file.txt` statement first and determines that `c:\test\file.txt` is excluded from backup processing and is, therefore, not a candidate for compression or encryption processing.

- Include-exclude compression and encryption processing is valid for backup and archive processing *only*.

- As with other include-exclude statements, you can use the `inclexcl` option to specify a file that is in Unicode format, which contains `include.compression` and `include.encrypt` specifying Unicode files. See `Inclexcl` for more information.

**Related reference:**

Compression

AIX Linux Solaris

## Compression and encryption backup processing

This topic lists some items to consider if you want to include specific files or groups of files for compression and encryption processing during a backup or archive operation.

- You must set the compression option to `yes` to enable compression processing. If you do not specify the compression option or you set the compression option to `no`, the backup-archive client does not perform compression processing.
- The client processes `exclude.fs`, `exclude.dir`, and other include-exclude statements first. The client then considers any `include.compression` and `include.encrypt` statements. For example, consider the following include-exclude list:

```
exclude /home/jones/proj1/file.txt
include.compression /home/jones/proj1/file.txt
include.encrypt /home/jones/proj1/file.txt
```

The client examines the `exclude /home/jones/proj1/file.txt` statement first and determines that `/home/jones/proj1/file.txt` is excluded from backup processing and is, therefore, not a candidate for compression and encryption processing.

- Include-exclude compression and encryption processing is valid for backup and archive processing *only*.

**Related reference:**

Compression

AIX Linux Solaris Mac OS X Windows

## Processing NAS file systems

Use the `include.fs.nas` option to bind a management class to NAS file systems and to control whether Table of Contents information is saved for the file system backup.

Linux Windows Note: The `include.fs.nas` option does not apply to incremental snapshot difference incremental backup.

A NAS file system specification uses the following conventions:

- NAS nodes represent a new node type. The NAS node name uniquely identifies a NAS file server and its data to the backup-archive client. You can prefix the NAS node name to the file specification to specify the file server to which the include statement applies. If you do not specify a NAS node name, the file system you specify applies to all NAS file servers.
- Regardless of the client operating system, NAS file system specifications use the forward slash (/) separator, as in this example: `/vol/vol0`.
- Windows NAS file system designations that are specified on the command line require brace delimiters ({ and }) around the file system names, such as: `{/vol/vol0}`. Do not use brace delimiters if you specify this option in the option file.

Use the following syntax:

```
>>-pattern-- mgmtclassname- toc=value-----<<
```

Where:

**pattern**

Specifies the objects to include for backup services, to assign a specific management class, or to control TOC creation. You can use wildcards in the pattern.

**mgmtclassname**

Specifies the name of the management class to assign to the objects. If a management class is not specified, the default management class is used.

**toc=value**

For more information, see `Toc`.

Example 1: To assign a management class to the /vol/vol1 file system of a NAS node that is called `netappsj`, specify the following include statement:

```
include.fs.nas netappsj/vol/vol1 nasMgmtClass toc=yes
```

Example 2: To assign the same management class to all paths that are subordinate to the /vol/ file system on a NAS node called `netappsj` (for example, /vol/vol1, /vol/vol2, and /vol/vol3), specify the following include statement:

```
include.fs.nas netappsj/vol/* nasMgmtClass toc=yes
```

Linux Windows

## Virtual machine include options

Virtual machine include and exclude options influence the behavior of backup and restore operations for virtual machines. These options are processed before any command-line options are processed, so that options on the command line can override options specified on any of the virtual machine include options or virtual machine exclude options. See the individual option descriptions for information about the options.

 This feature is available only if the client operates as a data mover for IBM Spectrum Protect™ for Virtual Environments.

- **Linux Windows** `Include.vm`  
For virtual machine operations, this option overrides the management class that is specified on the `vmc` option.
- **Linux Windows** `Include.vmdisk`  
The `INCLUDE.VMDISK` option includes a virtual machine (VM) disk in backup operations. If you do not specify one or more disk labels, all disks in the VM are backed up.
- **Linux Windows** `INCLUDE.VMSNAPSHOTATTEMPTS`  
Use the `INCLUDE.VMSNAPSHOTATTEMPTS` option to determine the total number of snapshot attempts to try for a virtual machine (VM) backup operation that fails due to snapshot failure.
- **Linux Windows** `INCLUDE.VMTSMVSS`  
The `INCLUDE.VMTSMVSS` option notifies virtual machine applications that a backup is about to occur. This option allows the application to truncate transaction logs and commit transactions so that the application can resume from a consistent state when the backup completes. An optional parameter can be specified to suppress truncation of the transaction logs. To use this option, you must have a license agreement to use IBM Spectrum Protect for Virtual Environments: Data Protection for VMware.

### Related reference:

`Include.vmdisk`

`INCLUDE.VMTSMVSS`

`INCLUDE.VMSNAPSHOTATTEMPTS`

Linux Windows

## Include.vm

For virtual machine operations, this option overrides the management class that is specified on the `vmc` option.

 This feature is available only if the client operates as a data mover for IBM Spectrum Protect™ for Virtual Environments.

The management class specified on the `vmc` option applies to all VMware backups.

The management class specified on the `vmc` option applies to all Hyper-V backups.

You can use the `include.vm` option to override that management class, for one or more virtual machines. The `include.vm` option does not override or affect the management class that is specified by the `vmctlmc` option. The `vmctlmc` option binds backed-up virtual machine control files to a specific management class.

## Supported Clients

**Linux** This option can be used with supported Linux clients that are configured to back up VMware virtual machines.

**Windows** This option can be used with supported Windows clients that are configured to back up VMware virtual machines.

**Windows** This option can be used with supported Windows clients that are configured to back up Hyper-V virtual machines.

## Options File

---

Set this option in the client options file.

## Syntax

---

```
>>-INCLUDE.VM-- --vmname-- --+-----+-----><
                               '-mgmtclassname-'
```

## Parameters

---

### vmname

Required parameter. Specifies the name of a virtual machine that you want to bind to the specified management class. The name is the virtual machine display name. Only one virtual machine can be specified on each include.vm statement. However, you can specify as many include.vm statements as needed to bind each virtual machine to a specific management class.

You can include wildcards in the virtual machine name. An asterisk (\*) matches any character string. A question mark (?) matches a single character. If the virtual machine name contains a space character, enclose the name in double quotation marks (").

Tip: If the virtual machine name contains special characters, type the question mark wildcard in place of the special characters when you specify the virtual machine name.

### mgmtclassname

Optional parameter. Specifies the management class to use when the specified virtual machine is backed up. If this parameter is not specified, the management class defaults to the global virtual machine management class that is specified by the vmvc option.

## Examples

---

Assume that the following management classes exist and are active on the IBM Spectrum Protect server:

- MCFORTESTVMS
- MCFORPRODVMS
- MCUNIQUEVM

### Example 1

The following include.vm statement in the client options file binds all virtual machines that have names that begin with VMTEST to the management class called MCFORTESTVMS:

```
include.vm vmtest* MCFORTESTVMS
```

### Example 2

The following include.vm statement in the client options file binds a virtual machine that is named WHOPPER VM1 [PRODUCTION] to the management class called MCFORPRODVMS:

```
include.vm "WHOPPER VM1 ?PRODUCTION?" MCFORPRODVMS
```

The virtual machine name must be enclosed in quotation marks because it contains space characters. Also, the question mark wildcard is used to match the special characters in the virtual machine name.

### Example 3

The following include.vm statement in the client options file binds a virtual machine that is named VM1 to a management class that is named MCUNIQUEVM:

```
include.vm VM1 MCUNIQUEVM
```

Linux | Windows

## Include.vmdisk

---

The INCLUDE.VMDISK option includes a virtual machine (VM) disk in backup operations. If you do not specify one or more disk labels, all disks in the VM are backed up.

This option is available only if you are using the IBM Spectrum Protect™ for Virtual Environments licensed product. For more information about this option, see the IBM Spectrum Protect for Virtual Environments product documentation on IBM® Knowledge Center at <http://www.ibm.com/support/knowledgecenter/SSERB6/welcome>.

The INCLUDE.VMDISK option specifies the label of a VM disk to be included in a backup vm operation. If you include a disk on the backup vm command, the command-line parameters override any INCLUDE.VMDISK statements in the options file.

This option applies to both VMware and Microsoft Hyper-V virtual machine disks.

Linux | Windows

## INCLUDE.VMDISK for VMware virtual machines

---

Use the INCLUDE.VMDISK option to include a VMware virtual machine in backup operations.

### Supported clients

---

Linux This option can be used with supported x86\_64 Linux clients.

Windows This option can be used with supported Windows clients.

### Options file

---

Set this option in the client options file. Command line parameters override statements in the options file.

### Syntax for VMware virtual machines

---

```
>>-INCLUDE.VMDISK--vmname-- -vmdk_label-----><
```

### Parameters

---

#### *vmname*

Specifies the name of the virtual machine that contains a disk that you want to include in a Backup VM operation. The name is the virtual machine display name. You can specify only one virtual machine name on each INCLUDE.VMDISK statement. Specify additional INCLUDE.VMDISK statements for each virtual machine disk to include.

The virtual machine name can contain an asterisk (\*), to match any character string, and question mark (?) to match any one character. Surround the VM name with quotation marks (") if the VM name contains space characters.

Tip: If the virtual machine name contains special characters, such as bracket characters ([ or ]), the virtual machine name might not be correctly matched. If a virtual machine name uses special characters in the name, you might need to use the question mark character (?) to match the special characters in the VM name

For example, to include `Hard Disk 1` in the backup of a virtual machine named `"Windows VM3 [2012R2]"`, use this syntax in the options file: `INCLUDE.VMDISK "Windows VM3 ?2012R2?" "Hard Disk 1"`

#### *vmdk\_label*

Specifies the disk label of the disk that you want to include. Wildcard characters are not allowed. Use the Backup VM command with the `-preview` option to determine the disk labels of disks in a given virtual machine. See "Backup VM" for the syntax.

### Examples

---

#### Options file

Assume that a virtual machine named `vm1` contains four disks, labeled `Hard Disk 1`, `Hard Disk 2`, `Hard Disk 3`, and `Hard Disk 4`. To include only disk 2 in a Backup VM operations, specify the following in the options file:

```
INCLUDE.VMDISK "vm1" "Hard Disk 2"
```

Include disks 2 and 3 in Backup VM operations:

```
INCLUDE.VMDISK "vm1" "Hard Disk 2"  
INCLUDE.VMDISK "vm1" "Hard Disk 3"
```

#### Command line

Include a single disk when backing up vm1:

```
dsmc backup vm "vm1:vmdk=Hard Disk 1"
```

Include disk 2 and disk 3 on vm1:

```
dsmc backup vm "vm1:vmdk=Hard Disk 2:vmdk=Hard Disk 3"
```

Windows

## INCLUDE.VMDISK for Microsoft Hyper-V virtual machines

---

Use the INCLUDE.VMDISK option to include a VM disk from Hyper-V RCT backup operations on Windows Server 2016 or later operating systems.

### Supported clients

---

This option can be used with Windows Server 2016 or later clients.

### Options file

---

Set this option in the client options file. Command-line parameters override statements in the options file.

### Syntax for Microsoft Hyper-V virtual machines

---

```
>>-INCLUDE.VMDISK--vmname-- -disk_location-----><
```

### Parameters

---

#### *vmname*

Specifies the name of the VM that contains a disk that you want to include from a backup vm operation. The name is the virtual machine display name. You can specify only one VM name on each INCLUDE.VMDISK statement. Specify additional INCLUDE.VMDISK statements for each VM disk to include.

The VM name can contain an asterisk (\*) to match any character string, and a question mark (?) to match any one character. If the VM name contains space characters, surround the VM name with quotation marks (" ").

Tip: If the VM name contains special characters, such as bracket characters ([ ] or { }), the VM name might not be correctly matched. If a VM name includes special characters, use a question mark (?) to represent the special characters.

For example, to include a SCSI VM disk in the backup of a virtual machine named "Windows VM3 [2012R2]", use this syntax in the options file:

```
INCLUDE.VMDISK "Windows VM3 ?2012R2?" "SCSI 0 1"
```

#### *disk\_location*

Specify the location of the VM disk to include in a Hyper-V RCT backup operation. The disk location label must begin with "SCSI" or "IDE" followed by the controller number and device location number. Wildcard characters are not allowed.

Tip: Use the backup vm command with the -preview option to determine the location of disks in a given virtual machine. See the "Backup VM" topic for the syntax.

### Examples

---

#### Options file

Virtual machine `vm1` contains an IDE VM disk (VHDX) at controller number 1 and device location 0. To include this VHDX in backup vm operations, specify the following statement in the options file:

```
INCLUDE.VMDISK vm1 "IDE 1 0"
```

Virtual machine `vm2` contains a SCSI VM disk at controller number 0 and device location 1. Include this VHDX in backup operations by specifying the following statement in the options file:

```
INCLUDE.VMDISK vm2 "SCSI 0 1"
```

#### Command line

Include a single IDE disk (at controller number 1 and device location 0) when virtual machine `vm1` is backed up:

```
dsmc backup vm "vm1:vhdX=IDE 1 0"
```

Include a SCSI disk (at controller number 0 and device location 1) in the backup operation of virtual machine `vm2`:

```
dsmc backup vm "vm2:vhdX=SCSI 0 1"
```

#### Related reference:

Backup VM

Restore VM

Domain.vmdisk

Exclude.vmdisk

Linux Windows

## INCLUDE.VMSNAPSHOTATTEMPTS

Use the `INCLUDE.VMSNAPSHOTATTEMPTS` option to determine the total number of snapshot attempts to try for a virtual machine (VM) backup operation that fails due to snapshot failure.

### Supported Clients

 This feature is available only if the client operates as a data mover for IBM Spectrum Protect™ for Virtual Environments.

**Linux** This option can be used with supported Linux clients that are configured to back up VMware virtual machines.

**Windows** This option can be used with supported Windows clients that are configured to back up VMware virtual machines.

**Windows** This option can be used with supported Windows clients that are configured to back up VMs on Hyper-V hosts that run on Windows Server 2016 operating systems.

### Options File

This option is valid in the client options file (`dsm.opt`). It can also be included on the server in a client options set. It is not valid on the command line.

### Syntax

```
>>--INCLUDE.VMSNAPSHOTATTEMPTS--vmname--num_with_quiescing----->
>>--num_without_quiescing-----><
```

### Parameters

`vmname`

A required positional parameter that specifies the name of the virtual machine to attempt the total number of snapshots for, if a backup attempt fails due to snapshot failure. The name is the virtual machine display name.

Only one virtual machine can be specified on each `INCLUDE.VMSNAPSHOTATTEMPTS` statement. However, to configure the total snapshot attempts for other virtual machines, you can use the following methods:

- For each virtual machine that you want this option to apply to, specify as many `INCLUDE.VMSNAPSHOTATTEMPTS` statements as needed to reattempt snapshots that failed.
- Use wildcard characters for the `vmname` parameter value to specify virtual machine names that match the wildcard pattern. An asterisk (\*) matches any character string. A question mark (?) matches a single character. If the virtual machine name contains a space character, enclose the name in double quotation marks (").

Tip: If the virtual machine name contains special characters, type the question mark wildcard (?) in place of the special characters when you specify the virtual machine name.

`num_with_quiescing`

A positional parameter that specifies the following action:

For VMware backup operations:



- For Windows virtual machines with IBM Spectrum Protect application protection enabled, *num\_with\_quiescing* specifies the number of times to attempt the snapshot with IBM Spectrum Protect VSS quiescing and Microsoft Windows system provider VSS quiescing. VSS quiescing applies only to Windows virtual machines.

Depending on the number that you specify, the first snapshot attempt is always made with IBM Spectrum Protect VSS quiescing. Subsequent snapshot attempts are made with Windows system provider VSS quiescing.

- For Windows virtual machines without IBM Spectrum Protect application protection enabled and for Linux virtual machines, *num\_with\_quiescing* specifies the number of times to attempt the snapshot with VMware Tools file system quiescing.

The maximum value that you can specify is ten (10). The default value is two (2). The minimum value that you can specify is zero (0).

For Hyper-V RCT backup operations:

The *num\_with\_quiescing* parameter specifies the number of times to attempt snapshots with quiescing to create application-consistent backups.

You can specify a value in the range 0 - 10. The default value is 2.

*num\_without\_quiescing*

For VMware backup operations:

A positional parameter that specifies the number of times to attempt the snapshot with VMware Tools file system quiescing and application (VSS) quiescing disabled after the specified number of attempts with VSS quiescing (*num\_with\_quiescing*) completes. For example, you can specify this parameter for a virtual machine that is already protected by an IBM® Data Protection agent that is installed in a guest virtual machine.

The maximum value that you can specify is ten (10). The minimum value that you can specify is zero (0), which is the default value.

Important: When this parameter is applied to a virtual machine backup, the backup is considered crash-consistent. As a result, operating system, file system, and application consistency are not guaranteed. An `include.vmsnapshotattempts 0 0` entry is not valid. Backup operations require at least one snapshot.

For Hyper-V RCT backup operations:

The *num\_without\_quiescing* option specifies the number of times to attempt snapshots without quiescing after the specified number of attempts in the *num\_with\_quiescing* option are completed.

You can specify a value in the range 0 - 10. The default value is 0.

Important: When this parameter is applied to a VM backup, the backup is considered crash-consistent. As a result, operating system, file system, and application consistency are not guaranteed. An `include.vmsnapshotattempts 0 0` entry is not valid. Backup operations require at least one snapshot.

## Examples

---

VMware examples:

### Example 1

The following `INCLUDE.VMSNAPSHOTATTEMPTS` statement in the client options file tries two total snapshot attempts (with VSS quiescing) for virtual machine `VM_a`:

```
INCLUDE.VMSNAPSHOTATTEMPTS VM_a 2 0
```

### Example 2

The following `INCLUDE.VMSNAPSHOTATTEMPTS` statement in the client options file tries three total snapshot attempts for Windows virtual machines that match the `vmServer_Dept*` string:

- The first attempt is made with IBM Spectrum Protect VSS quiescing.
- The second attempt is made with Windows system provider VSS quiescing.
- The third snapshot attempt is taken without VSS quiescing.

```
INCLUDE.VMSNAPSHOTATTEMPTS vmServer_Dept* 2 1
```

### Example 3

The following INCLUDE.VMSNAPSHOTATTEMPTS statement in the client options file tries one total snapshot attempt (with VSS quiescing) for virtual machines that match the vmDB\_Dept\* string:

```
INCLUDE.VMSNAPSHOTATTEMPTS vmDB_Dept* 1 0
```

### Example 4

The following INCLUDE.VMSNAPSHOTATTEMPTS statement in the client options file tries two total snapshot attempts (with VSS quiescing) for all virtual machines:

- The first attempt is made with IBM Spectrum Protect VSS quiescing.
- The second attempt is made with Windows system provider VSS quiescing.

```
INCLUDE.VMSNAPSHOTATTEMPTS * 2 0
```

### Example 5

In this example, the virtual machine DB15 has an IBM Data Protection agent that is installed in a guest virtual machine and does not need an application-consistent snapshot. The following INCLUDE.VMSNAPSHOTATTEMPTS statement in the client options file tries one total snapshot attempt (without VSS quiescing) for virtual machine DB15:

```
INCLUDE.VMSNAPSHOTATTEMPTS DB15 0 1
```

### Hyper-V examples:

#### Example 1

Specify the following statement in the client options file to make two total snapshot attempts at crash-consistent backups for all Hyper-V VMs that begin with LinuxVM:

```
INCLUDE.VMSNAPSHOTATTEMPTS LinuxVM* 0 2
```

#### Example 2

Specify the following statement in the client options file to try three snapshot attempts for virtual machine VM1: two application-consistent snapshot attempts, and if they fail, to try one crash-consistent snapshot attempt:

```
INCLUDE.VMSNAPSHOTATTEMPTS VM1 2 1
```

**Windows** If you are restoring application protection backups, see Shadow copy considerations for restoring an application protection backup from the data mover.

#### Related reference:

INCLUDE.VMTSMVSS

Linux Windows

## INCLUDE.VMTSMVSS

---

The INCLUDE.VMTSMVSS option notifies virtual machine applications that a backup is about to occur. This option allows the application to truncate transaction logs and commit transactions so that the application can resume from a consistent state when the backup completes. An optional parameter can be specified to suppress truncation of the transaction logs. To use this option, you must have a license agreement to use IBM Spectrum Protect™ for Virtual Environments: Data Protection for VMware.

When a virtual machine is included by this option, IBM Spectrum Protect provides application protection. That is, the client freezes and thaws the VSS writers and, optionally, truncates the application logs. If a virtual machine is not protected by this option, application protection is provided by VMware, and VMware freezes and thaws the VSS writers, but application logs are not truncated.

**Important:** Before you begin application protection backups, ensure that the application database, such as the Microsoft SQL Server database or Microsoft Exchange Server database, is on a non-boot drive (any drive other than the boot drive), in case a diskshadow revert operation is needed during restore.

## Supported clients

---

**Linux** This option can be used with supported x86\_64 Linux clients.

**Windows** This option can be used with supported Windows clients.

## Options file

---

Set this option in the client options file. This option cannot be set by the preferences editor or on the command line.

## Syntax

---

```
>>-INCLUDE.VMTSMVSS----vmname---- --OPTions=KEEPSqllog-----><
```

## Parameters

---

### *vmname*

Specifies the name of the virtual machine that contains the applications to quiesce. The name is the virtual machine display name. Specify one virtual machine per INCLUDE.VMTSMVSS statement. For example, to include a virtual machine named Windows VM3 [2012R2], use this syntax in the options file: INCLUDE.VMTSMVSS "Windows VM3 [2012R2]".

To protect all virtual machines with this option, use an asterisk as a wildcard (INCLUDE.VMTSMVSS \*). You can also use question marks to match any single character. For example, INCLUDE.VMTSMVSS vm?? protects all virtual machines that have names that begin with vm and are followed by any two characters (vm10, vm11, vm17, and so on).

Tip: If the virtual machine name contains special characters, such as bracket characters ([ or ]), the virtual machine name might not be correctly matched. If a virtual machine name uses special characters in the name, you can use the question mark character (?) to match the special characters in the virtual machine name.

There is no default value for this parameter. To enable application protection, you must include virtual machines to be protected on one or more INCLUDE.VMTSMVSS statements. Make sure that you do not exclude a disk on a virtual machine (by using the EXCLUDE.VMDISK option) if the disk contains application data that you want protected.

### OPTions=KEEPSqllog

If the OPTions `KEEPSqllog` parameter is specified on an INCLUDE.VMTSMVSS statement, the parameter prevents SQL server logs from being truncated when a backup-archive client that is installed on a data mover node backs up a virtual machine that is running a SQL server. Specifying this parameter allows the SQL server administrator to manually manage (backup, and possibly truncate) the SQL server logs, so that they can be preserved and be used to restore SQL transactions to a specific checkpoint, after the virtual machine is restored.

When this option is specified, the SQL log is not truncated and the following message is displayed and logged on the server:

```
ANS4179I IBM Spectrum Protect application protection
did not truncate the Microsoft SQL Server logs on VM 'VM'.
```

You can remove the `OPTIONS=KEEPSQLLOG` option to enable truncation of the SQL logs when a backup completes.

Note: The client does not back up the SQL log files. The SQL administrator must back up the log files so that they can be applied after the database is restored.

## Examples

---

### Options file

Configure application protection for a virtual machine that is named `vm_example`:

```
INCLUDE.VMTSMVSS vm_example
```

Configure application protection for `vm11`, `vm12`, and `vm15`:

```
INCLUDE.VMTSMVSS vm11
INCLUDE.VMTSMVSS vm12
INCLUDE.VMTSMVSS vm15 options=keepsqlllog
```

### Command line

Not applicable; this option cannot be specified on the command line.

### Related concepts:

**Windows** Shadow copy considerations for restoring an application protection backup from the data mover

### Related reference:

Vmtimeout

Exclude.vmdisk

Include.vmdisk

INCLUDE.VMSNAPSHOTATTEMPTS

# Incrbydate

---

Use the `incrbydate` option with the incremental command to back up new and changed files with a modification date later than the last incremental backup stored at the server, unless you exclude the file from backup.

**Important:** Files that are modified or created after their respective directory was processed by the backup-archive client, but before the incremental-by-date backup completes, are not backed up and will not be backed up in future incremental-by-date backups, unless the files are modified again. For this reason, a run a regular incremental backup periodically, without specifying the `incrbydate` option.

An incremental-by-date updates the date and time of the last incremental at the server. If you perform an incremental-by-date on only part of a file system, the date of the last full incremental is not updated and the next incremental-by-date backs up these files again.

**AIX Linux Mac OS X Solaris** **Important:**

**Mac OS X** The last incremental backup time refers to the server time and the file modification time refers to the client time. If the client and server time are not synchronized, or the client and server are in different time zones, this affects incremental-by-date backup with `mode=incremental`.

**AIX Linux Solaris** The last incremental backup time refers to the server time and the file modification time refers to the client time. If the client and server time are not synchronized, or the client and server are in different time zones, this affects incremental-by-date backup and image backup with `mode=incremental`.

**AIX Linux Solaris Mac OS X Windows** Both full incremental backups and incrementals-by-date backups backup new and changed files. An incremental-by-date takes less time to process than a full incremental and requires less memory. However, unlike a full incremental backup, an incremental-by-date backup does not maintain current server storage of all your workstation files for the following reasons:

- **AIX Linux Solaris Mac OS X Windows** It does not expire backup versions of files that are deleted from the workstation.
- It does not rebind backup versions to a new management class if the management class has changed.
- **AIX Linux Solaris Mac OS X** It does not back up files with attributes that have changed, such as Access control list (ACL) data, unless the modification dates and times have also changed.
- **Windows** It does not back up files with attributes that have changed, such as NTFS security information, unless the modification dates and times have also changed.
- It ignores the copy group frequency attribute of management classes.

**AIX Linux Mac OS X Solaris Windows** **Tip:** If you have limited time during the week to perform backups, but extra time on weekends, you can maintain current server storage of your workstation files by performing an incremental backup with the `incrbydate` option on weekdays and a full incremental backup on weekends.

## Supported Clients

---

This option is valid for all clients. The IBM Spectrum Protect™ API does not support this option.

## Syntax

---

```
>>-INCRbydate-----<<
```

## Parameters

---

There are no parameters for this option.

## Examples

---

Command line:  
`dsmc incremental -incrbydate`

**AIX Linux Solaris Windows**

## Incremental

---

Use the incremental option with the restore image command to ensure that any changes that were made to the base image are also applied to the restored image.

If you also use the deletefiles option, changes include the deletion of files and directories that were in the original image but later deleted from the workstation.

**AIX** **Linux** **Solaris** Note: Using the incremental option with the restore image command to perform a dynamic image backup is not supported.

**AIX** **Linux** **Solaris** **Windows**

## Supported Clients

---

**AIX** **Linux** **Solaris** This option is valid only for AIX®, Linux x86\_64, Linux on POWER®, and Solaris. The IBM Spectrum Protect™ API does not support this option.

**Windows** This option is valid for all Windows clients. The IBM Spectrum Protect API does not support this option.

## Syntax

---

```
>>-INCRemental-----<<
```

## Examples

---

**AIX** **Linux** **Solaris** Command line:  
**AIX** **Linux** **Solaris** `res i "/home/devel/projecta/*" -incremental`

**Windows** Command line:  
**Windows** `res i d: -incremental`

**Windows**

## Incrthreshold

---

The incrthreshold option specifies the threshold value for the number of directories in any journaled file space that might have active objects on the server, but no equivalent object on the workstation.

When a Windows client deletes a file or directory with a long name, it sometimes reports this using a compressed name. After the object is deleted, the compressed name might be reused and the deletion notice can no longer identify a unique object. During a journaled incremental backup of a file space, this can result in the *no active version* response from the server resulting in an unsuccessful expire for an object.

The incrthreshold option allows you to specify what to do when this condition arises:

- If you set the incrthreshold option to 0 (the default), no action is taken. The primary consequence is that, during a restore of such a directory, these objects might be inadvertently restored. When the next non-journaled incremental backup is run on this directory, the IBM Spectrum Protect™ server expires all objects in the directory that exist on the server but not on the workstation.
- If you specify a value greater than zero, the client saves the directory name of an object in the journal during journaled backups. During a full file space journaled incremental backup, if the number of directories in the file space is greater than or equal to this value, a full incremental backup of each directory occurs. This takes place automatically after completion of the journaled backup and does not require entry of another command.
- If you set the incrthreshold option to 1, the client performs a full incremental backup of these directories whenever a *no active version* response is received during a full file space journaled incremental backup.

## Supported Clients

---

This option is for all Windows clients.

## Options File

---

Place this option in the client options file (dsm.opt). You can set this option on the Backup > Threshold for non-journal incremental backup field of the Preferences editor.

## Syntax

---

```
>>-INCRThreshhold--numberdirectories-----><
```

## Parameters

---

### *numberdirectories*

Specifies the threshold value for the number of directories in any journaled file space that might contain active files that should be expired. When this threshold is reached during a full file space journaled incremental, the client initiates an incremental backup on each such directory at the completion of the journaled backup. The range of values is 0 through 2,000,000,000; the default is 0.

## Examples

---

Options file:

```
incrthreshold 1
```

Command line:

```
-increthreshold=1
```

This option is valid only on the initial command line. It is not valid in interactive mode.

## Instrlogmax

---

The instrlogmax option specifies the maximum size of the instrumentation log (dsminstr.log), in MB. Performance data for the client is collected in the dsminstr.log file during backup or restore processing when the enableinstrumentation option is set to *yes*.

If you change the value of the instrlogmax option, the existing log is extended or shortened to accommodate the new size. If the value is reduced, the oldest entries are deleted to reduce the file to the new size.

## Supported Clients

---

This option is valid for all clients and the IBM Spectrum Protect™ API.

## Options File

---

**AIX** | **Linux** | **Solaris** | **Mac OS X** Place this option in the client system-options file (dsm.sys) within a server stanza. The option can be set in the client option set on the IBM Spectrum Protect server.

**Windows** Place this option in the client options file (dsm.opt). The option can be set in the client option set on the IBM Spectrum Protect server.

## Syntax

---

```
>>-INSTRLOGMAX-- size-----><
```

## Parameters

---

### size

Specifies the maximum size, in MB, for the instrumentation log file. The range of values is 0 - 2047. The default value is 25.

When the size of the dsminstr.log file exceeds the maximum size, the log file is renamed to dsminstr.log.bak. Subsequent instrumentation data continues to be saved to the dsminstr.log file.

If you specify 0, the log file grows indefinitely.

## Examples

---

Options file:

```
instrlogmax 100
```

Command line:

```
AIX Linux Mac OS X Solaris dsmc sel /home/mydir/* -subdir=yes -enableinstrumentation=yes -  
instrlogmax=100  
Windows dsmc sel c:\mydir\* -subdir=yes -enableinstrumentation=yes -instrlogmax=100
```

This option is valid only on the initial command line. It is not valid in interactive mode.

**Related reference:**

Enableinstrumentation

Instrlogname

## Instrlogname

---

The instrlogname option specifies the path and file name where you want to store performance information that the backup-archive client collects.

When you use the enableinstrumentation yes option to collect performance data during backup and restore operations, the client automatically stores the information in a log file.

By default, the performance data is stored in the instrumentation log file (dsminstr.log) in the directory that is specified by the DSM\_LOG environment variable (or the DSMI\_LOG environment variable for the API-dependent products IBM Spectrum Protect™ for Databases: Data Protection for Microsoft SQL Server and IBM Spectrum Protect for Mail: Data Protection for Microsoft Exchange Server). If you did not set the DSM\_LOG environment variable, the instrumentation log file is stored in the current directory (the directory where you issued the dsmc command).

Use this option only when you want to change the file name and location of the instrumentation log.

If you want to control the size of the log file, use the instrlogmax option.

## Supported Clients

---

This option is valid for all clients and the IBM Spectrum Protect API.

## Options File

---

AIX Linux Solaris Mac OS X Place this option in the client system-options file (dsm.sys) within a server stanza. The option can be set in the client option set on the IBM Spectrum Protect server.

Windows Place this option in the client options file (dsm.opt). The option can be set in the client option set on the IBM Spectrum Protect server.

AIX Linux Solaris Mac OS X  
Important: Set the DSM\_LOG environment variable to name a directory where the log is to be placed. The directory that is specified must have permissions that allow write-access from the account under which the client is run. The root directory is not a valid value for DSM\_LOG.

Windows  
Important: Set the DSM\_LOG environment variable to name a directory where the log is to be placed. The directory that is specified must have permissions that allow write-access from the account under which the client is run.

## Syntax

---

```
>>-INSTRLOGNAME-- --filespec-----><
```

## Parameters

---

filespec

Specifies the path and file name where you want to store performance information during backup or restore processing. If any part of the path that you specify does not exist, the client attempts to create it.

**Windows** If you specify a file name only, the file is stored in the directory that is specified by the DSM\_LOG environment variable. If you did not set the DSM\_LOG environment variable, the instrumentation log file is stored in the current directory (the directory where you issued the dsmc command).

**AIX** **Linux** **Solaris** If you specify a file name only, the file is stored in the directory that is specified by the DSM\_LOG environment variable. If you did not set the DSM\_LOG environment variable, the instrumentation log file is stored in the current directory (the directory where you issued the dsmc command). The instrumentation log file cannot be a symbolic link.

**Mac OS X** For Mac OS X, if you specify a file name only, the file is stored in your default folder. The default directories are:

```
~/Library/Logs/tivoli/tsm  
/Library/Logs/tivoli/tsm
```

This instrumentation log file name replaces the previous instrumentation log file name dsminstr.report.pXXX that was created by the TESTFLAG=instrument:detail or instrument:API option.

## Examples

---

Options file:

**AIX** **Linux** **Solaris** For AIX®, Linux, and Oracle Solaris clients:

```
instrlogname /home/user1/mydir/mydsminstr.log
```

**Mac OS X** For Mac OS X clients:

```
instrlogname /Users/user1/Library/Logs/mydsminstr.log
```

**Windows** For Windows clients:

```
instrlogname c:\mydir\mydsminstr.log
```

Command line:

**AIX** **Linux** **Solaris** For AIX, Linux, and Oracle Solaris clients:

```
dsmc sel /home/user1/mydir/* -subdir=yes -instrlogname=/usr/log/mydsminstr.log
```

**Mac OS X** For Mac OS X clients:

```
dsmc sel /Users/user1/mydir/* -subdir=yes -  
instrlogname=/Users/user1/Library/Logs/mydsminstr.log
```

**Windows** For Windows clients:

```
dsmc sel c:\mydir\* -subdir=yes -instrlogname=c:\temp\mydsminstr.log
```

This option is valid only on the initial command line. It is not valid in interactive mode.

**Related reference:**

Enableinstrumentation

Instrlogmax

**Windows**

## Journalpipe

---

The journalpipe option specifies the pipe name of a journal daemon session manager to which the backup clients attach.

## Supported Clients

---

This option is for all Windows clients.

## Options File

---

Place this option in the client options file (dsm.opt).

```
JournalPipe \\.\pipe\jnlSessionMgr1
```



## Syntax

---

```
>>-JOURNALPipe--pipename-----<<
```

## Parameters

---

pipename

Specify the name of the pipe the client attaches to when performing a journal-based backup. The default pipe name is \\.\pipe\jnlSessionMgr.

## Examples

---

Options file:

```
JOURNALPipe \\.\pipe\jnlSessionMgr
```

Command line:

This option cannot be set on the command line.

AIX Linux Solaris Windows

## Lanfreecommmethod

---

The lanfreecommmethod option specifies the communications protocol between the IBM Spectrum Protect™ client and Storage Agent. This enables processing between the client and the SAN-attached storage device.

AIX Linux Solaris

If you are using LAN failover, you must have lanfreecommmethod in the dsm.sys file within a server stanza.

Windows

If you are using LAN failover, you must have lanfreecommmethod TCPip in the client options file (dsm.opt).

AIX Linux Solaris

For AIX®, Linux and Solaris, use the lanfreeshmport option to specify the shared memory port number where the Storage Agent is listening.

Windows

For Windows, use the lanfreeshmport option to uniquely identify the storage agent to which the client is trying to connect.

## Supported Clients

---

AIX Linux Solaris

This option is valid for AIX, Linux, and Oracle Solaris clients.

Windows

This option is valid for all Windows clients.

## Options File

---

AIX Linux Solaris

Place this option in the dsm.sys file within a server stanza.

Windows

Place this option in the client options file (dsm.opt).

## Syntax

---

```
>>-LANFREECommmethod-- commmethod-----<<
```

## Parameters

---

commmethod

Specifies the supported protocol for the backup-archive client:

AIX Linux Solaris TCPip

AIX Linux Solaris

The Transmission Control Protocol/Internet Protocol (TCP/IP) communication method.

Use the `lanfreetcppport` option to specify the TCP/IP port number where the Storage Agent is listening. The TCP/IP communication method is the default for non-root users on all supported platforms.

**Windows** TCPip

**Windows** The Transmission Control Protocol/Internet Protocol (TCP/IP) communication method.

Use the `lanfreetcppport` option to specify the TCP/IP port number where the Storage Agent is listening.

V6Tcip

Indicates that either TCP/IP v4 or v6 should be used, depending on the system configuration and results of a domain name service lookup. The only time this is not true is when `dsmc schedule` is used and `schedmode` is `prompt`. A valid DNS environment must be available.

**Windows** NAMEDpipes

**Windows** The interprocess communication method that permits message data streams to pass between a client and a server. This is the default. Do not specify the `lanfreetcppport` option if you want to use the NAMEDpipes communication method for LAN-free communication.

**Windows** SHAREdmem

**Windows** Use the shared memory communication method when the client and Storage Agent are running on the same system. Shared memory provides better performance than the TCP/IP protocol. The backup-archive client must have local administrator permissions.

**AIX** | **Linux** | **Solaris** SHAREdmem

**AIX** | **Linux** | **Solaris** Use the shared memory communication method when the client and Storage Agent are running on the same system. Shared memory provides better performance than the TCP/IP protocol. This is the default communication method for AIX, Linux, and Solaris root users. When specifying this communication method on AIX, the backup-archive client user can be logged in as root or non-root, as long as the Storage Agent is running as root. If the Storage Agent is not running as root, the user ID running the backup-archive client must match the user ID running the Storage Agent.

## Examples

---

Options file:

```
lanfreecommmethod tcp
```

Use only TCP/IP v4

```
lanfreecommmethod V6Tcip
```

Use both TCP/IP v4 or v6, depending on how the system is configured and the results of a domain name service lookup.

Command line:

```
-lanfreec=tcp
```

```
-lanfreec=V6Tcip
```

This option is valid only on the initial command line. It is not valid in interactive mode.

**AIX** | **Linux** | **Solaris** | **Windows**

## Lanfreeshmport

---

Use the `lanfreeshmport` option when `lanfreecommmethod=SHAREdmem` is specified for communication between the backup-archive client and the storage agent. This enables processing between the client and the SAN-attached storage device.

## Supported Clients

---

**AIX** | **Linux** | **Solaris** This option is valid for AIX®, Linux, and Oracle Solaris clients.

**Windows** This option is valid for all Windows clients.

## Options File

---

**AIX** | **Linux** | **Solaris** Place this option in the client system-options file (`dsm.sys`) within a server stanza.

**Windows** Place this option in the client options file (`dsm.opt`).

## Syntax

---

```
>>-LANFREEShmport-- --port_address-----><
```

## Parameters

---

port\_address

Specifies the number that is used to connect to the storage agent. The range of values is 1 through 32767.

For Windows clients, the default is 1.

For all clients except Windows clients, the default is 1510.

## Examples

---

Options file:

```
lanfrees 1520
```

Command line:

```
-lanfrees=1520
```

This option is valid only on the initial command line. It is not valid in interactive mode.

AIX Linux Solaris Windows

## Lanfreetcport

---

The lanfreetcport option specifies the TCP/IP port number where the IBM Spectrum Protect™ Storage Agent is listening.

Use this option when you specify lanfreecommmethod=TCPip for communication between the backup-archive client and Storage Agent. Do not specify the lanfreetcport option if you want to use the NAMedpipes communication method for LAN-free communication.

## Supported Clients

---

AIX Linux Solaris

This option is valid only for AIX®, Linux x86\_64, Linux on POWER®, and Oracle Solaris clients.

Windows

This option is valid for all Windows clients.

## Options File

---

AIX Linux Solaris

Place this option in the dsm.sys file within a server stanza.

Windows

Place this option in the client options file (dsm.opt).

## Syntax

---

```
>>-LANFREETCPort-- --port_address-----><
```

## Parameters

---

port\_address

Specifies the TCP/IP port number where the Storage Agent is listening. The range of values is 1 through 32767; the default is 1500.

**Note:** The client lanfreetcport value must match Storage Agent tcpport value for communications with the Storage Agent (virtual server). The client tcpport value must match the server tcpport value for communications with the actual server.

## Examples

---

Options file:

```
lanfreetcpp 1520
Command line:
-lanfreetcpp=1520
```

This option is valid only on the initial command line. It is not valid in interactive mode.

AIX Linux Solaris Windows

## Lanfreessl

---

Use the lanfreessl option to enable Secure Sockets Layer (SSL), to provide secure client and Storage Agent communications. This option is deprecated if you are connecting to an IBM Spectrum Protect™ server V8.1.2 and later.

### Supported Clients

---

This option is supported on all clients, except for Mac OS X clients.

### Options File

---

Place this option in the client options file. You cannot set this option in the GUI or on the command line.

### Syntax

---

```
.-No--.
>>-LANFREESSL+-----><
'-Yes-'
```

### Parameters

---

No

Specifies that the backup-archive client does not use SSL when communicating with the Storage Agent. No is the default.

Yes

Specifies that the backup-archive client enables SSL when communicating with the Storage Agent. To enable SSL, specify lanfreessl=yes and change the value of the lanfreetcppport option. Changing the value of the lanfreetcppport option is necessary because the IBM Spectrum Protect Storage Agent is typically set up to listen for SSL connections on a separate port.

### Examples

---

Options file:

```
lanfreessl yes
lanfreessl no
```

Command line:

Not applicable. You cannot set this option on the command line.

AIX Linux Solaris Windows

## Lanfreetcppserveraddress

---

The lanfreetcppserveraddress option specifies the TCP/IP address for the IBM Spectrum Protect™ Storage Agent.

Use this option when you specify lanfreecommmethod=TCPIP or V6TcPIP for communication between the backup-archive client and Storage Agent.

Overriding the default for this option is useful when configuring LAN-free in an environment where the client and storage agent are running on different systems. You can obtain this Storage Agent address from your administrator.

### Supported Clients

---

**AIX****Linux****Solaris**

This option is valid only for AIX®, Linux x86\_64, Linux on POWER®, and Oracle Solaris clients.

**Windows**

This option is valid for all supported Windows clients.

## Options File

---

Place this option in the client system-options file.

## Syntax

---

```
>>-LANFREETCPServeraddress-- --stagent_address-----<<
```

## Parameters

---

**stagent\_address**

Specifies a 1 to 64 character TCP/IP address for a server. Specify a TCP/IP domain name or a numeric IP address. The numeric IP address can be either a TCP/IP v4 or TCP/IP v6 address. The default value is 127.0.0.1 (localhost).

## Examples

---

Options file:

```
LANFREETCPServeraddress stagent.example.com
LANFREETCPServeraddress 192.0.2.1
```

Command line:

Does not apply.

**Windows**

## Language

---

The language option specifies the national language in which to present client messages.

You can use US English (ENU) with all clients.

The language that is displayed by the backup-archive client Java™ GUI is defined by the Windows display locale and not the Windows system locale. For example, if the Windows system and input locale is French, but the display locale is Russian, the language that is displayed by the Java GUI is Russian by default, if the language option is not used. If you want to display the Java GUI in US English or another language, you can override the default display language by specifying the language option.

Tip: The language option does not affect the web client. The web client displays in the language associated with the locale of the browser. If the browser is running in a locale that client does not support, the web client is displayed in US English.

## Supported Clients

---

This option is valid for all Windows clients.

## Options File

---

Place this option in the client options file (dsm.opt). You can set this option on the Regional Settings tab, Language drop-down list of the Preferences editor.

## Syntax

---

```
>>-LANGuage-- --language-----<<
```

## Parameters

---

language

Specifies the language that you want to use. The available languages include:

- ENU (English, United States).
- PTB (Brazilian Portuguese)
- CHS (Chinese, Simplified)
- CHT (Chinese, Traditional)
- FRA (Standard French)
- DEU (Standard German)
- ITA (Standard Italian)
- JPN (Japanese)
- KOR (Korean)
- ESP (Standard Spanish)
- CSY (Czech)
- HUN (Hungarian)
- PLK (Polish)
- RUS (Russian)

## Examples

---

Options file:

```
language enu
```

Command line:

Does not apply.

## Latest

---

Use the latest option to restore the most recent backup version of a file, even if the backup is inactive.

You can use the latest option with the following commands:

- restore
- restore group

If you are performing a point-in-time restore (using the pitdate option), it is not necessary to specify latest since this option is implicit when pitdate is used.

## Supported Clients

---

This option is valid for all clients. The IBM Spectrum Protect™ API does not support this option.

## Syntax

---

```
>>-LATest-----<<
```

## Parameters

---

There are no parameters for this option.

## Examples

---

Mac OS X	Command line:			
Mac OS X	dsmc restore "/Users/devel/projecta/*" -latest			
AIX	Linux	Solaris	Mac OS X	Command line:
AIX	Linux	Solaris	Mac OS X	dsmc restore "/home/devel/projecta/*" -latest
Windows	Command line:			
Windows	dsmc restore c:\devel\projecta\ -latest			
AIX	Linux	Solaris	Mac OS X	Windows

## Localbackupset

---

The localbackupset option specifies whether the backup-archive client GUI bypasses initial logon with the IBM Spectrum Protect™ server to restore a local backup set on a standalone workstation.

If you set the localbackupset option to yes, the GUI does not attempt initial logon with the server. In this case, the GUI only enables the restore functionality.

If you set the localbackupset option to no (the default), the GUI attempts initial logon with the server and enables all GUI functions.

Note: The restore backupset command supports restore of local backup sets on a standalone workstation without using the localbackupset option.

## Supported Clients

---

This option is valid for all clients.

## Options File

---

**AIX** | **Linux** | **Solaris** | **Mac OS X** Place this option in the client system-options file (dsm.sys) within a server stanza.

**Windows** Place this option in the dsm.opt file.

## Syntax

---

```
>>-LOCALbackupset--+-No--+.----->>
                    '-Yes-'
```

## Parameters

---

**No**  
Specifies that the GUI attempts initial logon with the server and enables all functions. This is the default.

**Yes**  
Specifies that the GUI does not attempt initial logon with the server and enables only the restore functionality.

## Examples

---

Options file:  
localbackupset yes

This option is not valid with the dsmsc command-line client.

**AIX** | **Linux** | **Solaris**

## Makesparsefile

---

Use the makesparsefile option with the restore or retrieve commands to specify how sparse files are recreated.

Sparse files do not have disk space allocated for every block in the whole address space, leading to holes within the file. The backup-archive client detects sparse files during a backup operation and marks them as sparse on the IBM Spectrum Protect™ server. Holes are detected by their content, which is always zeros.

If you set the makesparsefile option to yes (default), holes within the file are not written to disk so no additional disk space is allocated during a restore.

If you set the makesparsefile option to no, holes are not recreated, leading to disk blocks allocated for the whole address space. This might result in a larger amount of used disk space. Ensure that you have enough disk space to restore all data.

On some UNIX and Linux systems, it might be necessary to back up system specific files as non-sparse files. Use the `makesparsefile` option for files where the existence of physical disk blocks is required, such as `ufsboot` on Solaris, which is executed during boot time. The boot file loader of the operating system accesses physical disk blocks directly and does not support sparse files.

## Supported Clients

---

This option is valid for all UNIX and Linux clients except Mac OS X.

## Options File

---

Place this option in the client user options file (`dsm.opt`).

## Syntax

---

```
      .-Yes-.
>>-MAKESParsefile-----+-----+-----+-----+----->>
      '-No--'
```

## Parameters

---

Yes

Specifies that holes within the file are not written so that no additional disk space is allocated during a restore. This is the default.

No

Specifies that holes are not recreated leading to disk blocks allocated for the whole address space.

## Examples

---

Options file:

```
makesparsefile no
```

Command line:

```
-makesparsefile=no
```

This option is valid only on the initial command line. It is not valid in interactive mode.

## Manageservices

---

The `manageservices` option specifies whether the IBM Spectrum Protect™ client acceptor service manages the scheduler, the web client, or both.

Restriction: You cannot use the `dsmcad` for scheduling when you set the `sessioninitiation` option to `serveronly`.

The client acceptor daemon serves as an external timer for the scheduler. When the scheduler is started, it queries the server for the next scheduled event. The event is either executed immediately or the scheduler exits. The client acceptor daemon restarts the scheduler when it is time to execute the scheduled event.

Note:

1. If you set the `schedmode` option to `prompt`, the server prompts the client acceptor daemon when it is time to run the schedule. The scheduler connects to and disconnects from the server when the client acceptor daemon is first started.

The `dsmc schedule` command cannot be used when both `schedmode prompt` and `commmethod V6Tcip` are specified.

2. **Mac OS X** For Mac OS X, if you do not specify the `manageservices` option, the client acceptor daemon manages both the scheduler program and the web client, by default.
3. **Windows** Set the `passwordaccess` option to `generate` in your client options file (`dsm.opt`) and generate a password, so IBM Spectrum Protect can manage your password automatically.
4. **AIX | Linux | Solaris | Mac OS X** Set the `passwordaccess` option to `generate` in your `dsm.sys` file and generate a password, so IBM Spectrum Protect can manage your password automatically.

Using the client acceptor daemon to manage the scheduler service can provide the following benefits:



- Memory retention problems that can occur when using traditional methods of running the scheduler are resolved. Using the client acceptor daemon to manage the scheduler requires very little memory between scheduled operations.
- The client acceptor daemon can manage both the scheduler program and the web client, reducing the number of background processes on your workstation.
- **AIX | Linux | Solaris | Mac OS X** To use the web client, you must specify this option in the client system-options file.

## Supported Clients

---

This option is valid for all clients. The IBM Spectrum Protect API does not support this option.

## Options File

---

**Windows** Place this option in the client options file (dsm.opt). You can set this option on the Web Client tab of the Preferences editor.

**AIX | Linux | Solaris | Mac OS X** Place this option in the client system-options file (dsm.sys) within a server stanza. You can set this option on the Web Client tab of the Preferences editor.

**AIX | Linux | Solaris | Mac OS X | Windows**

## Syntax

---

```
>>-MANAGEDServices--mode-----<<
```

## Parameters

---

mode

Specifies whether the client acceptor daemon manages the scheduler, the web client, or both.

**Windows** webclient

**Windows** Specifies that the client acceptor daemon manages the web client.

**AIX | Linux | Solaris | Mac OS X** webclient

**AIX | Linux | Solaris | Mac OS X** Specifies that the client acceptor daemon manages the web client. This is the default for UNIX and Linux. Both webclient and schedule are the defaults for Mac OS X.

**Mac OS X | Windows** schedule

**Mac OS X | Windows** Specifies that the client acceptor daemon manages the scheduler. Both webclient and schedule are the defaults for Mac OS X.

**Mac OS X** none

**Mac OS X** For Mac OS X, specifies that the client acceptor daemon not manage the web client or schedules. Set managedservices to none to enable the dsmc schedule command.

## Examples

---

**Windows** Options file:

**Windows** The following are examples of how you might specify the managedservices option in your client options file (dsm.opt).

Task

Specify that the client acceptor daemon manages only the web client.

```
managedservices webclient
```

Task

Specify that the client acceptor daemon manages only the scheduler.

```
managedservices schedule
```

Task

Specify that the client acceptor daemon manages both the web client and the scheduler.

```
managedservices schedule webclient
```

Note: The order in which these values are specified is not important.

Mac OS X | AIX | Linux | Solaris | Mac OS X Options file:

Mac OS X | AIX | Linux | Solaris | Mac OS X The following are examples of how you might specify the managedservices option in your client system-options file (dsm.sys).

Task

Specify that the client acceptor daemon manages only the web client.

```
managedservices webclient
```

Task

Specify that the client acceptor daemon manages only the scheduler.

```
managedservices schedule
```

Task

Specify that the client acceptor daemon manages both the web client and the scheduler.

```
managedservices schedule webclient
```

Note: The order in which these values are specified is not important.

Mac OS X Task

Mac OS X For Mac OS X, to use the dsmc schedule command, specify:

```
managedservices none
```

Command line:

Does not apply.

## Maxcmdretries

---

The maxcmdretries option specifies the maximum number of times the client scheduler (on your workstation) attempts to process a scheduled command that fails.

The command retry starts only if the client scheduler has not yet backed up a file, never connected to the server, or failed before backing up a file. This option is only used when the scheduler is running.

Your IBM Spectrum Protect™ administrator can also set this option. If your administrator specifies a value for this option, that value overrides what you specify in the client options file after your client node successfully contacts the server.

## Supported Clients

---

This option is valid for all clients. The IBM Spectrum Protect API does not support this option. The server can also define this option.

## Options File

---

AIX | Linux | Solaris | Mac OS X Place this option in the client system-options file (dsm.sys) within a server stanza. You can set this option on the Scheduler tab, in the Maximum command retries field of the Preferences editor.

Windows Place this option in the client options file (dsm.opt). You can set this option on the Scheduler tab, in the Maximum command retries field of the Preferences editor.

## Syntax

---

```
>>-MAXCMDReTRIES-- --maxcmdretries-----<<
```

## Parameters

---

maxcmdretries

Specifies the number of times the client scheduler can attempt to process a scheduled command that fails. The range of values is zero through 9999; the default is 2.

## Examples

---

Options file:  
maxcmdr 4  
Command line:  
-maxcmdretries=4

This option is valid only on the initial command line. It is not valid in interactive mode.

Linux Windows

## Mbobjrefreshthresh

---

The mbobjrefreshthresh (megablock object refresh threshold) option is a number defining a threshold. When the number of IBM Spectrum Protect™ objects that are needed to describe any 128 MB megablock exceeds this value, the entire megablock is refreshed and the objects that were used to represent this area, in previous backups, are expired.

When you backup a virtual machine, the data is stored on the IBM Spectrum Protect server in 128 MB units, called *megablocks*. If an area on the production disk changes and a new incremental backup is performed, a new megablock is created to represent the changes that were made to the previously backed up data. Because a new megablock can be created with each incremental backup, eventually the megablocks can adversely affect the performance of the IBM Spectrum Protect database, and therefore, adversely affect the performance of most IBM Spectrum Protect operations.

Use this option when estimating IBM Spectrum Protect objects that represent production data for each virtual machine backup. For example, when the number of IBM Spectrum Protect objects exceed this value, the megablock is refreshed. This action means that the entire 128-MB block is copied to the server and is represented as a single IBM Spectrum Protect object. The minimum value is 2 and the maximum value is 8192. The default value is 50.

## Supported clients

---

Linux Windows This option is valid for data movers that protect VMware virtual machines. To use this option, you must have a license agreement to use IBM Spectrum Protect for Virtual Environments: Data Protection for VMware.

Windows This option is valid for data movers that protect Microsoft Hyper-V virtual machines. You must be licensed to use IBM Spectrum Protect for Virtual Environments: Data Protection for VMware, or IBM Spectrum Protect for Virtual Environments: Data Protection for Microsoft Hyper-V to use this option.

## Options file

---

This option is valid in the client options file (dsm.opt). It can also be included on the server in a client options set. It is not valid on the command line.

## Syntax

---

```
>>-MBOBJREFRESHTHRESH .-50-----.  
+-----+-----><  
'-integer-'
```

## Parameters

---

The minimum value you can specify is 2 megablocks, the largest value is 8192 megablocks; the default is 50 megablocks.

## Examples

---

Set this option to trigger a megablock refresh when the number of objects needed to represent an updated megablock exceeds 20 objects:

```
MBOBJREFRESHTHRESH 20
```

Linux Windows

## Mbpctrefreshthresh

---

The `mbpctrefreshthresh` (megablock percentage refresh threshold) option is a number defining a threshold. When the percentage of IBM Spectrum Protect™ objects that are needed to describe any 128 MB megablock exceeds this value, the entire megablock is refreshed and the objects that were used to represent this area, in previous backups, are expired.

When you backup a virtual machine, data is stored on the IBM Spectrum Protect server in 128 MB units, called *megablocks*. If an area on the production disk changes and a new incremental backup is performed, a new megablock is created to represent the changes that were made to the previously backed up data. Because a new megablock can be created with each incremental backup, eventually the megablocks can adversely affect the performance of the IBM Spectrum Protect database, and therefore, adversely affect the performance of most IBM Spectrum Protect operations.

Use this option when estimating the amount of additional data that is backed up for each virtual machine. For example, when a 128-MB block of a production disk changes more than the percentage specified, the entire 128-MB block is copied to the server. The block is represented as a single IBM Spectrum Protect object.

## Supported clients

---

**Linux** | **Windows** This option is valid for clients that act as data mover nodes that protect VMware virtual machines. To use this option, you must have a license agreement to use IBM Spectrum Protect for Virtual Environments: Data Protection for VMware.

**Windows** This option is valid for clients that act as data mover nodes that protect Microsoft Hyper-V virtual machines. You must be licensed to use IBM Spectrum Protect for Virtual Environments: Data Protection for VMware, or IBM Spectrum Protect for Virtual Environments: Data Protection for Microsoft Hyper-V to use this option.

## Options file

---

This option is valid in the client options file (`dsm.opt`). It can also be included on the server in a client options set. It is not valid on the command line.

## Syntax

---

```
>>-MBPCTREFRESHTHRESH .-50-----.  
                        -+-----+----->>  
                        '-integer-'
```

## Parameters

---

The minimum value you can specify is 1 percent, the largest value is 99 percent; the default is 50 percent.

## Examples

---

Set this option to trigger a megablock refresh when 50 percent (or more) of the objects in a megablock on a production disk have changed:

```
MBPCTREFRESHTHRESHOLD 50
```

## Memoryefficientbackup

---

The `memoryefficientbackup` option specifies the memory-conserving algorithm to use for processing full file space backups.

One method backs up one directory at a time, using less memory. The other method uses much less memory, but requires more disk space.

Use the `memoryefficientbackup` option with the `incremental` command when your workstation is memory constrained. You can also use this option as a parameter to the `include.fs` option in order to select the algorithm that the backup-archive client uses on a per-filespace basis.

**Windows** Use `memoryefficientbackup=diskcachemethod` for any file space that has too many files for the client to complete the incremental backup with either the default setting, `memoryefficientbackup=no`, or with `memoryefficientbackup=yes`. The disk

cache file created by the initial disk cache incremental backup can require up to 5 GB of disk space for each million files or directories being backed up.

**AIX Linux Solaris Mac OS X** Use `memoryefficientbackup=diskcachemethod` for any file space that has too many files for the client to complete the incremental backup with either the default setting, `memoryefficientbackup=no`, or with `memoryefficientbackup=yes`.

**Mac OS X AIX Linux Solaris Mac OS X** The actual amount of disk space required for the disk cache file created by disk cache incremental backups depends on the number of files and directories included in the backup and on the average path length of the files and directories to be backed up. For UNIX and Linux estimate 1 byte per character in the path name. For Mac OS X, estimate 4 bytes per character in the path name. For example, if there are 1 000 000 files and directories to be backed up and the average path length is 200 characters, then the database occupies approximately 200 MB for UNIX and Linux, and 800 MB for Mac OS X clients. Another way to estimate for planning purposes is to multiply the number of files and directories by the length of the longest path to establish a maximum database size.

**Windows** The actual amount of disk space required for the disk cache file created by disk cache incremental backups depends on the number of files and directories included in the backup and on the average path length of the files and directories to be backed up. Estimate 2 bytes per character in the path name. For example, if there are 1 000 000 files and directories to be backed up and the average path length is 200 characters, then the database occupies approximately 400 MB. Another way to estimate for planning purposes is to multiply the number of files and directories by the length of the longest path to establish a maximum database size.

**AIX Linux Solaris Mac OS X** A second disk cache file is created for the list of migrated files when backing up an HSM managed file system. The combined disk cache files, created by disk cache incremental backups and HSM managed file system backups, can require above 400 MB of disk space for each million files being backed up. The disk cache file can become very large. Large file support must be enabled on the file system that is being used for the disk cache file.

## Supported Clients

---

This option is valid for all clients. The server can also define this option.

## Options File

---

**AIX Linux Solaris Mac OS X** This option is allowed in `dsm.opt` and within a server stanza in `dsm.sys`, but the value in `dsm.opt` is ignored if it also appears in `dsm.sys`. You can also place this option on the initial command line. In interactive mode, this option can be used with the incremental command. You can also set this option on the Performance Tuning tab in the Preferences editor, and selecting the Use memory-saving algorithm check box.

**Windows** Place this option in the client user-options file (`dsm.opt`), or on the initial command line. You can also set this option on the Performance Tuning tab in the Preferences editor, and selecting the Use memory-saving algorithm check box.

## Syntax

---

```
..-No-----<br>>>-MEMORYEfficientbackup--+-+-----+-----<br>+-Yes-----<br>'-DISKCACHEMethod-'
```

## Parameters

---

No

Your client node uses the faster, more memory-intensive method when processing incremental backups. This is the default.

Yes

Your client node uses the method that requires less memory when processing incremental backups.

Diskcachemethod

Your client node uses the method that requires much less memory but more disk space when processing incremental backups for full file systems.

## Examples

---

Options file:

```
memoryefficientbackup yes
memoryefficientbackup diskcachem
```

Command line:  
-memoryef=no

AIX Linux Solaris Windows

## Mode

Use the mode option to specify the backup mode to use when performing specific backup operations.

The mode option has no effect on a when backing up a raw logical device.

You can use the mode option with the following backup commands:

backup image

To specify whether to perform a selective or incremental image backup of client file systems.

AIX Solaris Windows backup nas

To specify whether to perform a full or differential image backup of NAS file systems.

backup group

To specify whether to perform a full or differential group backup containing a list of files from one or more file space origins.

backup vm

Linux Windows For VMware virtual machines, this parameter specifies whether to perform an incremental-forever-full or incremental-forever-incremental backup of VMware virtual machines.

Windows For Microsoft Hyper-V virtual machines, this parameter specifies whether to perform an incremental-forever full or incremental-forever-incremental backup of Hyper-V virtual machines.

 This feature is available only if the client operates as a data mover for IBM Spectrum Protect™ for Virtual Environments.

## Supported Clients

This option is valid on all supported clients, except Mac OS. The IBM Spectrum Protect API does not support this option.

Linux Windows This option is valid for data movers that protect VMware virtual machines. To use this option, you must have a license agreement to use IBM Spectrum Protect for Virtual Environments: Data Protection for VMware.

Windows This option is valid for data movers that protect Microsoft Hyper-V virtual machines. You must be licensed to use IBM Spectrum Protect for Virtual Environments: Data Protection for VMware, or IBM Spectrum Protect for Virtual Environments: Data Protection for Microsoft Hyper-V to use this option.

## Syntax

For image backups of client file systems

```
>>-MODE = .-Selective---
           +-----+-----><
           '-Incremental-'
```

AIX Solaris Windows

For image backup of NAS file systems

```
>>-MODE = .-differential-
           +-----+-----><
           '-full-----'
```

For group backups

```
>>-MODE = .-full-----.
           +-----+-----><
           '-differential-'
```

For backing up VMware virtual machines

```

      .-IFIncremental-.
>>-MODE= -+-----+-----><
          '-IFFull-----'

```

For backing up Microsoft Hyper-V virtual machines

```

      .-IFIncremental-.
>>-MODE = -+-----+-----><
          '-IFFull-----'

```

## Parameters

Image backup parameters

### selective

Specifies that you want to perform a full (selective) image backup. This is the default mode for image backups of client file systems.

### incremental

Specifies that you want to back up only the data that has changed since the most recent image backup. If an image backup has not already been created, then the first backup is a full image backup (mode=selective), regardless of what mode option you specify.

NAS backup parameters

### differential

This is the default for NAS objects. Specifies that you want to perform a NAS backup of files that changed since the last full backup. If there is no copy of a full image stored on the IBM Spectrum Protect server, a full backup occurs. If a full image exists, whether it is restorable, or expired and being maintained because of dependent differential images, specifying MODE=differential sends a differential image backup. If a full image is sent during a differential backup, it is reflected as a full image using the QUERY NASBACKUP server command.

A full image can be eligible for expiration based on versioning or retention (verexists retextra), but still be maintained on the server to allow for restoring dependent differential images. A full image that is eligible for expiration cannot be selected for restore, so it is not displayed using the QUERY NASBACKUP server command. The differential image backups that depend on an "expired" full image can be restored.

### full

Specifies that you want to perform a full backup of NAS file systems.

Group backup parameters

### full

Specifies that you want to perform a full backup of group objects. This is the default for group backups.

### differential

Specifies that you want to perform a group backup of files that changed since the last full backup. If there is no copy of a full image stored on the IBM Spectrum Protect server, a full backup occurs. If a full image exists, whether it is restorable, or expired and being maintained because of dependent differential images, specifying MODE=differential sends a differential image backup. If a full image is sent during a differential backup, it is reflected as a full image using the QUERY GROUP server command.

A full image can be eligible for expiration based on versioning or retention (verexists retextra), but still be maintained on the server to allow for restoring dependent differential images. A full image that is eligible for expiration cannot be selected for restore, so it is not displayed using the QUERY GROUP server command. The differential image backups that depend on an "expired" full image can be restored.

## VMware virtual machine parameters

### IFFull

Specifies that you want to perform an incremental-forever-full backup of a virtual machine. An incremental-forever-full backup backs up all used blocks on a VMware virtual machine's disks.

By default, the first backup of a VMware virtual machine is an incremental-forever-full (`mode=iffull`) backup, even if you specify `mode=ifincremental` (or let the mode option default). Subsequent backups default to `mode=ifincremental`.

You cannot use this backup mode to back up a virtual machine if the client is configured to encrypt the backup data.

For a description of the incremental-forever backup strategy for VMware virtual machines, see Backup and restore types.

### IFIncremental

Specifies that you want to perform an incremental-forever-incremental backup of a virtual machine. An incremental-forever-incremental backup backs up only the disk blocks that have changed since the last backup.

This mode is the default backup mode for VMware virtual machine backups.

You cannot use this backup mode to back up a virtual machine if the client is configured to encrypt the backup data.

## Windows

## Microsoft Hyper-V virtual machine parameters

### IFIncremental

Specifies that you want to perform an incremental-forever-incremental backup of a Hyper-V virtual machine. An incremental-forever-incremental backup backs up only the disk blocks that have changed since the last backup.

This mode is the default backup mode for Hyper-V backups.

You cannot use this backup mode to back up a virtual machine if the client is configured to encrypt the backup data.

For a description of the incremental-forever backup strategy for Hyper-V virtual machines, see Incremental-forever backup strategy.

### IFFull

Specifies that you want to perform an incremental-forever-full backup of a Hyper-V virtual machine. An incremental-forever-full backup backs up all used blocks on a virtual machine's disks.

By default, the first backup of a Hyper-V virtual machine is an incremental-forever-full (`mode=iffull`) backup, even if you specify `mode=ifincremental` (or let the mode option default). Subsequent backups default to `mode=ifincremental`.

You cannot use this backup mode to back up a virtual machine if the client is configured to encrypt the backup data.

## Examples

---

### Task

**Linux** **Windows** Perform a backup of a VMware virtual machine named `vm1`, using the incremental-forever-incremental mode to back up only the data that has changed since the last backup.

```
dsmc backup vm vm1 -mode=ifincremental  
-vmbackuptype=full
```

### Windows Task

**Windows** Perform an incremental-forever-full VM backup of a Hyper-V VM named `msvm1`

```
dsmc backup vm msvm1 -mode=iffull
```

### Windows Task

**Windows** Perform an incremental-forever-incremental backup of a Hyper-V VM named `msvm1`

```
dsmc backup vm msvm1 -mode=ifincremental
```



AIX Solaris Task

AIX Solaris Perform the NAS image backup of the entire file system.

```
dsmc backup nas -mode=full -nasnodename=nas1  
/vol/vol0 /vol/vol1
```

Windows Task

Windows Perform the NAS image backup of the entire file system.

```
dsmc backup nas -mode=differential -nasnodename=nas1  
{/vol/vol0} {/vol/vol1}
```

AIX Linux Task

AIX Linux Back up the /home/test file space using an image incremental backup that backs up only new and changed files after the last full image backup.

```
dsmc backup image /home/test -mode=incremental -snapshotproviderimage=none
```

Windows Task

Windows Back up the c: drive using an image incremental backup that backs up only new and changed files after the last full image backup.

```
dsmc backup image c: -mode=full
```

AIX Linux Solaris Task

AIX Linux Solaris Perform a full backup of all the files in filelist /home/dir1/filelist1 to the virtual file space name /virtfs containing the group leader /home/group1 file.

```
dsmc backup group -filelist=/home/dir1/filelist1  
-groupname=group1 -virtualfsname=/virtfs -mode=full
```

Windows Task

Windows Perform a full backup of all the files in filelist c:\dir1\filelist1 to the virtual file space name \virtfs containing the group leader c:\group1 file.

```
dsmc backup group -filelist=c:\dir1\filelist1 -groupname=group1  
-virtualfsname=\virtfs -mode=incremental -vmbackuptype=fullvm
```

#### Related reference:

Backup VM  
Backup Group  
Backup Image  
Backup NAS

AIX Linux Solaris Windows

## Monitor

---

The monitor option specifies whether to monitor an image backup or restore of file systems belonging to a Network Attached Storage (NAS) file server.

If you specify monitor=yes, the backup-archive client monitors the current NAS image backup or restore operation and displays processing information on your screen. This is the default.

If you specify monitor=no, the client does not monitor the current NAS image backup or restore operation and is available to process the next command.

Use this option with the backup nas or restore nas commands.

## Supported Clients

---

AIX Linux Solaris This option is valid for AIX®, Linux, and Solaris clients *only*.

Windows This option is valid for all Windows clients.

## Syntax

---

```
    .-Yes-.
>>-MONitor = -+-----+-----><
    '-No--'
```

## Parameters

---

Yes

Specifies that you want to monitor the current NAS image backup or restore operation and display processing information on your screen. This is the default.

No

Specifies that you do not want to monitor the current NAS image backup or restore operation.

## Examples

---

Command line:

```
AIX | Linux | Solaris

backup nas -mode=full -nasnodename=nas1 -monitor=yes
/vol/vol0 /vol/vol1
```

```
Windows

backup nas -mode=full -nasnodename=nas1 -monitor=yes
{/vol/vol0} {/vol/vol1}
```

**Windows**

## Myprimaryserver

---

The myprimaryserver option specifies the primary server name that the client uses to log on to the secondary server in failover mode.

During the normal (non-failover) logon process, the myprimaryserver option is sent to the client and is saved in the dsm.opt file. Do not edit this option during normal operations.

Important: If you change the value for the myprimaryserver option, authentication information such as the IBM Spectrum Protect™ password and encryption key will no longer work with the new primary server. You will be prompted for the password and encryption key for operations that require authentication. Therefore, do not change this value even if you change the secondary server connection information.

## Supported Clients

---

This option is valid only for Windows clients.

## Options File

---

This option is placed in the client options file (dsm.opt).

## Syntax

---

```
>>-MYPRIMARYServer----primary_servername-----><
```

## Parameters

---

primary\_servername

Specifies the name of the primary server to be used for authentication during a failover. The primary server is the IBM Spectrum Protect server that a client uses for normal production.

## Examples

---

Options file:

```
*** These options should not be changed manually
REPLSERVERNAME          TARGET
REPLTCPSERVERADDRESS    192.0.2.9
REPLTCPSPORT            1501
REPLSERVERGUID          60.4a.c3.e1.85.ba.11.e2.af.ce.00.0c.29.2f.07.d3

MYREPLICATIONServer     TARGET
MYPRIMARYSERVERNAME     SERVER1
*** end of automatically updated options
```

Command line:  
Does not apply.

**Related concepts:**  
Automated client failover configuration and use  
**Related tasks:**  
Configuring the client for automated failover

## Myreplserver

---

The myreplserver option specifies which secondary server stanza that the client uses during a failover.

The secondary server stanza is identified by the replservername option and contains connection information about the secondary server.

This option is set by the IBM Spectrum Protect™ server administrator for the client node. During the normal (non-failover) logon process, the option is sent to the client and is saved in the client options file.

Do not edit this option during normal operations.

Edit this option only during situations such as the following ones:

- The primary server is offline and the information for the secondary server is not in the options file.
- The secondary server information is out-of-date or incorrect.

Any values that you edit are removed or updated the next time you log in to the primary server.

## Supported Clients

---

This option is valid for all clients.

## Options File

---

- AIX** | **Linux** | **Solaris** | **Mac OS X** This option is placed within a server stanza in the dsm.sys file.
- Windows** This option is placed in the client options file (dsm.opt).

## Syntax

---

```
>>-MYREPLICATIONServer----repl_servername-----<<
```

## Parameters

---

**repl\_servername**  
Specifies the name of the stanza for the secondary server to be used during a failover. This value is usually the name of the secondary server, not the host name of the server. Also, the value of the repl\_servername parameter is not case-sensitive, but the value must match the value that is specified for the REPLSERVERName option.

## Examples

---

Options file:  
MYREPLICATIONServer TargetReplicationServer1  
Command line:

Does not apply.

**AIX** **Linux** **Mac OS X** **Solaris** Options file:

**AIX** **Linux** **Mac OS X** **Solaris** The following example demonstrates how to specify options for three different servers in the dsm.sys file, and how to reference the secondary server. Connection information for multiple secondary server is presented in stanzas. Each stanza is identified by the replservername option and the name of the secondary server. The servername stanza must contain the myreplicationserver option, which points to the secondary server that is specified by the replservername stanza. Only one secondary server can be specified per servername stanza.

```
REPLSERVERNAME    TargetReplicationServer1
REPLTCPSEVERADDRESS TargetReplicationServer1
REPLTCPSPORT      1505
REPLSSLPORT       1506
REPLSERVERGUID    91.0f.ef.90.5c.cc.11.e1.ae.34.08.00.00.00.00

REPLSERVERNAME    TargetReplicationServer2
REPLTCPSEVERADDRESS TargetReplicationServer2
REPLTCPSPORT      1505
REPLSSLPORT       1506
REPLSERVERGUID    91.0f.ef.90.5c.cc.11.e1.ae.34.08.00.00.00.00.02

SErvername        server_a
COMMMethod        TCPip
TCPSPort          1500
TCPSEveraddress   server_hostname1.example.com
PASSWORDAccess    prompt
MYREPLICATIONServer TargetReplicationServer1

SErvername        server_b
COMMMethod        TCPip
TCPSPort          1500
TCPSEveraddress   server_hostname2.example.com
PASSWORDAccess    generate
INCLExcl          /adm/tsm/archive.excl
MYREPLICATIONServer TargetReplicationServer2

SErvername        server_c
COMMMethod        TCPip
TCPSPort          1500
TCPSEveraddress   server_hostname3.example.com
PASSWORDAccess    generate
MYREPLICATIONServer TargetReplicationServer1
```

**Windows** Options file:

**Windows** The following example demonstrates how to specify options for the secondary server in the dsm.opt file, and how to reference the secondary server. The connection information for the secondary server is located within the REPLSERVERName stanza. The MYREPLICATIONServer option points to the secondary server name that is specified by the REPLSERVERName stanza.

```
REPLSERVERNAME    TargetReplicationServer1
REPLTCPSEVERADDRESS TargetReplicationServer1
REPLTCPSPORT      1505
REPLSSLPORT       1506
REPLSERVERGUID    91.0f.ef.90.5c.cc.11.e1.ae.34.08.00.00.00.00.00

COMMMethod        TCPip
TCPSPort          1500
TCPSEveraddress   server_hostname1.example.com
PASSWORDAccess    prompt
MYREPLICATIONServer TargetReplicationServer1
MYPRIMARYSERVER   Server1
```

#### Related concepts:

Automated client failover configuration and use

#### Related tasks:

Configuring the client for automated failover

**Windows**

## Namedpipename

The `namedpipename` option specifies the name of a named pipe to use for communications between a client and a server on the same Windows server domain.

## Supported Clients

---

This option is valid for all Windows clients.

## Options File

---

Place this option in the client options file (`dsm.opt`). You can set this option on the Communication tab of the Preferences editor.

## Syntax

---

```
>>-NAMEDpipename-- --name-----><
```

## Parameters

---

**name**  
The name of a named pipe. The default is `\\.\pipe\Server1`.

## Examples

---

Options file:  
`namedpipename \\.\pipe\dsmser1`  
Command line:  
`-namedpipename=\\.\pipe\dsmser1`

This option is valid only on the initial command line. It is not valid in interactive mode.

AIX Linux Solaris Windows

## Nasnodename

---

The `nasnodename` option specifies the node name for the NAS file server when processing NAS file systems. The client prompts you for an administrator ID.

The node name identifies the NAS file server to the IBM Spectrum Protect™ server. The server must register the NAS file server.

AIX Linux Solaris You can specify this option on the command line or in the client system-options file (`dsm.sys`).

AIX Linux Solaris You can override the default value in the `dsm.sys` file by entering a different value on the command line. If you do not specify the `nasnodename` option in the `dsm.sys` file, you must specify this option on the command line when processing NAS file systems.

Windows You can specify this option on the command line or in the client options file (`dsm.opt`).

Windows You can override the default value in the `dsm.opt` file by entering a different value on the command line. If you do not specify the `nasnodename` option in the `dsm.opt` file, you must specify this option on the command line when processing NAS file systems.

You can use the `nasnodename` option with the following commands:

- `backup nas`
- `delete filespace`
- `query backup`
- `query filespace`
- `restore nas`

You can use the `delete filespace` command to interactively delete NAS file spaces from server storage.

AIX Linux Solaris Use the `nasnodename` option to identify the NAS file server. Place the `nasnodename` option in your client system-options file (`dsm.sys`). The value in the client system-options file is the default, but this value can be overridden on

the command line. If the `nasnodename` option is not specified in the client system-options file, you must specify this option on the command line when processing NAS file systems.

**Windows** Use the `nasnodename` option to identify the NAS file server. Place the `nasnodename` option in your client options file (`dsm.opt`). The value in the client options file is the default, but this value can be overridden on the command line. If the `nasnodename` option is not specified in the client options file, you must specify this option on the command line when processing NAS file systems.

Use the `class` option to specify the class of the file space to delete. To display a list of file spaces belonging to a NAS node so that you can choose one to delete, use the `-class=nas` option.

To delete NAS file spaces using the web client, see the topic for backing up your data.

## Supported Clients

---

**AIX** | **Linux** | **Solaris** This option is only valid for the AIX®, Linux, and Solaris clients. The IBM Spectrum Protect API does not support this option.

**Windows** This option is valid for all Windows clients. The IBM Spectrum Protect client API does not support this option.

## Options File

---

**AIX** | **Linux** | **Solaris** Place this option in the client system-options file (`dsm.sys`) within a server stanza. You can set this option on the General tab of the Preferences editor.

**Windows** Place this option in the client options file (`dsm.opt`). You can set this option on the General tab of the Preferences editor.

## Syntax

---

```
>>-NASnodename-- --nodename-----><
```

## Parameters

---

`nodename`  
Specifies the node name for the NAS file server.

## Examples

---

Options file:  
`nasnodename nas2`  
Command line:  
`-nasnodename=nas2`

**AIX** | **Linux** | **Solaris** | **Mac OS X**

## Nfstimeout

---

The `nfstimeout` option specifies the number of seconds the client waits for a status system call on an NFS file system before it times out.

You can use this option to mitigate the default behavior of status calls on file systems. For example, if an NFS file system is stale, a status system call is timed out by NFS (soft mounted) or hang the process (hard mounted).

When the value of this option is changed to a value other than zero, a new thread is created by a caller thread to issue the status system call. The new thread is timed out by the caller thread and the operation can continue.

**Solaris** Note: On Solaris, the `nfstimeout` option can fail if the NFS mount is hard. If a hang occurs, deactivate the `nfstimeout` option and mount the NFS file system soft mounted, as follows:

```
mount -o soft,timeo=5,retry=5 machine:/filesystem /mountpoint
```

The parameters are defined as follows:

soft

Generates a soft mount of the NFS file system. If an error occurs, the `stat()` function returns with an error. If the option `hard` is used, `stat()` does not return until the file system is available.

timeo=*n*

Sets the time out for a soft mount error to *n* tenths of a second.

retry=*n*

Set the internal retries and the mount retries to *n*, the default is 10000.

## Supported Clients

---

This option is for all UNIX and Linux clients. The server can also define this option.

## Options File

---

Place this option in the `dsm.sys` file within a server stanza *or* the client options file (`dsm.opt`).

## Syntax

---

```
>>-NFSTIMEout-- --number-----><
```

## Parameters

---

number

Specifies the number of seconds the client waits for a status system call on a file system before timing out. The range of values is 0 through 120; the default is 0 seconds.

## Examples

---

Options file:

```
nfsttimeout 10
```

Command line:

```
-nfsttimeout=10
```

This option is valid only on the initial command line. It is not valid in interactive mode.

## Nodename

---

Use the `nodename` option in your client options file to identify your workstation to the server. You can use different node names to identify multiple operating systems on your workstation.

When you use the `nodename` option, you are prompted for the password that is assigned to the node that you specify, if a password is required.

If you want to restore or retrieve files from the server while you are working from a different workstation, use the `virtualnodename` option. You can also use the `asnodename` option, if it is set up by the administrator.

**Windows** If you are working from a different workstation, you can use the `nodename` option even if the `passwordaccess` option is set to generate. To prevent this, use the `virtualnodename` option instead of `nodename`.

**Windows** The node name is not necessarily the TCP/IP host name.

When connecting to a server, the client must identify itself to the server. This login identification is determined in the following manner:

- **AIX Linux Solaris Mac OS X** In the absence of a `nodename` entry in the `dsm.sys` file, or a `virtualnodename` entry in the client user-options file (`dsm.opt`), or a virtual node name specified on a command line, the default login ID is the name that the `hostname` command returns.
- **AIX Linux Solaris Mac OS X** If a `nodename` entry exists in the `dsm.sys` file, the `nodename` entry overrides the name that the `hostname` command returns.
- **AIX Linux Solaris Mac OS X** If a `virtualnodename` entry exists in the client system-options file (`dsm.sys`), or a virtual node name is specified on a command line, it cannot be the same name as the name returned by the `hostname`

command. When the server accepts the virtual node name, a password is required (if authentication is on), even if the passwordaccess option is generate. When a connection to the server is established, access is permitted to any file that is backed up using this login ID.

- **Windows** In the absence of a nodename entry in the dsm.opt file, or a virtualnodename entry in the client options file (dsm.opt), or a virtual node name specified on a command line, the default login ID is the name that the hostname command returns.
- **Windows** If a nodename entry exists in the dsm.opt file, the nodename entry overrides the name that the hostname command returns.
- **Windows** If a virtualnodename entry exists in the client options file (dsm.opt), or a virtual node name is specified on a command line, it cannot be the same name as the name returned by the hostname command. When the server accepts the virtual node name, a password is required (if authentication is on), even if the passwordaccess option is generate. When a connection to the server is established, access is permitted to any file that is backed up using this login ID.

AIX Linux Solaris Mac OS X Windows

## Supported Clients

---

This option is valid for all clients.

## Options File

---

AIX Linux Solaris Mac OS X Place this option in the dsm.sys file within a server stanza. You can set this option on the General tab, in the Node Name field of the Preferences editor.

Windows Place this option in the client options file (dsm.opt). You can set this option on the General tab, in the Node Name field of the Preferences editor.

## Syntax

---

```
>>-NODename-- --nodename-----<<
```

## Parameters

---

AIX Linux Solaris Mac OS X nodename

AIX Linux Solaris Mac OS X Specifies a 1 to 64 character node name for which you want to request IBM Spectrum Protect™ services. The default is the value returned with the hostname command.

Not specifying a node name permits the node name to default to the host name of the workstation

Windows nodename

Windows Specifies a 1 to 64 character node name for which you want to request IBM Spectrum Protect services. The default is the value returned with the hostname command.

Not specifying a node name permits the node name to default to the host name of the workstation

## Examples

---

Options file:

```
nodename cougar
```

Windows Command line:

```
Windows -nodename=cougar
```

Windows This option is valid only on the initial command line. It is not valid in interactive mode.

Windows

## Nojournal

---

Use the nojournal option with the incremental command to specify that you want to perform a traditional full incremental backup, instead of the default journal-based backup.

Journal-based incremental backup differs from the traditional full incremental backup in the following ways:



- Non-default copy frequencies (other than 0) are not enforced on the IBM Spectrum Protect™ server.
- Attribute changes to an object require a backup of the entire object.

For these reasons, you might want to use the nojournal option periodically to perform a traditional full incremental backup.

## Supported Clients

---

This option is valid for all Windows clients. The IBM Spectrum Protect API does not support this option.

## Syntax

---

```
>>-NOJournal-----<<
```

## Parameters

---

There are no parameters for this option.

## Examples

---

Command line:

```
dsmc incr c: -nojournal
```

AIX

Linux

## Nojournal

---

Use the nojournal option with the incremental command to specify that you want to perform a traditional full incremental backup, instead of the default journal-based backup.

Journal-based incremental backup differs from the traditional full incremental backup in the following ways:

- Non-default copy frequencies (other than 0) are not enforced on the IBM Spectrum Protect™ server.
- UNIX special file changes are not detected by the Journal daemon and are not, therefore, backed up.

For these reasons, you want to use the nojournal option periodically to perform a traditional full incremental backup.

## Supported Clients

---

This option is valid for the AIX® and Linux backup-archive client.

## Syntax

---

```
>>-NOJournal-----<<
```

## Parameters

---

There are no parameters for this option.

## Examples

---

Command line:

```
dsmc incr /home -nojournal
```

## Noprompt

---

The noprompt option suppresses the confirmation prompt that is presented by the delete group, delete archive, expire, restore image, and set event commands.

- delete archive
- delete backup
- delete group
- expire
- |     |       |         |         |
|-----|-------|---------|---------|
| AIX | Linux | Solaris | Windows |
|-----|-------|---------|---------|

 restore image

Mac OS X
----------

 Note: The restore image command does not apply to Mac OS X operating systems.

AIX	Linux	Solaris	Mac OS X	Windows
-----	-------	---------	----------	---------

## Supported Clients

This option is valid for all clients. The IBM Spectrum Protect™ API does not support this option.

## Syntax

```
>>-NOPrompt-----<<
```

## Parameters

There are no parameters for this option.

## Examples

Mac OS X
----------

 Command line:  

Mac OS X	dsmc delete archive -noprompt "/Users/van/Documents/*"
----------	--

AIX	Linux	Solaris	Mac OS X
-----	-------	---------	----------

 Command line:  

AIX	Linux	Solaris	Mac OS X	dsmc delete archive -noprompt "/home/project/*"
-----	-------	---------	----------	---

Windows
---------

 Command line:  

Windows	dsmc delete archive -noprompt c:\home\project\*
---------	---

## Nrtablepath

The nrtablepath option specifies the location of the node replication table on the client. The backup-archive client uses this table to store information about each backup or archive operation to the IBM Spectrum Protect™ server.

The server to which you back up your data must be at version 7.1 or newer and must replicate client node data to the secondary server.

When a failover occurs, the information that is on the secondary server might not be the most recent version if replication did not happen before the failover. The client can compare the information in the node replication table against the information that is on the secondary server to determine whether the backup on the server is the most recent backup version.

## Supported Clients

This option is valid for all clients.

## Options File

AIX	Linux	Solaris	Mac OS X
-----	-------	---------	----------

 Place this option in the client system-options file (dsm.sys).

Windows
---------

 Place this option in the client options file (dsm.opt).

This option can also be configured in the client option set on the IBM Spectrum Protect server.

## Syntax

```
>>-NRTABLEPath----path-----<<
```

## Parameters

path

Specifies the location where the node replication table database is created. The default location is the backup-archive client installation directory.

**AIX** | **Linux** | **Mac OS X** | **Solaris** For non-root users, you must specify a path that your user ID has write access to, such as a temporary directory. Most non-root users do not have access to the client installation directory.

**AIX** | **Linux** | **Mac OS X** | **Solaris** Restriction: The node replication table cannot be created in the root directory (/). If you choose to specify a location for the node replication table, do not specify the root directory.

**Windows** Restriction: The node replication table cannot be created in the C:\ directory. If you choose to specify a location for the node replication table, do not specify the C:\ directory.

## Example

Options file:

**AIX** | **Linux** | **Mac OS X** | **Solaris** nrtablepath /Volumes/nrtbl

**Windows** nrtablepath C:\nrtbl

Command line:

Does not apply.

### Related tasks:

Determining the status of replicated client data

Configuring the client for automated failover

## Numberformat

The numberformat option specifies the format you want to use to display numbers.

**Windows** Use this option if you want to change the default number format for the language of the message repository you are using.

**AIX** | **Solaris** The AIX® and Solaris clients support locales other than English that describe every user interface that varies with location or language.

**AIX** | **Linux** | **Solaris** | **Mac OS X** | **Windows** By default, the backup-archive and administrative clients obtain format information from the locale definition in effect at the time the client is called. Consult the documentation on your local system for details about setting up your locale definition.

**Note:** The numberformat option does not affect the web client. The web client uses the number format for the locale that the browser is running in. If the browser is not running in a supported locale, the web client uses the number format for US English.

You can use the numberformat option with the following commands:

- delete archive
- delete backup
- expire
- query archive
- **Windows** query asr
- query backup
- **AIX** | **Linux** | **Solaris** | **Windows** query image
- **AIX** | **Linux** | **Solaris** | **AIX** | **Mac OS X** | **Windows** query nas
- **Windows** query systemstate
- restore
- **AIX** | **Linux** | **Solaris** | **Windows** restore image
- **AIX** | **Linux** | **Solaris** | **Mac OS X** | **Windows** restore nas
- **Windows** restore registry
- retrieve
- set event

**AIX** | **Linux** | **Solaris** | **Mac OS X** | **Windows**

## Supported Clients

This option is valid for all clients.

## Options File

**AIX** | **Linux** | **Solaris** | **Mac OS X** | **Windows** Place this option in the client user-options file (dsm.opt). You can set this option on the Regional Settings tab, Number Format field of the Preferences editor.

## Syntax

```
>>-NUMBERformat-- --number-----><
```

## Parameters

### number

Displays numbers using any one of the following formats. Specify the number (0–6) that corresponds to the number format you want to use.

0

Use the locale-specified date format. This is the default (does not apply to Mac OS X).

1

1,000.00

**AIX** | **Linux** | **Solaris** | **Mac OS X** | **Windows** This is the default for the following available translations:

**AIX** | **Linux** | **Solaris** | **Mac OS X** | **Windows**

- US English
- Japanese
- Chinese (Traditional)
- Chinese (Simplified)
- Korean

2

1,000,00

3

1 000,00

**AIX** | **Linux** | **Solaris** | **Mac OS X** | **Windows** This is the default for the following available translations:

**AIX** | **Linux** | **Solaris** | **Mac OS X** | **Windows**

- French
- Czech
- Hungarian
- Polish
- Russian

4

1 000.00

5

1.000,00

**AIX** | **Linux** | **Solaris** | **Mac OS X** | **Windows** This is the default for the following available translations:

**AIX** | **Linux** | **Solaris** | **Mac OS X** | **Windows**

- Brazilian Portuguese
- German
- Italian
- Spanish

6

1'000,00

**AIX** | **Solaris** For AIX and Solaris: To define number formats, modify the following lines in the source file of your locale. Whatever format you select applies both to output and to input.

AIX Solaris

decimal\_point

The character that separates the whole number from its fractional part.

thousands\_sep

The character that separates the hundreds from the thousands from the millions.

grouping

The number of digits in each group that is separated by the thousands\_sep character.

## Examples

---

Options file:

```
num 4
```

Command line:

```
-numberformat=4
```

This option is valid on the initial command line and in interactive mode. If you use this option in interactive mode, it affects only the command with which it is specified. When that command completes, the value reverts to the value at the beginning of the interactive session. This is the value from the dsm.opt file unless overridden by the initial command line or by an option forced by the server.

## Optfile

---

The optfile option specifies the client options file to use when you start a backup-archive client session.

AIX Linux Solaris Mac OS X Windows

## Supported Clients

---

This option is valid for all clients.

## Syntax

---

```
>>-OPTFILE = - --file_name-----<<
```

## Parameters

---

file\_name

Specifies an alternate client options file, if you use the fully qualified path name. If you specify only the file name, the client assumes the file name specified is located in the current working directory. The default is dsm.opt.

AIX Linux Solaris Mac OS X

**Restriction:** Specify the full path when you use this option with the client acceptor daemon (dsmcad), because the client acceptor daemon changes its working directory to root ("/") after initialization.

## Examples

---

Command line:

AIX Linux Solaris Mac OS X Windows

```
dsmc query session -optfile=myopts.opt
```

AIX Linux Solaris Mac OS X

Client acceptor daemon:

AIX Linux Solaris Mac OS X

```
dsmcad -optfile=/usr/tivoli/tsm/client/ba/bin/myopts.opt
```

This option is valid only on the initial command line. It is not valid in interactive mode.

## Password

---

The password option specifies a password for IBM Spectrum Protect™.

If you do not specify this option and your administrator has set authentication to On, you are prompted for a password when you start a backup-archive client session.

Note:

1. If the server prompts for a password, the password is not displayed as you enter it. However, if you use the password option on the command line, your password is displayed as you enter it.
2. If the IBM Spectrum Protect server name changes or the backup-archive clients are directed to a different server, all clients must re-authenticate with the server because the stored encrypted password must be regenerated.

The password option is ignored when the passwordaccess option is set to generate.

AIX Linux Solaris Mac OS X Windows

## Supported Clients

This option is valid for all clients.

## Options File

Windows Place this option in the client options file (dsm.opt).

AIX Linux Solaris Mac OS X Place this option in the client user-options file (dsm.opt).

## Syntax

```
>>-PASsword-- --password-----><
```

## Parameters

*password*

Specifies the password you use to log on to the IBM Spectrum Protect server.

Passwords can be up to 63 character in length. Password constraints vary, depending on where the passwords are stored and managed, and depending on the version of the server that your client connects to.

If your IBM Spectrum Protect server is at version 6.3.3 or later, and if you use an LDAP directory server to authenticate passwords

Use any of the following characters to create a password:

```
a b c d e f g h i j k l m n o p q r s t u v w x y z  
A B C D E F G H I J K L M N O P Q R S T U V W X Y Z  
0 1 2 3 4 5 6 7 8 9 . ! @ # $ % ^ & * _ - + = ` ( )  
| { } [ ] : ; < > , ? / ~
```

Passwords are case-sensitive and are subject to more restrictions that can be imposed by LDAP policies.

If your IBM Spectrum Protect server is at version 6.3.3 or later, and if you do not use an LDAP directory server to authenticate passwords

Use any of the following characters to create a password:

```
a b c d e f g h i j k l m n o p q r s t u v w x y z  
A B C D E F G H I J K L M N O P Q R S T U V W X Y Z  
0 1 2 3 4 5 6 7 8 9 . ! @ # $ % ^ & * _ - + = ` ( )  
| { } [ ] : ; < > , ? / ~
```

Passwords are stored in the IBM Spectrum Protect server database and are not case-sensitive.

If your IBM Spectrum Protect server is earlier than version 6.3.3

Use any of the following characters to create a password:

```
a b c d e f g h i j k l m n o p q r s t u v w x y z  
A B C D E F G H I J K L M N O P Q R S T U V W X Y Z  
0 1 2 3 4 5 6 7 8 9  
_ - & + .
```

Passwords are stored in the IBM Spectrum Protect server database and are not case-sensitive.

**AIX** | **Linux** | **Mac OS X** | **Solaris** | **Windows** Remember:

On the command line, enclose all parameters that contain one or more special characters in quotation marks. Without quotation marks, the special characters can be interpreted as shell escape characters, file redirection characters, or other characters that have significance to the operating system.

**Windows**

On Windows systems:

Enclose the command parameters in quotation marks ("").

Command line example:

```
dsmc set password "t67@#$$%^&" "pass2><w0rd"
```

**AIX** | **Linux** | **Solaris**

On AIX®, Linux, and Solaris systems:

Enclose the command parameters in single quotation marks (').

Command line example:

```
dsmc set password -type=vmguest 'Win 2012 SQL' 'ttml2dag\administrator' '7@#$$%^&7'
```

Quotation marks are not required when you type a password with special characters in an options file.

## Examples

Options file:

```
password secretword
```

Command line:

```
-password=secretword
```

**Windows** -password="secret>shhh"

**AIX** | **Linux** | **Mac OS X** | **Solaris** -password='my>pas\$word'

This option is valid only on the initial command line. It is not valid in interactive mode.

## Passwordaccess

The passwordaccess option specifies whether you want to generate your password automatically or set as a user prompt.

Your administrator can require a password for your client node by enabling the authentication feature. Ask your administrator if a password is required for your client node.

If a password is required, you can choose one of the following methods:

- Set the password for your client node yourself and have the client prompt for it each time you request services.
- Let the client automatically generate a new password for your client node each time it expires, encrypt and store the password in a file, and retrieve the password from that file when you request services. You are not prompted for the password.
- If the server is not configured to require a password to log on to it, you can still be prompted to enter your node password when the backup-archive client establishes a connection with the server. This behavior occurs if this option, passwordaccess, is allowed to default or if you set it to passwordaccess prompt. The password that you supply in response to the prompt is used only to encrypt your login information; it is not used to log onto the server. In this configuration, you can avoid entering a password by setting this option to passwordaccess generate. Setting passwordaccess generate causes the client to create, store, and submit the password for you. When passwordaccess generate is set, the password option is ignored.

Setting the passwordaccess option to generate is required in the following situations:

- **AIX** | **Linux** When using the HSM client.
- When using the web client.
- **AIX** | **Solaris** | **Windows** When performing NAS operations.
- When using IBM Spectrum Protect™ for Workstations.

## Supported Clients

This option is valid for all clients.

## Options File

**AIX** | **Linux** | **Solaris** | **Mac OS X** Place this option in the `dsm.sys` file within a server stanza. You can set this option on the Authorization tab, in the Password Access section of the Preferences editor.

**Windows** Place this option in the client options file (`dsm.opt`). You can set this option on the Authorization tab, in the Password Access section of the Preferences editor.

## Syntax

```
>>-PASSWORDAccess--+-prompt---.  
                        '-generate-'
```

## Parameters

### prompt

You are prompted for your client node password each time a client connects to the server. This is the default.

To keep your client node password secure, enter commands without the password and wait for the client to prompt you for the password.

**AIX** | **Linux** | **Solaris** | **Mac OS X** Each user must know the IBM Spectrum Protect password for your client node. Any user who knows the password for your client node can gain access to all backups and archives that originate from your client node. For example: If the user enters the node name and password for your client node from a different client node, the user becomes a virtual root user.

API applications must supply the password when a session is initiated. The application is responsible for obtaining the password.

### generate

Encrypts and stores your password locally and generates a new password when the old password expires. The new password is randomly generated by the client. Password constraints vary, depending on where the passwords are stored and managed, and depending on the version of the server that your client connects to. Generated passwords are 63 characters in length and contain at least two of the following characters:

- upper case letters
- lower case letters
- numeric characters
- special characters

Additionally, the first and last character of a generated password is an alphabetic character, and they can be either upper or lower case. Generated passwords do not contain repeated characters.

A password prompt is displayed when registering a workstation with a server using open registration or if your administrator changes your password manually.

**AIX** | **Linux** | **Solaris** | **Mac OS X** When logging in locally, users do not need to know the password for the client node. However, by using the `nodename` option at a remote node, users can access files they own and files to which another user grants access.

## Examples

Options file:

```
passwordaccess generate
```

Command line:

Does not apply.

**AIX** | **Linux** | **Solaris** | **Mac OS X**



# Passworddir

---

The passworddir option specifies the directory location in which to store an encrypted password file.

**AIX** | **Linux** | **Solaris** | **Mac OS X** The default directory for AIX® is /etc/security/adsm and for other UNIX and Linux platforms it is /etc/adsm. The default directory for Mac is /Library/Preferences/Tivoli Storage Manager. Regardless of where it is stored, the password file that is created by the client is always named TSM.sth. In turn three files comprise a password file. TSM.KDB stores the encrypted passwords. TSM.sth stores the random encryption key that is used to encrypt passwords in the TSM.KDB file. This file is protected by the file system. TSM.IDX is an index file that is used to track the passwords in the TSM.KDB file.

**AIX** | **Linux** | **Solaris** | **Mac OS X**

## Supported Clients

---

This option is valid for all UNIX clients.

## Options File

---

**AIX** | **Linux** | **Solaris** | **Mac OS X** Place this option in the client system-options file (dsm.sys) within a server stanza.

## Syntax

---

```
>>-PASSWORDDIR-- --directoryname-----<<
```

## Parameters

---

directoryname

Specifies the path in which to store the encrypted password file. The name of the password file is TSM.sth. If any part of the specified path does not exist, IBM Spectrum Protect™ attempts to create it.

## Examples

---

**Mac OS X** | **AIX** | **Linux** | **Solaris** | **Mac OS X** Options file:  
**Mac OS X** | **AIX** | **Linux** | **Solaris** | **Mac OS X** | **Mac OS X**

```
passworddir "/Users/user1/Library/Preferences/Tivoli Storage Manager/"
```

**AIX** | **Linux** | **Solaris** | **Mac OS X**

```
passworddir /etc/security/tsm
```

Command line:

Does not apply.

## Pick

---

The pick option creates a list of backup versions or archive copies that match the file specification you enter.

From the list, you can select the versions to process. Include the inactive option to view both active and inactive objects.

**AIX** | **Linux** | **Solaris** | **Windows** For images, if you do not specify a source file space and destination file space, the pick list contains all backed up images. In this case, the images selected from the pick list are restored to their original location. If you specify the source file space and the destination file space, you can select only one entry from the pick list.

Use the pick option with the following commands:

- delete archive
- delete backup
- delete group
- expire
- restore

- **Windows** restore asr
- restore group
- **AIX** | **Linux** | **Solaris** | **Windows** restore image
- **AIX** | **Linux** | **Solaris** | **Mac OS X** | **Windows** restore nas
- **Windows** restore vm
- retrieve

## Supported Clients

---

This option is valid for all clients. The IBM Spectrum Protect™ API does not support this option.

## Syntax

---

>>-Pick-----><

## Parameters

---

There are no parameters for this option.

## Examples

---

**Mac OS X** Command line:  
**Mac OS X** dsmc restore "/Users/van/Documents/\*" -pick -inactive

**AIX** | **Linux** | **Solaris** | **Mac OS X** Command line:  
**AIX** | **Linux** | **Solaris** | **Mac OS X** dsmc restore "/home/project/\*" -pick -inactive

**Windows** Command line:  
**Windows** dsmc restore c:\project\\* -pick -inactive

## Pitdate

---

Use the pitdate option with the pittime option to establish a point in time to display or restore the latest version of your backups.

Files that were backed up *on or before* the date and time you specify, and which were not deleted *before* the date and time you specify, are processed. Backup versions that you create after this date and time are ignored.

Use the pitdate option with the following commands:

- delete backup
- **Windows** query asr
- query backup
- query group
- **AIX** | **Linux** | **Solaris** | **Windows** query image
- **Windows** query nas
- **Windows** query systemstate
- **Windows** query vm (vmbackuptype=fullvm and vmbackuptype=hypervfull)
- restore
- **AIX** | **Linux** | **Solaris** | **Mac OS X** | **Windows** restore group
- **AIX** | **Linux** | **Solaris** | **Windows** restore image
- **AIX** | **Linux** | **Solaris** | **Mac OS X** | **Windows** restore nas
- **Windows** restore vm (vmbackuptype=fullvm and vmbackuptype=hypervfull)

When pitdate is used, the inactive and latest options are implicit.

**AIX** | **Linux** | **Solaris** | **Mac OS X** | **Windows**

## Supported Clients

---

This option is valid for all clients. The IBM Spectrum Protect™ API does not support this option.

## Syntax

---

```
>>-PITDate = - --date-----><
```

## Parameters

---

### date

Specifies the appropriate date. Enter the date in the format you selected with the dateformat option.

When you include dateformat with a command, it must precede the fromdate, pitdate, and todate options.

## Examples

---

```
Mac OS X Command line:
Mac OS X dsmc restore "/Volumes/proj4/myproj/*" -sub=y -pitdate=08/01/2003 -pittime=06:00:00
AIX Linux Solaris Mac OS X Command line:
AIX Linux Solaris Mac OS X dsmc restore "/fsl/*" -sub=y -pitdate=08/01/2003 -
pittime=06:00:00
Windows Command line:
Windows dsmc restore -pitdate=08/01/2003 c:\myfiles\
```

## Pittime

---

Use the pittime option with the pitdate option to establish a point in time to display or restore the latest version of your backups.

Files that were backed up *on or before* the date and time you specify, and which were not deleted *before* the date and time you specify, are processed. Backup versions that you create after this date and time are ignored. This option is ignored if you do not specify pitdate option.

Use the pittime option with the following commands:

- delete backup
- **Windows** query asr
- query backup
- **AIX Linux Solaris Windows** query image
- **Windows** query nas
- **Windows** query systemstate
- **Windows** query vm(vmbackuptype=fullvm and vmbackuptype=hypervfull)
- restore
- **AIX Linux Solaris Windows** restore image
- **AIX Linux Solaris Mac OS X Windows** restore nas
- **Windows** restore vm (vmbackuptype=fullvm and vmbackuptype=hypervfull)

```
AIX Linux Solaris Mac OS X Windows
```

## Supported Clients

---

This option is valid for all clients. The IBM Spectrum Protect™ API does not support this option.

## Syntax

---

```
>>-PITTime = - --time-----><
```

## Parameters

---

### time

Specifies a time on a specified date. If you do not specify a time, the time defaults to 23:59:59. Specify the time in the format you selected with the timeformat option.

When you include the timeformat option in a command, it must precede the fromtime, pittime, and tottime options.

## Examples

---

```
Mac OS X Command line:
Mac OS X dsmc query backup -pitt=06:00:00 -pitd=08/01/2003 "/Volumes/proj5/myproj/*"
AIX Linux Solaris Mac OS X Command line:
AIX Linux Solaris Mac OS X dsmc q b "/fs1/*" -pitt=06:00:00 -pitd=08/01/2003
Windows Command line:
Windows dsmc query backup -pitt=06:00:00 -pitd=08/01/2003 c:\myfiles\
```

## Postschedulcmd/Postnschedulcmd

---

The postschedulcmd/postnschedulcmd option specifies a command that the client program processes after it runs a schedule.

If you want the client program to wait for the command to complete before it continues with other processing, use the postschedulcmd option. If you do not want to wait for the command to complete before the client continues with other processing, specify the postnschedulcmd option.

Return code handling and scheduled action behavior depends on both the option specified, and the type of operation that is scheduled:

- For scheduled operations where the scheduled action is something other than COMMAND:

If the postschedulcmd command does not complete with return code 0 (zero), the return code for the scheduled event is either 8, or the return code of the scheduled operation, whichever is greater. If you do not want the postschedulcmd command to be governed by this rule, you can create a script or batch file that starts the command and exits with return code 0. Then configure postschedulcmd to start the script or batch file.

- For scheduled operations where the scheduled action is COMMAND:

The return code from the command specified on the postschedulcmd option does not affect the return code that is reported to the server when the scheduled event completes. If you want the results of postschedulcmd operations to affect the return code of the scheduled event, include the postschedulcmd operations in the scheduled action command script instead of using the postschedulcmd option.

- If the scheduler action cannot be started, and the command specified on the preschedulcmd option completes with a return code of zero (0), the command specified by the postschedulcmd option is run.
- The return code from an operation specified on the postnschedulcmd option is not tracked, and does not influence the return code of the scheduled event.

## Supported Clients

---

This option is valid for all clients. The IBM Spectrum Protect™ API does not support this option. The server can also define this option.

## Options File

---

```
AIX Linux Solaris Mac OS X Place this option in the client system-options file (dsm.sys) within a server stanza. You can set this option on the Scheduler tab in the Schedule Command text box in the Preferences editor. The server can also define these options.
```

```
Windows Place this option in the client options file (dsm.opt). You can set this option on the Scheduler tab in the Schedule Command text box in the Preferences editor. The server can also define these options.
```

## Syntax

---

```
>>--POSTSchedulcmd--+-+-- --cmdstring----->>
'-POSTNSchedulcmd-'
```

## Parameters

---

cmdstring

Specifies the command to process. You can enter a command to be run after a schedule with this option. Use only one `postschedulecmd` option.

**AIX** | **Linux** | **Solaris** | **Mac OS X** If the command string contains blanks, enclose the command string in quotation marks. If you placed quotation marks within the command string, then enclose the entire command string in single quotation marks.

**Windows** Specify the command string just as you would enter it from the operating system command prompt. If the command string contains any blank spaces, enclose the command string in single quotation marks. For example:

```
'net stop someservice'
```

Use a blank, or null, string for `cmdstring` if you want to prevent any commands from running that the IBM Spectrum Protect server administrator uses for `postschedulecmd` or `preschedulecmd`. If you specify a blank or null string on either option, it prevents the administrator from using a command on both options.

If your administrator uses a blank or null string on the `postschedulecmd` option, you cannot run a post-schedule command.

**Mac OS X** For Mac OS X, if the `postschedulecmd` schedule command is an AppleScript, you must use the `osascript` command to run the script. For example, if "Database Script" is an AppleScript, enter this command:

```
postschedulecmd osascript "/Volumes/La Pomme/Scripting/  
Database Script"
```

## Examples

**Mac OS X** Options file:

**Mac OS X** For Mac OS X: `postschedulecmd "/Volumes/La Pomme/Scripting/postsched.sh"`

**AIX** | **Linux** | **Solaris** | **Mac OS X** Options file:

**AIX** | **Linux** | **Solaris** | **Mac OS X** `postschedulecmd "restart database"`

The command string is a valid command for restarting your database.

**Windows** Options file:

**Windows**

```
posts startdb.cmd  
posts 'rename c:\myapp\logfile.log logfile.new'  
posts 'net start "simple service"'  
posts 'rename "c:\myapp\log file.log" "log file.new" '  
posts '"C:\Program Files\MyTools\runreport.bat"  
log1.in log2.in'
```

**Mac OS X** Command line:

**Mac OS X** `-postschedulecmd="/Volumes/La Pomme/Scripting/postsched.sh"`

**AIX** | **Linux** | **Solaris** | **Mac OS X** | **Windows** Command line:

**AIX** | **Linux** | **Solaris** | **Mac OS X** | **Windows** `-postschedulecmd="'restart database'"`

This option is valid only on the initial command line. It is not valid in interactive mode.

### Related concepts:

Client return codes

### Related reference:

DEFINE SCHEDULE command

**AIX** | **Linux** | **Windows**

## Postsnapshotcmd

The `postsnapshotcmd` option allows you to run operating system shell commands or scripts after the backup-archive client starts a snapshot during a snapshot-based backup operation.

**Windows** This option can be used in conjunction with the `presnapshotcmd` option to allow you to quiesce an application while a snapshot is created, and then to restart that application after the snapshot is started. This option is only valid if OFS or online image backup has been configured.

**AIX** **AIX**® only: This option is only applicable to JFS2 snapshot-based file backup or archive and snapshot-based image backup. For a snapshot-based file backup or archive, use this option with the `backup` command, the `include.fs` option, or in the

dsm.sys file.

**Linux** Linux only: This option is only valid if the LVM is installed and configured on your system, allowing you to perform a snapshot-based image backup operation.

**AIX** | **Linux** AIX and Linux only: For a snapshot-based image backup, use this option with the backup image command, the include.image option, or in the dsm.sys file.

**Windows** For an online image backup, use this option with the backup image command, the include.image option, or in the dsm.opt file.

**Windows** For open file support operations, use the postsnapshotcmd option in an include.fs statement or in your client options file (dsm.opt).

If the postsnapshotcmd fails the operation continues, but appropriate warnings are logged.

**Windows** Attention: During image backup operations or snapshot differential backup operations, if the command that you include on either the presnapshotcmd or postsnapshotcmd statement starts an asynchronous process, the command might not complete before the backup operation finishes. If the command does not complete before the backup completes, temporary files might be locked, which prevents them from being deleted. A database event occurs and the following message is recorded in the dsmerror.log file:

```
ANS0361I DIAG: ..\..\common\db\cacheobj.cpp( 777): dbDelete():  
remove('C:\adsm.sys\SystemExcludeCache__24400820.TsmCacheDB'):  
errno 13: "Permission denied".
```

The file that is specified in the message (cacheobj.cpp) can be manually deleted after the command that was started by the presnapshotcmd or postsnapshotcmd option completes.

## Supported Clients

---

**AIX** | **Linux** This option is valid for AIX clients and Linux x86\_64 clients only. The IBM Spectrum Protect™ API does not support this option. The server can also define this option.

**Windows** This option is valid for all Windows clients. The IBM Spectrum Protect API does not support this option. The server can also define this option.

## Options File

---

**AIX** | **Linux** Place this option in the client system-options file (dsm.sys) within a server stanza. You can also set this option on the Image-Snapshot tab of the Preferences editor.

**Windows** Place this option in the client options file (dsm.opt). You can also set this option on the Image-Snapshot tab of the Preferences editor.

## Syntax

---

```
>>---POSTSNAPshotcmd--- --"cmdstring"-----><
```

## Parameters

---

**AIX** | **Linux** "cmdstring"  
**AIX** | **Linux** Specifies a command to process.

Use the srvprepostsnapdisabled option to prevent the IBM Spectrum Protect server administrator from executing operating system commands on the client system.

If the command string contains blanks, enclose the command string in quotation marks:

```
"resume database myDb"
```

If you placed quotation marks within the command string, then enclose the entire command string in single quotation marks:

```
'resume database "myDb"'
```

**Windows** "cmdstring"

**Windows** Specifies the quiesce command to process.

Use a blank, or null, string for "cmdstring" if you want to prevent any commands from running that the administrator uses for postsnapshotcmd. If you specify a blank or null string, it prevents the administrator from using a command on this option. If your administrator uses a blank or null string on the postsnapshotcmd option, you cannot run a post-snapshot command.

Use the srprepstopsnapdisabled option to prevent the IBM Spectrum Protect server administrator from executing operating system commands on the client system.

If the command string contains blanks, enclose the command string in quotation marks:

```
"resume database myDb"
```

If you placed quotation marks within the command string, then enclose the entire command string in single quotation marks:

```
'resume database "myDb"'
```

## Examples

---

**AIX** | **Linux** Options file:

```
AIX | Linux postsnapshotcmd "any command"
```

The command string is a valid command for restarting your application.

**Windows** Options file:

```
Windows postsnapshotcmd "restart application"
```

The command string is a valid command for restarting your application.

**AIX** | **Linux** Command line:

```
AIX | Linux backup image -postsnapshotcmd="any command"
```

**Windows** Command line:

```
Windows backup image -postsnapshotcmd="restart application"
```

This option is valid only on the initial command line. It is not valid in interactive mode.

## Preschedulecmd/Prenschedulecmd

---

The preschedulecmd option specifies a command that the client program processes before it runs a schedule.

The client program waits for the command to complete before it starts the schedule. If you do not want it to wait, specify prenschedulecmd.

Note:

1. Successful completion of the preschedulecmd command is considered to be a prerequisite to running the scheduled operation. If the preschedulecmd command does not complete with return code 0, the scheduled operation and any postschedulecmd and postschedulecmd commands will not run. The client reports that the scheduled event failed, and the return code is 12. If you do not want the preschedulecmd command to be governed by this rule, you can create a script or batch file that invokes the command and exits with return code 0. Then configure prenschedulecmd to invoke the script or batch file. The return code for the prenschedulecmd command is not tracked, and does not influence the return code of the scheduled event.
2. The server can also define the preschedulecmd option (and the prenschedulecmd option).

## Supported Clients

---

This option is valid for all clients. The IBM Spectrum Protect™ API does not support this option. The server can also define this option.

## Options File

---

**AIX** | **Linux** | **Solaris** | **Mac OS X** Place this option in the client system-options file (dsm.sys) within a server stanza. You can set this option on the Scheduler tab, in the Schedule Command dialog box in the Preferences editor.

**Windows** Place this option in the client options file (dsm.opt). You can set this option on the Scheduler tab, in the Schedule Command dialog box in the Preferences editor.

## Syntax

```
>>--+-PRESchedulecmd--+-+ --cmdstring-----><
'-PRENSchedulecmd-'
```

## Parameters

### cmdstring

Specifies the command to process. Use only one preschedulecmd option. You can enter a command to be executed before a schedule using this option.

**AIX** | **Linux** | **Solaris** | **Mac OS X** If the command string contains blanks, enclose the command string in quotation marks. If you placed quotation marks within the command string, then enclose the entire command string in single quotation marks.

**Windows** Specify the command string just as you would enter it from the operating system command prompt; if the string you specify would require quotation marks to run it at a Windows prompt, include the quotation marks as needed. If the command string contains any blank spaces, enclose the command string in single quotation marks.

**Windows** In this example, single quotation marks are needed because the command string contains space characters:

```
'net stop someservice'
```

**Windows** In this next example, double quotation marks are needed because both the file being renamed, and the new file name, contain space characters. Because the command string does contain space characters, the entire string must be enclosed in single quotation marks.

```
presc 'rename "c:\myapp\log file.log" "log file.old"'
```

Use a blank or null string for cmdstring if you want to prevent any commands from running that the IBM Spectrum Protect server administrator uses for postschedulecmd and preschedulecmd. If you specify a blank or null string on either option, it prevents the administrator from using a command on both options.

If your administrator uses a blank or null string on the preschedulecmd option, you cannot run a pre-schedule command.

**Mac OS X** For Mac OS X, if the preschedulecmd schedule command is an AppleScript, you must use the osascript command to run the script. For example, if "Database Script" is an apple script, enter this command:

```
preschedulecmd osascript "/Volumes/La Pomme/Scripting/
Database Script"
```

## Examples

### Options file:

**AIX** | **Linux** | **Solaris** | **Mac OS X**

```
preschedulecmd "<the quiesce command of your database product>
database"
```

**AIX** | **Linux** | **Solaris** | **Mac OS X** The command string is a valid command for quiescing your database.

**Windows**

```
presc stopdb.cmd
presc 'rename c:\myapp\logfile.log logfile.old'
presc 'net stop "simple service"'
presc 'rename "c:\myapp\log file.log" "log file.old"'
presc '"C:\Program Files\MyTools\runreport.bat"
log1.in log2.in'
```

**AIX** | **Linux** | **Solaris** | **Mac OS X** Command line:

**AIX** | **Linux** | **Solaris** | **Mac OS X** -preschedulecmd="'quiesce database'"



**Windows** Command line:

```
Windows -preschedulecmd='"quiesce database"'
```

This option is valid only on the initial command line. It is not valid in interactive mode.

**Related concepts:**

Client return codes

## Preservelastaccessdate

---

Use the preservelastaccessdate option to specify whether a backup or archive operation changes the last access time.

A backup or archive operation can change the last access time of a file. After an operation, the backup-archive client can reset the last access time to the value before the operation. The last access time can be preserved, rather than modified, by the backup-archive client. Resetting the last access time requires extra processing for each file that is backed up or archived.

If you enable open file support, the last access date for files is always preserved regardless of the setting for preservelastaccessdate. When open file support is enabled, do not use the preservelastaccessdate option.

Use this option with the incremental, selective, or archive commands.

Note:

1. This option applies only to files; it does not apply to directories.
2. **AIX** | **Linux** | **Mac OS X** | **Solaris** Resetting the last access date affects backup and archive performance.
3. Resetting the last access date can affect applications that rely on accurate last-access dates such as a Storage Resource Management (SRM) application.
4. **AIX** | **Linux** On file systems that are not managed by the IBM Spectrum Protect™ for Space Management client or when non-root users back up or archive, the ctime attribute is reset. The last changed time and date (ctime) attribute is reset to the date and time of the backup or archive operation.
5. **AIX** | **Linux** The updatectime option takes precedence over the preservelastaccessdate option. If both options are set to yes, the preservelastaccessdate option is ignored.
6. **AIX** | **Linux** On file systems that are not managed by the IBM Spectrum Protect for Space Management client, do not use preservelastaccessdate yes and the GPFS™ mmbackup command. The mmbackup command and preservelastaccessdate yes selects all files for each backup operation.
7. **Windows** The last access date cannot be preserved on files that are write-protected either by the read-only attribute or by a restrictive NTFS security permission.
8. You cannot reset the last access date of read-only files. The preservelastaccessdate option ignores read-only files and does not change their date.

## Supported Clients

---

This option is valid for all clients.

The server can also define this option.

## Options File

---

**AIX** | **Linux** | **Mac OS X** | **Solaris** Place this option in the client user options file (dsm.opt). You can set this option on the Backup tab of the Preferences editor.

**Windows** Place this option in the client options file (dsm.opt). You can set this option on the Backup tab of the Preferences editor.

## Syntax

---

```
>>-PRESERVElastaccessdate--+-No--.  
                              |-----+----->>  
                              '-Yes-'
```

## Parameters

---

No

A backup or archive operation can change the last access date. This value is the default.

Yes

A backup or archive operation does not change the last access date.

## Examples

Options file:

```
preservelastaccessdate yes
```

[AIX](#) [Linux](#) [Mac OS X](#) [Solaris](#) Command line:

```
AIX Linux Mac OS X Solaris Incremental /proj/test/test_file -preservelastaccessdate=yes
```

[Windows](#) Command line:

```
Windows dsmc incr c: e: f: -preservelastaccessdate=yes
```

**Related information:**

[AIX](#) [Linux](#) [mmbackup command: IBM Spectrum Protect requirements](#)

[AIX](#) [Linux](#) [Guidance for integrating IBM Spectrum Scale AFM with IBM Spectrum Protect](#)

[AIX](#) [Linux](#) [Using IBM Spectrum Protect include and exclude options with IBM Spectrum Scale mmbackup command](#)

## Preservepath

The preservepath option specifies how much of the source path to reproduce as part of the target directory path when you restore or retrieve files to a new location.

Use the -subdir=yes option to include the entire subtree of the source directory (directories and files below the lowest-level source directory) as source to be restored. If a required target directory does not exist, it is created. If a target file has the same name as a source file, it is overwritten. Use the -replace=prompt option to have the client prompt you before files are overwritten.

Use the preservepath option with the following commands:

- restore
- restore backupset
- restore group
- retrieve

[AIX](#) [Linux](#) [Solaris](#) [Mac OS X](#) [Windows](#)

## Supported Clients

This option is valid for all clients. The IBM Spectrum Protect™ API does not support this option. The server can also define this option.

## Syntax

```
>>-PRESERvepath = .-Subtree--.  
+-----+  
+-Complete-+  
+-NOBase---+  
'-NONE-----'
```

## Parameters

Subtree

Creates the lowest-level source directory as a subdirectory of the target directory. Files from the source directory are stored in the new subdirectory. This is the default.

Complete

Restores the entire path, starting from the root, into the specified directory. The entire path includes all the directories except the file space name.

NOBase

Restores the contents of the source directory without the lowest level, or base directory, into the specified destination directory.

NONE

Restores all selected source files to the target directory. No part of the source path at or above the source directory is reproduced at the target.

If you specify SUBDIR=yes, the client restores all files in the source directories to the single target directory.

## Examples

---

AIX	Linux	Solaris	Mac OS X
-----	-------	---------	----------

 Command line:

AIX	Linux	Solaris	Mac OS X
-----	-------	---------	----------

 Assume that the server file space contains the following backup copies:

```
/fs/h1/m1/file.a  
/fs/h1/m1/file.b  
/fs/h1/m1/l1/file.x  
/fs/h1/m1/l1/file.y
```

AIX	Linux	Solaris	Mac OS X
-----	-------	---------	----------

 This command:

AIX	Linux	Solaris	Mac OS X
-----	-------	---------	----------

```
dsmc res /fs/h1/m1/ /u/ann/ -preser=complete
```

**Restores these directories and files:**

```
/u/ann/h1/m1/file.a  
/u/ann/h1/m1/file.b
```

AIX	Linux	Solaris	Mac OS X
-----	-------	---------	----------

 This command:

AIX	Linux	Solaris	Mac OS X
-----	-------	---------	----------

```
dsmc res /fs/h1/m1/ /u/ann/ -preser=nobase
```

**Restores these directories and files:**

```
/u/ann/file.a  
/u/ann/file.b
```

AIX	Linux	Solaris	Mac OS X
-----	-------	---------	----------

 This command:

AIX	Linux	Solaris	Mac OS X
-----	-------	---------	----------

```
dsmc res backupset /fs/h1/m1/ /u/ann/ -su=yes  
-preser=nobase -loc=file
```

**Restores these directories and files:**

```
/u/ann/file.a  
/u/ann/file.b  
/u/ann/file.x  
/u/ann/file.y
```

AIX	Linux	Solaris	Mac OS X
-----	-------	---------	----------

 This command:

AIX	Linux	Solaris	Mac OS X
-----	-------	---------	----------

```
dsmc res /fs/h1/m1/ /u/ann/ -preser=subtree
```

**Restores these directories and files:**

```
/u/ann/m1/file.a  
/u/ann/m1/file.b
```

AIX	Linux	Solaris	Mac OS X
-----	-------	---------	----------

 This command:

AIX	Linux	Solaris	Mac OS X
-----	-------	---------	----------

```
dsmc res /fs/h1/m1/ /u/ann/ -preser=none
```

**Restores these directories and files:**

```
/u/ann/file.a  
/u/ann/file.b
```

AIX	Linux	Solaris	Mac OS X
-----	-------	---------	----------

 This command:

AIX	Linux	Solaris	Mac OS X
-----	-------	---------	----------

```
dsmc res /fs/h1/m1/ /u/ann/ -su=yes -preser=complete
```

**Restores these directories and files:**

```
/u/ann/h1/m1/file.a
/u/ann/h1/m1/file.b
/u/ann/h1/m1/l1/file.x
/u/ann/h1/m1/l1/file.y
```

**AIX** | **Linux** | **Solaris** | **Mac OS X** This command:

**AIX** | **Linux** | **Solaris** | **Mac OS X**

```
dsmc res /fs/h1/m1/ /u/ann/ -su=yes -preser=nobase
```

**Restores these directories and files:**

```
/u/ann/file.a
/u/ann/file.b
/u/ann/l1/file.x
/u/ann/l1/file.y
```

**AIX** | **Linux** | **Solaris** | **Mac OS X** This command:

**AIX** | **Linux** | **Solaris** | **Mac OS X**

```
dsmc res /fs/h1/m1/ /u/ann/ -su=yes -preser=subtree
```

**Restores these directories and files:**

```
/u/ann/m1/file.a
/u/ann/m1/file.b
/u/ann/m1/l1/file.x
/u/ann/m1/l1/file.y
```

**AIX** | **Linux** | **Solaris** | **Mac OS X** This command:

**AIX** | **Linux** | **Solaris** | **Mac OS X**

```
dsmc res /fs/h1/m1/ /u/ann/ -su=yes -preser=none
```

**Restores these directories and files:**

```
/u/ann/file.a
/u/ann/file.b
/u/ann/file.x
/u/ann/file.y
```

**Windows** Command line:

**Windows** Assume the server file space contains the following backup copies:

```
c:\h1\m1\file.a
c:\h1\m1\file.b
c:\h1\m1\l1\file.x
c:\h1\m1\l1\file.y
```

**Windows** This command:

**Windows** `dsmc res backupset my.backupset.file /fs/h1/m1/ /u/ann/ -su=yes` creates a local backupset file named "my.backupset.file".

**Restores these directories and files:**

```
c:\ann\h1\m1\file.a
c:\ann\h1\m1\file.b
```

**Windows** This command:

**Windows** `dsmc res c:\h1\m1\ c:\ann\ -preser=nobase.`

**Restores these directories and files:**

```
c:\ann\file.a
c:\ann\file.b
```

**Windows** This command:

**Windows** `dsmc res c:\h1\m1\ c:\ann\ -preser=subtree.`

**Restores these directories and files:**

```
c:\ann\m1\file.a
c:\ann\m1\file.b
```

**Windows** This command:

**Windows** `dsmc res c:\h1\m1\ c:\ann\ -preser=none.`

**Restores these directories and files:**

```
c:\ann\file.a  
c:\ann\file.b
```

**Windows** This command:**Windows**

```
dsmc res c:\hl\m1\ c:\ann\ -su=yes -preser=  
complete
```

**Restores these directories and files:**

```
c:\ann\hl\m1\file.a  
c:\ann\hl\m1\file.b  
c:\ann\hl\m1\l1\file.x  
c:\ann\hl\m1\l1\file.y
```

**Windows** This command:**Windows**

```
dsmc res c:\hl\m1\ c:\ann\ -su=yes -preser=nobase.
```

**Restores these directories and files:**

```
c:\ann\file.a  
c:\ann\file.b  
c:\ann\l1\file.x  
c:\ann\l1\file.y
```

**Windows** This command:**Windows**

```
dsmc res c:\hl\m1\ c:\ann\ -su=yes -preser=subtree.
```

**Restores these directories and files:**

```
c:\ann\m1\file.a  
c:\ann\m1\file.b  
c:\ann\m1\l1\file.x  
c:\ann\m1\l1\file.y
```

**Windows** This command:**Windows**

```
dsmc res c:\hl\m1\ c:\ann\ -su=yes -preser=none.
```

**Restores these directories and files:**

```
c:\ann\file.a  
c:\ann\file.b  
c:\ann\file.x  
c:\ann\file.y
```

**Windows** This command:**Windows**

```
dsmc res backupset c:\hl\m1\ c:\ann\ -su=yes  
-preser=nobase -loc=file
```

**Restores these directories and files:**

```
c:\ann\file.a  
c:\ann\file.b  
c:\ann\file.x  
c:\ann\file.y
```

**AIX****Linux****Windows**

## Presnapshotcmd

---

The presnapshotcmd option allows you to run operating system commands before the backup-archive client starts a snapshot.

This allows you to quiesce an application before the client starts the snapshot during a snapshot-based backup or archive.

**Windows**

This option can be used in conjunction with the postsnapshotcmd option to allow you to quiesce an application while a snapshot is created, and then to restart that application after the snapshot is started. This option is only valid if OFS or online image backup has been configured.

**AIX** AIX® only: This option is only applicable to JFS2 snapshot-based file backup or archive and snapshot-based image backup. For a snapshot-based file backup or archive, use this option with the backup command, the include.fs option, or in the dsm.sys file.

**Linux** Linux only: This option is only valid if the LVM is installed and configured on your system, allowing you to perform a snapshot-based image backup.

**AIX** | **Linux** AIX and Linux only: For a snapshot-based image backup, use this option with the backup image command, the include.image option, or in the dsm.sys file.

**Windows** For an online image backup, use this option with the backup image command, the include.image option, or in the dsm.opt file.

**Windows** For open file support operations, use the presnapshotcmd option in an include.fs statement or in your client options file (dsm.opt).

If the presnapshotcmd fails it is assumed that the application is not in a consistent state and the client stops the operation and display the appropriate error message.

**Windows** Attention: During image backup operations or snapshot differential backup operations, if the command that you include on either the presnapshotcmd or postsnapshotcmd statement starts an asynchronous process, the command might not complete before the backup operation finishes. If the command does not complete before the backup completes, temporary files might be locked, which prevents them from being deleted. A database event occurs and the following message is recorded in the dsmerror.log file:

```
ANS0361I DIAG: ..\..\common\db\cacheobj.cpp( 777): dbDelete():  
remove('C:\adsm.sys\SystemExcludeCache__24400820.TsmCacheDB'):  
errno 13: "Permission denied".
```

The file that is specified in the message (cacheobj.cpp) can be manually deleted after the command that was started by the presnapshotcmd or postsnapshotcmd option completes.

## Supported Clients

---

**AIX** | **Linux** This option is valid for AIX JFS2 and Linux x86\_64 clients only. The IBM Spectrum Protect™ API does not support this option. The server can also define this option.

**Windows** This option is valid for all Windows clients. The IBM Spectrum Protect API does not support this option. The server can also define this option.

## Options File

---

**AIX** | **Linux** Place this option in the client system-options file (dsm.sys) within a server stanza. You can set also this option on the **Image-Snapshot** tab of the Preferences editor.

**Windows** Place this option in the client options file (dsm.opt). You can set also this option on the Image-Snapshot tab of the Preferences editor.

## Syntax

---

```
>>---PRESNAPshotcmd--- --"cmdstring"----->>
```

## Parameters

---

**AIX** | **Linux** "cmdstring"  
**AIX** | **Linux** Specifies a command to process.

Use the srvprepostsnapdisabled option to prevent the IBM Spectrum Protect server administrator from running operating system commands on the client system.

If the command string contains blanks, enclose the command string in quotation marks:

```
"quiesce database myDb"
```

If you placed quotation marks within the command string, then enclose the entire command string in single quotation marks:

```
'resume database "myDb"'
```

**Windows** "cmdstring"

**Windows** Specifies the quiesce command to process.

Use a blank, or null, string for "cmdstring" if you want to prevent any commands from running that the administrator uses for presnapshotcmd. If you specify a blank or null string, it prevents the administrator from using a command on this option. If your administrator uses a blank or null string on the presnapshotcmd option, you cannot run a pre-snapshot command.

Use the srvprepostsnapdisabled option to prevent the IBM Spectrum Protect server administrator from running operating system commands on the client system.

If the command string contains blanks, enclose the command string in quotation marks:

```
"quiesce database myDb"
```

If you placed quotation marks within the command string, then enclose the entire command string in single quotation marks:

```
'resume database "myDb"'
```

## Examples

---

**AIX** | **Linux** Options file:

**AIX** | **Linux**

```
presnapshotcmd "any shell command or script"
```

**Windows** Options file:

**Windows**

```
presnapshotcmd "<insert your application quiesce command here>  
application"
```

The command string is a valid command for quiescing your application.

**AIX** | **Linux** Command line:

**AIX** | **Linux**

```
backup image -presnapshotcmd="any shell command or script"
```

**Windows** Command line:

**Windows**

```
backup image -presnapshotcmd="<insert your application quiesce command  
here> application"
```

This option is valid only on the initial command line. It is not valid in interactive mode.

## Querschedperiod

---

The querschedperiod option specifies the number of hours you want the client scheduler to wait between attempts to contact the server for scheduled work.

This option applies only when you set the schedmode option to polling. This option is used only when the scheduler is running.

Your administrator can also set this option. If your administrator specifies a value for this option, that value overrides the value set in your client options file after your client node successfully contacts the server.

## Supported Clients

---

This option is valid for all clients. The IBM Spectrum Protect™ API does not support this option. The server can also define this option.

## Options File

---

**AIX** | **Linux** | **Solaris** | **Mac OS X** Place this option in the client system-options file (dsm.sys) within a server stanza.

**Windows** Place this option in the client options file (dsm.opt).

## Syntax

---

```
>>-QUERYSCHedperiod-- --hours-----><
```

## Parameters

---

hours

Specifies the number of hours the client scheduler waits between attempts to contact the server for scheduled work. The range of values is 1 through 9999; the default is 4.

## Example

---

```
Options file:
  queriesch 6
```

## Querysummary

---

The querysummary option provides statistics about files, directories and objects that are returned by the query backup or query archive commands.

The following statistics are provided by the querysummary option:

- The aggregate number of files and directories that are returned by the query backup or query archive command
- The aggregate amount of data of the objects that are returned by the query backup or query archive command
- The classic restore memory-utilization estimate to restore objects that are returned by the query backup or query archive command
- The total number of unique server volumes where the objects that are returned by the query command reside

**Windows** Single objects that span multiple volumes only include one volume in the total number of volumes statistics. For example, if `c:\bigfile` spans two volumes, only one of the volumes is counted in the estimated number of volumes.

## Supported Clients

---

This option is valid for all clients. The IBM Spectrum Protect™ API does not support this option.

## Syntax

---

```
>>-QUERYSUMMARY-----><
```

## Parameters

---

There are no parameters for this option.

## Examples

---

**AIX** | **Linux** | **Solaris** | **Mac OS X**

Command line:

**AIX** | **Linux** | **Solaris** | **Mac OS X** `dsmc q ba '/usr/fs1/*' -sub=yes -querysummary`

**AIX** | **Linux** | **Solaris** | **Mac OS X**

```
[root@kaveri:/home/cpark] $ dsmc q ba '/kalafsl/*' -sub=yes -querysummary
IBM Spectrum Protect
```



Command Line Backup-Archive Client Interface  
 Client Version 8, Release 1, Level 0.0  
 Client date/time: 12/09/2016 12:05:35  
 (c) Copyright by IBM Corporation and other(s) 1990, 2016. All Rights Reserved.

Node Name: KAVERI  
 Session established with server TEMPLAR: AIX-RS/6000  
 Server Version 8, Release 1, Level 0.0  
 Server date/time: 12/09/2016 12:05:35 Last access: 12/07/2016 07:48:59

Size	Backup Date	Mgmt Class	A/I File
4,096	B 08/07/08 12:07:30	BASVT2	A /kalafs1/
256	B 08/07/08 12:07:30	BASVT2	A /kalafs1/dir1
10,485,760	B 08/07/08 12:07:30	DEFAULT	A /kalafs1/info1
5,242,880	B 08/07/08 12:07:30	DEFAULT	A /kalafs1/info2
1,044	B 08/07/08 12:07:30	DEFAULT	A /kalafs1/dir1/subfile1
1,044	B 08/07/08 12:07:30	DEFAULT	A /kalafs1/dir1/subfile2

Summary Statistics

Total Files	Total Dirs	Avg. File Size	Total Data	Memory Est.
4	2	3.75 MB	15.00 MB	1.07 KB

Estimated Number of Volumes: 2

[root@kaveri:/home/cpark] \$

Windows

Command line:

Windows dsmc query backup k:\.\* -subdir=yes -QUERYSUMMARY

Windows

IBM Spectrum Protect  
 Command Line Backup-Archive Client Interface  
 Client Version 8, Release 1, Level 0.0  
 Client date/time: 12/09/2016 12:05:35  
 (c) Copyright by IBM Corporation and other(s) 1990, 2016. All Rights Reserved.

Node Name: BARKENSTEIN  
 Session established with server BARKENSTEIN\_SERVER1: Windows  
 Server Version 8, Release 1, Level 0.0  
 Server date/time: 12/09/2016 12:05:35 Last access: 12/08/2016 05:46:09

Size	Backup Date	Mgmt Class	A/I File
0	B 04/02/2008 20:21:51	STANDARD	A \\barkenstein\k\$\
0	B 04/02/2008 20:21:51	STANDARD	A \\barkenstein\k\$\jack_test
0	B 04/01/2008 12:37:07	STANDARD	A \\barkenstein\k\$\ System Volume Information
0	B 04/01/2008 12:37:07	STANDARD	A \\barkenstein\k\$\Test1
0	B 04/02/2008 20:21:51	STANDARD	A \\barkenstein\k\$\TestTree
0	B 04/01/2008 12:37:07	STANDARD	A \\barkenstein\k\$\Tree150
0	B 04/02/2008 19:49:20	STANDARD	A \\barkenstein\k\$\Tree150.1
0	B 04/01/2008 12:37:07	STANDARD	A \\barkenstein\k\$\Tree150.2
0	B 04/02/2008 19:50:51	STANDARD	A \\barkenstein\k\$\Tree150.3
0	B 04/01/2008 12:37:07	STANDARD	A \\barkenstein\k\$\Tree1500
0	B 04/02/2008 10:41:40	STANDARD	A \\barkenstein\k\$\Tree150_2
0	B 04/02/2008 20:02:31	STANDARD	A \\barkenstein\k\$\tree18
0	B 04/02/2008 20:15:04	STANDARD	A \\barkenstein\k\$\Tree18.test
0	B 04/01/2008 12:37:07	STANDARD	A \\barkenstein\k\$\Tree30
0	B 04/01/2008 12:37:07	STANDARD	A \\barkenstein\k\$\Tree30.2
0	B 04/02/2008 19:52:30	STANDARD	A \\barkenstein\k\$\tree30.test
11,788	B 04/02/2008 19:55:32	DEFAULT	A \\barkenstein\k\$\file1
11,788	B 04/02/2008 19:55:32	DEFAULT	A \\barkenstein\k\$\file10
11,788	B 04/02/2008 19:55:32	DEFAULT	A \\barkenstein\k\$\file11
11,788	B 04/02/2008 19:55:32	DEFAULT	A \\barkenstein\k\$\file12
11,788	B 04/02/2008 19:55:32	DEFAULT	A \\barkenstein\k\$\file13
11,788	B 04/02/2008 19:55:32	DEFAULT	A \\barkenstein\k\$\file14
11,788	B 04/02/2008 19:55:32	DEFAULT	A \\barkenstein\k\$\file15

```

11,788 B 04/02/2008 19:55:32 DEFAULT A \\barkenstein\k$\file16
11,788 B 04/02/2008 19:55:32 DEFAULT A \\barkenstein\k$\file17
11,788 B 04/02/2008 19:55:32 DEFAULT A \\barkenstein\k$\file18
11,788 B 04/02/2008 19:55:32 DEFAULT A \\barkenstein\k$\file19
11,788 B 04/02/2008 19:55:32 DEFAULT A \\barkenstein\k$\file2
11,788 B 04/02/2008 19:55:32 DEFAULT A \\barkenstein\k$\file20
11,788 B 04/02/2008 19:55:32 DEFAULT A \\barkenstein\k$\file21
11,788 B 04/02/2008 19:55:32 DEFAULT A \\barkenstein\k$\file3
11,788 B 04/02/2008 19:55:32 DEFAULT A \\barkenstein\k$\file4
11,788 B 04/02/2008 19:55:32 DEFAULT A \\barkenstein\k$\file5
11,788 B 04/02/2008 19:55:32 DEFAULT A \\barkenstein\k$\file6
11,788 B 04/02/2008 19:55:32 DEFAULT A \\barkenstein\k$\file7
11,788 B 04/02/2008 19:55:32 DEFAULT A \\barkenstein\k$\file8
11,788 B 04/02/2008 19:55:32 DEFAULT A \\barkenstein\k$\file9
11,788 B 04/02/2008 13:31:06 DEFAULT A \\barkenstein\k$\file910
10,964 B 04/01/2008 12:37:07 DEFAULT A \\barkenstein\k$\filea
10,964 B 04/01/2008 12:37:07 DEFAULT A \\barkenstein\k$\fileb
10,964 B 04/01/2008 12:37:07 DEFAULT A \\barkenstein\k$\x

```

#### Summary Statistics

Total Files	Total Dirs	Avg. File Size	Total Data	Memory Est.
-----	-----	-----	-----	-----
25	16	11.41 KB	285.37 KB	10.58 KB

Estimated Number of Volumes: 2

## Quiet

---

The quiet option limits the number of messages that are displayed on your screen during processing..

For example, when you run the incremental, selective, or archive commands, information might appear about each file that is backed up. Use the quiet option if you do not want to display this information

When you use the quiet option, error and processing information appears on your screen, and messages are written to log files. If you do not specify quiet, the default option, verbose is used.

## Supported Clients

---

This option is valid for all clients. The server can also define the quiet option, overriding the client setting. The IBM Spectrum Protect™ API does not support this option.

## Options File

---

**AIX** **Linux** **Solaris** **Mac OS X** Place this option in the client user-options file (dsm.opt). You can set this option on the Command Line tab, Do not display process information on screen checkbox of the Preferences editor.

**Windows** Place this option in the client options file (dsm.opt). You can set this option on the Command Line tab, Do not display process information on screen checkbox of the Preferences editor.

## Syntax

---

```
>>-QUIET-----<<
```

## Parameters

---

There are no parameters for this option.

## Examples

---

```
Options file:
  quiet
Command line:
  -quiet
```

This option is valid only on the initial command line. It is not valid in interactive mode.

## Quotesareliteral

---

The `quotesareliteral` option specifies whether single quotation marks (') or double quotation marks (") are interpreted literally, when they are included in a file list specification on a `filelist` option.

Ordinarily, the client requires you to use single or double quotation marks to delimit file specifications that contain space characters. Some file systems allow single and double quotation marks in file and directory names.

To prevent errors that would otherwise occur, when file specifications are included on a `filelist` option and they contain single quotation marks (') or double quotation marks ("), set `quotesareliteral yes`. When `quotesareliteral` is set to `yes`, quotation marks that are included in a file list specification on a `filelist` option are interpreted literally, as quotation marks, and not as delimiters.

This option applies to any command that accepts a `filelist` option as command parameter.

## Supported Clients

---

This option is valid for all supported platforms. The option is applied to any command that takes a file list specification as a parameter.

## Options File

---

Place this option in the client user options file (`dsm.opt`).

## Syntax

---

```
                .-no-----.  
>>-QUOTESARELITERAL--++-----++----->>  
                        '-yes-'
```

## Parameters

---

`no`

Specifies that single quotation marks (') and double quotation marks (") are interpreted as delimiters for file list specifications included on a `filelist` option. `No` is the default setting.

`yes`

Specifies that single quotation marks (') and double quotation marks (") are interpreted literally, and not as delimiters, for file list specifications that are included on a `filelist` option. Specify this value if you are backing up files from a file system that allows quotation marks in file or directory names.

## Examples

---

Options file:

```
QUOTESARELITERAL YES
```

**Windows** Command line:

**Windows** Assuming that the file system allows quotation marks in paths, the following are examples of files in a file list specification that can be successfully processed if `QUOTESARELITERAL` is set to `YES`.

**Windows** Assume the command that is issued is `dsmc sel -filelist=c:\important_files.txt`, where `important_files.txt` contains the list of files to process.

**Windows** `important_files.txt` contains the following list of files:

```
c:\home\myfiles\"file"1000  
c:\home\myfiles\'file'  
c:\home\myfiles\file'ABC  
c:\home\myfiles\ABC"file"
```

**AIX** **Linux** **Mac OS X** **Solaris** Command line:

**AIX** **Linux** **Mac OS X** **Solaris** Assuming that the file system allows quotation marks in paths, the following are examples of files in a file list specification that can be successfully processed if `QUOTESARELITERAL` is set to `YES`

AIX	Linux	Mac OS X	Solaris
-----	-------	----------	---------

Assume the command that is issued is `dsmc sel - filelist=/home/user1/important_files`, where `important_files.txt` contains the list of files to process.

AIX	Linux	Mac OS X	Solaris
-----	-------	----------	---------

```
/home/user1/myfiles/"file"1000
/home/user1/myfiles/'file'
/home/user1/myfiles/file'ABC
/home/user1/myfiles/ABC"file"
```

AIX	Linux	Solaris	Mac OS X
-----	-------	---------	----------

## Removeoperandlimit

---

The `removeoperandlimit` option specifies that the client removes the 20-operand limit.

If you specify the `removeoperandlimit` option with the incremental, selective, or archive commands, the 20-operand limit is not enforced and is restricted only by available resources or other operating system limits.

The `removeoperandlimit` option can be useful if you generate scripts which can invoke the command-line client with a large number of operands. For example, you can prescan a directory tree looking for files to back up. As each *eligible* file is discovered, it is added to the operand list of a selective command. Later, this selective command is submitted by a controlling script. In this case, specifying the `removeoperandlimit` option removes the 20-operand limit.

Note:

1. The `removeoperandlimit` option *must* be placed immediately after the incremental, selective, or archive command before any file specifications.
2. This option does not accept a value. If this option is specified on a command, the 20-operand limit is removed.
3. Because it adversely affects performance to allow the shell to expand wild cards, use the `removeoperandlimit` option in backup or archive operations in which wild cards are not used.
4. The `removeoperandlimit` option is valid only on the incremental, selective, or archive commands in batch mode. It is not valid in the client options file (`dsm.opt`) or `dsm.sys` file.

## Supported Clients

---

This option is valid for all UNIX and Linux clients.

## Syntax

---

```
>>-REMOVEOPerandlimit-----<<
```

## Parameters

---

There are no parameters for this option.

## Examples

---

Command line:  
`-removeoperandlimit`

## Replace

---

The `replace` option specifies whether to overwrite existing files on your workstation, or to prompt you for your selection when you restore or retrieve files.

**Important:** The `replace` option does not affect recovery of directory objects. Directory objects are always recovered, even when specifying `replace=no`. To prevent overwriting existing directories, use the `filesonly` option.

You can use this option with the following commands:

- restore
- restore backupset
- restore group

- retrieve

Note: Replace prompting does not occur during a scheduled operation. If you set the replace option to prompt, the backup-archive client skips files without prompting you during a scheduled operation.

**AIX** | **Linux** | **Solaris** | **Mac OS X** | **Windows**

## Supported Clients

This option is valid for all clients. The IBM Spectrum Protect™ API does not support this option.

## Options File

**AIX** | **Linux** | **Solaris** | **Mac OS X** Place this option in the client user-options file (dsm.opt). You can set this option on the Restore tab, Action for files that already exist section of the Preferences editor.

**Windows** Place this option in the client options file (dsm.opt). You can set this option on the Restore tab, Action for files that already exist section of the Preferences editor.

## Syntax

```

      .-Prompt-.
>>-REplace-+-----+----->>
      +-All----+
      +-Yes----+
      '-No-----'

```

## Parameters

### Prompt

For nonscheduled operations, you specify whether to overwrite existing files. For scheduled operations, existing files are not overwritten and no prompts are displayed. This is the default.

**AIX** | **Linux** | **Solaris** | **Mac OS X** All

**AIX** | **Linux** | **Solaris** | **Mac OS X** All existing files are overwritten, including read-only files. If access to a file is denied, you are prompted to skip or overwrite the file. No action is taken on the file until there is a response to the prompt.

**Windows** All

**Windows** All existing files are overwritten, including read-only files. All locked files are replaced when the system is rebooted. If access to a file is denied, you are prompted to skip or overwrite the file. No action is taken on the file until there is a response to the prompt.

### Yes

Existing files are overwritten, *except* read-only files. For nonscheduled operations, you specify whether to overwrite existing read-only files. For scheduled operations, existing read-only files are not overwritten and no prompts are displayed. If access to a file is denied, the file is skipped.

**Windows** No

**Windows** Existing files are not overwritten. No prompts are displayed.

**Mac OS X** **Note:** When restoring or retrieving files with the replace option set to no, existing files are not overwritten, but existing directories are overwritten. To leave existing directories intact during a restore or retrieve operation, select the Options > All selected files and directories > Files only from the backup-archive client GUI.

**AIX** | **Linux** | **Solaris** | **Mac OS X** No

**AIX** | **Linux** | **Solaris** | **Mac OS X** Existing files are not overwritten. No prompts are displayed.

**Windows** **Note:** You can choose to replace locked files when the system is rebooted. The client cannot perform an in-place restore of active files. However, it stages restored versions of active files for replacement during the next reboot, except for files containing named streams, sparse files, and directories. You can only restore these files if they are unlocked.

## Examples

Options file:

```
replace all
```

Command line:

```
-replace=no
```

This option is valid on the initial command line and in interactive mode. If you use this option in interactive mode, it affects only the command with which it is specified. When that command completes, the value reverts to the value at the beginning of the interactive session. This is the value from the `dsm.opt` file unless overridden by the initial command line or by an option forced by the server.

## Replserverguid

---

The `replserverguid` option specifies the globally unique identifier (GUID) that is used when the client connects to the secondary server during failover. The GUID is used to validate the secondary server to ensure that it is the expected server.

The replication GUID is different from the machine GUID of the server. It is generated one time for a server that is doing the replication and never changes.

This option must be specified within a `replservername` stanza in the client options file. The `replservername` stanza contains connection information about the secondary server.

This option is set by the IBM Spectrum Protect™ server administrator for the client node. During the normal (non-failover) logon process, the option is sent to the client and is saved in the client options file.

Do not edit this option during normal operations.

Edit this option only during situations such as the following ones:

- The primary server is offline and the information for the secondary server is not in the options file.
- The secondary server information is out-of-date or incorrect.

Any values that you edit are removed or updated the next time you log in to the primary server.

## Supported Clients

---

This option is valid for all clients.

## Options File

---

**AIX** | **Linux** | **Solaris** | **Mac OS X** This option is placed in the `dsm.sys` file within the `replservername` stanza.

**Windows** This option is placed in the client options file (`dsm.opt`).

## Syntax

---

```
>>-replserverguid----serverguid-----<<
```

## Parameters

---

`serverguid`  
Specifies the GUID of the secondary server that is used during a failover.

## Examples

---

Options file:  
`REPLSERVERGUID 91.0f.ef.90.5c.cc.11.e1.ae.34.08.00.00.00.00.02`  
Command line:  
Does not apply.

**AIX** | **Linux** | **Mac OS X** | **Solaris** Options file:  
**AIX** | **Linux** | **Mac OS X** | **Solaris** The following example demonstrates how to specify options for three different servers in the `dsm.sys` file, and how to reference the secondary server. Connection information for multiple secondary server is presented in stanzas. Each stanza is identified by the `replservername` option and the name of the secondary server. The `servername` stanza must contain the `myreplicationserver` option, which points to the secondary server that is specified by the `replservername` stanza. Only one secondary server can be specified per `servername` stanza.

```
REPLSERVERNAME TargetReplicationServer1  
REPLTCPSEVERADDRESS TargetReplicationServer1
```

```

REPLTCPSPORT          1505
REPLSSLPORT           1506
REPLSERVERGUID       91.0f.ef.90.5c.cc.11.e1.ae.34.08.00.00.00.00

REPLSERVERNAME       TargetReplicationServer2
REPLTCPSERVERADDRESS TargetReplicationServer2
REPLTCPSPORT          1505
REPLSSLPORT           1506
REPLSERVERGUID       91.0f.ef.90.5c.cc.11.e1.ae.34.08.00.00.00.00.02

SErvername            server_a
COMMethod              TCPip
TCPPort                1500
TCPServeraddress       server_hostname1.example.com
PASSWORDAccess         prompt
MYREPLICATIONServer   TargetReplicationServer1

SErvername            server_b
COMMethod              TCPip
TCPPort                1500
TCPServeraddress       server_hostname2.example.com
PASSWORDAccess         generate
INCLExcl               /adm/tsm/archive.excl
MYREPLICATIONServer   TargetReplicationServer2

SErvername            server_c
COMMethod              TCPip
TCPPort                1500
TCPServeraddress       server_hostname3.example.com
PASSWORDAccess         generate
MYREPLICATIONServer   TargetReplicationServer1

```

#### Windows Options file:

The following example demonstrates how to specify options for the secondary server in the `dsm.opt` file, and how to reference the secondary server. The connection information for the secondary server is located within the `REPLSERVERName` stanza. The `MYREPLICATIONServer` option points to the secondary server name that is specified by the `REPLSERVERName` stanza.

```

REPLSERVERNAME       TargetReplicationServer1
REPLTCPSERVERADDRESS TargetReplicationServer1
REPLTCPSPORT          1505
REPLSSLPORT           1506
REPLSERVERGUID       91.0f.ef.90.5c.cc.11.e1.ae.34.08.00.00.00.00.00

COMMethod              TCPip
TCPPort                1500
TCPServeraddress       server_hostname1.example.com
PASSWORDAccess         prompt
MYREPLICATIONServer   TargetReplicationServer1
MYPRIMARYSERVER        Server1

```

#### Related concepts:

Automated client failover configuration and use

#### Related tasks:

Configuring the client for automated failover

## Replservername

The `replservername` option specifies the name of the secondary server that the client connects to during a failover.

The `replservername` option begins a stanza in the client options file that contains connection information about the secondary server.

This option is set by the IBM Spectrum Protect™ server administrator for the client node. During the normal (non-failover) logon process, the option is sent to the client and is saved in the client options file.

Do not edit this option during normal operations.

Edit this option only during situations such as the following ones:

- The primary server is offline and the information for the secondary server is not in the options file.
- The secondary server information is out-of-date or incorrect.

Any values that you edit are removed or updated the next time you log in to the primary server.

## Supported Clients

This option is valid for all clients.

## Options File

**AIX** | **Linux** | **Solaris** | **Mac OS X** This option is placed in the client-system options dsm.sys.

**Windows** This option is placed in the client options file (dsm.opt).

## Syntax

```
>>-replservername----repl_servername-----<<
```

## Parameters

repl\_servername

Specifies the name of the secondary server to be used during a failover. This value is usually the name of the secondary server, not the host name of the server.

## Examples

Options file:

```
REPLSERVERName TargetReplicationServer1
```

Command line:

Does not apply.

**AIX** | **Linux** | **Mac OS X** | **Solaris** Options file:

The following example demonstrates how to specify options for three different servers in the dsm.sys file, and how to reference the secondary server. Connection information for multiple secondary server is presented in stanzas. Each stanza is identified by the replservername option and the name of the secondary server. The servername stanza must contain the myreplicationserver option, which points to the secondary server that is specified by the replservername stanza. Only one secondary server can be specified per servername stanza.

```
REPLSERVERNAME    TargetReplicationServer1
REPLTCPSEVERADDRESS TargetReplicationServer1
REPLTCPPOINT      1505
REPLSSLPORT       1506
REPLSERVERGUID    91.0f.ef.90.5c.cc.11.e1.ae.34.08.00.00.00.00

REPLSERVERNAME    TargetReplicationServer2
REPLTCPSEVERADDRESS TargetReplicationServer2
REPLTCPPOINT      1505
REPLSSLPORT       1506
REPLSERVERGUID    91.0f.ef.90.5c.cc.11.e1.ae.34.08.00.00.00.00.02

SErvername        server_a
COMMethod         TCPip
TCPPoint          1500
TCPSEveraddress   server_hostname1.example.com
PASSWORDAccess    prompt
MYREPLICATIONServer TargetReplicationServer1

SErvername        server_b
COMMethod         TCPip
TCPPoint          1500
TCPSEveraddress   server_hostname2.example.com
PASSWORDAccess    generate
INCLExcl          /adm/tsm/archive.excl
MYREPLICATIONServer TargetReplicationServer2
```



```

SErvername      server_c
COMMMethod      TCPip
TCPpPort        1500
TCPSeRveraddress  server_hostname3.example.com
PASSwORDAccess  generate
MYREPLICATIOnServer  TargetReplIcationServer1

```

**Windows** Options file:

**Windows** The following example demonstrates how to specify options for the secondary server in the dsm.opt file, and how to reference the secondary server. The connection information for the secondary server is located within the REPLSERVERName stanza. The MYREPLICATIONServer option points to the secondary server name that is specified by the REPLSERVERName stanza.

```

REPLSERVERNAME      TargetReplIcationServer1
REPLTCPSeRverADDRESS TargetReplIcationServer1
REPLTCPpPORT        1505
REPLSSLPORT         1506
REPLSeRverGUID      91.0f.ef.90.5c.cc.11.e1.ae.34.08.00.00.00.00

COMMMethod          TCPip
TCPpPort            1500
TCPSeRveraddress    server_hostname1.example.com
PASSwORDAccess      prompt
MYREPLICATIOnServer  TargetReplIcationServer1
MYPRIMARySERVER     Server1

```

**Related concepts:**

Automated client failover configuration and use

**Related tasks:**

Configuring the client for automated failover

## Replsslport

The replsslport option specifies the TCP/IP port on the secondary server that is SSL-enabled. The replsslport option is used when the client connects to the secondary server during a failover. This option is deprecated if you are connecting to an IBM Spectrum Protect™ server V8.1.2 and later.

The replsslport option is sent to the client by the primary server only if the secondary server is configured for SSL.

This option is applicable only when the client is configured to use SSL for secure communications between the IBM Spectrum Protect server and client. If the client is not configured to use SSL, the port that is specified by the repltcpport option is used. You can determine whether the client uses SSL by verifying the SSL client option.

This option must be specified within a replservername stanza in the client options file. The replservername stanza contains connection information about the secondary server.

During the normal (non-failover) logon process, this option is sent to the client and is saved in the client options file.

Do not edit this option during normal operations.

Edit this option only during situations such as the following ones:

- The primary server is offline and the information for the secondary server is not in the options file.
- The secondary server information is out-of-date or incorrect.

Any values that you edit are removed or updated the next time you log in to the primary server.

## Supported Clients

This option is valid for all clients.

## Options File

**AIX** | **Linux** | **Solaris** | **Mac OS X** This option is placed in the dsm.sys file within the replservername stanza.

**Windows** This option is placed in the client options file (dsm.opt).

## Syntax

```
>>-replsslport----port_address-----<<
```

## Parameters

port\_address

Specifies the TCP/IP port address that is enabled for SSL and that is used to communicate with the secondary server.

## Examples

Options file:

```
REPLSSLPORT 1506
```

Command line:

Does not apply.

**AIX** | **Linux** | **Mac OS X** | **Solaris** Options file:

**AIX** | **Linux** | **Mac OS X** | **Solaris** The following example demonstrates how to specify options for three different servers in the dsm.sys file, and how to reference the secondary server. Connection information for multiple secondary server is presented in stanzas. Each stanza is identified by the replservername option and the name of the secondary server. The servername stanza must contain the myreplicationserver option, which points to the secondary server that is specified by the replservername stanza. Only one secondary server can be specified per servername stanza.

```
REPLSERVERNAME TargetReplicationServer1
REPLTCPSERVERADDRESS TargetReplicationServer1
REPLTCPPOINT 1505
REPLSSLPORT 1506
REPLSERVERGUID 91.0f.ef.90.5c.cc.11.e1.ae.34.08.00.00.00.00
```

```
REPLSERVERNAME TargetReplicationServer2
REPLTCPSERVERADDRESS TargetReplicationServer2
REPLTCPPOINT 1505
REPLSSLPORT 1506
REPLSERVERGUID 91.0f.ef.90.5c.cc.11.e1.ae.34.08.00.00.00.00.02
```

```
SERvername server_a
COMMethod TCPip
TCPPOINT 1500
TCPServeraddress server_hostname1.example.com
PASSWORDAccess prompt
MYREPLICATIONServer TargetReplicationServer1
```

```
SERvername server_b
COMMethod TCPip
TCPPOINT 1500
TCPServeraddress server_hostname2.example.com
PASSWORDAccess generate
INCLExcl /adm/tsm/archive.excl
MYREPLICATIONServer TargetReplicationServer2
```

```
SERvername server_c
COMMethod TCPip
TCPPOINT 1500
TCPServeraddress server_hostname3.example.com
PASSWORDAccess generate
MYREPLICATIONServer TargetReplicationServer1
```

**Windows** Options file:

**Windows** The following example demonstrates how to specify options for the secondary server in the dsm.opt file, and how to reference the secondary server. The connection information for the secondary server is located within the REPLSERVERName stanza. The MYREPLICATIONServer option points to the secondary server name that is specified by the REPLSERVERName stanza.

```
REPLSERVERNAME TargetReplicationServer1
REPLTCPSERVERADDRESS TargetReplicationServer1
REPLTCPPOINT 1505
REPLSSLPORT 1506
REPLSERVERGUID 91.0f.ef.90.5c.cc.11.e1.ae.34.08.00.00.00.00
```

COMMMethod	TCPip
TCPPort	1500
TCPServeraddress	server_hostname1.example.com
PASSWORDAccess	prompt
MYREPLICATIONServer	TargetReplicationServer1
MYPRIMARYSERVER	Server1

**Related concepts:**

Automated client failover configuration and use

**Related tasks:**

Configuring the client for automated failover

## Repltcpport

---

The repltcpport option specifies the TCP/IP port on the secondary server to be used when the client connects to the secondary server during a failover.

This option must be specified within a replservername stanza in the client options file. The replservername stanza contains connection information about the secondary server.

This option is set by the IBM Spectrum Protect™ server administrator for the client node. During the normal (non-failover) logon process, the option is sent to the client and is saved in the client options file.

Do not edit this option during normal operations.

Edit this option only during situations such as the following ones:

- The primary server is offline and the information for the secondary server is not in the options file.
- The secondary server information is out-of-date or incorrect.

Any values that you edit are removed or updated the next time you log in to the primary server.

## Supported Clients

---

This option is valid for all clients.

## Options File

---

**AIX** | **Linux** | **Solaris** | **Mac OS X** This option is placed in the dsm.sys file within the replservername stanza.

**Windows** This option is placed in the client options file (dsm.opt).

## Syntax

---

```
>>-repltcpport----port_address-----<<
```

## Parameters

---

port\_address

Specifies the TCP/IP port address that is used to communicate with the secondary server.

## Examples

---

Options file:

```
REPLTCPport 1500
```

Command line:

Does not apply.

**AIX** | **Linux** | **Mac OS X** | **Solaris** Options file:

**AIX** | **Linux** | **Mac OS X** | **Solaris** The following example demonstrates how to specify options for three different servers in the dsm.sys file, and how to reference the secondary server. Connection information for multiple secondary server is presented in stanzas. Each stanza is identified by the replservername option and the name of the secondary

server. The servername stanza must contain the myreplicationserver option, which points to the secondary server that is specified by the replservername stanza. Only one secondary server can be specified per servername stanza.

```
REPLSERVERNAME    TargetReplicationServer1
  REPLTCPSEVERADDRESS TargetReplicationServer1
  REPLTCPSPORT      1505
  REPLSSLPORT       1506
  REPLSERVERGUID    91.0f.ef.90.5c.cc.11.e1.ae.34.08.00.00.00.00

REPLSERVERNAME    TargetReplicationServer2
  REPLTCPSEVERADDRESS TargetReplicationServer2
  REPLTCPSPORT      1505
  REPLSSLPORT       1506
  REPLSERVERGUID    91.0f.ef.90.5c.cc.11.e1.ae.34.08.00.00.00.00.02

SErvername        server_a
  COMMMethod       TCPip
  TCPPort          1500
  TCPSEveraddress  server_hostname1.example.com
  PASSWORDAccess   prompt
  MYREPLICATIONServer TargetReplicationServer1

SErvername        server_b
  COMMMethod       TCPip
  TCPPort          1500
  TCPSEveraddress  server_hostname2.example.com
  PASSWORDAccess   generate
  INCLExcl         /adm/tsm/archive.excl
  MYREPLICATIONServer TargetReplicationServer2

SErvername        server_c
  COMMMethod       TCPip
  TCPPort          1500
  TCPSEveraddress  server_hostname3.example.com
  PASSWORDAccess   generate
  MYREPLICATIONServer TargetReplicationServer1
```

#### Windows Options file:

**Windows** The following example demonstrates how to specify options for the secondary server in the dsm.opt file, and how to reference the secondary server. The connection information for the secondary server is located within the REPLSERVERName stanza. The MYREPLICATIONServer option points to the secondary server name that is specified by the REPLSERVERName stanza.

```
REPLSERVERNAME    TargetReplicationServer1
  REPLTCPSEVERADDRESS TargetReplicationServer1
  REPLTCPSPORT      1505
  REPLSSLPORT       1506
  REPLSERVERGUID    91.0f.ef.90.5c.cc.11.e1.ae.34.08.00.00.00.00.00

COMMMethod        TCPip
TCPPort           1500
TCPSEveraddress   server_hostname1.example.com
PASSWORDAccess    prompt
MYREPLICATIONServer TargetReplicationServer1
MYPRIMARYSERVER   Server1
```

#### Related concepts:

Automated client failover configuration and use

#### Related tasks:

Configuring the client for automated failover

## Repltcpserveraddress

The repltcpserveraddress option specifies the TCP/IP address of the secondary server to be used when the client connects to the secondary server during a failover.

This option must be specified within a replservername stanza in the client options file. The replservername stanza contains connection information about the secondary server.

This option is set by the IBM Spectrum Protect™ server administrator for the client node. During the normal (non-failover) logon process, the option is sent to the client and is saved in the client options file.

Do not edit this option during normal operations.

Edit this option only during situations such as the following ones:

- The primary server is offline and the information for the secondary server is not in the options file.
- The secondary server information is out-of-date or incorrect.

Any values that you edit are removed or updated the next time you log in to the primary server.

## Supported Clients

---

This option is valid for all clients.

## Options File

---

**AIX** | **Linux** | **Solaris** | **Mac OS X** This option is placed in the dsm.sys file within the replservername stanza.

**Windows** Place this option in the client options file (dsm.opt).

## Syntax

---

```
>>-REPLTCPserveraddress----server_address-----<<
```

## Parameters

---

server\_address

Specifies a TCP/IP address for a server that is 1 - 64 characters in length. Specify a TCP/IP domain name or a numeric IP address. The numeric IP address can be either a TCP/IP v4 or TCP/IP v6 address. You can use only IPv6 addresses if you specified the `commmethod V6Tcpip` option.

## Examples

---

Options file:

```
REPLTCPserveraddress dsmchost.example.com
```

Command line:

Does not apply.

**AIX** | **Linux** | **Mac OS X** | **Solaris** Options file:

The following example demonstrates how to specify options for three different servers in the dsm.sys file, and how to reference the secondary server. Connection information for multiple secondary server is presented in stanzas. Each stanza is identified by the replservername option and the name of the secondary server. The servername stanza must contain the myreplicationserver option, which points to the secondary server that is specified by the replservername stanza. Only one secondary server can be specified per servername stanza.

```
REPLSERVERNAME TargetReplicationServer1
REPLTCPSEVERADDRESS TargetReplicationServer1
REPLTCPPOINT 1505
REPLSSLPORT 1506
REPLSERVERGUID 91.0f.ef.90.5c.cc.11.e1.ae.34.08.00.00.00.00

REPLSERVERNAME TargetReplicationServer2
REPLTCPSEVERADDRESS TargetReplicationServer2
REPLTCPPOINT 1505
REPLSSLPORT 1506
REPLSERVERGUID 91.0f.ef.90.5c.cc.11.e1.ae.34.08.00.00.00.00.02

SErvername server_a
COMMethod TCPip
TCPPOINT 1500
TCPSEVERADDRESS server_hostname1.example.com
PASSWORDACCESS prompt
MYREPLICATIONSERVER TargetReplicationServer1
```

```

SErvername      server_b
COMMMethod      TCPip
TCPpPort        1500
TCPServeraddress server_hostname2.example.com
PASSWORDAccess  generate
INCLExcl        /adm/tsm/archive.excl
MYREPLICATIONServer TargetReplicationServer2

SErvername      server_c
COMMMethod      TCPip
TCPpPort        1500
TCPServeraddress server_hostname3.example.com
PASSWORDAccess  generate
MYREPLICATIONServer TargetReplicationServer1

```

**Windows** Options file:

**Windows** The following example demonstrates how to specify options for the secondary server in the dsm.opt file, and how to reference the secondary server. The connection information for the secondary server is located within the REPLSERVERName stanza. The MYREPLICATIONServer option points to the secondary server name that is specified by the REPLSERVERName stanza.

```

REPLSERVERNAME      TargetReplicationServer1
REPLTCPSErverADDRESS TargetReplicationServer1
REPLTCPpPORT        1505
REPLSSLPORT         1506
REPLSErverGUID      91.0f.ef.90.5c.cc.11.e1.ae.34.08.00.00.00.00.00

COMMMethod          TCPip
TCPpPort            1500
TCPSErveraddress    server_hostname1.example.com
PASSWORDAccess      prompt
MYREPLICATIONSErver TargetReplicationServer1
MYPRIMARySErver     SErver1

```

**Related concepts:**

Automated client failover configuration and use

**Related tasks:**

Configuring the client for automated failover

**Windows**

## Resetarchiveattribute

Use the resetarchiveattribute option to specify whether the backup-archive client resets the Windows archive attribute on files that are successfully backed up to the IBM Spectrum Protect™ server.

The client also resets the archive attribute during incremental backups if it is determined that there is already an active object on the server. The resetarchiveattribute option is useful in conjunction with applications, such as IBM Spectrum Control™, as a simple way to report on the backup status of files.

The Windows archive attribute is used to indicate that a file has changed since the last backup. After the client resets the archive attribute, the Windows operating system turns the attribute back to ON after the file has been modified. The client does not use the Windows archive attribute to determine if a file is a candidate for incremental backup, but only manipulates this attribute for reporting purposes. The client uses a much more sophisticated method to determine candidacy for incremental backup.

There are several applications which manipulate or examine the Windows archive attribute. Be aware of the ramifications of using the resetarchiveattribute option in conjunction with these products.

If you set the resetarchiveattribute option to yes, after a file has been successfully backed up to the IBM Spectrum Protect server, the client resets the Windows archive attribute on the local file system:

- The Windows archive attribute is reset during incremental and selective backups after the file has been successfully committed to the IBM Spectrum Protect server database. This attribute is not reset for archive, or image operations.
- The Windows archive attribute is not reset when processing system objects or system state objects.
- The Windows archive attribute is not reset for directory entries.

In addition, in order for the local file system to reflect the current active object inventory on the IBM Spectrum Protect server, the resetarchiveattribute option instructs the client to reset the Windows archive attribute on the local file system if it is determined

during incremental backup that a valid, active backup copy of the file already exists on the server. This behavior is not displayed in the following cases:

- Incremental backup operations which do not examine the stored client attributes on the server, such as journal-based backup or incremental-by-date processing.
- Files that are not examined during an incremental backup operation because they are excluded from backup processing.

The client does not guarantee the accuracy of the current setting of the Windows archive attribute. For example, if the `resetarchiveattribute` option is set to yes and a file examined by a reporting product indicates that the Windows archive attribute is OFF for a particular file, this does not necessarily mean that a valid, active backup copy of the file exists on the IBM Spectrum Protect server. Factors that could contribute to this type of situation include:

- An independent software vendor product is manipulating the Windows archive attribute
- A file space was deleted from the server
- A backup tape was lost or destroyed

There should be no significant performance degradation when using the `resetarchiveattribute` option. The `resetarchiveattribute` option does not affect restore processing.

## Supported Clients

---

This option is valid for all Windows clients. The server can also define this option.

## Options File

---

This option is valid in the client options file (`dsm.opt`) or server client options set. You can set this option on the Backup tab of the Preferences editor.

## Syntax

---

```
>>-RESETARCHIVEATTRIBUTE = .-No--.  
                           -+-----+----->>  
                           '-Yes-'
```

## Parameters

---

Yes

Specifies that you want to reset the Windows archive attribute for files during a backup operation.

No

Specifies that you do not want to reset the Windows archive attribute for files during a backup operation. This is the default.

## Examples

---

Options file:

```
resetarchiveattribute yes
```

## Resourceutilization

---

Use the `resourceutilization` option in your option file to regulate the level of resources the IBM Spectrum Protect™ server and client can use during processing.

## Supported Clients

---

This option is valid for all clients. The server can also define this option. The IBM Spectrum Protect API does not support this option.

## Options File

---

**AIX** | **Linux** | **Solaris** | **Mac OS X** Place this option in the `dsm.sys` file within a server stanza. You can set this option on the General tab, in the Resource Utilization field of the Preferences editor.

**Windows** Place this option in the client options file (dsm.opt). You can set this option on the General tab, in the Resource Utilization field of the Preferences editor.

## Syntax

---

```
>>-RESOURceutilization-- --number-----><
```

## Parameters

---

number

Specifies the level of resources the IBM Spectrum Protect server and client can use during processing. The range of values that you can specify is 1 - 100. The default value is 2.

## Examples

---

Options file:

```
resourceutilization 7
```

Command line:

```
-resourceutilization=7
```

This option is valid only on the initial command line. It is not valid in interactive mode.

- Regulating backup and archive sessions  
When you request a backup or archive, the client can use more than one session to the server.
- Regulating restore sessions  
When you request a restore, the default is to use a maximum of one session.
- Multiple client session considerations  
This topic lists some items to consider when working with multiple client sessions.

## Regulating backup and archive sessions

---

When you request a backup or archive, the client can use more than one session to the server.

The default is to use a maximum of two sessions; one to query the server and one to send file data. The client can use only one server session if you set the `resourceutilization` option to 1.

A client can use more than the default number of sessions when it connects to the IBM Spectrum Protect™ server. For example, `resourceutilization 10` permits up to eight sessions with the server. Multiple sessions can be used for querying the server and sending file data.

Multiple query sessions are used when you specify multiple file specifications with a backup or archive command. For example, if you enter the following commands and you specify `resourceutilization 5`, the client might start a second session to query files on file space B.

```
inc /Volumes/filespaceA /Volumes/filespaceB
```

Whether the second session starts depends on how long it takes to query the server about files that are backed up on file space A. The client might also try to read data from the file system and send it to the server on multiple sessions.

Note: During a backup operation, if you enter multiple file specifications, the result might be that files from one file specification are stored on multiple tapes and interspersed with files from different file specifications. This can decrease restore performance. Setting the `collocatebyfilespec` option to `yes` eliminates interspersing of files from different file specifications, by limiting the client to one server session per file specification. Therefore, if you store the data to tape, files for each file specification are stored together on one tape (unless another tape is required for more capacity).

## Regulating restore sessions

---

When you request a restore, the default is to use a maximum of one session.

Additional restore sessions are based on:



- resourceutilization value
- how many tapes on which the requested data is stored
- how many tape drives are available
- the maximum number of mount points that are allowed for the node

Note:

1. If all of the files are on disk, only one session is used. There is no multi-session for a pure disk storage pool restore. However, if you are performing a restore in which the files are on 4 tapes and others are on disk, you could use up to 5 sessions during the restore.
2. The IBM Spectrum Protect™ server can set the maximum number of mount points a node can use on the server by using the MAXNUMMP parameter. If the resourceutilization option value exceeds the value of the MAXNUMMP on the server for a node, the backup can fail with an `Unknown System Error` message.
3. You can get a multi-session restore from your single restore command, and from a single volume on the server, if that volume is device class FILE.

For example, if the data you want to restore is on 5 different tape volumes, the maximum number of mount points is 5 for your node, and resourceutilization is set to 3, then 3 sessions are used for the restore. If you increase the resourceutilization setting to 5, then 5 sessions are used for the restore. There is a 1 to 1 relationship between the number of restore sessions that are allowed and the resourceutilization setting. Multiple restore sessions are only allowed for no-query restore operations.

## Multiple client session considerations

---

This topic lists some items to consider when working with multiple client sessions.

The following factors can affect the throughput of multiple sessions:

- The ability of the server to handle multiple client sessions. Is there sufficient memory, multiple storage volumes, and processor cycles to increase backup throughput?
- The ability of the client to drive multiple sessions (sufficient processor cycles, memory, etc.).
- The configuration of the client storage subsystem. File systems that are striped across multiple disks, using either software striping or RAID-5 can better handle an increase in random read requests than a single drive file system. Additionally, a single drive file system might not see performance improvement if it attempts to handle many random concurrent read requests.
- Sufficient bandwidth in the network to support the increased traffic.

Potentially undesirable aspects of running multiple sessions include:

- The client could produce multiple accounting records.
- The server might not start enough concurrent sessions. To avoid this, the server `maxsessions` parameter must be reviewed and possibly changed.
- A query node command might not summarize client activity.
- It is possible that files are restored instead of hard links.

Restoring files instead of hard links can occur when the following criteria are all true:

- You restore an entire file system.
- During the restore operation, the value of the `resourceutilization` option is greater than 1.
- The file system contained hard links when the file system was backed up.

The chance of restoring linked files instead of hard links increases as the number of sessions increases. When you restore a file system that contained hard links when the file system was backed up, set `resourceutilization=1` to ensure that hard links are restored.

## Retryperiod

---

The `retryperiod` option specifies the number of minutes the client scheduler waits between attempts to process a scheduled command that fails, or between unsuccessful attempts to report results to the server. Use this option only when the scheduler is running.

**Windows** Your administrator can also set this option. If your administrator specifies a value for this option, that value overrides the value in your client options file after your client node successfully contacts the server.

**AIX** | **Linux** | **Solaris** | **Mac OS X** Your administrator can also set this option. If your administrator specifies a value for this option, that value overrides the value in your client system options file after your client node successfully contacts the server.

## Supported Clients

---

This option is valid for all clients. The IBM Spectrum Protect™ API does not support this option.

## Options File

---

**AIX** | **Linux** | **Solaris** | **Mac OS X** Place this option in the client system-options file (dsm.sys) within a server stanza. You can set this option on the Scheduler tab, in the Retry period field of the Preferences editor.

**Windows** Place this option in the client options file (dsm.opt). You can set this option on the Scheduler tab, in the Retry period field of the Preferences editor.

## Syntax

---

```
>>-RETRYPeriod-- --minutes-----><
```

## Parameters

---

minutes

Specifies the number of minutes the client scheduler waits between attempts to contact the server, or to process a scheduled command that fails. The range of values is 1 through 9999; the default is 20.

## Examples

---

Options file:

```
retryp 10
```

Command line:

```
-retryperiod=10
```

This option is valid only on the initial command line. It is not valid in interactive mode.

## Revokeremoteaccess

---

The revokeremoteaccess option restricts an administrator with client access privilege from accessing a client workstation that is running the web client.

This option does not restrict administrators with client owner, system, or policy privilege from accessing your workstation through the web client.

**AIX** | **Linux** | **Solaris** | **Mac OS X** | **Windows**

## Supported Clients

---

This option is valid for all clients. The IBM Spectrum Protect™ API does not support this option.

## Options File

---

**AIX** | **Linux** | **Solaris** | **Mac OS X** Place this option in the client system-options file (dsm.sys) within a server stanza. You can set this option on the Web Client tab of the Preferences editor.

**Windows** Place this option in the client options file (dsm.opt). You can set this option on the Web Client tab of the Preferences editor.

## Syntax

---

```
>>-REVOKEremoteaccess--+-None---+-----><
                        '-Access-'
```

## Parameters

---

- None  
Does not revoke access to administrators who have client access authority for the client. This is the default.
- Access  
Revokes access to administrators who have client access authority for the client.

## Examples

---

Options file:  
`revokeremoteaccess none`

Command line:  
Does not apply.

Windows

## Runasservice

---

The runasservice option forces the client command process to continue running, even if the account that started the client logs off.

Use this option with the AT command and the dsmc sched command when you schedule client command batch jobs. The runasservice option is *not* valid in any options file (dsm.opt or tsmasr.opt).

**Important:** Use the scheduler service when running IBM Spectrum Protect™ services unattended. Set runasservice=yes only to schedule client commands using the Windows AT command. Setting runasservice=yes might interfere with other interactive uses of the backup-archive client.

## Supported Clients

---

This option is valid for all Windows clients. The IBM Spectrum Protect API does not support this option.

## Syntax

---

```
>>-RUNASSERVICE--+-No-- .  
                  +-----+-----><  
                  '-Yes-'
```

## Parameters

---

- No  
Does not force the client command process to continue running, even if the account that started the client logs off. This is the default.
- Yes  
Forces the client command process to continue running, even if the account that started the client logs off.

### Restrictions:

1. When runasservice=yes, the setting for the REPLACE is always overridden to the behavior of replace=no.
2. The option runasservice=yes cannot be used with passwordaccess=prompt.
3. Backup, archive, restore and retrieve operations performed with runasservice=yes that encounter prompts always fail. To avoid this problem, either save the encryption key password with encryptkey=save, or turn off the runasservice option.

## Examples

---

Command line:  
`-runasservice=yes`

This option is valid only on the initial command line. It is not valid in interactive mode.

## Schedcmddisabled

---

The schedcmddisabled option specifies whether to disable the scheduling of commands by the server action=command option on the define schedule server command.

This option does not disable the preschedulecmd and postschedulecmd commands. However, you can specify preschedulecmd or postschedulecmd with a blank or a null string to disable the scheduling of these commands.

You can disable the scheduling of commands defined by your IBM Spectrum Protect™ administrator by setting the schedcmddisabled option to yes.

Use the query schedule command to query the schedules defined by your administrator.

## Supported Clients

---

This option is valid for all clients. The server can also define this option. The IBM Spectrum Protect API does not support this option.

## Options File

---

**Windows** Place this option in the client options file (dsm.opt).

**AIX** | **Linux** | **Solaris** | **Mac OS X** Place this option in the dsm.sys file within a server stanza.

## Syntax

---

```
>>-SCHEDCMDDisabled--+-No-- .-No-- .  
                        +-----+----->>  
                        '-Yes-'
```

## Parameters

---

Yes

Specifies that the server disables the scheduling of commands using the action=command option on the DEFINE SCHEDULE server command.

No

Specifies that the server does not disable the scheduling of commands using the action=command option on the DEFINE SCHEDULE server command. This is the default.

## Examples

---

Options file:

```
schedcmddisabled no
```

Command line:

Does not apply.

## Schedcmdexception

---

The schedcmdexception option is used in conjunction with the schedcmddisabled option to disable the scheduling of commands by the server action=command option on the DEFINE SCHEDULE server command, except for specific command strings.

You must specify the exact string that matches the "objects" definition in the schedule for the scheduled server command to be accepted. If the string does not match exactly (for example, there is an extra space or the capitalization is different), the scheduled command action is blocked.

You can provide multiple schedcmdexception options in the options file. This option is not honored if schedcmddisabled is not enabled. The placement of this option in the options file is independent of the placement of the schedcmddisabled option.

## Supported Clients

---

This option is valid for all clients. This option is not valid in the IBM Spectrum Protect™ server client options set.

## Options File

---

**Windows** Place this option in the client options file (dsm.opt).

**AIX** | **Linux** | **Solaris** | **Mac OS X** Place this option in the dsm.sys file within a server stanza.

## Syntax

---

```
>>-SCHEDCMDEXCEPTION--string----->>
```

## Parameters

---

string

For commands scheduled by the action=command option on the DEFINE SCHEDULE server command, this parameter indicates the objects pattern to enable if the schedcmddisabled=yes option is specified. This parameter is case sensitive, and must match the command string on the IBM Spectrum Protect server schedule definition.

## Example

---

Options file:

```
schedcmddisabled yes  
Windows schedcmDEXCEPTION "start dir c: /s"  
schedcmDEXCEPTION "start echo hello, world!"
```

## Schedgroup

---

The schedgroup option assigns a schedule to a group.

An example of the use of this option is to group multiple daily local backup schedules with a single server backup schedule.

## Supported Clients

---

This option is valid for all clients as a command-line option for the server DEFINE SCHEDULE command. This option cannot be added to a client option set that is on the IBM Spectrum Protect™ server.

## Syntax

---

```
>>-SCHEDGROUP-- --schedule_group_name----->>
```

## Parameters

---

schedule\_group\_name

Specifies the name of the schedule group. You can specify up to 30 characters for the name.

For a list of valid characters that you can use in the schedule group name, see Naming IBM Spectrum Protect objects

## Examples

---

The following example commands group schedules SCHED\_A\_1, SCHED\_A\_2, SCHED\_A\_3, and SCHED\_A\_4 in to schedule group GROUP\_A.

Command line:

This example shows a local backup at 6 AM:

```
define schedule standard SCHED_A_1 Type=Client ACTION=Backup SUBACTION=VM OPTIONS='-  
vmfulltype=vstor -vmbackuptype=fullvm -vmbackuplocation=local -domain.vmfull="SCHEDULE-TAG" -
```

```
asnodename=DC_SARTRE_WB -SCHEDGROUP=GROUP_A' STARTDate=02/06/2017 STARTTime=06:00:00  
SCHEDStyle=Enhanced DAYofweek=ANY
```

This example shows a local backup at 12 PM:

```
define schedule standard SCHED_A_2 Type=Client ACTION=Backup SUBACTION=VM OPTIONS='-  
vmfulltype=vstor -vmbackuptype=fullvm -vmbackuplocation=local -domain.vmfull="SCHEDULE-TAG" -  
asnodename=DC_SARTRE_WB -SCHEDGROUP=GROUP_A' STARTDate=02/06/2017 STARTTime=12:00:00  
SCHEDStyle=Enhanced DAYofweek=ANY
```

This example shows a local backup at 6 PM:

```
define schedule standard SCHED_A_3 Type=Client ACTION=Backup SUBACTION=VM OPTIONS='-  
vmfulltype=vstor -vmbackuptype=fullvm -vmbackuplocation=local -domain.vmfull="SCHEDULE-TAG" -  
asnodename=DC_SARTRE_WB -SCHEDGROUP=GROUP_A' STARTDate=02/06/2017 STARTTime=18:00:00  
SCHEDStyle=Enhanced DAYofweek=ANY
```

This example shows a local and server backup at midnight:

```
define schedule standard SCHED_A_4 Type=Client ACTION=Backup SUBACTION=VM OPTIONS='-  
vmfulltype=vstor -vmbackuptype=fullvm -vmbackuplocation=both -domain.vmfull="SCHEDULE-TAG" -  
asnodename=DC_SARTRE_WB -SCHEDGROUP=GROUP_A' STARTDate=02/06/2017 STARTTime=00:00:00  
SCHEDStyle=Enhanced DAYofweek=ANY
```

Tip: Ensure that each schedule in the group can complete before the next schedule is set to start.  
This option is valid only on the initial command line. It is not valid in interactive mode.

## Schedlogmax

---

The `schedlogmax` option specifies the maximum size of the schedule log (`dsmsched.log`) and web client log (`dsmwebcl.log`), in megabytes.

This option causes the log files that get created for scheduler events (`dsmsched.log`) and web client events (`dsmwebcl.log`) to wrap around when they reach their maximum size. As scheduler and web client events are logged, log records are added to the end of the log files until the maximum specified size is reached. When the maximum specified size is reached, a log record saying `Continued at beginning of file` is placed as the last record in the file. Subsequent logging is resumed at the beginning of the file. The end of the wrapped log is indicated by a record saying `END OF DATA`.

When you set the `schedlogmax` option, scheduler and web client log messages are not saved in a prune file. If you want to prune logs and save the pruned log entries to another file, see the `schedlogretention` option.

If you change from log wrapping (`schedlogmax` option) to log pruning (`schedlogretention` option), all existing log entries are retained and the log is pruned using the new `schedlogretention` criteria.

If you change from log pruning (`schedlogretention` option) to log wrapping (`schedlogmax` option), all records in the existing logs are copied to a file containing the pruned entries. For example, log records pruned from the `dsmsched.log` file are copied to `dsmsched.pru`. Log records pruned from `dsmwebcl.log` are copied to `dsmwebcl.pru`. The existing logs (`dsmsched.log` and `dsmwebcl.log`) are emptied, and logging begins using the new log wrapping criteria.

If you simply change the value of the `schedlogmax` option, the existing log is extended or shortened to accommodate the new size. If the value is reduced, the oldest entries are deleted to reduce the file to the new size.

If neither `schedlogmax` nor `schedlogretention` is specified, the error log can grow without any limit on its size. You must manually manage the log contents to prevent the log from depleting disk resources. When the log has been created with neither option specified, if you later issue a command and specify the `schedlogretention` option, the log is pruned using the retention value specified. When the log has been created with neither option specified, if you later issue a command and specify the `schedlogmax` option, the existing log is treated as if it was a pruned log. That is, the content of the `dsmsched.log` file is copied to a file called `dsmsched.pru`, the content of `dsmwebcl.log` is copied to a file called `dsmwebcl.pru`, and new log entries are created in `dsmsched.log` and `dsmwebcl.log`, and both files wrap when they reach their maximum size.

Note: If you specify a non-zero value for `schedlogmax` (which enables log wrapping), you cannot use the `schedlogretention` option to create pruned logs. Logs can be pruned or wrapped, but not both.

Logs created with the `schedlogmax` option contain a log header record that contains information similar to this example record:

```
LOGHEADERREC 661 104857600 IBM Spectrum Protect 8.1.0.0 Fri Dec 9 06:46:53 2014
```

Note that the dates and time stamps in the `LOGHEADERREC` text are not translated or formatted using the settings specified on the `dateformat` or `timeformat` options.

## Supported Clients

---

This option is valid for all clients.

## Options File

---

**AIX Linux Solaris Mac OS X** Place this option in the client system-options file (dsm.sys) within a server stanza.

**Windows** Place this option in the client options file (dsm.opt).

**AIX Linux Mac OS X Solaris Windows** You can also set this option on the Client Preferences > Scheduler tab in the GUI, by selecting Enable scheduler log file wrapping and by specifying a non-zero maximum size for the log file. To prevent log file wrapping, set the maximum size to zero. When the maximum wrapping is set to zero, clearing or setting the Enable scheduler log file wrapping option has no effect; log wrapping does not occur if the maximum size is set to zero.

## Syntax

---

```
>>-SCHEDLOGMAX-- --size-----<<
```

## Parameters

---

size

Specifies the maximum size, in megabytes, for the log file. The range of values is 0 to 2047; the default is 0, which disables log file wrapping and allows the log file to grow indefinitely.

## Examples

---

Options file:

```
  schedlogmax 100
```

Command line:

```
-schedlogmax=100
```

This option is valid only on the initial command line. It is not valid in interactive mode.

## Schedlogname

---

The schedlogname option specifies the path and file name where you want to store schedule log information.

Use this option only when you want to store schedule log information. This option applies only when the scheduler is running.

If this option is not used, the `dsmsched.log` file is created in the same directory as the `dsmerror.log` file.

When you run the schedule command, output from scheduled commands appears on your screen. Output is also sent to the file you specify with this option. If any part of the path you specify does not exist, the client attempts to create it.

## Supported Clients

---

This option is valid for all clients. The IBM Spectrum Protect™ API does not support this option.

## Options File

---

**AIX Linux Solaris Mac OS X** Place this option in the client system-options file (dsm.sys) within a server stanza. You can set this option on the Scheduler tab, in the Schedule Log text box, in the Preferences editor.

**Windows** Place this option in the client options file (dsm.opt). You can set this option on the Scheduler tab, in the Schedule Log text box, in the Preferences editor.

**AIX Linux Solaris Mac OS X**  
 Note: Set the `DSM_LOG` environment variable to name a directory where the log is to be placed. The directory specified must have permissions which allow write access from the account under which the client is run. The root directory is not a valid value for

DSM\_LOG.

**Windows**

Note: Set the DSM\_LOG environment variable to name a directory where the log is to be placed. The directory specified must have permissions which allow write access from the account under which the client is run.

## Syntax

---

```
>>-SCHEDLOGName-- --filespec-----><
```

## Parameters

---

filespec

Specifies the path and file name where you want to store schedule log information when processing scheduled work. If any part of the path you specify does not exist, the client attempts to create it.

**Windows** If you specify a file name only, the file is stored in your current directory. The default is the current working directory with a file name of `dsmsched.log`.

**AIX** **Linux** **Solaris** **Mac OS X** If you specify a file name only, the file is stored in your current directory. The default is the current working directory with a file name of `dsmsched.log`. The `dsmsched.log` file *cannot* be a symbolic link.

**Mac OS X** For Mac OS X, if you specify a file name only, the file is stored in your default folder. The default directories are:

```
~/Library/Logs/tivoli/tsm  
/Library/Logs/tivoli/tsm
```

## Examples

---

Options file:

**Mac OS X**

```
SCHEDLOGN /Users/user1/Library/Logs/schedlog.jan
```

**AIX** **Linux** **Solaris** **Mac OS X**

```
schedlogname /home/mydir/schedlog.jan
```

**Windows**

```
schedlogname c:\mydir\schedlog.jan
```

**Mac OS X** Command line:

**Mac OS X** `-schedlogname=/Users/user1/Library/Logs/schedlog.jan`

**AIX** **Linux** **Solaris** **Mac OS X** Command line:

**AIX** **Linux** **Solaris** **Mac OS X** `-schedlogname=/home/mydir/schedlog.jan`

**Windows** Command line:

**Windows** `-schedlogn=c:\mydir\schedlog.jan`

This option is valid only on the initial command line. It is not valid in interactive mode.

## Schedlogretention

---

The `schedlogretention` option specifies the number of days to keep entries in the schedule log (`dsmsched.log`) and the web client log (`dsmwebcl.log`), and whether to save the pruned entries in another file.

The schedule log (`dsmsched.log`) is pruned when the scheduler starts and after a scheduled event completes. Pruned entries are written to a file called `dsmsched.pru`.

The web client log (`dsmwebcl.log`) is pruned during the initial start of the client acceptor daemon. Pruned entries are written to a file called `dsmwebcl.pru`.

If you change from log pruning (`schedlogretention` option) to log wrapping (`schedlogmax` option), all records in the existing log are copied to the pruned log (`dsmsched.pru` and `dsmwebcl.pru`), and the existing logs (`dsmsched.log` and `dsmwebcl.log`) are emptied, and logging begins using the new log wrapping criteria.



If you change from log wrapping (schedlogmax option) to log pruning (schedlogretention option), all existing log entries are retained and the log is pruned using the new schedlogretention criteria. Pruned entries are saved in their corresponding \*.pru files.

If neither schedlogmax nor schedlogretention is specified, the logs can grow without any limit on their size. You must manually manage the log contents to prevent the log from depleting disk resources. When the log has been created with neither option specified, if you later issue a command and specify the schedlogretention option, the log is pruned using the retention value specified. When the log has been created with neither option specified, if you later issue a command and specify the schedlogmax option, the existing log is treated as if it was a pruned log. That is, the content of the dsmsched.log file is copied to a file called dsmsched.pru, the content of dsmwebcl.log is copied to dsmwebcl.pru, and new log entries are created in both dsmsched.log and dsmwebcl.log, and both files wrap when they reach their maximum size.

Note: If you specify schedlogretention option to create pruned logs, you cannot specify the schedlogmax option. Logs can be pruned or wrapped, but not both.

AIX Linux Solaris Mac OS X Windows

## Supported Clients

This option is valid for all clients.

## Options File

AIX Linux Solaris Mac OS X Place this option in the client system-options file (dsm.sys) within a server stanza.

Windows Place this option in the client options file (dsm.opt).

AIX Linux Mac OS X Solaris Windows You can also set this option on the Client preferences > Scheduler tab in the GUI, by selecting Prune old entries and by specifying a value for Prune entries older than. Selecting the Save pruned entries option saves the pruned scheduler log entries in the dsmsched.pru log file. Selecting Save pruned entries also saves web client log entries in the dsmwebcl.pru log file.

## Syntax

```
>>-SCHEDLOGRetention--+-N---+---D-+-----><
                          '-days-'   '-S-'
```

## Parameters

N or days

Specifies how long to wait before pruning the log.

N

Do not prune the log. This permits the log to grow indefinitely. This is the default.

days

Specifies the number of days to keep log file entries before pruning. The range of values is zero through 9999.

D or S

Specifies whether to save the pruned entries. Use a space or comma to separate this parameter from the previous one.

D

Discards the log entries when pruning the log. This is the default.

S

Saves the log entries when pruning the log.

Pruned entries are copied to the file of pruned entries (dsmsched.pru or dsmwebcl.pru), which is stored in the same directory as the log.

## Examples

Options file:

```
schedlogretention 30 S
```

Command line:

```
-schedlogretention=30,S
```

This option is valid only on the initial command line. It is not valid in interactive mode.

## Schedmode

---

The schedmode option specifies whether you want to use the polling mode (your client node periodically queries the server for scheduled work), or the prompted mode (the server contacts your client node when it is time to start a scheduled operation).

All communication methods can use the client polling mode, but only TCP/IP can use the server prompted mode.

This option applies only if you are using the TCP/IP communication method, and the schedule command is running.

**Windows** Your administrator can specify that the server support both modes or just one mode. If your administrator specifies that both modes are supported, you can select either schedule mode. If your administrator specifies only one mode, you must specify that mode in your dsm.opt file or scheduled work is not processed.

**AIX** **Linux** **Solaris** **Mac OS X** Your administrator can specify that the server support both modes or just one mode. If your administrator specifies that both modes are supported, you can select either schedule mode. If your administrator specifies only one mode, you must specify that mode in your dsm.sys file or scheduled work is not processed.

**Windows** If you specify prompted mode, you should consider supplying values for the tcpclientaddress and tcpclientport options in your dsm.opt file or on the schedule command; the client can then be contacted at either an address or a port of your choice (useful for client systems with multiple network interface cards).

**AIX** **Linux** **Solaris** **Mac OS X** If you specify prompted mode, you should consider supplying values for the tcpclientaddress and tcpclientport options in your dsm.sys file or on the schedule command; the client can then be contacted at either an address or a port of your choice (useful for client systems with multiple network interface cards).

Note:

- Windows** When changing the setting of this option in the client options file (dsm.opt) you must stop and restart the scheduler service for the setting to take effect.
- AIX** **Linux** **Solaris** **Mac OS X** When changing the setting of this option in the dsm.sys file you must stop and restart the scheduler service for the setting to take effect.
- The server can also define this option.

**AIX** **Linux** **Solaris** **Mac OS X** **Windows**

## Supported Clients

---

This option is valid for all clients.

## Options File

---

**AIX** **Linux** **Solaris** **Mac OS X** Place this option in the client system-options file (dsm.sys) within a server stanza. You can set this option on the Scheduler tab, in the Schedule Mode section in the Preferences editor.

**Windows** Place this option in the client options file (dsm.opt). You can set this option on the Scheduler tab, in the Schedule Mode section in the Preferences editor.

## Syntax

---

```
    .-Polling--.  
>>-SCHEDMODE-----<<  
    '-PRompted-'
```

## Parameters

---

### Polling

The client scheduler queries the server for scheduled work at prescribed time intervals. This is the default. You can set the time intervals using the queryschedperiod option.

**AIX** **Linux** **Solaris** **Mac OS X** **Windows** PRompted

**AIX Linux Solaris Mac OS X Windows** The client scheduler waits for the server to contact your client node when scheduled work needs to be done.

Note:

1. **Windows** Use schedmode prompted in conjunction with the autodeploy option, to enable the scheduler to process the client deployment schedule immediately.
2. If you use the dsmc schedule command and both schedmode prompted and commmethod V6Tcip are specified, the client and IBM Spectrum Protect™ server must be configured for IPv6. Additionally, the client host name must be set up for the IPv6 address.

### Examples

---

```
Options file:
    schedmode prompted
Command line:
    -schedmod=po
```

This option is valid only on the initial command line. It is not valid in interactive mode.

**Related reference:**  
**Windows** Autodeploy  
Cadlistenonport  
Tcpclientaddress  
Tcpclientport

### Schedrestretrdisabled

---

The schedrestretrdisabled option specifies whether to disable the execution of restore or retrieve schedule operations.

### Supported Clients

---

This option is valid for all clients. The server cannot define this option. The IBM Spectrum Protect™ API does not support this option.

### Options File

---

**AIX Linux Solaris Mac OS X** Place this option in the dsm.sys file within a server stanza for the scheduler. You can set this option on the Scheduler tab in the Schedule Command section in the Preferences editor.

**Windows** Place this option in the client options file (dsm.opt) for the scheduler. You can set this option on the Scheduler tab in the Schedule Command section in the Preferences editor.

### Syntax

---

```
.-No--.
>>-SCHEDRESTRETRDisabled-+-----+----->>
                           '-Yes-'
```

### Parameters

---

- No  
Specifies that the client does not disable the execution of restore and retrieve schedule operations. This parameter is the default.
- Yes  
Specifies that the client disables the execution of restore and retrieve schedule operations.

### Examples

---

```
Options file:
    schedrestretrdisabled yes
Command line:
```

Does not apply.

## Scrolllines

---

The scrolllines option specifies the number of lines of information that are displayed on your screen at one time.

Use this option when you set the scrollprompt option to Yes.

You can use the scrolllines option with the following commands only:

- delete filesystem
- query archive
- query backup
- query backupset
- query filesystem
- query group
- |     |       |         |         |
|-----|-------|---------|---------|
| AIX | Linux | Solaris | Windows |
|-----|-------|---------|---------|

 query image
- |     |       |         |          |         |
|-----|-------|---------|----------|---------|
| AIX | Linux | Solaris | Mac OS X | Windows |
|-----|-------|---------|----------|---------|

 query nas
- |     |       |         |          |         |
|-----|-------|---------|----------|---------|
| AIX | Linux | Solaris | Mac OS X | Windows |
|-----|-------|---------|----------|---------|

 query node
- query options

## Supported Clients

---

This option is valid for all clients. The server can also define this option. The IBM Spectrum Protect™ API does not support this option.

## Options File

---

Place this option in the client user-options file (dsm.opt). You can set this option in Command Line > Number of lines to display in the Preferences editor.

**Windows** Place this option in the client options file (dsm.opt). You can set this option in Command Line > Number of lines to display in the Preferences editor.

## Syntax

---

```
>>>-SCROLLLines-- --number-----<<<
```

## Parameters

---

number

Specifies the number of lines of information that are displayed on your screen at one time. The range of values is 1 through 80; the default is 20.

## Examples

---

Options file:

```
scrolllines 25
```

Command line:

```
-scrollll=25
```

This option is valid on the initial command line and in interactive mode. If you use this option in interactive mode, it affects only the command with which it is specified. When that command completes, the value reverts to the value at the beginning of the interactive session. This is the value from the dsm.opt file unless overridden by the initial command line or by an option forced by the server.

## Scrollprompt

---

The scrollprompt option specifies whether you want the backup-archive client to stop and wait after displaying the number of lines of information you specified with the scrolllines option, or scroll through and stop at the end of the information list.

You can use the scrollprompt option with the following commands only:

- delete filespace
- query archive
- query backup
- query backupset
- query filespace
- query group
- |     |       |         |         |
|-----|-------|---------|---------|
| AIX | Linux | Solaris | Windows |
|-----|-------|---------|---------|

 query image
- |     |       |         |          |         |
|-----|-------|---------|----------|---------|
| AIX | Linux | Solaris | Mac OS X | Windows |
|-----|-------|---------|----------|---------|

 query nas
- |     |       |         |          |         |
|-----|-------|---------|----------|---------|
| AIX | Linux | Solaris | Mac OS X | Windows |
|-----|-------|---------|----------|---------|

 query node
- query options

## Supported Clients

---

This option is valid for all clients. The server can also define this option. The IBM Spectrum Protect™ API does not support this option.

## Options File

---

Place this option in the client user-options file (dsm.opt). You can set this option on the Command Line tab, Pause after displaying the following number of lines field of the Preferences editor.

## Syntax

---

```
>>-SCROLLPrompt--+-No--+.----->>  
                    '-Yes-'
```

## Parameters

---

No

Scrolls to the end of the list and stops. This is the default.

Yes

Stops and waits after displaying the number of lines you specified with the scrolllines option. The following prompt is displayed on the screen:

```
Press 'Q' to quit, 'C' to continuous scroll, or 'Enter' to  
continue.
```

## Examples

---

Options file:

```
scrollprompt yes
```

Command line:

```
-scrollp=yes
```

This option is valid on the initial command line and in interactive mode. If you use this option in interactive mode, it affects only the command with which it is specified. When that command completes, the value reverts to the value at the beginning of the interactive session. This is the value from the dsm.opt file unless overridden by the initial command line or by an option forced by the server.

AIX	Linux	Solaris	Mac OS X
-----	-------	---------	----------

## Servername

---

In your dsm.sys file, the servername option specifies the name you want to use to identify a server and to begin a stanza containing options for that server. You can name and specify options for more than one server.

The following example demonstrates how to specify options for two different servers:

In your client user-options file (dsm.opt), the `servername` option specifies which server, of those named in your dsm.sys file, to contact for backup-archive services. When specified in a client user-options file (dsm.opt) or on the command line, the `servername` option overrides the default server specified in your client system options file.

Note:

1. You cannot use the `servername` option to override the server that is specified for migration in your client system options file.
2. If the IBM Spectrum Protect™ server name changes or backup-archive clients are directed to a different IBM Spectrum Protect server, all clients must have a new password initialized for the new server name.

## Supported Clients

---

This option is for all UNIX and Linux clients.

## Options File

---

Place this option in the client user options file (dsm.opt) and in the client system options file (dsm.sys). In the dsm.sys file, the `servername` option is the beginning of a server stanza.

Do not modify this option in dsm.opt when you are running the Backup-Archive client in a command-line session or when you are running the Backup-Archive client GUI.

## Syntax

---

```
>>-SErvername-- --servername-----><
```

## Parameters

---

`servername`

In your dsm.sys file, specify the name you want to assign to a particular server. In your client user-options file (dsm.opt) or on the command line, specify the name of the server you want to contact for backup-archive services. The value of `servername` in dsm.opt must match a `servername` value in dsm.sys, or the client cannot contact the server.

A server name is not case sensitive; it can have up to 64 characters.

## Examples

---

Options file:

```
servername server_a
```

Command line:

```
-se=server_b
```

This option is valid only on the initial command line. It is not valid in interactive mode.

## Sessioninitiation

---

Use the `sessioninitiation` option to control whether the server or client initiates sessions through a firewall. The default is that the client initiates sessions. You can use this option with the `schedule` command.

**AIX | Linux | Solaris | MacOS X** For the client scheduler, you do not need to open any ports on the firewall. If you set the `sessioninitiation` option to `serveronly`, the client will not attempt to contact the server. All sessions must be initiated by server prompted scheduling on the port defined on the client with the `tcpclientport` option. The `sessioninitiation` option only affects the behavior of the client scheduler running in the prompted mode. If you set the `sessioninitiation` option to `serveronly`, with the exception of client acceptor daemon-managed schedulers, the command-line client, the backup-archive client GUI, and web client GUI still attempts to initiate sessions.

**Windows** For the client scheduler, you do not need to open any ports on the firewall. If you set the `sessioninitiation` option to `serveronly`, the client will not attempt to contact the server. All sessions must be initiated by server prompted scheduling on the port defined on the client with the `tcpclientport` option. The `sessioninitiation` option only affects the behavior of the client scheduler running in the prompted mode. If you set the `sessioninitiation` option to `serveronly`, with the exception of client acceptor

daemon-managed schedulers, the command-line client, the backup-archive client GUI, and web client GUI still attempt to initiate sessions.

Attention: You cannot use the `dsmcad` for scheduling when you set the `sessioninitiation` option to `serveronly`

**AIX** | **Linux** | **Solaris** | **Mac OS X** Note: If you set the `sessioninitiation` option to `serveronly`, the client setup wizard and scheduler service are unable to authenticate to the IBM Spectrum Protect™ server. In this case, you can execute the scheduler from the command line (`dsmc schedule`) and enter the password for your node when prompted.

**Windows** Note: If you set the `sessioninitiation` option to `serveronly`, the client setup wizard and scheduler service are unable to authenticate to the IBM Spectrum Protect server. In this case, you can execute the scheduler from the command line (`dsmc schedule`) and enter the password for your node when prompted, or use the following `dsmcutil` command to update the password:

```
dsmcutil updatepw /node:nnn /commServer:server1.example.com /password:ppp /validate:no
```

A similar problem can occur if an encryption key is required for backup operations. In this case, you can execute the scheduler from the command line (`dsmc schedule`) and enter the encryption key when prompted. After the password and encryption key are updated, you must restart the scheduler.

If you set the `sessioninitiation` option to `client`, the client initiates sessions with the server by communicating on the TCP/IP port defined with the `server` option `tcpport`. This is the default. Server prompted scheduling can be used to prompt the client to connect to the server.

Note:

1. The IBM Spectrum Protect server can specify `SESSIONINITiation=clientserver` or `SESSIONINITiation=serveronly` on the register node and update node commands. If the server specifies `SESSIONINITiation=clientserver`, the client can decide which method to use. If the server specifies `SESSIONINITiation=serveronly`, all sessions are initiated by the server.
2. If `sessioninitiation` is set to `serveronly`, the value for the `tcpclientaddress` client option must be the same as the value for the `HLAddress` option of the update node or register node server command. The value for the `tcpclientport` client option must be the same as the value for the `LLAddress` option of the update node or register node server command.

## Supported Clients

This option is valid for all clients. The IBM Spectrum Protect API does not support this option.

## Options File

**AIX** | **Linux** | **Solaris** | **Mac OS X** Place this option in the `dsm.sys` file within a server stanza. You can set this option on the Scheduler tab, Session Initiation field of the Preferences editor.

**Windows** Place this option in the client options file (`dsm.opt`). You can set this option on the Scheduler tab, Session Initiation field of the Preferences editor.

## Syntax

```
.-Client----.
>>-SESSIONINITiation--+-----+----->>
'-SERVEROnly-'
```

## Parameters

Client

Specifies that the client initiates sessions with the server by communicating on the TCP/IP port defined with the `server` option `TCPPORT`. This is the default. Server prompted scheduling can be used to prompt the client to connect to the server.

**AIX** | **Linux** | **Solaris** | **Mac OS X** `SERVEROnly`

**AIX** | **Linux** | **Solaris** | **Mac OS X** Specifies that the server will not accept client requests for sessions. All sessions must be initiated by server prompted scheduling on the port defined on the client with the `tcpclientport` option. Except for client acceptor daemon-managed schedulers, the command-line client, the backup-archive client GUI, and web client GUI still attempt to initiate sessions.

**AIX** | **Linux** | **Solaris** | **Mac OS X** If the server `AUTHENTICATION` option is set to `LDAP`, do not set the `client sessioninitiation` option to `serveronly`; if you do, schedules cannot run.

**Windows** `SERVEROnly`

**Windows** Specifies that the server will not accept client requests for sessions. All sessions must be initiated by server prompted scheduling on the port defined on the client with the `tcpclientport` option. Except for client acceptor daemon-managed schedulers, the command-line client, the backup-archive client GUI, and web client GUI still attempt to initiate sessions.

**Windows** If the server AUTHENTICATION option is set to LDAP, do not set the client sessioninitiation option to `serveronly`; if you do, schedules cannot run.

## Examples

---

Options file:

```
sessioninitiation serveronly
```

Command line:

```
schedule -sessioninitiation=serveronly
```

This option is valid only on the initial command line. It is not valid in interactive mode.

## Setwindowtitle

---

Use the `setwindowtitle` option to modify the title of the administrative client command window during processing.

For example, when you run the administrative client command (`dsmadm`) on the client node and the administrative client connects to the IBM Spectrum Protect™ server, the following text is displayed in the title of the command window:

```
CONNECTED TO SERVER: servername(serverhostname)
```

where *servername* is the name of the IBM Spectrum Protect server, and *serverhostname* is the host name of the IBM Spectrum Protect.

When you use the `setwindowtitle` option, any user-defined title of the command window is overwritten. After you disconnect the administrative client from the IBM Spectrum Protect server, the window title is reset to the user-defined window title.

**AIX** | **Linux** | **Solaris** On AIX®, Linux, and Oracle Solaris operating systems, the terminal window title is reset to the title "Terminal" after you disconnect from the server.

## Supported Clients

---

This option is valid for all clients.

## Options File

---

**AIX** | **Linux** | **Mac OS X** | **Solaris** Place this option in the client user-options file (`dsm.opt`) or the client system-options file (`dsm.sys`).

**Windows** Place this option in the client options file (`dsm.opt`).

## Syntax

---

```
>>-SETWINDOWTITLE--+-No-- .
                    +-----+----->>
                    '-Yes-'
```

## Parameters

---

No

The title of the administrative client command window is not changed during processing. This parameter is the default.

Yes

The IBM Spectrum Protect server name and host server name is displayed in the title of the administrative client command window.

## Examples

---



Options file:

```
SETWINDOWTITLE YES
```

Command line:

```
-setwindowtitle=yes
```

This option is valid only on the initial command line. It is not valid in interactive mode.

AIX Linux Solaris Windows

## Shmport

---

The shmport option specifies the TCP/IP port address of a server when using shared memory. All shared memory communications start with a TCP/IP connection.

AIX Linux Solaris

Note: The value specified for the shmport option in the dsm.sys file must match the value specified for shmport in the server options file.

Windows

Note: The value specified for the shmport option in the client options file (dsm.opt) must match the value specified for shmport in the server options file.

## Supported Clients

---

AIX Linux Solaris

This option is valid for AIX®, Linux, and Oracle Solaris clients.

Windows

This option is valid for all Windows clients.

## Options File

---

AIX Linux Solaris

Place this option in the client system-options file (dsm.sys) within a server stanza.

Windows

Place this option in the client options file (dsm.opt).

## Syntax

---

```
>>-SHMPort-- --port_number-----<<
```

## Parameters

---

port\_number

AIX Linux Solaris

Specifies the port number. You can specify a value from 1000 to 32767. The default value is 1510.

Windows

Specifies the port number. You can specify a value from 1 to 32767. The default value is 1510.

## Examples

---

Options file:

```
shmport 1580
```

Command line:

Does not apply.

AIX Linux Solaris Windows

## Showmembers

---

Use the showmembers option to display all members of a group.

AIX Linux Solaris

You can use the showmembers option with the query group, and restore group commands.

Windows

You can use the showmembers option with the query group, query systemstate, and restore group, commands.

The showmembers option is not valid with the inactive option. If you want to display members of a group that are not currently active, use the pitdate and pittime options.

## Supported Clients

**AIX Linux Solaris** This option is valid for all UNIX and Linux clients except Mac OS X.

**Windows** This option is valid for all Windows clients.

## Syntax

```
>>-SHOWMembers-----<<
```

## Parameters

There are no parameters for this option.

## Examples

Command line:

**AIX Linux Solaris**

```
restore group /virtfs/* -pick -showmembers
```

**Windows**

```
restore group {virtfs}\* -pick -showmembers
```

## Skipacl

The skipacl option allows you to include or exclude access control list (ACL) data during a backup or archive operation; by default, ACL data is included.

When this option is set to yes, the backup-archive client does not include ACL data when it backs up or archives files and directories. The default is no, which enables the ACL data to be included when objects are copied to the server. You should only set the skipacl to yes when ACLs are not defined on the file system, or when you are certain that you do not need the ACL data when the files are retrieved or restored.

## Supported Clients

This option is valid for all UNIX and Linux clients. On Linux and AIX systems, setting skipacl to yes also omits the extended attributes.

## Options File

Place this option in the client user options (dsm.opt) file.

## Syntax

```
>>-SKIPACL-+-No--
           +-Yes-'-----<<
```

## Parameters

- No  
If you specify No, the ACL data is backed up. This is the default.
- Yes

If you specify Yes, the ACL data is not backed up, and consequently, it cannot be restored. skipacl=yes overrides skipaclupdatecheck settings.

## Examples

---

Options file:  
skipacl yes

AIX Linux Solaris Mac OS X

## Skipaclupdatecheck

---

The skipaclupdatecheck option disables checksum and size comparisons of ACL data.

When set to yes (default is no), the backup-archive client will not perform checksum and size comparisons before or after backup and during incremental processing (ACL checksum from previous backup and current ACL) to detect ACL updates. However, current ACL data is backed up if the file is selected for backup due to other reasons. If only ACLs are updated on a file, the next incremental backup will not recognize this ACL update, and the file is not backed up.

## Supported Clients

---

This option is valid for all UNIX and Linux clients.

## Options File

---

Place this option in the client user options (dsm.opt) file.

## Syntax

---

```
>>-SKIPACLUPdatecheck-+-No--+-+-----+-----<<
                        '-Yes-'
```

## Parameters

---

No

If you specify No, the client performs checksum and size comparisons of the ACL data, before and after backup and during incremental processing. This is the default.

Yes

If you specify Yes, the client does not perform checksum and size comparisons of the ACL data.

## Examples

---

Options file:  
skipaclup yes

Windows

## Skipmissingsyswfiles

---

Use the Skipmissingsyswfiles option to specify whether the backup-archive client skips certain missing VSS writer files and continues the system state backup.

Setting the skipmissingsyswfile option to yes causes certain VSS writer files that are not found during a system state backup to be skipped. This option is effective only for missing files from the following VSS writers:

- System Writer
- Windows Deployment Service Writer
- Event Log writer

Consider the following items before you use the skipmissingsyswfile option:

- Setting the skipmissingsyswfile option to yes enables backups that might have failed to complete with previous versions of the backup-archive client.
- There is a small risk of an inconsistent backup because a file is skipped.
- This risk is minimized by these factors:
  - The backup can be done only when the system is running.
  - Critical system files are protected from deletion by Microsoft Windows.

## Supported Clients

---

This option is valid for Windows clients.

## Options File

---

Place this option in the client options file (dsm.opt).

## Syntax

---

```
>>-SKIPMISSingsyswfiles--+-Yes-+-----<<
                          '-No--'
```

## Parameters

---

Yes

Specifies that you want the backup-archive client to skip certain files that are not found during system state backup. The files that are not found are logged to both the error log and the server activity log. The final return code is set to 8. This is the default.

No

Specifies that you want the backup-archive client to stop the backup when files are not found during system state backup. The files that are not found are logged to the error log and to the server activity log. The final return code is 12.

## Examples

---

Options file:

```
SKIPMISSingsyswfiles yes
```

Command line:

```
-SKIPMISSingsyswfiles=yes
```

**Related reference:**

Backup Systemstate

Windows

## Skipntpermissions

---

The skipntpermissions option bypasses processing of Windows file system security information.

You can use this option for incremental backups, selective backups, restore operations, and for archive and retrieve operations.

## Supported Clients

---

This option is valid for all Windows clients.

## Options File

---

Place this option in the client options file (dsm.opt). It applies to incremental, selective, restore, archive, and retrieve commands. You can also set this option on the General tab of the Preferences editor.

## Syntax

---

```
>>-SKIPNTPermissions-----><
      .-No--
      '-Yes-'
```

## Parameters

---

No

If you specify No, Windows file system security information is backed up, restored, archived, or retrieved. This is the default setting.

Yes

If you specify Yes, Windows file system security information is not backed up, restored, archived, or retrieved.

## Examples

---

Options file:

```
skipntp yes
```

Command line:

```
-skipntp=yes
```

Windows

## Skipntsecuritycrc

---

The skipntsecuritycrc option controls the computation of the security cyclic redundancy check (CRC) for a comparison of Windows NTFS or ReFS security information during an incremental or selective backup, archive, restore, or retrieve operation.

If you set the skipntsecuritycrc option to no (the default), performance might be slower because the program must retrieve all the security descriptors.

Use this option with the following commands:

- archive
- incremental
- restore
- retrieve
- selective

## Supported Clients

---

This option is valid for all Windows clients.

## Options File

---

Place this option in the client options file (dsm.opt).

## Syntax

---

```
>>-SKIPNTSecuritycrc-----><
      .-No--
      '-Yes-'
```

## Parameters

---

No

If you specify No, the security CRC is generated during a backup. This is the default setting.

Yes

If you specify Yes, the security CRC is not generated during a backup. All the permissions are backed up, but the program cannot determine if the permissions are changed during the next incremental backup. When the skipntpermissions option is set to yes, the skipntsecuritycrc option does not apply.

## Examples

---

Options file:  
skipnts no  
Command line:  
-skipnts=no

Windows

## Skipsystemexclude

---

Use the skipsystemexclude option to specify how to process exclude statements for certain operating system files that the IBM Spectrum Protect™ for Virtual Environments client skips by default.

By default, IBM Spectrum Protect for Virtual Environments clients skip certain Windows operating system files that are not normally required for system recovery during virtual machine (VM) backup operations. These files can include Windows system files, temporary internet files, and files in the Recycle Bin.

You can use this option to skip the processing of exclude statements for these operating system files. By not processing these exclude statements, the time it takes to back up VMs might be reduced.

## Support clients

---

This option is valid for IBM Spectrum Protect for Virtual Environments clients on Windows operating systems only.

## Options file

---

This option is valid in the client options file (dsm.opt) or on the command line. The option can be set in the client option set on the IBM Spectrum Protect server. The option is ignored for all other clients.

## Syntax

---

```
.-Yes-.  
>>-SKIPSYSTemexclude----->>  
'-No--'
```

## Parameters

---

Yes

Specify this parameter to skip the processing of exclude statements for certain Windows operating system files during VM backup operations. This parameter is the default.

No

Specify this parameter to process exclude statements of Windows operating system files. When you select this parameter and run a file backup of the Hyper-V host, the operating system files are excluded.

## Examples

---

Options file  
SKIPSYSTemexclude yes  
Command line  
dsmc backup vm -SKIPSYST=yes  
dsmc incr -skipsyst=no

Linux

Windows

## Snapdiff

---

Using the snapdiff option with the incremental command streamlines the incremental backup process. The command runs an incremental backup of the files that were reported as changed by NetApp instead of scanning all of the volume for changed files.

**Windows** The `snappdiff` (snapshot difference) option is for backing up NAS/N-Series file server volumes that are NFS or CIFS attached.

**Windows** Restriction: None of the NetApp predefined shares, including `C$`, works with the IBM Spectrum Protect™ snapshot difference option because the backup-archive client cannot determine their mount points programmatically.

You must configure a user ID and password on the backup-archive client to enable snapshot difference processing.

Use this option with an incremental backup of a NAS file server volume, instead of a simple incremental backup or an incremental backup with the `snapshotroot` option, whenever the NAS file server is running ONTAP 7.3.0, or later. Do not use the `snappdiff` and `snapshotroot` options together.

**Linux** Restriction: Incremental backups with snapshot difference processing are only available with the Linux `x86_64` backup-archive client.

The first time that you run an incremental backup with the snapshot difference option, a snapshot is created (the base snapshot) and a traditional incremental backup is run by using this snapshot as the source. The name of the snapshot that is created is recorded in the IBM Spectrum Protect server database. The initial incremental backup must complete without failure in order for the next backup operation to use snapshot difference processing.

The second time an incremental backup is run with this option, a newer snapshot is either created, or an existing one is used (depending on the value set for the `diffsnapshot` option) to find the differences between these two snapshots. The second snapshot is called the *diffsnapshot*, or differences snapshot. The client then incrementally backs up the files that are reported as changed, by NetApp, to the IBM Spectrum Protect server. The file system that you select for snapshot difference processing must be mounted to the root of the volume. You cannot use the `snappdiff` option for any file system that is not mounted to the root of the volume. After you backed up the data with the `snappdiff` option, the snapshot that was used as the base snapshot is deleted from the snapshot directory.

**Windows** On Windows systems, the snapshot directory is in `~snapshot`.

**Linux** On Linux systems, the snapshot directory is in `.snapshot`.

The client does not delete any snapshots that it did not create.

When a snapshot-differential-incremental backup operation completes, the client ensures that only the most recently-registered base snapshot persists on the filer volume. All snapshots that are created by a snapshot-differential-incremental backup on the backup-archive client begin with the characters "TSM\_". If you use a snapshot tool other than the backup-archive client to produce snapshots, ensure that you do not use the string "TSM\_" at the beginning of the snapshot name. If the snapshot names begin with "TSM\_", the files are deleted when the client initiates the next snapshot-differential-incremental backup operation.

To run a snapshot-differential-incremental backup of read-only NetApp filer volumes, the `useexistingbase` option must be specified to prevent an attempt to create a snapshot on the read-only volume. Also, specify the name of the base snapshot to use (`basesnapshotname` option) and the name of the differential snapshot to use (`diffsnapshotname` option).

For NAS and N-Series file servers that are running ONTAP 7.3.0, or later, you can use the `createnewbase` option to back up any files that were skipped because of one of the following reasons:

- A file is excluded because the include-exclude file has an exclude rule in effect. A file is excluded when you did not change the include-exclude file, but you removed the rule that excluded the file. The NetApp API detects file changes only between two snapshots, not changes to the include-exclude file.
- If you added an include statement to the option file, that include option does not take effect unless NetApp detects that the file changes occurred. The client does not inspect each file on the volume during backup.
- You used the `dsmc delete backup` command to explicitly delete a file from the IBM Spectrum Protect server inventory. NetApp does not detect that a file was manually deleted from the server. Therefore, the file remains unprotected in IBM Spectrum Protect storage until it is changed on the volume and the change is detected by NetApp, signaling the client to back it up again.
- Policy changes such as changing the policy from `mode=modified` to `mode=absolute` are not detected.
- The entire file space is deleted from the IBM Spectrum Protect inventory. This action causes the snapshot difference option to create a snapshot to use as the source, and runs a full incremental backup.
- A file is excluded from backup because the file name contains a character that is not in the 7 bit-ASCII character set. The `createnewbase` option creates a base snapshot and uses it as a source to run a full incremental backup. NetApp controls what constitutes a changed object.

Tip: You can use the `snappdiffhttps` option to run snapshot-differential-incremental backups of NetApp filers with a secure HTTPS connection. To successfully run snapshot-differential-incremental backups, previous releases of the backup-archive client

required HTTP administrative access to be enabled on the NetApp filer. With the `snapdiffhttps` option, you can establish a secure administrative session with the NetApp filer regardless of whether HTTP administrative access is enabled on the filer. In the list of options that are used by the traditional incremental command, the last column shows the interaction of each option with the `snapdiff` option. The following information describes the definitions of *valid*, *not valid*, and *no effect*:

Valid

Processing runs normally when the option is used.

Not valid

If the option is used with the `snapdiff` option, an error message is generated.

No effect

The option can be used, but it is ignored.

Table 1. Incremental command: Related options

Option	Where specified	With <code>snapdiff</code>
AIX Linux <code>asnodename</code>	AIX Linux Client system options file ( <code>dsm.sys</code> ) or command line.	AIX Linux Valid
Windows <code>asnodename</code>	Windows Client options file ( <code>dsm.opt</code> ) or command line.	Windows Valid
AIX Linux <code>automount</code>	AIX Linux Client options file ( <code>dsm.opt</code> ).	AIX Linux No effect
Windows <code>autofsrename</code>	Windows Client options file ( <code>dsm.opt</code> ) only.	Windows No effect
AIX Linux <code>basesnapshotname</code>	AIX Linux Client options file ( <code>dsm.opt</code> ) or command line.	AIX Linux Valid
Windows <code>basesnapshotname</code>	Windows Client options file ( <code>dsm.opt</code> ) or command line.	Windows Valid
AIX Linux <code>changingretries</code>	AIX Linux Client system options file ( <code>dsm.sys</code> ) or command line.	AIX Linux No effect
Windows <code>changingretries</code>	Windows Client options file ( <code>dsm.opt</code> ) or command line.	Windows No effect
Windows <code>compressalways</code>	Windows Client options file ( <code>dsm.opt</code> ) or command line.	Windows Valid
AIX Linux <code>compressalways</code>	AIX Linux Client options file ( <code>dsm.opt</code> ) or command line.	AIX Linux Valid
Windows <code>compression</code>	Windows Client options file ( <code>dsm.opt</code> ) or command line.	Windows Valid
AIX Linux <code>compression</code>	AIX Linux Client system options file ( <code>dsm.sys</code> ) within a server stanza, or command line.	AIX Linux Valid
AIX Linux Windows <code>createnewbase</code>	AIX Linux Windows Command line only.	AIX Linux Windows Valid
<code>diffsnapshot</code>	Command line only.	Valid
AIX Linux <code>diffsnapshotname</code>	AIX Linux Client options file ( <code>dsm.opt</code> ) or command line.	AIX Linux Valid
Windows <code>diffsnapshotname</code>	Windows Client options file ( <code>dsm.opt</code> ) or command line.	Windows Valid
<code>dironly</code>	Command line only.	Valid
Windows <code>domain</code>	Windows Client options file ( <code>dsm.opt</code> ) or command line only.	Windows Valid
AIX Linux <code>domain</code>	AIX Linux Client system options file ( <code>dsm.sys</code> ), client user-options file ( <code>dsm.opt</code> ), or command line.	AIX Linux Valid



Option	Where specified	With snapdiff
<b>AIX</b>   <b>Linux</b> efsdecrypt	<b>AIX</b>   <b>Linux</b> Client system options file (dsm.sys), client user-options file (dsm.opt), or command line.	<b>AIX</b>   <b>Linux</b> No effect
<b>AIX</b>   <b>Linux</b> enablelanfree	<b>AIX</b>   <b>Linux</b> Client system options file (dsm.sys) or command line.	<b>AIX</b>   <b>Linux</b> Valid
<b>Windows</b> enablelanfree	<b>Windows</b> Client options file (dsm.opt) or command line.	<b>Windows</b> Valid
<b>AIX</b>   <b>Linux</b> encryptiontype	<b>AIX</b>   <b>Linux</b> system-options file (dsm.sys) within a server stanza.	<b>AIX</b>   <b>Linux</b> Valid
<b>Windows</b> encryptiontype	<b>Windows</b> Client options file (dsm.opt).	<b>Windows</b> Valid
<b>Windows</b> encryptkey	<b>Windows</b> Client options file (dsm.opt).	<b>Windows</b> Valid
<b>AIX</b>   <b>Linux</b> encryptkey	<b>AIX</b>   <b>Linux</b> System-options file (dsm.sys) within a server stanza.	<b>AIX</b>   <b>Linux</b> Valid
<b>AIX</b>   <b>Linux</b> exclude.fs.nas	<b>AIX</b>   <b>Linux</b> Client system options file (dsm.sys).	<b>AIX</b>   <b>Linux</b> No effect
<b>Windows</b> exclude.fs.nas	<b>Windows</b> Client options file (dsm.opt).	<b>Windows</b> No effect
filelist	Command line only.	Not valid
filesonly	Command line only.	Valid
<b>AIX</b>   <b>Linux</b> followsymboliclink	<b>AIX</b>   <b>Linux</b> Client options file (dsm.opt).	<b>AIX</b>   <b>Linux</b> No effect
<b>AIX</b>   <b>Linux</b> include.fs.nas	<b>AIX</b>   <b>Linux</b> Client system options file (dsm.sys) or command line.	<b>AIX</b>   <b>Linux</b> No effect
<b>Windows</b> include.fs.nas	<b>Windows</b> Client options file (dsm.opt) or command line.	<b>Windows</b> No effect
<b>AIX</b>   <b>Linux</b> inclexcl	<b>AIX</b>   <b>Linux</b> Client system options file (dsm.sys).	<b>AIX</b>   <b>Linux</b> Valid, but only when a file change is detected by NetApp.
<b>Windows</b> inclexcl	<b>Windows</b> Client options file (dsm.opt).	<b>Windows</b> Valid, but only when a file change is detected by NetApp.
incrbydate	Command line only.	Not valid
<b>Windows</b> memoryefficientbackup	<b>Windows</b> Client options file (dsm.opt), server, or command line.	<b>Windows</b> No effect
<b>AIX</b>   <b>Linux</b> memoryefficientbackup	<b>AIX</b>   <b>Linux</b> This option is allowed in both dsm.sys and dsm.opt, but the value in dsm.opt is ignored if it is also in dsm.sys. You can also place this option within a server stanza, or on the initial command line.	<b>AIX</b>   <b>Linux</b> No effect
monitor	Command line only.	Not valid
<b>AIX</b>   <b>Linux</b> nojournal	<b>AIX</b>   <b>Linux</b> Command line only.	<b>AIX</b>   <b>Linux</b> Not valid
<b>Windows</b> nojournal	<b>Windows</b> Command line only.	<b>Windows</b> Not valid
<b>AIX</b>   <b>Linux</b> postsnapshotcmd	<b>AIX</b>   <b>Linux</b> Client system options file (dsm.sys) or with the include.fs option.	<b>AIX</b>   <b>Linux</b> Valid

Option	Where specified	With snapdiff
<b>Windows</b> postsnapshotcmd	<b>Windows</b> Client options file (dsm.opt) or with the include.fs option.	<b>Windows</b> Valid
<b>AIX</b> <b>Linux</b> preservelastaccessdate	<b>AIX</b> <b>Linux</b> Client user-options file (dsm.opt) or command line.	<b>AIX</b> <b>Linux</b> Valid
<b>Windows</b> preservelastaccessdate	<b>Windows</b> Client options file (dsm.opt) or command line.	<b>Windows</b> Valid
<b>AIX</b> <b>Linux</b> presnapshotcmd	<b>AIX</b> <b>Linux</b> Client system options file (dsm.sys) or with the include.fs option.	<b>AIX</b> <b>Linux</b> Valid
<b>Windows</b> presnapshotcmd	<b>Windows</b> Client options file (dsm.opt) or with the include.fs option.	<b>Windows</b> Valid
<b>AIX</b> <b>Linux</b> removeoperandlimit	<b>AIX</b> <b>Linux</b> Command line only.	<b>AIX</b> <b>Linux</b> Valid
<b>Windows</b> resetarchiveattribute	<b>Windows</b> Client options file (dsm.opt).	<b>Windows</b> Valid
<b>AIX</b> <b>Linux</b> skipaclupdatecheck	<b>AIX</b> <b>Linux</b> Client options file (dsm.opt).	<b>AIX</b> <b>Linux</b> Valid
<b>Windows</b> skipntpermissions	<b>Windows</b> Client options file (dsm.opt) or command line.	<b>Windows</b> Valid
<b>Windows</b> skipntsecuritycrc	<b>Windows</b> Client options file (dsm.opt) or command line.	<b>Windows</b> Valid
<b>AIX</b> <b>Linux</b> <b>Windows</b> snapdiffhttps	<b>AIX</b> <b>Linux</b> <b>Windows</b> Command line only.	<b>AIX</b> <b>Linux</b> <b>Windows</b> Valid
<b>AIX</b> <b>Linux</b> snapshotcachesize	<b>AIX</b> <b>Linux</b> Client system options file (dsm.sys) or with the include.fs option.	<b>AIX</b> <b>Linux</b> No effect
<b>AIX</b> <b>Linux</b> snapshotproviderfs	<b>AIX</b> <b>Linux</b> System-options file (dsm.sys) within a server stanza or with the include.fs option.	<b>AIX</b> <b>Linux</b> Not valid
<b>Windows</b> snapshotproviderfs	<b>Windows</b> Client options file (dsm.opt) or with the include.fs option.	<b>Windows</b> Not valid
<b>AIX</b> <b>Linux</b> snapshotproviderimage	<b>AIX</b> <b>Linux</b> Client system options file (dsm.sys) or with the include.image option.	<b>AIX</b> <b>Linux</b> Not valid
<b>Windows</b> snapshotproviderimage	<b>Windows</b> Client options file (dsm.opt) or with the include.image option.	<b>Windows</b> Not valid
snapshotroot	Command line only.	Not valid
subdir	Client options file (dsm.opt) or command line.	Not valid
<b>AIX</b> <b>Linux</b> tapeprompt	<b>AIX</b> <b>Linux</b> Client options file (dsm.opt) or command line.	<b>AIX</b> <b>Linux</b> Valid
<b>Windows</b> tapeprompt	<b>Windows</b> Client options file (dsm.opt) or command line.	<b>Windows</b> Valid
<b>AIX</b> <b>Linux</b> toc	<b>AIX</b> <b>Linux</b> Command line only.	<b>AIX</b> <b>Linux</b> Not valid
<b>Windows</b> toc	<b>Windows</b> Command line only.	<b>Windows</b> Not valid
<b>AIX</b> <b>Linux</b> useexistingbase	<b>AIX</b> <b>Linux</b> Command line only.	<b>AIX</b> <b>Linux</b> Valid
<b>Windows</b> useexistingbase	<b>Windows</b> Command line only.	<b>Windows</b> Valid

Option	Where specified	With snapdiff
virtualfsname	Command line only.	Not valid
<b>AIX</b>   <b>Linux</b> virtualmountpoint	<b>AIX</b>   <b>Linux</b> Client system options file (dsm.sys).	<b>AIX</b>   <b>Linux</b> Not valid

## Supported Clients

**Windows** This option is valid for all Windows clients.

**Linux** This option is valid for Linux x86\_64 clients.

## Syntax

```
>>-SNAPDiff-----<<
```

## Parameters

There are no parameters for this option.

## Examples

**Linux** Command line:

**Linux** Perform a snapshot-differential-incremental backup of an NFS mounted file system /vol/vol1 hosted on the file server homestore.example.com, where /net/home1 is the mount point of /vol/vol1.

```
Linux incremental -snapdiff -diffsnapshot=latest /net/home1
```

**Windows** Command line:

**Windows** Perform a snapshot-differential-incremental backup from a snapshot that is taken of a network share //homestore.example.com/vol/vol1 mounted on drive H:, where homestore.example.com is a file server.

```
Windows incremental -snapdiff H:
```

**Windows** Perform a snapshot-differential-incremental backup from a snapshot that is taken of a network share //homestore.example.com/vol/vol1 mounted on drive H:, where homestore.example.com is a file server. The -diffsnapshot option value of LATEST means that the operation uses the latest snapshot (the active snapshot) for volume H:.

```
Windows incremental -snapdiff H: -diffsnapshot=latest
```

Command line:

Run a one-time full incremental backup after detecting that the NetApp server has migrated to a unicode-enabled file server from a server that did not support unicode file names. **AIX** | **Linux**

```
dsmc incremental -snapdiff -createnewbase=migrate /net/home1
```

**Windows**

```
dsmc incremental -snapdiff -createnewbase=migrate h:
```

Run a snapshot-differential-incremental backup after detecting that the NetApp server has migrated to a unicode-enabled file server from a server that did not support unicode file names. This command suppresses the warning message.

**AIX** | **Linux**

```
dsmc incremental -snapdiff -createnewbase=ign /net/home1
```

**Windows**

```
dsmc incremental -snapdiff -createnewbase=ign h:
```

Perform a full incremental backup because you made some include or exclude changes: **AIX** | **Linux**

```
dsmc incremental -snapdiff -createnewbase=yes /net/home1
```

**Windows**

```
dsmc incremental -snapdiff -createnewbase=yes h:
```

## Related concepts:

**Linux** Snapshot differential backup with an HTTPS connection

SnapMirror support for NetApp snapshot-assisted progressive incremental backup (snapdiff)

**Related tasks:**

Configuring NetApp and IBM Spectrum Protect for snapshot difference incremental backups

**Related reference:**

Snapdiffhttps

Basesnapshotname

Diffsnapshotname

Useexistingbase

Diffsnapshot

Set Password

Linux Windows

## Snapdiffchangelogdir

---

The `snapdiffchangelogdir` option defines the location where the client stores persistent change logs that are used for snapshot differential backup operations.

Important: If you previously used snapshot differential backups with a backup-archive client that is older than Version 8.1.2, the first snapshot differential backup that you run with the V8.1.2 or later client will be a full progressive incremental backup. To avoid this full progressive incremental backup, move the existing change log files from the old location specified by the `stagingdirectory` option to the new location specified by the `snapdiffchangelogdir` option before you run the first snapshot differential backup.

For example, run the following copy command:

Linux

```
cp -R /tmp/TSM/TsmSnapDiff /opt/tivoli/tsm/client/ba/TsmSnapDiff
```

Windows

```
xcopy C:\Users\Bob\AppData\Local\Temp\TSM\TsmSnapDiff  
"C:\Program Files\Tivoli\TSM\baclient\TsmSnapDiff" /s /y
```

The change log files have the following naming patterns:

Linux

```
.../TSM/TsmSnapDiff/.TsmSnapdiffChangeLogs/NetAppFiler/  
SnapdiffChangeLog__VolumeName__.tsmDB  
.../TSM/TsmSnapDiff/.TsmSnapdiffChangeLogs/NetAppFiler/  
SnapdiffChangeLog__VolumeName__.tsmDB.Lock
```

Windows

```
... \TSM\TsmSnapDiff\ .TsmSnapdiffChangeLogs\NetAppFiler\  
SnapdiffChangeLog__VolumeName__.tsmDB  
... \TSM\TsmSnapDiff\ .TsmSnapdiffChangeLogs\NetAppFiler\  
SnapdiffChangeLog__VolumeName__.tsmDB.Lock
```

where:

- *NetAppFiler* is the host name or IP address of the storage virtual machine (SVM) from the cluster management server or the 7-mode file server.
- *VolumeName* is the volume that you want to protect.

## Supported Clients

---

Linux

This option is valid for Linux x86\_64 clients. This option can also be defined on the server.

Windows

This option is valid for all Windows clients. This option can also be defined on the server.

## Options File

---

Linux

Place this option in the client options file (`dsm.opt`). When `snapdiffchangelogdir` is specified on the command line, it overrides the values that are specified in the options file. You can set this option on the General tab of the Preferences editor.

Windows

Place this option in the client options file (`dsm.opt`). When `snapdiffchangelogdir` is specified on the command line, it overrides the values that are specified in the options file. You can set this option on the General tab of the Preferences editor.

## Syntax

---

>>--SNAPDIFFCHANGELOGDir--path-----<<

## Parameters

---

### path

Specifies the directory path where the client stores persistent change logs for snapshot differential backup operations. If you do not specify the `snappdiffchangelogdir` option, the client uses the directory where the client is installed. The default installation directory is: **Linux**

```
/opt/tivoli/tsm/client/ba
```

#### **Windows**

```
C:\Program Files\Tivoli\TSM\baclient
```

The exact name of the change log file is in the following format: **Linux**

```
snappdiff_change_log_dir/TsmSnapDiff/.TsmSnapdiffChangeLogs/NetAppFiler/  
SnapdiffChangeLog__VolumeName__.tsmDB
```

#### **Windows**

```
snappdiff_change_log_dir\TsmSnapDiff\.TsmSnapdiffChangeLogs\NetAppFiler\  
SnapdiffChangeLog__VolumeName__.tsmDB
```

where:

- `snappdiff_change_log_dir` is the name of the directory for storing the snapshot differential change logs, as specified by the `snappdiffchangelogdir` option.
- `NetAppFiler` is the host name or IP address of the storage virtual machine (SVM) from the cluster management server or the 7-mode file server.
- `VolumeName` is the volume that you want to protect.

A lock file is also created to prevent the change log file from being updated by different snapshot differential backups that are running at the same time.

**Windows** In Uniform Naming Convention (UNC) format, the path must contain a drive letter. In the following UNC format example, the path contains the drive letter:

```
\\computer7\C$\tsmdata
```

## Examples

---

Options file:

```
Linux snappdiffchangelogdir /tmp/tsmdata
```

```
Windows snappdiffchangelogdir c:\tsmdata
```

Command line:

```
Linux -snappdiffchangelogd=/tmp/tsmdata
```

```
Windows -snappdiffchangelogd="c:\tsmdata"
```

### Related reference:

Diffsnapshot

Snappdiff

**Linux** | **Windows**

## Snappdiffhttps

---

Specify the `snappdiffhttps` option to use a secure HTTPS connection for communicating with a NetApp filer during a snapshot differential backup.

When you specify this option, the backup-archive client can establish a secure administrative session with the NetApp filer regardless of whether HTTP administrative access is enabled on the NetApp filer.

**Important:** The default communication protocol that the backup-archive client uses to establish the administrative session with the NetApp filer is HTTP. To use a secure HTTPS connection, you must specify the `snappdiffhttps` option whenever you run a snapshot differential backup.

Restrictions:

The following restrictions apply to snapshot differential backups with HTTPS:

- The HTTPS connection is used only to securely transmit data over the administrative session between the backup-archive client and the NetApp filer. The administrative session data includes information such as filer credentials, snapshot information, and file names and attributes that are generated by the snapshot differencing process. The HTTPS connection is not used to transmit normal file data that is accessed on the filer by the client through file sharing. The HTTPS connection also does not apply to normal file data transmitted by the client to the IBM Spectrum Protect™ server through the normal IBM Spectrum Protect client/server protocol.
- The snapdiffhttps option does not apply to vFilers because the HTTPS protocol is not supported on the NetApp vFiler.
- The snapdiffhttps option is available only by using the command-line interface. It is not available for use with the backup-archive client GUI.

## Supported Clients

---

**Windows** This option is valid for all Windows clients.

**Linux** This option is valid for Linux x86\_64 clients.

## Options File

---

This option is valid only on the command-line interface. You cannot enter it in a client options file.

## Syntax

---

```
>>-SNAPDIFFHTTPS-----<<
```

## Parameters

---

There are no parameters for this option.

## Examples

---

**Linux** Command line:

**Linux** Issue the following command on a Linux system, with an NFS mounted file system `/vol/vol1` hosted on the file server `homestore.example.com`, where `/net/home1` is the mount point of `/vol/vol1`.

```
dsmc incr /net/home1 -snapdiff -snapdiffhttps
```

**Windows** Command line:

**Windows** Issue the following command on a Windows system with a network share `\\netapp1\vol1`, where `netapp1` is a filer.

```
dsmc incr \\netapp1\vol1 -snapdiff -snapdiffhttps
```

**Windows** Command line:

**Windows** Issue the following command on a Windows system with a network share `\\netapp1.example.com\petevol` mounted on drive `v:`, where `netapp1.example.com` is a filer.

```
dsmc incr v: -snapdiff -snapdiffhttps
```

```
IBM Spectrum Protect
Command Line Backup-Archive Client Interface
  Client Version 8, Release 1, Level 0.0
  Client date/time: 12/09/2016 15:36:53
(c) Copyright by IBM Corporation and other(s) 1990, 2016. All Rights Reserved.
```

```
Node Name: THINKCENTRE
Session established with server BARKENSTEIN_SERVER1: Windows
  Server Version 8, Release 1, Level 0.0
  Server date/time: 12/09/2016 15:36:53  Last access: 12/09/2016 11:21:14
```

```
Incremental by snapshot difference of volume 'v:'
```

```
Connected to NetApp Filer netappl.example.com as user pete via HTTPS
NetApp Release 8.1.1RC1 7-Mode: Thu May 31 21:30:59 PDT 2012
Performing a Snapshot Differential Backup of volume
'\\netappl.example.com\petevol'
Creating Diff Snapshot.
Using Base Snapshot 'TSM_THIN5086B9441A1F8_PETEVOL' with timestamp 12/09/2016
15:36:53
Using Diff Snapshot 'TSM_THIN5086B9772AF8_PETEVOL' with timestamp 12/09/2016
15:37:44
Successful incremental backup of '\\netappl.example.com\petevol'
```

#### Related concepts:

- Linux** Snapshot differential backup with an HTTPS connection
- Windows** Snapshot differential backup with an HTTPS connection

#### Related reference:

Snapdiff

## Snapshotcachesize

---

Use the snapshotcachesize option to specify an appropriate size to create the snapshot.

**AIX** | **Linux** The size estimation is needed for storing the original data blocks for modified and deleted data for the point in time when the snapshot was taken.

**AIX** | **Linux** For snapshot-based file backup or archive, use the snapshotcachesize option with the include.fs option, or in the server stanza in the dsm.sys file.

**AIX** | **Linux** For snapshot-based image backups, use the snapshotcachesize option with the backup image command, the include.image option, or in your dsm.sys file.

## Supported Clients

---

**AIX** | **Linux** This option is valid for AIX® and Linux clients *only*. The IBM Spectrum Protect™ API does not support this option. The server can also define this option.

## Options File

---

**AIX** | **Linux** Place this option in the server stanza in the dsm.sys file. You can set this option on the Image-Snapshot tab of the Preferences editor.

## Syntax

---

```
>>-SNAPSHOTCACHESize-- --size----->>
```

## Parameters

---

**AIX** | **Linux**

size

Specifies an appropriate size to create the snapshot for storing the original data blocks for modified and deleted data for the point in time when the snapshot was taken. The value is the percent of the file system size that is changed due to file system activity. The range of values is 1 to 100 percent. For AIX JFS2 and Linux the default value is 100 percent of the file system size. If a sufficient amount of free space is not available to create the snapshot, the command fails with an error message. You can then either increase the size of the volume group or retry the operation. If based on your experience with your AIX JFS2 file system activity, you find that a snapshot size of 100 percent is not necessary, you can fine-tune the value.

**AIX** | **Linux**

## Examples

---

Options file:

```

snapshotcachesize 95
AIX AIX only: include.fs /kalafs1
snapshotproviderfs=JFS2 snapshotcachesize=95
AIX AIX only: include.image /kalafs2
snapshotcachesize=95
Linux Linux only: include.image /linuxfs1
snapshotcachesize=100

```

Command line:

```
-snapshotcachesize=95
```

**AIX** | **Windows**

## Snapshotproviderfs

Use the `snapshotproviderfs` option to enable snapshot-based file backup and archive operations, and to specify a snapshot provider.

**AIX** You must be a root user to perform a snapshot-based file backup or archive operation. If you are not a root user, the operation fails with an error message.

**AIX** | **Windows**

## Supported Clients

**AIX** This option is valid for AIX® clients only. The IBM Spectrum Protect™ API does not support this option. The server can also define this option.

**Windows** This option is valid for all Windows clients. The IBM Spectrum Protect API does not support this option. The server can also define this option.

## Options File

**AIX** Specify this option in the server stanza of the system-options file, `dsm.sys`, to enable snapshots for all JFS2 file systems on the client. You can override the client-wide option for a specific operation by specifying this option on the command line for the backup and archive commands. You can also override the client-wide option for a specific file system by using the `include.fs` statement in the `dsm.sys` file. You can also set this option using the Preferences editor.

**Windows** Specify this option in the client options file, `dsm.opt`, to enable snapshots. You can override the client-wide option for a specific operation by specifying this option on the command line for the backup and archive commands. You can also override the client-wide option for a specific file system by using the `include.fs` statement in the `dsm.opt` file. You can also set this option using the Preferences editor.

## Syntax

```
>>-SNAPSHOTPROVIDERFS-- --value-----<<
```

## Parameters

value

Specifies one of the following values:

**AIX** JFS2

**AIX** Specifies that you want to perform a snapshot-based file backup or archive while the file system is available to other system applications. Valid for JFS2 file systems on AIX clients *only*.

**Windows** VSS

**Windows** Specifies that VSS should be used to provide OFS support.

**AIX** NONE

**AIX** Specifies that no snapshots should be used. A file backup or archive operation is performed using the specified file system. This is the default.

**Windows** NONE

**Windows** Specifies that no snapshot provider should be used; OFS support is turned off. This is the default.



## Examples

---

**AIX** Options file:

```
AIX  
snapshotproviderfs JFS2  
include.fs /kalafs1 snapshotproviderfs=JFS
```

**Windows** Options file:

```
Windows  
snapshotproviderfs VSS  
include.fs d: snapshotproviderfs=vss
```

**AIX** Command line:

```
AIX -SNAPSHOTPROVIDERFS=JFS2
```

**Windows** Command line:

```
Windows -SNAPSHOTPROVIDERFS=VSS
```

**AIX** | **Linux** | **Windows**

## Snapshotproviderimage

---

Use the `snapshotproviderimage` option to enable snapshot-based image backup, and to specify a snapshot provider.

**AIX** | **Linux** You must be a root user to perform a snapshot-based image backup operation. If you are not a root user, the operation fails with an error message.

**AIX** | **Linux** | **Windows**

## Supported Clients

---

**AIX** | **Linux** This option is valid for AIX® and Linux clients only. The IBM Spectrum Protect™ API does not support this option. The server can also define this option.

**Windows** This option is valid for all Windows clients. The IBM Spectrum Protect API does not support this option. The server can also define this option.

## Options File

---

**AIX** | **Linux** Specify this option in the server stanza of the system-options file, `dsm.sys`, to enable snapshots for all the file systems on the client. You can override the client-wide option for a specific operation by specifying this option on the command line for the backup image command. You can also override the client-wide option for a specific file system using the `include.image` statement in the `dsm.sys` file. You can also set this option using the Preferences editor.

**Windows** Specify this option in the client options file, `dsm.opt`, to enable snapshots for all the file systems on the client. You can override the client-wide option for a specific operation by specifying this option on the command line for the backup image command. You can also override the client-wide option for a specific file system using the `include.image` statement in the `dsm.opt` file. You can also set this option using the Preferences editor.

## Syntax

---

```
>>-SNAPSHOTPROVIDERImage-- --value-----<<
```

## Parameters

---

value

Specifies one of the following values:

**AIX** JFS2

**AIX** Specifies that you want to perform a snapshot-based image backup while the file system is available to other system applications. This is the default for JFS2 file systems. Valid for AIX clients *only*.

**Linux** LINUX\_LVM

**Linux** Specifies that you want to perform a snapshot-based image backup while the file system is available to other system applications. This is the default for file systems residing on logical volumes created by the Linux Logical Volume Manager. Valid for Linux clients *only*.

**Windows** VSS

**Windows** Specifies that the VSS should be used to provide online image support.

**AIX** | **Linux** NONE

**AIX** | **Linux** Specifies that you do not want to perform a snapshot-based image backup operation. This performs a static image backup operation using the specified file system. This is the default for file systems other than AIX JFS2 and Linux LVM.

**Windows** NONE

**Windows** Specifies that no snapshot provider should be used. This turns off online image support. This is the default

## Examples

**AIX** | **Linux** Options file:

**AIX** | **Linux**

```
snapshotprovideri JFS2
include.image /kalafsl snapshotprovideri=JFS2
```

**Windows** Options file:

**Windows**

```
snapshotprovideri VSS
include.image d: snapshotprovideri=vss
```

Command line:

```
-SNAPSHOTPROVIDERImage=NONE
```

**AIX** | **Linux** | **Solaris** | **Windows**

## Snapshotroot

Use the snapshotroot option with the incremental, selective, or archive commands with an independent software vendor application that provides a snapshot of a logical volume, to associate the data on the local snapshot with the real file space data that is stored on the IBM Spectrum Protect™ server.

**AIX** | **Linux** | **Solaris**

The snapshotroot option can be used to back up NFS mounted file systems. Both the backup specification (source) and the snapshotroot value can be an NFS mounted file specification. For example, the snapshotroot option can be used to backup an NFS file system that is hosted on a network-attached storage (NAS) that supports snapshot.

**AIX** | **Linux** | **Solaris** | **Windows**

This option should be used with an incremental backup of a NAS file server volume instead of a simple incremental or incremental with snapshotroot option whenever the NAS file server is running ONTAP V7.3 for performance reasons. The snapdiff and snapshotroot options should not be used together.

**Windows**

The snapshotroot option can be used to back up network share mounted file systems. Both the backup specification (source) and the snapshotroot value can be a network share mounted file specification. For example, the snapshotroot option can be used to back up a network share file system hosted on a network-attached storage (NAS) that supports snapshot.

**AIX** | **Linux** | **Solaris**

In the following example, filesystem test495 is NFS-mounted from a NAS file server philo and /philo/test945/.snapshot/backupsnap represents the snapshot that is created at the NAS file server.

**Windows**

In the following example, c:\snapshots\snapshot.0 is network share that is mounted from a NAS file server and \\florance\c\$ represents the snapshot that is created at the NAS file server.

**Windows**

```
dsmc incr \\florance\C$ -snapshotroot=c:\shapshots
\snapshot.0
```

**AIX** | **Linux** | **Solaris** | **Windows**

You can also specify a directory with the snapshotroot option when you backup each file set as a separate file space.

The snapshotroot option does not provide any facilities to take a volume snapshot, only to manage data that is created by a volume snapshot.

**AIX** **Linux** **Solaris** For example, consider an application that takes a snapshot of the `/usr` file system and mounts it as `/snapshot/day1`. If you back up this data by using the following command, a unique file space that is called `/snapshot/day1` is created on the server.

```
dsmc incremental /snapshot/day1
```

**AIX** **Linux** **Solaris** However, you might want to associate the snapshot data with the data already processed for the `/usr` file system. Using the `snapshotroot` option, you can associate the data with the file space corresponding to the `/usr` file system on the IBM Spectrum Protect server:

```
dsmc incremental /usr -snapshotroot=/snapshot/day1
```

**Windows** For example, consider an application that takes a snapshot of the `c:` drive and mounts it as the NTFS junction point `\\florence\c$\snapshots\snapshot.0`. If you back up this data by using the following command, a unique file space that is called `\\florence\c$\snapshots\snapshot.0` is created on the server.

```
dsmc incremental \\florence\c$\snapshots\snapshot.0
```

**Windows** However, you might want to associate the snapshot data with the data already processed for the `c:` drive (`\\florence\c$`). Using the `snapshotroot` option, you can associate the data with the file space corresponding to the `c:` drive (`\\florence\c$`) on the IBM Spectrum Protect server:

```
dsmc incr c: -snapshotroot=\\florence\c$\snapshots\snapshot.0
-or-
dsmc incr \\florence\c$ -snapshotroot=\\florence\c$\snapshots\
snapshot.0
```

On a subsequent day, you can back up a snapshot that was written to an alternative location, but managed under the same file space on the server:

```
dsmc incremental /usr -snapshotroot=/snapshot/day2
```

**Windows**

```
dsmc incr c: -snapshotroot=\\florence\c$\snapshots\snapshot.1
```

You can perform incremental backups, selective backups, or archives of a single directory, directory structure, or single file by using the `snapshotroot` option. In all instances, the `snapshotroot` option must identify the root of the logical volume that was created by the snapshot. For example:

```
dsmc incremental /usr/dir1/* -subdir=yes
-snapshotroot=/snapshot/day1
dsmc selective /usr/dir1/sub1/file.txt
-snapshotroot=/snapshot/day1
dsmc archive /usr/dir1/sub1/*.txt
-snapshotroot=/snapshot/day1
```

**Windows**

```
dsmc incr c:\dir1* -subdir=yes -snapshotroot=\\florence\c$\
snapshots\snapshot.1
dsmc sel c:\dir1\sub1\file.txt -snapshotroot=\\florence\c$\
snapshots\snapshot.1
dsmc archive c:\mydocs\*.doc -snapshotroot=\\florence\c$\
snapshots\snapshot.1
```

**AIX** **Linux** **Solaris** If you want to include or exclude specific file specifications, the include and exclude statements should contain the name of the file system that was the source of the snapshot (the `/usr` file system), and not the name of the target of the snapshot (`/snapshot/day1`). Doing this allows you to preserve a set of include and exclude statements regardless of the name of the logical volume to which the snapshot is written. The following are examples of include and exclude statements.

```
include /usr/dir1/*.txt lyrmgmtclass
exclude /usr/mydocs/*.txt
```

**Windows** If you want to include or exclude specific file specifications, the include and exclude statements should contain the name of the file system that was the source of the snapshot (the `c:` drive), and not the name of the target of the snapshot (`\\florence\c$\snapshots\snapshot.1`). Doing this allows you to preserve a set of include and exclude statements regardless of the name of the logical volume to which the snapshot is written. The following are examples of include and exclude statements.

```
include c:\dir1\...\*.txt lyrmgmtclass
exclude \\florence\c$\mydocs\*.doc
```

The following include-exclude statements are not valid because they contain the name of the snapshot:

AIX Linux

Solaris

```
include /snapshot/day1/dir1/*.txt lyrmgmtclass
exclude /snapshot/day1/mydocs/*.txt
```

Windows

```
include \\florence\c$\snapshots\snapshot.1\dir1\...\
*.txt lyrmgmtclass
exclude \\florence\c$\mydocs\*.doc
```

You must use the snapshotroot option with a single file specification for an incremental, selective, or archive operation. You cannot specify multiple file specifications or no file specifications. For example, these commands are valid:

AIX Linux

Solaris

```
dsmc incremental /usr -snapshotroot=/snapshot/day1
dsmc incremental /usr/dir1/* -snapshotroot=/snapshot/day1
```

Windows

```
dsmc incr c: -snapshotroot=\\florence\c$\snapshots\snapshot.0
dsmc incr c:\dir1\* -snapshotroot=\\florence\c$\snapshots\
snapshot.0
```

The following command is invalid because it contains two file specifications:

AIX Linux Solaris

```
dsmc incremental /usr/dir1/* /home/dir2/*
-snapshotroot=/snapshot/day1
```

Windows

```
dsmc incr c:\dir1\* e:\dir1\* -snapshotroot=\\florence\c$\
snapshots\snapshot.0
```

The following command is invalid because it contains no file specification:

AIX Linux Solaris

```
dsmc incremental -snapshotroot=/snapshot/day1
```

Windows

```
dsmc incr -snapshotroot=\\florence\c$\snapshots\snapshot.0
```

Notes:

1. Ensure that the snapshotroot option references a snapshot of the correct volume. Ensure that snapshotroot location refers to the root of the snapshot. If these rules are not followed, unintended results, such as files that expire incorrectly, can result.
2. If you specify the filelist option and the snapshotroot option, all files that are specified in the filelist option are assumed to be in the same file system. If there are entries in the filelist in a different file system, they are skipped and an error is logged. If the filelist contains files that were created in the file system after the snapshot was taken, these entries are also skipped, and an error is logged.
3. **Windows** You cannot use the snapshotroot option with any backup command, such as backup image, or backup systemstate, and so on.
4. **Linux Windows** You cannot use the snapshotroot option with the snapdiff option.
5. **Windows** Use the snapshotroot option with caution if you are using the IBM Spectrum Protect journal-based backup feature. Since there is no coordination between the IBM Spectrum Protect journal and the vendor-acquired snapshot provider (VSS), unwanted behavior can occur with journal notifications received after the snapshot occurs. For example, files might not be backed up, or they might be backed up redundantly to the IBM Spectrum Protect server.
6. You can use the snapshotroot option with the preschedulecmd and postschedulecmd options, or in an automated script that you run with the client scheduler.

## Supported Clients

This option is valid for the following clients:

- **AIX Linux Solaris** UNIX and Linux clients except Mac OS X.
- **Windows** All Windows clients.

## Syntax

---

```
>>-SNAPSHOTRoot = - --snapshot_volume_name-----<<
```

## Parameters

---

snapshot\_volume\_name

Specifies the root of the logical volume that is created by the independent software vendor snapshot application.

## Examples

---

```
AIX Linux Solaris Command line:
AIX Linux Solaris dsmc incremental /usr -SNAPSHOTRoot=/snapshot/day1
Windows Command line:
Windows dsmc incr c: -SNAPSHOTRoot=\\florence\c$\snapshots\snapshot.0
```

## Srvoptsetencryptiondisabled

---

The `srvoptsetencryptiondisabled` option allows the client to ignore encryption options in a client options set from the IBM Spectrum Protect™ server.

If the option is set to `yes` in the client options file, the client ignores the following options in a client options set from the server:

- `encryptkey generate`
- `exclude.encrypt`
- `include.encrypt`

## Supported Clients

---

This option is valid for all clients. The IBM Spectrum Protect API does not support this option.

## Options File

---

```
Windows Place this option in the client options file (dsm.opt).
```

```
AIX Linux Solaris Mac OS X Place this option in the client options file (dsm.sys) within a server stanza.
```

## Syntax

---

```
>>-SRVOPTSETENCryptiondisabled--+-no--
                               +-----+
                               '-yes-'<<
```

## Parameters

---

yes

The backup-archive client ignores the values of the listed encryption options in a client options set from the IBM Spectrum Protect server.

no

The backup-archive client processes the setting of the listed encryption options in a client options set from the IBM Spectrum Protect server. This is the default.

## Examples

---

```
Options file:
  srvoptsetencryptiondisabled no
Command line:
  Does not apply.
```

## Srvprepostscheddisabled

---

The `srvprepostscheddisabled` option specifies whether to prevent the pre-schedule and post-schedule commands specified by the IBM Spectrum Protect™ administrator from executing on the client system, when performing scheduled operations.

The `srvprepostscheddisabled` option can be used in conjunction with the `schedcmddisabled` and `srvprepostscheddisabled` options to disable the execution of any unwanted operating system command by the IBM Spectrum Protect administrator on a client node.

### Supported Clients

---

This option is valid for all backup-archive clients that use the IBM Spectrum Protect client scheduler. The server cannot define this option.

### Options File

---

**AIX** | **Linux** | **Mac OS X** | **Solaris** Place this option in the `dsm.sys` file within a server stanza for the scheduler. You can set this option on the Scheduler tab of the Preferences editor, in the Schedule Command section.

**Windows** Place this option in the client options file (`dsm.opt`) for the scheduler. You can set this option on the Scheduler tab of the Preferences editor, in the Schedule Command section.

### Syntax

---

```
>>-SRVPREPOSTScheddisabled--+-No-- .
                              |-----+----->>
                              '-Yes-'
```

### Parameters

---

**No**  
Specifies that the client allows pre-schedule and post-schedule commands defined by the IBM Spectrum Protect administrator to execute on the client system, when performing scheduled operations. If a pre-schedule or a post-schedule command is defined by both the client and the IBM Spectrum Protect administrator, the command defined by the administrator overrides the corresponding command defined in the client option file. This is the default.

**Yes**  
Specifies that the client prevents pre-schedule and post-schedule commands defined by the IBM Spectrum Protect administrator to execute on the client system, when performing scheduled operations. If a pre-schedule or a post-schedule command is defined by both the client and the IBM Spectrum Protect administrator, the command defined by the administrator will *not* override the corresponding command defined in the client option file. This option can be used in conjunction with the `schedcmddisabled` and `srvprepostscheddisabled` options.

### Examples

---

Options file:  
`srvprepostscheddisabled yes`  
Command line:  
Does not apply.

**Linux** | **Windows**

## Srvprepostsnapdisabled

---

The `srvprepostsnapdisabled` option specifies whether to prevent the pre-snapshot and post-snapshot commands specified by the IBM Spectrum Protect™ administrator from executing on the client system, when performing scheduled image snapshot backup operations.

The `srvprepostsnapdisabled` option can be used in conjunction with the `schedcmddisabled` and `srvprepostsnapdisabled` options to disable the execution of any unwanted operating system command by the IBM Spectrum Protect administrator on a client node.

### Supported Clients

---

**Linux** This option is valid for Linux clients that support the image snapshot backup command. The server cannot define this option. The IBM Spectrum Protect API does not support this option.

**Windows** This option is valid for Windows clients that support the image snapshot backup command. The server cannot define this option. The IBM Spectrum Protect API does not support this option.

## Options File

---

**Linux** Place this option in the `dsm.sys` file within a server stanza for the scheduler. You can set this option on the Snapshot tab of the Preferences editor, in the Snapshot Options section.

**Windows** Place this option in the client options file (`dsm.opt`) for the scheduler. You can set this option on the Snapshot tab of the Preferences editor, in the Snapshot Options section.

## Syntax

---

```
.-No--.  
>>-SRVPREPOSTSNAPdisabled-----><  
'-Yes-'
```

## Parameters

---

No

Specifies that client allows pre-snapshot and post-snapshot commands defined by the IBM Spectrum Protect administrator to execute on the client system, when performing scheduled image snapshot backup operations. If a pre-snapshot or a post-snapshot command is defined by both the client and the IBM Spectrum Protect administrator, the command defined by the administrator overrides the corresponding command defined in the client option file. This is the default.

Yes

Specifies that the client does not allow pre-snapshot and post-snapshot commands defined by the IBM Spectrum Protect administrator to execute on the client system, when performing scheduled image snapshot backup operations. If a pre-snapshot or a post-snapshot command is defined by both the client and the IBM Spectrum Protect administrator, the command defined by the administrator will *not* override the corresponding command defined in the client option file. This option can be used in conjunction with the `schedmddisabled` and `srvprepostsnapdisabled` options.

## Examples

---

Options file:

```
srvprepostsnapdisabled yes
```

Command line:

Does not apply.

## Ssl

---

Use the `ssl` option to enable Secure Sockets Layer (SSL) to provide secure client and server communications. When the backup-archive client communicates with an IBM Spectrum Protect™ server V8.1.1 and earlier V8 levels, and V7.1.7 and earlier levels, it determines whether SSL is enabled. When the backup-archive client communicates with an IBM Spectrum Protect server V8.1.2 and later, SSL is always used and this option controls whether object data is encrypted or not. For performance reasons, it might be desirable to not encrypt the object data.

## Supported Clients

---

This option is valid for all supported clients.

## Options File

---

**AIX** | **Linux** | **Mac OS X** | **Solaris** Place this option in the client system-options file (`dsm.sys`) within a server stanza. You can also set this option on the Communication tab of the Preferences editor.

**Windows** Place this option in the client options file (`dsm.opt`). You can also set this option on the Communication tab of the Preferences editor.

## Syntax

---

```
.-No--.  
>>-SSL--+-----><  
'-Yes-'
```

## Parameters for communicating with an IBM Spectrum Protect server V8.1.1 and earlier V8 levels, and V7.1.7 and earlier levels.

---

No

Specifies that the backup-archive client does not use SSL to encrypt information. No is the default.

Yes

Specifies that the backup-archive client uses SSL to encrypt information.

To enable SSL, specify SSL Yes and change the value of the TCPPOINT option. Changing the value of the TCPPOINT option is generally necessary because the IBM Spectrum Protect server is typically set up to listen for SSL connections on a separate port.

## Parameters for communicating with an IBM Spectrum Protect server V8.1.2 and later.

---

No

Specifies that the backup-archive client does not use SSL to encrypt object data when communicating with the server. All other information is encrypted. No is the default.

Yes

Specifies that the backup-archive client uses SSL to encrypt all information, including object data, when communicating with the server.

To use SSL for all data, specify SSL Yes.

## Examples

---

Options file:

```
ssl yes
```

Command line:

Does not apply.

## Sslacceptcertfromserv

---

Use the `sslacceptcertfromserv` option to control whether the backup-archive client or the API application accept and trust the IBM Spectrum Protect™ server's Secure Sockets Layer (SSL) public certificate the first time they connect. This option applies only the first time that the backup-archive client or the API application connects to the IBM Spectrum Protect server. When the SSL public certificate is accepted, future changes to the certificate are not automatically accepted, and must be manually imported to the backup-archive client. You can use this option to connect only to an IBM Spectrum Protect server V8.1.2 and later.

## Supported Clients

---

This option is valid for all supported clients.

## Options File

---

**AIX** | **Linux** | **Mac OS X** | **Solaris** Place this option in the client system-options file (`dsm.sys`) within a server stanza.

**Windows** Place this option in the client options file (`dsm.opt`).

## Syntax

---

```
.-Yes-.  
>>-SSLACCEPTCERTFROMSERV--+-----><
```



'-No--'

## Parameters

---

Yes

Specifies that the backup-archive client does automatically accept the IBM Spectrum Protect server's public certificate. Yes is the default.

No

Specifies that the backup-archive client does not automatically accept the IBM Spectrum Protect server's public certificate.

To disable SSLACCEPTCERTFROMSERV, specify sslacceptcertfromserv no.

## Examples

---

Options file:

```
sslacceptcertfromserv no
```

Command line:

Does not apply.

## Ssldisablelegacytls

---

Use the ssldisablelegacytls option to disallow the use of SSL protocols that are lower than TLS 1.2.

## Supported Clients

---

This option is valid for all supported clients.

## Options File

---

**AIX** | **Linux** | **Mac OS X** | **Solaris** Place this option in the dsm.sys file. You can also set this option in the GUI by selecting the Require TLS 1.2 or above check box on the Communication tab of the Preferences editor. You cannot set this option on the command line.

**Windows** Place this option in the client options (dsm.opt) file. You can also set this option in the GUI by selecting the Require TLS 1.2 or above check box on the Communication tab of the Preferences editor. You cannot set this option on the command line.

## Syntax

---

```
>>>SSLDISABLELEGACYtls----->>>
      .-No--.
      '-Yes-'
```

## Parameters

---

No

Specifies that the backup-archive client does not require TLS 1.2 for SSL sessions. It allows connection at TLS 1.1 and lower SSL protocols. When the backup-archive client communicates with an IBM Spectrum Protect™ server V8.1.1 and earlier V8 levels, and V7.1.7 and earlier levels, No is the default.

Yes

Specifies that the backup-archive client requires that all SSL sessions use TLS 1.2 (or higher) protocol. When the backup-archive client communicates with an IBM Spectrum Protect server V8.1.2 and later, Yes is the default.

## Examples

---

Options file:

```
ssldisablelegacytls yes
```

Command line:

Does not apply.

# Sslfipsmode

---

The `sslfipsmode` option specifies whether the client uses SSL Federal Information Processing Standards (FIPS) mode for Secure Sockets Layer (SSL) communications with the server. The default is no.

## Supported clients

---

This option is supported on all clients.

## Options File

---

Set this option in the client options file. You cannot specify it as a command-line parameter and you cannot set this option in a client options set.

## Syntax

---

```
>>-SSLFIPSMODE = .-No-- .  
                  +-----+-----+-----+-----+-----><  
                  '-Yes-'
```

## Parameters

---

- No**  
Specifies that the client does not use SSL FIPS mode for secure communications with the server. SSL in FIPS mode is supported only by version 6.3 and newer versions of the server. Set this client option to no if the client uses SSL to connect to a server that is not at V6.3, or newer.
- Yes**  
Specifies that the client uses SSL FIPS mode for secure communications with the server. Setting this option to yes restricts SSL session negotiation to use only FIPS-approved cipher suites. SSL FIPS mode is only supported by the V6.3 (or newer) server.

## Example

---

To enable SSL FIPS mode on the client:

```
SSLFIPSMODE yes
```

# Sslrequired

---

The `sslrequired` option specifies the conditions when SSL is or is not required when the client logs on to the IBM Spectrum Protect™ server or storage agents. To actually enable SSL so client-to-server and client-to-storage-agent communications are secure, you must set the client `ssl` option to yes. When communicating with the IBM Spectrum Protect server V8.1.2 and later, this option no longer applies since SSL is always used.

## Supported Clients

---

This option is supported on all clients.

## Options File

---

Place this option in the client options file or in the GUI, on the Communications tab. You cannot set this option on the command line.

## Syntax

---

```
>>-SSLREQuired- .-Default---- .  
                  +-----+-----+-----+-----+-----><  
                  +-Yes-----+
```

```
+-No-----+
'-SERVERonly-'
```

## Parameters

### Default

This setting indicates that SSL is required to secure communications between the client and server, and client and storage agents, if `AUTHENTICATION=LDAP` is set on the server. To secure communications by using SSL, you must also set `ssl=yes` on the client.

If `AUTHENTICATION=LOCAL` is set on the server, this setting indicates that SSL is not required. Even though SSL is not required when `AUTHENTICATION=LOCAL` and `sslrequired=default`, you can still use SSL by setting the client `ssl` option to `yes`.

### Yes

Indicates that SSL is always required to secure communications between the client and server, and between the client and storage agents. `sslrequired=yes` has no dependency on the server `AUTHENTICATION` option. If you set `sslrequired=yes` on the client, you must also set `ssl=yes` on the client.

### No

Indicates that you do not require SSL to be used to secure communications between the client and server or between the client and storage agents. Choose this option only if you use a virtual private network or other method to secure your session communications. You can still enable SSL by setting `ssl=yes` on the client; but `sslrequired=no` specifies that SSL is not a prerequisite.

### SERVERonly

Indicates that SSL is required for client-to-server communications and not for server-to-storage agent communications. To use SSL for client to server communications, set `sslrequired=serveronly` and `ssl=yes`. The server setting for the `AUTHENTICATION` option can be either `LOCAL` or `LDAP`.

For client to storage agent communications, use the client `lanfreessl` option to enable SSL.

The following table describes the situations under which authentication succeeds or fails, depending on the settings of the `SSLREQUIRED` option on the server, and client, and the setting of the `ssl` option on the client. The table results assume that valid credentials are supplied.

Table 1. Effects of server and client SSL settings on success or failure of login attempts

SSLREQUIRED option (server setting)	sslrequired option (client setting)	ssl option (client setting)	Authentication success or failure
Yes	Yes	Yes	Authentication succeeds
Yes	Yes	No	Authentication fails; the client rejects the session
Yes	No	Yes	Authentication succeeds
Yes	No	No	Authentication fails; the server rejects the session
No	Yes	Yes	Authentication succeeds
No	Yes	No	Authentication fails; the client rejects the session
No	No	Yes	Authentication succeeds
No	No	No	Authentication succeeds

The following text describes how setting `SSLREQUIRED=DEFAULT` and `SSLREQUIRED=SERVERONLY` on the server affects the `ssl` option on the client.

If the server sets `SSLREQUIRED=DEFAULT` and `AUTHENTICATION=LDAP`, the client must set `ssl=yes` or authentication fails.

If the server sets `SSLREQUIRED=DEFAULT` and `AUTHENTICATION=LOCAL`, the client can set `ssl=yes` or `ssl=no`.

If the server sets `SSLREQUIRED=SERVERONLY`, you must set `ssl=yes` on the client. The client `lanfreessl` option can be set to `yes`, to secure communications with a storage agent, or to `no` if secure communications with storage agents is not needed.

## Examples

Options file:

```
sslrequired yes
sslrequired no
sslrequired default
sslrequired serveronly
```

Command line:

Not applicable; you cannot set this option on the command line.

Linux Windows

## Stagingdirectory

---

The stagingdirectory option defines the location where the client stores any data that it generates to perform its operations. The data is deleted when processing is complete.

**Windows** The client uses the stagingdirectory location for Active Directory object query and restore operations. The client also uses the stagingdirectory location for temporary files when the client processes files that were migrated with IBM Spectrum Protect™ HSM for Windows.

**Important:** Starting with Version 8.1.2, the snapdiffchangelogdir option is used to specify the location to store change logs for snapshot differential backup operations. The stagingdirectory option is no longer used for this purpose. For more information, see Snapdiffchangelogdir.

## Supported Clients

---

**Linux** This option is valid for Linux clients. The server can also define this option.

**Windows** This option is valid for all Windows clients. The server can also define this option.

## Options File

---

**Linux** Place this option in the client options file (dsm.opt). When stagingdirectory is specified on the command line, it overrides the values that are specified in the options file.

**Windows** Place this option in the client options file (dsm.opt). When stagingdirectory is specified on the command line, it overrides the values that are specified in the options file.

## Syntax

---

```
>>-STAGINGDIrectory--path-----<<
```

## Parameters

---

path

**Linux** Specifies the directory path where the client writes staging data. If you do not specify a staging directory, the client stores temporary data in the temporary file system (typically /tmp).

**Windows** Specifies the directory path where the client writes staging data. If you do not specify a staging directory, the client checks for the existence of the USER environment variables in the following order, and uses the first path found:

1. The path that is specified by the TMP user variable.
2. The path that is specified by the TMP system variable.
3. The path that is specified by the TEMP user variable.
4. The path that is specified by the TEMP system variable.
5. The Windows system directory.

**Windows** In Uniform Naming Convention (UNC) format, the path must contain a drive letter. In the following UNC format example, the path contains the drive letter D\$:

```
\\computer7\D$\temp\tsmstaging
```

## Examples

---

Options file:

```
Linux stagingdirectory /usr/tsmdata
Linux stagingdirectory /private/tmp
Windows stagingdirectory c:\tsmdata
```

Command line:

```
Linux -stagingdir="/tmp/tsmtempdata"
Windows -stagingdir="e:\tsmdata"
```

**Related reference:**

**Windows** Query Adobjects

**Windows** Restore Adobjects

Diffsnapshot

Snapdiff

**Related information:**

<http://www.ibm.com/support/knowledgecenter/SSERBH>

## Subdir

---

The `subdir` option specifies whether you want to include subdirectories of named directories for processing.

You can use the `subdir` option with the following commands:

- archive
- delete archive
- delete backup
- **AIX** **Linux** **Solaris** **Mac OS X** **Windows** incremental
- query archive
- query backup
- restore
- restore backupset
- restore group
- retrieve
- selective

If you set the `subdir` option to `yes` when backing up a specific path and file, the backup-archive client recursively searches all of the subdirectories under that path, and looks for any instances of the specified file that exist under any of those subdirectories. For example, assume that a file called `myfile.txt` exists on a client in the following directories:

```
//myfile.txt
/dir1/myfile.txt
/dir1/dir_a/myfile.txt
/dir1/dir_b/myfile.txt
```

Performing a selective backup of that file, as follows, backs up all four instances of `myfile.txt`:

```
dsmc sel /myfile.txt -subdir=yes
```

Similarly, the following command displays all instances of `myfile.txt` if you specify `subdir=yes` in the client options file or in a client options set.

```
dsmc restore /myfile.txt -pick
```

## Supported Clients

---

This option is valid for all clients. The server can also define this option. The IBM Spectrum Protect™ API does not support this option.

## Options File

---

**Windows** Place this option in the client options file (`dsm.opt`).

**AIX** **Linux** **Solaris** **Mac OS X** Place this option in the client user-options file (`dsm.opt`).

## Syntax

---

```
      .-No--.
>>-Subdir--+-----+-----+-----+----->>
      '-Yes-'
```

## Parameters

---

No

Subdirectories are not processed. This is the default.

Yes

Subdirectories are processed. Because the client program searches all subdirectories of a directory that is being processed, processing can take longer to complete. Specify Yes only when necessary.

If you use the `preservepath` option in addition to `subdir=yes`, it can affect which subdirectories are processed.

**AIX** | **Linux** | **Solaris** | **Mac OS X** If a subdirectory is a mounted file system, it is not processed even if you specify `subdir=yes`.

Note:

1. When you run the client in interactive mode, and if you use the `-subdir=yes` option, the setting persists for all commands entered in interactive mode, until you end interactive mode, by typing `Quit`.
2. If `subdir=yes` is in effect when you restore multiple files, place a directory delimiter character at the end of the destination file specification. If the delimiter is omitted, the client displays a message indicating that the destination file specification is not valid.
3. It is a best practice to include only the default value for `subdir` (No) in a client options file or a client options set.

## Examples

---

Options file:

```
subdir no
```

Command line:

**Mac OS X** To restore the structure:

```
/Users/mike/dir1
/Users/mike/dir1/file1
/Users/mike/dir1/dir2
/Users/mike/dir1/dir2/file1
```

enter any of the following commands:

```
dsmc rest "/Users/van/dir1/*" /Users/mike/ -su=yes
dsmc rest "/Users/van/dir1/file*" /Users/mike/ -su=yes
dsmc rest "/Users/van/dir1/file1*" /Users/mike/ -su=yes
```

**AIX** | **Linux** | **Solaris** | **Mac OS X** To restore the structure:

```
/path2/dir1
/path2/dir1/file1
/path2/dir1/dir2
/path2/dir1/dir2/file1
```

enter any of the following commands:

```
dsmc rest "/path/dir1/*" /path2/ -su=yes
dsmc rest "/path/dir1/file*" /path2/ -su=yes
dsmc rest "/path/dir1/file1*" /path2/ -su=yes
```

**Windows** To restore the structure:

```
\path2\dir1
\path2\dir1\file1
\path2\dir1\dir2
\path2\dir1\dir2\file1
```

enter any of the following commands:

```
rest \path\dir1\* \path2\ -su=yes
rest \path\dir1\file* \path2\ -su=yes
```

```
rest \path\dir1\file1* \path2\ -su=yes
```

This option is valid on the initial command line and in interactive mode. If you use this option in interactive mode, it affects only the command with which it is specified. When that command completes, the value reverts to the value at the beginning of the interactive session. This is the value from the `dsm.opt` file unless overridden by the initial command line or by an option forced by the server.

Windows

## Systemstatebackupmethod

---

Use the `systemstatebackupmethod` option to specify which backup method to use to back up the system writer portion of the system state data. The method you select is used when you backup the system state data.

### Supported clients

---

This option is valid for Windows clients.

### Options file

---

Place this option in the client options file (`dsm.opt`). When specified in the `dsm.opt` file, the option affects system state backups created by `BACKUP SYSTEMSTATE` commands, and system state data backed up by `INCREMENTAL` commands. However, the only command that you can specify this option on is the `BACKUP SYSTEMSTATE` command.

### Schedule definitions

---

You can also specify this option on the options parameter of a schedule definition on schedules that have both `action=backup` and `subaction=systemstate` set. Defining an infrequent schedule with this option set to `FULL` ensures that you periodically perform a full backup of Windows system state data.

### Syntax

---

```
>>-SYSTEMSTATEBACKUPMethod--+-PROGressive---+-----><
                               +-OPPortunistic--+
                               '-FULL-----'
```

### Parameters

---

#### PROGressive

With the `PROGressive` method, the system writer portion of the system state data is backed up using the progressive incremental backup method. That is, if system writer files have not changed since the last system state backup, they are not included in this backup. Only the changed system writer files are backed up. This is the default system state backup method.

This type of system state backup uses the least network bandwidth and IBM Spectrum Protect™ server storage, but it increases the amount of server database processing required to keep track of the changes.

#### OPPortunistic

With the `OPPortunistic` method, if any system writer files have changed since the last system state backup, all system writer files are backed up.

This method, like the `PROGressive` method, also uses the least network bandwidth and IBM Spectrum Protect server storage if system writer files have not changed since the last system state backup. If any system writer files have changed since the last system state backup then the system writer is backed up in full, which uses more network bandwidth and server storage. With the `OPPortunistic` method, the amount of server database processing that occurs is less than that caused by the `PROGressive` method.

#### FULL

When FULL is specified, all system writer files are backed up, even if they have not changed since the last system state backup.

This type of system state backup uses the most network bandwidth and IBM Spectrum Protect server storage because all system writer files are backed up during each system state backup operation. However, this system state backup method causes little server database processing.

## Examples

---

Options file:

```
SYSTEMSTATEBACKUPMETHOD FULL
SYSTEMSTATEBACKUPMETHOD OPPORTUNISTIC
```

Command line:

```
backup systemstate -SYSTEMSTATEBACKUPMETHOD=FULL
```

## Tapeprompt

---

The `tapeprompt` option specifies whether you want the backup-archive client to wait for a tape mount if it is required for a backup, archive, restore, or retrieve process, or to be prompted for a choice.

In the backup-archive client GUI, the Media Mount dialog can display the `Information Not Available` value in the Device and Volume Label fields if you perform a standard (also known as classic) restore or retrieve operation. This value means that this information is only available for no-query restore or retrieve operations; not a standard restore or retrieve operation. The Device field displays the name of the device on which to mount the media needed to process an object. The Volume Label field displays the name of the volume needed to process an object.

Tape prompting does not occur during a scheduled operation regardless of the setting for the `tapeprompt` option.

The `tapeprompt` option can be used with the following commands:

- archive
- delete archive
- delete backup
- incremental
- restore
- retrieve
- selective

Note: The server can also define this option.

## Supported Clients

---

This option is valid for all clients.

## Options File

---

**AIX** | **Linux** | **Solaris** | **Mac OS X** Place this option in the client user-options file (`dsm.opt`). You can set this option on the General tab, Prompt before mounting tapes check box of the Preferences editor.

**Windows** Place this option in the client options file (`dsm.opt`). You can set this option on the General tab, Prompt before mounting tapes check box of the Preferences editor.

## Syntax

---

```
>>-TAPEprompt--+-No-->>
                  |-----+----->>
                  '-Yes-'
```

## Parameters

---

No

You are not prompted for your choice. The server waits for the appropriate tape to mount. This is the default.



Note: For API applications, this permits backup directly to tape.

Yes

You are prompted when a tape is required to back up, archive, restore, or retrieve data. At the prompt, you can wait for the appropriate tape to be mounted, always wait for a tape to be mounted, skip a particular object, skip all objects on a single tape, skip all objects on all tapes, or cancel the entire operation.

## Examples

---

```
Options file:
  tapeprompt yes
Command line:
  -tapep=yes
```

This option is valid only on the initial command line. It is not valid in interactive mode.

## Tcpadminport

---

Use the tcpadminport option to specify a separate TCP/IP port number on which the server waits for requests for administrative client sessions, allowing secure administrative sessions within a private network.

The client tcpadminport setting depends on how the IBM Spectrum Protect™ server tcpadminport and adminonclientport options are configured. The server has a tcpadminport setting that indicates on which port the server listens for administrative sessions, and the adminonclientport setting, which can be either yes or no.

If tcpadminport is not set on the server, then administrative sessions are allowed on the same port as client sessions.

If tcpadminport is set on the server, then administrative sessions are allowed on the port specified by that setting. In this case, if adminonclientport yes is in effect, then administrative sessions can connect on either the regular client port or the port specified by tcpadminport. If adminonclientport no is in effect, then administrative sessions can connect only on the port specified by tcpadminport.

## Supported Clients

---

This option is valid for all clients. The server can also define this option. The IBM Spectrum Protect API does not support this option.

## Options File

---

**AIX** | **Linux** | **Solaris** | **Mac OS X** Place this option in the dsm.sys file within a server stanza. You can set this option on the Communication tab, in the Admin Port field in the Preferences editor.

**Windows** Place this option in the client options file (dsm.opt). You can set this option on the Communication tab, in the Admin Port field in the Preferences editor.

## Syntax

---

```
>>-TCPADMINPort--+-----+----->>
      '-admin_port_address-'
```

## Parameters

---

admin\_port\_address  
Specifies the port number of the server. The default value is the value of the tcpport option.

## Examples

---

```
Options file:
  tcpadminport 1502
```

## Tcpbuffsize

---

The `tcpbuffsize` option specifies the size of the internal TCP/IP communication buffer used to transfer data between the client node and server. Although it uses more memory, a larger buffer can improve communication performance.

**AIX** | **Linux** | **Solaris** | **Mac OS X** | **Windows**

## Supported Clients

---

This option is valid for all clients.

## Options File

---

**AIX** | **Linux** | **Solaris** | **Mac OS X** Place this option in the client system-options file (`dsm.sys`) within a server stanza. You can set this option on the Communication tab, in the Buffer Size field in the Preferences editor.

**Windows** Place this option in the client options file (`dsm.opt`). You can set this option on the Communication tab, in the Buffer Size field in the Preferences editor.

## Syntax

---

```
>>-TCPBuffsize-- --size-----><
```

## Parameters

---

size

Specifies the size, in kilobytes, that you want to use for the internal TCP/IP communication buffer. The range of values is 1 through 512; the default is 32.

Depending on the operating system communication settings, your system might not accept all values in the range of 1 through 512.

## Examples

---

Options file:

```
tcpb 32
```

Command line:

```
-tcpbuffsize=32
```

This option is valid only on the initial command line. It is not valid in interactive mode.

## Tcpcadaddress

---

The `tcpcadaddress` option specifies a TCP/IP address for `dsmcad`. Normally, this option is not needed. Use this option only if your client node has more than one TCP/IP address, or if TCP/IP is not the default communication method.

## Supported Clients

---

This option is valid for all clients. The IBM Spectrum Protect™ API does not support this option.

## Options File

---

**Windows** Place this option in the client options file (`dsm.opt`).

**AIX** | **Linux** | **Solaris** | **Mac OS X** Place this option in the `dsm.sys` file within a server stanza.

## Syntax

---

```
>>-TCPCADAddress-- --cad_address-----><
```

## Parameters

---

AIX	Linux	Solaris	Mac OS X	Windows
-----	-------	---------	----------	---------

`cad_address`  

AIX	Linux	Solaris	Mac OS X	Windows
-----	-------	---------	----------	---------

 Specifies a TCP/IP Internet domain name or a numeric IP address. If you specify an IPv6 addresses, you must specify the commethod V6Tcip option.

## Examples

---

Options file:

```
tcpcada dsmclnt.example.com
```

Command line:

```
-tcpcadaddress=192.0.2.0
```

```
-tcpcadaddress=mycompany.example.com
```

AIX	Linux	Solaris	Mac OS X	Windows
-----	-------	---------	----------	---------

```
-tcpcadaddress=2001:0DB8:0:0:0:0:0:0
```

This option is valid only on the initial command line of the dsmcad program. It is not valid with other dsm modules.

## Tcpclientaddress

---

The tcpclientaddress option specifies a TCP/IP address if your client node has more than one address, and you want the server to contact an address other than the one that was used to make the first server contact.

The server uses this address when it begins the server prompted scheduled operation.

Use this option only if you use the prompted parameter with the schedmode option.

If sessioninitiation is set to serveronly, the value for the tcpclientaddress client option should be the same as the value for the HLAddress server setting.

## Supported Clients

---

This option is valid for all clients. The IBM Spectrum Protect™ API does not support this option.

## Options File

---

AIX	Linux	Solaris	Mac OS X
-----	-------	---------	----------

 Place this option in the dsm.sys file *within* a server stanza. You can set this option on the Scheduler tab, Your TCP/IP address field of the Preferences editor.

Windows
---------

 Place this option in the client options file (dsm.opt). You can set this option on the Scheduler tab, Your TCP/IP address field of the Preferences editor.

## Syntax

---

```
>>-TCPCLIENTAddress-- --client_address-----<<
```

## Parameters

---

client\_address

Specifies the TCP/IP address you want the server to use to contact your client node. Specify a TCP/IP Internet domain name or a numeric IP address. The numeric IP address can be either a TCP/IPv4 or TCP/IPv6 address. You can only use IPv6 addresses if you specified the commethod V6Tcip option.

## Examples

---

AIX	Linux	Mac OS X	Solaris
-----	-------	----------	---------

 Options file:  

AIX	Linux	Mac OS X	Solaris
-----	-------	----------	---------

```
tcpclienta dsmclnt.example.com
or
tcpclienta 192.0.2.21
```

**Windows** Command line:

**Windows**

```
-tcpclientaddress=192.0.2.0
-tcpclientaddress=example.mycompany.mydomain.com
-tcpclientaddress=2001:0DB8:0:0:0:0:0:0
```

This option is valid only on the initial command line. It is not valid in interactive mode.

## Tcpclientport

---

The tcpclientport option specifies a TCP/IP port number for the server to contact the client when the server begins the server prompted scheduled operation.

Use this option only if you specify the prompted parameter with the schedmode option.

If sessioninitiation is set to serveronly, the value for the tcpclientport client option should be the same as the value for the LLAddress server option.

## Supported Clients

---

This option is valid for all clients. The IBM Spectrum Protect™ API does not support this option.

## Options File

---

**AIX** | **Linux** | **Solaris** | **Mac OS X** Place this option in the dsm.sys file within a server stanza. You can set this option on the Scheduler tab, in the Your TCP/IP port field in the Preferences editor.

**Windows** Place this option in the client options file (dsm.opt). You can set this option on the Scheduler tab, in the Your TCP/IP port field in the Preferences editor.

## Syntax

---

```
>>-TCPCLIENTPort-- --client_port_address-----><
```

## Parameters

---

**client\_port\_address**  
Specifies the TCP/IP port address you want the server to use to contact your client node. The range of values is 1 through 32767; the default is 1501.

## Examples

---

Options file:  
tcpclientp 1502

Command line:  
-tcpclientport=1492

This option is valid only on the initial command line. It is not valid in interactive mode.

## Tcpnodelay

---

The tcpnodelay option specifies whether the client disables the delay of sending successive small packets on the network, per transaction.

Change the value from the default of yes only under one of the following conditions:

- You are directed to change the option by IBM® technical support.
- You fully understand the effects of the TCP Nagle algorithm on network transmissions. Setting the option to no enables the Nagle algorithm, which delays sending small successive packets.

AIX Linux Solaris Mac OS X Windows

## Supported Clients

AIX Linux Solaris Mac OS X This option is valid for all UNIX and Linux clients.

Windows This option is valid for all Windows clients.

## Options File

AIX Linux Solaris Mac OS X Place this option in the client system-options file (dsm.sys) within a server stanza. You can set this option on the Communication tab in the Preferences editor. Select Send transaction to the server immediately.

Windows Place this option in the client options file (dsm.opt). You can set this option on the Communication tab in the Preferences editor. Select Send transaction to the server immediately.

## Syntax

```
>>-TCPNodelay-+-.-Yes-.-<<
                '-No--'
```

## Parameters

No

Specifies that the server does not allow successive small packets to be sent immediately over the network. Setting this option to no can degrade performance.

Yes

Specifies that the server or client allows successive small packets to be sent immediately over the network. The default is yes.

## Examples

Options file:

```
tcpnodelay yes
```

Command line:

Does not apply.

## Tcpport

The tcpport option specifies a TCP/IP port address for the IBM Spectrum Protect™ server. You can obtain this address from your administrator.

## Supported Clients

This option is valid for all clients.

## Options File

AIX Linux Solaris Mac OS X Place this option in the client system-options file (dsm.sys) within a server stanza. You can set this option on the Communication tab, in the Server Port field in the Preferences editor.

Windows Place this option in the client options file (dsm.opt). You can set this option on the Communication tab, in the Server Port field in the Preferences editor.

## Syntax

```
>>-TCPport-- --port_address-----<<
```

## Parameters

---

port\_address

Specifies the TCP/IP port address that is used to communicate with a server. The range of values is 1 through 32767; the default is 1500.

## Examples

---

Options file:

```
tcpport 1501
```

**Windows** Command line:

```
-tcpport=1501
```

**AIX** **Linux** **Solaris** **Mac OS X** Command line:

**AIX** **Linux** **Solaris** **Mac OS X** Does not apply.

**Windows** This option is valid only on the initial command line. It is not valid in interactive mode.

## Tcpserveraddress

---

The tcpserveraddress option specifies the TCP/IP address for the IBM Spectrum Protect™ server. You can obtain this server address from your administrator.

## Supported Clients

---

This option is valid for all clients.

## Options File

---

**AIX** **Linux** **Solaris** **Mac OS X** Place this option in the client system-options file (dsm.sys) within a server stanza. You can set this option on the Communication tab, in the Server Address field in the Preferences editor.

**Windows** Place this option in the client options file (dsm.opt). You can set this option on the Communication tab, in the Server Address field in the Preferences editor.

If this option is not specified, the client attempts to contact a server running on the same computer as the backup-archive client.

## Syntax

---

```
>>-TCPserveraddress-- --server_address-----<<
```

## Parameters

---

server\_address

Specifies a 1 to 64 character TCP/IP address for a server. Specify a TCP/IP domain name or a numeric IP address. The numeric IP address can be either a TCP/IP v4 or TCP/IP v6 address. You can only use IPv6 addresses if you specified the commmethod V6Tcpcip option.

## Examples

---

Options file:

```
tcps dsmchost.example.com
```

**AIX** **Linux** **Solaris** **Mac OS X** Command line:

**AIX** **Linux** **Solaris** **Mac OS X** Does not apply.

**Windows** Command line:

```
-tcpserveraddress=129.33.24.99
```

```
-tcpserveraddress=2002:92b:111:221:128:33:10:249
```

**Windows** This option is valid only on the initial command line. It is not valid in interactive mode.

## Tcpwindow size

Use the tcpwindow size option to specify, in kilobytes, the size you want to use for the TCP/IP sliding window for your client node.

The sending host cannot send more data until it receives an acknowledgment and a TCP receive window update. Each TCP packet contains the advertised TCP receive window on the connection. A larger window allows the sender to continue sending data and can improve communication performance.

## Supported Clients

This option is valid for all clients.

## Options File

**AIX** | **Linux** | **Solaris** | **Mac OS X** Place this option in the client system-options file (dsm.sys) within a server stanza. You can set this option on the Communication tab, Window Size field of the Preferences editor.

**Windows** Place this option in the client options file (dsm.opt). You can set this option on the Communication tab, Window Size field of the Preferences editor.

## Syntax

```
>>-TCPWindow size-- --window_size-----<<
```

## Parameters

**AIX** | **Linux** | **Solaris** | **Mac OS X** window\_size

**AIX** | **Linux** | **Solaris** | **Mac OS X** Specifies the size, in kilobytes, to use for your client node TCP/IP sliding window. The range of values is 0 through 2048. A value of 0 allows the client to use the operating system default TCP window size. Values from 1 to 2048 indicate that the window size is in the range of 1KB to 2MB. If you specify a value less than 1, the TCP window size defaults to 1. If you specify a value greater than 2048, the TCP window size defaults to 2048.

**AIX** | **Linux** | **Solaris** | **Mac OS X** For backup-archive clients, the default value for this parameter is 63 KB.

**AIX** | **Linux** | **Solaris** | **Mac OS X** For IBM Spectrum Protect™ for Virtual Environments: Data Protection for VMware, the default value for this parameter is 512 KB.

**AIX** | **Linux** | **Solaris** | **Mac OS X**

Notes:

- The TCP window acts as a buffer on the network. It is not related to the tcpbuffsize option, or to the send and receive buffers allocated in client or server memory.
- A window size larger than the buffer space on the network adapter might degrade throughput due to resending packets that were lost on the adapter.
- Depending on the operating system communication settings, your system might not accept all values in the range of values.
- The tcpwindow size option overrides the operating system's default TCP/IP session send and receive window sizes.

**Windows** window\_size

**Windows** Specifies the size, in kilobytes, to use for your client node TCP/IP sliding window. The range of values is 0 through 2048. A value of 0 allows the client to use the operating system default TCP window size. Values from 1 to 2048 indicate that the window size is in the range of 1KB to 2MB. If you specify a value less than 1, the TCP window size defaults to 1. If you specify a value greater than 2048, the TCP window size defaults to 2048.

**Windows** For backup-archive clients, the default value for this parameter is 63 KB.

**Windows** For IBM Spectrum Protect for Virtual Environments: Data Protection for VMware, the default value for this parameter is 512 KB.

**Windows**

Notes:

- The TCP window acts as a buffer on the network. It is not related to the tcpbuffsize option, or to the send and receive buffers allocated in client or server memory.

- A window size larger than the buffer space on the network adapter might degrade throughput due to resending packets that were lost on the adapter.
- Depending on the operating system communication settings, your system might not accept all values in the range of values.
- The tcpwindowsize option overrides the operating system's default TCP/IP session send and receive window sizes.
- Windows provides a larger TCP receive window size when communicating with hosts that also provide this support, known as RFC1323. In these environments, a value greater than 63 can be useful.

## Examples

---

Options file:  
 tcpwindowsize 63  
 Command line:  
 -tcpw=63

This option is valid only on the initial command line. It is not valid in interactive mode.

## Timeformat

---

The timeformat option specifies the format in which you want to display and enter system time.

**Windows** Use this option if you want to change the default time format for the language of the message repository you are using.

By default, the backup-archive and administrative clients obtain format information from the locale definition in effect at the time the client is called. Consult the documentation on your local system for details about setting up your locale definition.

Note: The timeformat option does not affect the web client. The web client uses the time format for the locale that the browser is running in. If the browser is not running in a locale that the client supports, the web client uses the time format for US English.

You can use the timeformat option with the following commands:

- delete archive
- delete backup
- expire
- query archive
- **Windows** query asr
- query backup
- query filespace
- **AIX** **Linux** **Solaris** **Windows** query image
- query nas
- **Windows** query systemstate
- restore
- **AIX** **Linux** **Solaris** **Windows** restore image
- **AIX** **Solaris** **Windows** restore nas
- **Windows** restore registry
- retrieve
- set event

When you include the timeformat option with a command, it must precede the fromtime, pittime, and totime options.

## Supported Clients

---

This option is valid for all clients.

## Options File

---

**AIX** **Linux** **Solaris** **Mac OS X** Place this option in the client user-options file (dsm.opt). You can set this option on the Regional Settings tab, Time Format field of the Preferences editor.

**Windows** Place this option in the client options file (dsm.opt). You can set this option on the Regional Settings tab, Time Format field of the Preferences editor.

## Syntax

---



>>-TIMEformat-- --format\_number-----><

## Parameters

### format\_number

Displays time in one of the formats listed here. Select the format number that corresponds to the format you want to use. When you include the timeformat option in a command, it must precede the fromtime, pittime, and totime options.

	AIX	Linux	Solaris	
			0	
	AIX	Linux	Solaris	Use the locale-defined time format (does not apply to Mac OS X). This value is the default if the locale-specified format consists of digits, separator characters, and, if applicable, the AM or PM string.
1				23:00:00
	AIX	Linux	Mac OS X	Solaris
				This is the default if the locale-specified format does not consist of digits, separator characters, and, if applicable, the AM or PM string.
2				23,00,00
3				23.00.00
4				12:00:00 A/P
5				A/P 12:00:00

## Examples

Options file:

```
timeformat 4
```

Command line:

```
-time=3
```

This option is valid on the initial command line and in interactive mode. If you use this option in interactive mode, it affects only the command with which it is specified. When that command completes, the value reverts to the value at the beginning of the interactive session. This is the value from the dsm.opt file unless overridden by the initial command line or by an option forced by the server.

## Additional considerations for specifying time and date formats

The date or time format you specify with this option must be used when using options that take date and time as input. Examples are: totime, fromtime, todate, fromdate, and pittime.

For example, if you specify the timeformat option as TIMEFORMAT 4, the value that you provide on the fromtime or totime option must be specified as a time such as 12:24:00pm. Specifying 13:24:00 would not be valid because TIMEFORMAT 4 requires an hour integer that is 12 or less. If you want to specify up to 24 hour values on an option, and if you want to use commas as separators, you must specify TIMEFORMAT 2.

AIX	Linux	Mac OS X	Solaris
-----	-------	----------	---------

## Configuring date and time formats in the system locale configuration file

You can specify date and time formats by configuring them in your system's locale file. If you specify time and date formats in the locale file, they must be defined using a subset of number-producing format specifiers that are supported by the C language strftime() function. You can use the following specifiers to set date and time formats in configuration settings for your locale.

Date specifiers

- %Y - the year, in four digits. For example, 2011.
- %y - the year, last two digits only. For example, 11 not 2011.
- %m - the month, as a decimal number (1-12).
- %d - the day of the month (1-31).

In the date specifiers, you can specify only one year specifier. Do not specify both %Y and %y. The E modifier (a capital E) can precede the date specifiers to produce the locale's alternative form for the year, month, or day. If no alternative form exists, the E modifier is ignored. Separate the specifiers with a single 7-bit ASCII character. Commonly used separators include colons (:), commas (,), periods (.), hyphens (-), or forward slash (/) characters. Do not use multibyte characters as separators.

#### Time specifiers

- %H - the hour, in 24-hour form (00-23).
- %I - the hour, in 12-hour form (00-12).
- %M - minutes after the hour (00-59).
- %S - seconds after the minute (00-59)
- %p - adds the AM (before noon) or PM (after noon) indicator.

In the time specifiers, you can specify only one hour specifier. Do not specify both %I and %H.

The O modifier (a capital O) can precede the time specifiers to produce the locale's alternative form for the hour, minutes, or seconds. The O modifier cannot precede the %p specifier. Separate the specifiers with a single 7-bit ASCII character. Commonly used separators include colons (:), commas (,), or periods (.). Do not use multibyte characters as separators. Do not specify a separator between the %p specifier and the separator that precedes or follows it.

#### Time format examples, configured in the locale settings

**AIX** | **Linux** | **Mac OS X** | **Solaris** To set a particular time format, edit the configuration file for your locale and modify the `t_fmt` line to support your needs. Whatever time format you select applies both to output and to input. After the locale configuration file has been edited, the `localedef` command must be run to create the final locale file.

Table 1. Sample time format settings in the locale configuration (`t_fmt` line)

Example	Result
"%H:%M:%S"	Displays time in the form <i>hh:mm:ss</i> with <i>hh</i> ranging from 0 through 23.
"%H,%M,%S"	Displays time in the form <i>hh,mm,ss</i> with <i>hh</i> ranging from 0 through 23.
"%I,%M,13p"	Displays time in the form <i>hh,mm,ssA/P</i> with <i>hh</i> ranging from 1 through 12 and <i>A/P</i> is the local abbreviation for ante-meridian (AM in English) or post-meridian (PM in English).

#### Date format examples, configured in the locale settings

**AIX** | **Linux** | **Mac OS X** | **Solaris** To set a particular date format, edit the configuration file and modify the `d_fmt` line as needed to support your needs. Whatever date format you select applies both to output and to input.

Table 2. Sample date format settings in the locale configuration (`d_fmt` line)

Example	Result
"%m/%d/%y"	Displays the date in the form <i>MM/DD/YY</i> .
"%d.%m.%Y"	Displays the date in the form <i>DD.MM.YYYY</i> .

**AIX** | **Solaris** | **Windows**

## Toc

Use the `toc` option with the `backup nas` command or the `include.fs.nas` option to specify whether the backup-archive client saves table of contents (TOC) information for each file system backup.

You should consider the following when deciding whether you want to save TOC information:

- If you save TOC information, you can use the `QUERY TOC server` command to determine the contents of a file system backup in conjunction with the `RESTORE NODE server` command to restore individual files or directory trees.
- You can also use the web client to examine the entire file system tree and select files and directories to restore.

- Creation of a TOC requires that you define the TOCDESTINATION attribute in the backup copy group for the management class to which this backup image is bound. Note that TOC creation requires additional processing, network resources, storage pool space, and possibly a mount point during the backup operation.
- If you do not save TOC information, you can still restore individual files or directory trees using the RESTORE NODE server command, provided that you know the fully qualified name of each file or directory and the image in which that object was backed up.

## Supported Clients

**AIX** | **Solaris** This option is only valid for AIX® and Solaris clients. The IBM Spectrum Protect™ API does not support this option.

**Windows** This option is valid for all Windows clients. The IBM Spectrum Protect API does not support this option.

## Options File

**AIX** | **Solaris** Place the include.fs.nas statement containing the toc value in the dsm.sys file within a server stanza.

**Windows** Place the include.fs.nas statement containing the toc value in the client options file (dsm.opt).

## Syntax

```

    .-Preferred-.
>>-TOC-----+-----><
    +-Yes-----+
    '-No-----'

```

## Parameters

Yes

Specifies that the client saves TOC information during a NAS file system image backup. However, the backup fails if an error occurs during creation of the TOC.

No

Specifies that the client does not save TOC information during a NAS file system image backup.

Preferred

Specifies that the client saves TOC information during a NAS file system image backup. The backup does not fail if an error occurs during creation of the TOC. This is the default.

Note: If the mode option is set to differential and you set the toc option to preferred or yes, but the last full image does not have a TOC, the client performs a full image backup and creates a TOC.

## Examples

Options file:

```
include.fs.nas netappsj/vol/vol0 homemgmtclass toc=yes
```

**AIX** | **Solaris** Command line:

```
backup nas -nasnodename=netappsj /vol/vol0 -toc=yes
```

**Windows** Command line:

```
backup nas -nasnodename=netappsj {/vol/vol0} -toc=yes
```

## Todate

Use the todate option with the totime option to specify an ending date and time to which you want to search for backups or archives during a restore, retrieve, or query operation

Use the todate and totime options with the fromtime and fromdate options to request a list of backed up or archived files within a period of time. For example, you might request a list of files that were backed up between 6:00 AM on July 1, 2002 and 11:59 PM on July 30, 2002.

Use the todate option with the following commands:

- delete backup
- query archive
- query backup
- restore
- restore group
- retrieve

## Supported Clients

---

This option is valid for all clients. The IBM Spectrum Protect™ API does not support this option.

## Syntax

---

```
>>-TODate = - --date-----<<
```

## Parameters

---

date

Specifies an ending date. Enter the date in the format you selected with the dateformat option.

When you include dateformat with a command, it must precede the fromdate, pitdate, and todate options.

## Examples

---

```
Mac OS X Command line:
Mac OS X dsmc restore "/Users/agordon/Documents/*" -todate=12/11/2003
AIX Linux Solaris Mac OS X Command line:
AIX Linux Solaris Mac OS X dsmc restore "/home/user1/*" -todate=12/11/2003
Windows Command line:
Windows dsmc restore -todate=12/11/2003 c:\myfiles\
```

## Totime

---

Use the totime option with the todate option to specify an ending date and time to which you want to search for backups or archives during a restore, retrieve, or query operation. The backup-archive client ignores this option if you do not specify the todate option.

Use the totime and todate options with the fromtime and fromdate options to request a list of files that were backed up within a period of time. For example, you might request a list of files that were backed up between 6:00 AM on July 1, 2003 and 11:59 PM on July 30, 2003.

Use the totime option with the following commands:

- delete backup
- query archive
- query backup
- restore
- restore group
- retrieve

## Supported Clients

---

This option is valid for all clients. The IBM Spectrum Protect™ API does not support this option.

## Syntax

---

```
>>-TOTime = - --time-----<<
```

## Parameters

---

time

Specifies an ending time. If you do not specify a time, the time defaults to 23:59:59. Specify the time in the format you selected with the timeformat option.

When you include the timeformat option in a command, it must precede the fromtime, pittime, and totime options.

## Examples

---

```
Mac OS X Command line:
Mac OS X dsmc restore "/Users/van/Documents/myfiles/*" -todate=09/17/2003 -totime=23:00:00
AIX Linux Solaris Mac OS X Command line:
AIX Linux Solaris Mac OS X dsmc restore "/home/user1/*" -todate=09/17/2003 -
totime=23:00:00
Windows Command line:
Windows dsmc query backup -totime=23:59:00 -todate=06/30/2003 c:\mybackups\
```

## Txnbytelimit

---

The txnbytelimit option specifies the number of kilobytes the client program buffers before it sends a transaction to the server.

A *transaction* is the unit of work exchanged between the client and server. A transaction can contain more than one file or directory, called a *transaction group*.

You can control the amount of data sent between the client and server, before the server commits the data and changes to the server database, using the txnbytelimit option. Controlling the amount of data sent changes the speed of the client to perform the transactions. The amount of data sent applies when files are batched together during backup or when receiving files from the server during a restore procedure.

After the txngroupmax number is reached, the client sends the files to the server, even if the transaction byte limit is not reached.

```
AIX Linux Solaris Mac OS X Windows
```

## Supported Clients

---

This option is valid for all clients.

## Options File

---

```
AIX Linux Solaris Mac OS X
```

Place this option in the client system-options file (dsm.sys) within a server stanza. You can set this option on the General tab, in the Transaction Buffer Size field in the Preferences editor.

```
Windows
```

Place this option in the client options file (dsm.opt). You can set this option on the General tab, in the Transaction Buffer Size field in the Preferences editor.

## Syntax

---

```
>>-TXNBytelimit-- --number-----<<
```

## Parameters

---

number

Specifies the number of kilobytes the client program sends to the server before committing the transaction. The range of values is 300 through 34359738368 (32 GB). The default is 25600 KB. The number can be specified as an integer or as an integer with one of the following unit qualifiers:

- K or k (kilobytes)
- M or m (megabytes)
- G or g (gigabytes)

If no unit qualifier is specified, the integer is in kilobytes.

Restriction: The `txnbytelimit` option does not support decimal numbers, and only one-unit letters are allowed. For example: K, M, or G.

## Examples

---

Options file:

```
txn 25600
txn 2097152
txn 2097152k
txn 2048m
txn 2g
txn 32G
```

Command line:

```
-txn=25600
-txn=16G
```

This option is valid only on the initial command line. It is not valid in interactive mode.

AIX | Solaris | Windows

## Type

---

Use the `type` option with the `query node` command to specify the type of node to query. Use this option with the `set event` command to activate, hold, or release.

## Supported Clients

---

AIX This option is also valid for the `set password` command with the TSM type on AIX® clients.

Windows This option is also valid for the `set password` command with the TSM or FILER type.

AIX | Solaris This option is only valid for AIX and Solaris clients. The IBM Spectrum Protect™ API does not support this option.

Windows This option is valid for all Windows clients. The IBM Spectrum Protect API does not support this option.

AIX | Solaris | Windows

## Syntax

---

```
>>-Type = .-any----
          +-----+----->><
          +-nas----+
          +-server-+
          '-client-'
```

## Parameters

---

`nas`

Specifies all NAS nodes registered at the server.

`server`

Specifies client nodes that are other IBM Spectrum Protect servers.

`client`

Specifies client nodes that are backup-archive clients.

## Examples

---

Command line:

AIX | Solaris | Windows `query node -type=nas`

AIX | Linux

## Updatectime

---

Use the updatectime option to check the change time (ctime) attribute during an incremental backup operation.

### Supported Clients

---

This option is valid for AIX® and Linux clients on GPFS™ file systems only. The server can also define this option.

### Options File

---

Place this option in the client user options file (dsm.opt).

### Syntax

---

```
>>-UPDATEctime--+-no--+.-----><
                  '-yes-'
```

### Parameters

---

no

The backup-archive client does not check the change time (ctime attribute) during a backup operation. This value is the default.

yes

The backup-archive client checks the change time (ctime attribute) during a backup operation. If the ctime attribute changed since the last backup operation, the ctime attribute is updated on the IBM Spectrum Protect™ server. The object is not backed up unless it has either ACLs or extended attributes. The client checks files and directories.

### Examples

---

Options file:

```
updatect yes
```

Command line:

```
dsmc incr /proj/gpfs/test/ -updatectime=yes
```

Windows

## Usedirectory

---

The usedirectory option queries the Active Directory for the communication method and server with which to connect.

This option overrides the commmethod parameters specified in the client options file (dsm.opt). Optimally, the administrator enables only one server and one specific communication protocol for a given client node. The specification of this information in Active Directory is done using the IBM Spectrum Protect™ server on Windows, which has a wizard to assist with this configuration. If a node is registered to more than one server published in Active Directory, the first server returned in the Active Directory query is used. If the client cannot contact the server, the client session fails.

### Supported Clients

---

This option is valid for all Windows clients. The IBM Spectrum Protect API does not support this option.

### Options File

---

Place this option in the client options file (dsm.opt). You can set this option on the Communication tab of the Preferences editor.

### Syntax

---

```
>>-USEDIRectory--+-No--+.-----><
```

'-Yes-'

## Parameters

---

Yes

Specifies that the client ignores commmethod parameters set in the client options file and query the Active Directory for the communication method and server with which to connect.

No

Specifies that the client uses the communication method specified in the option file. If there is no communication method specified in the option file the default communication method and server are used.

## Examples

---

Options file:

```
usedirectory no
```

Command line:

```
-usedir=yes
```

This option is valid only on the initial command line. It is not valid in interactive mode.

AIX

Linux

Windows

## Useexistingbase

---

The useexistingbase option is used when you back up snapshots that are on NetApp filer volumes. The useexistingbase option indicates that the latest snapshot that exists on the volume being backed up, is to be used as the base snapshot, during a snapshot differential backup operation.

If this option is not specified, a new snapshot is created on the volume that is being backed up. Because target filer volumes are read only volumes, useexistingbase must be specified when performing snapshot differential backups of target filer volumes. If useexistingbase is not specified, snapshot differential backups of a target filer volume fail because the new snapshot cannot be created on the read only volume.

When backing up target filer volumes, use both the useexistingbase option and the diffsnapshot=latest option to ensure that the most recent base and most recent differential snapshots are used during the volume backup

## Supported Clients

---

Linux

This option can be used with supported x86\_64 Linux clients.

Windows

This option can be used with supported Windows clients.

## Options File

---

This option is only valid on the command line.

## Syntax

---

```
>>-USEEXISTINGBase-----<<
```

## Parameters

---

This option has no parameters

## Examples

---

Options file:

Does not apply.

Command line:



```
dsmc incr \\DRFile\UserDataVol_Mirror_Share -snapdiff
-useexistingbase -basenameshotname="nightly.?"
```

**Related reference:**  
Basesnapshotname

## User replication failover

---

The `userreplicationfailover` option specifies whether automated client failover occurs on a client node.

Use this option to enable a client node for failover or to prevent it from failing over to the secondary server. This option overrides the configuration that is provided by the IBM Spectrum Protect™ server administrator settings on the primary server.

## Supported Clients

---

This option is valid for all clients.

## Options File

---

**AIX** | **Linux** | **Solaris** | **Mac OS X** Place this option within a server stanza in the `dsm.sys` file.

**Windows** Place this option in the client options file (`dsm.opt`).

## Syntax

---

```

                                     .-Yes-.
>>-USEREPLICATIONFailover-----><
                                     '-No--'
```

## Parameters

---

Yes

Specifies that you want the client to automatically fail over to the secondary server if the primary server is unavailable. The client uses the configuration that is provided by the primary server to connect to the secondary server. This value is the default.

No

Specifies that the client does not automatically fail over to the secondary server.

## Examples

---

Options file:

```
USEREPLICATIONFailover no
```

Command line:

Does not apply.

**Related concepts:**

Automated client failover configuration and use

**Related tasks:**

Configuring the client for automated failover

**AIX** | **Linux** | **Solaris** | **Mac OS X**

## Users (deprecated)

---

This option is deprecated.

## V2archive

---

Use the `v2archive` option with the `archive` command to archive only files to the server.

The backup-archive client will not process directories that exist in the path of the source file specification.

This option differs from the filesonly option in that the filesonly option archives the directories that exist in the path of the source file specification.

The v2archive and dirsonly options are mutually exclusive and an error message is displayed if you use both options in the same archive command.

If you use this option, you might want to consider the following:

- You might experience performance problems when retrieving large amounts of data archived with this option.
- You might want to use this option only if you are concerned about expiration performance on a server that already contains extremely large amounts of archived data.
- If there are multiple files with the same name for the v2archive option, the files are archived multiple times, with their directory structure. The v2archive option archives only the files.

## Supported Clients

---

This option is valid for all clients. The IBM Spectrum Protect™ API does not support this option.

## Syntax

---

```
>>-v2archive-----<<
```

## Parameters

---

There are no parameters for this option.

## Examples

---

**Mac OS X** This command:

```
Mac OS X dsmc archive "/Users/user2/Documents/*" -v2archive -su=y.
```

**Archives these files:**

```
/Users/user2/Documents/file1  
/Users/user2/Documents/file2  
/Users/user2/Documents/file3  
/Users/user2/Documents/dir2/file4  
/Users/user2/Documents/dir2/file5
```

Note: The client does not archive /Users/user2/Documents and /Users/user2/Documents/dir2.

**AIX** **Linux** **Solaris** **Mac OS X** This command:

```
AIX Linux Solaris Mac OS X dsmc archive "/home/relx/dir1/*" -v2archive -su=y.
```

**Archives these files:**

```
/home/relx/dir1/file1  
/home/relx/dir1/file2  
/home/relx/dir1/file3  
/home/relx/dir1/dir2/file4  
/home/relx/dir1/dir2/file5
```

Note: The client does not archive /home/relx/dir1 and /home/relx/dir1/dir2.

**Windows** This command:

```
Windows dsmc archive c:\relx\dir1\ -v2archive -su=y
```

**Archives these files:**

```
c:\relx\dir1\file1  
c:\relx\dir1\file2  
c:\relx\dir1\file3  
c:\relx\dir1\dir2\file4  
c:\relx\dir1\dir2\file5
```

Note: The client does not archive c:\relx\dir1 and c:\relx\dir1\dir2.

## Verbose

---

The verbose option specifies that you want to display detailed processing information on your screen. This is the default.

When you run the incremental, selective, or archive commands, information is displayed about each file that is backed up. Use the quiet option if you do not want to display this information.

The following behavior applies when using the verbose and quiet options:

- If the server specifies either the quiet or verbose option in the server client option set, the server settings override the client values, even if force is set to no on the server.
- If you specify quiet in your dsm.opt file, and you specify -verbose on the command line, -verbose prevails.
- If you specify both -quiet and -verbose on the same command, the last option encountered during options processing prevails. If you specify -quiet -verbose, -verbose prevails. If you specify -verbose -quiet, -quiet prevails.

**Mac OS X** The information is displayed on your screen in the Scheduler Status window. This option only applies when you are running the scheduler and the client is performing scheduled work.

## Supported Clients

---

This option is valid for all clients. The server can also define this option. The IBM Spectrum Protect™ API does not support this option.

## Options File

---

**AIX** **Linux** **Solaris** **Mac OS X** Place this option in the client user-options file (dsm.opt). You can set this option on the Command Line tab, Do not display process information on screen checkbox of the Preferences editor.

**Windows** Place this option in the client options file (dsm.opt). You can set this option on the Command Line tab, Do not display process information on screen checkbox of the Preferences editor.

## Syntax

---

```
>>-VErbose-----<<
```

## Parameters

---

There are no parameters for this option.

## Examples

---

Options file:  
verbose  
Command line:  
-verbose

This option is valid only on the initial command line. It is not valid in interactive mode.

**AIX** **Linux** **Solaris** **Windows**

## Verifyimage

---

Use the verifyimage option with the restore image command to specify that you want to enable detection of bad sectors on the destination target volume.

If bad sectors are detected on the target volume, the backup-archive client issues a warning message on the console and in the error log.

## Supported Clients

---

**AIX** **Linux** **Solaris** This option is valid only for AIX®, Oracle Solaris, and all Linux clients. The IBM Spectrum Protect™ API does not support this option.

**Windows** This option is valid for all Windows clients. The IBM Spectrum Protect API does not support this option.

## Syntax

---

```
>>-VERIFYImage-----<<
```

## Parameters

---

There are no parameters for this option.

## Examples

---

```
AIX Linux Solaris Command line:
AIX Linux Solaris dsmc restore image /usr -verifyimage
Windows Command line:
Windows dsmc restore image d: -verifyimage
```

## Virtualfsname

---

Use the virtualfsname option with the backup group command to specify the name of the virtual file space for the group on which you want to perform the operation. The virtualfsname cannot be the same as an existing file space name.

```
AIX Linux Solaris Windows
```

## Supported Clients

---

```
AIX Linux Solaris This option is valid for all UNIX and Linux clients except for Mac OS X.
Windows This option is valid for all Windows clients.
```

## Syntax

---

```
>>-VIRTUALFname = - --fname-----<<
```

## Parameters

---

**fsname**  
Specifies the name of the container for the group on which you want to perform the operation.

## Examples

---

```
Command line:
Mac OS X
backup group -filelist=/Users/van/Documents/filelist1 -groupname=group1
-virtualfsname=/virtfs -mode=full
AIX Linux Solaris
backup group -filelist=/home/dir1/filelist1 -groupname=group1
-virtualfsname=/virtfs -mode=full
Windows
backup group -filelist=c:\dir1\filelist1 -groupname=group1
-virtualfsname=\virtfs -mode=full
AIX Linux Solaris
```

## Virtualmountpoint

---

The virtualmountpoint option defines a virtual mount point for a file system if you want to consider files for backup that begin with a specific directory within that file system.

Using the `virtualmountpoint` option to identify a directory within a file system provides a direct path to the files you want to back up, saving processing time. It is more efficient to define a virtual mount point within a file system than it is to define that file system using the `domain` option, and then to use the `exclude` option in your include-exclude options list to exclude the files that you do not want to back up.

Use the `virtualmountpoint` option to define virtual mount points for multiple file systems, for local and remote file systems, and to define more than one virtual mount point within the same file system. Virtual mount points cannot be used in a file system handled by automounter.

You can use the `virtualmountpoint` option to back up unsupported file systems, with certain limitations. For information about using `virtualmountpoint` with unsupported file systems, see [File system and ACL support](#).

Note: If the directory that you want to specify as a virtual mount point is a symbolic link, set the `followsymbolic` option to Yes. If that option is set to no (the default), you are not permitted to use a symbolic link as a virtual mount point. Also, if you back up a file system, then add a virtual mount point, and then do another incremental on the file system, the files and directories in the virtual mount point directory are expired, because they are logically contained within the virtual mount point directory and not the file system.

After you define a virtual mount point, you can specify the path and directory name with the `domain` option in either the default client options file or on the incremental command to include it for incremental backup services. When you perform a backup or archive using the `virtualmountpoint` option, the `query filespace` command lists the virtual mount point in its response along with other file systems. Generally, directories that you define as virtual mount points are treated as actual file systems and require that the `virtualmountpoint` option is specified in the `dsm.sys` file to restore or retrieve the data.

Note: When you specify a `virtualmountpoint` option, the path that it specifies is added to the default backup domain (domain all-local). The `virtualmountpoint` path is always considered a local "mount point" regardless of the real file system type it points to.

## Supported Clients

---

This option is valid for all UNIX clients except Mac OS X. The IBM Spectrum Protect™ API does not support this option.

## Options File

---

Place this option in the client system-options file (`dsm.sys`) within a server stanza.

## Syntax

---

```
.-----  
v                                     |  
>>---VIRTUALMountpoint-- --directory+-----<<
```

## Parameters

---

`directory`

Specifies the path and directory name for the directory you want to use as the virtual mount point for a file system. You cannot use wildcard characters in either the path or directory names.

Define only one virtual mount point with each `virtualmountpoint` option that you include in your client system-options file. Use the `virtualmountpoint` option as many times as necessary to define all of the virtual mount points that you want to use.

## Examples

---

Options file:

```
virtualmountpoint /afs/xyzcorp.com/home/ellen  
virtualmountpoint /afs/xyzcorp.com/home/ellen/test/data
```

Command line:

Does not apply.

## Virtualnodename

---

The `virtualnodename` option specifies the node name of your workstation when you want to restore or retrieve files to a different workstation.

When you use the `virtualnodename` option in your client options file, or with a command:

- **Windows** You must specify the name you specified with the `nodename` option in your client options file (`dsm.opt`). This name should be different from the name returned by the `hostname` command on your workstation.
- **AIX Linux Solaris Mac OS X** You must specify the name you specified with the `nodename` option in your client system-options file (`dsm.sys`). This name should be different from the name returned by the `hostname` command on your workstation.
- The client prompts for the password assigned to the node that you specify, if a password is required (even when the `passwordaccess` option is set to generate). If you enter the correct password, you have access to all backups and archives that originated from the specified node.

When connecting to a server, the client must identify itself to the server. This login identification is determined in the following ways:

- If the `nodename` and `virtualnodename` options are not specified, or a virtual node name is not specified on the command line, the default login ID is the name returned by the `hostname` command.
- If the `nodename` option is specified, the name specified with the `nodename` option overrides the name returned by the `hostname` command.
- If the `virtualnodename` option is specified, or a virtual node name is specified on a command line, it cannot be the same name as the name returned by the `hostname` command.

**Windows** Note: The client can use file space information when restoring files. The file space information can contain the name of the computer from which the files were backed up. If you restore from another client node and do not specify a destination for the restored files, the client uses the file space information to restore the files. In such a case, the client attempts to restore the files to the file system on the original computer. If the restoring computer has access to the file system of the original computer, you can restore files to the original file system. If the restoring computer can not access the file system of the original computer, the client can return a network error message. If you want to restore the original directory structure but on a different computer, specify only the target file system when you restore. This is true when restoring files from another node and when retrieving files from another node.

**AIX Linux Solaris Mac OS X Windows**

## Supported Clients

---

This option is valid for all clients.

## Options File

---

**Windows** Place this option in the client options file (`dsm.opt`).

**AIX Linux Solaris Mac OS X** Place this option in the client user-options file (`dsm.opt`).

## Syntax

---

```
>>-VIRTUALNodename-- --nodename-----><
```

## Parameters

---

`nodename`

Specifies a 1- to 64-character name that identifies the node for which you want to request IBM Spectrum Protect™ services. There is no default.

## Examples

---

Options file:

```
virtualnodename cougar
```

Command line:

```
-virtualn=banshee
```

This option is valid only on the initial command line. It is not valid in interactive mode.

## Vmautostartvm

Use the `vmautostartvm` option with the restore VM `vmrestoretype=instantaccess` command to specify whether the VM created during instant access processing is automatically powered on.

This option is only valid for VMware virtual machines. The virtual machines must be hosted on VMware ESXi 5.1 servers, or later versions. To use this option, you must have a license agreement to use IBM Spectrum Protect™ for Virtual Environments: Data Protection for VMware.

### Supported Clients

**Windows** This option can be used with supported Windows clients.

### Options file

Place this option in the client options file (`dsm.opt`), or on the command line. This option is only valid when used for an operation where `vmrestoretype=instantaccess`.

### Syntax

```
>>-VMAUTOSTARTvm-+-----+----->>
                  .-NO-- .
                  '-YES-'
```

### Parameters

#### NO

The VM created for instant access is not started automatically. The VM must be started manually. This is the default setting. The default provides an opportunity to reconfigure the VM before you power it on, to avoid potential conflicts with existing virtual machines.

#### YES

The VM created for instant access is started automatically.

### Examples

#### Options file:

```
VMAUTOSTARTvm NO
```

#### Command line:

```
dsmc restore vm Oslo -VMRESToretype=INSTANTAccess -vmname=Oslo_verify
-VMAUTOSTARTvm=YES
```

## Vmbackdir

The `vmbackdir` option specifies the temporary disk location where the client saves control files that are created during full VM backup and restore operations of virtual machines.

### Supported Data Movers

 This feature is available only if the client operates as a data mover for IBM Spectrum Protect™ for Virtual Environments.

When a client on a data mover node starts a full VM backup of a virtual machine, the client creates metadata in files that are associated with the backed up virtual machine and its data. The files that contain the metadata are referred to as *control files*.

During full VM backup operations, the metadata is saved on a disk in the data mover node until the backup completes and both the virtual machine data and the control files are saved to server storage. During a full VM restore operation, the control files are copied from the server and are temporarily stored on the data mover disk, where they are used to restore the virtual machine and

its data. After a backup or a restore operation completes, the control files are no longer needed and the client deletes them from their temporary disk location.

The directory that is specified by this option must be on a drive that contains sufficient free space to contain the control information from a full VM backup.

**Linux** | **Windows** This option is valid for Linux and Windows data movers that are installed on a vStorage backup server.

**Windows** This option is valid for Windows data movers that are installed on a Hyper-V server.

## Options File

---

Set this option in the client options file, or specify it on the command line as an option for the backup vm or restore vm commands.

## Syntax

---

```
>>-VBACKDir--directory-----<<
```

## Parameters

---

directory

Specifies the path where the control files are stored on the backup server.

**Windows** The default is c:\mnt\tsmvmbackup\fullvm\

**Linux** The default is /tmp/tsmvmbackup/fullvm/

## Examples

---

Options file:

**Windows** VBACKD c:\mnt\tsmvmbackup\

**Linux** VBACKD /tmp/tsmvmbackup/

Command line:

**Windows** dsmc backup vm -VBACKUPT=fullvm -VBACKD=G:\virtual\_machine\control\_files\

**Windows** dsmc restore vm -VBACKUPT=fullvm -VBACKD=G:\san\_temp\

**Linux** dsmc backup vm -VBACKUPT=fullvm -VBACKD=/home/vmware/control\_files

**Linux** dsmc restore vm -VBACKUPT=fullvm -VBACKD=/home/mine/bkup\_ctrl

**Linux** | **Windows**

## Vmbackuplocation

---

Use the vmbackuplocation option with the backup vm or restore vm commands to specify the backup location for virtual machine backup and restore operations.

This option is only valid for VMware virtual machines. To use this option, you must have a license agreement to use IBM Spectrum Protect™ for Virtual Environments: Data Protection for VMware.

For restore operations, this option is ignored if the vmrestoretype option is set to mountcleanup or mountcleanupall.

## Supported Clients

---

**Linux** This option can be used with supported x86\_64 Linux clients.

**Windows** This option can be used with supported Windows clients.

## Options file

---

This option must be specified on the command line of a backup vm or restore vm command. You cannot set this option in the client options file.

## Syntax

---



```
>>- -VMBACKUPLOCation-- .-SERVER-. ---+LOCAL--+-----><
                                     '-BOTH---'
```

## Parameters

---

### SERVER

For backup operations, specifies that virtual machines are backed up to the IBM Spectrum Protect server.  
For restore operations, specifies that virtual machines are restored from the IBM Spectrum Protect server.  
This value is the default.

### LOCAL

For backup operations, specifies that virtual machines are backed up on the hardware storage. The backup is a full virtual machine image snapshot, even if an incremental backup is specified.

To create a local backup, the virtual machine must be stored in a VMware virtual volume (VVOL) datastore. If any virtual disk of the virtual machine is not in a VVOL datastore, the local backup is not allowed.

For restore operations, specifies that virtual machines are restored from persisted snapshots that are on the hardware storage.

By restoring from a local snapshot, you can only revert an existing virtual machine. You cannot restore a deleted virtual machine, and you cannot restore a virtual machine to a different name or location.

Local restore is not valid if the following parameters are used for the restore vm command:

- VMNAME
- DATACENTER
- HOST
- DATASTORE
- :vmdk

This value is also not valid if the vmrestoretype option is set to one of the following values. If these values are set, an error message is displayed.

- instantaccess
- instantrestore
- mount

Because no network data movement is needed for local snapshots, backup and restore operations can be faster than server backup and restore operations.

### BOTH

For backup operations, specifies that virtual machines are backed up to the IBM Spectrum Protect server and are also backed up locally. The local backup is always a full image snapshot of the VMs, even if incremental backups are configured for the server.

For restore operations, specifies that virtual machines are restored from the latest active version regardless whether it is a local or a server backup. If both active backups have the same timestamp, the local backup is used for the restore.

This value is not valid with the parameters and vmrestoretype option values that are listed above for the LOCAL value.

## Examples

---

### Command line:

Perform a full server and local backup for virtual machine vm1:

```
dsmc backup vm vm1 -vmbackuplocation=BOTH -vmbackuptype=FULLvm
```

Perform a local restore for virtual machine vm1:

```
dsmc restore vm vm1 -vmbackuplocation=LOCAL
```

## Vmbackupmailboxhistory

---

The vmbackupmailboxhistory option specifies whether mailbox history is automatically uploaded with the virtual machine (VM) backup if IBM Spectrum Protect™ for Mail: Data Protection for Microsoft Exchange Server is detected on a VM.

## Supported Clients

---

**Linux** | **Windows** This option is valid on clients that act as a data mover for VMware guest backups.

 This feature is available only if the client operates as a data mover for IBM Spectrum Protect for Virtual Environments: Data Protection for VMware.

## Options File

---

**Linux** Place this option in the client system-options file (dsm.sys) within a server stanza.

**Windows** Place this option in the client options file (dsm.opt).

## Syntax

---

```
.-Yes-.  
>>-VMBACKUPMAILBoxhistory--+----->>  
'-No--'
```

## Parameters

---

Yes

The mailbox history is automatically uploaded with the VM backup if IBM Spectrum Protect for Mail: Data Protection for Microsoft Exchange Server is detected on a VM.

No

The mailbox history is not automatically uploaded with the VM backup.

## Examples

---

Options file:  
vmbackupmailboxhistory yes

**Linux** | **Windows**

## Vmbackuptype

---

Use the vmbackuptype option with the backup VM or restore VM command to specify the type of virtual machine backup or restore to complete. You can also use this option on query VM commands to filter the query results to include only virtual machines that were backed up by a specific backup type. For examples, see the query VM command description.

 This feature is available only if the client operates as a data mover for IBM Spectrum Protect™ for Virtual Environments.

**Linux**

You can specify a VMware full VM backup.

**Windows**

You can specify a VMware full VM backup or a Hyper-V full VM backup.

## Supported Clients

---

**Linux** This option is valid on Linux data movers that are installed on a vStorage backup server. The server can also define this option.

**Windows** This option is valid on Windows data movers that are installed on a vStorage backup server. The server can also define this option.

**Windows** This option is valid on Windows data movers that are installed on a Microsoft Hyper-V system. The server can also define this option.

## Options File

---

**Linux** Place this option in the client system-options file (dsm.sys) within a server stanza.

**Windows** Place this option in the client options file (dsm.opt), or on the command line.

**Linux**

## Syntax

---

```
                .-FULLvm-.  
>>-VBACKUPTYPE---+-----+----->><
```

**Linux**

## Parameters

---

### FULLvm

Specify this value to run a traditional full VM backup of a VMware virtual machine. This is the default backup type for Linux clients.

**Windows**

## Syntax

---

```
                .-FULLvm-----.  
>>-VBACKUPTYPE---+--HYPERVFULL+----->><
```

**Windows**

## Parameters

---

### FULLvm

Specify this value to run a traditional full VM backup of a VMware virtual machine. This is the default backup type for Windows clients that run on Windows server systems, where the Hyper-V server role is not enabled. Contrast with `vmbackuptype=hypervfull`.

### HYPERVFULL

Specifies that you are backing up one or more Hyper-V virtual machines. If you enable the Hyper-V server role, this value is the default backup type. If you specify `vmbackuptype=hypervfull`, all of the options that are associated with backing up VMware files from a vStorage backup server are ignored (for example: VMCHOST, VMCUSER, VMCPW, VMFULLNODELETE).

## Examples

---

### Options file:

```
VBACKUPT full
```

### Command line:

```
Linux | Windows dsmc backup vm vm1 -VBACKUPT=full -vmchost=virtctr -vmcuser=virtctr_admin -  
vmcpw=xxxxxx
```

Performs a full virtual-machine backup of `vm1.example.com` using the VMware VirtualCenter machine `virtctr.example.com`, to the IBM Spectrum Protect server, using machine name `vm1`.

```
Windows dsmc backup vm -VBACKUPT=hypervfull -vmlist="VM 1,VM 2"
```

Performs a full virtual-machine backup of Hyper-V virtual machines named "VM 1" and "VM 2", to the IBM Spectrum Protect server.

**Linux** | **Windows**

## Vmchost

---

Use the `vmchost` option with the backup VM, restore VM, or query VM commands to specify the host name of the VMware VirtualCenter or ESX server that you want to backup, restore, or query.

Use the VirtualCenter if it is available. If you cannot use a VirtualCenter server and you need to perform backups of multiple systems on multiple ESX servers, do not specify this option, but instead specify the option with the command so that it can be

varied for each ESX server.

 This feature is available only if the client operates as a data mover for IBM Spectrum Protect™ for Virtual Environments: Data Protection for VMware.

## Supported Clients

---

This command is valid for clients that are configured to perform an off-host backup of a VMware virtual machine. The server can also define this option.

**Windows** This option is not supported for Hyper-V backups.

## Options File

---

**Windows** Place this option in the client options file (dsm.opt), or on the command line.

**Linux** Place this option in the client options file (dsm.opt), the client system options file (dsm.sys), or on the command line.

## Syntax

---

```
>>-VMCHost-- --hostname-----><
```

## Parameters

---

hostname

Specifies the host name of the VMware VirtualCenter or ESX server that you want to backup, restore, or query.

## Examples

---

Options file:

```
VMCH vcenter.storage.usca.example.com
```

Command line:

```
-VMCH=esx1.storage.usca.example.com
```

**Linux** | **Windows**

## Vmcpw

---

Use the vmcpw option with the backup VM, restore VM, or query VM commands to specify the password for the VMware VirtualCenter or the ESX user ID that is specified with the vmcuser option.

Use the VirtualCenter if it is available. If you cannot use a VirtualCenter server and you need to perform backups of multiple systems on multiple ESX servers, do not specify this option, but instead specify the option with the command so that it can be varied for each ESX server.

 This feature is available only if the client operates as a data mover for IBM Spectrum Protect™ for Virtual Environments: Data Protection for VMware.

## Supported Clients

---

**Linux** This option is valid only on supported Linux clients that are installed on a vStorage backup server that is used to backup a VMware virtual machine.

**Windows** This option is valid only on supported Windows clients that are installed on a vStorage backup server that is used to backup a VMware virtual machine. This option is not valid for Hyper-V backups.

## Options File

---

**Windows** Place this option in the client options file (dsm.opt), or on the command line.

**Linux** Place this option in the client system options file (dsm.sys), or on the command line.

1. Click Edit > Client Preferences > VM Backup. In the Password field, type the password that you want to have saved.
2. Click OK.

As an alternative to the preferences editor, you can store the password locally by using the set password command. For example:

```
dsmc SET PASSWORD -type=vm  
vcenter.us.ibm.com Administrator secret
```

## Syntax

---

```
>>-VMCPw-- --pwname-----><
```

## Parameters

---

pwname

Specifies the password for the VMware VirtualCenter or ESX server that you want to backup, restore, or query.

## Examples

---

Options file:

```
VMCPw SECRET
```

Command line:

```
-VMCPw=SECRET
```

**Related reference:**

Set Password

**Linux** | **Windows**

## Vmctlmc

---

This option specifies the management class to use when backing up virtual machine control files.

 This feature is available only if the client operates as a data mover for IBM Spectrum Protect™ for Virtual Environments.

By default, virtual machine control files are bound to the default management class. The vmmc option can be used to specify a different management class to which virtual machine data and virtual machine control files are bound. The vmctlmc option overrides the default management class and the vmmc option for the virtual machine control files.

Under certain conditions, it might be desirable or necessary to bind the control files to a different management class than the data files.

The vmctlmc option is required if virtual machine data files are backed up to tape. Virtual machine control files must be backed up to a disk-based storage pool that does not migrate to tape. The storage pool can be composed of random access volumes and sequential file volumes; the storage pool can also be a deduplicated pool. Use the vmctlmc option to specify a management class that stores data in such a storage pool.

Restriction: The management class that is specified by the vmctlmc option determines only the destination storage pool for virtual machine control files. Retention of the control files is determined by the vmmc option, if specified, or by the default management class. The retention for the virtual machine control files always matches the retention of the virtual machine data files.

## Supported Clients

---

**Linux** | **Windows** This option is valid for clients that act as data mover nodes that protect VMware virtual machines.

**Windows** This option is valid for clients that act as data mover nodes that protect Microsoft Hyper-V virtual machines.

The option can only be used for virtual machine backups that use an incremental-forever backup mode.

This option is available only if you have a license to use either IBM Spectrum Protect for Virtual Environments: Data Protection for VMware or IBM Spectrum Protect for Virtual Environments: Data Protection for Microsoft Hyper-V.

## Options File

---

**Linux** Place this option in the system options file dsm.sys.

**Windows** Place this option in the client options file dsm.opt.

## Syntax

---

```
>>-VMCTLmc--class_name-----<<
```

## Parameters

---

class\_name

Specifies a management class that applies to backing up virtual machine control files. If you do not set this option, the management class that is specified on the vmc option is used. If you do not set this option and the vmc option is not set, the default management class of the node is used.

## Examples

---

Options file:

```
vmctlmc diskonlymc
```

Command line:

Does not apply.

**Linux** | **Windows**

## Vmcuser

---

Use the vmcuser option with the backup VM, restore VM, or query VM commands to specify the user name of the VMware VirtualCenter or ESX server that you want to backup, restore, or query.

Use the VirtualCenter if it is available. If you cannot use a VirtualCenter server and you need to perform backups of multiple systems on multiple ESX servers, do not specify this option, but instead specify the option with the command so that it can be varied for each ESX server.

 This feature is available only if the client operates as a data mover for IBM Spectrum Protect™ for Virtual Environments: Data Protection for VMware.

## Supported Clients

---

This option is valid for clients that are configured as to perform an off-host backup of VMware virtual machines. The server can also define this option.

**Windows** This option is not valid for Hyper-V backups.

## Options File

---

**Windows** Place this option in the client options file (dsm.opt), or on the command line.

**Linux** Place this option in the client options file (dsm.opt), the client system options file (dsm.sys), or on the command line.

## Syntax

---

```
>>-VMCUser-- --username-----<<
```

## Parameters

---

username

Specifies the user name of the VMware VirtualCenter or ESX server that you want to backup, restore, or query.

When working with a virtual center, a user id with access to the Windows system hosting the virtual center is required. This user id must either have administrator privileges, or the minimum privileges that are identified in technote 1659544.

## Examples

---

Options file:

```
VMCUser administrator
```

Command line:

```
backup vm -VMCUser=domainname\administrator
```

Command line:

Example of connecting to an ESX server:

```
backup vm -VMCUser=root
```

Linux Windows

## Vmdatstorethreshold

---

Use the `vmdatstorethreshold` option to set the threshold percentage of space usage for each VMware datastore of a virtual machine.

When you specify this option, space usage is checked before a virtual machine snapshot is created. If the threshold is exceeded, the virtual machine is not backed up. By setting this option, you can prevent out-of-space errors when you back up virtual machines.

 This feature is available only if the client operates as a data mover for IBM Spectrum Protect™ for Virtual Environments: Data Protection for VMware.

## Supported clients

---

**Linux** You can use this option with supported x86\_64 Linux clients.

**Windows** You can use this option with supported Windows 64-bit clients.

## Options file

---

**Linux** You can specify this option in the client system-options file (`dsm.sys`) or on the command line by using the `backup vm` command. You can also include this option on the IBM Spectrum Protect Version 7.1.5 or later server in a client option set. You cannot set this option in the Preferences Editor.

**Windows** You can specify this option in the client options file (`dsm.opt`) or on the command line by using the `backup vm` command. You can also include this option on the IBM Spectrum Protect Version 7.1.5 or later server in a client option set. You cannot set this option in the Preferences Editor.

## Syntax

---

```
>>-VMDATASTOREThreshold---percent-----><
```

## Parameters

---

*percent*

Specifies the threshold percentage of each VMware datastore of the virtual machine to be backed up. You can specify an integer from 0 - 100. The default value is 100. If you do not set this option, the client begins a virtual machine backup without first verifying the existing space usage.

Requirements:

- Ensure that the threshold is low enough so that the snapshot does not use up all the available space in the VMware datastores. Otherwise, you will run out of space on the VMware datastores and the snapshot will not be created.
- If you use multiple clients that act as data mover nodes, you must add this option to the options file for each data mover.

- The client checks the data usage of the VMware datastore that contains the virtual machine disk snapshots. By default, the snapshots are created in the same directory as that of the parent virtual disk (.vmdk) file.

If you change the snapshot location to a new directory on the same datastore or on another datastore with the `workingDir` option in the VM configuration file, ensure that the path of the working directory is correct. If the path is incorrect, the client might validate the data usage of the wrong datastore.

If you use the `EXCLUDE.VMDISK` option to exclude one or more disks from a backup, the threshold check is still run on these disks. Even though these disks are not backed up, VMware still takes a snapshot of these disks.

Independent disks are not checked during space verification processing because a snapshot of these disks does not use any VMware datastore space.

## Example 1

---

Virtual machine `vm1` spans `datastore1` and `datastore2`. Set the `vmdatastorethreshold` option to 90 to ensure that both VMware datastores are at most 90% full before the virtual machine is backed up.

Options file:

```
vmdatastorethreshold 90
```

Command line:

```
dsmc backup vm vm1 -vmdatastorethreshold=90
```

## Example 2

---

The datastore threshold of `datastore2` is set to 85. The datastore threshold is exceeded during the backup of virtual machine `vm5`. The following error message is displayed:

```
ANSI14200E The virtual machine 'vm5' could not be backed up because the data usage of datastore 'datastore2' exceeded the datastore threshold of 85%.
```

Increase the value of the `vmdatastorethreshold` option to 95 and restart the backup.

Options file:

```
vmdatastorethreshold 95
```

Command line:

```
dsmc backup vm vm5 -vmdatastorethreshold=95
```

**Related reference:**

Backup VM

Linux | Windows

## Vmdefaultvportgroup

---

Use this option to specify the port group for the NICs to use during restore vm operations for a virtual machine that was connected to a distributed virtual port group when it was backed up, but the target host for the restore operation does not contain a similar distributed virtual port group.

 This feature is available only if the client operates as a data mover for IBM Spectrum Protect™ for Virtual Environments: Data Protection for VMware.

This option does not apply to backup or restore operations for Microsoft Hyper-V virtual machines.

## Supported clients

---

**Linux** This option is valid for Linux clients that are installed on a vStorage backup server.

**Windows** This option is valid for Windows clients that are installed on a vStorage backup server.

## Options file

---

**Linux** Place this option in the client options file (`dsm.opt`), in the client system options file (`dsm.sys`), or specify it as a command-line parameter on the `restore vm` command.



**Windows** Place this option in the client options file (dsm.opt), or specify it as a command-line parameter on the restore vm command.

## Syntax

---

```
>>-VMDEFAULTDVPORTGROUP--portgroup_name-----><
```

## Parameters

---

*portgroup name*

Specifies the name of the port group to use. The port group name is case sensitive.

## Examples

---

Option file:

```
VMDEFAULTDVPORTGROUP dvPortGroup
```

Command line:

```
dsmc restore vm vm123 -VMDEFAULTDVPORTGROUP=dvPortGroup
```

### Related reference:

Vmdefaultnetwork

Vmdefaultdvswitch

**Linux**

**Windows**

## Vmdefaultdvswitch

---

Use this option to specify the distributed virtual switch (dvSwitch) that contains the port group that you set on the vmdefaultdvportgroup option. The option has no effect unless you also specify the vmdefaultdvportgroup option.

 This feature is available only if the client operates as a data mover for IBM Spectrum Protect™ for Virtual Environments: Data Protection for VMware.

This option does not apply to backup or restore operations for Microsoft Hyper-V virtual machines.

## Supported clients

---

**Linux**

This option is valid for Linux clients that are installed on a vStorage backup server.

**Windows**

This option is valid for Windows clients that are installed on a vStorage backup server.

## Options file

---

**Linux**

Place this option in the client options file (dsm.opt), in the client system options file (dsm.sys), or specify it as a command-line parameter on the restore vm command.

**Windows**

Place this option in the client options file (dsm.opt), or specify it as a command-line parameter on the restore vm command.

## Syntax

---

```
>>-VMDEFAULTDVSWITCH--dvSwitch-----><
```

## Parameters

---

*dvSwitch*

Specifies the name of the virtual switch to use. The virtual switch name is case sensitive.

## Examples

---

Option file:

```
VMDEFAULTDVSWITCH dvSwitch
```

Command line:

```
dsmc restore vm vm123 -VMDEFAULTDVSWITCH=dvSwitch -VMDEFAULTDVPORTGROUP=dvPortGroup
```

**Related reference:**

Vmdefaultdvportgroup

Linux Windows

## Vmdefaultnetwork

---

Use this option to specify the network for NICs to use during a restore vm operation, for a virtual machine that had been connected to a distributed virtual port group when it was backed up, but the target host for the restore operation does not have any distributed switch port groups configured.

 This feature is available only if the client operates as a data mover for IBM Spectrum Protect™ for Virtual Environments: Data Protection for VMware.

This option does not apply to restore operations for Microsoft Hyper-V virtual machines.

## Supported clients

---

Linux This option is valid for Linux clients that are installed on a vStorage backup server.

Windows This option is valid for Windows clients that are installed on a vStorage backup server.

## Options file

---

Linux Place this option in the client options file (dsm.opt), in the client system options file (dsm.sys), or specify it as a command-line parameter on the restore vm command.

Windows Place this option in the client options file (dsm.opt), or specify it as a command-line parameter on the restore vm command.

## Syntax

---

```
>>-VMDEFAULTNETWORK--vm_network_name-----<<
```

## Parameters

---

*vm\_network\_name*

Specifies the name of the virtual machine network to use. The network name is case sensitive. If the name contains space characters, enclose it in quotation marks.

## Examples

---

Option file:

```
VMDEFAULTNETWORK "VM Network"
```

Command line:

```
dsmc restore vm vm123 -VMDEFAULTNETWORK="VM Network"
```

**Related reference:**

Vmdefaultdvportgroup

Vmdefaultdvswitch

Windows

## Vmdiskprovision

---

Use the `vmdiskprovision` option to specify a provisioning policy for the virtual disk file that is used to restore VMware virtual machine data. This option is valid only for restore vm operations where `vmrestoretype=instantrestore` is specified.

This option is only valid for VMware virtual machines. The virtual machines must be hosted on VMware ESXi 5.1 servers, or later versions. To use this option, you must have a license agreement to use IBM Spectrum Protect™ for Virtual Environments: Data Protection for VMware.

### Supported Clients

---

**Windows** This option can be used with supported Windows clients.

### Options file

---

Place this option in the client options file (`dsm.opt`), or on the command line.

### Syntax

---

```
.-THICK-.
>>-VMDISKPROvision--+-----+----->>
'-THIN--'
```

### Parameters

---

#### THICK

Creates a virtual disk in a default thick format; where the space that is required for the virtual disk is allocated when the virtual disk is created. This setting is the default value.

#### THIN

Creates a virtual disk in a thin format.

**Note:** If you are restoring a virtual machine and you specify thin provisioning, the datastore that you restore the VM to must have enough free space to accommodate the total capacity of the VM disk, and not just the amount of disk that is used. For example, if a thin-provisioned VM has 300 GB total capacity for its disk, you cannot restore that VM to a datastore that has less than 300 GB available, even if only a portion of the total capacity is being used.

### Examples

---

#### Options file:

```
VMDISKPROvision THIN
```

#### Command line:

```
dsmc restore vm Mainz -VMRESToretype=INSTANTRestore
-VMTEMPDatastore=Temporary_Datastore -VMDISKPROvision=THIN
```

**Linux** | **Windows**

## Vmenabletemplatebackups

---

The `vmenabletemplatebackups` option specifies whether the client backs up VMware template virtual machines when it protects virtual machines in a vCenter server. VMware templates virtual machines cannot be backed up when they are in an ESXi host because ESXi does not support templates.

When this option is enabled, you can include VMware template machines in full VM backup operations. You use the existing Backup VM command and the `DOMAIN.VMFULL` option to specify the virtual machines to include in the backup operation.

 This feature is available only if the client operates as a data mover for IBM Spectrum Protect™ for Virtual Environments: Data Protection for VMware.

Incremental backups are not supported and snapshots are not taken, so you must use `MODE=IFFULL`. Use `MODE=IFFULL` to force a new backup of VMware template virtual machines, even if they were not changed since the last backup.

When `vmenabletemplatebackups` is enabled, any backup process that is initiated by using `MODE=INCREMENTAL` is processed by using `MODE=IFFULL`. VMware template VMs are included in a backup only if they were changed since the last backup occurred.

With this option enabled, make sure that the `vmvstortransport` options include `NBDSSL` or `NBD`. Using only the `SAN` or `HOTADD` transport modes with this option enabled causes backups of the template machines to fail.

## Supported clients

---

**Linux** This option can be used with supported x86\_64 Linux clients.

**Windows** This option can be used with supported Windows clients.

## Options file

---

**Linux** You can set this option on the command line, in the client system options file (`dsm.sys`), client options file (`dsm.opt`), or on the server in a client options set.

**Windows** You can set this option on the command line, in the client options file (`dsm.opt`), or on the server in a client options set.

**Linux** | **Windows** You can also set it in the preferences editor on the VM Backup tab (select the Backup virtual machine templates option).

## Syntax

---

```
                .-No-----.  
>>-VMENABLETEMPlatebackups--++-----++----->>  
                '-Yes-'
```

## Parameters

---

- No**  
Specifies that template virtual machines are not included in full VM backup operations; this is the default setting.
- Yes**  
Specifies that template VMs are included in full VM backup operations.

## Examples

---

### Options file

```
vmenabletemplatebackups yes
```

### Command line

Back up a VMware template VM

```
dsmc backup vm vmname -VMENABLETEMPLATEBACKUPS=YES
```

where *vmname* is the template machine name.

### Command line

Restore a VMware template VM to the same location and name

```
dsmc restore vm vmname -VMENABLETEMPLATEBACKUPS=YES
```

where *vmname* is the template machine name.

### Command line

Restore a template virtual machine to a new location

```
dsmc restore vm vmname -vmname=win7x64  
-datastore=datastore22 -host=supersht.labx.com  
-datacenter="Lab Center" -VMENABLETEMPLATEBACKUPS=YES
```

where *vmname* is the template machine name. "win7x64" is the new template VM name. The new data center, host, and datastore are also included.

### Related reference:

- Backup VM
- Restore VM

## Vmexpireprotect

---

Use this option to protect virtual machine snapshots so that they cannot be expired while an instant restore or instant access operation of VMware VMs or while a file-level restore of a VMware VM is in progress. Use this option to protect virtual machine snapshots so that they cannot be expired while an instant restore or instant access operation of Hyper-V VMs or while a file-level restore of a Hyper-V VM is in progress.

During a mount or restore operation, the snapshot on the IBM Spectrum Protect™ server is locked to prevent it from expiring during the operation. Expiration might occur because another snapshot is added to the snapshot sequence. This option specifies whether to prevent or allow snapshot expiration during a mount or a restore operation.

### Supported Clients

---

**Windows** This option can be used with supported Windows clients that are configured to restore virtual machines.

 This feature is available only if the client operates as a data mover for IBM Spectrum Protect for Virtual Environments.

### Options File

---

For restoring VMware virtual machines, set this option in the client options file (dsm.opt) or on a restore vm command where the vmrestoretype option is set to instantaccess or instantrestore.

For restoring file-level backups for virtual machines, specify this option in the client options file, or on the restore vm command.

Note: File-level backups were created with the version 7.1 or earlier backup-archive clients.

### Syntax

---

```
.-No--.  
>>-VMEXPIREPROTECT---+-Yes+-----<<
```

### Parameters

---

#### Yes

Specify Yes to protect the snapshot from expiration. The snapshot on the IBM Spectrum Protect server is locked and the snapshot is protected from expiration during a mount or a restore operation.

#### No

Specify No to disable expiration protection. This value is the default. The snapshot on the IBM Spectrum Protect server is not locked and the snapshot is not protected from expiration. If the snapshot that is being mounted or restored is expired, the result of the mount or restore operation is unpredictable. For example, the mount point can become unusable or contain errors. However, expiration does not affect the current active copy of the virtual machine. The active copy cannot expire during an operation.

When the snapshot is on a target replication server, the snapshot cannot be locked because it is in read-only mode. A lock attempt by the server causes the mount or restore operation to fail.

To avoid the lock attempt and prevent such a failure, disable expiration protection by specifying No, or by allowing this option to default.

### Examples

---

Client options file:

```
VMEXPIREPROTECT YES
```

Command line:

Run an instant access operation for a VMware virtual machine:

```
dsmc restore vm vml -vmname=new_vml -vmrestoretype=instantaccess  
-vmexpireprotect=no
```

To restore files from a virtual machine backup, use the IBM Spectrum Protect recovery agent GUI.

For information about the IBM Spectrum Protect recovery agent, see the IBM Spectrum Protect for Virtual Environments documentation.

Windows

## Vmiscsiadapter

---

This option specifies which iSCSI adapter, on the ESX host, to use for instant restore and instant access operations for VMware virtual machines.

### Supported Clients

---

This option is valid for 64-bit Windows clients that are configured as data movers that backup VMware virtual machines.

### Options File

---

Set this option in the client options file (dsm.opt). You can also specify this option as a command-line parameter on the restore vm command that initiates an instant restore or instant access operation. To use this option, you must have a license agreement to use IBM Spectrum Protect™ for Virtual Environments: Data Protection for VMware.

### Syntax

---

```
>>-VMISCSIAdapter---iSCSI_adapter_name-----><
```

iSCSI\_adapter\_name

Specifies the name of the iSCSI adapter to connect to on the ESX host. If you do not specify this option, the first iSCSI adapter that is found on the host is used.

### Examples

---

Options file:

```
vmiscsiadapter "vmhba36"
```

Command line:

```
dsmc restore vm "Haifa" -VMRESToretype=INSTANTAccess -vmname="Haifa_verify" -  
VMISCSIAdapter="vmhba36"
```

Windows

## Vmiscsiserveraddress

---

Use the vmiscsiserveraddress option with the restore VM command to specify the host name or the IP address of the iSCSI server that provides the iSCSI targets for instant restore and instant access operations.

The vmiscsiserveraddress option is valid for all instant operations (vmrestoretype=instantaccess and vmrestoretype=instantrestore) for VMware virtual machines.

The virtual machines must be hosted on VMware ESXi 5.1 servers, or later versions. To use this option, you must have a license agreement to use IBM Spectrum Protect™ for Virtual Environments: Data Protection for VMware.

### Supported Clients

---

Windows

This option can be used with supported Windows clients.

### Options file

---

Place this option in the client options file (dsm.opt), or on the command line.

### Syntax

---

```
>>-VMISCSIserveraddress-- --iSCSI serverhost name or IP address-><
```

## Parameters

---

iSCSI serverhost name or IP address

Specify the host name or IP address of the iSCSI server that supplies the iSCSI target disks. This iSCSI server must connect the data mover machine with all of the ESX hosts that are used for instant restore operations. If `vmiscsiserveraddress` is not specified, the host name or IP address of the data mover machine is used.

For instant restore operations, the IP address of the network card in the data mover machine that is used for the iSCSI transfer should be in the same subnet as the iSCSI adapter on the ESX host.

For file restore mount operations, the Windows and Linux mount proxy systems must be in the same network range.

## Examples

---

Options file:

```
VMISCSIserveraddress 192.168.42.50
```

Command line:

```
dsmc restore vm Oslo -VMRESToretype=INSTANTAccess -vmname=Oslo_verify  
-VMISCSIserveraddress=odin.oslo.no.xyzco.com
```

Linux | Windows

## Vmlimitperdatastore

---

The `vmlimitperdatastore` option specifies the number of virtual machines (VMs) and virtual disks in a datastore that can be processed in parallel during an optimized backup operation.

An optimized backup operation is one in which parallel backup capability is enabled at the VM, virtual disk, or subdisk level.

The `vmlimitperdatastore` option works with the `vmmaxparallel`, `vmmaxbackupsessions`, and `vmlimitperhost` options to optimize backup operations and to help control the amount of resources that the backup can create on a host in the vSphere infrastructure. Adjust the values of these options to find the values that provide optimal performance for the backups that are in your environment.

 This feature is available only if the client operates as a data mover for IBM Spectrum Protect™ for Virtual Environments: Data Protection for VMware.

## Supported clients

---

**Linux** This option can be used with supported x86\_64 Linux clients.

**Windows** This option can be used with supported Windows clients. This option is not valid for Data Protection for Microsoft Hyper-V backups.

## Options file

---

**Linux** This option is valid in the client system options file (`dsm.sys`), in the client options file (`dsm.opt`) or on the command line for Backup VM. It can also be included on the server in a client options set. It cannot be set in the Preferences Editor.

**Windows** This option is valid in the client options file (`dsm.opt`) or on the command line for Backup VM. It can also be included on the server in a client options set. It cannot be set in the Preferences Editor.

## Syntax

---

```
>>-VMLIMITPERDatastore-- .-0-----  
                        +-+-----+-----><  
                        '-integer-'
```

## Parameters

---

*integer*

Specifies the maximum number of VMs in any one datastore that are included during an optimized backup operation. The maximum that you can specify is 50 VMs. The default is 0 (zero).

Specifying 0 means that you are not concerned about how many VMs can be backed up in parallel from a datastore.

Instead, you want to limit the maximum number of VMs to include in a backup by using the value that you specify on the `vmmxparallel` option. The `vmlimitperdatastore` option is enforced even when VM data exists in two or more datastores.

## Examples

---

Options file

```
VMLIMITPERD 5
```

Command line:

```
dsmc backup vm -VMLIMITPERD=5
```

### Related reference:

Backup VM

Domain.vmfull

Vmmxbackupsessions

Vmmxparallel

Vmlimitperhost

### Related information:

[Backing up multiple virtual machines in parallel](#)

Linux

Windows

## Vmlimitperhost

---

The `vmlimitperhost` option specifies the number of virtual machines (VMs) and virtual disks in a host that can be processed in parallel during an optimized backup operation.

An optimized backup operation is one in which parallel backup capability is enabled at the VM, virtual disk, or subdisk level.

The `vmlimitperhost` option works with the `vmmxparallel`, `vmmxbackupsessions`, and `vmlimitperdatastore` options to optimize backup operations and to help control the amount of resources that the backup can create on a host in the vSphere infrastructure. Adjust the values of these options to find the values that provide optimal performance for the backups that are in your environment.

 This feature is available only if the client operates as a data mover for IBM Spectrum Protect™ for Virtual Environments: Data Protection for VMware.

## Supported clients

---

Linux

This option can be used with supported x86\_64 Linux clients.

Windows

This option can be used with supported Windows clients. This option is not valid for Data Protection for Microsoft Hyper-V backups.

## Options file

---

Linux

This option is valid in the client system options file (`dsm.sys`), in the client options file (`dsm.opt`) or on the command line for Backup VM. It can also be included on the server in a client options set. It cannot be set in the Preferences Editor.

Windows

This option is valid in the client options file (`dsm.opt`) or on the command line for Backup VM. It can also be included on the server in a client options set. It cannot be set in the Preferences Editor.

## Syntax

---

```
>>-VMLIMITPERHost-- .-0-----<
                    --++-----++-----<
                    '-integer-'
```

## Parameters

---



*integer*

Specifies the maximum number of VMs in any one ESX server that can be included in an optimized backup operation. The maximum that you can specify is 50 VMs. The default is 0 (zero).

Specifying 0 means that you are not concerned about how many VMs can be backed up in parallel from an ESX server. Instead, you want to limit the maximum number of VMs to include in a backup by using the limit that you specify on the `vmmaxparallel` option.

## Examples

---

Options file

```
VMLIMITPERH 5
```

Command line:

```
dsmc backup vm -VMLIMITPERH=5
```

### Related reference:

Backup VM

Domain.vmfull

Vmmaxparallel

Vmlimitperhost

### Related information:

 [Backing up multiple virtual machines in parallel](#)

Windows

## Vmlist

---

The `vmlist` option is deprecated for Hyper-V backup operations. To specify one or more Hyper-V virtual machines (VMs) to include in Data Protection for Microsoft Hyper-V backup operations, use the `domain.vmfull` option or specify the VMs when you run the `backup vm` command.

If you need to use the `vmlist` option, see the documentation in previous releases of IBM Spectrum Protect™.

### Related reference:

Domain.vmfull

Backup VM

Linux

Windows

## Vmmaxbackupsessions

---

The `vmmaxbackupsessions` option specifies the maximum number IBM Spectrum Protect™ server sessions that move virtual machine (VM) data to the server that can be included in an optimized backup operation.

An optimized backup operation is one in which parallel backup capability is enabled at the VM, virtual disk, or subdisk level.

The `vmmaxbackupsessions` option works with the `vmmaxparallel`, `vmlimitperdatastore`, and `vmlimitperhost` options to optimize backup operations and to help control the amount of resources that the backup can create on a host in the vSphere infrastructure. Adjust the values of these options to find the values that provide optimal performance for the backups that are in your environment.

## Supported clients

---

 This feature is available only if the client operates as a data mover for IBM Spectrum Protect for Virtual Environments: Data Protection for VMware.

Linux

This option can be used with supported x86\_64 Linux clients.

Windows

This option can be used with supported Windows clients. This option is not valid for Data Protection for Microsoft Hyper-V backups.

## Options file

---

Linux

This option is valid in the client system options file (`dsm.sys`), in the client options file (`dsm.opt`), or on the command line for Backup VM. It can also be included on the server in a client options set. It cannot be set in the Preferences Editor.

**Windows** This option is valid in the client options file (dsm.opt) or on the command line for Backup VM. It can also be included on the server in a client options set. It cannot be set in the Preferences Editor.

## Syntax

---

```
.-vmmaxparallelvalue-.  
>>-VMMAXBACKUPSEssions-- --+-----+-----><  
'-integer-'
```

## Parameters

---

### *integer*

Specifies the maximum number of IBM Spectrum Protect server sessions that can be created during the backup operation.

Review the following information for using the `vmmaxbackupsessions` option along with the `vmmaxparallel` option or the `maxnummp` server parameter:

### `vmmaxparallel`

The `vmmaxparallel` option specifies the maximum number of virtual machines that can be backed up to the IBM Spectrum Protect server at any one time. The value of the `vmmaxbackupsessions` option must be equal to or greater than the value of the `vmmaxparallel` option.

If the value is less than the value of the `vmmaxparallel` option, the following message is returned and the value is changed to the same value as the `vmmaxparallel` option:

```
ANS9995W The value of the VMMAXBACKUPSESSIONS option is number_value. This value must be  
greater than or equal to the value of the VMMAXPARALLEL option, which is number_value.  
The value will be set to the value of the VMMAXPARALLEL option.
```

### `maxnummp`

The `maxnummp` server parameter specifies the maximum number of mount points a node is allowed to use on the server when the copy destination of the storage pool is FILE or TAPE. The `maxnummp` parameter must be equal to or greater than the `vmmaxparallel` and `vmmaxbackupsessions` option settings. When multiple instances of the client are backing up files, or when a single client performs parallel backups, more mount points might be needed.

If the values for `vmmaxparallel` or `vmmaxbackupsessions` exceed the value for `maxnummp`, ANS0266I and other messages are displayed. Depending on the message, the client reduces the value of the `vmmaxparallel` option to match the number that is specified by `maxnummp` parameter or prohibits additional sessions from being opened for the specified VM. In either situation, the backup operation continues.

If additional ANS0266I errors are detected, the client reduces the `vmmaxparallel` value by 1 and attempts to continue the backup. If `vmmaxparallel` is decremented to 1 and the client receives more ANS0266I errors, the client ends the backup and issues the following error:

```
ANS5228E A backup VM operation failed because VMMAXPARALLEL was reduced to 1 and the  
client still cannot obtain a server mount point.
```

Contact your server administrator if you want the value that is currently set for `maxnummp` increased so your node can support additional parallel backup sessions.

On Windows Server 2012 and 2012 R2, during Hyper-V virtual machine backups, IBM Spectrum Protect creates VSS snapshots of all volumes that contain virtual machine data. Backup data is read from the VSS snapshots, and not from data that is on the live file system. In many cases, when IBM Spectrum Protect attempts to create several snapshots concurrently, the VSS software provider might fail to satisfy a snapshot request for several virtual machines. The failures occur because the VSS software snapshot provider can not handle the load that is created by several backups that are attempted in parallel. To avoid this issue, use a VSS hardware snapshot provider instead of a VSS software provider.

The maximum that you can specify is 100 sessions. The default is the value that is set for the `vmmaxparallel` option.

## Examples

---

### Options file

```
VMMAXBACKUPS 10
```

### Command line:

```
dsmc backup vm -VMMAXBACKUPS=10
```

### Related reference:

Backup VM

Domain.vmfull  
Vmmaxparallel  
Vmlimitperdatastore  
Vmlimitperhost

**Related information:**

 [Backing up multiple virtual machines in parallel](#)

[Linux](#) | [Windows](#)

## Vmmaxparallel

---

The vmmaxparallel option is used to configure optimized backups of several virtual machines by using a single instance of the backup-archive client. This option specifies the maximum number of virtual machines that can be backed up to the IBM Spectrum Protect™ server at any one time.

An optimized backup operation is one in which parallel backup capability is enabled at the VM, virtual disk, or subdisk level.

The vmmaxparallel option works with the vmmaxbackupsessions, vmlimitperhost, and vmlimitperdatastore options to optimize backup operations and to help control the amount of resources that the backup can create on a host in the vSphere infrastructure. Adjust the values of these options to find the values that provide optimal performance for the backups that are in your environment.

 This feature is available only if the client operates as a data mover for IBM Spectrum Protect for Virtual Environments.

For Data Protection for Microsoft Hyper-V, this option is valid only for Hyper-V backup operations on Windows Server 2012 and 2012 R2 operating systems.

## Supported clients

---

[Linux](#) This option can be used with supported x86\_64 Linux clients.

[Windows](#) This option can be used with supported Windows clients.

## Options file

---

[Linux](#) This option is valid in the client system options file (dsm.sys) or on the command line for the Backup VM command. It can also be included on the server in a client options set. It cannot be set in the Preferences Editor.

[Windows](#) This option is valid in the client options file (dsm.opt) or on the command line for the Backup VM command. It can also be included on the server in a client options set. It cannot be set in the Preferences Editor.

## Syntax

---

```
.-4-----.  
>>-VMAXParallel--+-----+-----><  
                '-integer-'
```

## Parameters

---

### *integer*

Specifies the maximum number of virtual machines that can be backed up at any one time during an optimized backup operation. The default is 4. The maximum is 50.

Tip: When you use client-side data deduplication, a data deduplication session is started for each VM. This data deduplication session is not counted as one of the vmmaxparallel sessions.

Review the following information for using the vmmaxparallel option in conjunction with the vmmaxbackupsessions option or the maxnummp server parameter:

### vmmaxbackupsessions

The vmmaxbackupsessions specifies the maximum number of sessions that move virtual machine data to the server that can be included in an optimized backup operation. The value of the vmmaxbackupsessions option must be equal to or greater than the value of the vmmaxparallel option.

### maxnummp

The `maxnummp` server parameter specifies the maximum number of mount points a node is allowed to use on the server when the copy destination of the storage pool is FILE or TAPE. The `maxnummp` parameter must be equal to or greater than the `vmmaxparallel` and `vmmaxbackupsessions` option settings. When multiple instances of the client are backing up files, or when a single client performs parallel backups, more mount points might be needed. If the values for `vmmaxparallel` or `vmmaxbackupsessions` exceed the value for `maxnummp`, ANS0266I and other messages are displayed. Depending on the message, the client reduces the value of the `vmmaxparallel` option to match the number that is specified by `maxnummp` parameter or prohibits additional sessions from being opened for the specified VM. In either situation, the backup operation continues.

If additional ANS0266I errors are detected, the client reduces the `vmmaxparallel` value by 1 and attempts to continue the backup. If `vmmaxparallel` is decremented to 1 and the client receives more ANS0266I errors, the client ends the backup and issues the following error:

```
ANS5228E A backup VM operation failed because VMMAXPARALLEL was reduced to 1 and the client still cannot obtain a server mount point.
```

Contact your server administrator if you want the value that is currently set for `maxnummp` increased so your node can support additional parallel backup sessions.

On Windows Server 2012 and 2012 R2, during Hyper-V virtual machine backups, IBM Spectrum Protect creates VSS snapshots of all volumes that contain virtual machine data. Backup data is read from the VSS snapshots, and not from data that is on the live file system. In many cases, when IBM Spectrum Protect attempts to create several snapshots concurrently, the VSS software provider might fail to satisfy a snapshot request for several virtual machines. The failures occur because the VSS software snapshot provider can not handle the load that is created by several backups that are attempted in parallel. To avoid this issue, use a VSS hardware snapshot provider instead of a VSS software provider.

## Examples

---

Options file

```
VMMAXP 10
```

 Command line:

```
 dsmc backup vm -VMMAXP=10
```

### Related reference:

Backup VM

Domain.vmfull

Vmlimitperhost

Vmlimitperdatastore

### Related information:

 [Backing up multiple virtual machines in parallel](#)



## Vmmaxpersnapshot

---

Use the `vmmaxpersnapshot` option to specify the maximum number of virtual machines (VMs) to include in a Hyper-V snapshot. The VMs in the snapshot are backed up to the IBM Spectrum Protect™ server.

By increasing the number of VMs in a snapshot, you can reduce the number of snapshots that are taken for a backup operation. This capability reduces the scheduling contention that can be experienced during cluster backup operations of VMs on Clustered Shared Volumes (CSVs).

A snapshot with more VMs takes longer to complete and increases the load on the system. A larger number of VMs means that the snapshot persists longer, which can affect performance.

 This feature is available only if the client operates as a data mover for IBM Spectrum Protect for Virtual Environments: Data Protection for Microsoft Hyper-V.

This option is valid only for Hyper-V backup operations on Windows Server 2012 and 2012 R2 operating systems.

## Supported clients

---

This option is valid for all supported Windows clients. This option can also be defined on the server.

## Options file

---

This option is valid in the client options file (dsm.opt) or on the command line for the Backup VM command. It can also be included on the server in a client options set. It cannot be set in the Preferences Editor.

## Syntax

---

```
.-20-----.  
>>-VMMAXPERSnapshot--+-integer+-----<<
```

## Parameters

---

### *integer*

Specifies the maximum number of VMs that can be included in a Hyper-V snapshot. The default is 20. The maximum is 100. The minimum is 1.

If some VMs reside on local volumes and some VMs reside on Clustered Shared Volumes (CSVs), the number of VMs in a snapshot might be less than the `vmmaxpersnapshot` setting. A snapshot cannot contain a mixture of VMs on local and CSV volumes.

To avoid creating a snapshot that spans volumes, the number of VMs in a snapshot might be less than the maximum number if the VMs are on different volumes. For example, four VMs are on Volume A and one VM is on Volume B. A snapshot is taken with only four VMs (from Volume A) even though the maximum setting is five. A second snapshot is taken for Volume B.

## Examples

---

### Options file

```
vmmaxpersnapshot 10
```

### Command line

```
dsmc backup vm -vmmaxpers=10
```

### Related reference:

Vmmaxsnapshotretry

### Related information:

[Tuning scheduled VM backups for Windows Server 2012 and 2012 R2 clusters](#)

Linux Windows

## Vmmaxrestoresessions

---

The `vmmaxrestoresessions` option specifies the maximum number of IBM Spectrum Protect™ server sessions that can be included in an optimized restore operation for a virtual machine (VM).

A optimized restore operation is one in which parallel restore capability is enabled at the subdisk level of a virtual disk.

## Supported clients

---

**Linux** This option can be used with supported x86\_64 Linux clients.

**Windows** This option can be used with supported Windows clients. This option is not valid for Data Protection for Microsoft Hyper-V backups.

 This feature is available only if the client operates as a data mover for IBM Spectrum Protect for Virtual Environments: Data Protection for VMware.

## Options file

---

**Linux** This option is valid in the client system options file (dsm.sys), in the client options file (dsm.opt), or on the command line for Restore VM. It can also be included on the server in a client options set. It cannot be set in the Preferences Editor.

**Windows** This option is valid in the client options file (dsm.opt) or on the command line for Restore VM. It can also be included on the server in a client options set. It cannot be set in the Preferences Editor.

## Syntax

---

```
>>-VMAXRESTORESessions-- .-1-----.  
--++-----++-----><  
'-integer-'
```

## Parameters

---

*integer*

Specifies the number of IBM Spectrum Protect server sessions that are created during the restore operation. The default is 1.

## Examples

---

Options file

```
VMAXRESTORES 10
```

**Windows** Command line:

```
Windows dsmc restore vm -VMAXRESTORES=10
```

**Related reference:**

Restore VM

**Linux** | **Windows**

## Vmmaxrestoreparalleldisks

---

The `vmmaxrestoreparalleldisks` option enables an IBM Spectrum Protect™ client to restore multiple virtual disks at the same time.

You can specify the number of disk sessions to be opened, up to a maximum of 50. The number of disk restore sessions available is specified by the `vmmaxrestoresessions` option. Available sessions are allocated across the number of disk sessions specified by `vmmaxrestoreparalleldisks`, by rounding down the number of sessions per disk to the nearest whole number.

## Supported clients

---

**Linux** This option can be used with supported x86\_64 Linux clients.

**Windows** This option can be used with supported Windows clients. This option is not valid for Data Protection for Microsoft Hyper-V backups.

 This feature is available only if the client operates as a data mover for IBM Spectrum Protect for Virtual Environments: Data Protection for VMware.

## Options file

---

**Linux** This option is valid in the client system options file (`dsm.sys`), or on the command line for Restore VM. It can also be included on the server in a client options set. It cannot be set in the Preferences Editor.

**Windows** This option is valid in the client options file (`dsm.opt`) or on the command line for Restore VM. It can also be included on the server in a client options set. It cannot be set in the Preferences Editor.

## Syntax

---

```
>>-VMAXRESTOREPARALLELDisks-- .-1-----.  
--++-----++-----><  
'-integer-'
```

## Parameters

---

*integer*

Specifies the number of virtual hard disks that can be restored simultaneously. The default is 1. The maximum is 50.

## Examples

---

### Task

Set a maximum of 10 simultaneous restore operations for virtual disks in the VM vm1:

```
dsmc restore vm vm1 -vmmxrestoreparalleldisks=10 -vmmxrestoresessions=20
```

This will assign 2 simultaneous restore sessions per virtual disk.

### Related reference:

Restore VM

Windows

## Vmmxsnapshotretry

---

Use the `vmmxsnapshotretry` option to specify the maximum number of times to retry a snapshot operation of a virtual machine (VM) if the initial snapshot fails with a recoverable condition.

During a VM backup, if a snapshot of a VM fails due to a temporary condition, Data Protection for Microsoft Hyper-V automatically retries the snapshot operation up to the number of times that is specified by the `vmmxsnapshotretry` option. If the snapshot still fails after the maximum number of retries is reached, the snapshot operation for the VM is not retried and the backup attempt fails.

For example, a recoverable condition might be caused by two backup requests that started at about the same time, backing up VMs that reside on the same volume. One backup operation reports that the snapshot failed because the backup cannot be started while another backup is running for the same VM. In this case, Data Protection for Microsoft Hyper-V will retry the snapshot operation after the first VM backup is completed.

If the initial error is not recoverable, a snapshot is not attempted. For example, if an error occurs with the Volume Shadow Copy Services (VSS) writer during the initial snapshot process, the backup processing stops and Data Protection for Microsoft Hyper-V does not retry the snapshot operation.

 This feature is available only if the client operates as a data mover for IBM Spectrum Protect™ for Virtual Environments: Data Protection for Microsoft Hyper-V.

This option is valid only for Hyper-V backup operations on Windows Server 2012 and 2012 R2 operating systems.

## Supported clients

---

This option is valid for all supported Windows clients. This option can also be defined on the server.

## Options file

---

This option is valid in the client options file (`dsm.opt`) or on the command line for the Backup VM command. It can also be included on the server in a client option set. It cannot be set in the Preferences Editor.

## Syntax

---

```
..-20-----.  
>>-VMMXSNAPSHOTretry--+integer+-----<<
```

## Parameters

---

### *integer*

Specifies the maximum number of times to retry the snapshot operation of a VM if the initial snapshot attempt fails with a recoverable condition. The default is 20. The maximum is 30. The minimum is 1.

For example, if the `vmmxsnapshotretry` option is set to 12, Data Protection for Microsoft Hyper-V retries the snapshot operation up to 12 times after the initial snapshot failed during a VM backup operation. If the snapshot still fails after 12 retries are reached, no more retries are attempted, and the backup attempt fails.

At least 10 minutes must elapse before the next snapshot retry attempt. The time between attempts will be longer when the failed VM is part of a snapshot with VMs that are currently being backed up. The backup operation of the other VMs must be completed and the snapshot is removed by the backup operation before a retry attempt can be made.

## Examples

---

### Options file

```
vmmaxsna 12
```

### Command line

```
dsmc backup vm -vmmaxsna=12
```

### Related reference:

Vmmaxpersnapshot

### Related information:

[Tuning scheduled VM backups for Windows Server 2012 and 2012 R2 clusters](#)

Linux

Windows

## Vmmaxvirtualdisks

---

The vmmaxvirtualdisks option specifies the maximum size of the VMware virtual machine disks (VMDKs) to include in a backup operation.

 This feature is available only if the client operates as a data mover for IBM Spectrum Protect™ for Virtual Environments: Data Protection for VMware.

Use the vmmaxvirtualdisks option with the vmskipmaxvirtualdisks option to specify how the client processes large VMDKs during a backup operation:

- Set the vmmaxvirtualdisks option to specify the maximum size of the VMDKs to include.
- Set the vmskipmaxvirtualdisks option to back up the VMDKs that do not exceed the maximum size (and exclude any VMDKs that exceed the size), or fail the operation.

## Supported clients

---

Linux

This option is valid for 64-bit Linux clients that are configured as data movers that back up VMware virtual machines.

Windows

This option is valid for 64-bit Windows clients that are configured as data movers that back up VMware virtual machines.

## Options file

---

Linux

Set the vmmaxvirtualdisks option in the client system options file (dsm.sys). You can also specify this option as a command-line parameter on the backup vm command.

Windows

Set the vmmaxvirtualdisks option in the client options file (dsm.opt). You can also specify this option as a command-line parameter on the backup vm command.

## Syntax

---

```
>>-VMMAXVIRTUALDisks--+-size -+-----+----->><
                          .-2-----
                          '-2...8, 999-'
```

## Parameters

---

### size

Specifies the maximum size, in terabytes, of the VMDKs to include in a backup operation. The range is an integer 2 - 8; the default is 2. The maximum is 8.

To ensure that the VMware VMDK size that is included in backup operations is always the maximum size, specify 999. Use this value as the most effective method to ensure that the maximum value is always set. This value prevents the need to continuously modify the option files.



When you also specify the `vmskipmaxvirtualdisks yes` option, VMDKs that are the specified maximum size or smaller are backed up and VMDKs that are larger than the specified maximum size are excluded.

When you also specify the `vmskipmaxvirtualdisks no` option, backup operations fail if a VMDK is larger than the specified maximum size.

## Examples

---

Options file:

```
vmmaxvirtualdisks 3
```

Command line:

Back up VMDKs that are 5 TB or smaller and exclude VMDKs that are larger than 5 TB:

```
backup vm VM1 -vmmaxvirtualdisks=5 -vmskipmaxvirtualdisks=yes
```

Back up VMDKs that are 3 TB or smaller and fail the backup operation if a VMDK is larger than 3 TB:

```
backup vm VM1 -vmmaxvirtualdisks=3 -vmskipmaxvirtualdisks=no
```

Back up VMDKs that are 8 TB or smaller and exclude VMDKs that are larger than 8 TB:

```
backup vm VM1 -vmmaxvirtualdisks=8 -vmskipmaxvirtualdisks=yes
```

or

```
backup vm VM1 -vmmaxvirtualdisks=999 -vmskipmaxvirtualdisks=yes
```

Linux

Windows

## Vmmc

---

Use the `vmmc` option to store virtual machine backups by using a management class other than the default management class. For VMware VM backups, the `vmmc` option is valid only if the `vmbackuptype=fullvm` option is set.

## Supported Clients

---

 This feature is available only if the client operates as a data mover for IBM Spectrum Protect™ for Virtual Environments.

Linux

Windows

This option is valid for clients that are configured to back up VMware virtual machines. The server can also define this option.

Windows

This option is valid for clients that are configured to back up Hyper-V virtual machines. The server can also define this option.

## Options File

---

Linux

Place this option in the client options file `dsm.opt`, in the client system options file `dsm.sys`, or on the command line.

Windows

Place this option in the client options file (`dsm.opt`), or on the command line.

## Syntax

---

```
>>-VMMC--management_class_name-----<<
```

## Parameters

---

`management_class_name`

Specifies a management class that applies to the backed up virtual machine data. If you do not set this option, the default management class of the node is used.

## Examples

---

Task:

Run a backup of the virtual machine that is named `myVirtualMachine` and save the backup according to the management class that is named `myManagementClass`.

```
dsmc backup vm "myVirtualMachine" -vmc=myManagementClass
```

Windows

## Vmmountage

---

Use the `vmmountage` option with the `restore VM "*" -vmrestoretype=mountcleanupall` command to specify the number of hours that a VM file level restore mount must be active to be cleaned up.

## Supported Clients

---

Windows This option is only valid for Windows clients.

 This feature is available only if the client operates as a data mover for IBM Spectrum Protect™ for Virtual Environments: Data Protection for VMware.

## Options File

---

Windows None. You can specify this option only on the command line.

## Syntax

---

```
>>-VMMOUNTAge = - --hours-----<<
```

## Parameters

---

hours

Specifies the number of hours that a VM file level restore mount must be active to be cleaned up. All active mount operations that exceed this period are cleaned up.

The value that is specified must be an integer between 0 and 10000. The default is 0.

## Examples

---

Command line:

Clean up all mount operations that are active longer than 24 hours:

```
dsmc restore vm "*" -VMRESToretype=MOUNTCLEANUPALL -VMMOUNTAge=24
```

Clean up all active mount operations:

```
dsmc restore vm "*" -VMRESToretype=MOUNTCLEANUPALL -VMMOUNTAge=0
```

or

```
dsmc restore vm "*" -VMRESToretype=MOUNTCLEANUPALL
```

Linux | Windows

## Vmnoprmdisks

---

This option enables the client to restore configuration information for the pRDM volumes that are associated with a VMware virtual machine, even if the LUNs that were associated with the volumes cannot be found. Because pRDM volumes are not included in virtual machine snapshot, only the configuration information can be restored, and not the data that was on the volumes.

 This feature is available only if the client operates as a data mover for IBM Spectrum Protect™ for Virtual Environments: Data Protection for VMware.

This option does not apply to backups of Microsoft Hyper-V virtual machines.

## Supported Clients

---

This option is valid for Windows and Linux clients that are installed on a vStorage backup server.

## Options File

---

**Windows** Place this option in the client options file (dsm.opt), or specify it as a command-line parameter on the restore vm command.

**Linux** Place this option in the client options file (dsm.opt), in the client system options file (dsm.sys), or specify it as a command-line parameter on the restore vm command.

## Syntax

---

```
                .-NO--.  
>>-VMNOPRDMdisks-----<<  
                '-YES-'
```

## Parameters

---

### YES

Specify this value if you must restore a virtual machine that you backed up with `-vmprocesswithprdm=yes`, and the original LUNs that were mapped by the raw device mappings file cannot be located. This setting causes the client to skip attempts to locate the missing LUNs used by the pRDM volumes, and restore the configuration information (disk labels) that were associated with them. The pRDM volumes are restored as thin-provisioned VMFS VMDKs. You can then use the vSphere client to create the necessary pRDM mappings.

### NO

Setting `-vmnoprdmdisk=no` causes restore operations for virtual machines that were backed up with `-processvmwithprdm=yes` to fail if the original LUNs that were mapped to by the raw device mappings file cannot be located. This value is the default value.

## Examples

---

Option file:

```
VMNOPRDMDISKS YES
```

Command line:

```
dsmc restore vm vm123 -vmnoprdmdisks=yes
```

**Linux** | **Windows**

## Vmnovrdmdisks

---

This option enables the client to restore configuration information and data for vRDM volumes that are associated with a VMware virtual machine, even if the LUNs that were associated with the volumes cannot be found.

 This feature is available only if the client operates as a data mover for IBM Spectrum Protect™ for Virtual Environments: Data Protection for VMware.

This option does not apply to backups of Microsoft Hyper-V virtual machines.

## Supported Clients

---

This option is valid for Windows and Linux clients that are installed on a vStorage backup server.

## Options File

---

**Windows** Place this option in the client options file (dsm.opt), or specify it as a command-line parameter on the restore vm command.

**Linux** Place this option in the client options file (dsm.opt), in the client system options file (dsm.sys), or specify it as a command-line parameter on the restore vm command.

## Syntax

---

```
.-NO--.  
>>-VMNOVRDmdisks-----><  
'-YES-'
```

## Parameters

---

### YES

Specify this value if you must restore a virtual machine that you backed up, and the original LUNs that were mapped by the raw device mappings file cannot be located. This setting causes the client to skip attempts to locate the missing LUNs used by the vRDM volumes, and restore the configuration information (disk labels) and the data that was backed up. The vRDM volumes are restored as thin-provisioned VMFS VMDKs.

### NO

Setting `-vmnovrdmdisk=no` causes restore operations for virtual machines that had vRDM volume to fail, if the original LUNs that were mapped to by the raw device mappings file cannot be located. This value is the default value.

## Examples

---

Option file:

```
VMNOVRDMDISKS YES
```

Command line:

```
dsmc restore vm vm123 -vmnovrdmdisks=yes
```

## Vmpreferdagpassive

---

The `vmpreferdagpassive` option specifies whether to back up an active copy or passive copy of a database that is part of a Microsoft Exchange Server Database Availability Group (DAG).

This option applies to Microsoft Exchange Server workloads that run inside VMware virtual machine guests that are protected by IBM Spectrum Protect™ for Virtual Environments.

Use the `vmpreferdagpassive` option with the `backup vm` command.

## Supported Clients

---

**Linux** | **Windows** This option is valid on clients that act as a data mover for VMware guest backups.

## Options File

---

**Linux** Place this option in the client system-options file (`dsm.sys`) within a server stanza.

**Windows** Place this option in the client options file (`dsm.opt`).

## Syntax

---

```
.-No--.  
>>-VMPREFERDAGPassive-----><  
'-Yes-'
```

## Parameters

---

### No

Back up the Microsoft Exchange Server database in a DAG regardless of whether it is an active copy or passive copy. This value is the default.

### Yes

Skip the backup for an active database copy in a DAG if a valid passive copy is available on another server. If no valid passive copy is available, the active database copy is backed up.

## Examples

---

Options file:  
vmpreferdagpassive yes

Linux Windows

## Vmprocessvmwithindependent

---

Use this option to control whether full VMware virtual machine backups are processed if the machine is provisioned with one or more independent disk volumes.

Independent disk volumes do not support snapshots. Any independent disk volumes found on a virtual machine are not be processed as part of the backup operation. When the virtual machine is restored, the backup-archive client recovers the virtual machine, and only the volumes that participated in snapshot operations are restored. Configuration information and content of the independent disk volumes is not preserved in the information that is stored on the IBM Spectrum Protect™ server. Users must recreate the independent disk volumes on the restored machine.

If the virtual machine also contains one or more raw device mapping (RDM) volumes configured in physical-compatibility mode (pRDM), use the `vmprocessvmwithprdm` option to control whether the client backs up any files on the virtual machine if an independent disk is present.

 This feature is available only if the client operates as a data mover for IBM Spectrum Protect for Virtual Environments: Data Protection for VMware.

This option is only valid for VMware backups and does not pertain to Microsoft Hyper-V backups.

## Supported Clients

---

This option is valid for Windows and Linux clients that are configured as a VMware backup server. The server can also define this option.

## Options File

---

Windows Place this option in the client options file (`dsm.opt`) or on the command-line

Linux Place this option in the client options file (`dsm.opt`), in the client system options file (`dsm.sys`), or on the command-line.

## Syntax

---

```
>>--VMPROCESSVMWITHINDEPENDENT--+-NO-- .  
                                     +-----+----->>  
                                     '-YES-'
```

## Parameters

---

No  
The backup of the virtual machine fails if one or more independent disk volumes are detected. No is the default.

Yes  
Virtual machines that contain one or more independent disk volumes are backed-up. However, the independent disk volumes are not be processed as part of the virtual machine backup operation.  
If the virtual machine also contains one or more raw device mapping (RDM) disks that are provisioned in physical-compatibility mode, the `VMPROCESSVMWITHPRDM` option must also be specified.

## Examples

---

Option file:

VMPROCESSVMWITHINDEPENDENT Yes

Command line:

```
dsmc backup vm vmlocal -vmbackuptype=fullvm -vmprocessvmwithindependent=yes
```

Windows

## Vmprocessvmwithphysdisks

Use the `vmprocessvmwithphysdisks` option to control whether Hyper-V RCT virtual machine (VM) backups are processed if the VM has one or more physical disks (pass-through disks) provisioned.

A VM can access the storage on a physical disk that is connected directly to the Hyper-V server. This physical disk is called a *pass-through disk*.

When you set this option to `yes`, the data on any physical disks is excluded from backup operations, but the configuration information for the physical disks is saved with the VM backup. During a restore operation, you can restore the physical disk configuration by setting the `vmskipphysdisks no` option. If the original physical disks are available, they are reconnected to the restored VM.

 This feature is available only if the client operates as a data mover for IBM Spectrum Protect™ for Virtual Environments: Data Protection for Microsoft Hyper-V.

This option is valid only for Microsoft Hyper-V backups and does not apply to VMware backups.

This option is valid only for RCT backups on Windows Server 2016. This option does not apply to Hyper-V VSS backups on Windows Server 2012 or Windows Server 2012 R2.

## Supported Clients

This option is valid for clients on Windows Server 2016 or later operating systems.

## Options File

Place this option in the client options file (`dsm.opt`) or specify it as a command-line parameter on the `backup vm` command.

## Syntax

```
>>-VMPROCESSVMWITHPHYSDisks--+-NO-- .
                               +-----+----->>
                               '-YES-'
```

## Parameters

No

The backup operation of the VM fails if one or more physical disks are detected. This value is the default.

Yes

VMs that contain one or more physical disks are backed up. This option backs up the physical disk configuration without backing up the data on the physical disks.

## Examples

Options file:

```
VMPROCESSVMWITHPHYSDISKS Yes
```

Command line:

```
dsmc backup vm vmlocal -vmprocessvmwithphysd=yes
```

**Related reference:**

Vmskipphysdisks

Linux | Windows

## Vmprocessvmwithprdm

---

Use this option to control whether full VMware virtual machine backups are processed if the virtual machine has one or more raw device mapping (RDM) volumes provisioned in physical-compatibility mode (pRDM).

pRDM volumes do not support snapshots. Any pRDM volumes found on a virtual machine are not processed as part of the backup operation. When the virtual machine is restored, the backup-archive client recovers the virtual machine, and only the volumes that participated in snapshot operations are restored. Configuration information and content of the pRDM volumes is not preserved in the information stored on the IBM Spectrum Protect™ server. Users must re-create the pRDM volumes on the restored machine.

This option does not apply to virtual machines that have one or more RDM volumes that are provisioned in virtual-compatibility mode (vRDM). Because vRDM volumes do support snapshot operations, they are included in a full VMware virtual machine backup.

If the virtual machine also contains one or more independent disks, use the `vmprocessvmwithindependent` option to control whether the client backs up any files on the virtual machine if an independent disk is present.

 This feature is available only if the client operates as a data mover for IBM Spectrum Protect for Virtual Environments: Data Protection for VMware.

This option is only valid for VMware backups and does not pertain to Microsoft Hyper-V backups.

## Supported Clients

---

This option is valid for Windows and Linux clients that are configured as a VMware backup server. The server can also define this option.

## Options File

---

**Windows** Place this option in the client options file (`dsm.opt`) or on the command line

**Linux** Place this option in the client options file (`dsm.opt`), in the client system options file (`dsm.sys`), or on the command line.

## Syntax

---

```
                . -NO-- .  
>>-VMPROCESSVMWITHPRDM--+-----+-----<<  
                ' -YES- '
```

## Parameters

---

No

The backup of the virtual machine fails if one or more pRDM volumes are detected. No is the default.

Yes

Virtual machines that contain one or more raw device mapping (RDM) volumes that are provisioned in physical-compatibility mode (pRDM) are backed up. However, the pRDM volumes are not processed as part of the virtual machine backup operation.

If the virtual machine also contains one or more independent disks, the `vmprocessvmwithindependentdisk` option must also be specified.

## Examples

---

Option file:

```
VMPROCESSVMWITHPRDM Yes
```

Command line:

```
dsmc backup vm vmlocal -vmbackuptype=fullvm -vmprocessvmwithprdm=yes
```

**Windows**

## Vmrestoretype

---

Use the `vmrestoretype` option with the `query VM` or `restore VM` commands to specify the type of restore operation to perform or query.

This option is only valid for VMware virtual machines. The virtual machines must be hosted on VMware ESXi 5.1 servers, or later versions. To use this option, you must have a license agreement to use IBM Spectrum Protect™ for Virtual Environments: Data Protection for VMware.

## Supported Clients

---

**Windows** This option can be used with supported Windows clients.

## Options file

---

This option must be specified on the command line of a `restore vm` or `query vm` command. You cannot set this option in the client options file.

## Syntax

---

```

      .-NONinstant-----.
>>-VMRESToretype-+-----+-----><
      +-INSTANTRestore--+
      +-INSTANTAccess---+
      +-VMCleanup-----+
      +-VMFULLLCleanup---+
      +-ALLtype-----+
      '-MOUNTCLEANUPall-'
```

## Parameters

---

### noninstant

Specifies that classic full VM restore is performed. This is the default restore type.

### instantrestore

Specifies that an instant restore is performed. During an instant restore operation, the VM is started during the restore operation. When this restore type is specified on a `query VM` command, the command returns a list of VMs running an instant restore operation.

Important: For instant restore operations, ensure that both the temporary datastore that you specify with the `vmtempdatastore` option and the VMware datastore that is specified by the `datastore` option on the `restore VM` command have enough free storage to save the virtual machine that you are restoring, and the snapshot file that contains changes made to the data.

### instantaccess

Specifies that a temporary restore of the backed-up VM is performed. Use this restore type when you want to restore a VM temporarily, to test the integrity of a backup, before you run an instant restore. Any changes that are made to the temporary VM are not saved.

When this restore type is specified on a `query vm` command, the command returns a list of VMs that are running an instant access operation.

### vmcleanup

Specifies that a cleanup of the selected VM and its components is performed.

For instant access operations, this option removes the temporary VM and all of its components.

For instant restore operations, this option removes only the components that are no longer needed (for example the iSCSI mounts). The virtual machine is not removed. Cleanup operations are not allowed when the VM is still running on the iSCSI disks. To force this behavior see `vmfullcleanup`.

### vmfullcleanup

The VM and all its components are removed regardless of the current state. Do not start a full clean up operation while `vMotion` is still migrating a virtual machine.

### alltype

Queries all active instant access and instant restore sessions.

### mountcleanupall



Cleans up active VM file level restore mount operations that are older than the period specified with the `vmmountage` option. You must specify restore vm "\*" to use the `mountcleanupall` option.

## Examples

---

Command line:

Perform an instant access of the VM named Oslo. The original VM still exists. As a result, the `-vmname` option is used to assign the new name `Oslo_verify`.

```
dsmc restore vm Oslo -vmrest=instantaccess -vmname=Oslo_verify
```

Perform an instant restore of the VM named Cologne.

```
dsmc restore vm Cologne -vmrest=instantrestore  
-vmtempdatastore=Verify_datastore
```

Perform a regular (full VM) restore of the virtual machine named `San_Jose`.

```
dsmc restore vm San_Jose
```

Alternatively, you can also use the following command: `dsmc restore vm San_Jose -vmrest=noni`

Perform an instant restore of the VM named Oslo, with the `-pick` option to choose a specific backup version.

```
dsmc restore vm Oslo -vmrest=instantrestore -pick
```

Perform a cleanup of the VM and all its components. These components include iSCSI mounts, devices, and temporary data that are associated with the VM name, on the ESX host.

```
dsmc restore vm Oslo -VMRESToretype=VMCleanup -vmname=Oslo_Verify
```

Perform a query to find all active instant restore sessions and display an abbreviated status for each.

```
dsmc query vm * -VMRESToretype=INSTANTRestore
```

Perform a query to find all active instant restore mode and instant access mode virtual machines.

```
dsmc query vm * -VMRESToretype=ALLtype
```

Perform a query to find all active instant restore mode virtual machines, and obtain detailed status for each virtual machine.

```
dsmc query vm * -VMRESToretype=INSTANTRestore -Detail
```

Perform a query to find all active instant access sessions.

```
dsmc query vm * -VMRESToretype=INSTANTAccess
```

Perform a mount cleanup of all mount operations that are active longer than 24 hours.

```
dsmc restore vm "*" -vmrestoretype=mountcleanupall -vmmountage=24
```

Windows

Linux

## Vmskipctlcompression

---

Use the `vmskipctlcompression` option for VM backups to specify whether control files (\*.ctl) are compressed during VM backup. The option does not affect the compression of data files (\*.dat)

You can compress virtual machine control files and data files only when the files are stored in a storage pool that is enabled for client-side deduplication. Use the following options configuration to compress data files and not compress control files:

```
compression yes  
vmskipctlcompression yes
```

You must direct the data files to a storage pool that is enabled for client-side deduplication. You can direct the control files to a storage pool that is not enabled for client-side deduplication

You must be licensed to use IBM Spectrum Protect™ for Virtual Environments to use this option.

## Supported Clients

---

**Windows** This option can be used with supported Windows and Linux clients.

## Options file

---

Place this option in the client options file (dsm.opt), or on the command line.

## Syntax

---

```
>>-VMSKIPCTLCOMPRESSION--+-Yes-.  
'--No--'-----<<
```

## Parameters

---

Yes

Do not compress control files (\*.ctl) during VM backup. The option does not affect compression of data files (\*.dat).

No

Control files (\*.ctl) can be compressed during VM backup. Whether control files are compressed depends on the value of the compression option.

**Linux** | **Windows**

## Vmskipmaxvirtualdisks

---

The vmskipmaxvirtualdisks option specifies how the backup operation processes VMware virtual machine disks (VMDKs) that exceed the maximum disk size.

 This feature is available only if the client operates as a data mover for IBM Spectrum Protect™ for Virtual Environments: Data Protection for VMware.

Use the vmskipmaxvirtualdisks option with the vmmaxvirtualdisks option to specify how the client processes large VMDKs during a backup operation:

- Set the vmskipmaxvirtualdisks option to back up the VMDKs that do not exceed the maximum size (and exclude any VMDKs that exceed the size), or fail the operation.
- Set the vmmaxvirtualdisks option to specify the maximum size of the VMDKs to include.

In V7.1.3 and earlier, the vmskipmaxvirtualdisks option was named vmskipmaxvmdks. In V7.1.4 and later, vmskipmaxvirtualdisks is the preferred option name. However, the client still processes backup operations with the vmskipmaxvmdks name.

## Supported clients

---

**Linux** This option is valid for 64-bit Linux clients that are configured as data movers that back up VMware virtual machines.

**Windows** This option is valid for 64-bit Windows clients that are configured as data movers that back up VMware virtual machines.

## Options file

---

**Linux** Set the vmskipmaxvirtualdisks option in the client system options file (dsm.sys). You can also specify this option as a command-line parameter on the backup vm command.

**Windows** Set the vmskipmaxvirtualdisks option in the client options file (dsm.opt). You can also specify this option as a command-line parameter on the backup vm command.

## Syntax

---

```
>>-VMSKIPMAXVIRTUALDISKS--+-No--.  
'--Yes-'-----<<
```

## Parameters

---

No

Specifies that backup operations fail if a VMware virtual machine has one or more VMDKs that are larger than the maximum size. This setting is the default value.

Yes

Specifies that backup operations include VMware VMDKs that are the maximum size (or smaller) and exclude any VMDKs that are larger than the maximum size.

## Examples

---

Options file:

```
vmskipmaxvirtualdisks yes
```

Command line:

Fail a backup operation if a VMDK is larger than 2 TB:

```
backup vm VM1 -vmskipmaxvirtualdisks=no
```

Fail a backup operation if a VMDK is larger than 5 TB:

```
backup vm VM1 -vmskipmaxvirtualdisks=no -vmmaxvirtualdisks=5
```

Back up VMDKs that are 8 TB or smaller and exclude VMDKs that are larger than 8 TB:

```
backup vm VM1 -vmskipvirtualdisks=yes -vmmaxvirtualdisks=8
```

Linux

Windows

## Vmskipmaxvmdks

---

The `vmskipmaxvmdks` option specifies how the backup operation processes VMware virtual machine disks (VMDKs) that exceed the maximum disk size.

In V7.1.4 and later, `vmskipmaxvmdks` is renamed `vmskipmaxvirtualdisks`. Although `vmskipmaxvirtualdisks` is the preferred name, the client still processes backup operations with the `vmskipmaxvmdks` name.

 This feature is available only if the client operates as a data mover for IBM Spectrum Protect™ for Virtual Environments: Data Protection for VMware.

Windows

## Vmskipphysdisks

---

Use the `vmskipphysdisks` option to restore configuration information for physical disks (pass-through disks) that are associated with a Hyper-V virtual machine (VM), if the logical unit numbers (LUNs) that are associated with the volumes on the physical disks are available.

Because physical disks are not included in a VM snapshot, only the configuration information can be restored, and not the data on the volumes.

 This feature is available only if the client operates as a data mover for IBM Spectrum Protect™ for Virtual Environments: Data Protection for Microsoft Hyper-V.

This option is valid only for Microsoft Hyper-V backups and does not apply to VMware backups.

This option is valid only for restoring Hyper-V VMs on Windows Server 2016. This option does not apply to Hyper-V hosts on Windows Server 2012 or Windows Server 2012 R2.

## Supported Clients

---

This option is valid for clients on Windows Server 2016 or later operating systems.

## Options File

---

Place this option in the client options file (dsm.opt), or specify it as a command-line parameter on the restore vm command.

## Syntax

---

```
.-NO--.  
>>-VMSKIPPHYSDisks-----><  
'-YES-'
```

## Parameters

---

NO

If the original physical disks are available, specify this value to restore the physical disk configuration information that was backed up with the `vmprocessvmwithphysdisks yes` option. The original physical disks are reconnected to the restored VM. If the original physical disks cannot be located, the restore operation fails. This value is the default.

YES

Specify this value if you must restore a VM that you backed up with the `vmprocessvmwithphysdisks yes` option, and the original physical disks cannot be located. This setting causes the client to skip attempts to locate the physical disks, and does not restore the physical disk configuration information.

## Examples

---

Options file:

```
VMSKIPPHYSDISKS YES
```

Command line:

```
dsmc restore vm vm123 -vmskipphysd=yes
```

**Related reference:**

[Vmprocessvmwithphysdisks](#)

Windows

## Vmstoragetype

---

Use the `vmstoragetype` option with the restore VM command to specify the storage device type from which the snapshot is mounted with IBM Spectrum Protect™ recovery agent.

Windows

You can specify the `vmstoragetype` option with the restore VM `-VMRESToretype=INSTANTRestore` or restore VM `-VMRESToretype=INSTANTAccess` commands.

When `vmstoragetype` is specified, it is not necessary to set the storage type option in the IBM Spectrum Protect recovery agent GUI. The `vmstoragetype` overwrites the storage type setting in the recovery agent GUI.

## Supported Clients

---

Windows

This option is valid on Windows only.



This feature is available only if the client operates as a data mover for IBM Spectrum Protect for Virtual Environments: Data Protection for VMware.

## Options File

---

Windows

Place this option in the client options file (dsm.opt) on the Windows mount proxy system, or on the command line.

Windows

## Syntax

---

```
.-DISK-.  
>>-VMSTORAGEType---+---VTL---+-----><  
'-TAPE-'
```

## Parameters

---

**Windows** DISK

The snapshots to be mounted by the recovery agent are on Disk or File storage pools. This value is the default.

**Windows** VTL

The snapshots to be mounted by the recovery agent are on VTL storage pools.

**Windows** TAPE

The snapshots to be mounted by the recovery agent are on Tape storage pools.

## Examples

---

Options file:

```
VMSTORAGETYPE TAPE
```

Command line:

**Windows** Restore a virtual machine that is named Orion by using the following command:

```
dsmc restore vm Orion -Host=esxi.example.com -datacenter=mydatacenter  
-VMTEMPDatastore=temp_datastore -VMRESToretype=INSTANTRestore  
-datastore=mydatastore -VMSTORAGETYPE=VTL
```

This command specifies the name of the virtual machine to restore, the host and data center to restore it to, and the restore type (-VMRESToretype=INSTANTRestore). The -VMSTORAGETYPE=VTL option identifies the snapshot (Orion) that is to be mounted by the recovery agent is on VTL storage pools. The VMTEMPDatastore option is a mandatory parameter for instant restore operations.

**Linux** | **Windows**

## Vmtagdatamover

---

Use the vmtagdatamover option to enable tagging support in the backup-archive client (data mover). When this option is enabled, the client manages backups of virtual machines in VMware inventory objects according to the data protection tags that are set by the IBM Spectrum Protect™ vSphere Client plug-in of the vSphere Web Client, or set with tools such as VMware vSphere PowerCLI Version 5.5 R2 or later.

 This feature is available only if the client operates as a data mover for IBM Spectrum Protect for Virtual Environments: Data Protection for VMware.

For more information about data protection tags, see "Data protection tagging overview" .

The data mover processes data protection tags when the vmtagdatamover option is set to yes. Ensure that the following requirements are met.

Requirements:

- For the data mover:
  - VMware vCenter Server must be at Version 6.0 Update 1 or later.
  - Extra permissions are required for the account that is used for backup or restore operations. These new vCenter permissions are required to perform category and tagging operations. Ensure that the following user permissions are set on the root vCenter Server:

```
Inventory Service > vSphere Tagging > Assign or Unassign vSphere Tag  
Inventory Service > vSphere Tagging > Create vSphere Tag  
Inventory Service > vSphere Tagging > Create vSphere Tag Category  
Inventory Service > vSphere Tagging > Delete vSphere Tag  
Inventory Service > vSphere Tagging > Delete vSphere Tag Category  
Inventory Service > vSphere Tagging > Modify UsedBy Field For Tag  
Inventory Service > vSphere Tagging > Modify UsedBy Field For Category
```

For more information about setting vCenter permissions for backup and restore operations, see technote 7047438.

- In order for the Data Protection for VMware vSphere GUI to function correctly with tagging support, ensure that the following requirements are met during the installation of the GUI:
  - At least one data mover and the Data Protection for VMware vSphere GUI must be installed on the same server. This data mover node must be configured so that the vCenter server credentials are saved. You can save the credentials

by running the configuration wizard to save the data mover node password, or by using the `dsmc set password` command in the data mover command line.

If you use other data movers, running on virtual machines or physical machines as additional data movers, you can install them on other servers. For tagging support, all these data movers must also be configured with the `vmtagdatamover=yes` option. These additional data movers do not require the Data Protection for VMware vSphere GUI to be installed on the same server in order for them to work correctly as tag-based data movers.

- o **Linux** For Linux data movers, ensure that you specify the data mover installation directory and the Java™ shared library `libjvm.so` in the `LD_LIBRARY_PATH` environment variable. The path to `libjvm.so` is used for tagging support when you enable the `vmtagdatamover` option on the data mover. For instructions, see "Setting up the data mover nodes in a vSphere environment".
- o **Linux** On Linux operating systems, the Data Protection for VMware vSphere GUI must be installed by using the default user name (`tdpvmware`).
- o **Linux** On Linux data mover nodes, the default password file (`/etc/adsm/TSM.sth`) must be used.

## Supported clients

---

**Linux** This option can be used with supported x86\_64 Linux clients.

**Windows** This option can be used with supported Windows 64-bit clients.

## Options file

---

**Linux** You can specify this option in the client system-options file (`dsm.sys`) or on the command line for the backup `vm` command. You can also include this option on the IBM Spectrum Protect server in a client option set. You cannot set this option in the Preferences Editor.

**Windows** You can specify this option in the client options file (`dsm.opt`) or on the command line for the backup `vm` command. You can also include this option on the IBM Spectrum Protect server in a client option set. You cannot set this option in the Preferences Editor.

## Syntax

---

```
. -No-- .  
>>-VMTAGDATAmover-+-----+----->>  
'-Yes-'
```

## Parameters

---

No

The client ignores any data protection settings or tags that are attributed to the VMware asset. This value is the default.

Yes

The client manages backups based on the data protection settings in the IBM Spectrum Protect vSphere Client plug-in or based on the tag values that are attributed to the VMware asset.

When tagging support is enabled, some client options might be affected by the data protection settings. For information about which options are affected, see "Supported data protection tags".

The following examples show how client options can be affected by data protection tags:

- When you use data protection settings or tags to control which VMware virtual machines are backed up, the tag values might overlap the `domain.vmfull` client option setting. While the `domain.vmfull` option defines what virtual machines the client protects, the `Excluded` and `Included` tags override what is defined by the `domain.vmfull` option.

For example, the following options file statement specifies what is backed up during full virtual machine backup operations:

```
DOMAIN.VMFULL VMHOSTCLUSTER=cluster01,cluster02;VM=Dept20*
```

If you use data protection settings or tags to exclude virtual machine `Dept204`, the `Dept204` virtual machine is not backed up.

- The retention policy setting in the IBM Spectrum Protect vSphere Client plug-in or the tag setting for the `Management Class (IBM Spectrum Protect)` category overrides the `include.vm` and `vmmc` client options, but does not override the `vmctlmc` option.

Tip: If you want to set up a data mover as the default data mover, use the `Vmtagdefaultdatamover` option.

## Examples

---

Options file:

```
vmtagdat yes
```

Command line:

```
-vmtagdat=yes
```

### Related concepts:

Data protection tagging overview

### Related tasks:

[Enabling tagging support](#)

### Related reference:

Supported data protection tags

`Vmtagdefaultdatamover`

`Domain.vmfull`

`Include.vm`

`Vmmc`

`Vmctlmc`

Set Vmtags

Linux

Windows

## Vmtagdefaultdatamover

---

Use the `vmtagdefaultdatamover` option to protect virtual machines, defined in a schedule, that do not have an assigned or inherited `Data Mover` category and tag.

 This feature is available only if the client operates as a data mover for IBM Spectrum Protect™ for Virtual Environments: Data Protection for VMware.

When you specify a data mover node with the `vmtagdefaultdatamover` option and the `vmtagdatamover yes` option, the data mover backs up any new virtual machines that are added to any container in the datacenter, if the container is already in a protection set. A protection set consists of the virtual machines in a container that is assigned the `Schedule (IBM Spectrum Protect)` category and tag. The default data mover also backs up any virtual machines in the protection set that are not assigned the `Data Mover` tag.

When more than one data mover is associated with a schedule, define one data mover as the default data mover with the `vmtagdefaultdatamover` option. If only one data mover is associated with a schedule, assign that data mover as the default.

Tip: For each schedule, specify only one data mover in its associated data mover list as the default. Otherwise, any new virtual machines and virtual machines that are not assigned the `Data Mover` tag will be backed up more than once.

Data protection tags can be assigned to the vSphere inventory to manage the protection of virtual machines. For the list of supported categories and tags, see "Supported data protection tags".

## Supported clients

---

Linux

This option can be used with supported x86\_64 Linux data movers.

Windows

This option can be used with supported Windows 64-bit data movers.

## Options file

---

Linux

You can specify this option in the client system-options file (`dsm.sys`) or on the command line for the backup `vm` command. You can also include this option on the IBM Spectrum Protect server in a client option set. You cannot set this option in the Preferences Editor.

**Windows** You can specify this option in the client options file (dsm.opt) or on the command line for the backup vm command. You can also include this option on the IBM Spectrum Protect server in a client option set. You cannot set this option in the Preferences Editor.

## Syntax

---

```
. -No----- .  
>>-VMTAGDEFAULTdatamover----->>  
+-Yes-----+  
'-dm_name-'
```

## Parameters

---

### No

The local data mover does not function as a default data mover. Virtual machines that are not assigned the `Data Mover tag` are not protected by this data mover. This value is the default.

### Yes

Specifies that the local data mover (the data mover where you are specifying this option) functions as the default data mover.

You must also enable the data mover for tagging support by specifying the `vmtagdatamover yes` option.

### *dm\_name*

The name of the data mover that you want to use as the default data mover. This option is necessary only if you want to set this option in the options file for the default data mover. This option is ignored for any data mover that is not the default data mover.

It is possible to pass this option down to all data movers on the server schedule command or to include it all data mover option files. Only the default data mover uses this option. Therefore, define only one default data mover.

You must also specify the `vmtagdatamover yes` option in the options file on the data mover that you want to designate as the default data mover.

## Example

---

Your Windows Data Protection for VMware configuration uses two data movers, `VC1_DC1_DM1` and `VC1_DC1_DM2`. To designate data mover `VC1_DC1_DM1` as the default data mover, complete the following steps:

1. In the options file for data mover `VC1_DC1_DM1` (dsm.VC1\_DC1\_DM1.opt), add the following statements:

```
vmtagdatamover yes  
vmtagdefaultdatamover yes
```

or

```
vmtagdatamover yes  
vmtagdefaultdatamover VC1_DC1_DM1
```

2. In the options file for data mover `VC1_DC1_DM2` (dsm.VC1\_DC1\_DM2.opt), add the following statements:

```
vmtagdatamover yes  
vmtagdefaultdatamover VC1_DC1_DM1
```

The `vmtagdefaultdatamover` option can also be passed to a schedule definition or command to assign the default data mover. If the default data mover is defined in the schedule definition, all data movers that are associated with the schedule will be able to identify the default data mover for the protection set.

For example: `dsmc backup vm -vmtagdefaultdatamover=VC1_DC1_DM1`

### Related tasks:

[Enabling tagging support](#)

### Related reference:

Domain.vmfull

Vmtagdatamover

Set Vmtags



## Vmtempdatastore

Use the `vmtempdatastore` option with the `restore VM` command to define a temporary datastore on the ESX host for an instant restore operation.

The datastore created with the `vmtempdatastore` option is used to temporarily store the configuration of the VM created during restore processing. This option is required during instant restore operations (`-vmrestoretype=instantrestore`).

This option is only valid for VMware virtual machines. The virtual machines must be hosted on VMware ESXi 5.1 servers, or later versions. To use this option, you must have a license agreement to use IBM Spectrum Protect™ for Virtual Environments: Data Protection for VMware.

### Supported Clients

**Windows** This option can be used with supported Windows clients.

### Options file

Place this option in the client options file (`dsm.opt`), or on the command line.

### Syntax

```
>>-VMTEMPDatastore-- --datastore_name-----><
```

### Parameters

`datastore_name`

Specify the name of an existing datastore on the ESX host. The temporary datastore must be different from the original datastore, or the datastore specified by the `datastore` option. The datastore that you specify must be a VMFS datastore.

### Examples

Options file:

```
VMTEMPDatastore Verify_Datastore
```

Command line:

```
dsmc restore vm Oslo -VMRESToretype=INSTANTAccess
-vmname=Oslo_instant_restored -VMTEMPDatastore=Temporary_Datastore
```

Linux | Windows

## Vmverifyifaction

Use this option to specify the action to perform if the data mover detects integrity problems with the latest CTL and bitmap files for a virtual machine.

This option affects backup processing for a VM guest only when all of the following conditions are true:

- The previous backup operation for the VM guest was an incremental-forever-incremental backup (`mode=ifincremental`)
- The current backup operation for the VM guest is an incremental-forever-incremental backup
- The data mover detected an integrity problem with the CTL and bitmap data from the previous incremental-forever-incremental backup operation
- The `vmverifyiflatest` option is set to `yes`

If all of these conditions are not true for a virtual machine, the backup occurs as it normally would; the action that is specified by this option is not initiated.

 This feature is available only if the client operates as a data mover for IBM Spectrum Protect™ for Virtual Environments: Data Protection for VMware.

## Supported clients

---

**Linux** This option is valid for Linux clients that act as a data mover for VMware guest backups.

**Windows** This option is valid for Windows clients that act as a data mover for VMware guest backups.

## Options file

---

**Windows** Set this option in the client options file (dsm.opt).

**Linux** Set this option in the client options file (dsm.opt) or the client system options file (dsm.sys).

This option can also be included in a client options set, as a parameter on a backup vm command, or on the options parameter in a schedule definition.

## Syntax

---

```
                .-FAILbackup-.  
>>-VMVERIFYIFAction-----><  
                +-FORCEfull--+  
                '-PREview----'
```

## Parameters

---

### FAILbackup

This action fails the backup operation. The following messages are written to the data mover error log file (dsmerror.log):

```
ANS9921E Virtual machine disk, vm_name (disk_label),  
verification check failed (xxx/yyy).
```

The *xxx/yyy* in the message indicate the size of the bitmap (*xxx*) and CTL files (*yyy*).

```
ANS9919E Failed to find the expected control files for vm_name
```

Perform a full VM backup (set `-mode=IFFull` for the affected virtual machines at a time of your choosing. An alternative is to use the `-vmverifyifaction=forcefull` on the next scheduled incremental-forever-incremental operation to force a full backup of those VMs, if you determine that your scheduled backup window can contain the full VM backups for these VMs. This value is the default action value.

### FORCEfull

This action changes the backup mode from `-mode=ifincremental` to `-mode=iffull`; the current backup becomes a full VM backup. The full VM backup is initiated for you. The following messages are written to the data mover error log file (dsmerror.log):

```
ANS9921E Virtual machine disk, vm_name (disk_label),  
verification check failed (xxx/yyy)
```

The *xxx/yyy* in the message indicate the size of the bitmap (*xxx*) and CTL files (*yyy*).

```
ANS9919E Failed to find the expected control files for vm_name
```

```
ANS9922I VMVERIFYIFlatest is enabled for vm_name (action: FORCEFULL).
```

```
ANS9920W Forcing a full vm backup for vm_name
```

Use this option if your current backup window can contain a full VM backup of the affected virtual machines.

### PREview

This action does not perform any backups. Instead, the CTL and bitmap data for each VM guest that is processed by the backup vm command is restored to a temporary location, where it is checked for integrity. If the integrity check fails, the following messages are written to the data mover error log file (dsmerror.log):

```
ANS9921E Virtual machine disk, vm_name (disk_label),  
verification check failed (xxx/yyy)
```

The xxx/yyy in the message indicate the size of the bitmap (xxx) and CTL files (yyy).

```
ANS9919E Failed to find the expected control files for vm_name
```

```
ANS9922I VMVERIFYIFlatest is enabled for vm_name (action: PREVIEW)
```

Use this option to validate the integrity of the incremental-forever-incremental backups (`-mode=ifincremental`) that you previously created for one or more a virtual machines.

If the messages indicate that some VMs failed the integrity checks, start a full VM backup (`-mode=iffull`) at a time of your choosing. Alternatively, set `-vmverifyifaction=forcefull` on the next scheduled incremental-forever-incremental operation to force a full backup of those VMs. The backup window must be large enough to accommodate one or more full VM backups.

Linux | Windows

## Vmverifyiflatest

This option applies only to VMware virtual machine (VM) backup operations that use the incremental-forever-incremental backup mode (that is, a backup vm command with `-mode=IFIncremental` specified). If this `vmverifyiflatest` option is enabled, the data mover runs an integrity check on the CTL and bitmap files that were created on the server during the last backup, if the last backup was an incremental-forever-incremental backup.

If the files pass the integrity tests, the virtual machine is restorable. The current backup proceeds and adds another snapshot to the chain of snapshots for the virtual machine.

If the files fail the integrity tests, the virtual machine is not restorable. The data mover then performs another action, which you specified on the `vmverifyifaction` option. You can set `vmverifyifaction` to create a full VM backup immediately, or you can fail the backup completely, and run a full VM backup at another time. A third parameter can be set to just verify the CTL and bitmap files for a virtual machine, without creating a new backup snapshot.

Verification can be performed only if the previous backup operation for the VM used `mode=IFIncr`, and if the current backup operation also uses `mode=IFIncr`. This option has no effect on the other virtual machine backup modes.

Important:

If this option is set to `no`, VM backup processing continues without any verification tests. The processing resources that are involved in performing the integrity checks is negligible. To ensure the continued integrity of your incremental-forever-incremental backup chain, set or use the default value (`vmverifyiflatest yes`). Do not set this option to `no`, unless you are directed to do so, by IBM® support.

 This feature is available only if the client operates as a data mover for IBM Spectrum Protect™ for Virtual Environments: Data Protection for VMware.

## Supported clients

Linux This option is valid for Linux clients that act as a data mover for VMware guest backups.

Windows This option is valid for Windows clients that act as a data mover for VMware guest backups.

## Options file

Windows Set this option in the client options file (`dsm.opt`).

Linux Set this option in the client options file (`dsm.opt`) or the client system options file (`dsm.sys`).

This option can also be included in a client options set, as a parameter on a backup vm command, or on the options parameter in a schedule definition.

## Syntax

```
.-YES-.
>>-VMVERIFYIFlatest--+----->>
'-NO--'
```

## Parameters

---

YES

This setting specifies that validation of the CTL and the bitmap data is performed for each VM that is processed by the current incremental-forever-incremental (mode=IFIncr) backup operation, if the previous backup operation for that VM was also an incremental-forever-incremental backup. This value is the default value.

NO

This setting specifies that validation of CTL and bitmap data does not occur during incremental-forever-incremental backup processing. Do not set this value unless directed to do so by IBM support.

## Examples

---

Options file:

```
vmverifyiflatest yes
```

Command line:

```
dsmc backup vm vml -mode=ifincremental -vmverifyiflatest=yes
```

Linux

Windows

## Vmvstortransport

---

The `vmvstortransport` option specifies the preferred transports order (hierarchy) to use when backing up or restoring VMware virtual machines. If you do not include a given transport using this option, that transport is excluded and is not used to transfer data.

The transport order that you specify determines how the VMware API for Data Protection (VADP) accesses virtual disk data, but it does not influence the data path that is used between the backup-archive client and the IBM Spectrum Protect™ server. Valid transports include any order or combination of the following options:

`nbd`

Network based data transfer. Access virtual disk data using the LAN. This transport path is generally available in all configurations.

`nbdssl`

Same as `nbd`, but the data is encrypted before being sent over the LAN. Encryption can decrease performance.

`san`

Storage Area Network transfer: Access virtual disk data using the SAN.

`hotadd`

If you use the backup-archive client in a virtual machine, the `hotadd` transport allows the transport of backed up data to dynamically added storage.

Separate each transport option from the others with a colon, for example, `san:nbd:nbdssl:hotadd`.

If you do not specify a transport hierarchy, the default transport selection order is `san:hotadd:nbdssl:nbd`.

The first transport that is available is used to transfer the data. If you want to prevent data transport over a particular path, do not include it in the transport list. For example, if it is important to not disrupt LAN traffic, omit the `nbd` transports from the hierarchy.

 This feature is available only if the client operates as a data mover for IBM Spectrum Protect for Virtual Environments: Data Protection for VMware.

Linux

Set this option in `dsm.sys`.

Windows

Set this option in the client options file (`dsm.opt`).

## Supported clients

---

Windows

This option is valid for Windows clients that are configured to back up or restore virtual machine files using VADP.

Linux

This option is valid for Linux clients that are configured to back up or restore virtual machine files using VADP.

## Syntax

---

.-,-----.

```

      V          |
>>-VMVSTORTransport-----+-----+----->>
      +-NBD-----+
      +-NBDSSTL--+
      +-SAN-----+
      '-HOTADD-'

```

## Examples

If the SAN is available, do not transport backups or restores over the LAN

```
VMVSTORTRANSPORT san
```

The backup-archive client is running in a virtual machine, but do not use the hotadd transport

```
VMVSTORTRANSPORT nbdssl:nbd
```

Use the LAN transport, even if nbdssl is available, to obtain better performance

```
VMVSTORTRANSPORT nbd
```

The SAN transport is preferred, but use nbd when the SAN is not available, and do not use nbdssl or hotadd

```
VMVSTORTRANSPORT san:nbd
```

Windows

## Vssaltstagingdir

The vssaltstagingdir option specifies the fully qualified path that contains the system exclude cache and temporary data for VSS snapshot operation.

The backup-archive client determines the path for temporary VSS files from the following prioritized choices:

1. The vssaltstagingdir option is defined in the dsm.opt file.
2. The c:\adsm.sys directory exists and is not empty.
3. If the vssaltstagingdir is not defined and the c:\adsm.sys directory does not exist, the client gets the path from a registry key. The path for temporary VSS files is the DefaultVssStagingDir value, and is generated from the Path value under the HKLM\SOFTWARE\IBM\ADSM\CurrentVersion\BackupClient key. After the DefaultVssStagingDir value is created, the value is not changed if the client is reinstalled to a new location.

## Supported Clients

This option is valid for all Windows clients.

## Options File

Place this option in the client options file (dsm.opt).

## Syntax

```
>>-VSSALTSTAGINGDIR--filepath----->>
```

## Parameters

filepath

Specify the fully qualified path for temporary files that are related to VSS snapshot operations. If any part of the path does not exist, the backup-archive client attempts to create it. The default value is the client installation directory.

In Uniform Naming Convention (UNC) format, the path must contain a drive letter. In the following UNC format example, the path contains the drive letter D\$: \\computer7\D\$\temp\snapshot.

## Examples

Options file:

```
vssaltstagingdir "c:\Users\All Users\Tivoli\adsm.sys"
```

Command line:

```
-vssaltstagingdir ="c:\Users\All Users\Tivoli\adsm.sys"
```

The option is valid only on the initial command line. It is not valid in interactive mode.

Windows

## Vssusesystemprovider

---

The `vssusesystemprovider` option specifies whether to use the Windows system provider, or to let Windows decide the most suitable provider to use.

Use the `vssusesystemprovider` option for Microsoft Windows Volume Shadow Copy Service (VSS) operations, such as system state backup or IBM Spectrum Protect™ for Copy Services backups.

### Supported Clients

---

This option is valid for all Windows clients. The server can also define this option. The IBM Spectrum Protect API does not support this option.

### Options File

---

Place this option in the client options file (`dsm.opt`).

### Syntax

---

```
>>-VSSUSESYSTEMProvider-+-----+----->>  
                          .-No--.  
                          '-Yes-'
```

### Parameters

---

Yes

Specifies that the Microsoft Windows VSS system provider is used.

No

Specifies that the default system provider is used. This provider might or might not be the same as the system provider, depending on what other providers are installed on the system. Use no if you want to use the default system provider and the default system provider is not the Microsoft Windows VSS provider. No is the default.

### Examples

---

Options file:

```
vssusesystemprovider yes
```

Command line:

Does not apply.

Linux | Windows

## Vmtimeout

---

`VMTIMEOut` specifies the maximum time, in seconds, to wait before abandoning a backup vm operation, when the `INCLUDE.VMTSMVSS` option is used to provide application protection. To use this option, the IBM Spectrum Protect™ for Virtual Environments license must be installed.

Each backup vm operation that is performed on a virtual machine that is protected by a `INCLUDE.VMTSMVSS` option is subject to a timer. The timer value determines how many seconds the client should wait for the application to quiesce activity and truncate its logs so the backup can be performed. The default time out value is sufficient for most environments. However, if your application

data cannot be backed up because the application needs additional time to prepare for the snapshot, you can increase the time out value. This timer applies only to backup vm operations when the INCLUDE.VMTSMVSS option is set for a virtual machine.

## Supported clients

---

**Linux** This option can be used with supported x86\_64 Linux clients.

**Windows** This option can be used with supported Windows clients.

## Options file

---

Place this option in the client options file. It cannot be set on the command line or in the Preferences editor.

## Syntax

---

```
>>-VMTIMEout-----.-180-----<<
      '-time_out-'
```

## Parameters

---

*time\_out*

Specifies the time to allow, in seconds, for backup operations to complete when a virtual machine is protected by the application protection option, INCLUDE.VMTSMVSS. The value specified must be an integer between 180 and 500. The default is 180 seconds.

## Examples

---

Options file

```
VMTIMEout 500
```

Command line

Not applicable; this option cannot be set on the command line.

**Related reference:**

INCLUDE.VMTSMVSS

## Webports

---

The webports option enables the use of the web client outside a firewall.

The webports option enables the use of the web client outside a firewall by specifying the TCP/IP port number used by the IBM Spectrum Protect™ client acceptor service and web client agent service for communications with the web client.

**AIX** **Linux** **Solaris** **Mac OS X** Values for both the client acceptor and the web client agent service are required.

**Windows** Values for both the client acceptor service and the web client agent service are required.

**AIX** **Linux** **Solaris** **Mac OS X** If you do not specify this option, the default value, zero (0), is used for both ports. This causes TCP/IP to randomly assign a free port number for the client acceptor and the web client agent service.

**Windows** If you do not specify this option, the default value, zero (0), is used for both ports. This causes TCP/IP to randomly assign a free port number for the client acceptor service and the web client agent service.

## Supported Clients

---

This option is valid for all clients. The IBM Spectrum Protect API does not support this option.

## Options File

---

**AIX** **Linux** **Solaris** **Mac OS X** Place this option in the dsm.sys file within a server stanza. To set this option in the Client Preferences editor, click Edit > Client Preferences > Web Client, and specify the ports in the Web Agent Port and Web Client

Acceptor Port fields.

**Windows** Place this option in the client options file (dsm.opt). To set this option in the Client Preferences editor, click Edit > Client Preferences > Web Client , and specify the ports in the Web Agent Port and Web Client Acceptor Port fields.

## Syntax

---

```
>>-WEBPorts-- --cadport-- --agentport-----<<
```

## Parameters

---

**AIX** | **Linux** | **Mac OS X** | **Solaris** **cadport**

Specifies the required client acceptor port number. The range of values is 1000 through 32767. If a value is not specified, the default, zero (0), causes TCP/IP to randomly assign a free port number.

**Windows** **cadport**

Specifies the required client acceptor service port number. The range of values is 1000 through 32767. If a value is not specified, the default, zero (0), causes TCP/IP to randomly assign a free port number.

**agentport**

Specifies the required web client agent service port number. The range of values is 1000 through 32767. If a value is not specified, the default, zero (0), causes TCP/IP to randomly assign a free port number.

## Examples

---

Options file:

```
webports 2123 2124
```

Command line:

**Windows**

```
webports 2123, 2124
```

**AIX** | **Linux** | **Solaris** | **Mac OS X** Does not apply.

## Wildcardsareliteral

---

The wildcardsareliteral option specifies whether question marks (?) and asterisks (\*) are interpreted literally, when they are included in a file list specification on a filelist option.

Ordinarily, the client does not accept wildcard characters (?) and asterisks (\*) in a file list specification that is included on a filelist option. Some file systems allow single and double quotation marks in file and directory names. To prevent errors that would otherwise occur, when file specifications are included on a filelist option and they contain wildcard characters, set wildcardsareliteral yes. When wildcardsareliteral is set to yes, question marks (?) and asterisks (\*) that are included in a file list specification on the filelist option are interpreted literally, and not as wildcard characters.

This option applies to any command that accepts a filelist option as command parameter.

## Supported Clients

---

This option is valid for all supported platforms. The option is applied to any command that takes a file list specification as a parameter.

## Options File

---

Place this option in the client user options file (dsm.opt).

## Syntax

---

```
>>-WILDCARDSareliteral--no-----+-----<<  
'-yes-'
```



## Parameters

no

Specifies that question marks and asterisks are interpreted as wildcards when used in a file list specification that is included on a filelist option. No is the default. If a file list specification on a filelist option includes a question mark or asterisk, an error occurs and the file specification cannot be processed.

yes

Specifies that asterisks and question marks in a file list specification that is included on a filelist option are interpreted literally, and not as wildcard characters. Specify this value if you are backing up files from a file system that allows wildcard characters in file or directory names.

## Examples

Options file:

```
WILDCARDSARELITERAL YES
```

**Windows** Command line:

**Windows** Assuming that the file system allows wildcard characters in paths, the following are examples of files in a file list specification that can be successfully processed if WILDCARDSARELITERAL is set to YES.

**Windows** Assume that the command issued is `dsmc sel -filelist=c:\important_files.txt`, where `important_files.txt` contains the list of files to process.

**Windows** `important_files.txt` contains the following list of files:

```
c:\home\myfiles\file?9000
c:\home\myfiles\?file
c:\home\myfiles\**README**version2
c:\home\myfiles\ABC?file*
```

**Windows** If both WILDCARDSARELITERAL and QUOTESARELITERAL are both set to YES, the following backups can be successfully processed:

```
c:\home\myfiles\"file?
c:\home\myfiles\?file'
c:\home\myfiles\**"README Tomorrow"**
c:\home\myfiles\file*
```

**AIX** | **Linux** | **Mac OS X** | **Solaris** Command line:

**AIX** | **Linux** | **Mac OS X** | **Solaris** Assuming that the file system allows wildcard characters in paths, the following are examples of files in a file list specification that can be successfully processed if WILDCARDSARELITERAL is set to YES.

**AIX** | **Linux** | **Mac OS X** | **Solaris** Assume that the command issued is `dsmc sel -filelist=/home/user1/important_files`, where `important_files.txt` contains the list of files to process.

**AIX** | **Linux** | **Mac OS X** | **Solaris** `important_files.txt` contains the following list of files:

```
/home/user1/myfiles/file?9000
/home/user1/myfiles/?file
/home/user1/myfiles/**README**version2
/home/user1/myfiles/ABC?file*
```

**AIX** | **Linux** | **Mac OS X** | **Solaris** If both WILDCARDSARELITERAL and QUOTESARELITERAL are both set to YES, the following backups can be successfully processed:

```
/home/user1/myfiles/"file?
/home/user1/myfiles/?file'
/home/user1/myfiles/**"README Tomorrow"**
/home/user1/myfiles/file*
```

## Using commands

The backup-archive client provides a command-line interface (CLI) that you can use as an alternative to the graphical user interface (GUI). This topic describes how to start or end a client command session and how to enter commands.

- Start and end a client command session
- Enter client command names, options, and parameters
- Wildcard characters

The following table provides an alphabetical list of the commands and a brief description.

Table 1. Commands

Command	Description
archive	Archives files from a workstation to IBM Spectrum Protect™ storage.
<b>Windows</b> archive fastback	<b>Windows</b> Archives volumes specified by the fbpolycname, fbclientname and fbvolumename options for long term retention.
<b>Linux</b> <b>Windows</b> backup fastback	<b>Linux</b> <b>Windows</b> Backs up volumes specified by the fbpolycname, fbclientname and fbvolumename options for long term retention.
backup group	Creates and backs up a group containing a list of files from one or more file space origins to a virtual file space on the IBM Spectrum Protect server.
<b>AIX</b> <b>Linux</b> <b>Solaris</b> <b>Windows</b> backup image	<b>AIX</b> <b>Linux</b> <b>Solaris</b> <b>Windows</b> Creates an image backup of one or more file systems or logical volumes that you specify.
<b>AIX</b> <b>Linux</b> <b>Solaris</b> <b>Windows</b> backup nas	<b>AIX</b> <b>Linux</b> <b>Solaris</b> <b>Windows</b> Creates an image backup of one or more file systems belonging to a Network Attached Storage (NAS) file server.
<b>Windows</b> backup systemstate	<b>Windows</b> Backs up all startable system state and system services components as one object to provide a consistent point-in-time snapshot of the system state. This command is valid for any supported Windows client.
<b>Linux</b> <b>Windows</b> backup vm	<b>Linux</b> <b>Windows</b> Backs up virtual machines specified in the vmlist option.
<b>AIX</b> <b>Solaris</b> <b>Windows</b> cancel process	<b>AIX</b> <b>Solaris</b> <b>Windows</b> Displays a list of current NAS (if NDMP support is enabled) image backup and restore processes for which the administrative user has authority.
cancel restore	Displays a list of restartable restore sessions from which you can select one to cancel.
delete access	Deletes authorization rules for files that are stored on the server. <b>AIX</b> <b>Linux</b> <b>Solaris</b> <b>Windows</b> On those clients that support image backup, this command deletes authorization rules for images that are stored on the server.
delete archive	Deletes archived files from IBM Spectrum Protect server storage.
delete backup	Deletes active and inactive backup files from IBM Spectrum Protect server storage.
delete filespace	Deletes file spaces in IBM Spectrum Protect server storage.
delete group	Deletes a group backup on the IBM Spectrum Protect server.
expire	Inactivates backup objects that you specify in the file specification or with the filelist option.
help	Displays a Table of Contents of help topics for the command-line client.
incremental	<b>Mac OS X</b> <b>AIX</b> <b>Linux</b> <b>Solaris</b> <b>Mac OS X</b> <b>Windows</b> Backs up all new or changed files or directories in the default client domain or from file systems, directories, or files you specify, unless you exclude them from backup services.
loop	Starts an interactive command session.
macro	Executes commands within a macro file that you specify.
<b>AIX</b> <b>Linux</b> <b>Solaris</b> <b>Windows</b> monitor process	<b>AIX</b> <b>Linux</b> <b>Solaris</b> <b>Windows</b> Displays a list of current NAS image backup and restore processes from which you can select one to cancel.
preview archive	Simulates an archive command without sending data to the server.
preview backup	Simulates a backup command without sending data to the server.
query access	Displays a list of current authorization rules.
<b>Windows</b> query adobjects	<b>Windows</b> Displays a list of current authorization rules.
query archive	Displays a list of archived files.
query backup	Displays a list of backup versions.

Command	Description
query backupset	Queries a backup set from a local file or the IBM Spectrum Protect server. On those clients that support tape devices, this command can query a backup set from a tape device.
query filespace	Displays a list of file spaces in IBM Spectrum Protect storage. You can also specify a single file space name to query.
query group	Displays information about group backups and their members.
<b>AIX</b>   <b>Linux</b>   <b>Solaris</b>   <b>Windows</b> query image	<b>AIX</b>   <b>Linux</b>   <b>Solaris</b>   <b>Windows</b> Displays information about image backups.
query inclexcl	Displays a list of include-exclude statements in the order in which they are processed during backup and archive operations.
query mgmtclass	Displays information about available management classes.
query node	Displays all the nodes for which an administrative user ID has authority to perform operations.
query options	Displays all or part of your options and their current settings.
query restore	Displays a list of your restartable restore sessions in the server database.
query schedule	Displays information about scheduled events for your node.
query session	Displays information about your session, including the current node name, when the session was established, server information, and server connection information.
query systeminfo	Gathers IBM Spectrum Protect system information and outputs this information to a file or the console.
<b>Windows</b> query systemstate	<b>Windows</b> Displays information about the backup of the system state on the IBM Spectrum Protect server. This command is valid for all supported Windows clients.
<b>Windows</b>   <b>Linux</b> query vm	<b>Windows</b>   <b>Linux</b> Verifies the successful backups of the virtual machines from the vStorage backup server.
restart restore	Displays a list of restartable restore sessions from which you can one to restart.
restore	Restores copies of backup versions of your files from the IBM Spectrum Protect server.
<b>Windows</b> restore adobjects	<b>Windows</b> Restores individual Active Directory objects from the local Active Directory Deleted Objects container.
restore backupset	Restores a backup set from the IBM Spectrum Protect server or a local file. On those clients that support tape devices, this command can restore a backup set from a tape device.
restore group	Restores specific members or all members of a group backup.
<b>AIX</b>   <b>Linux</b>   <b>Solaris</b>   <b>Windows</b> restore image	<b>AIX</b>   <b>Linux</b>   <b>Solaris</b>   <b>Windows</b> Restores a file system or raw volume image backup.
<b>AIX</b>   <b>Linux</b>   <b>Solaris</b>   <b>Windows</b> restore nas	<b>AIX</b>   <b>Linux</b>   <b>Solaris</b>   <b>Windows</b> Restores the image of a file system belonging to a Network Attached Storage (NAS) file server.
<b>Windows</b> restore systemstate	<b>Windows</b> Restores a backup of the system state. This command is deprecated for online system restore operations. For more information, see Restore Systemstate.
<b>Linux</b>   <b>Windows</b> restore vm	<b>Linux</b>   <b>Windows</b> Restores a full VM backup, and returns the full VM backup files to the vmbackdir directory on the vStorage backup server.
retrieve	Retrieves copies of archived files from the IBM Spectrum Protect server.
schedule	Starts the client scheduler on the workstation.
selective	Backs up selected files.

Command	Description
set access	Authorizes another user to access your backup versions or archived copies. <b>AIX   Linux   Solaris   Windows</b> On those clients that support image backup, this command can set authorization rules for images that are stored on the server.
set event	Allows you to specify the circumstances for when archived data is deleted.
<b>Linux   Windows</b> set netappsvm	<b>Linux   Windows</b> Associates the login credentials for a cluster management server with a NetApp storage virtual machine and the data SVM name (data Vserver). This command must be entered before you can create a snapshot difference incremental backup of a clustered NetApp volume.
set password	Changes the IBM Spectrum Protect password for your workstation.



For proper operation, the was node must be restored to the same location and under the same name.

Important: To avoid problems, restore your data at the Network Deployment Manager node or Application Server node level only.

- Start and end a client command session  
You can start or end a client command session in either batch mode or interactive mode.
- Enter client command names, options, and parameters  
A client command can include one or more of these components: *Command name*, *options*, and *parameters*. The topics that follow describe each of these components.
- Wildcard characters  
Use wildcard characters when you want to specify multiple files with similar names in *one* command. Without wildcard characters, you must repeat the command for each file.
- Client commands reference  
The following sections contain detailed information about each of the backup-archive client commands.
- Archive  
The archive command archives a single file, selected files, or all files in a directory and its subdirectories on a server.
- **Linux | Windows** Archive FastBack  
Use the archive fastback command to archive Tivoli® Storage Manager FastBack volumes specified by the fbpolycname, fbclientname and fbvolumename options for long-term retention.
- **Linux | Windows** Backup FastBack  
Use the backup fastback command to back up Tivoli Storage Manager FastBack volumes specified by the fbpolycname, fbclientname and fbvolumename options for long-term retention.
- Backup Group  
Use the backup group command to create and back up a group containing a list of files from one or more file space origins to a virtual file space on the IBM Spectrum Protect server.
- **AIX | Linux | Solaris | Windows** Backup Image  
The backup image command creates an image backup of one or more volumes on your system.
- **AIX | Solaris | Windows** Backup NAS  
The backup nas command creates an image backup of one or more file systems that belong to a Network Attached Storage (NAS) file server, otherwise known as NDMP Backup. You are prompted for the IBM Spectrum Protect administrator ID.
- **Windows** Backup Systemstate  
Use the backup systemstate command to back up all bootable system state and system services components as a single object, to provide a consistent point-in-time snapshot of the system state.
- **Linux | Windows** Backup VM  
Use the backup vm command to start a full backup of a virtual machine.
- **AIX | Solaris | Windows** Cancel Process  
The cancel process command displays a list of current NAS (if NDMP support is enabled) image backup and restore processes for which the administrative user has authority. You are prompted for the IBM Spectrum Protect administrator ID.
- Cancel Restore  
The cancel restore command displays a list of your restartable restore sessions in the server database.
- Delete Access  
The delete access command deletes authorization rules for files that are stored on the server.
- Delete Archive  
The delete archive command deletes archived files from IBM Spectrum Protect server storage. Your administrator must give you the authority to delete archived files.

- **Delete Backup**  
The delete backup command deletes files, images, and virtual machines that were backed up to IBM Spectrum Protect server storage. Your administrator must give you authority to delete objects.
- **Delete Filespace**  
The delete filespace command deletes file spaces in IBM Spectrum Protect server storage. A file space is a logical space on the server that contains files you backed up or archived.
- **Delete Group**  
Use the delete group command to delete a group backup on the IBM Spectrum Protect server.
- **Expire**  
The expire command deactivates the backup objects that you specify in the file specification or with the filelist option. You can specify an individual file to expire, or a file that contains a list of files to expire. If `OBJTYPE=VM`, this command deactivates the current backup for a virtual machine.
- **Help**  
Use the help command to display information about commands, options, and messages.
- **Incremental**  
The incremental command backs up all new or changed data in the locations that you specify, unless you exclude them from backup services.
- **Loop**  
The loop command starts an interactive command line session that is maintained until you enter `quit`.
- **Macro**  
The macro command runs a series of commands that you specify in a macro file.
- **AIX Solaris Windows Monitor Process**  
The monitor process command displays a list of current NAS (if NDMP support is enabled) image backup and restore processes for which the administrative user has authority. You are prompted for the IBM Spectrum Protect administrator ID.
- **Preview Archive**  
The preview archive command simulates an archive command without sending data to the server.
- **Preview Backup**  
The preview backup command simulates a backup command without sending data to the server.
- **Query Access**  
The query access command shows who was given access to backup versions or archive copies of specific files.
- **Windows Query Adobjects**  
Use the query adobjects command to display information about the deleted objects that are located on the local Active Directory domain.
- **Query Archive**  
The query archive command displays a list of your archived files and the following information about each file: file size, archive date, file specification, expiration date, and archive description.
- **Query Backup**  
The query backup command displays a list of backup versions of your files that are stored on the IBM Spectrum Protect server, or that are inside a backup set from the server when the `backupsetname` option is specified.
- **Query Backupset**  
The query backupset command queries a backup set from a local file, tape device (if applicable), or the IBM Spectrum Protect server.
- **Query Filespace**  
The query filespace command displays a list of file spaces for a node. The file spaces are stored on the IBM Spectrum Protect server, or inside a backup set from the server when the `backupsetname` option is specified. You can also specify a single file space name to query.
- **Query Group**  
Use the query group command to display information about a group backup and its members.
- **Query Image**  
The query image command displays information about file system images that are stored on the IBM Spectrum Protect server, or that are inside a backup set from the IBM Spectrum Protect server, when the `backupsetname` option is specified.
- **Query Inclexcl**  
The query inclexcl command displays a list of include-exclude statements in the order in which they are processed during backup and archive operations. The list displays the type of option, the scope of the option (archive, all, and so on), and the name of the source file.
- **Query Mgmtclass**  
The query mgmtclass command displays information about the management classes available in your active policy set.
- **Query Node**  
The query node command displays all the nodes for which an administrative user ID has authority to perform operations. You are prompted for the IBM Spectrum Protect administrator ID.

- **Query Options**  
Use the query options command to display all or part of your options and their current settings that are relevant to the command-line client.
- **Query Restore**  
The query restore command displays a list of your restartable restore sessions in the server database. The list contains these fields: owner, replace, subdir, preservepath, source, and destination.
- **Query Schedule**  
The query schedule command displays the events that are scheduled for your node. Your administrator can set up schedules to perform automatic backups and archives for you. To plan your work, use this command to determine when the next scheduled events occur.
- **Query Session**  
The query session command displays information about your session, including the current node name, when the session was established, server information, and server connection information.
- **Query Systeminfo**  
Use the query systeminfo command to gather information and output this information to a file or the console.
- **Windows Query Systemstate**  
Use the query systemstate command to display information about a backup of the system state on the IBM Spectrum Protect server, or system state inside a backup set from the IBM Spectrum Protect server, when the backupsetname option is specified.
- **Linux Windows Query VM**  
Use the query VM command to list and verify the successful backups of virtual machines (VMs).
- **Restart Restore**  
The restart restore command displays a list of your restartable restore sessions in the server database.
- **Restore**  
The restore command obtains copies of backup versions of your files from the IBM Spectrum Protect server, or inside a backup set.
- **Windows Restore Abjects**  
Use the restore abjects command to restore individual Active Directory objects from the local Deleted Objects container.
- **Restore Backupset**  
The restore backupset command restores a backup set from the IBM Spectrum Protect server, a local file, or a local tape device. You can restore the entire backup set, or, in some cases, specific files within the backup set.
- **Restore Group**  
Use the restore group command to restore specific members or all members of a group backup.
- **AIX Linux Solaris Windows Restore Image**  
The restore image command restores a file system or raw volume image that was backed up using the backup image command.
- **AIX Solaris Windows Restore NAS**  
The restore nas command restores the image of a file system that belongs to a Network Attached Storage (NAS) file server. When you are using an interactive command-line session with a non-administrative ID, you are prompted for an administrator ID.
- **Windows Restore Systemstate**  
The restore systemstate command is deprecated for online system state restore operations.
- **Linux Windows Restore VM**  
Use the restore vm command to restore a virtual machine that was previously backed up.
- **Retrieve**  
The retrieve command obtains copies of archived files from the IBM Spectrum Protect server. You can retrieve specific files or entire directories.
- **Schedule**  
The schedule command starts the client scheduler on your workstation. The client scheduler must be running before scheduled work can start.
- **Selective**  
The selective command backs up files that you specify. If you damage or mislay these files, you can replace them with backup versions from the server.
- **Set Access**  
The set access command gives users at other nodes access to your backup versions or archived copies.
- **Set Event**  
Using the set event command, you can specify the circumstances for when archived data is deleted.
- **Set Netappsvm**  
The set netappsvm command associates the logon credentials for a cluster management server, which are specified on the set password command, with a NetApp storage virtual machine, and the data storage virtual machine (SVM) name (data Vserver). You must enter this command before you can create a snapshot difference incremental backup of a clustered NetApp volume.

- Set Password  
The set password command changes the IBM Spectrum Protect password for your workstation, or sets the credentials that are used to access another server.
-   Set Vmtags  
The set vmtags command creates data protection tags and categories that can be added to VMware inventory objects. You can manage IBM Spectrum Protect backups of virtual machines in these VMware objects by specifying the tags with tools such as VMware vSphere PowerCLI Version 5.5 R2 or later.

**Related reference:**

Reading syntax diagrams

## Start and end a client command session

---

You can start or end a client command session in either batch mode or interactive mode.

Use batch mode when you want to enter a *single* client command. The backup-archive client processes the command and returns to the command prompt.

Use interactive mode when you want to enter a *series* of commands. Since the client establishes connection to the server only once for interactive mode, a series of commands can be processed more quickly. The client processes the commands and returns to the `Protect>` prompt.

- Process commands in batch mode  
Some options are valid *only* on the initial command line and not in interactive mode. These options generally affect the operation of the entire session.
- Process commands in interactive mode  
Use the *interactive* mode (or *loop* mode) to enter a series of commands.

## Process commands in batch mode

---

Some options are valid *only* on the initial command line and not in interactive mode. These options generally affect the operation of the entire session.

For example, the command **dsmc query session -errorlogname=myerror.log** is accepted and it does name the error log. However, it is accepted simply because it appears in the initial command, even though the option is not valid for the query command.

There are also some options that are always valid on the initial command line as well as on individual commands in interactive mode. Therefore, certain options are accepted on the initial command line even though they have no effect on the command being entered. For example, **dsmc query session -subdir=yes** is a valid command, but in this case the `-subdir` option has no effect on the command that was entered.

When you enter a *single* command in batch mode, precede it with the executable program name, **dsmc**. For example, to process the incremental command in batch mode, you would enter:

```
dsmc incremental
```

The backup-archive client prompts you each time you enter a command if the `passwordaccess` option is set to `prompt` and authentication on the server is set to `On`. Type your password and press Enter.

You can also enter your password using the `password` option with a command, but your password appears on the screen. For example, if your password is **secret**, enter:

```
dsmc incremental -password=secret
```

If you set the `passwordaccess` option to `generate` in your `dsm.opt` file, you do not need to specify the password with the command. The client only prompts you for your password if you are registering your workstation with a server or manually changing your password.

## Process commands in interactive mode

---

Use the *interactive* mode (or *loop* mode) to enter a series of commands.

Enter `dsmc` on the command line and press Enter. When the `Protect>` command prompt appears, type the command name and press Enter. Do not precede each command with the executable program name, `dsmc`. Alternatively, you can enter `dsmc loop` on the command line to start a client command session in interactive mode. `loop` is the default command for `dsmc`.

If a password is required, the backup-archive client prompts you before you enter the first command.

**Windows** Type your password and press Enter.

**AIX** | **Linux** | **Solaris** | **Mac OS X** Type your user ID and password and press Enter.

You can also enter your password using the password option with the `loop` command, but your password appears on the screen. For example, if your password is **secret**, enter:

```
dsmc loop -password=secret
```

To end an interactive session, enter `quit` at the prompt.

**AIX** | **Linux** | **Solaris** | **Mac OS X** Note for UNIX and Linux clients:

In loop mode, following a restore operation directly from tape, the mount point is not released in case additional restore requests are made to that volume. If you request a backup operation in the same session and that mount point is the only one available, the backup operation will stop with the following message:

```
Waiting for mount of offline media
```

In this case, the mount point is not released until one of the following conditions is met:

- The device class MOUNTRETENTION limit is satisfied.
- The client idletimeout period is satisfied.
- The `dsmc loop` session is closed after the restore operation completes, allowing you to start a subsequent loop mode session to perform the backup operation.

## Enter client command names, options, and parameters

---

A client command can include one or more of these components: *Command name*, *options*, and *parameters*. The topics that follow describe each of these components.

- **Command name**  
The first part of a command is the command name. The command name consists of a single word, such as **help** or **schedule**, or an action word and an object for that action, such as **query archive**.
- **Options**  
When you enter options with a command, always precede the option with a dash (`-`). Do not put a space between the dash and the option name.
- **Parameters**  
Commands can have required parameters, optional parameters, or no parameters at all.
- **File specification syntax**  
There are some syntax rules that you need to know about when entering file specification parameters such as `filespec`, `sourcefilespec`, and `destinationfilespec`.

## Command name

---

The first part of a command is the command name. The command name consists of a single word, such as **help** or **schedule**, or an action word and an object for that action, such as **query archive**.

Enter the full command name, or its minimum abbreviation.

For example, you can enter any of the following versions of the `query schedule` command:

```
query schedule
q sc
q sched
query sc
```

## Options

---



When you enter options with a command, always precede the option with a dash (-). Do not put a space between the dash and the option name.

Enter more than one option in any order in a command before or after the file specification. Separate multiple options with a blank space.

There are two groups of options that you can use with commands: Client options (set in your options file), or client command options (used on the command line).

- **Client options:** The group of options that are set in your client options file. You can override an option in the client options file when you enter the option with a command on the command line.
- **Client command options:** Use a client command option *only* when you enter the option with a command on the command line. You cannot set these options in an options file.
- Options in interactive mode  
In interactive mode, options that you enter on the initial command line override the value that you specified in your options file.

## Parameters

---

Commands can have required parameters, optional parameters, or no parameters at all.

Required parameters provide information to perform a task. The most commonly required parameter is a file specification.

For example, if you want to archive a file named budget.fin from the project directory, you would enter the following:

```
AIX Linux Solaris Mac OS X Mac OS X
```

```
dsmc archive /project/budget.fin
```

```
Windows
```

```
dsmc archive c:\project\budget.fin
```

Some commands have optional parameters. If you do not enter a value for an optional parameter, the backup-archvie client uses the default value. For example, the restore command includes a required parameter, sourcefilespec, that specifies the path and file name in storage that you want to restore. The optional parameter, destinationfilespec, specifies the path where you want to place the restored files. If you do not specify the destinationfilespec, by default, the client restores the files to the original source path. If you want to restore the files to a *different* directory, enter a value for destinationfilespec.

```
AIX Linux Solaris Mac OS X Mac OS X
```

Example: Restore the file /project/budget.fin to the new path /newproj/newbudg.fin

```
dsmc restore /project/budget.fin /newproj/
```

```
Windows
```

Example: Restore the file c:\project\budget.fin to the new path c:\newproj\newbudg.fin

```
dsmc restore c:\project\budget.fin c:\newproj\newbudg.fin
```

Enter parameters in the order indicated in the command syntax diagram.

## File specification syntax

---

There are some syntax rules that you need to know about when entering file specification parameters such as filespec, sourcefilespec, and destinationfilespec.

The following are the syntax rules:

- Do not use wildcards as part of the file space name or anywhere in the destinationfilespec. The one exception to this rule is the set access command where wildcards are permitted in the two lowest levels of the file spec.

```
AIX Linux Solaris Mac OS X
```

Example: Allow access to all files in all directories in and subordinate to the /home directory:

```
set access backup /home/* * *
set access backup /home/*/* * *
```

**AIX** | **Linux** | **Solaris** | **Mac OS X** With UNIX clients, do not use wildcards in a directory path name, for example:

```
/home/j*asler/file1.c
```

**Windows**

Example: Allow access to all files in all directories in and subordinate to the d:\test directory:

```
set access backup d:\test\* * *
set access backup d:\test\*\* * *
```

- There is a maximum number of file specifications per command:
  - The Query commands can accept only one file specification.
  - The restore and retrieve commands can accept a source file specification and a destination file specification.
  - **AIX** | **Linux** | **Solaris** | **Mac OS X** There is a limit of 20 operands on some commands. This limit is to prevent excessive sessions that are caused when wildcards are expanded by the UNIX shell command processor. You can prevent shell expansion from causing you to go over the 20-operand limit by placing quotation marks around your source filespec expansion characters for restore commands. Note: Using quotation marks has the side affect of causing a no-query restore.

You can use the `removeoperandlimit` option to specify that the backup-archive client removes the 20-operand limit. If you specify the `removeoperandlimit` option with the `incremental`, `selective`, or `archive` commands, the 20-operand limit is not enforced and is restricted only by available resources or other operating system limits.

- The length of a file specification is limited.
  - **AIX** | **Solaris** | **Mac OS X** On AIX, Solaris, and Mac: The maximum number of characters for a file name is 255. The maximum combined length of the file name and path name is 1024 characters. The Unicode representation of a character can occupy several bytes, so the maximum number of characters that a file name might contain can vary.
  - **Linux** On Linux: The maximum length for a file name is 255 bytes. The maximum combined length of both the file name and path name is 4096 bytes. This length matches the `PATH_MAX` that is supported by the operating system. The Unicode representation of a character can occupy several bytes, so the maximum number of characters that comprises a path and file name can vary. The actual limitation is the number of bytes in the path and file components, which might correspond to an equal number of characters.
    - **Linux** On Linux: For archive or retrieve operations, the maximum length that you can specify for a path and file name (combined) remains at 1024 bytes.
  - **Windows** The maximum number of bytes for a file name and file path when combined is 6255. However, the file name itself cannot exceed 255 bytes. Furthermore, directory names (including the directory delimiter) within a path are limited to 255 bytes. The Unicode representation of a character can occupy several bytes, so the maximum number of characters that a file name might contain can vary.

When using the open file support feature with VSS, the backup-archive client adds the snapshot volume name to the path of the objects being processed. The resulting path (snapshot volume name plus object path) must adhere to the limits shown. The snapshot volume name can be up to 1024 bytes.

- **AIX** | **Linux** | **Solaris** | **Mac OS X** When you enter the `sourcefilespec`, if the directory name ends with `/`, then `/*` is implied.

**Windows** When you enter the `sourcefilespec`, if the directory name ends with `\`, then `\*` is implied.

**AIX** | **Linux** | **Solaris** | **Mac OS X** When you enter a `destinationfilespec`, if the name ends with `/`, then it is considered a directory, otherwise it is considered a file.

**Windows** When you enter a `destinationfilespec`, if the name ends with `\`, then it is considered a directory, otherwise it is considered a file.

**AIX** | **Linux** | **Solaris** | **Mac OS X** The following example illustrates these two rules. Even though `mydir` and `yourdir` are directories, the command will fail because `/*` is implied after `mydir`, and `yourdir` is considered a file.

```
restore /home/mydir/ /away/yourdir
```

**Windows** The following example illustrates these two rules. Even though `mydir` and `yourdir` are directories, the command will fail because `\*` is implied after `mydir`, and `yourdir` is considered a file.

```
restore c:\home\mydir\ c:\away\yourdir
```

- **AIX** **Linux** **Solaris** **Mac OS X** **Windows**

If a file specification does not begin with a directory delimiter, the file specification is assumed to be a subdirectory of the current working directory. The client appends the file specification to the working directory to build the complete path.

**AIX** **Linux** **Solaris** **Mac OS X** For example, if the current working directory is /home/me and the command is `dsmc res "/fs/dir1/*" mydir/`, the complete restore path is this: /home/me/mydir

**Windows** For example, if the current working directory is c:\home\me and the command is `dsmc res c:\fs\dir1\mydir\`, the complete restore path is this: c:\home\me\mydir

- **AIX** **Linux** **Solaris** **Mac OS X** The only command that accepts a simple file space name is the incremental command. The following example is valid:

**AIX** **Linux** **Solaris** **Mac OS X**

```
dsmc i /Users
```

The following example is not valid, because the command is the selective command:

**AIX** **Linux** **Solaris** **Mac OS X**

```
dsmc sel /Users
```

- **Windows** When a file specification contains spaces, it must be enclosed in quotation marks. For example:

```
dsmc sel "x:\dir one\file1"
```

When a file specification ends with a backslash and is enclosed in quotation marks, an extra backslash (\) must be added to the end of the file specification. If an extra backslash is not added, the filespec will not be processed correctly, and the operation might cause unexpected results.

The following example is incorrect:

```
dsmc sel "x:\dir one\"
```

The following example is correct:

```
dsmc sel "x:\dir one\\"
```

Here is an example of restoring the contents of one directory to another, when both directory names contain spaces:

```
dsmc rest "x:\dir one\\" "x:\dir two\\"
```

- **Windows** Microsoft Dfs volumes are accessed using the standard UNC names. The following are examples of valid syntax to access MS Dfs volumes:

```
\\Server_Name\Dfs_Root_Name\path  
\\Fault_Tolerant_Name\Dfs_Root_Name\path
```

## Wildcard characters

Use wildcard characters when you want to specify multiple files with similar names in *one* command. Without wildcard characters, you must repeat the command for each file.

In a command, you can use wildcard characters in the file name or file extension *only*. You cannot use them to specify destination files, file systems, or server names. You cannot specify a directory whose name contains an asterisk (\*) or a question mark (?).

Valid wildcard characters that you can use include:

\*

Asterisk. Matches zero or more characters.

?

Question mark. Matches any single character at the present position.

The following table shows examples of each wildcard.

Table 1. Wildcard characters

Pattern	Matches	Does not match
---------	---------	----------------

Pattern	Matches	Does not match
<b>Asterisk (*)</b>		
ab*	ab, abb, abxxx	a, b, aa, bb
ab*rs	abrs, abtrs, abrsrs	ars, aabrs, abrss
ab*ef*rs	abefrs, abefghrs	abefr, abers
abcd.*	abcd.c, abcd.txt	abcd, abcdc, abcdtxt
<b>Question Mark (?)</b>		
ab?	abc	ab, abab, abzzz
ab?rs	abfrs	abrs, abllrs
ab?ef?rs	abdefjrs	abefrs, abdefrs, abefjrs
ab??rs	abcdrs, abzzrs	abrs, abjrs, abkkrs

Important: Use an asterisk (\*) instead of a question mark (?) as a wildcard character when trying to match a pattern on a multibyte code page, to avoid unexpected results.

**AIX** | **Linux** | **Solaris** | **Mac OS X** Note: In batch mode, enclose values containing wildcards in quotation marks. Otherwise, UNIX shells expand unquoted wildcards, and it is easy to exceed the 20 operand limit. It is more efficient to let the client process wildcard file specifications because many fewer server interactions are needed to complete the task. For example:

```
dsmsc selective "/home/me/*.c"
```

## Client commands reference

The following sections contain detailed information about each of the backup-archive client commands.

Information for each command includes the following information:

- A description of the command.
- A syntax diagram of the command.
- Detailed descriptions of the command parameters. If the parameter is a constant (a value that does not change), the minimum abbreviation appears in uppercase letters.
- Examples of using the command.

## Archive

The archive command archives a single file, selected files, or all files in a directory and its subdirectories on a server.

Archive files that you want to preserve in their current condition. To release storage space on your workstation, delete files as you archive them using the `deletfiles` option. Retrieve the archived files to your workstation whenever you need them again.

Use the `snapshotroot` option with the archive command along with an independent software vendor application that provides a snapshot of a logical volume to associate the data on the local snapshot with the real file space data that is stored on the IBM Spectrum Protect™ server. The `snapshotroot` option does not provide any facilities to take a volume snapshot, only to manage data that is created by a volume snapshot.

**AIX** AIX® only: You can enable snapshot-based file archive by using the option `snapshotproviderfs=JFS2`.

## Supported Clients

This command is valid for all clients.

## Syntax

```

>>>-----v-----|-----<
>>>-Archive----- --filespec-----+-----<
                                '- --options-'

```

## Parameters

### filespec

Specifies the path and name of the file you want to archive. Use wildcard characters to include a group of files or to include all files in a directory.

To include multiple file specifications, separate each *filespec* parameter with a space character. If multiple file specifications are included, and two or more of the specifications have common parent directories, then it is possible for the common directory objects to be archived more than once. The conditions under which this behavior occurs are runtime-dependent, but the behavior itself has no adverse effects.

**AIX** **Linux** **Mac OS X** **Solaris** For example, if the *filespec* is /home/amr/ice.doc /home/amr/fire.doc, then /home and /home/amr might be archived twice. The file objects ice.doc, and fire.doc, are archived only once.

**Windows** For example, if the *filespec* is C:\proposals\drafts\ice.doc C:\proposals\drafts\fire.doc, then C:\proposals and C:\proposals\drafts might be archived twice. The file objects ice.doc and fire.doc are archived only once.

If you want to avoid including the shared parent directory more than once, use separate, non-overlapping archive commands to archive each file specification.

**AIX** **Linux** **Mac OS X** **Solaris** If you archive a file system, include a trailing slash (/home/).

**AIX** **Linux** **Mac OS X** **Solaris** There is a limit of 20 operands. This limit prevents excessive sessions that are caused when wildcards are expanded by the UNIX shell command processor. You can prevent shell expansion from causing you to go over the 20-operand limit by placing quotation marks around file specifications that contain wildcards ("home/docs/\*").

**AIX** **Linux** **Mac OS X** **Solaris** You can use the *removeoperandlimit* option to specify that the 20-operand limit is removed. If you specify the *removeoperandlimit* option, the 20-operand limit is not enforced and is restricted only by available resources or other operating system limits. For example, remove the 20 operand limit to archive 21 file specifications:

```
selective -removeoperandlimit filespec1 filespec2 ... filespec21
```

**Windows** If you archive a file system, include a trailing slash (C:\).

**Windows** You can specify as many file specifications as available resources or other operating system limits allow. You can use the *filelist* option, instead of file specifications, to identify which files to include in this operation. However, these two methods are mutually exclusive. You cannot include file specification parameters and use the *filelist* option. If the *filelist* option is specified, any file specifications that are included are ignored.

Table 1. Archive command: Related options

Option	Where to use
archmc	Command line only.
<b>AIX</b> <b>Linux</b> <b>Solaris</b> <b>Mac OS X</b> archsymlinkasfile	<b>AIX</b> <b>Linux</b> <b>Solaris</b> <b>Mac OS X</b> Client user-options file (dsm.opt) or command line.
<b>Mac OS X</b> <b>Windows</b> autofsrrename	<b>Mac OS X</b> <b>Windows</b> Client options file (dsm.opt) only.
<b>Windows</b> changingretries	<b>Windows</b> Client options file (dsm.opt) or command line.
<b>AIX</b> <b>Linux</b> <b>Solaris</b> <b>Mac OS X</b> changingretries	<b>AIX</b> <b>Linux</b> <b>Solaris</b> <b>Mac OS X</b> Client system options file or command line.
<b>Windows</b> compressalways	<b>Windows</b> Client options file (dsm.opt) or command line.
<b>AIX</b> <b>Linux</b> <b>Solaris</b> <b>Mac OS X</b> compressalways	<b>AIX</b> <b>Linux</b> <b>Solaris</b> <b>Mac OS X</b> Client user-options file (dsm.opt) or command line.
<b>Windows</b> compression	<b>Windows</b> Client options file (dsm.opt) or command line.
<b>AIX</b> <b>Linux</b> <b>Solaris</b> <b>Mac OS X</b> compression	<b>AIX</b> <b>Linux</b> <b>Solaris</b> <b>Mac OS X</b> dsm.sys file within a server stanza or command line.
deletefiles	Command line only.
description	Command line only.
dirsonly	Command line only.
<b>AIX</b> <b>Linux</b> <b>Solaris</b> <b>Mac OS X</b> encryptiontype	<b>AIX</b> <b>Linux</b> <b>Solaris</b> <b>Mac OS X</b> dsm.sys file within a server stanza.

Option	Where to use
<b>Windows</b> encryptiontype	<b>Windows</b> Client options file (dsm.opt).
<b>AIX</b>   <b>Linux</b>   <b>Solaris</b>   <b>Mac OS X</b> encryptkey	<b>AIX</b>   <b>Linux</b>   <b>Solaris</b>   <b>Mac OS X</b> dsm.sys file within a server stanza.
<b>Windows</b> encryptkey	<b>Windows</b> Client options file (dsm.opt).
filelist	Command line only.
filesonly	Command line only.
<b>Windows</b> postsnapshotcmd	<b>Windows</b> Client options file (dsm.opt) or with the include.fs option.
<b>AIX</b>   <b>Linux</b>   <b>Solaris</b>   <b>Mac OS X</b> preservelastaccessdate	<b>AIX</b>   <b>Linux</b>   <b>Solaris</b>   <b>Mac OS X</b> Client user-options file (dsm.opt) or command line.
<b>Windows</b> preservelastaccessdate	<b>Windows</b> Client options file (dsm.opt) or command line.
<b>Windows</b> presnapshotcmd	<b>Windows</b> Client options file (dsm.opt) or with the include.fs option.
<b>AIX</b>   <b>Linux</b>   <b>Solaris</b>   <b>Mac OS X</b> removeoperandlimit	<b>AIX</b>   <b>Linux</b>   <b>Solaris</b>   <b>Mac OS X</b> Command line only.
<b>Windows</b> skipntpermissions	<b>Windows</b> Client options file (dsm.opt) or command line.
<b>Windows</b> skipntsecuritycrc	<b>Windows</b> Client options file (dsm.opt) or command line.
<b>AIX</b>   <b>Linux</b>   snapshotcachesize	<b>AIX</b>   <b>Linux</b> Client options file (dsm.opt) or include.fs option.
snapshotroot	Command line only.
subdir	Client options file (dsm.opt) or command line.
tapeprompt	Client options file (dsm.opt) or command line.
v2archive	Command line only.

## Examples

**AIX** | **Linux** | **Solaris** | **Mac OS X** Task

**AIX** | **Linux** | **Solaris** | **Mac OS X** Archive a single file that is named `budget` in the `/home/proj1` directory.

**Command:** `archive /home/proj1/budget`

**Windows** Task

**Windows** Archive a single file that is named `budget.jan` in the `c:\plan\proj1` directory.

**Command:** `archive c:\plan\proj1\budget.jan`

**AIX** | **Linux** | **Solaris** | **Mac OS X** Task

**AIX** | **Linux** | **Solaris** | **Mac OS X** Archive all files in the `/home/proj1` directory with a file extension of `.txt`.

**Command:** `archive "/home/proj1/*.txt"`

**Windows** Task

**Windows** Archive all files in the `c:\plan\proj1` directory with a file extension of `.txt`.

**Command:** `archive c:\plan\proj1\*.txt`

**AIX** | **Linux** | **Solaris** | **Mac OS X** Task

**AIX** | **Linux** | **Solaris** | **Mac OS X** Archive all files in the directory tree that is headed by the `/home` directory.

**Command:** `archive -subdir=yes "/home/*"`

**Windows** Task

**Windows** Archive all files in the `c:\` drive.

**Command:** `archive -subdir=yes c:\*.*`

**Windows** Task

**Windows** Archive all files in the Microsoft Dfs volume, MyDfsVolume. You must specify **subdir=yes** to archive *all* files in the volume.

**Command:** archive \\myserver\mydfsroot\mydfsvolume\\*. \* -subdir=yes

**AIX** | **Linux** | **Solaris** | **Mac OS X** | **Task**

**AIX** | **Linux** | **Solaris** | **Mac OS X** Assuming that you initiated a snapshot of the /usr file system and mounted the snapshot as /snapshot/day1, archive the /usr/dir1/sub1 directory tree from the local snapshot and manage it on the IBM Spectrum Protect server under the file space name /usr.

**Command:** dsmc archive /usr/dir1/sub1/ -subdir=yes -snapshotroot=/snapshot/day1

**Windows** | **Task**

**Windows** Assuming that you initiated a snapshot of the C:\ drive and mounted the snapshot as \\florence\c\$\snapshots\snapshot.0, archive the c:\dir1\sub1 directory tree from the local snapshot and manage it on the IBM Spectrum Protect server under the file space name C:.

**Command:** dsmc archive c:\dir1\sub1\\* -subdir=yes -snapshotroot=\\florence\c\$\snapshots\snapshot.0

- **Windows** Open file support  
If open file support has been configured, the backup-archive client performs a snapshot backup or archive of files that are locked (or "in use") by other applications.

**Linux** | **Windows**

## Archive FastBack

Use the archive fastback command to archive Tivoli® Storage Manager FastBack volumes specified by the fbpolycyname, fbclientname and fbvolumename options for long-term retention.

Before using this command, configure the client to back up and archive Tivoli Storage Manager FastBack data. Also, before you issue this command, at least one snapshot should exist in the FastBack repository for the FastBack policy being archived or backed up.

**Windows** If a policy specification contains both Windows and Linux FastBack clients, only the Windows volumes will be backed up or archived to the IBM Spectrum Protect™ server by the Windows backup-archive client.

**Linux** If a policy specification contains both Windows and Linux FastBack clients, only the Linux volumes will be backed up or archived to the IBM Spectrum Protect server by the Linux backup-archive client.

You can use Tivoli Storage Manager FastBack options to archive the latest snapshots of the following volumes:

- All clients and volumes associated with a specific FastBack policy or a list of FastBack policies.
- All volumes associated with a specific FastBack client or a list of FastBack clients for a given FastBack policy.
- A specific volume or volumes associated with a specific FastBack client for a given FastBack policy.

## Supported Clients

**Linux** This option is valid for Linux x86\_64 clients.

**Windows** This option is valid for all Windows clients that are configured as FastBack dedicated proxies. This command is also valid for Windows clients that are installed on the FastBack server workstation, or the FastBack Disaster Recovery Hub.

## Syntax

```

      .-.-.-.-.
      V         |
>>-ARCHIVE FASTBack--FBPolycyname-----name+----->
>>-FBServer---name--+-----+----->
      |
      |         .-.-.-.-. |
      |         V         | |
      '-FBClientname-----name-+-'
```

```

>----->
|          .-.-. |
|          v     |
|'-FBVolumename-----name-+'
>----->
|'-FBReposlocation-----name-'  '-FBBranch-----name-'
>----->>
|'-ARCHMc-----name-'

```

**Important:**

1. At least one FBpolicyName is always required.
2. You can specify up to 10 values for FBPolicyName, if no values are specified for both FBClientName and FBVolumeName.
3. When you specify a FBClientName value, there must be only one value for FBPolicyName.
4. You can specify up to 10 values for FBClientName if only one PolicyName is specified, and no values for FBVolumeName are specified.
5. When you specify the FBVolumeName option, you can have only one FBPolicy, and only one FBClientName specified.
6. You can specify multiple FBVolumeNames if condition 5 is satisfied.
7. You must always specify the FBReposLocation option for Linux.

## Parameters

Table 1. Archive FastBack command: Related options

Option	Where to use
fbpolicyname	Command line and scheduler.
fbserver	Command line and scheduler.
fbclientname	Command line and scheduler.
fbvolumename	Command line and scheduler.
fbreposlocation	Command line and scheduler.
fbbranch	Command line and scheduler.
archmc	Command line and scheduler.

## Examples

**Linux** Command line:

**Linux** The backup-archive client is installed on a Linux proxy client machine. Use this command to archive all FastBack volumes for all Linux FastBack clients that are defined for FastBack policy1:

```
dsmc archive fastback -fbpolicyname=Policy1
-fbserver=myfbserver -fbreposlocation=myfbserver@WORKGROUP
```

The FastBack server name, -myFbDrHub is the short host name of the FastBack Disaster Recovery Hub server where the repository is located.

The -fbreposlocation parameter specifies the location of the repository. The repository location is required. If you do not provide the repository location, the command fails.

FBServer should point to the short host name of the FastBack DR hub in this case.

**Linux** Command line:

**Linux** The repository, rep\_server1, is located on the FastBack DR hub, myFbDrHub.

```
dsmc archive fastback -fbpolicyname="Policy 1"
-fbserver=myFbDrHub -fbreposlocation=\\myFbDrHub\rep_server1
```

The repository location is required. If you do not provide the repository location, the command fails.



The FastBack server name, -myFbDrHub, is the short host name of the FastBack Disaster Recovery Hub where the repository is located.

FBServer should point to the short host name of the FastBack DR hub in this case.

**Linux** Command line:

**Linux** Archive all volumes protected by FastBack policy named policy1 from the FastBack server named basil:

```
dsmc archive fastback -Fbpolicyname=policy1
-FBServer=basil -ARCHMC="my_tsm_mgmt_class"
-fbreposlocation=basil@WORKGROUP
```

**Windows** Command line:

**Windows** The backup-archive client is installed on the FastBack server. Use this command to archive all FastBack volumes for all Windows FastBack clients that are defined for FastBack policy1:

```
dsmc archive fastback -fbpolicyname=Policy1
-fbserver=myfbserver
```

The repository location is not required. If you provide the repository location, it is ignored.

The FastBack server name, -myfbserver, is the short host name of the FastBack server where the client is running.

**Windows** Command line:

**Windows** The backup-archive client is installed on the FastBack Disaster Recovery Hub. Use this command to archive all FastBack volumes for all FastBack clients that are found in the policy named Policy 1:

```
dsmc archive fastback -fbpolicyname="Policy 1"
-fbserver=myFbServer -fbbranch=branch1
```

The repository location is not required. If you provide the repository location, it is ignored.

The parameter myFbServer specifies the short host name of the FastBack Server whose FastBack branch is specified using the FBBranch option

**Windows** Command line:

**Windows** The backup-archive client is installed on a dedicated proxy machine with Tivoli Storage Manager FastBack administrative command line and FastBack mount. The client is connecting to the FastBack server repository. Use this command to archive all FastBack volumes for all FastBack clients that are found in the policy named Policy 1:

```
dsmc archive fastback -fbpolicyname="Policy 1" -fbserver=myFbServer
-fbreposlocation=\\myFbServer.company.com\REP
```

The repository location is required.

The short host name of the machine where the FastBack server is installed is myFbServer.

**Windows** Command line:

**Windows** The backup-archive client is installed on a dedicated proxy machine with Tivoli Storage Manager FastBack administrative command line and FastBack mount. The client is connecting to a remote branch repository on the FastBack Disaster Recovery Hub. Use this command to archive all FastBack volumes for all FastBack clients that are found in the policy named Policy 1:

```
dsmc archive fastback -fbpolicyname="Policy 1" -fbserver=myFbServer
-fbreposlocation=\\myfbdrhub.company.com\REP
-fbbranch=aFbServerBranch
```

The repository location is required.

The myFbServer value specified with the -fbserver option is the short host name of the FastBack Server whose FastBack branch is specified using the FBBranch option.

The fbbranch option specifies the branch ID of the FastBack server on the disaster recovery hub.

**Windows** Command line:

**Windows** Archive all volumes protected by FastBack policy named policy1 from the FastBack server named basil, and apply management class "my\_tsm\_mgmt\_class" to the archived volumes.

```
dsmc archive fastback -Fbpolicyname=policy1
-FBServer=basil -ARCHMC="my_tsm_mgmt_class"
```

**Related concepts:**

Configuring the client to back up and archive Tivoli Storage Manager FastBack data

**Related tasks:**

Configuring backup-archive clients

Linux Windows

## Backup FastBack

---

Use the backup fastback command to back up Tivoli® Storage Manager FastBack volumes specified by the fbpolycyname, fbclientname and fbvolumename options for long-term retention.

Before using this command, configure the client to back up and archive Tivoli Storage Manager FastBack data. Also, before you issue this command, at least one snapshot should exist in the Tivoli Storage Manager FastBack repository for the Tivoli Storage Manager FastBack policy being archived or backed up.

**Windows** If a policy specification contains both Windows and Linux FastBack clients, only the Windows volumes will be backed up or archived to the IBM Spectrum Protect™ server by the Windows backup-archive client.

**Linux** If a policy specification contains both Windows and Linux FastBack clients, only the Linux volumes will be backed up or archived to the IBM Spectrum Protect server by the Linux backup-archive client.

Tivoli Storage Manager FastBack options are supported for the incremental backup of the latest snapshots, depending on the option specified:

- All clients and volumes associated with the FastBack policy or a list of FastBack policies.
- All volumes associated with a specific FastBack client or a list of FastBack clients for a given FastBack policy.
- A specific volume or volumes associated with a specific FastBack client for a given FastBack policy.

## Supported Clients

---

**Linux** This command is valid for Linux x86\_64 clients that are configured as Tivoli Storage Manager FastBack dedicated proxies.

**Windows** This command is valid for all Windows clients that are configured as Tivoli Storage Manager FastBack dedicated proxies. This command is also valid for Windows clients that are installed on the Tivoli Storage Manager FastBack server workstation, or the Tivoli Storage Manager FastBack Disaster Recovery Hub.

Linux

## Syntax

---

```

      .-,----.
      v      |
>>-BACKUP FASTBack--FBPolycyname--=====name+----->
>>-FBServer-----name--+-----+----->
      |
      |      .-,----. |
      |      v      | |
      |'-FBClientname-----name-+-'|
>>-+-----+-----FBReposlocation-----name----->
      |
      |      .-,----. |
      |      v      | |
      |'-FBVolumename-----name-+-'|
>>-+-----+-----+-----+----->>
      |'-FBBranch-----name-' |'-BACKMC-----name-'

```

**Important:**

1. At least one FBpolicyName is always required.
2. You can specify up to 10 values for FBPolicyName, if no values are specified for both FBClientName and FBVolumeName.
3. When you specify a FBClientName value, there must be only one value for FBPolicyName.
4. You can specify up to 10 values for FBClientName if only one PolicyName is specified, and no values for FBVolumeName are specified.

5. When you specify the FBVolumeName option, you can have only one FBPolicy, and only one FBClientName specified.
6. You can specify multiple FBVolumeNames if condition 5 is satisfied.
7. You must specify the FBReposLocation option.

Windows

## Syntax

```

>>-BACKUP FASTBack--FBPolicyname-----name+----->
                                     .-,---. |
                                     V      |
>>-FBServer-----name+----->
                                     |
                                     |                                     .-,---. |
                                     |                                     V      |
                                     | -FBClientname-----name+-----|
>--+-----+----->
|                                     |                                     .-,---. |
|                                     |                                     V      |
| -FBVolumename-----name+-----|
>--+-----+----->
| -FBReposlocation-----name- ' | -FBBranch-----name- '
>--+-----+-----><
| -BACKMc-----name- '

```

### Important:

1. At least one FBpolicyName is always required.
2. You can specify up to 10 values for FBPolicyName, if no values are specified for both FBClientName and FBVolumeName.
3. When you specify a FBClientName value, there must be only one value for FBPolicyName.
4. You can specify up to 10 values for FBClientName if only one PolicyName is specified, and no values for FBVolumeName are specified.
5. When you specify the FBVolumeName option, you can have only one FBPolicy, and only one FBClientName specified.
6. You can specify multiple FBVolumeNames if condition 5 is satisfied.

Table 1. Backup FastBack command: Related options

Option	Where to use
fbpolicyname	Command line and scheduler.
fbserver	Command line and scheduler.
fbclientname	Command line and scheduler.
fbvolumename	Command line and scheduler.
fbreposlocation	Command line and scheduler.
fbbranch	Command line and scheduler.
backmc	Command line and scheduler.

## Examples

Linux Command line:

Linux The backup-archive client is installed on a Linux proxy client machine. Use this command to back up all FastBack volumes for all Linux FastBack clients that are defined for FastBack policy1:

```

dsmc backup fastback -fbpolicyname=Policy1
-fbserver=myfbserver
-fbreposlocation=myfbserver@WORKGROUP

```

The repository location is required. If you do not provide the repository location, the command will fail.

The FastBack server name, -myfbserver, is the short host name of the FastBack server where the repository is located.

**Linux** Command line:

**Linux** The repository, rep\_server1, is located on the FastBack Disaster Recovery Hub, myFbDrHub

```
dsmc backup fastback -fbpolicyname="Policy 1"  
-fbserver=myFbDrHub -fbreposlocation=\\myFbDrHub\rep_server1
```

The FastBack server name, -myFbDrHub, is the short host name of the FastBack Disaster Recovery Hub server where the repository is located.

The -fbreposlocation option specifies the location of the repository. The repository location is required. If you do not provide the repository location, the command fails.

The FBServer option should point to the short host name of the FastBack DR hub in this case.

**Linux** Command line:

**Linux** Back up all volumes protected by FastBack policy named policy1 from the FastBack server named basil:

```
dsmc backup fastback -Fbpolicyname=policy1  
-FBServer=basil -BACKMC="my_tsm_mgmt_class"  
-fbreposlocation=basil@WORKGROUP
```

**Windows** Command line:

**Windows** The backup-archive client is installed on the FastBack server. Use this command to back up all Tivoli Storage Manager FastBack volumes for all Windows FastBack clients that are defined for Tivoli Storage Manager FastBack policy1:

```
dsmc backup fastback -fbpolicyname=Policy1  
-fbserver=myfbserver
```

The repository location is not required. If you provide the repository location, it is ignored.

The FastBack server name, -myfbserver, is the short host name of the FastBack server where the client is running.

**Windows** Command line:

**Windows** The backup-archive client is installed on the FastBack disaster recovery hub. Use this command to back up all FastBack volumes for all FastBack clients that are found in the policy named Policy 1:

```
dsmc backup fastback -fbpolicyname="Policy 1"  
-fbserver=myFbServer -fbbranch=branch1
```

The repository location is not required. If you provide the repository location, it is ignored.

The FastBack server name, myFbServer, is the short host name of the FastBack server whose FastBack branch is specified using the FBBranch option

**Windows** Command line:

**Windows** The backup-archive client is installed on a dedicated proxy machine with FastBack administrative command line and FastBack mount. The client is connecting to the FastBack server repository. Use this command to back up all FastBack volumes for all FastBack clients that are found in the policy named Policy 1:

```
dsmc backup fastback -fbpolicyname="Policy 1" -fbserver=myFbServer  
-fbreposlocation=\\myFbServer.company.com\REP
```

The repository location is required.

The short host name of the machine where the FastBack server is installed is myFbServer.

**Windows** Command line:

**Windows** The backup-archive client is installed on a dedicated proxy machine with FastBack administrative command line and FastBack mount. The client is connecting to a remote branch repository on the FastBack Disaster Recovery Hub. Use this command to back up all FastBack volumes for all FastBack clients that are found in the policy named Policy 1:

```
dsmc backup fastback -fbpolicyname="Policy 1" -fbserver=myFbServer  
-fbreposlocation=\\myfbdrhub.company.com\REP  
-fbbranch=aFbServerBranch
```

The repository location is required.

The myFbServer value specified with the -fbserver option is the short host name of the FastBack Server whose FastBack branch is specified using the FBBranch option.

The fbbranch option specifies the branch ID of the FastBack server on the disaster recovery hub.

**Windows** Command line:

**Windows** Back up all volumes protected by FastBack policy named policy1 from the FastBack server named basil, and apply the management class "my\_tsm\_mgmt\_class" to the backed up volumes:

```
dsmc backup fastback -Fbpolicyname=policy1  
-FBServer=basil -BACKMC="my_tsm_mgmt_class"
```

**Related concepts:**

Configuring the client to back up and archive Tivoli Storage Manager FastBack data

**Related tasks:**

Configuring backup-archive clients

## Backup Group

---

Use the backup group command to create and back up a group containing a list of files from one or more file space origins to a virtual file space on the IBM Spectrum Protect™ server.

**AIX** AIX® only: You can enable snapshot-based group backup by using the option `snapshotproviderfs=JFS2`.

A group backup allows you to create a consistent point-in-time backup of a group of files that is managed as a single logical entity. Objects in the group are subject to the following processing rules:

- Management class rebinding for grouped objects:
  - During full backups, all objects in a backup group are assigned to the same management class.
  - During differential backups, if a new management class is specified on an include statement for an existing backup group, the following behavior occurs:
    - Any new and changed objects in the backup group are bound to the new management class.
    - Any member objects of the group that are not changed appear as though they have not been bound to the new management class. These unchanged objects are not included in the Total number of objects rebound statistics that are displayed when the Backup Group command completes.
    - The unchanged objects are reassigned to a newly created backup group, and the new backup group is bound to the new management class. However, the original management class name is still displayed for the unchanged group objects.

Even though the original management class name is still displayed for the unchanged objects, they are effectively bound to the new management class of the backup group.

- Existing exclude statements for any files in the group are ignored.
- All objects in the group are exported together.
- All objects in the group are expired together as specified in the management class. No objects in a group are expired until all other objects in the group are expired, even when another group they belong to gets expired.
- If you are performing full and differential group backups to a sequential device, during a restore the data is in no more than two locations. To optimize restore time, perform periodic full backups to back up the data to one location on the sequential media.
- During a full group backup, all objects in the filelist are sent to the server. During a differential group backup, only data that has changed since the last full backup is sent to the server. Objects in the filelist that have not changed since the last full backups are assigned as members of the differential group backup. This data is not resent to the server, reducing backup time.

The backup group command requires the following options:

filelist

Specifies a list of files to add to a new group.

groupname

Specifies the fully qualified name of the group containing a list of files.

virtualfsname

Specifies the name of the virtual file space for the group on which you want to perform the operation. The virtualfsname option cannot be the same as an existing file space name.

mode

Specifies whether you want to back up all of the files in the filelist or only files that have changed since the last full backup.

Note:

1. If any file in the group backup fails, the entire group backup fails.
2. Use the query group command to query members of a group backup on the IBM Spectrum Protect server.
3. Use the restore group command to restore specific members or all members of a group backup on the server.
4. Unless you are running Mac OS X, use the delete group command to delete a specific group backup from the server.
5. Use the query filespace command to display virtual file space names for your node that are stored on the server.
6. A group backup can be added to a backup set.

AIX Linux Solaris Windows

## Supported Clients

AIX Linux Solaris This command is valid for all UNIX and Linux clients except Mac OS X.

Windows This command is valid for all Windows clients.

## Syntax

```
>>-Backup Group-- --options-----<<
```

## Parameters

Table 1. Backup Group command: Related options

Option	Where to use
filelist	Command line only.
groupname	Command line only.
mode	Command line only.
AIX snapshotproviderfs	AIX System-options file (dsm.sys) within a server stanza or with the include.fs option.
Windows snapshotproviderfs	Windows Client options file (dsm.opt) or with the include.fs option.
Windows snapshotproviderimage	Windows Client options file (dsm.opt) or with include.image option.
virtualfsname	Command line only.

## Examples

Mac OS X AIX Linux Solaris Task

Mac OS X AIX Linux Solaris Perform a full backup of all the files in the /home/dir1/filelist1 file to the virtual file space name accounting containing the group leader /home/group1 file.

**Command:**

```
backup group -filelist=/home/dir1/filelist1 -groupname=group1  
-virtualfsname=/virtfs -mode=full
```

Windows Task

Windows Perform a full backup of all the files in the c:\dir1\filelist1 file to the virtual file space name \virtfs containing the group leader group1 file.

**Command:**

```
backup group -filelist=c:\dir1\filelist1 -groupname=group1  
-virtualfsname=\virtfs -mode=full
```

AIX Linux Solaris Windows

## Backup Image

The backup image command creates an image backup of one or more volumes on your system.

You can use the backup image command to back up NTFS or ReFS, or unformatted RAW volumes. If a volume is NTFS-formatted, only those blocks that are used by the file system are backed up. On ReFS volumes, all blocks are backed up.

**AIX** If you set the `imagegapsize` option to 0, all blocks, including unused blocks at the end of the volume, are backed up.

**AIX** If you specify an AIX® JFS2 file system for image backup, only those blocks that are used by the file system are backed up. If you set the `imagegapsize` option to zero, all blocks, including blocks at the end of the volume, are backed up.

**AIX** | **Linux** | **Solaris** Note:

1. **AIX** AIX only: By default, snapshot-based image backup is enabled for JFS2 volumes. To turn off snapshot-based image backups, set `-snapshotproviderimage=NONE` on this command.
2. **Linux** For the Linux clients, image backup is only supported on partitions with id 0x83 or logical volumes that are created with the Linux Logical Volume Manager. Backing up other partitions, such as extended partitions that contain mounted file systems or database data, can produce inconsistent backup data if the data changes during the image backup operation.
3. **Linux** For the Linux client, image backup of DASD devices with raw-track access mode on Linux on z Systems™ is not supported.
4. **AIX** | **Linux** Backup image is not supported on any GPFS™ file system.
5. The IBM Spectrum Protect™ API must be installed to use the backup image command.
6. **AIX** When you change the attribute of a JFS2 file system to an HSM-managed file system, an image backup is not done for that file system.

Important: The last incremental backup time refers to the server time and the file modification time refers to the client time. If the client and server time are not synchronized, or the client and server are in different time zones, this affects incremental-by-date backup and image backup where `mode=incremental`.

The client backs up the files that have modification dates and times (on the client) that are later than the date and time of the last incremental backup of the file system on which the file is stored (on the server).

If the server time is ahead of the client time, incremental-by-date backups, or image backup with `mode=incremental`, skip the files, which had been created or modified after the last incremental or image backup with a modification date earlier than the last incremental backup time stamp.

If the client time is ahead of the server time, all files that had been created or modified before the last incremental or image backup and have a modification time stamp later than the last incremental backup time stamp, are backed up again. Typically, these files would not get backed up because they had already been backed up.

The backup date can be checked by the `query filespace` command.

**Windows** Note:

1. The account that is running the backup-archive client must have administrator authority to successfully perform any type of image backup.
2. The API must be installed to use the backup image command.

**AIX** | **Linux** | **Solaris** The backup-archive client must support the raw device type on the specific platform to perform an image backup of a raw device. You can perform an image backup only on local devices. Clustered devices or file systems as well as devices or file systems that are shared between two or more systems are not supported. If you want to perform an image backup for a file system that is mounted on a raw device, the raw device must be supported.

Use the `include.image` option to include a file system or logical volume for image backup, or to specify volume-specific options for image backup.

The backup image command uses the `compression` option.

## Supported Clients

---

**AIX** | **Linux** | **Solaris** This option is valid for AIX, Linux, and Oracle Solaris clients.

**Windows** This command is valid for all Windows platforms.

## Syntax

---

```

      .----- .
      |         |
      v         |
>>-Backup Image-+-----+-----+-----+----->>
      '- --options-'   '- --filespec-'

```

## Parameters

### filespec

Specifies the name of one or more logical volumes. If you want to back up more than one file system, separate their names with spaces. Do not use pattern matching characters. If you do not specify a volume name, the logical volumes that are specified with the domain.image option are processed. If you do not use the domain.image option to specify file systems to process, an error message is displayed and no image backup occurs.

**AIX** **Linux** **Solaris** Specify the file space over which the logical volume is mounted or the logical volume name. If there is a file system that is configured in the system for a given volume, you cannot back up the volume with the device name.

**AIX** **Linux** **Solaris** For example, if the /dev/lv01 file space is mounted on the /home volume, you can issue backup image /home, but backup image /dev/lv01 fails with an error:

```
ANS1063E Invalid path specified
```

**Solaris** Note: For Sun systems, specify either a file system name or a raw device name (block device type).

**Windows** Image backup is only supported on a volume that has a mount or a drive letter assigned to it. A volume without a drive letter or mount point cannot be backed up.

Table 1. Backup Image command: Related options

Option	Where to use
<b>Windows</b> asnodename	<b>Windows</b> Client options file (dsm.opt) or command line.
<b>AIX</b> <b>Linux</b> <b>Solaris</b> asnodename	<b>AIX</b> <b>Linux</b> <b>Solaris</b> Client system options file (dsm.sys) or command line.
<b>AIX</b> <b>Linux</b> <b>Solaris</b> compressalways	<b>AIX</b> <b>Linux</b> <b>Solaris</b> Client system options file (dsm.sys) or command line.
<b>Windows</b> compressalways	<b>Windows</b> Client options file (dsm.opt) or command line.
compression	Client options file or command line.
<b>AIX</b> <b>Linux</b> <b>Solaris</b> dynamicimage	<b>AIX</b> <b>Linux</b> <b>Solaris</b> Use with the backup image command or the include.image option in the options file.
<b>AIX</b> <b>Linux</b> <b>Windows</b> imagegapsize	<b>AIX</b> <b>Linux</b> <b>Windows</b> Use with the backup image command, the include.image option, or in the options file.
mode	Command line only.
postsnapshotcmd	Use with the backup image command, the include.image option, or in the options file.
presnapshotcmd	Use with the backup image command, the include.image option, or in the options file.
<b>AIX</b> <b>Linux</b> snapshotcachesize	<b>AIX</b> <b>Linux</b> Use with the backup image command, the include.image option, or in the options file.
<b>AIX</b> <b>Linux</b> <b>Windows</b> snapshotproviderimage	<b>AIX</b> <b>Linux</b> <b>Windows</b> Client options file or with include.image option.

## Examples

**AIX** **Linux** **Solaris** Task

**AIX** **Linux** **Solaris** Back up the /home/test file space over which the logical volume is mounted and perform an image incremental backup that backs up only new and changed files after the last full image backup.

```
dsmc backup image /home/test -mode=incremental
```

**Windows** Task



**Windows** Back up a volume that has no drive letter but is mounted as a mount point.

```
dsmc backup image m:\mnt\myntfs
```

**Windows** Task

**Windows** Back up the h drive by using an image incremental backup. An image incremental backup backs up files that are new or changed since the last full image backup.

```
dsmc backup image h: -mode=incremental
```

**AIX** | **Linux** Task

**AIX** | **Linux** Perform a static image backup of the logical volume that is mounted at the /home directory.

```
dsmc backup image /home -snapshotproviderimage=none
```

**Windows** Task

**Windows** Perform an offline image backup of the f drive.

```
dsmc backup image f: -snapshotproviderimage=none
```

**AIX** | **Linux** | **Solaris** Task

**AIX** | **Linux** | **Solaris** Perform a dynamic image backup of the logical volume that is mounted at the /home directory.

**Command:** `dsmc backup image /home -dynamicimage=yes`

**AIX** | **Linux** Task

**AIX** | **Linux** Perform a snapshot image backup of the /home directory.

**AIX** AIX client: `dsmc backup image /home -snapshotproviderimage=JFS2`

**Linux** LINUX client: `dsmc backup image /home -snapshotproviderimage=LINUX_LVM`

**Windows** Task

**Windows** Perform an online image backup of the f drive.

```
dsmc backup image f: -snapshotproviderimage=VSS
```

**AIX** | **Linux** | **Solaris** Task

**AIX** | **Linux** | **Solaris** Back up the /dev/lv01 raw logical volume.

```
dsmc backup image /dev/lv01
```

**Windows** Task

**Windows** Back up the f drive, which is mapped to a volume that has not been formatted with a file system.

```
dsmc backup image f:
```

- **AIX** | **Linux** | **Solaris** Static, dynamic, and snapshot image backup  
The traditional image backup prevents write access to the volume by other system applications during the operation.
- **Windows** Offline and online image backup  
The traditional offline image backup prevents write access to the volume by other system applications during the operation.
- **AIX** | **Linux** | **Solaris** | **Windows** Utilizing image backup to perform file system incremental backup  
There are two methods of utilizing image backups to perform efficient incremental backups of your file system. These backup methods allow you to perform point-in-time restore of your file systems and improve backup and restore performance.

**AIX** | **Linux** | **Solaris**

## Static, dynamic, and snapshot image backup

The traditional image backup prevents write access to the volume by other system applications during the operation.

Use the `dynamicimage` option to back up the volume as is without remounting it read-only. Corruption of the backup can occur if applications write to the volume while the backup is in progress. In this case, run `fsck` after a restore.

**AIX** The `dynamicimage` option is not supported for JFS2 volumes.

**Linux** For Linux x86\_64 clients only: By default, the backup-archive client runs a snapshot image backup of file systems residing on a logical volume created by the Linux Logical Volume Manager during which the volume is available to other system applications. Snapshot image backup requires a Version 5.1 IBM Spectrum Protect™ server.

**AIX** For AIX® clients only: By default, backup-archive client runs a snapshot image backup of JFS2 volumes during which the volume is available to other system applications. AIX allows the creation of a snapshot of a JFS2 volume while it is still online. The snapshot is created inside the same volume group as the source volume. You must ensure that the volume group provides enough free disk space to create the snapshot. The snapshot contains the old data blocks while the modified data is stored in the source volume. Use the `snapshotcachesize` option with the backup image command, in the `dsm.sys` file, or with the `include.image` option to specify an appropriate snapshot size so that all old data blocks can be stored while the image backup occurs.

**Linux** The Linux Logical Volume Manager allows the creation of a snapshot of a logical volume while the logical volume itself is still online. The snapshot is created inside the same volume group as the source logical volume. You must ensure that the volume group provides enough free disk space to create the snapshot. The snapshot contains the old data blocks while the modified data is stored in the source logical volume. Use the `snapshotcachesize` option with the backup image command, in the `dsm.sys` file, or with the `include.image` option to specify an appropriate snapshot size so that all old data blocks can be stored while the image backup occurs. A snapshot size of 100 percent will ensure a valid snapshot.

**Windows**

## Offline and online image backup

---

The traditional offline image backup prevents write access to the volume by other system applications during the operation.

If open file support has been configured, the backup-archive client performs a snapshot backup or archive of files that are locked (or "in use") by other applications.

Use VSS as the snapshot provider for open file support.

The following considerations apply to offline and online image backups:

- If you create an image of the system drive, you cannot restore it to the original location. Restore of any image requires that the client have an exclusive lock of the volume you are restoring to, so the system drive cannot be restored since the client is unable to lock the system drive. You can restore an image backup of the system drive to an alternate location.
- Because of different system component configurations, the system image not be consistent across components (such as Active Directory). Some of these components can be configured to use different volumes where parts are installed on the system drive and others to non-system volumes.
- Install the IBM Spectrum Protect™ client program on the system drive. The client cannot restore an image to the same volume where the client program is installed.
- Image backup is only supported on volumes that have a mount point or a drive letter assigned. the client will not back up a volume without a mount point or drive letter.
- If bad disk sectors are detected on the source drive during a LAN-free or LAN-based image backup, data corruption occur. In this case, bad sectors are skipped when sending image data to the IBM Spectrum Protect server. If bad disk sectors are detected during the image backup, a warning message is issued after the image backup completes.

**AIX**

**Linux**

**Solaris**

**Windows**

## Utilizing image backup to perform file system incremental backup

---

There are two methods of utilizing image backups to perform efficient incremental backups of your file system. These backup methods allow you to perform point-in-time restore of your file systems and improve backup and restore performance.

You can perform the backup only on formatted volumes; not on raw logical volumes. You can either use *image backup with file system incremental* or you can use *image backup with image incremental mode* to perform image backups of volumes with mounted file systems.

The following are some examples of using *image backup with file system incremental*.

**AIX**

**Linux**

**Solaris**

- To perform a full incremental backup of the file system: `dsmc incremental /myfilesystem`
- To perform an image backup of the same file system: `dsmc backup image /myfilesystem`
- To periodically perform incremental backups: `dsmc incremental /myfilesystem`

**Windows**

- To perform a full incremental backup of the file system: `dsmc incremental h:`
- To perform an image backup of the same file system: `dsmc backup image h:`
- To periodically perform incremental backups: `dsmc incremental h:`

You must follow the next steps in the order shown to ensure that the server records additions and deletions accurately.

**AIX** | **Linux** | **Solaris** Use this command to restore the file system to its exact state as of the last incremental backup:  
`dsmc restore image /myfilesystem -incremental -deletefiles.`

**Windows** Use this command to restore the file system to its exact state as of the last incremental backup: `dsmc restore image h: -incremental -deletefiles.`

During the restore, the client does the following:

- Restores the most recent image on the server.
- Deletes all of the files restored in the previous step which are inactive on the server. These are files which existed at the time of the image backup, but were subsequently deleted and recorded by a later incremental backup.
- Restores new and changed files from the incremental backups.

If you do not follow the steps exactly, two things can occur:

1. After the original image is restored, all files backed up with the incremental command are restored individually.
2. If you perform a backup image before performing an incremental, files deleted from the original image are *not* deleted from the final restored file system.

The following are some examples of using *image backup with image incremental mode*.

**AIX** | **Linux** | **Solaris**

- To perform an image backup of the same file system: `dsmc backup image /myfilesystem`
- To perform an incremental image backup of the file system: `dsmc backup image /myfilesystem -mode=incremental`

This sends only those files that were added or changed since the last image backup to the server.

- To periodically perform full image backups: `dsmc backup image /myfilesystem`
- To restore the image: `dsmc restore image /myfilesystem -incremental`

On restore, the backup-archive client ignores the `deletefiles` option when the `image+image` incremental technique of backing up has been used. The restore will include files that were deleted after the last full image backup plus the latest versions of files added or changed after the last image backup.

**Windows**

- To perform an image backup of the same file system: `dsmc backup image h:`
- To perform an incremental image backup of the file system: `dsmc backup image h: -mode=incremental`

This sends only those files that were added or changed since the last image backup to the server.

- To periodically perform full image backups: `dsmc backup image h:`
- To restore the image: `dsmc restore image h: -incremental`

On restore, the backup-archive client ignores the `deletefiles` option when the `image+image` incremental technique of backing up has been used. The restore will include files that were deleted after the last full image backup plus the latest versions of files added or changed after the last image backup.

Note: You should perform full image backups periodically in the following cases. This will improve restore time because fewer changes are applied from incrementals.

- When a file system changes substantially (more than 40%).
- Once each month.
- As appropriate for your environment.

The following restrictions apply when using the image backup with image incremental mode:

- The file system can have no previous full incremental backups produced by the incremental command.
- Incremental-by-date image backup does not inactivate files on the server; therefore, when files are restored, none can be deleted.

- If this is the first image backup for the file system, a full image backup is performed.
- Using `mode=incremental` backs up only files with a changed date, not files with changed permissions.
- If file systems are running at or near capacity, an out-of-space condition could result during the restore.

AIX

Solaris

Windows

## Backup NAS

---

The `backup nas` command creates an image backup of one or more file systems that belong to a Network Attached Storage (NAS) file server, otherwise known as NDMP Backup. You are prompted for the IBM Spectrum Protect™ administrator ID.

The NAS file server performs the outboard data movement. A server process starts in order to perform the backup.

Use the `nasnodename` option to specify the node name for the NAS file server. The NAS node name identifies the NAS file server to the IBM Spectrum Protect server; the NAS node name must be registered at the server. Place the `nasnodename` option in your client options file (`dsm.opt`). The value in the client options file is the default, but can be overridden on the command line.

Use the `toc` option with the `backup nas` command or the `include.fs.nas` option to specify whether the IBM Spectrum Protect server saves Table of Contents (TOC) information for each file system backup. If you save TOC information, you can use the `QUERY TOC` server command to determine the contents of a file system backup with the `RESTORE NODE` server command to restore individual files or directory trees.

You can also use the IBM Spectrum Protect web client to examine the entire file system tree and select files and directories to restore. Creation of a TOC requires that you define the `tocdestination` attribute in the backup copy group for the management class to which this backup image is bound. TOC creation requires more processing, network resources, storage pool space, and possibly a mount point during the backup operation. If you do not save TOC information, you can still restore individual files or directory trees using the `RESTORE NODE` server command, if you know the fully qualified name of each file or directory and the image in which that object was backed up.

The `toc` option is only supported for images that are backed up by Version 5.2 or later client and server.

Specifying `mode=differential` on the `BACKUP NODE` server command or the `backup nas` command where no full image exists, shows that a full backup was started. Using the `QUERY PROCESS` server command shows that a full backup is in process.

Use the `mode` option to specify whether to perform a full or differential NAS image backup. A full image backup backs up the entire file system. The default is a differential NAS image backup on files that change after the last full image backup. If an eligible full image backup does not exist, a full image backup is performed. If a full image exists, whether it is restorable, or expired and being maintained because of dependent differential images, specifying `mode=differential` sends a differential image backup. If a full image is sent during a differential backup, it is reflected as a full image using the `QUERY NASBACKUP` server command. The `QUERY NASBACKUP` server command also displays NAS images that are restorable and displays full image or differential image as the object type.

Use the `monitor` option to specify whether you want to monitor a NAS file system image backup and display processing information on your screen.

Use the `monitor process` command to display a list of all processes for which an administrative user ID has authority. The administrative user ID should have at least client owner authority over both the NAS node and the client workstation node they are using either from command line or from the web.

Use the `cancel process` command to stop NAS backup processing.

Regardless of client platform, NAS file system specifications use the forward slash (/) separator, as in this example: `/vol/vol10`.

Windows

NAS file system designations on the command line require brace delimiters {} around the file system names, such as: `{/vol/vol10}`.

## Supported Clients

---

AIX

Solaris

This command is valid for AIX®, and Solaris clients only.

Windows

This command is valid for all Windows clients.

## Syntax

---

```

      .-----|
      v       |
>>-Backup NAS-----+----- --filespec-----><
      '- --options-'

```

## Parameters

### filespec

Specifies the name of one or more file systems on the NAS file server. If you do not specify this parameter, the backup-archive client processes all of the file systems that are defined by the domain.nas option.

If you do not specify the *filespec* or the domain.nas option, the default all-nas value is used for domain.nas and all file systems on the NAS file server are backed up.

Table 1. Backup NAS command: Related options

Option	Where to use
mode	Command line only.
monitor	Command line only.
<b>AIX</b>   <b>Solaris</b> nasnodename	<b>AIX</b>   <b>Solaris</b> Client options file (dsm.sys) or command line.
<b>Windows</b> nasnodename	<b>Windows</b> Client options file (dsm.opt) or command line.
<b>AIX</b>   <b>Solaris</b> toc	<b>AIX</b>   <b>Solaris</b> Command line or with the include.fs.nas option in your client options file (dsm.sys).
<b>Windows</b> toc	<b>Windows</b> Command line or with the include.fs.nas option in your client options file (dsm.opt).

## Examples

### **AIX** | **Solaris** Task

**AIX** | **Solaris** Perform the NAS image backup of the entire file system.

**Command:** backup nas -mode=full -nasnodename=nas1 /vol/vol0 /vol/vol2

### **Windows** Task

**Windows** Perform the NAS image backup of the entire file system.

**Command:** backup nas -mode=full -nasnodename=nas1 {/vol/vol0} {/vol/vol2}

### Task

Perform the NAS image backup of the entire file server.

**Command:** backup nas -nasnodename=nas1

### **AIX** | **Solaris** Task

**AIX** | **Solaris** Perform the NAS image backup of the entire file system and save Table of Contents (TOC) information for the file system backup.

**Command:** backup nas -mode=full -nasnodename=netappsj /vol/vol0 -toc=yes

### **Windows** Task

**Windows** Perform the NAS image backup of the entire file system and save Table of Contents (TOC) information for the file system backup.

**Command:** backup nas -mode=full -nasnodename=netappsj {/vol/vol0} -toc=yes

### **Windows**

## Backup Systemstate

Use the backup systemstate command to back up all bootable system state and system services components as a single object, to provide a consistent point-in-time snapshot of the system state.

Bootable system state components can include the following:

- Active Directory (domain controller only)
- System volume (domain controller only)
- Certificate Server Database
- COM+ database
- Windows Registry
- System and boot files
- ASR writer

System services components can include the following:

- Background Intelligent Transfer Service (BITS)
- Event logs
- Removable Storage Management Database (RSM)
- Cluster Database (cluster node only)
- Remote Storage Service
- Terminal Server Licensing
- Windows Management Instrumentation (WMI)
- Internet Information Services (IIS) metabase
- DHCP database
- Wins database

The list of bootable system state and system services components is dynamic and can change depending on service pack and operating system features installed. The backup-archive client allows for the dynamic discovery and backup of these components.

System state is represented by several VSS writers of type "bootable system state" and "system service". Of these, the System Writer is the largest part of the system state in terms of number of files and size of data. By default, the System Writer backup is incremental. You can use the systemstatebackupmethod option to perform full backups of the System Writer. For more information, about this option, see Systemstatebackupmethod. The client always backs up all other writers in full.

This command also backs up ASR data for Windows clients; BIOS and UEFI boot architectures are supported.

Note:

1. The system and boot files component of system state is backed up only if a member (file) of that component has changed since the last backup. If a member changes, the entire group of files that comprise that component are backed up.
2. The backup-archive client on Windows does not allow the backup of any individual component.
3. By default, system state backups are bound to the default management class. To bind them to a different management class, use the include.systemstate option; specify all as the pattern, and specify the name of the new management class.

For example: `include.systemstate ALL BASVT2.`

4. Use the query systemstate command to display information about a backup of the system state on the IBM Spectrum Protect™ server.
5. You can no longer restore the system state on a system that is still online. Instead, use the ASR-based recovery method to restore the system state in offline Windows PE mode. For more information, see the following IBM Spectrum Protect wiki articles:
  - Best Practices for Recovering Windows Server 2012 and Windows 8
  - Best Practices for Recovering Windows Server 2012 R2 and Windows 8.1

If you try to restore the system state with the dsmc restore systemstate command, from the backup-archive client GUI, or from the web client, the following message is displayed:

```
ANS5189E Online SystemState restore has been deprecated. Please use offline WinPE method for performing system state restore.
```

## Supported Clients

---

This command is valid for all supported Windows clients.

## Syntax

---

>>-Backup SYSTEMState-----<<

## Parameters

---

There are no parameters for this command.

## Examples

---

Task

Back up the system state.

**Command:** backup systemstate

Linux | Windows

## Backup VM

---

Use the backup vm command to start a full backup of a virtual machine.

Windows

The backup vm command can be used to back up both Microsoft Hyper-V virtual machines and VMware virtual machines. The information for each hypervisor is presented in its own heading. If you are backing up a virtual machine that is part of a Hyper-V setup, you do not need to read the *Backing up VMware virtual machines* text. If you are backing up a VMware virtual machine, you do not need to read the *Backing up Microsoft Hyper-V virtual machines* text.

 This feature is available only if the client operates as a data mover for IBM Spectrum Protect™ for Virtual Environments.

Linux | Windows

## Backing up VMware virtual machines

---

Use the backup vm command to back up VMware virtual machines.

One or more virtual machines are backed up by the IBM Spectrum Protect data mover node. *Data mover node* is the name that is given to a configuration where the backup-archive client runs on a vStorage backup server and is configured to protect the virtual machines in a Virtual Center or ESX/ESXi server. You must configure the VMware virtual machine before you use this command. For information about configuring the VMware virtual machine, see *Preparing the environment for full backups of VMware virtual machines*.

A full VM backup stores a backup copy of all virtual disk images and configuration information for a virtual machine. Full VM backups enable a complete restore of a virtual machine, but they take more time and more server space than an incremental backup.

If you set `vmenabletemplatebackups` option to `yes`, a backup vm operation includes the template VMs, but only if the vStorage backup server is connected to a vCenter Server, and not to an ESX or ESXi host.

If a snapshot fails during backup processing, the client attempts to back up the VMware virtual machine one more time. To control the number of total snapshot attempts, set the `INCLUDE.VMSNAPSHOTATTEMPTS` option in the client options file.

Data protection tags are used to configure the backup policy of virtual machines in VMware objects. The tags and categories are created when you use one of the following methods:

- Enable tagging support on the data mover node with the `vmtagdatamover` option and run the backup vm command.
- Use the IBM Spectrum Protect vSphere Client plug-in to manage IBM Spectrum Protect backups.
- Run the `set vmtags` command on any data mover node.

When the `vmtagdatamover` option is set to `yes`, all tags that are assigned to a virtual machine are backed up during backup vm operations. The tags are restored when the `restore vm` command is run. Tags that are assigned to other inventory objects are not backed up and cannot be restored.

For more information about data protection tags, see *Data protection tagging overview*.

A Full VM backup uses VMware Changed Block Tracking (CBT) to create content-aware (used-block only) backups. The client enables changed block tracking (CBT) on an ESX or ESXi server when a backup begins. VMware CBT requires an ESX 4.1 (or later)

host, with virtual hardware 7 (or later). You cannot perform incremental or full VM content-aware backups on virtual machines that do not support CBT.

When CBT is enabled, it tracks disk changes when I/O operations are processed by the ESX or ESXi server storage stack on the following disks:

- A virtual disk that is stored on VMFS; the disk can be an iSCSI disk, a local disk, or a disk that is on a SAN.
- A virtual disk that is stored on NFS.
- An RDM that is in virtual compatibility mode.

When I/O operations are not processed by the ESX or ESXi storage stack, changed block tracking cannot be used to track disk changes. The following disks cannot use CBT:

- An RDM that is in physical compatibility mode.
- A disk that is accessed directly from inside a VM. For example, vSphere cannot track changes that are made to an iSCSI LUN that is accessed by an iSCSI initiator in the virtual machine.

Complete information about changed block tracking requirements is described in the *VMware Virtual Disk API Programming Guide* in the VMware product documentation. In the guide, search for "Low Level Backup Procedures" and read the "Changed Block Tracking on Virtual Disks" section.

For VMware servers that do not support CBT, both the used and the unused areas of the disk are backed up and an informational message is logged in the dsmerror.log file. Use the -preview option on the backup vm command to view the current CBT status. CBT status has three values:

#### Off

Indicates the CBT configuration parameter (ctkEnabled) is not enabled in the virtual machine's configuration parameters. Off is the default state.

#### Not Supported

Indicates that the virtual machine does not support CBT. Changed-block only backups are not possible.

#### On

Indicates the virtual machine supports CBT and that CBT is enabled in the virtual machine's configuration parameters (ctkEnabled=true).

The client turns on CBT (it sets ctkEnable=true) with each backup attempt. After the client turns on CBT, it remains on, even if the virtual machine is deleted from the IBM Spectrum Protect server. With CBT enabled, after the first full VM backup is performed, only the changed blocks on the disk are backed up or restored.

If you are no longer performing IBM Spectrum Protect backups of a virtual machine, you can turn off CBT. To turn off CBT, right-click the virtual machine that you want to turn off CBT for in the vSphere client. Click Edit Settings > Options > General > Configuration Parameters. Then, set the ctkEnabled configuration parameter to `false`.

Tip: You can use the compression option with backups only if the backup is being saved to a storage pool that was enabled for client-side deduplication.

**Windows** For more information about compression, see Compression and encryption processing.

**Windows** **Linux** You specify the -vmbackuptype and -mode options to indicate how the backups are to be performed. For full VM backups, use -vmbackuptype=fullvm, and specify any of the following mode options:

#### IFFull

Incremental-forever-full mode. In this mode, a snapshot of all used blocks on a virtual machine's disks are backed up to the server. You must be licensed to use IBM Spectrum Protect for Virtual Environments: Data Protection for VMware, or IBM Spectrum Protect for Virtual Environments: Data Protection for Microsoft Hyper-V to use this option.

#### IFIncremental

Incremental-forever-incremental. In this mode, a snapshot is created of the blocks that changed since the last backup. You must be licensed to use IBM Spectrum Protect for Virtual Environments: Data Protection for VMware, or IBM Spectrum Protect for Virtual Environments: Data Protection for Microsoft Hyper-V to use this option.

For information about the incremental-forever backup strategy, see IBM Spectrum Protect for Virtual Environments, Data Protection for VMware: Backup and restore types .

## Supported Clients

---

**Windows** This command is valid on supported Windows clients that are installed on a vStorage backup server that protects VMware virtual machines.



**Linux** This command is valid only on supported Linux clients that are installed on a vStorage backup server that protects VMware virtual machines.

## Syntax

```

      .-.-.-----
      | V           |
      | .---vmname-+-|
      |               |
>>-Backup VM--+-+-----+----->
>-----+----->
| .-.-.-----|
| V           | |
| .---vmname--:vmdk=---disk_label-+-'|
>-----+----->>
'- -VMBACKUPUPDATEGUID-' '- -PREView-- --options-'
```

## Parameters

### *vmname*

Specify the name of one or more virtual machines that you want to back up. The name is the virtual machine display name. Separate multiple virtual machine names with commas. If you set the `vmenabletemplatebackups` option to `yes`, *vmname* can specify the name of a template VM to back up.

VMware vCenter allows for two or more virtual machines to have the same display name. However, the backup-archive client requires that all virtual machine names in a vCenter server configuration be unique. To prevent errors during processing, ensure that all virtual machines have a unique display name.

Wildcard characters can be used in virtual machine names that are specified as this parameter. However, wildcard processing differs, depending on which backup mode is used.

- For backups that use `mode=iffull` or `mode=ifincremental`, wildcards can be used to match VM name patterns. For example:
  - `backup vm VM_TEST*` includes all virtual machines that have names that begin with `VM_TEST`
  - `backup vm VM??` includes any virtual machine that has a name that begins with the letters "VM", followed by 2 characters

If you do not specify *vmname*, you can identify the virtual machine with the `domain.vmfull` option.

### `:vmdk=disk_label`

This keyword is an extension to the *vmname*. It specifies the label (name) of the virtual machine disk to include in the backup operation. You can exclude a disk by preceding the keyword with the exclusion operator (-). For more ways to include or exclude disks from processing, see `Domain.vmfull`, `Exclude.vmdisk`, `Include.vmdisk`.

### `-VMBACKUPUPDATEGUID`

To use this option, you must have a license agreement to use IBM Spectrum Protect for Virtual Environments: Data Protection for VMware.

This option updates the globally unique identifier (GUID) for the virtual machine that you are backing up. This parameter is intended for use only in the following scenario:

You want to restore a previously backed up virtual machine named ORION. But, before you shut down and replace the copy of ORION that is running in your production environment, you want to verify the configuration of the restored virtual machine before you use it to replace the existing ORION.

1. You restore the ORION virtual machine and give it a new name: `dsmc restore vm Orion -vmname=Orion2`
2. You update and verify the ORION2 virtual machine and determine that it is ready to replace the existing virtual machine that is named ORION.
3. You power down and delete ORION.
4. You rename ORION2 so that it is now named ORION.
5. The next time that you backup ORION, by using either an incremental-forever full, or incremental-forever-incremental backup, you add the `-VMBACKUPUPDATEGUID` parameter to the `backup vm` command. This option updates the GUID, on the IBM Spectrum Protect server, so the new GUID is associated with the stored backups for the ORION virtual machine. The chain of incremental backups is preserved; there is no need to delete existing backups and replace them with new backups.

## -PREVIEW

This option displays information about a virtual machine, including the labels of the hard disks in the virtual machine, and the management class information for a virtual machine.

You can use the disk labels with the `:vmdk=` or `:-vmdk=` keywords to include or exclude disks from a backup operation. The following text is sample output from the `-preview` parameter:

```
backup vm vm1 -preview
Full BACKUP VM of virtual machines 'VM1'

vmName:vm1
VMDK[1]Label: Hard disk 1
VMDK[1]Name: [ds5k_svt_1] tsmcctlx14/tsmcctlx14.vmdk
VMDK[1]Status: Included
VMDK[2]Label: Hard disk 2
VMDK[2]Name: [ds5k_svt_1] tsmcctlx14/tsmcctlx14_1.vmdk
VMDK[2]Status: Excluded - user,Independent,pRDM
```

This example output from `-preview` shows that VMDK 2 was excluded by the previous backup. Disks that were included in a backup have a status of `Included`. Disks that were excluded from the backup have a status of `Excluded`, followed by a reason code. The reason codes can be any of the following:

### user

Indicates that the disk was skipped because it was excluded on a `domain.vmf` statement, on the command line, or in the client options file.

### Independent

Indicates that the disk is an independent disk. Independent disks cannot be part of a snapshot, so they are excluded from backup vm operations. Ensure that the `vmprocessvmwithindependent` option is set to `yes` or the entire virtual machine is bypassed by a backup operation if it contains one or more independent disks.

### pRDM

Indicates that the disk is a physical Raw Device Mapped (pRDM) disk. pRDM disks cannot be part of a snapshot, so they are excluded from backup vm operations. Ensure that the `vmprocessvmwithprdm` option is set to `yes` or the entire virtual machine is bypassed by a backup operation if it contains one or more raw device mapping (RDM) volumes that are provisioned in physical-compatibility mode (pRDM).

The output from the `-preview` parameter also shows the management class name that is associated with the virtual machine, along with information about where the management class was set. This information can help you verify whether the domain and tag values are set correctly for the management class. For example:

```
backup vm -preview
Full BACKUP VM of virtual machines specified in DOMAIN.VMFULL option.

1. vmName: tag_vm_2
   DomainKeyword: all-vm
   toolsRunningStatus: guestToolsNotRunning
   toolsVersionStatus: guestToolsNotInstalled
   consolidationNeeded: No
   Change Block Tracking: On
   managementClassName: STANDARD
   managementClassLocation: Node Default

   VMDK[1]Label: 'Hard disk 1' (Hard Disk 1)
   VMDK[1]Name: '[Raid1-lannds2] tag_vm_2/tag_vm_2.vmdk'
   VMDK[1]Status: Included
   ...

12. vmName: vm-jean
   DomainKeyword: all-vm
   toolsRunningStatus: guestToolsNotRunning
   toolsVersionStatus: guestToolsNotInstalled
   consolidationNeeded: No
   Change Block Tracking: On
   managementClassName: MGMTCLASS1 (invalid)
   managementClassLocation: VM Tag Management Class (IBM Spectrum Protect)

   VMDK[1]Label: 'Hard disk 1' (Hard Disk 1)
   VMDK[1]Name: '[Raid1-lannds2] vm-jean/vm-jean.vmdk'
   VMDK[1]Status: Included
```

where:

#### managementClassName

Displays the name of the management class that the virtual machine is bound to.

If the "(invalid)" label is shown next to the management class name, either the name was incorrectly specified, the management class was removed on the IBM Spectrum Protect server, or no backup copy group was found in the management class on the server. When the management class name is invalid, the virtual machine backup operation fails.

#### managementClassLocation

Displays where the management class was set. The following locations are possible:

##### Node Default

The management class is set on the default domain of the VMware datacenter node.

##### VMMC option

The management class is set with the vmmc option.

##### VMCTLMC option

The management class is set with the vmctlmc option.

##### INCLUDE.VM option

The management class is set with the include.vm option.

##### VM Tag Management Class (IBM Spectrum Protect)

The management class is set as a tag value of the `Management Class (IBM Spectrum Protect)` tag category. Tag values can be set with data protection settings in the IBM Spectrum Protect vSphere Client plug-in in the vSphere Web Client, or by using tools such as VMware vSphere PowerCLI version 5.5 R2 or later.

**Important:** In order to display the management class information that is set by tags, you must set the `vmtagdatamover yes` option in the client options file, or you must include the `-vmtagdatamover=yes` parameter when you run the `dsmc backup vm` command. If you did not set the `vmtagdatamover` option or if it is set to `no`, the client ignores any management class tag values, and displays the management class definition that is set in the default domain of the datacenter node, the `vmmc` option, or the `include.vm` option.

## Return codes for virtual machine backup operations

Backup operations for virtual machines can complete with the return codes that are shown in the following table.

Return code	Description
0	A command to back up one or more virtual machines completed successfully.
8	A command to back up multiple virtual machines succeeded for only some of the virtual machines that were targeted by the command. Examine the log file to determine the processing status for each of the targeted virtual machines.
12	Indicates that either of the following error conditions occurred: <ul style="list-style-type: none"><li>The backup command could not back up any of the virtual machines that were targets of the backup operation.</li><li>The backup command failed and it stopped before all virtual machines that were specified were inspected.</li></ul> Examine the log file to determine the reason for the failure.

## vStorage API for data protection example commands

Perform an IFIncremental backup of two VMs named vm3 and vm4.

```
dsmc backup vm vm3,vm4 -vmbackuptype=fullvm -mode=ifincremental
```

Perform an IFFull backup of a VM named vm1.

```
dsmc backup vm vm1 -vmbackuptype=fullvm -mode=iffull
```

Perform an IFFull VM backup of a VM named vm1, but include only Hard Disk 1 in the backup operation.

```
dsmc backup vm "vm1:vmdk=Hard Disk 1" -vmbackuptype=fullvm -mode=iffull
```

Perform an incremental-forever backup of a virtual machine that is named vm1, but exclude Hard Disk 1 and Hard Disk 4 from the backup operation.

```
dsmc backup vm "vm1:-vmdk=Hard Disk 1:-vmdk=Hard Disk 4"
-vmbackuptype=fullvm -mode=iffull
```

Perform an incremental-forever-full backup of two virtual machines that are named vm1 and vm2. On vm1, back up only Hard Disk 2 and Hard Disk 3. On vm2, back up all virtual disks.

```
dsmc backup vm "vm1:vmdk=Hard Disk 2:vmdk=Hard Disk 3",
vm2 -vmbackuptype=fullvm -mode=iffull
```

Perform parallel incremental-forever-full backups of the VMware virtual machines that are selected for backup by using the selection criteria (domain parameters) on the domain.vmfll statement. Set the maximum number of parallel backups to 5 virtual machines and 10 sessions and limit the backups to 5 VMs per host and 5 VMs per datastore.

```
dsmc backup vm -vmbackuptype=fullvm -mode=iffull -vmmaxparallel=5
-vmmaxbackupsessions=10 -vmlimitperhost=5 -vmlimitperdatastore=5
```

Linux | Windows

Related links for backing up VMware virtual machines

- Query VM
- Restore VM
- Domain.vmfll
- Include.vm
- Mbjrefreshthresh
- Mbpctrefreshthresh
- Mode
- Vmbackdir
- Vmbackuplocation
- Vmbackuptype
- Vmchost
- Vmctlmc
- Vmcpw
- Vmcuser
- Vmlimitperdatastore
- Vmlimitperhost
- Vmmc
- Vmmaxbackupsessions
- Vmmaxparallel
- Vmtagdatamover
- Set Vmtags
- Virtual machine exclude options
- Virtual machine include options

Windows

## Backing up Microsoft Hyper-V virtual machines

---

Use the backup vm command to back up Hyper-V virtual machines. You can back up Hyper-V guests that exist on a local disk, a SAN-attached disk, a Cluster Shared Volume (CSV), or guests that exist on a remote file server share. Remote file server shares must be on a Windows Server 2012 or later system.

You specify the backup mode to use when you want to back up a virtual machine by adding the -mode parameter on the command line, or you can set the mode option in the client options file. Any of the following modes can be specified:

### IFFull

Incremental-forever-full mode. In this mode, a snapshot of all used blocks on a virtual machine's disks are backed up to the server. The backup includes configuration information, and all of the disks. You must have a license for IBM Spectrum Protect for Virtual Environments: Data Protection for Microsoft Hyper-V to use this mode. This mode can be used only on Windows clients on Hyper-V hosts that are running in Windows Server 2012 or later environments.

### IFIncremental

Incremental-forever-incremental. In this mode, a snapshot is created of the blocks that were changed since the last backup. The backup includes configuration information, and all of the disks. You must have a license for IBM Spectrum Protect for Virtual Environments: Data Protection for Microsoft Hyper-V to use this mode. This mode can be used only on Windows clients on Hyper-V hosts that are running in a Windows Server 2012 or later environments.

For information about the incremental-forever backup strategy, see Incremental-forever backup strategy.

## Supported Clients

This command is valid on supported Windows clients that are installed on a Microsoft Hyper-V host server.

## Syntax

```

      .-,-----.
      |           |
      v           |
      .---vmname-+- .
>>-Backup VM--+-+-----+-----+-----+-----+-----+-----+-----+----->
                                     | .-,-----. |
                                     | v           | |
                                     |---vmname--:vhdx==disk_location+-'
                                     |           |
      .-IFIncremental-.
>-- -MODE = -+-----+-----+-----+-----+-----+-----+----->
          '-IFFull-----'

>--+-----+-----+-----+-----+-----+-----+-----+-----+----->>
    '- -VMBACKUPUPDATEGUID-' '- -PREview-' '- -DETail-- --options-'

```

## Parameters

### *vmname*

Specify the name of the virtual machine that you want to back up; the name is case sensitive. If you specify multiple virtual machine names, separate the names with commas.

Wildcard characters can be used in virtual machine names that are specified as this parameter. However, wildcard processing differs, depending on which backup mode is used.

- For backups that use `mode=iffull` or `mode=ifincremental`, wildcards can be used to match VM name patterns. For example:
  - `backup vm VM_TEST*` includes all virtual machines that have names that begin with `VM_TEST`
  - `backup vm VM??` includes any virtual machine that has a name that begins with the letters "VM", followed by 2 characters

If you do not specify a virtual machine name, and if you specify `-mode=ifincremental` or `-mode=iffull`, the `domain.vmfull` option is used to determine which virtual machines to include in the backup operation.

### *vmname:vhdx=disk\_location*

This parameter specifies the virtual machine hard disk (VHDX) to include in Hyper-V RCT VM backup operations on Windows Server 2016.

The `vmname` variable specifies the name of the VM to back up. Wildcard characters can be used to select VM names that match a pattern. An asterisk (\*) matches any sequence of characters. A question mark (?) matches any single character.

The `:vhdx=disk_location` keyword specifies the location of the VM disk to include in the backup operation. The disk location is specified in the format "`controller_type controller_number disk_location_number_inside_controller`". The controller type must be "SCSI" or "IDE". For example:

```
dsmc backup vm "vm1:VHDX=IDE 1 0"
```

You can obtain the disk location information in the Hyper-V Manager. In the Virtual Machines view, right-click a VM and click Settings. In the Hardware section of the Settings window, locate the IDE Controller or SCI Controller, and click Hard Drive to view the hard disk settings. The controller number and disk location are displayed in the Controller and Location fields. You can also obtain the disk location information by running the Windows PowerShell cmdlet `Get-VMHardDiskDrive`.

You can exclude a VM disk from backup operations by specifying the exclude operator (-) before the `vhdx=` keyword. For example, use `-vhdx=` to exclude a VM disk from the backup operation of a VM:

```
dsmc backup vm "vm1:-VHDX=IDE 1 0:-VHDX=SCSI 0 1"
```

If you specify multiple VM disks to include or exclude, the `vhdx=` or `-vhdx=` keyword and associated values must be separated by colons, with no intervening space characters. For example:

```
dsmc backup vm "*:--VHDX=IDE 1 0:--VHDX=SCSI 0 1"
```

If you specify multiple VM names and VM disks, the VM name and associated values must be separated by semicolons, with no intervening space characters. For example:

```
dsmc backup vm "vm1:--VHDX=IDE 1 0:--VHDX=SCSI 0 1;vm2:--VHDX=IDE 1 0:--VHDX=SCSI 0 1"
```

#### -VMBACKUPUPDATEGUID

You must be licensed to use IBM Spectrum Protect for Virtual Environments: Data Protection for Microsoft Hyper-V to use this option.

This option updates the globally unique identifier (GUID) for the virtual machine that you are backing up. This parameter is intended for use only in the following scenario:

You want to restore a previously backed up virtual machine named ORION. But, before you shut down and replace the copy of ORION that is running in your production environment, you want to verify the configuration of the restored virtual machine before you use it to replace the existing ORION.

1. You restore the ORION virtual machine and give it a new name: `dsmc restore vm Orion -vmname=Orion2`
2. You update and verify the ORION2 virtual machine and determine that it is ready to replace the existing virtual machine that is named ORION.
3. You power down and delete ORION.
4. You rename ORION2 so that it is now named ORION.
5. The next time that you backup ORION, by using either an incremental-forever full, or incremental-forever-incremental backup, you add the -VMBACKUPUPDATEGUID parameter to the backup vm command. This option updates the GUID, on the IBM Spectrum Protect server, so the new GUID is associated with the stored backups for the ORION virtual machine. The chain of incremental backups is preserved; there is no need to delete existing backups and replace them with new backups.

#### -PREView

This parameter displays additional information about a virtual machine, including the labels of the virtual hard disks that are in the virtual machine.

When you issue the -preview option, the backup operation does not start. You must issue the backup command without the -preview option to start the backup operation.

You can use both the -preview option and the -detail option on the command to display information about subdisks that are included when the backup is run. A subdisk is the AVHDX file that is created when a snapshot is taken of a VHDX file.

## Return codes for virtual machine backup operations

Backup operations for virtual machines can complete with the return codes that are shown in the following table.

Return code	Description
0	A command to back up one or more virtual machines completed successfully.
8	A command to back up multiple virtual machines succeeded for only some of the virtual machines that were targeted by the command. Examine the log file to determine the processing status for each of the targeted virtual machines.
12	Indicates that either of the following error conditions occurred: <ul style="list-style-type: none"><li>• The backup command could not back up any of the virtual machines that were targets of the backup operation.</li><li>• The backup command failed and it stopped before all virtual machines that were specified were inspected.</li></ul> Examine the log file to determine the reason for the failure.

## Microsoft Hyper-V backup examples

Start an incremental-forever incremental backup of a Hyper-V virtual machine that is named "VM1".

```
dsmc backup vm VM1 -mode=ifincremental
```

Start an incremental-forever-incremental backup of all Hyper-V virtual machines that are specified on the domain.vmfull option.

```
dsmc backup vm -mode=ifincremental
```

For Windows Server 2016 or later operating systems: The following command excludes an IDE disk (with controller number 1 and disk location 0) and a SCSI disk (with controller number 0 and disk location 1) from an incremental-forever incremental Hyper-V RCT backup of a virtual machine, "vm2":

```
dsmc backup vm "vm2:-VHDX=IDE 1 0:-VHDX=SCSI 0 1" -mode=ifincremental
```

For Windows Server 2016 or later operating systems: The following command shows the preview of a Hyper-V RCT backup of a virtual machine, "VM05":

```
dsmc backup vm VM05 -mode=ifincremental -preview
```

In the command output, the -preview parameter displays the VHDX labels in the virtual machine. When the -detail parameter is specified with the -preview parameter, no additional information is shown for Hyper-V RCT backups.

```
Backup VM command started. Total number of virtual machines to process: 1
```

```
1. VM Name: VM05
```

```
Domain Keyword:      VM05
Mode:                Incremental Forever - Incremental
Target Node Name:    NODE14
Data Mover Node Name: NODE14
Cluster Resource:    No
```

```
Disk[1]
```

```
Name: \\node14\d$\Hyper_V_Virtual_Machine\VM05\Virtual Hard Disks\VM05.vhdx
Capacity:           15.00 GB
Size:               10.91 GB
Status:             included
Disk Type:          VHDX
Number of Subdisk:  0
Controller Location: IDE 0 0
```

```
Disk[2]
```

```
Name: \\node14\d$\Hyper_V_Virtual_Machine\VM05\Virtual Hard Disks\VM05_Disk2.vhdx
Capacity:           2.00 GB
Size:               132.00 MB
Status:             included
Disk Type:          VHDX
Number of Subdisk:  0
Controller Location: SCSI 0 1
```

```
Total number of virtual machines processed: 1
```

For Windows Server 2012 or 2012 R2: The following command starts an incremental forever-incremental backup of a Hyper-V virtual machine, "VM3":

```
dsmc backup vm VM3 -mode=ifincremental -preview
```

In the command output, the -preview parameter displays the VHDX labels in the virtual machine:

```
VM Name: VM3
```

```
Domain Keyword:      all-vm
Mode:                Incremental Forever - Incremental
Target Node Name:    NODE1
Data Mover Node Name: NODE1
Cluster Resource:    Yes
```

```
Disk[1]
```

```
Name: c:\ClusterStorage\Volume1\Hyper-V\VM3\VM3.VHDX
Capacity:           40.00 GB
Size:               9.09 GB
Full Backup:        included
Incremental Backup: excluded
Disk Type:          VHDX
Number of Subdisk:  1
```

```
Disk[2]
```

```
Name: c:\ClusterStorage\Volume3\Hyper-V\VM3\VM3-DISK2.VHDX
Capacity:           127.00 GB
Size:               4.00 MB
Full Backup:        included
```

```
Incremental Backup: excluded
Disk Type:         VHDX
Number of Subdisk: 1
```

When the -detail parameter is specified with the -preview parameter, the VHDX labels and their subdisks are shown. The following example output is abbreviated to show only information about one virtual machine and one disk:

VM Name: VM3

```
Domain Keyword:    all-vm
Mode:              Incremental Forever - Incremental
Target Node Name:  NODE1
Data Mover Node Name: NODE1
Cluster Resource:  Yes
```

```
Disk[1]
Name: c:\ClusterStorage\Volume1\Hyper-V\VM3\VM3.VHDX
Capacity:         40.00 GB
Size:             9.09 GB
Full Backup:      included
Incremental Backup: excluded
Disk Type:        VHDX
Number of Subdisk: 1
```

```
Subdisk[1]
Name: c:\ClusterStorage\Volume1\Hyper-V\VM3\VM3_9B26166-9C3E.avhdx
Capacity:         40.00 GB
Size:             1.25 GB
Full Backup:      included
Incremental Backup: included
Disk Type:        AVHDX
```

## Hyper-V options file examples

---

The following example specifies individual virtual machines in the client options file, and shows the domain.vmvull option.

```
domain.vmfull vm1,vm2,vm5
```

In the following examples, the domain.vmfull option is used to process specific virtual machine.

For Windows Server 2016 or later operating systems: In the following example, the domain.vmfull option is specified as follows:

```
domain.vmfull VM04,VM05
```

The following command shows a preview of a Hyper-V RCT backup of all virtual machine specified in the domain.vmfull option. The command displays preview information about each virtual machine:

```
dsmc backup vm -mode=iffull -preview
```

The following output is shown:

```
Backup VM command started. Total number of virtual machines to process: 2
```

1. VM Name: VM04

```
Domain Keyword:    VM04
Mode:              Incremental Forever - Full
Target Node Name:  NODE14
Data Mover Node Name: NODE14
Cluster Resource:  No
```

```
Disk[1]
Name: \\node14\d$\Hyper_V_Virtual_Machine\VM04\Virtual Hard Disks\VM04.vhdx
Capacity:         36.00 GB
Size:             9.16 GB
Status:           included
Disk Type:        VHDX
Number of Subdisk: 0
Controller Location: IDE 0 0
```

2. VM Name: VM05

```
Domain Keyword:    VM05
```



```
Mode: Incremental Forever - Full
Target Node Name: NODE14
Data Mover Node Name: NODE14
Cluster Resource: No
```

```
Disk[1]
Name: \\node14\d$\Hyper_V_Virtual_Machine\VM05\Virtual Hard Disks\VM05.vhdx
Capacity: 15.00 GB
Size: 10.91 GB
Status: included
Disk Type: VHDX
Number of Subdisk: 0
Controller Location: IDE 0 0
```

```
Disk[2]
Name: \\node14\d$\Hyper_V_Virtual_Machine\VM05\Virtual Hard Disks\VM05_Disk2.vhdx
Capacity: 2.00 GB
Size: 132.00 MB
Status: included
Disk Type: VHDX
Number of Subdisk: 0
Controller Location: SCSI 0 1
```

Total number of virtual machines processed: 2

For Windows Server 2012 or 2012 R2: In the following example, the domain.vmfull option specifies these virtual machines:

```
domain.vmfull BigVM,myGentoox64,HPV2VM3-OLD,Local10
```

The following command shows a preview of an incremental forever-incremental backup operation of all Hyper-V virtual machines: specified in the domain.vmfull option. The command displays preview information about each virtual machine:

```
dsmc backup vm -mode=iffull -preview
```

The following output is shown:

1. VM Name: BigVM

```
Domain Keyword: all-vm
Mode: Incremental Forever - Full
Target Node Name: MSF
Data Mover Node Name: MSF
Cluster Resource: No
```

```
Disk[1]
Name: \\lingonberry\c$\Users\michael\Documents\Storage\BigVM.vhdx
Capacity: 5.85 TB
Size: 5.00 MB
Full Backup: included
Incremental Backup: excluded
Disk Type: VHDX
Number of Subdisk: 0
```

2. VM Name: Gentoox64

```
Domain Keyword: all-vm
Mode: Incremental Forever - Full
Target Node Name: MSF
Data Mover Node Name: MSF
Cluster Resource: No
```

3. VM Name: HPV2VM3-OLD

```
Domain Keyword: all-vm
Mode: Incremental Forever - Full
Target Node Name: MSF
Data Mover Node Name: MSF
Cluster Resource: No
```

4. VM Name: Local10

```
Domain Keyword: all-vm
Mode: Incremental Forever - Full
Target Node Name: MSF
```

```
Data Mover Node Name: MSF
Cluster Resource:      No
```

```
Disk[1]
Name: \\lingonberry\c$\Users\michael\Documents\Storage\Local10.vhdx
Capacity:      127.00 GB
Size:          4.00 MB
Full Backup:   included
Incremental Backup: excluded
Disk Type:     VHDX
Number of Subdisk: 0
```

```
Total number of virtual machines processed: 4
ANSI900I Return code is 0.
ANSI901I Highest return code was 0.
```

Related links for backing up Hyper-V virtual machines

- Detail
- Domain.vmfull
- Mbojrefreshthresh
- Mbpctrefreshthresh
- Mode
- Query VM
- Restore VM
- Vmbackdir
- Vmbackuptype

AIX Linux Solaris Windows

## Cancel Process

---

The cancel process command displays a list of current NAS (if NDMP support is enabled) image backup and restore processes for which the administrative user has authority. You are prompted for the IBM Spectrum Protect™ administrator ID.

From the list, the administrative user can select one process to cancel. Client owner privilege is sufficient authority to cancel the selected NAS image backup or restore processes.

AIX Solaris Windows

## Supported Clients

---

AIX Solaris This command is valid for AIX®, Linux, and Solaris clients only.

Windows This command is valid for all Windows clients.

## Syntax

---

```
>>-Cancel Process-----><
```

## Parameters

---

There are no parameters for this command.

## Examples

---

Task

Cancel current NAS image backup or restore processes.

**Command:** `cancel process`

## Cancel Restore

---

The cancel restore command displays a list of your restartable restore sessions in the server database.

You can cancel only one restartable restore session at a time. Run the cancel restore command again to cancel more restores. To restart restartable restore sessions, use the restart restore command.

Use the cancel restore command under the following circumstances:

- You cannot back up files that are affected by the restartable restore.
- **Windows** You want to cancel restartable restore sessions.
- Restartable restore sessions lock the file space so that files cannot be moved off of the sequential volumes of the server.

AIX Linux Solaris Mac OS X Windows

## Supported Clients

---

This command is valid for all clients.

## Syntax

---

```
>>-Cancel Restore-----<<
```

## Parameters

---

There are no parameters for this command.

## Examples

---

Task

Cancel a restore operation.

```
cancel restore
```

## Delete Access

---

The delete access command deletes authorization rules for files that are stored on the server.

When you delete an authorization rule, you revoke user access to any files or images that are specified by that rule.

AIX Linux Solaris Mac OS X Windows

## Supported Clients

---

This command is valid for all clients.

## Syntax

---

```
>>-Delete-- --Access-----<<
```

## Parameters

---

There are no parameters for this command.

## Examples

---

Task

Display a list of current authorization rules and select the rules that you want to delete.

```
delete access
```

See the following screen example:

AIX	Linux	Solaris	Mac OS X	
Index	Type	Node	Owner	Path
1	Backup	NODE1	USER1	home/dev/proja/list/
2	Archive	NODE3	LUIE	home/fin/budg/depta/
3	Backup	NODE4	USER2	home/plan/exp/deptc/
4	Archive	NODE5	USER2S	home/mfg/invn/parta/

Enter Index of rule(s) to delete, or quit to cancel:

**AIX** **Linux** **Solaris** **Mac OS X** To delete the authorization rules that allow luie and user2s to access your files or images, type 2 4 or 2, 4 and press Enter.

**Windows**

Index	Type	Node	Owner	Path
1	Backup	node1	daisy	c:\dev\proja\list.c
2	Archive	node3	marm	c:\fin\budg\depta.jan
3	Backup	node4	susie	c:\plan\exp\deptc.feb
4	Archive	node5	susies	c:\mfg\invn\parta.wip

Enter Index of rule(s) to delete, or quit to cancel:

**Windows** To delete the authorization rules that allow marm and susies to access your files, type 2 4 or 2, 4, then press Enter.

## Delete Archive

The delete archive command deletes archived files from IBM Spectrum Protect™ server storage. Your administrator must give you the authority to delete archived files.

**Important:** When you delete archived files, you cannot retrieve them. Verify that the files are obsolete before you delete them.

**AIX** **Linux** **Solaris** **Mac OS X** **Windows**

## Supported Clients

This command is valid for all clients.

## Syntax

```
>>-Delete ARchive----->
      '- --options-'
>--+- --filespec-----><
      '- --{--filespace--}-filespec-'
```

## Parameters

### filespec

Specifies the path and file name that you want to delete from storage. Use wildcard characters to specify a group of files or all files in a directory. You can also use the filelist option to process a list of files. The backup-archive client opens the file that you specify with this option and processes the list of files within according to the specific command.

**Note:** If you indicate *filespace*, do not include a drive letter in the file specification.

### {filespace}

Specifies the file space (enclosed in braces) on the server that contains the file you want to delete. This is the name on the workstation drive from which the file was archived.

Use the filespace if the name was changed, or if you are deleting files that are archived from another node with drive labels that are different from yours.

**Windows** You can specify a UNC name; drive label names are only used for removable media.

**Windows** You must specify a mixed or lowercase NTFS or ReFS file space name that is enclosed in quotation marks and braces. For example, {"NTFSDrive"}. Single quotation marks are valid in loop mode. For example, {"NTFSDrive"} and

{ 'NTFSDrive' } are both valid. In batch mode, only single quotation marks are valid. The single quotation mark requirement is a restriction of the operating system.

Table 1. Delete Archive command: Related options

Option	Where to use
dateformat	Client options file (dsm.opt) or command line.
description	Command line only.
filelist	Command line only.
noprompt	Command line only.
numberformat	Client options file (dsm.opt) or command line.
pick	Command line only.
subdir	Client options file (dsm.opt) or command line.
tapeprompt	Client options file (dsm.opt) or command line.
timeformat	Client options file (dsm.opt) or command line.

## Examples

**AIX Linux Solaris Mac OS X Task**

**AIX Linux Solaris Mac OS X** Delete a file that is named budget.

```
dsmc delete archive /user/home/proj1/budget
```

**AIX Linux Solaris Mac OS X Task**

**AIX Linux Solaris Mac OS X** Delete all files that are archived from the /user/home/proj1 directory with a file extension of .txt.

```
dsmc del arch "/user/home/proj1/*.txt"
```

**AIX Linux Solaris Mac OS X Task**

**AIX Linux Solaris Mac OS X** Delete files that are archived from the /user/project directory by using the pick option to display a list of archive copies that match the file specification. From the list, you can select the versions to process.

```
dsmc delete archive "/user/project/*" -pick
```

**AIX Linux Solaris Mac OS X Task**

**AIX Linux Solaris Mac OS X** Delete selected files from the group of files that are archived with the description "Monthly Budgets 2010" located in /user/projects and its subdirectories.

```
dsmc delete ar "/user/projects/*" -description="Monthly Budgets 2010" -pick -subdir=yes
```

**Windows Task**

**Windows** Delete files from file space abc in the proj directory.

```
dsmc delete archive {"abc"}\proj\*
```

**Windows Task**

**Windows** Delete a file that is named budget.

```
dsmc delete archive c:\plan\proj1\budget.jan
```

**Windows Task**

**Windows** Delete all files that are archived from the c:\plan\proj1 directory with a file extension of .txt.

```
delete archive c:\plan\proj1*.txt
```

**Windows Task**

**Windows** Delete files that are archived from the `c:\project` directory by using the `pick` option to display a list of archive copies that match the file specification. From the list, you can select the versions to process.

```
dsmc delete archive c:\project\* -pick
```

**Windows Task**

**Windows** Delete selected files from the group of files that are archived with the description "Monthly Budgets 2013" located in `c:\projects` and its subdirectories.

```
dsmc delete ar c:\projects\* -description="Monthly Budgets 2013" -pick -subdir=yes
```

## Delete Backup

The delete backup command deletes files, images, and virtual machines that were backed up to IBM Spectrum Protect™ server storage. Your administrator must give you authority to delete objects.

When you delete files, the IBM Spectrum Protect server takes all of the backed up files that meet the `filespec` and `deltypes` options that are specified and deactivates them. The server also assigns a deactivation date of *infinite-minus* so that the files are no longer available for restore and are purged, immediately on the subsequent run of file expiration. The file is not physically removed until the expiration process runs.

Important: After you delete backup files, you cannot restore them; verify that the backup files are no longer needed before you delete them. You are prompted to choose whether you want to continue with the delete. If you specify yes, the specified backup files are scheduled for deletion and removed from server storage.

AIX Linux Solaris Mac OS X Windows

## Supported Clients

This command is valid for all clients.

AIX Linux Solaris Mac OS X Windows

## Syntax

```
>>-Delete BACKup-- --+-----+----->
                        '+-filespec-----+'
                        '-{--filespace--}-filespec-'
>--+-----+----->
| .-objtype=FILE----- . |
'+-----+'
+objtype=IMAGE-----+
'-objtype=VM-----+ vmname-'
| .-BOTH--- . |
'--FROM --SERVER--'
| -LOCAL-- |
.-deltypes=ACTIVE-----
>--+-----+----->>
++-----++ '-options-'
| '-deltypes=INACTIVE-' |
'+-----+'
'-deltypes=ALL-'
```

## Parameters

*filespace/filespec*

*filespec*

Specifies the path and file name that you want to delete from storage. To specify a file in another file space, precede the file name with the file space name. Use wildcard characters to specify a group of files or all files in a directory. Separate file specifications with a space. You can also use the `filelist` option to process a list of files. The backup-archive client opens the file that is specified with this option and processes the list of files within according to the specific command.

Note: If you indicate *filespace*, do not include a drive letter in the file specification.

When you use `-deltype=inactive` or `-deltype=active`, use wildcard characters to specify a group of files or all files in a directory.

When you use `-deltype=all`, specify a fully wildcarded directory.

### *objtype*

Specifies the type of object that you want to delete. You can specify either of the following values:

#### FILE

Specifies that you want to delete directories and files. This value is the default object type.

#### IMAGE

Specifies that you want to delete an image backup. Specifies that you want to delete an image backup. `Objtype=image` is not supported on Mac OS X.

#### VM *vmname*

Specifies that you want to delete one or more versions of a virtual machine backup; the virtual machine is identified by the *vmname* variable parameter. The virtual machine name cannot contain wildcard characters.

 This feature is available only if the client operates as a data mover for IBM Spectrum Protect for Virtual Environments.

When `objtype=VM` is specified, the `filelist` option cannot be used. Specifying `objtype=VM` changes the behavior of the `-deltype` option. When `objtype=vm` is specified, you can use either `-deltype=active` or `-deltype=inactive`. You cannot use `-deltype=all`. Specifying `-deltype=inactive` displays a list of both inactive and active backups. You can use this list to specify which virtual machine backups that you want to delete. To delete only active virtual machine backups, use `-deltype=active`.

When you specify `-objtype=VM`, this command deletes only virtual machine backups that were created with any of the following modes: FULL, IFINCR, and IFFULL. Backups that were created with the full or incremental mode were created with the version 7.1 or earlier client.

For backups that were created with the version 7.1 or earlier clients: Individual incremental backups (backups that were created by using `MODE=INCR`) that were created after a full backup was run cannot be deleted with this command. However, if you delete a full virtual machine image backup (created by using `MODE=FULL`), and if the server has any incremental backups (`MODE=INCR`) that were created for this VM after the full backup, then deleting the full VM backup also deletes the files that were created by a `MODE=INCR` backup.

If you delete an active backup for a virtual machine, the most recent inactive copy becomes the active backup. If you specify the `-pick` or `-inactive` option, only the backup that you specify is deleted. If you select a backup that is created by `MODE=IFINCR`, only the selected incremental backup is deleted; other incremental backups for the virtual machine are not deleted.

#### -FROM

Specify the backup location or locations where virtual machine backups are deleted. You can specify one of the following values:

##### SERVER

Backups of virtual machines are deleted from the IBM Spectrum Protect server.

##### LOCAL

Persisted snapshots of virtual machines are deleted from the hardware storage.

##### BOTH

Backups of virtual machines that are on the IBM Spectrum Protect server and snapshots that are on the hardware storage are deleted. This value is the default.

Specifying this value displays a list of backup locations. From the list, you can select the location from which to delete virtual machine backups.

### *deltype*

Specifies the deletion type. Specify one of the following values:

#### ACTIVE

Delete only active file objects. Directory objects are not deleted. This value is the default deletion type.

Note: If there are any inactive objects, then after the active object is deleted, the most current inactive object is changed from inactive to active.

To delete all versions of a file, first issue the delete backup command with `-deltype=inactive`, then enter the command again with `-deltype=active`.

## INACTIVE

Delete only inactive file objects. Directory objects are not deleted.

## ALL

Delete all active and inactive objects below a particular directory, including all subdirectories and their files.

Note: The parent directory of the deleted files and subdirectories is not deleted. If you specify `delttype=ALL`, you cannot use the `pick` option because `delttype=ALL` and the `pick` option are mutually exclusive.

Table 1. Delete Backup command: Related options

Option	Where to use
description	Command line only.
filelist	Command line only.
fromdate	Command line, and in the GUI find function.
fromtime	Command line, and in the GUI find function.
noprompt	Command line only.
pick	Command line only.
pitdate	Command line, and in the GUI find function.
pittime	Command line, and in the GUI find function.
subdir	Client options file (dsm.opt) or command line.
tapeprompt	Client options file (dsm.opt) or command line.
timeformat	Client options file (dsm.opt) or command line.
to date	Command line, and in the GUI find function.
totime	Command line, and in the GUI find function.

## Examples

AIX Linux Solaris Mac OS X Task

AIX Linux Solaris Mac OS X Delete all active and inactive file objects that are named budget in directory

/data/plan/proj1.

Commands:

```
delete backup /data/plan/proj1/budget.jan
-delttype=inactive
delete backup /data/plan/proj1/budget.jan
-delttype=active
```

AIX Linux Solaris Mac OS X Task

AIX Linux Solaris Mac OS X Delete all inactive files that have a .txt extension that were backed up from the

/data/plan/proj1 directory and its subdirectories.

Command: `delete backup "/data/plan/proj1/*.txt" -delttype=inactive -subdir=yes`

AIX Linux Solaris Mac OS X Task

AIX Linux Solaris Mac OS X Delete selected active files that are backed up from the /home/marymb/project directory. Use the `-pick` option to display a list of backup copies that match the file specification. From the list, you can select which versions to delete.

Command: `delete backup "/home/marymb/project/*" -pick`

AIX Linux Solaris Mac OS X Task

AIX Linux Solaris Mac OS X Delete all active and inactive versions of files and subdirectories in the /home/storman/myproject directory. Then, delete all active and inactive versions of the /user/myproject directory.

Command:

```
delete backup "/home/storman/myproject*"
-delttype=all
```



#### Windows Task

**Windows** Delete all active file objects from file space abc in the proj directory.

```
Command: delete backup {abc}\proj\*
```

#### Windows Task

**Windows** Delete all inactive files with a name that ends with .txt that were backed up from the c:\plan\proj1 directory, and its subdirectories.

```
Command: delete backup c:\plan\proj1\*.txt -deltype=inactive -subdir=yes
```

#### Windows Task

**Windows** Delete selected active files that are backed up from the c:\project directory. Use the -pick option to display a list of backup copies that match the file specification. From the list, you can select which versions to delete.

```
Command: delete backup c:\project\* -pick
```

#### Windows Task

**Windows** Delete all active and inactive versions of files and subdirectories in c:\user\myproject.

```
Command: delete backup c:\user\myproject\* -deltype=all
```

Note: The backup versions of directory object c:\user\myproject are not deleted.

#### Windows Task

**Windows** Delete the active backup of a virtual machine that is named vm1.

```
Command: delete backup -objtype=vm vm1
```

Note: If one or more inactive versions of this backup exist, the most recent becomes the active version.

#### Windows Task

**Windows** Delete one or more backup versions of a virtual machine that is named vm\_test.

```
Command: delete backup -objtype=vm -inactive vm_test
```

Note: All versions of backups for this VM node are displayed in a list; you select the versions to delete.

## Delete Filespace

---

The delete filesystem command deletes file spaces in IBM Spectrum Protect™ server storage. A file space is a logical space on the server that contains files you backed up or archived.

**AIX** | **Linux** | **Solaris** | **Mac OS X** | **Mac OS X** You must be an authorized user to use this command.

**Mac OS X** | **AIX** | **Linux** | **Solaris** | **Mac OS X** IBM Spectrum Protect assigns a separate file space on the server for each workstation file system from which you back up or archive files. The file space name is the same as the file system name.

**Windows** IBM Spectrum Protect assigns a separate file space on the server for each workstation file system from which you back up or archive files. The file space name is the same as the UNC name.

When you enter the delete filesystem command, a list of your file spaces is displayed. From this list, select the file space that you want to delete.

Your IBM Spectrum Protect administrator must give you authority to delete a file space. You need BACKDEL authority if the file space you want to delete contains backup versions, or ARCHDEL authority if the file space contains archive copies. If the file space contains both backup versions and archive copies, you need both types of authority.

Important: When you delete a file space, you delete all backup versions and archive copies within that file space. When you delete a file space, **you cannot restore the files**. Verify that the files are obsolete before you delete them.

**AIX** | **Linux** | **Solaris** | **Mac OS X** | **Windows** You can use the delete filesystem command to interactively delete NAS file spaces from server storage. Use the nasnodename option to identify the NAS file server. Use the class option to specify the class of the file space to delete.

**AIX** | **Linux** | **Solaris** | **Mac OS X** | **Windows**

## Supported Clients

---

This command is valid for all clients.

## Syntax

```
>>-Delete Filespace--+-----+----->>
      '- --options-'
```

## Parameters

Table 1. Delete Filespace command: Related options

Option	Where to use										
<table border="1"><tr><td>AIX</td><td>Linux</td><td>Solaris</td><td>Mac OS X</td><td>Windows</td></tr></table> class	AIX	Linux	Solaris	Mac OS X	Windows	<table border="1"><tr><td>AIX</td><td>Linux</td><td>Solaris</td><td>Mac OS X</td><td>Windows</td></tr></table> Command line only.	AIX	Linux	Solaris	Mac OS X	Windows
AIX	Linux	Solaris	Mac OS X	Windows							
AIX	Linux	Solaris	Mac OS X	Windows							
detail	Command line only.										
<table border="1"><tr><td>Mac OS X</td><td>AIX</td><td>Linux</td><td>Solaris</td><td>Mac OS X</td></tr></table> nasnodename	Mac OS X	AIX	Linux	Solaris	Mac OS X	<table border="1"><tr><td>Mac OS X</td><td>AIX</td><td>Linux</td><td>Solaris</td><td>Mac OS X</td></tr></table> Client system options file or command line.	Mac OS X	AIX	Linux	Solaris	Mac OS X
Mac OS X	AIX	Linux	Solaris	Mac OS X							
Mac OS X	AIX	Linux	Solaris	Mac OS X							
<table border="1"><tr><td>Windows</td></tr></table> nasnodename	Windows	<table border="1"><tr><td>Windows</td></tr></table> Client options file or command line.	Windows								
Windows											
Windows											
<table border="1"><tr><td>Mac OS X</td><td>AIX</td><td>Linux</td><td>Solaris</td><td>Mac OS X</td></tr></table> scrolllines	Mac OS X	AIX	Linux	Solaris	Mac OS X	<table border="1"><tr><td>Mac OS X</td><td>AIX</td><td>Linux</td><td>Solaris</td><td>Mac OS X</td></tr></table> Client system options file or command line.	Mac OS X	AIX	Linux	Solaris	Mac OS X
Mac OS X	AIX	Linux	Solaris	Mac OS X							
Mac OS X	AIX	Linux	Solaris	Mac OS X							
<table border="1"><tr><td>Windows</td></tr></table> scrolllines	Windows	<table border="1"><tr><td>Windows</td></tr></table> Client options file or command line.	Windows								
Windows											
Windows											
<table border="1"><tr><td>Mac OS X</td><td>AIX</td><td>Linux</td><td>Solaris</td><td>Mac OS X</td></tr></table> scrollprompt	Mac OS X	AIX	Linux	Solaris	Mac OS X	<table border="1"><tr><td>Mac OS X</td><td>AIX</td><td>Linux</td><td>Solaris</td><td>Mac OS X</td></tr></table> Client system options file or command line.	Mac OS X	AIX	Linux	Solaris	Mac OS X
Mac OS X	AIX	Linux	Solaris	Mac OS X							
Mac OS X	AIX	Linux	Solaris	Mac OS X							
<table border="1"><tr><td>Windows</td></tr></table> scrollprompt	Windows	<table border="1"><tr><td>Windows</td></tr></table> Client system options file or command line.	Windows								
Windows											
Windows											

## Examples

### Task

Delete a file space.

**Command:** delete filespace

AIX	Linux	Solaris	Mac OS X	Windows	Task
-----	-------	---------	----------	---------	------

AIX	Linux	Solaris	Mac OS X	Windows	Delete NAS file spaces from the <b>dagordon</b> NAS file server stored on the server.
-----	-------	---------	----------	---------	---

**Command:** delete filespace -nasnodename=dagordon -class=nas

## Delete Group

Use the delete group command to delete a group backup on the IBM Spectrum Protect™ server.

After you delete a group, the group leader (virtualfsname) remains on the IBM Spectrum Protect server. It contains no members (file or directories) but is reported in a subsequent query filespace command. No files are listed if the showmembers option is added. Deleting a group does not remove the file space that it resides in because there might be other groups in it. Use delete filespace if you want to remove the file space and all the data it contains.

### Note:

1. Use the inactive option to display both active and inactive group backup versions. By default, the client displays active versions.
2. Use the pick option to select a specific group to delete from the IBM Spectrum Protect server.
3. Use the noprompt option if you want to suppress the confirmation prompt that normally appears before you delete a group backup version. By default, the client prompts you for confirmation before you delete the group backup. Using this option can speed up the delete procedure. However, it also increases the danger of accidentally deleting a group backup version that you want to save. Use this option with caution.
4. Use the query filespace command to display virtual file space names for your node that are stored on the server.

## Supported Clients

AIX Linux Solaris This command is valid for all UNIX and Linux clients, except for Mac OS X.

Windows This command is valid for all Windows clients.

## Syntax

```
>>-Delete GRoup-- --filespec--+-----+----->>
                    '- --options-'
```

## Parameters

filespec

Specifies the virtual file space name and the group name that you want to delete from the server storage.

Table 1. Delete Group command: Related options

Option	Where to use
inactive	Command line only.
noprompt	Command line only.
pick	Command line only.
pitdate	Command line only.
pittime	Command line only.

## Examples

AIX Linux Solaris Task

AIX Linux Solaris Delete the current active version of the /virtfs/group1 group.

**Command:**

```
delete group /virtfs/group1
```

Windows Task

Windows Delete the current active version of the virtfs\group1 group.

**Command:**

```
delete group {virtfs}\group1
```

AIX Linux Solaris Task

AIX Linux Solaris Delete a backup version of the /virtfs/group1 group from a list of active and inactive versions.

**Command:**

```
delete group /virtfs/group1 -inactive -pick
```

Windows Task

Windows Delete a backup version of the virtfs\group1 group from a list of active and inactive versions.

**Command:**

```
delete group {virtfs}\group1 -inactive -pick
```

## Expire

The expire command deactivates the backup objects that you specify in the file specification or with the filelist option. You can specify an individual file to expire, or a file that contains a list of files to expire. If `OBJTYPE=VM`, this command deactivates the current backup for a virtual machine.

When you are working in interactive mode, a prompt notifies you before files are expired.

The expire command does not remove workstation files. If you expire a file or directory that still exists on your workstation, the file or directory is backed up again during the next incremental backup, unless you exclude the object from backup processing.

If you expire a directory that contains active files, those files are not displayed in a subsequent query from the GUI. However, these files are displayed on the command line, if you specify the correct query with a wildcard character for the directory.

**AIX** | **Linux** | **Solaris** | **Mac OS X** Note: Because the expire command changes the server picture of the client file system without changing the client file system, the expire command is not allowed on files that are on a file system that is monitored by the IBM Spectrum Protect™ journal daemon.

**Windows** Note: Because the expire command changes the server picture of the client file system without changing the client file system, the expire command is not allowed on files that are on a file system that is monitored by the IBM Spectrum Protect journal service.

**AIX** | **Linux** | **Mac OS X** | **Solaris** | **Windows**

## Supported Clients

This command is valid for all clients.

## Syntax

```

                .-OBJTYPE=FILE-- --filespec-.
>>-EXpire-- -+-----+-----+-----+-----+-----+-----+----->
                                                     '-OBJTYPE=VM-- --vmname-'
>-+-----+-----+-----+-----+-----+-----+-----><
       '-options-'

```

## Parameters

**OBJTYPE=FILE filespec**

Specifies a path and a file name that you want to expire. You can enter only one file specification on this command. However, you can use wildcards to select a group of files or all the files in a directory. If you specify the filelist option, the filespec designation is ignored.

**OBJTYPE=VM vmname**

vmname specifies the name of a virtual machine. The active backup for the specified virtual machine is expired. The virtual machine name cannot contain wildcard characters.

When objtype=VM is specified, the expire command expires only full virtual machine backups (MODE=FULL or MODE=IFFULL) for the virtual machine that is specified on the vmname parameter. Backups that were created with the full or incremental mode were created with the version 7.1 or earlier client.

 This feature is available only if the client operates as a data mover for IBM Spectrum Protect for Virtual Environments.

Table 1. Expire command: Related options

Option	Where to use
<b>Windows</b> dateformat	<b>Windows</b> Client options file (dsm.opt) or command line.
<b>AIX</b>   <b>Linux</b>   <b>Solaris</b> <b>Mac OS X</b> dateformat	<b>AIX</b>   <b>Linux</b>   <b>Solaris</b>   <b>Mac OS X</b> Client user-options file (dsm.opt) or command line.
filelist	Command line only.
noprompt	Command line only.
<b>Windows</b> numberformat	<b>Windows</b> Client options file (dsm.opt) or command line.
<b>AIX</b>   <b>Linux</b>   <b>Solaris</b> <b>Mac OS X</b> numberformat	<b>AIX</b>   <b>Linux</b>   <b>Solaris</b>   <b>Mac OS X</b> Client user-options file (dsm.opt) or command line.
pick	Command line only.
<b>Windows</b> timeformat	<b>Windows</b> Client options file (dsm.opt) or command line.

Option	Where to use										
<table border="1"> <tr> <td>AIX</td> <td>Linux</td> <td>Solaris</td> </tr> <tr> <td>Mac OS X</td> <td colspan="2">timeformat</td> </tr> </table>	AIX	Linux	Solaris	Mac OS X	timeformat		<table border="1"> <tr> <td>AIX</td> <td>Linux</td> <td>Solaris</td> <td>Mac OS X</td> </tr> </table> Client user-options file (dsm.opt) or command line.	AIX	Linux	Solaris	Mac OS X
AIX	Linux	Solaris									
Mac OS X	timeformat										
AIX	Linux	Solaris	Mac OS X								

## Examples

AIX	Linux	Solaris	Mac OS X
-----	-------	---------	----------

**Task**  

AIX	Linux	Solaris	Mac OS X
-----	-------	---------	----------

 Deactivate the letter1.txt file in the home directory.

Command: `expire "/home/letter1.txt"`

Windows
---------

**Task**  

Windows
---------

 Deactivate the letter1.txt file in the home directory.

Command: `expire c:\home\letter1.txt`

AIX	Linux	Solaris	Mac OS X
-----	-------	---------	----------

**Task**  

AIX	Linux	Solaris	Mac OS X
-----	-------	---------	----------

 Deactivate all files in the /admin/mydir directory.

Command: `expire /admin/mydir/*`

Windows
---------

**Task**  

Windows
---------

 Deactivate all files in the admin\mydir directory.

Command: `expire c:\admin\mydir\*`

AIX	Linux	Solaris	Mac OS X
-----	-------	---------	----------

**Task**  

AIX	Linux	Solaris	Mac OS X
-----	-------	---------	----------

 Deactivate all files that are named in the /home/avi/filelist.txt file.

Command: `expire -filelist=/home/avi/filelist.txt`

Windows
---------

**Task**  

Windows
---------

 Deactivate all files that are named in the c:\avi\filelist.txt file.

Command: `expire -filelist=c:\avi\filelist.txt`

Windows
---------

**Task**  

Windows
---------

 Deactivate the current backup of the virtual machine that is named vm\_test.

Command: `expire -objtype=VM vm_test`

## Help

Use the help command to display information about commands, options, and messages.

Tip: If you use the help command on the initial command line, no server contact is made and no password is needed.

AIX	Linux	Solaris	Mac OS X	Windows
-----	-------	---------	----------	---------

## Supported Clients

This command is valid for all clients.

## Syntax

```
>>-Help--+-+-----+----->>
      +-command-name [subcommand-name]-+
      +-option-name-----+
      +-TOC-section-number-----+
      '- [ANS]message-number-----'
```

Entering the help command with no arguments causes help to display the complete table of contents. Either with the initial command or when HELP displays a prompt, you can enter the following parameters.

## Parameters

---

command-name [subcommand-name]

Specifies a command name and, optionally, a subcommand name or their abbreviation, for example: backup image, or b i. In that case, the combination must be unique. Non-unique abbreviations result in the display of the first section of the entire help file that matches the abbreviation. This parameter is optional.

option-name

Specifies the name of an option, for example: domain or do. This parameter is optional.

TOC-section-number

Specifies a table of contents section number, for example: 1.5.3. This parameter is optional.

[ANS]message-number

Specifies a message number with or without its prefix, for example: ans1036 or 1036. This parameter is optional. The severity code is never necessary. Entering ans1036E results in a not-found response.

**Important:** If you enter arguments that do not fit these descriptions, you may get unexpected results (or no results) to be displayed. If you enter more than two arguments, your help request is rejected. Where a command name and an option name are the same, for example: incremental (command) and incremental (option), you can get help on the option by entering its table-of-contents section number.

The requested help text is displayed in one or more sections, depending on the number of display lines that are available in your command window. When enough lines are displayed to fill the display space, or when the end of the requested help text is displayed, you see a prompt along with instructions for what can be entered at that prompt. To continue displaying text for your current selection, press enter or type the 'd' key to scroll down. To scroll up in the current selection, press the 'u' key and press Enter. Other choices might be presented, so read the prompt instructions.

Proper display of the help text requires a usable display width of 72 characters. A display width fewer than 72 characters causes sentences that are 72 characters wide to wrap to the next line. This can cause the displayed help text to begin somewhere within the section rather than at the beginning. The undisplayed lines can be viewed by using the scrolling function of the terminal to move up.

## Examples

---

Task

Display the table of contents of the help topics.

**Command:** `dsmc help`

Task

Display the information in help topic 2.1.2

**Command:** `dsmc help 2.1.2`

Task

Display help information on the archive command.

**Command:** `dsmc help archive`

Task

Display help information on message ANS1036.

**Command:** `dsmc help 1036`

**Command:** `dsmc help ANS1036`

## Incremental

---

The incremental command backs up all new or changed data in the locations that you specify, unless you exclude them from backup services.

**AIX** | **Linux** | **Solaris** | **Mac OS X** | **Windows** You can back up all new or changed files or directories in the default client domain or from file systems, directories, or files.

To incrementally back up selected files or directories, enter a file specification in the command. If you do not enter a file specification, the default is to back up files or directories in the default domain.

**AIX** AIX® only: You can enable snapshot-based incremental backup by using the option `snapshotproviderfs=JFS2`.

The following attributes in the management class that is assigned to the file or directory affect whether the data is backed up:

**AIX** | **Linux** | **Solaris** | **Mac OS X** | **Windows** **Frequency**

**AIX** | **Linux** | **Solaris** | **Mac OS X** | **Windows** The number of days that must elapse between successive backups of the object. The frequency attribute applies only to a full incremental backup.

**AIX** | **Linux** This management class attribute is ignored during a journal-based backup.

**Windows** This management class attribute is ignored during a journal-based backup.

#### Mode

Specifies whether changes since the last backup operation affect the processing. If `mode=modified`, only objects that changed since the last backup operation are processed. If `mode=absolute`, every object is processed, regardless of whether the object changed since the last backup operation.

If the copy group mode is set to modified, it can be overridden by using the client absolute option. For more information about the absolute option, see Absolute.

#### Serialization

Permits or denies backup of files or directories according to the following values:

- **static**: To be backed up, data must not be modified during backup or archive.
- **shared static**: If data in the file or directory changes during each of the allowed attempts to back up or archive it, it is not backed up or archived. The value of the `changingretries` option determines how many attempts are made. The default is 4.
- **dynamic**: The object is backed up or archived on the first attempt whether or not data changes during the process.
- **shared dynamic**: The object is backed up or archived on the last attempt, even if data changes during the process.

Using the `include` option in an include-exclude list, you can override the default management class for a file or group of files.

You can perform either a full incremental backup or an incremental-by-date backup. The default is a full incremental backup.

**AIX** | **Windows** | **Linux** If you are journaling a file system and the journal is valid, the full incremental backup performs a journal-based backup. More than one journal-based backup session can be started, but only one journal-based backup session can proceed. All other journal-based backup sessions that need access to the same file space must wait until the current journal-based backup session completes before the next session can proceed. You can perform a full incremental backup without the journal by using the `nojournals` option.

You can also use the selective command to perform a backup that backs up only the files, directories, or empty directories that you specify regardless of whether they were changed.

**AIX** | **Linux** | **Solaris** | **Mac OS X** A full incremental backs up all files and directories that are new or were changed since the last incremental backup. During a full incremental backup, the client queries the server. IBM Spectrum Protect™ uses this information when it performs the following actions:

**Windows** A full incremental backs up all files and directories that are new or were changed since the last incremental backup. During a full incremental backup, the client queries the server or the journal database. IBM Spectrum Protect uses this information when it performs the following actions:

- Backing up new files or directories.
- Backing up files or directories whose contents were changed since the previous backup.
- Marking inactive backup versions on the server for files or directories that are deleted from the workstation.
- Rebinding backup versions to management classes if the management class assignments change.

**AIX** | **Linux** | **Solaris** | **Mac OS X** | **Windows**

## Supported Clients

---

This command is valid for all clients.

**Mac OS X** | **AIX** | **Linux** | **Solaris** | **Mac OS X**

## Syntax

---

```

      .-----|
      v
>>-Incremental-+-----+-----+----->>
      '- --options-'   +- --filespec--+
                      '- --"filespec"-'

```

Windows

## Syntax

```

>>-Incremental-+-----+-----+----->>
      '- --options-'   | .-----|
                      | v         |
                      |-----| |
                      |--- --filespec-+-|

```

## Parameters

AIX | Linux | Solaris | Mac OS X **filespec**

AIX | Linux | Solaris | Mac OS X Specifies the path and file name that you want to back up. Use wildcard characters to select a group of files or all the files in a directory. If you do not specify a file specification, the domain option determine what to back up.

If you specify a file system, all new and changed files are backed up. In addition, the last incremental date for the file space is updated on the server. If you specify a file or directory, the last incremental date is not updated. This means that the file or directory might be backed up again if a later backup is performed by using the `incrbydate` option. If you specify a file system, specify the file system without a trailing slash.

Windows **filespec**

Windows Specifies the path and file name that you want to back up. Use wildcards to select a group of files or all the files in a directory. You can specify as many file specifications as available resources or other operating system limits permit. Separate file specifications with a space. You can also use the `filelist` option to process a list of files. The backup-archive client opens the file that you specify with this option and processes the list of files within according to the specific command. If you do not specify a file specification, the domain option determines what to backup.

If you specify a file system, all new and changed files are backed up. In addition, the last incremental date for the file space is updated on the server. If you specify a file or directory, the last incremental date is not updated. This means that the file or directory might be backed up again if a later backup is performed by using the `incrbydate` option. If you specify a file system, specify the file system without a trailing slash.

Table 1. Incremental command: Related options

Option	Where to use
<code>absolute</code>	Command line only.
Windows <code>autofsrename</code>	Windows Client options file ( <code>dsm.opt</code> ) only.
Windows <code>changingretries</code>	Windows Client options file ( <code>dsm.opt</code> ) or command line.
AIX   Linux   Solaris   Mac OS X <code>changingretries</code>	AIX   Linux   Solaris   Mac OS X <code>dsm.sys</code> file or command line.
Windows <code>compressalways</code>	Windows Client options file ( <code>dsm.opt</code> ) or command line.
AIX   Linux   Solaris   Mac OS X <code>compressalways</code>	AIX   Linux   Solaris   Mac OS X Client user-options file ( <code>dsm.opt</code> ) or command line.
Windows <code>compression</code>	Windows Client options file ( <code>dsm.opt</code> ) or command line.
AIX   Linux   Solaris   Mac OS X <code>compression</code>	AIX   Linux   Solaris   Mac OS X <code>dsm.sys</code> file within a server stanza or command line.
AIX   Linux   Windows <code>detail</code>	AIX   Linux   Windows Command line only.



Option	Where to use
<b>Linux</b>   <b>Windows</b>   diffsnapshot	<b>Linux</b>   <b>Windows</b>   Command line only.
dirsonly	Command line only.
<b>Windows</b>   domain	<b>Windows</b>   Client options file (dsm.opt) or command line.
<b>AIX</b>   <b>Linux</b>   <b>Solaris</b>   <b>Mac OS X</b>   domain	<b>AIX</b>   <b>Linux</b>   <b>Solaris</b>   <b>Mac OS X</b>   dsm.sys file or the client user-options file (dsm.opt) or command line.
<b>AIX</b>   <b>Linux</b>   <b>Solaris</b>   <b>Mac OS X</b>   encryptiontype	<b>AIX</b>   <b>Linux</b>   <b>Solaris</b>   <b>Mac OS X</b>   System-options file (dsm.sys) within a server stanza.
<b>Windows</b>   encryptiontype	<b>Windows</b>   Client options file (dsm.opt).
<b>Windows</b>   encryptkey	<b>Windows</b>   Client options file (dsm.opt).
<b>AIX</b>   <b>Linux</b>   <b>Solaris</b>   <b>Mac OS X</b>   encryptkey	<b>AIX</b>   <b>Linux</b>   <b>Solaris</b>   <b>Mac OS X</b>   System-options file (dsm.sys) within a server stanza.
filelist	Command line only.
filesonly	Command line only.
incrbydate	Command line only.
<b>Windows</b>   memoryefficientbackup	<b>Windows</b>   Client user-options file (dsm.opt), server, or command line.
<b>AIX</b>   <b>Linux</b>   <b>Solaris</b>   <b>Mac OS X</b>   memoryefficientbackup	<b>AIX</b>   <b>Linux</b>   <b>Solaris</b>   <b>Mac OS X</b>   Client user-options file (dsm.opt), client system-options file (dsm.sys), server, or command line.
<b>Windows</b>   nojournal	<b>Windows</b>   Command line only.
<b>AIX</b>   <b>Linux</b>   nojournal	<b>AIX</b>   <b>Linux</b>   Command line only.
<b>Windows</b>   postsnapshotcmd	<b>Windows</b>   Client options file (dsm.opt) or with include.fs option.
<b>AIX</b>   <b>Linux</b>   <b>Solaris</b>   <b>Mac OS X</b>   preservelastaccessdate	<b>AIX</b>   <b>Linux</b>   <b>Solaris</b>   <b>Mac OS X</b>   Client user-options file (dsm.opt) or command line.
<b>Windows</b>   preservelastaccessdate	<b>Windows</b>   Client options file (dsm.opt) or command line.
<b>Windows</b>   presnapshotcmd	<b>Windows</b>   Client options file (dsm.opt) or with include.fs option.
<b>AIX</b>   <b>Linux</b>   <b>Solaris</b>   <b>Mac OS X</b>   <b>Mac OS X</b>   removeoperandlimit	<b>AIX</b>   <b>Linux</b>   <b>Solaris</b>   <b>Mac OS X</b>   <b>Mac OS X</b>   Command line only.
<b>Windows</b>   resetarchiveattribute	<b>Windows</b>   Client options file (dsm.opt).
<b>Windows</b>   skipntpermissions	<b>Windows</b>   Client options file (dsm.opt) or command line.
<b>Windows</b>   skipntsecuritycrc	<b>Windows</b>   Client options file (dsm.opt) or command line.
<b>Linux</b>   <b>Windows</b>   snapdiff	<b>Linux</b>   <b>Windows</b>   Command line only.
<b>AIX</b>   <b>Linux</b>   snapshotcachesize	<b>AIX</b>   <b>Linux</b>   Client options file (dsm.opt) or with the include.fs option.
<b>AIX</b>   <b>Windows</b>   snapshotproviderfs	<b>AIX</b>   <b>Windows</b>   System-options file (dsm.sys) within a server stanza or with the include.fs option.
<b>Windows</b>   snapshotproviderimage	<b>Windows</b>   Client options file (dsm.opt) or with the include.image option.

Option	Where to use
snapshotroot	Command line only.
<b>Windows</b> subdir	<b>Windows</b> Client options file (dsm.opt) or command line.
<b>AIX</b>   <b>Linux</b>   <b>Solaris</b>   <b>Mac OS X</b> subdir	<b>AIX</b>   <b>Linux</b>   <b>Solaris</b>   <b>Mac OS X</b> Client user-options file (dsm.opt) or command line.
<b>Windows</b> tapeprompt	<b>Windows</b> Client options file (dsm.opt) or command line.
<b>AIX</b>   <b>Linux</b>   <b>Solaris</b>   <b>Mac OS X</b> tapeprompt	<b>AIX</b>   <b>Linux</b>   <b>Solaris</b>   <b>Mac OS X</b> Client user-options file (dsm.opt) or command line.

## Examples

**AIX** | **Linux** | **Solaris** | **Mac OS X** Task  
**AIX** | **Linux** | **Solaris** | **Mac OS X** Run an incremental backup of the client domain that is specified in your client user-options file (dsm.opt).

Incremental

**AIX** | **Linux** | **Solaris** | **Mac OS X** Run an incremental backup that backs up all files in the domain regardless of whether they were changed since the last backup.

Incremental -absolute

**Windows** Task  
**Windows** Run an incremental backup of the default client domain that is specified in your client options file (dsm.opt).

Incremental

**Windows** Run an incremental backup of the domain that is specified in your client user options file. Adding the -absolute option forces a backup of all files in the domain, even if they were not changed since the last incremental backup.

Incremental -absolute

**Windows** Task  
**Windows** Run an incremental backup of the C, D, and E drives.

incremental c: d: e:

**Windows** Task  
**Windows** Run an incremental backup of the \home\ngai directory and its contents on the current drive.

i \home\ngai\

**AIX** | **Linux** | **Solaris** | **Mac OS X** Task  
**AIX** | **Linux** | **Solaris** | **Mac OS X** Run an incremental backup for the /home, /usr, and /proj file systems.

Incremental /home /usr /proj

**AIX** | **Linux** | **Solaris** | **Mac OS X** Task  
**AIX** | **Linux** | **Solaris** | **Mac OS X** Run an incremental backup for the /proj/test directory.

Incremental /proj/test/

**AIX** | **Linux** | **Solaris** | **Mac OS X** Task  
**AIX** | **Linux** | **Solaris** | **Mac OS X** Run an incremental-by-date backup for the /home file system.

Incremental -incrbydate /home

**AIX** | **Linux** | **Solaris** | **Mac OS X** Task  
**AIX** | **Linux** | **Solaris** | **Mac OS X** Run an incremental backup of the abc file in the /fs/dir1 directory.

Incremental -subdir=yes /fs/dir1/abc

**AIX** | **Linux** | **Solaris** | **Mac OS X** Task

**AIX** | **Linux** | **Solaris** | **Mac OS X** Run an incremental backup of the directory object /fs/dir1, but not any of the files in the /fs/dir1 directory.

```
Incremental /fs/dir1
```

**AIX** | **Linux** | **Solaris** | **Mac OS X** **Task**

**AIX** | **Linux** | **Solaris** | **Mac OS X** Run an incremental backup of the directory object /fs/dir1, all of the files in the /fs/dir1 directory, and all files and subdirectories under /fs/dir1.

```
Incremental -subdir=yes /fs/dir1/
```

**AIX** | **Linux** | **Solaris** | **Mac OS X** **Task**

**AIX** | **Linux** | **Solaris** | **Mac OS X** Assuming that you initiated a snapshot of the /usr file system and mounted the snapshot as /snapshot/day1, run an incremental backup of all files and directories under the local snapshot and manage them on the IBM Spectrum Protect server under the file space name /usr.

```
dsmc inc /usr -snapshotroot=/snapshot/day1
```

**Windows** **Task**

**Windows** Assuming that you initiated a snapshot of the C drive and mounted the snapshot as \\florence\c\$\snapshots\snapshot.0, run an incremental backup of all files and directories under the local snapshot and manage them on the IBM Spectrum Protect server under the C:\ drive file space name.

```
dsmc inc c: -snapshotroot=\\florence\c$\snapshots\snapshot.0
```

**Linux** **Task**

**Linux** Run an incremental backup for the /home file system by using the snapdiff option and specify the option to create the difference snapshot. In the following example, /home is the NFS mount point for a NAS/N-Series file server volume.

```
incremental /home -snapdiff -diffsnapshot=create
```

**AIX** **Task**

**AIX** Run an incremental backup of the /proj file system by using the snapdiff option. Specify the option to use the latest snapshot on the file server as the difference snapshot. In the following example, /proj is the NFS mount point for a NAS/N-Series file server volume.

```
incremental /proj -snapdiff -diffsnapshot=latest
```

**Windows** **Task**

**Windows** Run a snapdiff incremental backup from a snapshot taken of a network share //homestore.example.com/vol1 mounted on drive H, where homestore.example.com is a file server.

```
incremental -snapdiff H:
```

**Windows** **Task**

**Windows** Run a snapdiff incremental backup from a snapshot taken of a network share //homestore.example.com/vol1 mounted on drive H, where homestore.example.com is a file server. The -diffsnapshot option value of LATEST means that the operation uses the latest snapshot (the active snapshot) for volume H.

```
incremental -snapdiff H: -diffsnapshot=LATEST
```

- **Windows** Open file support  
If open file support has been configured, the backup-archive performs a snapshot backup or archive of files that are locked (or "in use") by other applications.
- **Windows** Journal-based backup  
If the journal engine service is installed and running, then by default the incremental command performs a journal-based backup on file systems that are being monitored by the journal engine service.
- **AIX** | **Linux** Journal-based backup  
A backup for a particular file system is journal-based when the IBM Spectrum Protect journal daemon is installed and configured to journal the file system, and a valid journal has been established.
- Backing up NTFS or ReFS volume mount points  
If you perform an incremental backup of a file system on which a volume mount point exists, IBM Spectrum Protect backs up the directory (junction) where the volume is mounted, but it does not traverse or back up the data on the mounted volume.
- **Windows** Back up Microsoft Dfs root  
If you perform an incremental backup of Microsoft Dfs root with dfsbackupmntpnt=yes specified, the backup-archive client

backs up only the junction points, *not* the subtree under the junctions.

- Incremental-by-Date

An incremental-by-date backup backs up new and changed files with a modification date later than the date of the last incremental backup stored at the server, unless the files are excluded from backup by an **exclude** statement.

- Associate a local snapshot with a server file space

Use the snapshotroot option with the incremental command in conjunction with a vendor-supplied application that provides a snapshot of a logical volume, to associate the data on the local snapshot with the real file space data that is stored on the IBM Spectrum Protect server.

Windows

## Open file support

---

If open file support has been configured, the backup-archive performs a snapshot backup or archive of files that are locked (or "in use") by other applications.

Use VSS as the snapshot provider; set snapshotproviderimage or snapshotproviderfs to VSS.

Note:

1. You can use the include.fs option to set snapshot options on a per file system basis.
2. Open file support is only available for local fixed volumes (mounted to either drive letters or volume mount points) formatted with NTFS file systems. This support includes SAN-attached volumes that meet these requirements.
3. If the client is unable to create a snapshot, failover to non-OFS backup occurs; the same backup support that would be done if the OFS feature was not configured.
4. To enable open file support in a cluster environment all systems in the cluster should have the OFS feature configured.

Windows

## Journal-based backup

---

If the journal engine service is installed and running, then by default the incremental command performs a journal-based backup on file systems that are being monitored by the journal engine service.

The backup-archive client does not use the journaling facility inherent in Windows NTFS or ReFS file systems or any other journaled file system.

The journal engine service records changes to an object or its attributes in a journal database. During a journal-based backup, the client obtains a list of files that are eligible for backup from the journal database. Performing backups regularly maintains the size of the journal.

Journal-based backup can increase backup performance. With journal-based backup, the client does not scan the local file system or obtain information from the server to determine which files to process. Journal-based backup also reduces network traffic between the client and server.

The client filters the list by using the current include-exclude list. IBM Spectrum Protect™ processes, expires, and updates the resulting files according to policy constraints, such as serialization. The management-class copy frequency attribute is ignored during journal-based backup.

The journal engine service excludes specific system files (pagefile, registry, and so on) from having changes recorded in the journal. Because changes to these files are not journaled, the client does not back up these files. See the journal service configuration file tsmjbbd.ini, which is in the backup-archive client installation directory, for specific system files that are excluded.

To support journal-based backup, you must install the journaling engine service. Install this service by using the dsmscutil command or the GUI Setup wizard.

If the file specification on the incremental command is a file space, the client processes any journal entries for that file space. The client processes directories and file specifications that contain wildcards in the same way. The client uses the domain list if you do not specify a file specification.

Note: Journal-based backup might not fall back to the traditional incremental backup if the policy domain of your node is changed on the server, depending on when the policy set within the domain was last updated and the date of the last incremental. In this case, you must force a full traditional incremental backup to rebind the files to the new domain. Use the nojournal option with the

incremental command to specify that you want to perform a traditional full incremental backup, instead of the default journal-based backup.

When a user deletes a file with a long name, the Windows operating system might supply a short (compressed) name to the journal engine service. After the object is deleted, the compressed name can be reused and the deletion notice might no longer identify a unique object. During a journaled incremental backup, the attempt to expire the file fails because the compressed name is not known to the server. When this failure occurs, a record is placed in the journal, which indicates that the current directory is not exactly represented at the server. Use the `incrthreshold` option to specify what action is taken when this occurs.

The journal database is considered invalid and the client reverts to the traditional full incremental backup when any of the following events occur:

- A journaled file space name changes.
- The client node name changes.
- The client contacts a different server to do the backup.
- A policy changes occurs (new policy set activation).
- The journal is corrupted (out of space conditions, disk error).
- The journal service is not running.
- The journal service is stopped or started for any reason, even if it is restarted because the system is rebooted.

Journal-based backup differs from the traditional full incremental backup in the following ways:

- IBM Spectrum Protect does not enforce non-default copy frequencies (other than 0).
- Attribute changes to an object require a backup of the entire object.

You can use the `nojournal` option with the incremental command to perform a traditional full incremental backup instead of the default journal-based backup.

Multiple journal-based backup sessions are possible.

AIX | Linux

## Journal-based backup

---

A backup for a particular file system is journal-based when the IBM Spectrum Protect™ journal daemon is installed and configured to journal the file system, and a valid journal has been established.

**AIX** Journal-based backup is supported on the AIX® Backup-Archive Client, on JFS and JFS2 file systems.

**Linux** Journal-based backup is supported on the Linux Backup-Archive client on Ext2, Ext3, Ext4; XFS, ReiserFS, JFS, VxFS, and NSS. GPFS™ is not supported for journal-based backups on Linux.

If the journal daemon is installed and running, then by default the incremental command performs a journal-based backup on file systems which are being monitored by the journal engine daemon. The following conditions must be met in order to successfully perform a journal-based backup:

- The journal daemon must be set up to monitor the file system that contains the files and directories being backed up.
- A full incremental backup must have been run successfully at least once on the file system being backed up.
- The file space image of the file system at the server cannot have been modified by an administrative command since the last full incremental backup.
- The storage management policy for the files being backed up cannot have been updated since the last full incremental backup.

The journal daemon records changes to an object or its attributes in a journal database. During a journal-based backup, the client obtains a list of files that are eligible for backup from the journal database. Journal-based backup can increase backup performance because the client does not scan the local file system or contact the server to determine which files to process. Journal-based backup also reduces network traffic between the client and server.

The backup-archive client filters the list based on the current include-exclude list and processes, expires, and updates the resulting files according to policy constraints, such as serialization. However, the client ignores the server frequency attribute during a journal-based backup. The reason for this is because a journal-based backup eliminates the backup version query to the server; therefore, the client does not know how many days have transpired since the last backup of the file.

The journal daemon does not record changes in UNIX special files.

The journal daemon excludes specific system files from having changes recorded in the journal. Because changes to these files are not journaled, the client does not back up these files. See the journal daemon configuration file `tsmjbbd.ini` located in the backup-archive client installation directory for specific system files that are excluded.

Note:

1. When using antivirus software, there are limitations to journal-based backup. Some antivirus software can incorrectly generate change notifications to the IBM Spectrum Protect journal service, causing files that have not changed to be incorrectly backed up during journal based backup. To avoid these problems, use Norton Anti-Virus Corporate Edition 8.0 and higher.
2. A journal-based backup might not fall back to the traditional incremental backup if the policy domain of your node is changed on the server. This depends on when the policy set within the domain was last updated and the date of the last incremental backup. In this case, you must force a full traditional incremental backup to rebind the files to the new domain. Use the `nojournal` option with the incremental command to specify that you want to perform a traditional full incremental backup, instead of the default journal-based backup.

**AIX** Add an exclude snapshot statement to the `tsmjbbd.ini` file for AIX 6.1 (or later) to prevent JFS2 internal snapshot directories from being monitored by the journal-based backup daemon. If you do not exclude the snapshot directories, the files in them are backed up. Backing up the snapshot directories is redundant and wastes server space.

Under the following conditions, the journal database is considered invalid and the client reverts to the traditional full incremental backup:

- A journaled file space name has changed.
- The client node name has changed.
- The client contacts a different server to do the backup.
- Policy changes have occurred (new policy set activation).
- The journal is corrupt (out of space conditions, disk error).
- The journal is not running.

Journal-based backup differs from the traditional full incremental backup in the following ways:

- IBM Spectrum Protect does not enforce non-default copy frequencies (other than 0).
- Changes to UNIX special files are not detected.

You can use the `nojournal` option with the incremental command to perform a traditional full incremental backup instead of the default journal-based backup.

**Windows**

## Backing up NTFS or ReFS volume mount points

---

If you perform an incremental backup of a file system on which a volume mount point exists, IBM Spectrum Protect™ backs up the directory (junction) where the volume is mounted, but it does not traverse or back up the data on the mounted volume.

For example, if `C:\mount` is a mount point, then an incremental backup of the `C:\` drive backs up only the junction (`C:\mount`), and not the data under `C:\mount`.

- Backing up data on NTFS or ReFS mounted volumes  
Backing up a volume from the mount point is especially useful for volumes that have no drive letter assignment. If the volume mounted on the mount point can also be referenced by drive letter, then the volume does not have to be backed up over the mount point.

### Related concepts:

Restoring NTFS or ReFS volume mount points

Restoring data on NTFS mounted volumes

Backing up data on NTFS or ReFS mounted volumes

**Windows**

## Back up Microsoft Dfs root

---

If you perform an incremental backup of Microsoft Dfs root with `dfsbackupmntpnt=yes` specified, the backup-archive client backs up only the junction points, *not* the subtree under the junctions.

If you want to traverse the Dfs tree and back up the files and subdirectories of any junction it encounters, specify the `dfsbackupmntpnt=no` option. If you want to backup both the Dfs tree structure and the data contained in the Dfs tree you must run two backups: one with `dfsbackupmntpnt=yes` and one with `dfsbackupmntpnt=no`.

This option has no effect if you are backing up individual junctions. The **`exclude.dir`** option behavior for Dfs junctions is same as for mounted virtual volumes.

Note: If a Dfs root is added or modified, the client will not back it up. You must specify the Dfs root in the domain option in the client options file (`dsm.opt`) regardless of whether DOMAIN ALL-LOCAL is specified.

## Incremental-by-Date

---

An incremental-by-date backup backs up new and changed files with a modification date later than the date of the last incremental backup stored at the server, unless the files are excluded from backup by an **`exclude`** statement.

**Windows** If an incremental-by-date is performed on only part of a file system, the date of the last full incremental is not updated, and the next incremental-by-date will back up these files again. Use the `query filespace` command to determine the date and time of the last incremental backup of the entire file system.

**AIX Linux Solaris Mac OS X** If an incremental-by-date is performed on only part of a file system, the date of the last full incremental is not updated, and the next incremental-by-date will back up these files again. Changes to the access control lists (ACL) or Extended Attributes do not cause the files to be backed up during an incremental-by-date. Use the `query filespace` command to determine the date and time of the last incremental backup of the entire file system.

To perform an incremental-by-date backup, use the `incrbydate` option with the `incremental` command.

**AIX Linux Solaris Mac OS X Windows** Unlike a full incremental, an incremental-by-date does not maintain current server storage of *all* your workstation files for the following reasons:

- AIX Linux Solaris Mac OS X Windows** It does not expire backup versions of files that are deleted from the workstation.
- It does not rebind backup versions to a new management class if the management class has changed.
- It does not back up files with attributes that have changed, unless the modification dates and times have also changed.
- It ignores the copy group frequency attribute of management classes.

**AIX Linux Solaris Mac OS X Windows** For these reasons, if you have limited time during the week to perform backups, but extra time on the weekends, you can perform an incremental-by-date backup on weekdays and a full incremental backup on weekends to maintain current server storage of your workstation files.

If the `incremental` command is retried because of a communication failure or session loss, the transfer statistics will display the number of bytes that the client attempted to transfer during all command attempts. Therefore, the statistics for bytes transferred might not match the file statistics, such as those for file size.

## Associate a local snapshot with a server file space

---

Use the `snapshotroot` option with the `incremental` command in conjunction with a vendor-supplied application that provides a snapshot of a logical volume, to associate the data on the local snapshot with the real file space data that is stored on the IBM Spectrum Protect™ server.

The `snapshotroot` option does not provide any facilities to take a volume snapshot, only to manage data created by a volume snapshot.

## Loop

---

The `loop` command starts an interactive command line session that is maintained until you enter `quit`.

If you are required to enter a password, you are prompted for it before the loop mode prompt appears.

Note: It is not possible to enter loop mode without a valid server contact. One of the consequences is that certain commands, such as `restore backupset -location=file`, are only accepted on the initial command line when a valid server is not available.

In an interactive command line session, it is unnecessary to precede each command name with **`dsmc`** and your password, if one is required.

**Windows** In interactive mode, options that you enter on the initial command line override the value that you specified in your client options file (dsm.opt). This value remains in effect for the entire interactive session unless overridden by a different value on a given interactive command. For example, if you set the `subdir=yes` in your client options file (dsm.opt), and you specify `subdir=no` on the initial command line, the `subdir=no` setting remains in effect for the entire interactive session unless overridden by the `subdir=yes` value on a given interactive command. However, the `subdir=yes` value only affects the command it is entered on. When that command completes, the value reverts back to `subdir=no`, the value at the beginning of the interactive session.

**AIX Linux Solaris Mac OS X** In interactive mode, options that you enter on the initial command line override the value that you specified in your client user-options file (dsm.opt) or dsm.sys file. This value remains in effect for the entire interactive session unless overridden by a different value on a given interactive command. For example, if you set the `subdir=yes` in your client user-options file (dsm.opt), and you specify `subdir=no` on the initial command line, the `subdir=no` setting remains in effect for the entire interactive session unless overridden by the `subdir=yes` value on a given interactive command. However, the `subdir=yes` value only affects the command it is entered on. When that command completes, the value reverts back to `subdir=no`, the value at the beginning of the interactive session.

You can enter all valid commands in interactive mode *except* the `schedule` and `loop` commands.

There are some options that you cannot use in the interactive session created by the `loop` command and are identified in the option description by this statement: *This option is valid only on the initial command line. It is not valid in interactive mode.*

**AIX Linux Solaris Mac OS X** Note:

1. In loop mode, following a restore operation directly from tape, the mount point is not released in case additional restore requests are made to that volume. If you request a backup operation in the same session and that mount point is the only one available, the backup operation stops with the following message:

```
Waiting for mount of offline media
```

In this case, the mount point is not released until one of the following conditions is met:

- o The device class MOUNTRETENTION limit is satisfied.
  - o The client idletimeout period is satisfied.
  - o The dsmc loop session is closed after the restore operation completes, allowing you to start a subsequent loop mode session to perform the backup operation.
2. In interactive mode, you cannot enter a file specification that contains national language characters. If a command contains national characters, process the command in batch mode by preceding the command with the executable program name, **dsmc**.

## Supported Clients

---

This command is valid for all clients.

## Syntax

---

```
>>--LOOP----->><
```

## Parameters

---

There are no parameters for this command.

## Examples

---

Task

Start an interactive command line session.

**Command:** `dsmc`

At the `Protect>` prompt, enter a command.

**Windows** To end an interactive session, enter `quit`

**AIX Linux Solaris Mac OS X** There are two methods for ending an interactive session:

**AIX Linux Solaris Mac OS X**



- Enter quit
- If you set editor=yes, you can do the following:
  1. Press the Escape key (Esc).
  2. Type Q and press the Enter key.

**AIX** | **Linux** | **Solaris** | **Mac OS X** Note: The default setting is editor=yes.

Note: To interrupt a dsmc command before the client has finished processing, enter QQ on the IBM Spectrum Protect™ console. In many cases, but not all, this interrupts the command.

## Macro

The macro command runs a series of commands that you specify in a macro file.

By including the macro command within a macro file, you can nest as many as 10 levels of commands.

Comment lines are not supported within the macro file that you specify for the macro command.

**AIX** | **Linux** | **Solaris** | **Mac OS X** | **Windows**

## Supported Clients

This command is valid for all clients.

## Syntax

```
>>-Macro-- --macroname-----><
```

## Parameters

macroname

Specifies the fully qualified name of the file that contains the commands.

## Examples

The following is an example of how to use the macro command.

Task

Selectively back up files in the following directories:

- **Windows** c:\devel\project\proja
- **Windows** c:\devel\project\projb
- **Windows** c:\devel\project\projc
- **AIX** | **Linux** | **Solaris** | **Mac OS X** /devel/project/proja
- **AIX** | **Linux** | **Solaris** | **Mac OS X** /devel/project/projb
- **AIX** | **Linux** | **Solaris** | **Mac OS X** /devel/project/projc

**AIX** | **Linux** | **Solaris** | **Mac OS X** | **Windows** **Command:** macro backabc.mac

Where backabc.mac contains the following statements: **AIX** | **Linux** | **Solaris** | **Mac OS X**

```
Selective /devel/project/proja/
Selective /devel/project/projb/
Selective /devel/project/projc/
```

**Windows**

```
selective c:\devel\project\proja\*.*
selective c:\devel\project\projb\*.*
selective c:\devel\project\projc\*.*
```

**AIX** | **Linux** | **Solaris** | **Windows**

## Monitor Process

The monitor process command displays a list of current NAS (if NDMP support is enabled) image backup and restore processes for which the administrative user has authority. You are prompted for the IBM Spectrum Protect™ administrator ID.

The administrative user can then select one process to monitor. Client owner privilege is sufficient authority to monitor the selected NAS image backup or restore processes.

## Supported Clients

---

**AIX** | **Linux** | **Solaris** This command is valid for AIX®, Linux, and Solaris clients only.

**Windows** This command is valid for all Windows clients.

## Syntax

---

```
>>-MONitor Process-----<<
```

## Parameters

---

There are no parameters for this command.

## Examples

---

Task

Monitor current NAS image backup or restore processes.

**Command:** monitor process

## Preview Archive

---

The preview archive command simulates an archive command without sending data to the server.

The preview archive command generates a tab-delimited text file that can be imported into a spreadsheet program. The preview contains information such as whether the file is excluded or included. If the file is excluded, the pattern, or reason, that the file is excluded is listed, along with the source for the pattern.

**AIX** | **Linux** | **Solaris** | **Mac OS X** | **Windows**

## Supported Clients

---

This command is valid for all clients.

## Syntax

---

```

                                     .- -filter=ALL-.
>>-PREview--Archive--filespec--+- -filter=INCL+----->
                                     '- -filter=EXCL-'
>--+-----+-----+-----+----->
  '- -FILENAME= filename-' '- -CONsole-'
                                     .- -TRAverse=Yes-.
>--+-----+-----+-----+-----><
  '- -TRAverse=No--'
```

## Parameters

---

filespec

Specifies the path and file name that you want to archive. Use wildcard characters to select a group of files or all the files in a directory.

-filter

Specifies the output to display. You can display included objects, excluded objects, or both.

ALL

Display output for included and excluded objects. This is the default.

INCLuded

Display output for included objects only.

EXCLuded

Display output for excluded objects only.

-FILENAME=

Specifies the filename in which to write the tab-delimited output. The default is dsmprev.txt.

-CONSOLE

Output is written to the console, and the file.

-TRAverse

Preview the current directory and subdirectories.

Yes

Preview the current directories and subdirectories. This is the default.

No

Preview only the current directory, not subdirectories.

Important: Specifying **-traverse** does not preview directories excluded using the `exclude.dir` option.

## Preview Backup

---

The preview backup command simulates a backup command without sending data to the server.

The preview backup command generates a tab-delimited text file that can be imported into a spreadsheet program. The preview contains information such as whether the file is excluded or included. If the file is excluded, the pattern, or reason, that the file is excluded is listed, along with the source for the pattern.

AIX | Linux | Solaris | Mac OS X | Windows

## Supported Clients

---

This command is valid for all clients.

## Syntax

---

```
.. -filter=ALL--.
>>-PREview--backup--filespec--+ -filter=INCL-+----->
                                   '- -filter=EXCL-'
>+-----+-----+-----+----->
  '- -FILENAME= filename-' '- -CONSOLE-'
.. -TRAverse=Yes-.
>+-----+-----+-----+-----><
  '- -TRAverse=No--'
```

## Parameters

---

filespec

Specifies the path and file name that you want to back up. Use wildcard characters to select a group of files or all the files in a directory.

-filter

Specifies the output to display. You can display included objects, excluded objects, or both.

ALL

Display output for included and excluded objects. This is the default.

INCLuded

Display output for included objects only.

EXCLuded

Display output for excluded objects only.

- FILENAME=  
Specifies the filename in which to write the tab-delineated output. The default is dsmprev.txt.
- CONsole  
Output is written to the console, and the file.
- TRAverse  
Preview the current directory and subdirectories.  
  
Yes  
Preview the current directories and subdirectories. This is the default.  
No  
Preview only the current directory, not subdirectories.

Important: Specifying **-traverse** does not preview directories excluded using the exclude.dir option.

## Query Access

---

The query access command shows who was given access to backup versions or archive copies of specific files.

The backup-archive client displays a list of authorization rules that you defined with the set access command or with the Utilities > Node Access List menu in the backup-archive client graphical user interface (GUI).

The following information is included.

- Authority that you gave a user to restore backup versions or retrieve archive copies.
- The node name of the user to whom you gave authorization.
- |     |       |         |          |
|-----|-------|---------|----------|
| AIX | Linux | Solaris | Mac OS X |
|-----|-------|---------|----------|

 The ID of the user at that node to whom you gave authorization.
- The files to which the user has access.

## Supported Clients

---

This command is valid for all clients.

## Syntax

---

```
>>-Query Access-----<<
```

## Parameters

---

There are no parameters for this command.

## Examples

---

Task  
Display a list of users who have access to your files.

**Command:** `query access`

**Windows**

## Query Adobjects

---

Use the query adobjects command to display information about the deleted objects that are located on the local Active Directory domain.

On Windows Server operating system clients, Active Directory object information can also be displayed from full system-state backups on the server.

## Supported Clients

---

This command is valid for Windows Server OS clients only.

## Syntax

---

```
>>-Query ADOBJects--+-----+--+-----+-----><
                    '- --sourcepathspec-' '-options-'
```

## Parameters

---

### sourcepathspec

Specifies the Active Directory object or container to query. You can specify an asterisk (\*) as a wildcard character. You can specify either the full distinguished name of an object or a container, or just the name attribute (cn or ou), where the wildcard might be used. You can also specify object GUID enclosed in braces ({}). The following special characters require an escape character, the backslash, (\), if any of them are contained in the name:

- \
- #
- +
- =
- <
- >

For example, "cn=test#" is entered as "cn=test\#".

The client cannot display any object names that contain an asterisk (\*) as part of the name.

Table 1. Query Adobjects command: Related options

Option	Where to use
adlocation	Command line only.
dateformat	Client options file (dsm.opt) or command line.
detail	Command line only.
pitdate (option is ignored when adlocation is not specified)	Command line only.
pittime (option is ignored when adlocation is not specified)	Command line only.
scrolllines	Client options file (dsm.opt) or command line.
scrollprompt	Client options file (dsm.opt) or command line.
timeformat	Client options file (dsm.opt) or command line.

## Examples

---

### Task

Query all local deleted objects.

**Command:** `query adobjects`

### Task

Query all local deleted objects for a user with the name starting with Fred.

**Command:** `query adobjects "cn=Fred*" -detail`

### Task

Query all objects that are located in the Users container of the bryan.test.example.com domain from the server.

**Command:** `query adobjects "cn=Users,DC=bryan,DC=test,DC=ibm,DC=com" -adloc=server`

### Task

Query all local deleted objects for organizational unit testou.

**Command:** query adobjects "ou=testou"

#### Task

Query the local deleted object with a GUID of E079130D-3451-4C69-8349-31747E26C75B.

**Command:** query adobjects {E079130D-3451-4C69-8349-31747E26C75B}

## Query Archive

The query archive command displays a list of your archived files and the following information about each file: file size, archive date, file specification, expiration date, and archive description.

If you use the detail option with the query archive command, the client displays the following additional information:

- Last modification date
- |     |       |         |          |
|-----|-------|---------|----------|
| AIX | Linux | Solaris | Mac OS X |
|-----|-------|---------|----------|

 Last access date
- |     |       |         |          |
|-----|-------|---------|----------|
| AIX | Linux | Solaris | Mac OS X |
|-----|-------|---------|----------|

 Last file attributes (inode) change date
- |         |
|---------|
| Windows |
|---------|

 Creation date
- Compression type
- Encryption type
- |     |       |          |         |         |
|-----|-------|----------|---------|---------|
| AIX | Linux | Mac OS X | Solaris | Windows |
|-----|-------|----------|---------|---------|

 Client-side data deduplication
- Retention initiation
- Whether the file is on hold
- |     |       |
|-----|-------|
| AIX | Linux |
|-----|-------|

 Size of ACL metadata (IBM Spectrum Scale™), for AIX® and Linux clients
- |     |       |
|-----|-------|
| AIX | Linux |
|-----|-------|

 Server storage information (media class, volume ID, and restore order), for AIX and Linux clients

The following example shows sample output when the query archive command is issued with the detail option:

```

|     |       |          |         |
|-----|-------|----------|---------|
| AIX | Linux | Mac OS X | Solaris |
|-----|-------|----------|---------|

  
Size Archive Date - Time File - Expires on - Description  
-----  
219 B 08/15/2016 09:32:13 /Volumes/Data/info.txt 08/16/2016  
Archive Date: 08/16/2016  
RetInit:STARTED Obj  
Held:NO  
Modified: 03/02/2016 19:43:00 Accessed: 03/03/2016 09:31:23 Inode changed: 03/02/2016 19:43:00  
Compression Type: LZ4 Encryption Type: None Client-deduplicated: YES  
ACL Size: 0 Media Class: Fixed Volume ID: 0008 Restore Order: 00000000-0000001F-00000000-  
00600774
```

```

|         |
|---------|
| Windows |
|---------|

  
Size Archive Date - Time File - Expires on - Description  
-----  
219 B 03/03/2016 09:32:13 \\halley\m$\tsm620c.0901fa\debug\bin\  
winnt_unicode\dsm.opt 03/03/2016  
Archive Date: 03/03/2016  
RetInit:STARTED Obj  
Held:NO  
Modified: 03/03/2016 19:43:00 Created: 03/01/2016 15:31:23  
Compression Type: LZ4 Encryption Type: None Client-deduplicated: YES
```

For more information about the compression type, see Compression.

## Supported Clients

This command is valid for all clients.

## Syntax

```
>>-Query ARchive-+-----+----->  
      '- --options-'  
  
>--+ --filespec-----+--+ --filespec-----<<  
      '- --{--filespecname--}--filespec-' '- --"filespec"-'
```

## Parameters

**AIX** | **Linux** | **Solaris** | **Mac OS X** filespec

**AIX** | **Linux** | **Solaris** | **Mac OS X** Specifies the path and file name that you want to query. Use wildcard characters to specify a group of files or all the files in a directory. If you use wildcard characters, enclose the file specification in double quotation marks. Specify an asterisk (\*) to query all archived files in the current directory.

**Windows** filespec

**Windows** Specifies the path and file name that you want to query. Use wildcard characters to specify a group of files or all the files in a directory.

If you include filespace name, do not include a drive letter in the file specification. Drive label names are only used for removable media.

**Windows** {filespace name}

**Windows** Specifies the file space (enclosed in braces) on the server that contains the file that you want to query. The file space is the name on the workstation drive from which the file was archived. The following example is valid for specifying a UNC name: {'\\machine\C\$'}.

Use the filespace name if the name was changed or if you are querying files that were archived from another node with drive labels that are different from yours.

Note: You must specify a mixed or lowercase NTFS filespace name that is enclosed in quotation marks within braces, for example, {"NTFSDrive"}. Single quotation marks or double quotation marks are valid in loop mode. For example: {'NTFSDrive'} and {"NTFSDrive"} are both valid. In batch mode, only single quotation marks are valid.

Table 1. Query Archive command: Related options

Option	Where to use
<b>Windows</b> dateformat	<b>Windows</b> Client options file (dsm.opt) or command line.
<b>AIX</b>   <b>Linux</b>   <b>Solaris</b>   <b>Mac OS X</b> dateformat	<b>AIX</b>   <b>Linux</b>   <b>Solaris</b>   <b>Mac OS X</b> Client user-options file (dsm.opt) or command line.
description	Command line only.
detail	Command line only.
dirsonly	Command line only.
filelist	Command line only.
filesonly	Command line only.
fromdate	Command line only.
fromnode	Command line only.
<b>AIX</b>   <b>Linux</b>   <b>Solaris</b>   <b>Mac OS X</b>   <b>Mac OS X</b> fromowner	<b>AIX</b>   <b>Linux</b>   <b>Solaris</b>   <b>Mac OS X</b>   <b>Mac OS X</b> Command line only.
fromtime	Command line only.
<b>Windows</b> numberformat	<b>Windows</b> Client options file (dsm.opt) or command line.
<b>AIX</b>   <b>Linux</b>   <b>Solaris</b>   <b>Mac OS X</b> numberformat	<b>AIX</b>   <b>Linux</b>   <b>Solaris</b>   <b>Mac OS X</b> Client user-options file (dsm.opt) or command line.
querysummary	Command line only.
<b>Windows</b> scrolllines	<b>Windows</b> Client options file (dsm.opt) or command line.
<b>AIX</b>   <b>Linux</b>   <b>Solaris</b>   <b>Mac OS X</b> scrolllines	<b>AIX</b>   <b>Linux</b>   <b>Solaris</b>   <b>Mac OS X</b> Client user-options file (dsm.opt) or command line.
<b>Windows</b> scrollprompt	<b>Windows</b> Client options file (dsm.opt) or command line.
<b>AIX</b>   <b>Linux</b>   <b>Solaris</b>   <b>Mac OS X</b> scrollprompt	<b>AIX</b>   <b>Linux</b>   <b>Solaris</b>   <b>Mac OS X</b> Client user-options file (dsm.opt) or command line.
<b>Windows</b> subdir	<b>Windows</b> Client options file (dsm.opt) or command line.
<b>AIX</b>   <b>Linux</b>   <b>Solaris</b>   <b>Mac OS X</b> subdir	<b>AIX</b>   <b>Linux</b>   <b>Solaris</b>   <b>Mac OS X</b> Client user-options file (dsm.opt) or command line.

Option	Where to use
<b>Windows</b> timeformat	<b>Windows</b> Client options file (dsm.opt) or command line.
<b>AIX</b>   <b>Linux</b>   <b>Solaris</b> <b>Mac OS X</b> timeformat	<b>AIX</b>   <b>Linux</b>   <b>Solaris</b>   <b>Mac OS X</b> Client user-options file (dsm.opt) or command line.
today	Command line only.
totime	Command line only.

## Examples

**AIX** | **Linux** | **Solaris** | **Mac OS X** Task

**AIX** | **Linux** | **Solaris** | **Mac OS X** Display a list of all your archived files in the current working directory.

**Command:** q archive "\*"

**Windows** Task

**Windows** Display a list of all your archived files in the c:\proj directory.

**Command:** q ar c:\proj\\*

**AIX** | **Linux** | **Solaris** | **Mac OS X** Task

**AIX** | **Linux** | **Solaris** | **Mac OS X** Display a list of all your archived files in the /devel directory and all of its subdirectories.

**Command:** query archive "/devel/\*" -subdir=yes

**Windows** Task

**Windows** Display a list of archived files from your c: drive with the description "January Ledgers".

**Command:** query archive c:\ -su=y -descr="January Ledgers"

**AIX** | **Linux** | **Solaris** | **Mac OS X** Task

**AIX** | **Linux** | **Solaris** | **Mac OS X** Display a list of all your archived files in the current directory. Use the dateformat and timeformat options to reformat the dates and times.

**Command:** q ar -date=5 -time=1 "\*"

**Windows** Task

**Windows** Display a list of all your archived files in the c:\proj directory. Use the dateformat and timeformat options to reformat the dates and times.

**Command:** q ar -date=5 -time=4 c:\proj\\*

**AIX** | **Linux** | **Solaris** | **Mac OS X** Task

**AIX** | **Linux** | **Solaris** | **Mac OS X** Display a list of all your archived files in the current directory. Use the detail option to display the last modification date and the last access date of each file.

**Command:** q ar -detail "\*"

**Windows** Task

**Windows** Display a list of all your archived files in the c:\dir1 directory. Use the detail option to display the last modification date and the creation date of each file.

**Command:** q ar -detail c:\dir1\\*

**Windows** Task

**Windows** Display a list of archived files in the c:\proj directory that contains a file extension of .dev. Use the dateformat and timeformat options.

**Command:** q ar -date=5 -time=4 c:\proj\\*.dev

**Windows** Task

**Windows** Recently you changed the label of your c:\ drive to store and archive some files. Then, yesterday the label was changed to dev and some more files were archived. Display a list of all the files you archived in the c:\proj directory when the label was store.



**Command:** `q ar {store}\proj\*`

**Windows Task**

**Windows** Recently you archived files from a diskette labeled `docs`. Display a list of all the files you archived.

**Command:** `q ar {docs}\*`

**AIX Linux Solaris Mac OS X Task**

**AIX Linux Solaris Mac OS X** Display a list of archived files in the `/home/proj` directory whose first four characters of the file name begin with `proj`.

**Command:** `q ar "/home/proj/proj*"`

## Query Backup

The query backup command displays a list of backup versions of your files that are stored on the IBM Spectrum Protect™ server, or that are inside a backup set from the server when the `backupsetname` option is specified.

The command displays the following file information:

- File specification
- File size
- Backup date
- Whether the file is active or inactive
- The management class that is assigned to the file. Only the first 10 characters of the management class name are displayed.

If you use the detail option with the query backup command, the client displays the following extra information:

- Last modification date
- **AIX Linux Solaris Mac OS X** Last access date
- **AIX Linux Solaris Mac OS X** Last file attributes (inode) change date
- **Windows** Creation date
- Compression type
- Encryption type
- Client-side data deduplication
- **AIX Linux** Whether the file is migrated or premigrated. A value of `Yes` means that the file is migrated or premigrated. A value of `No` means that the file is not migrated or premigrated.
- **AIX Linux** File inode number
- **AIX Linux** Size of ACL metadata (IBM Spectrum Scale™)
- **AIX Linux** Server storage information (media class, volume ID, and restore order)

The following example shows sample output when the query backup command is issued with the detail option:

```
AIX Linux Mac OS X Solaris
      Size      Backup Date      Mgmt Class      A/I File
      ----      -
1,500,000 B 08/15/2016 16:01:25      DEFAULT      A /home/test/mydir/myfile1.txt
Modified: 08/15/2016 16:00:10 Accessed: 08/16/2016 15:31:23 Inode changed: 08/15/2016 16:00:10
Compression Type: LZ4 Encryption Type: None Client-deduplicated: YES Migrated: NO Inode#: 22691
ACL Size: 0 Media Class: Fixed Volume ID: 0008 Restore Order: 00000000-0000001F-00000000-00600774
```

**Windows**

```
      Size      Backup Date      Mgmt Class      A/I File
      ----      -
1,000,000 B 03/15/2016 14:33:17      DEFAULT      A \\eighth\n$\testdir\myfile1.txt
Modified: 03/15/2016 14:31:42      Created: 03/15/2016 14:31:41
Compression Type: LZ4 Encryption Type: None Client-deduplicated: YES
```

For more information about the compression type, see [Compression](#).

## Supported Clients

This command is valid for all clients.

## Syntax

```
>>-Query Backup--+-----+----->
      '- --options-'

>--+ --filespec-----+--+ --filespec---+-----<
      '- --{--filespace--}-filespec-' '- --"filespec"-'
```

## Parameters

**AIX Linux Solaris Mac OS X filespec**  
**AIX Linux Solaris Mac OS X** Specifies the path and file name that you want to query. Use wildcard characters to specify a group of files or all the files in a directory. If you use wildcard characters, enclose the file specification in double quotation marks. Specify an asterisk (\*) to display information about backup versions for all of your files in the current directory. Do not use wildcard characters when you query NAS file system images with `-class=nas` option setting.

**Windows filespec**  
**Windows** Specifies the path and file name that you want to query. Use wildcard characters to specify a group of files or all the files in a directory. Do not use wildcard characters when you query NAS file system images with `-class=nas` option setting.

If you include `filespace`, do not include a drive letter in the file specification. Drive label names are only used for removable media.

You can also use the following value for `filespec`:

`systemstate`  
 Displays the list of backup versions of Windows system state.

**Windows {filespace}**  
**Windows** Specifies the file space, enclosed in braces, on the server that contains the file you want to query. This is the drive label or UNC name on the workstation drive from which the file was backed up. The following example shows how to specify a UNC name: `{ '\\machine\C$' }`.

Use the `filespace` if the name has changed, or if you want to query files backed up from another node with drive label names that are different from yours.

You must specify a mixed or lowercase NTFS or ReFS file space name that is enclosed in quotation marks and braces. For example, `{"NTFSDrive"}`. Single quotation marks or double quotation marks are valid in loop mode. For example: `{"NTFSDrive"}` and `{'NTFSDrive'}` are both valid. In batch mode, only single quotation marks are valid.

Table 1. Query Backup command: Related options

Option	Where to use
backupsetname	Command line only.
<b>AIX Linux Solaris Mac OS X Windows</b> class	<b>AIX Linux Solaris Mac OS X Windows</b> Command line only.
<b>Windows</b> dateformat	<b>Windows</b> Client options file (dsm.opt) or command line.
<b>AIX Linux Solaris Mac OS X</b> dateformat	<b>AIX Linux Solaris Mac OS X</b> Client system options file (dsm.sys) or command line.
detail	Command line only.
dironly	Command line only.
filelist	Command line only.
filesonly	Command line only.
fromdate	Command line only.
fromowner	Command line only.
<b>AIX Linux Solaris Mac OS X Mac OS X</b> fromowner	<b>AIX Linux Solaris Mac OS X Mac OS X</b> Command line only.

Option	Where to use
fromtime	Command line only.
inactive	Command line only.
<b>AIX</b> <b>Linux</b> <b>Solaris</b> <b>Mac OS X</b> nasnodename	<b>AIX</b> <b>Linux</b> <b>Solaris</b> <b>Mac OS X</b> Client system options file (dsm.sys) or command line.
<b>Windows</b> nasnodename	<b>Windows</b> Client options file (dsm.opt) or command line.
<b>Windows</b> numberformat	<b>Windows</b> Client options file (dsm.opt) or command line.
<b>AIX</b> <b>Linux</b> <b>Solaris</b> <b>Mac OS X</b> numberformat	<b>AIX</b> <b>Linux</b> <b>Solaris</b> <b>Mac OS X</b> Client user-options file (dsm.opt) or command line.
pitdate	Command line only.
pittime	Command line only.
querysummary	Command line only.
<b>Windows</b> scrolllines	<b>Windows</b> Client options file (dsm.opt) or command line.
<b>AIX</b> <b>Linux</b> <b>Solaris</b> <b>Mac OS X</b> scrolllines	<b>AIX</b> <b>Linux</b> <b>Solaris</b> <b>Mac OS X</b> Client user-options file (dsm.opt) or command line.
<b>Windows</b> scrollprompt	<b>Windows</b> Client options file (dsm.opt) or command line.
<b>AIX</b> <b>Linux</b> <b>Solaris</b> <b>Mac OS X</b> scrollprompt	<b>AIX</b> <b>Linux</b> <b>Solaris</b> <b>Mac OS X</b> Client user-options file (dsm.opt) or command line.
<b>Windows</b> subdir	<b>Windows</b> Client options file (dsm.opt) or command line.
<b>AIX</b> <b>Linux</b> <b>Solaris</b> <b>Mac OS X</b> subdir	<b>AIX</b> <b>Linux</b> <b>Solaris</b> <b>Mac OS X</b> Client user-options file (dsm.opt) or command line.
<b>Windows</b> timeformat	<b>Windows</b> Client options file (dsm.opt) or command line.
<b>AIX</b> <b>Linux</b> <b>Solaris</b> <b>Mac OS X</b> timeformat	<b>AIX</b> <b>Linux</b> <b>Solaris</b> <b>Mac OS X</b> Client user-options file (dsm.opt) or command line.
todate	Command line only.
totime	Command line only.

## Examples

**Windows** dsmc query backup c:\\* -subdir=yes -querysummary

**Windows** dsmc query archive c:\\* -subdir=yes -querysummary

**Windows** Task

**Windows** Query files from the abc file space proj directory.

```
dsmc query backup {"abc"}\proj\*.*
```

**AIX** **Linux** **Solaris** **Mac OS X** Task

**AIX** **Linux** **Solaris** **Mac OS X** Display a list of all active and inactive backup versions of your files in the current directory.

```
dsmc query backup -inactive "*"
```

**Windows** Task

**Windows** Display a list of all active and inactive backup versions that were backed up from the c:\proj directory.

```
dsmc q backup -ina c:\proj\*
```

**AIX** **Linux** **Solaris** **Mac OS X** Task

**AIX** **Linux** **Solaris** **Mac OS X** Display a list of all your backups in the current directory. Use the detail option to display the last modification date and the last access date of each file.

```
dsmc q backup -detail "*"
```

#### Windows Task

**Windows** Display a list of all your backups in the `c:\dir1` directory. Use the detail option to display the last modification date and the creation date of each file.

```
dsmc q backup -detail c:\dir1\*
```

#### Windows Task

**Windows** Display a list of all active and inactive backup versions that were backed up from the `c:\proj` directory. Use the dateformat and timeformat options to reformat the dates and times.

```
dsmc q b -date=5 -time=4 -ina c:\proj\*
```

#### AIX Linux Solaris Mac OS X Task

**AIX Linux Solaris Mac OS X** Display a list of files that were backed up from the `/home/proj` directory with file names that begin with `proj`.

```
dsmc q b "/home/proj/proj*"
```

#### AIX Linux Solaris Mac OS X Task

**AIX Linux Solaris Mac OS X** Display a list of active and inactive backup file versions in the `/home` file system.

```
dsmc q b -ina -su=yes /home/
```

#### Windows Task

**Windows** Last week you backed up files from a diskette labeled **docs**. Display a list of those files.

```
dsmc q b {docs}\*
```

#### AIX Linux Solaris Task

**AIX Linux Solaris** Query file system images from the `nas2` NAS file server.

```
dsmc query backup -nasnodename=nas2 -class=nas
```

#### Windows Task

**Windows** Query file system images from the `nas2` NAS file server.

```
dsmc query backup -nasnodename=nas2 -class=nas
```

#### Windows Task

**Windows** Display a list of all files from your `c` drive that are contained in the backup set `weekly_accounting_data.32145678`.

```
dsmc query backup c:\* -subdir=yes -backupsetname=weekly_accounting_data.32145678
```

#### Windows Task

**Windows** Display information about all the active and inactive backup versions of the system state on the server.

```
dsmc query backup -ina systemstate
```

- **AIX Linux Solaris Mac OS X Windows** Query NAS file system images

You can use the query backup command to display information about file system images backed up for a NAS file server. The client prompts you for an administrator ID.

## Query Backupset

---

The query backupset command queries a backup set from a local file, tape device (if applicable), or the IBM Spectrum Protect™ server.

This command displays the backup set name, generation date, retention (for a backup set on the IBM Spectrum Protect server), and user-supplied description.

## Supported Clients

---

This command is valid for all clients.

**AIX Solaris** Tape support is only available on AIX® and Oracle Solaris clients.

## Syntax

```
>>-Query BACKUPSET---+-----+---BACKUPSETName=----->
      '-options-'

>---+backupsetname+---+-----+-----+-----><
  +-localfilename+  '-LOCation=---+server+--'
  '-tapedevice----'          +-file----+
                              '-tape---'
```

## Parameters

### BACKUPSETName=

Specifies the name of a backup set you want to query. You can use wildcards to specify the backup set name. If you use wildcards or do not specify a backup set name, all backup sets that you own are displayed. This parameter is required.

**AIX** **Linux** **Solaris** **Mac OS X** When a backup set is created, the server assigns root as the owner of the backup set. When querying a backup set on the server, a non-root user does not see the backup set listed, even if they know the backup set name and use it in the query.

The value of backupsetname depends on the location of the backup set, and corresponds to one of these three choices:

#### backupsetname

Specifies the name of the backup set from the server. If the location parameter is specified, you must set `-location=server`.

#### localfilename

Specifies the file name of the first backup set volume. You must set `-location=file`.

#### tapedevice

Specifies the name of the tape device that contains the backup set volume. You must use a Windows native device driver, not the device driver that is provided by IBM. You must set `-location=tape`.

### LOCation=

Specifies where the backup-archive client searches for the backup set. If you do not specify the location parameter, the client searches for backup sets on the IBM Spectrum Protect server.

#### server

Specifies that the client searches for the backup set from the server. This location is the default.

#### file

Specifies that the client searches for the backup set from a local file.

#### tape

Specifies that the client searches for the backup set from a local tape device.

Table 1. Query Backupset command: Related options

Option	Where to use
<b>AIX</b> <b>Linux</b> <b>Solaris</b> <b>Mac OS X</b> description	<b>AIX</b> <b>Linux</b> <b>Solaris</b> <b>Mac OS X</b> Command line only.
<b>Windows</b> description	<b>Windows</b> Command line only.
<b>Windows</b> scrolllines	<b>Windows</b> Client options file (dsm.opt) or command line.
<b>AIX</b> <b>Linux</b> <b>Mac OS X</b> <b>Solaris</b> scrolllines	<b>AIX</b> <b>Linux</b> <b>Mac OS X</b> <b>Solaris</b> Client user-options file (dsm.opt) or command line.
<b>Windows</b> scrollprompt	<b>Windows</b> Client options file (dsm.opt) or command line.
<b>AIX</b> <b>Linux</b> <b>Mac OS X</b> <b>Solaris</b> scrollprompt	<b>AIX</b> <b>Linux</b> <b>Mac OS X</b> <b>Solaris</b> Client user-options file (dsm.opt) or command line.

## Examples

### Task

Query all backup sets from the IBM Spectrum Protect server.

**Command:** query backupset -backupsetname=\*

#### Task

Query a backup set that is called `monthly_financial_data` from the IBM Spectrum Protect server.

**Command:** query backupset -backupsetname=monthly\_financial\_data.12345678

**AIX** | **Linux** | **Mac OS X** | **Solaris** | **Task**

**AIX** | **Linux** | **Mac OS X** | **Solaris** | Query the backup set in the file `/home/budget/weekly_budget_data.ost`.

**Command:** dsmc query backupset -backupsetname="/home/budget/weekly\_budget\_data.ost" -loc=file

**Windows** | **Task**

**Windows** | Query the backup set in the file `c:\budget\weekly_budget_data.ost`.

**Command:** query backupset -backupsetname=c:\budget\weekly\_budget\_data.ost loc=file

**AIX** | **Linux** | **Solaris** | **Mac OS X** | **Task**

**AIX** | **Linux** | **Solaris** | **Mac OS X** | Query the backup set from the `/dev/rmt0` tape device.

**Command:** dsmc query backupset -backupsetname=/dev/rmt0 -loc=tape

**Windows** | **Task**

**Windows** | Query the backup set from the `\\.\tape0` tape device.

**Command:** dsmc query backupset -backupsetname=\\.\tape0 -loc=tape

- Query Backupset without the backupsetname parameter  
The query backupset command can be used without the backupsetname parameter.

## Query Filespace

The query filespace command displays a list of file spaces for a node. The file spaces are stored on the IBM Spectrum Protect™ server, or inside a backup set from the server when the backupsetname option is specified. You can also specify a single file space name to query.

A *file space* is a logical space on the server that contains files you backed up or archived. A separate file space is assigned on the server for each node at your workstation from which you back up or archive files.

A separate file space is assigned on the server for each file system at your workstation from which you back up or archive files. The file space name is the same as the file system name.

**Windows** | A Unicode file space name might not display correctly if the server is unable to display the Unicode name. In this case, use the file space identifier (fsID) to identify these file spaces on the server. Use the query filespace command with the detail option to determine the fsID of a file space.

**AIX** | **Linux** | **Solaris** | **Mac OS X** | **Windows**

## Supported Clients

This command is valid for all clients.

## Syntax

```
>>-Query Filespace-+-----+-----+-----+-----><  
                '- --filespace-name-' '- --options-'
```

## Parameters

filespace-name

Specifies an optional character string that can include wildcards. Use this argument to specify a subset of file spaces. The default is to display all file spaces.

Table 1. Query Filespace command: Related options

Option	Where to use
backupsetname	Command line only.
Windows AIX Linux Solaris Mac OS X class	Windows AIX Linux Solaris Mac OS X Command line only.
Windows dateformat	Windows Client options file (dsm.opt) or command line.
AIX Linux Solaris Mac OS X dateformat	AIX Linux Solaris Mac OS X Client user-options file (dsm.opt) or command line.
detail	Command line only.
fromnode	Command line only.
AIX Linux Solaris Mac OS X Mac OS X fromowner	AIX Linux Solaris Mac OS X Mac OS X Command line only.
AIX Linux Solaris Mac OS X nasnodename	AIX Linux Solaris Mac OS X Client system options file (dsm.sys) or command line.
Windows nasnodename	Windows Client options file (dsm.opt) or command line.
Windows scrolllines	Windows Client options file (dsm.opt) or command line.
AIX Linux Solaris Mac OS X scrolllines	AIX Linux Solaris Mac OS X Client user-options file (dsm.opt) or command line.
Windows scrollprompt	Windows Client options file (dsm.opt) or command line.
AIX Linux Solaris Mac OS X scrollprompt	AIX Linux Solaris Mac OS X Client user-options file (dsm.opt) or command line.
Windows timeformat	Windows Client options file (dsm.opt) or command line.
AIX Linux Solaris Mac OS X timeformat	AIX Linux Solaris Mac OS X Client user-options file (dsm.opt) or command line.

## Examples

AIX Linux Solaris Mac OS X Windows Display your file spaces. Use the dateformat and timeformat options to reformat the dates and times.

```
query filesystem -date=5 -time=4
```

AIX Linux Solaris Mac OS X Display the /home file space.

```
query filesystem /home
```

AIX Linux Solaris Mac OS X Display file space names that include the pattern smith.

```
query filesystem "*smith"
```

AIX Linux Solaris Mac OS X Windows Query a file space from the nas2 NAS file server.

```
query filesystem -nasnodename=nas2 -class=nas
```

Windows Display the \\florence\c\$ file space.

```
query filesystem \\florence\c$
```

Windows Display all of the file space names on the server with a file space name that ends in '\$' belonging to system named florence.

```
query filesystem \\florence\*$
```

Windows Display file spaces in the backup set named monthly\_accounting.23456789.

```
query filesystem -backupsetname=monthly_accounting.23456789
```

Display detailed file space information that shows the replication status during a failover.

Command:

```
query filesystem -detail
```

Output:

#	Last Incr Date	Type	fsID	Unicode	Replication	File Space Name
1	00/00/0000 00:00:00	HFS	3	Yes	Current	/

Last Store Date	Server	Local
Backup Data :	04/29/2013 16:49:55	04/29/2013 16:49:55
Archive Data :	No Date Available	No Date Available

- **AIX | Linux | Solaris | Mac OS X | Windows** Query NAS file spaces

Use the `nasnodename` option to identify the NAS file server to query. When using an interactive command-line session with a non-administrative ID, the client prompts you for an administrator ID.

## Query Group

Use the `query group` command to display information about a group backup and its members.

Note:

1. Use the `showmembers` option to display and select individual group members that you want to query. The `showmembers` option is not valid with the `inactive` option. If you want to display members of a group that are not currently active, use the `pitdate` and `pittime` options to specify the backup date and time of the member you want to query.
2. **AIX | Linux | Solaris | Windows** Use the `query filesystem` command to display virtual file space names for your node that are stored on the IBM Spectrum Protect™ server.
3. If you perform a full and differential group backup, a query of this group using the `-inactive` option displays two active backups of the same name, one of type FULL and one of type DIFF.

**Windows** These backups inactivate any previous full and differential backups:

**Windows**

```
Protect> q group {\fs}\v1 -inactive
```

Size	Backup Date	Mgmt Class	A/I	Group
978 B	06/02/2007 11:57:04	DEFAULT	A	FULL \fs\v1
32 B	06/05/2007 13:52:04	DEFAULT	A	DIFF \fs\v1

**AIX | Linux | Solaris**

```
Protect> q group {/fs}/v1 -inactive
```

Size	Backup Date	Mgmt Class	A/I	Group
978 B	06/02/2007 11:57:04	DEFAULT	A	FULL /fs/v1
32 B	06/05/2007 13:52:04	DEFAULT	A	DIFF /fs/v1

If you query a group backup without the `-inactive` option, the query displays only the latest group backup, whether it is type FULL or type DIFF:

**Windows**

```
Protect> q group {\fs}\v1
```

Size	Backup Date	Mgmt Class	A/I	Group
32 B	06/05/2007 13:52:04	DEFAULT	A	DIFF \fs\v1

**AIX | Linux | Solaris**

```
Protect> q group {/fs}/v1
```

Size	Backup Date	Mgmt Class	A/I	Group
32 B	06/05/2007 13:52:04	DEFAULT	A	DIFF /fs/v1

## Supported Clients



**AIX** **Linux** **Solaris** This command is valid for all clients, except for Mac OS X.

**Windows** This command is valid for all clients.

## Syntax

```
>>-Query GGroup-- --filespec--+-----+----->>  
                                '- --options-'
```

## Parameters

**Windows** filespec

**Windows** Specifies the virtual file space name (enclosed in braces) and the group name on the server that you want to query.

**AIX** **Linux** **Solaris** filespec

**AIX** **Linux** **Solaris** Specifies the virtual file space name and the group name on the server that you want to query.

Table 1. Query Group command: Related options

Option	Where to use
fromnode	Command line only.
<b>AIX</b> <b>Linux</b> <b>Solaris</b> fromowner	<b>AIX</b> <b>Linux</b> <b>Solaris</b> Command line only.
inactive	Command line only.
pitdate	Command line only.
pittime	Command line only.
<b>AIX</b> <b>Linux</b> <b>Solaris</b> <b>Windows</b> showmembers (does not apply to Mac OS X)	<b>AIX</b> <b>Linux</b> <b>Solaris</b> <b>Windows</b> Command line only.

## Examples

**AIX** **Linux** **Solaris** Task

**AIX** **Linux** **Solaris** Display all the groups in the /virtfs file space.

**Command:**

```
query group /virtfs/*
```

**Windows** Task

**Windows** Display all the groups in the virtfs file space.

**Command:**

```
query group {virtfs}\*
```

**AIX** **Linux** **Solaris** Task

**AIX** **Linux** **Solaris** Display active and inactive versions of the /virtfs/group1 file space.

**Command:**

```
query group /virtfs/group1 -inactive
```

**Windows** Task

**Windows** Display active and inactive versions of the virtfs\group1 file space.

**Command:**

```
query group {virtfs}\group1 -inactive
```

**AIX** **Linux** **Solaris** Task

**AIX** **Linux** **Solaris** Display the /virtfs/group1 file space. Use the showmembers option to display a list of group members from which you can select one or more to query.

**Command:**

```
query group /virtfs/group1 -showmembers
```

**Windows** Task

**Windows** Display the `virtfs\group1` file space. Use the `showmembers` option to display a list of group members from which you can select one or more to query.

**Command:**

```
query group {virtfs}\group1 -showmembers
```

**AIX** | **Linux** | **Solaris** | **Windows**

## Query Image

The query image command displays information about file system images that are stored on the IBM Spectrum Protect™ server, or that are inside a backup set from the IBM Spectrum Protect server, when the `backupsetname` option is specified.

The following information about file system images is displayed:

- Image Size - The volume size which was backed up.
- **AIX** | **Linux** | **Solaris** Stored Size - The actual image size that is stored on the server. The stored image on the IBM Spectrum Protect server is the same size as the volume capacity. For online snapshot-based image backups, the stored image can be larger than the file system based on the size of the cache files. The stored image on the server is the same size as the volume capacity.
- **Windows** Stored Size - The actual image size that is stored on the server. Because image backup allows you to back up only used blocks in a file system, the stored image size on the IBM Spectrum Protect server could be smaller than the volume size. For online image backups, the stored image can be larger than the file system based on the size of the cache files.
- File system type
- Backup date and time
- Management class that is assigned to image backup
- Whether the image backup is an active or inactive copy
- The image name

Note: The IBM Spectrum Protect API must be installed to use the query image command.

## Supported Clients

**AIX** | **Linux** | **Solaris** This option is valid for AIX®, Linux, and Oracle Solaris clients.

**Windows** This command is valid for all Windows clients.

## Syntax

```
>>-Query Image-----+--- --logicalvolumename-----<<  
      '- --options-' '- --filespace-----'
```

## Parameters

`logicalvolumename`

The name of a logical volume you want to query. You must specify the exact name of the image. You cannot use wildcards. The default is all active images (unless restricted by one or more options).

`filespace`

Specifies the file system name that you want to query.

Omitting `logicalvolumename` and `filespace` causes all images to be displayed.

Table 1. Query Image command: Related options

Option	Where to use
<code>backupsetname</code>	Command line only.
<b>AIX</b>   <b>Linux</b>   <b>Solaris</b> <code>dateformat</code>	<b>AIX</b>   <b>Linux</b>   <b>Solaris</b> Client user option file ( <code>dsm.opt</code> ) or command line.

Option	Where to use
<b>Windows</b> dateformat	<b>Windows</b> Client option file (dsm.opt) or command line.
fromnode	Command line only.
<b>AIX</b> <b>Linux</b> <b>Solaris</b> fromowner	<b>AIX</b> <b>Linux</b> <b>Solaris</b> Command line only.
inactive	Command line only.
<b>AIX</b> <b>Linux</b> <b>Solaris</b> numberformat	<b>AIX</b> <b>Linux</b> <b>Solaris</b> Client user option file (dsm.opt) or command line.
<b>Windows</b> numberformat	<b>Windows</b> Client option file (dsm.opt) or command line.
pitdate	Command line only.
pittime	Command line only.
<b>AIX</b> <b>Linux</b> <b>Solaris</b> scrolllines	<b>AIX</b> <b>Linux</b> <b>Solaris</b> Client user options file (dsm.opt) or command line.
<b>Windows</b> scrolllines	<b>Windows</b> Client options file (dsm.opt) or command line.
<b>AIX</b> <b>Linux</b> <b>Solaris</b> scrollprompt	<b>AIX</b> <b>Linux</b> <b>Solaris</b> Client user options file (dsm.opt) or command line.
<b>Windows</b> scrollprompt	<b>Windows</b> Client options file (dsm.opt) or command line.
<b>AIX</b> <b>Linux</b> <b>Solaris</b> timeformat	<b>AIX</b> <b>Linux</b> <b>Solaris</b> Client user option file (dsm.opt) or command line.
<b>Windows</b> timeformat	<b>Windows</b> Client option file (dsm.opt) or command line.

## Examples

### Task

Display all backed up images.

**Command:** `q image`

**AIX** **Linux** **Solaris** Task

**AIX** **Linux** **Solaris** Display all backed up images that are owned by `kutras` at node `avalon`.

**Command:** `query image -fromnode=avalon -fromowner=kutras`

**AIX** **Linux** **Solaris** Task

**AIX** **Linux** **Solaris** Display active and inactive version of the `/usr` image.

**Command:** `q i /usr -inactive`

**Windows** Task

**Windows** Display active and inactive version of the `h:` image.

**Command:** `q im h: -inactive`

### Task

Display all images that are contained within the backup set `weekly_backup_data.32145678`.

**Command:** `query image -backupsetname=weekly_backup_data.32145678`

## Query Inclexcl

The query inclexcl command displays a list of include-exclude statements in the order in which they are processed during backup and archive operations. The list displays the type of option, the scope of the option (archive, all, and so on), and the name of the source file.

The backup-archive client excludes some files from file system backup and restore operations. You can use the query inclexcl command to display a list of these files. In the output of the command, these files have `Operating System` next to the path.

You can test the validity of patterns you want to use in your include-exclude list before you actually insert them in your options file. See the *test pattern* explanation.

Use the detail option to display the management class that is associated with an include-exclude statement.

**Windows** Use the display option to display the files that are included or excluded from a file system back up operation.

## Supported Clients

---

This command is valid for all clients.

## Syntax

---

AIX Linux Mac OS X Solaris

```
>>-Query INCLexcl-- --+-----+-----+-----+----->>
                        '-test pattern-' '- -DETail-'
```

**Windows**

```
>>-Query INCLexcl--+-----+-----+-----+-----+>>
                        '-test pattern-' '- -DETail-' |           .-basic---. |
                        '--DISPLAY=--+vssexcl+--'
                        '-all-----'
```

## Parameters

---

### test pattern

Use for testing the validity of patterns you want to use in your include-exclude list. When you use a test pattern with this command, the following occurs:

- The internal include-exclude list is not displayed
- The pattern is processed as if it came from an include-exclude statement, including all the usual error checking
- The pattern is displayed as it would appear in the include-exclude list

If the test pattern has no errors, the compiled pattern result is the same as the test pattern.

### -DETail

Displays the management class that is associated with the include-exclude statement.

**Windows** -DISPLAY=basic | vssexcl | all

**Windows** -DISPLAY=basic displays the files and directories that have been included or excluded by one of the following methods:

- The objects were included or excluded in the client options file.
- The objects were included or excluded in a server-side client option set.
- The objects were excluded by the operating system because they are contained in the HKEY\_LOCAL\_MACHINES\SYSTEM\CurrentControlSet\BackupRestore\FilesNotToBackup registry key.
- The objects were explicitly excluded by the client.

This is the default if a display value is not specified.

**Windows** -DISPLAY=vssexcl displays a list of files that are excluded from a file system backup, because they are included when a system state backup is performed. Files that are backed up by a backup systemstate operation are protected by the VSS writer; you cannot include these files in a file system backup by adding them to an include statement in the dsm.opt file, or client option set.

**Windows** -DISPLAY=all displays all files that are included or excluded during a file system backup.

## Examples

---

### Task

Exclude a file from deduplication by excluding it in the client options file:

```
Exclude Dedup *\...\file2
```

### Task

Display a basic list of include-exclude statements. Command:

```
query inclexcl
```

**Windows** Task

**Windows** Display a list of files that are excluded from file system backups because the VSS writer includes them in system state backups.

```
query inclexcl -display=vssexcl
```

Task

Display a list of include-exclude statements. Display the management class that is associated with each statement.

```
query inclexcl -detail
```

**AIX** | **Linux** | **Solaris** | **Mac OS X** Task

**AIX** | **Linux** | **Solaris** | **Mac OS X** Test the validity of this pattern: /.../?x?/\*.log

```
query inclexcl /.../?x?/*.log
```

**Windows** Task

**Windows** Test the validity of this pattern: ..\?x?\\*.log

```
query inclexcl ..\?x?\*.log
```

## Query Mgmtclass

The query mgmtclass command displays information about the management classes available in your active policy set.

Your administrator defines management classes that contain attributes which control whether a file is eligible for backup or archive services. Management classes also determine how backups and archives are managed on the server.

**Windows** Your active policy set contains a default management class; it can contain any number of extra management classes. You can assign specific management classes to files using include options that are located in the client options file (dsm.opt). If you do not assign a management class to a file, the default management class is used.

**AIX** | **Linux** | **Solaris** | **Mac OS X** Your active policy set contains a default management class; it can contain any number of extra management classes. You can assign specific management classes to files using include options that are located in the client user-options file (dsm.opt). If you do not assign a management class to a file, the default management class is used.

When you archive files, you can override the assigned management class by using the archmc option.

**AIX** | **Linux** | **Solaris** | **Mac OS X** | **Windows**

## Supported Clients

This command is valid for all clients.

## Syntax

```
>>-Query Mgmtclass--+-+-----+----->>  
                    '- --options-'
```

## Parameters

Table 1. Query Mgmtclass command: Related options

Option	Where to use
detail	Command line only.
fromnode	Command line only.

## Examples

**Command:** `query mgmtclass`

## Query Node

The query node command displays all the nodes for which an administrative user ID has authority to perform operations. You are prompted for the IBM Spectrum Protect™ administrator ID.

Ideally, the administrative user ID has at least client owner authority over the client workstation node they are using either from the command line or from the web.

Use the type option to specify the type of node to filter for. The following are the valid values:

- AIX Linux Solaris Mac OS X Windows nas
- client
- server
- any

The default is any.

Note: When the IBM Spectrum Protect for Virtual Environments: Data Protection for VMware license file is installed on a vStorage backup server, the platform string that is stored on the IBM Spectrum Protect server is set to "TDP VMware" for every nodename that is used on that machine. The platform string can be used in the context of PVU calculations. If a nodename is being used to back up the machine with standard Backup-Archive client functions (for example, file-level or image backup), then this platform string would be interpreted as a "client" for the purposes of PVU calculations.

For more information about processor value units, see *Estimating processor value units* in the IBM Spectrum Protect server documentation.

## Supported Clients

This command is valid for all clients.

## Syntax

```
>>-Query Node--+-+-----+----->>
                '- --options-'
```

## Parameters

Table 1. Query Node command: Related options

Option	Where to use
type	Command line only.
<span style="background-color: #800040; color: white; padding: 2px;">Windows</span> scrolllines	<span style="background-color: #800040; color: white; padding: 2px;">Windows</span> Client options file (dsm.opt) or command line.
<span style="background-color: #800040; color: white; padding: 2px;">AIX</span> <span style="background-color: #800040; color: white; padding: 2px;">Linux</span> <span style="background-color: #800040; color: white; padding: 2px;">Solaris</span> <span style="background-color: #800040; color: white; padding: 2px;">Mac OS X</span> scrolllines	<span style="background-color: #800040; color: white; padding: 2px;">AIX</span> <span style="background-color: #800040; color: white; padding: 2px;">Linux</span> <span style="background-color: #800040; color: white; padding: 2px;">Solaris</span> <span style="background-color: #800040; color: white; padding: 2px;">Mac OS X</span> Client user options file (dsm.opt) or command line.
<span style="background-color: #800040; color: white; padding: 2px;">Windows</span> scrollprompt	<span style="background-color: #800040; color: white; padding: 2px;">Windows</span> Client options file (dsm.opt) or command line.
<span style="background-color: #800040; color: white; padding: 2px;">AIX</span> <span style="background-color: #800040; color: white; padding: 2px;">Linux</span> <span style="background-color: #800040; color: white; padding: 2px;">Solaris</span> <span style="background-color: #800040; color: white; padding: 2px;">Mac OS X</span> scrollprompt	<span style="background-color: #800040; color: white; padding: 2px;">AIX</span> <span style="background-color: #800040; color: white; padding: 2px;">Linux</span> <span style="background-color: #800040; color: white; padding: 2px;">Solaris</span> <span style="background-color: #800040; color: white; padding: 2px;">Mac OS X</span> Client user options file (dsm.opt) or command line.

## Examples

**Command:** query node -type=nas

**Mac OS X Task**

**Mac OS X** Display all client nodes that are backup-archive clients.

**Command:** query node -type=client

## Query Options

Use the query options command to display all or part of your options and their current settings that are relevant to the command-line client.

AIX Linux Solaris Mac OS X Windows

## Supported Clients

This command is valid for all clients.

## Syntax

```
>>-Query Options--+-----+----- --pattern-----><
                    '- --options-'
```

## Parameters

pattern

An optional character string that can include wildcards. Use this argument to specify a subset of options. The default is to display all options.

Table 1. Query Options command: Related options

Option	Where to use
<b>Windows</b> scrolllines	<b>Windows</b> Client options file (dsm.opt) or command line.
<b>AIX</b> <b>Linux</b> <b>Solaris</b> <b>Mac OS X</b> scrolllines	<b>AIX</b> <b>Linux</b> <b>Solaris</b> <b>Mac OS X</b> Client user options file (dsm.opt) or command line.
<b>Windows</b> scrollprompt	<b>Windows</b> Client options file (dsm.opt) or command line.
<b>AIX</b> <b>Linux</b> <b>Solaris</b> <b>Mac OS X</b> scrollprompt	<b>AIX</b> <b>Linux</b> <b>Solaris</b> <b>Mac OS X</b> Client user options file (dsm.opt) or command line.

## Examples

Task

Display all options and their values.

```
query options
```

Task

Display only options that begin with *comm*.

```
query options comm*
```

Task

Display the value of the replace option.

```
query options replace
```

Task

Issue the command to display all options and their values. The failover status information is displayed.

```
query options
```

Output:

```

MYPRIMARYSERVERNAME: SERVER1
MYREPLICATIONSERVER: TARGET
  REFLSERVERNAME: TARGET
    Address: 192.0.2.9
      Port: 1501
    SSLPort: 1502
    GUID: 39.5a.da.d1.ae.92.11.e2.82.d3.00.0c.29.2f.07.d3
    Used: yes

```

## Query Restore

---

The query restore command displays a list of your restartable restore sessions in the server database. The list contains these fields: owner, replace, subdir, preservepath, source, and destination.

A restartable restore session is created when a wildcard restore command fails because of network outage, client failure, server outage, or a similar problem. When such a failure occurs, the file space is locked on the server and its files cannot be moved off the sequential volumes of the server. To unlock the file space, either restart the restore and allow it to complete (query restore command), or cancel the restore (cancel restore command). Use query restore to determine if you have any restartable restore sessions and which file spaces are affected.

AIX | Linux | Solaris | Mac OS X | Windows

## Supported Clients

---

This command is valid for all clients.

## Syntax

---

```
>>-Query Restore-----<<
```

## Parameters

---

There are no parameters for this command.

## Examples

---

Windows Task

The following example displays the output when you use query restore:

```

--- Restartable Restore Information ---
Restartable Session: 1
  Start date/time: 10/17/2001 15:18:22
    Source: {"\\ers\c$"}\data\proposals\*
    Destination: - not specified by user -

Restartable Session: 2
  Start date/time: 10/17/2001 15:20:01
    Source: {"\\ers\c$"}\data\spreadsheets\*
    Destination: - not specified by user -

```

Mac OS X | AIX | Linux | Solaris | Mac OS X Task

Mac OS X | AIX | Linux | Solaris | Mac OS X Display your restartable restore session in the server database.

**Command:** query restore

AIX | Linux | Mac OS X | Solaris | Windows

## Query Schedule

---

The query schedule command displays the events that are scheduled for your node. Your administrator can set up schedules to perform automatic backups and archives for you. To plan your work, use this command to determine when the next scheduled events occur.



## Supported Clients

---

This command is valid for all clients.

## Syntax

---

```
>>-Query SCHEDULE-----<<
```

## Parameters

---

There are no parameters for this command.

## Examples

---

### Task

Display your scheduled events.

**Command:** query schedule

## Query Session

---

The query session command displays information about your session, including the current node name, when the session was established, server information, and server connection information.

AIX	Linux	Solaris	Mac OS X	Windows
-----	-------	---------	----------	---------

## Supported Clients

---

This command is valid for all clients.

## Syntax

---

```
>>-Query SSession-----<<
```

## Parameters

---

There are no parameters for this command.

## Examples

---

AIX	Linux	Solaris	Mac OS X	Windows	Task
-----	-------	---------	----------	---------	------

AIX	Linux	Solaris	Mac OS X	Windows
-----	-------	---------	----------	---------

 Display your session information.

**Command:** query session

A sample query session display follows:

```
Server Name.....: HALLEY_SERVER1
Server Type.....: Windows
Archive Retain Protect..: "No"
Server Version.....: Ver. 6, Rel. 2, Lev. 0.0
Last Access Date.....: 09/03/2009 09:08:13
Delete Backup Files.....: "No"
Delete Archive Files....: "Yes"
Deduplication.....: "Server Only"
```

```
Node Name.....: HALLEY
User Name.....:
```

Possible client-side deduplication values:

- None
  - Displayed when connected to a pre V6.1 IBM Spectrum Protect™ server
- Server Only
- Client Or Server

AIX	Linux	Solaris	Task
AIX	Linux	Solaris	

A sample query session display with LAN-free enabled follows:

```
IBM Spectrum Protect Server Connection Information

Server Name.....: TEMPLAR
Server Type.....: AIX
Archive Retain Protect..: "No"
Server Version.....: Ver. 6, Rel. 1, Lev. 4.0
Last Access Date.....: 08/12/10  22:10:15
Delete Backup Files.....: "No"
Delete Archive Files....: "Yes"

Node Name.....: LAN2
User Name.....: root

Storage Agent Name.....: TEMPLAR_STA
Storage Agent Type.....: AIX
Storage Agent Version...: Ver. 6, Rel. 1, Lev. 3.3
```

## Query Systeminfo

Use the query systeminfo command to gather information and output this information to a file or the console.

This command is intended primarily as an aid for IBM® support to help diagnosing problems. However, users who are familiar with the concepts addressed by this information might also find it useful.

If you use the console option, no special formatting of the output is performed to accommodate screen height or width. Therefore, the console output can be difficult to read due to length and line-wrapping. If the console output is difficult to read, use the filename option with the query systeminfo command. This combination allows the output to be written to a file that can be submitted to IBM support.

AIX	Linux	Solaris	Mac OS X	Windows
-----	-------	---------	----------	---------

## Supported Clients

This command is valid for all clients.

## Syntax

```

      .----- .
      |         |
      v         |
>>-Query SYSTEMInfo----- --item-+--+-----><
                                   '- --options-'
```

## Parameters

item

Specifies one or more items from which you want to gather information and output the information to the file name that you specify with the filename option or to the console. The default is to gather all items.

You can gather information on one or more of the following items:

- DSMOPTFILE - The contents of dsm.opt file.
- |     |       |         |          |
|-----|-------|---------|----------|
| AIX | Linux | Solaris | Mac OS X |
|-----|-------|---------|----------|

 DSMSYSFILE - The contents of the dsm.sys file.
- |     |       |         |          |         |
|-----|-------|---------|----------|---------|
| AIX | Linux | Solaris | Mac OS X | Windows |
|-----|-------|---------|----------|---------|

 ENV - Environment variables.
- ERRORLOG - The client error log file.
- FILE - Attributes for the file name that you specify.

- **Windows** FILESNOTTOBACKUP - Enumeration of Windows Registry key:

```
HKEY_LOCAL_MACHINE\
  SYSTEM\
    CurrentControlSet\
      BackupRestore\
        FilesNotToBackup
```

This key specifies those files that are not to be backed up. The query inclexcl command indicates that these files are excluded per the operating system.

- INCLEXCL - Compiles a list of include-exclude in the order in which they are processed during backup and archive operations.
- **Windows** KEYSNOTTORESTORE - Enumeration of Windows Registry key:

```
HKEY_LOCAL_MACHINE\
  SYSTEM\
    ControlSet001\
      BackupRestore\
        KeysNotToRestore
```

This key specifies those Windows Registry keys that are not to be restored.

- **Windows** MSINFO - Windows system information (output from MSINFO32.EXE).
- OPTIONS - Compiled options.
- **Windows** OSINFO - Name and version of the client operating system
- **AIX** **Linux** **Solaris** **Mac OS X** OSINFO - Name and version of the client operating system (includes ULIMIT information for UNIX).
- POLICY - Policy set dump.
- **Windows** REGISTRY - IBM Spectrum Protect™-related Windows Registry entries.
- **AIX** **Linux** **Solaris** **Mac OS X** **Windows** SCHEDLOG - The contents of the schedule log (usually dsmsched.log).
- **Windows** SFP - The list of files that are protected by Windows System File Protection, and for each file, indicates whether that file exists. These files are backed up as part of the SYSFILES system object.
- **Windows** SFP=<filename> - Indicates whether the specified file (*filename*) is protected by Windows System File Protection. For example:

```
SFP=C:\WINNT\SYSTEM32\MSVCRT.DLL
```

- **Windows** SYSTEMSTATE - Windows system state information.
- **AIX** CLUSTER - AIX® cluster information.
- **Windows** CLUSTER - Windows cluster information.
- ENCRYPT - Available encryption methods.

Note:

1. **AIX** **Linux** **Solaris** **Mac OS X** Use the filename option to specify a file name in which to store the information that is gathered from the items you specify. If you do not specify a file name, by default the information is stored in the /Library/Application Support/tivoli/tsm/client/ba/bin/dsminfo.txt file (for Mac OS X) or the dsminfo.txt file (for other UNIX and Linux).
2. **Windows** Use the filename option to specify a file name in which to store the information gathered from the items you specify. If you do not specify a file name, by default the information is stored in the dsminfo.txt file.
3. Use the console option if you want to output the information to the console.

Table 1. Query Systeminfo command: Related options

Option	Where to use
console	Command line only.
filename	Command line only.

## Examples

Task

Gather and store the contents of the dsm.opt file and the IBM Spectrum Protect error log file in the tsminfo.txt file.

**Command:** query systeminfo dsmoptfile errorlog -filename=tsminfo.txt

## Query Systemstate

Use the query systemstate command to display information about a backup of the system state on the IBM Spectrum Protect™ server, or system state inside a backup set from the IBM Spectrum Protect server, when the backupsetname option is specified.

The output indicates whether the object is active ("A") or inactive ("I"). Only active objects are listed unless the inactive option is specified with the command. The backup-archive client on Windows supports standard and detailed format.

### Supported Clients

This command is valid for supported Windows clients only.

### Syntax

```
>>-Query SYSTEMState--+-+-----+----->>
                        '- options-'
```

### Parameters

Table 1. Query Systemstate command: Related options

Option	Where to use
backupsetname	Command line only.
dateformat	Client option file (dsm.opt) or command line.
inactive	Command line only.
numberformat	Client option file (dsm.opt) or command line.
pitdate	Command line only.
pittime	Command line only.
showmembers	Command line only.
timeformat	Client option file (dsm.opt) or command line.
detail	Command line only.

### Examples

#### Task

Display information about the active backup of the system state on the IBM Spectrum Protect server.

**Command:** `query systemstate`

#### Task

Display information about the active backup of the system state on the IBM Spectrum Protect server.

**Command:** `query systemstate -detail`

#### Task

Display information about the active backup of the system state that is contained within the backup set `daily_backup_data.12345678`.

**Command:** `query systemstate -backupsetname=daily_backup_data.12345678`

#### Task

To display information about Active Directory, enter the following command: `query systemstate -detail`.

Locate information that is related to Active Directory in the output.

Linux | Windows

## Query VM

Use the query VM command to list and verify the successful backups of virtual machines (VMs).

Windows

The query VM command can be used to determine which Microsoft Hyper-V virtual machines and VMware virtual machines have been backed up to the server. The information for each hypervisor is presented in its own section. If you are querying the backups of Hyper-V virtual machines, you can skip over the *Query VM for VMware virtual machines* text. If you are querying backups of VMware virtual machines, you do not need to read the *Query VM for Hyper-V virtual machines* text.

 This feature is available only if the client operates as a data mover for IBM Spectrum Protect™ for Virtual Environments.

Linux | Windows

## Query VM for VMware virtual machines

Use the query vm command to determine which VMware virtual machines were backed up.

## Supported Clients

Linux This command is valid on Linux clients that are installed on a vStorage backup server.

Windows This command is valid on Windows clients that are installed on a vStorage backup server.

## Syntax

```
>>-Query VM-- --vmname-----+-----+-----+-----><
|           .-BOTH-. | '-options-'
'--FROM --SERVER--'
' -LOCAL--'
```

## Parameters

vmname

Specifies the virtual machine host name that you want to query. If you omit the virtual machine name, the command displays all VM backups on the IBM Spectrum Protect server.

-FROM

Specifies the backup location or locations to query. You can specify one of the following values:

SERVER

The query is limited to backups that are on the IBM Spectrum Protect server.

LOCAL

The query is limited to persisted snapshots that are on the hardware storage.

BOTH

The query lists information for both backups that are on the IBM Spectrum Protect server and snapshots that are on the hardware storage. This value is the default.

Table 1. Query VM command: Related options for VMware virtual machine queries.

Option	Where to use
detail	Command line.
Valid for <code>vmbackuptype=fullvm</code>	
 Valid for <code>-vmrestoretype</code>	

Option	Where to use
inactive Valid for vmbackuptype=fullvm	Command line.
pitdate Valid for vmbackuptype=fullvm	Command line.
pittime Valid for vmbackuptype=fullvm	Command line.
vmbackuptype	Command line or client options file.
vmchost	Command line or client options file.
vmcpw	Command line or client options file.
vmcuser	Command line or client options file.

Linux Windows

## Query VM examples (VMware)

The following are examples of using the query VM command and the command with the -detail option.

Linux Windows Full VM

Linux Windows

```
q vm devesx04-24 -ina
Query Virtual Machine for Full VM backup
```

#	Backup Date	Mgmt Class	Size	Type	A/I	Location	Virtual Machine
1	12/07/2016 14:45:24	DDMGMT	47.85 GB	IFFULL	I	SERVER	devesx04-24
2	12/14/2016 17:38:05	DDMGMT	47.85 GB	IFINCR	A	SERVER	devesx04-24
3	01/23/2017 14:07:44	DDMGMT	47.85 GB	SNAPSHOT	I	LOCAL	devesx04-24
4	02/01/2017 08:59:52	DDMGMT	47.85 GB	SNAPSHOT	A	LOCAL	devesx04-24

ANS1900I Return code is 0.

Linux Windows Full VM with -detail option

Linux Windows

```
q vm devesx04-24 -ina -detail
Query Virtual Machine for Full VM backup
```

#	Backup Date	Mgmt Class	Size	Type	A/I	Location	Virtual Machine
1	12/07/2016 14:45:24	DDMGMT	47.85 GB	IFFULL	I	SERVER	devesx04-24

```

The size of this incremental backup: n/a
The number of incremental backups since last full: 0
The amount of extra data: 0
The IBM Spectrum Protect objects fragmentation: 0
Backup is represented by: 79 TSM objects
Application protection type: VMware
Snapshot type: VMware Tools
Disk[1]Label: Hard Disk 1
Disk[1]Name: [TSMXIV11:vVOL_JOANNE] rfc4122.750c6a3a-9c65-4a1f-9ed7-1b531aa204
af/devesx04-24-000003.vmdk
Disk[1]Status: Protected
Disk[2]Label: Hard Disk 2
Disk[2]Name: [TSMXIV11:vVOL_JOANNE] rfc4122.750c6a3a-9c65-4a1f-9ed7-1b531aa204
af/devesx04-24_1-000003.vmdk
Disk[2]Status: Protected
Disk[3]Label: Hard Disk 3
Disk[3]Name: [TSMXIV11:vVOL_JOANNE] rfc4122.750c6a3a-9c65-4a1f-9ed7-1b531aa204
af/devesx04-24_2-000003.vmdk
Disk[3]Status: Protected

```

```

2 12/14/2016 17:38:05 DDMGMT          47.85 GB IFINCR    A  SERVER    devesx04-24
  The size of this incremental backup: 186.43 MB
  The number of incremental backups since last full: 1
  The amount of extra data: 0
  The IBM Spectrum Protect objects fragmentation: 2
  Backup is represented by: 119 TSM objects
  Application protection type: VMware
  Snapshot type: VMware Tools
  Disk[1]Label:    Hard Disk 1
  Disk[1]Name:     [TSMXIV11:vVOL_JOANNE] rfc4122.750c6a3a-9c65-4a1f-9ed7-1b531aa204
af/devesx04-24-000006.vmdk
  Disk[1]Status:   Protected
  Disk[2]Label:    Hard Disk 2
  Disk[2]Name:     [TSMXIV11:vVOL_JOANNE] rfc4122.750c6a3a-9c65-4a1f-9ed7-1b531aa204
af/devesx04-24_1-000006.vmdk
  Disk[2]Status:   Protected
  Disk[3]Label:    Hard Disk 3
  Disk[3]Name:     [TSMXIV11:vVOL_JOANNE] rfc4122.750c6a3a-9c65-4a1f-9ed7-1b531aa204
af/devesx04-24_2-000006.vmdk
  Disk[3]Status:   Protected
3 01/23/2017 14:07:44 DDMGMT          47.85 GB SNAPSHOT  I  LOCAL    devesx04-24
  The size of this incremental backup: n/a
  The number of incremental backups since last full: 0
  The amount of extra data: 0
  The IBM Spectrum Protect objects fragmentation: 0
  Backup is represented by: 0 TSM objects
  Application protection type: VMware
  Snapshot type: VMware Tools
4 02/01/2017 08:59:52 DDMGMT          47.85 GB SNAPSHOT  A  LOCAL    devesx04-24
  The size of this incremental backup: n/a
  The number of incremental backups since last full: 0
  The amount of extra data: 0
  The IBM Spectrum Protect objects fragmentation: 0
  Backup is represented by: 0 TSM objects
  Application protection type: VMware
  Snapshot type: VMware Tools
-----
All averages are calculated only for incremental forever backups displayed above.
The average size of incremental backup: 186.43 MB
The average number of incremental backups since last full: 1
The average overhead of extra data: 0
The average objects fragmentation: 0
The average number of objects per backup: 49
ANS1900I Return code is 0.

```

**Windows** The following command returns a list of VMs that are running an instant restore operation.

```
q vm * -vmrestoretype=instantrestore
```

**Linux** **Windows** Query all VMware virtual machines that were backed up using `-vmbacktype=fullvm`:

```
q vm * -vmbackuptype=fullvm
```

**Windows**

## Query VM for Microsoft Hyper-V virtual machines

Use the `query vm` command to determine which Hyper-V virtual machines were backed up.

## Supported Clients

This command is valid on Windows clients that are installed on a Hyper-V host system.

## Syntax

```
>>-Query VM-- --vmname--+-----+-----><
                    '-options-'
```

## Parameters

vmname

Specifies the virtual machine host name that you want to query. The virtual machine name is case-sensitive. If you specify a VM name on the command, the name cannot contain wildcard characters.

If you omit the virtual machine name, the command displays all VM backups on the IBM Spectrum Protect server.

Windows

Table 2. Query VM command: Related options for Hyper-V virtual machine queries.

Option	Where to use
detail	Command line. Displays the details of each disk (label, name) and its status (protected or excluded), and incremental-forever backup performance statistics.
inactive	Command line.
pitdate	Command line.
pittime	Command line.

Windows

## Examples

### Task

List all virtual machines that have been backed up by Data Protection for Microsoft Hyper-V on the Hyper-V host.

```
dsmc query vm
```

Windows

## Query VM examples (Hyper-V)

The following example shows a query VM command that displays summary information about all Hyper-V virtual machines that have been backed up.

```
dsmc query vm
```

Query Virtual Machine for Full VM backup

#	Backup Date	Mgmt Class	Size	Type	A/I	Location	Virtual Machine
1	03/19/2017 17:54:34	STANDARD	17.00 GB	IFFULL	A	SERVER	DeptA_VM05
2	03/20/2017 01:51:34	STANDARD	15.00 GB	IFINCR	A	SERVER	DeptA_VM_W2k08R2
3	03/20/2017 01:46:19	STANDARD	36.00 GB	IFFULL	A	SERVER	DeptA_VM04

The following query VM command with the -detail option shows detailed information about Hyper-V VMs that have been backed up. The detailed output includes the type of backup that was performed, the size of the virtual machine, information about its disks, and statistics.

```
dsmc query vm -detail
```

Query Virtual Machine for Full VM backup

#	Backup Date	Mgmt Class	Size	Type	A/I	Location	Virtual Machine
1	03/19/2017 17:54:34	STANDARD	17.00 GB	IFFULL	A	SERVER	DeptA_VM05
The size of this incremental backup: n/a							
The number of incremental backups since last full: 0							
The amount of extra data: 0							
The IBM Spectrum Protect objects fragmentation: 0							
Backup is represented by: 99 IBM Spectrum Protect objects							
Application protection type: n/a							
Backup is compressed: No							
Backup is deduplicated: No							
Snapshot type: Hyper-V RCT Application Consistent							
Disk[1]Name: DeptA_VM05.vhdx							
Disk[1]Location: IDE 0 0							
Disk[1]Status: Protected							
Disk[2]Name: DeptA_VM05_Disk2.vhdx							
Disk[2]Location: SCSI 0 1							
Disk[2]Status: Protected							



```

Disk[3]Name:      Disk 7 2.00 GB Bus 0 Lun 4 Target 0
Disk[3]Location:  SCSI 0 0
Disk[3]Status:    Skipped: Physical disk
Disk[4]Name:      Disk 8 2.50 GB Bus 0 Lun 5 Target 0
Disk[4]Location:  SCSI 0 2
Disk[4]Status:    Skipped: Physical disk
2 03/20/2017 01:51:34 STANDARD      15.00 GB IFINCR      A SERVER      DeptA_VM_W2k08R2
The size of this incremental backup: 544.00 KB
The number of incremental backups since last full: 1
The amount of extra data: 0
The IBM Spectrum Protect objects fragmentation: 2
Backup is represented by: 37 IBM Spectrum Protect objects
Application protection type: n/a
Backup is compressed: No
Backup is deduplicated: No
Snapshot type: Hyper-V RCT Crash Consistent
Disk[1]Name:      DeptA_VM_W2k08R2.vhdx
Disk[1]Location:  IDE 0 0
Disk[1]Status:    Protected
3 03/20/2017 01:46:19 STANDARD      36.00 GB IFFULL      A SERVER      DeptA_VM04
The size of this incremental backup: n/a
The number of incremental backups since last full: 0
The amount of extra data: 0
The IBM Spectrum Protect objects fragmentation: 0
Backup is represented by: 79 IBM Spectrum Protect objects
Application protection type: n/a
Backup is compressed: No
Backup is deduplicated: No
Snapshot type: Hyper-V RCT Application Consistent
Disk[1]Name:      DeptA_VM04.vhdx
Disk[1]Location:  IDE 0 0
Disk[1]Status:    Protected

```

```

-----
All averages are calculated only for incremental forever backups displayed above.
The average size of incremental backup: 544.00 KB
The average number of incremental backups since last full: 0
The average overhead of extra data: 0
The average objects fragmentation: 0
The average number of objects per backup: 71

```

The detailed output also includes the snapshot type and disk information such as the following information:

#### Snapshot type

The type of snapshot that was taken during the VM backup operation:

##### Hyper-V RCT Application Consistent

A quiesced snapshot that was created with Hyper-V Resilient change Tracking (RCT) on Windows Server 2016.

##### Hyper-V RCT Crash Consistent

A non-quiesced snapshot that was created with Hyper-V RCT on Windows Server 2016.

##### Hyper-V VSS

A snapshot that was created with Volume Shadow Copy Service (VSS) on Windows Server 2012 or Windows Server 2012 R2.

#### Disk[n]Location

The disk location of VM disk *n*, where *n* is a number. The disk location consists of the disk controller type, "IDE" or "SCSI", followed by the controller number and device location number.

#### Disk[n]Status

The backup status of VM disk *n*, where *n* is a number.

##### Protected

Indicates that the data on the VM disk is backed up.

##### Skipped: Excluded by user

Indicates that the VM disk is excluded during backup operations as specified by the exclude.vmdisk option. For more information, see Exclude.vmdisk.

##### Skipped: Physical disk

Indicates that the VM disk is a physical disk (pass-through disk) and its data is not backed up. Only the disk configuration information is backed up. For more information, see Vmprocessvmwithphysdisks.

The following example shows the syntax to use to list detailed output for a specific virtual machine named DeptA\_VM\_W2k08R2.

```
dsmc query vm DeptA_VM_W2k08R2 -detail
```

Query Virtual Machine for Full VM backup

#	Backup Date	Mgmt Class	Size	Type	A/I	Location	Virtual Machine
1	03/20/2017 01:51:34	STANDARD	15.00 GB	IFINCR	A	SERVER	DeptA_VM_W2k08R2

The size of this incremental backup: 544.00 KB  
The number of incremental backups since last full: 1  
The amount of extra data: 0  
The IBM Spectrum Protect objects fragmentation: 2  
Backup is represented by: 37 IBM Spectrum Protect objects  
Application protection type: n/a  
Backup is compressed: No  
Backup is deduplicated: No  
Snapshot type: Hyper-V RCT Crash Consistent  
Disk[1]Name: Jimmy\_VM\_Windows2008R2.vhdx  
Disk[1]Location: IDE 0 0  
Disk[1]Status: Protected

All averages are calculated only for incremental forever backups displayed above.  
The average size of incremental backup: 544.00 KB  
The average number of incremental backups since last full: 1  
The average overhead of extra data: 0  
The average objects fragmentation: 2  
The average number of objects per backup: 37

## Restart Restore

The restart restore command displays a list of your restartable restore sessions in the server database.

You can restart only one restartable restore session at a time. Run the restart restore command again to restart further restores.

The restarted restore uses the same options that you used in the failed restore. The restarted restore continues from the point at which the restore previously failed.

To cancel restartable restore sessions, use the cancel restore command. Use the restart restore command when:

- Restartable restore sessions lock the file space at the server so that files cannot be moved off the sequential volumes of the server.
- You cannot back up files that are affected by the restartable restore.

Options from the failed session supersede new or changed options for the restarted session.

AIX | Linux | Solaris | Mac OS X | Windows

## Supported Clients

This command is valid for all clients.

## Syntax

```
>>-REStArt Restore-----<<
```

## Parameters

There are no parameters for this command.

## Examples

Task

Restart a restore.

**Command:** restart restore

# Restore

The restore command obtains copies of backup versions of your files from the IBM Spectrum Protect™ server, or inside a backup set.

To restore files, specify the directories or selected files, or select the files from a list. Restore files to the directory from which you backed them up or to a different directory. The backup-archive client uses the `preservepath` option with the `subtree` value as the default for restoring files.

**AIX** | **Linux** | **Solaris** | **Mac OS X** Note:

1. On UNIX and Linux systems when a symbolic link is created its modification time is set to the current system time and cannot be changed. So, when restoring a symbolic link its modification date and time is set to the date and time of the restore, not to the date and time the link had when it was backed up. As a result, the client backs up the symbolic link during the next incremental backup because its modification time changed since the last backup.

**Windows** Note:

1. When you restore directory, its modification date and time is set to the date and time of the restore, not to the date and time the directory had when it was backed up. This is because the client restores the directories first, then adds the files to the directories.
2. An error occurs if you attempt to restore a file whose name is the same the short name of an existing file. For example, if you attempt to restore a file that you specifically named ABCDEF~1.DOC into the same directory where a file named abcdefghijk.doc exists, the restore fails because the Windows operating system equates the file named abcdefghijk.doc to a short name of ABCDEF~1.DOC. The restore function treats this as a duplicate file.

If this error occurs, perform any of the following actions to correct it:

- o Restore the file with the short file name to a different location.
- o Stop the restore and change the name of the existing file.
- o Disable the short file name support on Windows.
- o Do not use file names that would conflict with the short file naming convention; for example, do not use ABCDEF~1.DOC.

If you set the `subdir` option to `yes` when you restore a specific path and file, the client recursively restores all subdirectories under that path, and any instances of the specified file that exist under any of those subdirectories.

**AIX** | **Linux** | **Solaris** | **Mac OS X** When you restore an entire directory or directory tree, and you do not specify the `inactive`, `latest`, `pick`, `todate`, and `fromdate` options on the restore command, the client tracks which objects are restored. If the restore process is interrupted for any reason, you can restart the restore at the point of interruption by entering the `restart restore` command. It is possible to create more than one restartable restore session. Restores are only restartable if the file specification is fully wildcarded. For example, for a restore that is restartable, enter:

```
dsmc rest /home/* -sub=yes
```

**AIX** | **Linux** | **Solaris** | **Mac OS X** For a restore that is not restartable, enter:

```
dsmc rest "/Users/user1/file?.c" -sub=yes
```

**AIX** | **Linux** | **Solaris** | **Mac OS X** Use the `query restore` command to display a list of your restartable restore sessions in the server database. Further backups of the file system cannot be performed unless the restartable restore completes by using the `restart restore` command or is canceled by using the `cancel restore` command.

```
dsmc rest "/Users/user1/file?.c" -sub=yes
```

**Windows** For more information, see the Microsoft Knowledge Base article Q121007, entitled *How to Disable the 8.3 Name Creation on NTFS Partitions*, for more information.

**Windows** If the restore command is tried again because of a communication failure or session loss, the transfer statistics display the bytes that the client attempted to transfer across all command attempts. Therefore, the statistics for bytes transferred might not match file statistics, such as those for file size.

**AIX** | **Linux** | **Solaris** | **Mac OS X** | **Windows**

## Supported Clients

This command is valid for all clients.

## Syntax

```

      .- --FILE-.
>>-REStore----->
      '- --options-'

>--+- --sourcefilespec----->
      '- --{--filespace--}-sourcefilespec-'

>--+- --sourcefilespec----->
      '- --"sourcefilespec"- ' - --destinationfilespec-'

>----->
      '-BACKUPSETName=--+backupsetname-+-'
      +-localfilename-+
      '-tapedevice----'

>-----><
      '-LOcation=--+server-+-'
      +-file---+
      '-tape---'
```

## Parameters

### file

This parameter specifies that the source file specification is an explicit file name. This parameter is required when you restore a file name from the current path, when you do not specify a relative or absolute path, and when the file name conflicts with one of the reserved restore command keywords, such as restore backupset.

### sourcefilespec

Specifies the path and file name in storage that you want to restore. Use wildcard characters to specify a group of files or all the files in a directory.

**Windows** Note: If you include filespace, do not include a drive letter in the file specification.

### {filespace}

Specifies the file space (enclosed in braces) on the server that contains the files you want to restore. This is the name on the workstation drive from which the files were backed up.

Specify the file space name if the drive label name has changed or if you are restoring files that were backed up from another node that had drive labels that are different from yours.

**Windows** Note: You must specify a mixed or lowercase NTFS or ReFS file space name that is enclosed in quotation marks and braces. For example, {"NTFSDrive"}. Single quotation marks or double quotation marks are valid in loop mode. For example: {"NTFSDrive"} and {'NTFSDrive'} are both valid. In batch mode, only single quotation marks are valid. The single quotation marks requirement is a restriction of the operating system.

### destinationfilespec

Specifies the path and file name where you want to place the restored files. If you do not specify a destination, the client restores the files to the original source path.

**Windows** When you enter the destinationfilespec, consider the following points:

- If the sourcefilespec names a single file, the destinationfilespec can be a file or a directory. If you are restoring a single file, you can optionally end the specification with a file name if you want to give the restored file a new name.
- If the sourcefilespec is wildcarded or `subdir=yes` is specified, the destinationfilespec must be a directory and end with a directory delimiter (\).

Note: If the destination path or any part of it does not exist, the client creates it.

**AIX** | **Linux** | **Solaris** | **Mac OS X** Note: If you do not specify a destination, the client determines whether the original file system can be reached. If the original file system cannot be reached, the client will not restore the file. In this case, you can specify a different destination and try the command again.

### BACKUPSETName=

Specifies the name of a backup set. This parameter is optional. If you specify the backupsetname parameter with the restore command, you cannot use the pick option.

The value of backupsetname depends on the location of the backup set, and corresponds to one of the following options:

backupsetname

Specifies the name of the backup set from the IBM Spectrum Protect server. If the location parameter is specified, you must set `-location=server`. If the backup set resides in IBM Spectrum Protect server storage, the backup set must have a TOC.

localfilename

Specifies the file name of the first backup set volume. You must set `-location=file`.

tapedevice

Specifies the name of the tape device that contains the backup set volume. You must use a Windows-provided device driver, not the device driver that is provided by IBM. You must set `-location=tape`.

LOCation=

Specifies where the client searches for the backup set. If you do not specify the location parameter, the client searches for backup sets on the IBM Spectrum Protect server.

server

Specifies that the client searches for the backup set from the server. This is the default location.

file

Specifies that the client searches for the backup set from a local file.

tape

Specifies that the client searches for the backup set from a local tape device.

Table 1. Restore command: Related options

Option	Where to use
<b>Windows</b> asrmode	<b>Windows</b> Command line only.
<b>Windows</b> dateformat	<b>Windows</b> Client options file (dsm.opt) or command line.
<b>AIX</b> <b>Linux</b> <b>Solaris</b> <b>Mac OS X</b> dateformat	<b>AIX</b> <b>Linux</b> <b>Solaris</b> <b>Mac OS X</b> Client user options file (dsm.opt) or command line.
dirsonly	Command line only.
filelist	Command line only.
filesonly	Command line only.
<b>AIX</b> <b>Linux</b> <b>Solaris</b> <b>Mac OS X</b> followsymbolic	<b>AIX</b> <b>Linux</b> <b>Solaris</b> <b>Mac OS X</b> Client user options file (dsm.opt) or command line.
fromdate	Command line only.
fromnode	Command line only.
<b>AIX</b> <b>Linux</b> <b>Solaris</b> <b>Mac OS X</b> <b>Mac OS X</b> fromowner	<b>AIX</b> <b>Linux</b> <b>Solaris</b> <b>Mac OS X</b> <b>Mac OS X</b> Command line only.
fromtime	Command line only.
ifnewer	Command line only.
inactive	Command line only.
latest	Command line only.
<b>Windows</b> numberformat	<b>Windows</b> Client options file (dsm.opt) or command line.
<b>AIX</b> <b>Linux</b> <b>Solaris</b> <b>Mac OS X</b> numberformat	<b>AIX</b> <b>Linux</b> <b>Solaris</b> <b>Mac OS X</b> Client user options file (dsm.opt) or command line.
pick Note: If you specify the backupsetname parameter with the restore command, you cannot use the pick option.	Command line only.
pitdate	Command line only.
pittime	Command line only.
preservepath	Command line only.
<b>Windows</b> replace	<b>Windows</b> Client options file (dsm.opt) or command line.

Option	Where to use										
<table border="1"> <tr> <td>AIX</td> <td>Linux</td> <td>Solaris</td> </tr> <tr> <td>Mac OS X</td> <td colspan="2">replace</td> </tr> </table>	AIX	Linux	Solaris	Mac OS X	replace		<table border="1"> <tr> <td>AIX</td> <td>Linux</td> <td>Solaris</td> <td>Mac OS X</td> </tr> </table> Client user options file (dsm.opt) or command line.	AIX	Linux	Solaris	Mac OS X
AIX	Linux	Solaris									
Mac OS X	replace										
AIX	Linux	Solaris	Mac OS X								
<table border="1"> <tr> <td>Windows</td> <td>skipntpermissions</td> </tr> </table>	Windows	skipntpermissions	<table border="1"> <tr> <td>Windows</td> <td>Client options file (dsm.opt) or command line.</td> </tr> </table>	Windows	Client options file (dsm.opt) or command line.						
Windows	skipntpermissions										
Windows	Client options file (dsm.opt) or command line.										
<table border="1"> <tr> <td>Windows</td> <td>skipntsecuritycrc</td> </tr> </table>	Windows	skipntsecuritycrc	<table border="1"> <tr> <td>Windows</td> <td>Client options file (dsm.opt) or command line.</td> </tr> </table>	Windows	Client options file (dsm.opt) or command line.						
Windows	skipntsecuritycrc										
Windows	Client options file (dsm.opt) or command line.										
<table border="1"> <tr> <td>Windows</td> <td>subdir</td> </tr> </table>	Windows	subdir	<table border="1"> <tr> <td>Windows</td> <td>Client options file (dsm.opt) or command line.</td> </tr> </table>	Windows	Client options file (dsm.opt) or command line.						
Windows	subdir										
Windows	Client options file (dsm.opt) or command line.										
<table border="1"> <tr> <td>AIX</td> <td>Linux</td> <td>Solaris</td> </tr> <tr> <td>Mac OS X</td> <td colspan="2">subdir</td> </tr> </table>	AIX	Linux	Solaris	Mac OS X	subdir		<table border="1"> <tr> <td>AIX</td> <td>Linux</td> <td>Solaris</td> <td>Mac OS X</td> </tr> </table> Client user options file (dsm.opt) or command line.	AIX	Linux	Solaris	Mac OS X
AIX	Linux	Solaris									
Mac OS X	subdir										
AIX	Linux	Solaris	Mac OS X								
<table border="1"> <tr> <td>Windows</td> <td>tapeprompt</td> </tr> </table>	Windows	tapeprompt	<table border="1"> <tr> <td>Windows</td> <td>Client options file (dsm.opt) or command line.</td> </tr> </table>	Windows	Client options file (dsm.opt) or command line.						
Windows	tapeprompt										
Windows	Client options file (dsm.opt) or command line.										
<table border="1"> <tr> <td>AIX</td> <td>Linux</td> <td>Solaris</td> </tr> <tr> <td>Mac OS X</td> <td colspan="2">tapeprompt</td> </tr> </table>	AIX	Linux	Solaris	Mac OS X	tapeprompt		<table border="1"> <tr> <td>AIX</td> <td>Linux</td> <td>Solaris</td> <td>Mac OS X</td> </tr> </table> Client user options file (dsm.opt) or command line.	AIX	Linux	Solaris	Mac OS X
AIX	Linux	Solaris									
Mac OS X	tapeprompt										
AIX	Linux	Solaris	Mac OS X								
<table border="1"> <tr> <td>Windows</td> <td>timeformat</td> </tr> </table>	Windows	timeformat	<table border="1"> <tr> <td>Windows</td> <td>Client options file (dsm.opt) or command line.</td> </tr> </table>	Windows	Client options file (dsm.opt) or command line.						
Windows	timeformat										
Windows	Client options file (dsm.opt) or command line.										
<table border="1"> <tr> <td>AIX</td> <td>Linux</td> <td>Solaris</td> </tr> <tr> <td>Mac OS X</td> <td colspan="2">timeformat</td> </tr> </table>	AIX	Linux	Solaris	Mac OS X	timeformat		<table border="1"> <tr> <td>AIX</td> <td>Linux</td> <td>Solaris</td> <td>Mac OS X</td> </tr> </table> Client user options file (dsm.opt) or command line.	AIX	Linux	Solaris	Mac OS X
AIX	Linux	Solaris									
Mac OS X	timeformat										
AIX	Linux	Solaris	Mac OS X								
todate	Command line only.										
totime	Command line only.										

## Examples

AIX	Linux	Solaris	Mac OS X
-----	-------	---------	----------

**Task**  

AIX	Linux	Solaris	Mac OS X
-----	-------	---------	----------

 Restore a single file named `budget` in the `/Users/user1/Documents` directory.

```
restore /home/devel/projecta/budget
```

Windows
---------

**Task**  

Windows
---------

 Restore a single file named `budget.fin`.

```
restore c:\devel\projecta\budget.fin
```

AIX	Linux	Solaris	Mac OS X
-----	-------	---------	----------

**Task**  

AIX	Linux	Solaris	Mac OS X
-----	-------	---------	----------

 Restore a single file named `budget`, which exists in the current directory.

```
restore file budget
```

Windows
---------

**Task**  

Windows
---------

 Restore a single file named `budget.fin`, which exists in the current directory.

```
restore file budget.fin
```

Windows
---------

**Task**  

Windows
---------

 Restore files from the `abc` file space `proj` directory.

```
rest {"abc"}\proj\*.*
```

AIX	Linux	Solaris	Mac OS X
-----	-------	---------	----------

**Task**  

AIX	Linux	Solaris	Mac OS X
-----	-------	---------	----------

 Restore all files with a file extension of `.c` from the `/home/devel/projecta` directory.

```
restore "/home/devel/projecta/*.c"
```

Windows
---------

**Task**  

Windows
---------

 Restore all files with a file extension of `.c` from the `c:\devel\projecta` directory.

```
rest c:\devel\projecta\*.c
```

Windows
---------

**Task**  

Windows
---------

 Restore all files with an extension of `.c` from the `\devel\projecta` directory that is located in the `winnt` file space.

```
rest {winnt}\devel\projecta\*.c
```

**Windows Task**

**Windows** Restore all files with a file extension of .c from the c:\devel\projecta directory to the c:\newdevel\projectn\projecta directory. If the projectn or projectn\projecta directory does not exist, it is created.

```
restore c:\devel\projecta\*.c c:\newdevel\projectn\
```

**AIX Linux Solaris Mac OS X Task**

**AIX Linux Solaris Mac OS X** Restore files in the /user/project directory. Use the pick and inactive options to select active and inactive backup versions.

```
restore "/user/project/*" -pick -inactive
```

**Windows Task**

**Windows** Restore files in the c:\project directory. Use the pick and inactive options to select active and inactive backup versions.

```
restore c:\project\* -pi -ina
```

**AIX Linux Solaris Mac OS X Task**

**AIX Linux Solaris Mac OS X** Restore all files from the /home/devel/projecta directory that end with the character .c to the /home/newdevel/projectn/projecta directory. If the projectn or the projectn/projecta directory does not exist, it is created.

```
restore "/home/devel/projecta/*.c" /home/newdevel/projectn/
```

**AIX Linux Solaris Mac OS X Task**

**AIX Linux Solaris Mac OS X** Restore all files in the /home/mydir directory to their state as of 1:00 PM on August 17, 2002.

```
restore -pitt=8/17/2002 -pitt=13:00:00 /home/mydir/
```

**Windows Task**

**Windows** Restore all files in the c:\mydir directory to their state as of 1:00 PM on August 17, 2002.

```
restore -pitt=8/17/2002 -pitt=13:00:00 c:\mydir\
```

**AIX Linux Solaris Mac OS X Task**

**AIX Linux Solaris Mac OS X** Restore all objects in the /home/myid/ directory. Since this restore operation is fully wildcarded, if the restore process is interrupted, a restartable restore session is created.

```
res "/home/myid/*"
```

**Windows Task**

**Windows** Restore a file from the renamed file space \\your-node\h\$\_OLD to its original location. Enter both the source and destination as follows:

```
res \\your-node\h$_OLD\docs\myresume.doc h:\docs\
```

**AIX Linux Solaris Mac OS X Task**

**AIX Linux Solaris Mac OS X** Restore all files in the /home/mydir directory to their state as of 1:00 PM on August 17, 2002.

```
restore -pitt=8/17/2002 -pitt=13:00:00 /home/mydir/
```

**Windows Task**

**Windows** Restore all files in the c:\mydir directory to their state as of 1:00 PM on August 17, 2002.

```
restore -pitt=8/17/2002 -pitt=13:00:00 c:\mydir\
```

**Windows Task**

**Windows** Restore a single file named budget.fin contained within the backup set daily\_backup\_data.12345678.

```
restore c:\projecta\budget.fin -backupsetname=daily_backup_data.12345678 -location=server
```

- Restoring NTFS or ReFS volume mount points

When restoring a file system that contains a volume mount point, only the mount point (directory) is restored. The data on the volume mounted on that directory is not restored.

- **Windows** Restore Microsoft Dfs junctions  
To restore Microsoft Dfs junctions, you must restore Microsoft Dfs root.
- **Windows** Restore active files  
When restoring active and inactive versions of the same file using the replace option, only the most recently restored file is replaced.
- **Windows** Universal Naming Convention restores  
The client stores files on the IBM Spectrum Protect server using the Windows Universal Naming Convention (UNC), not the drive letter. The UNC name is the network name for the file. The system name is a part of the UNC name. For example, if your system name is STAR and you have a file named c:\doc\h2.doc, the UNC name is \\star\c\$\doc\h2.doc.
- **Mac OS X** | **Windows** Restore from file spaces that are not Unicode-enabled  
If you want to restore from file spaces that are not Unicode-enabled, you must specify the source on the server and a destination on the client, prior to installing the Unicode-enabled client.
- **Windows** Restore named streams  
The backup-archive client restores named streams on a file basis only.
- **Windows** Restore sparse files  
When restoring sparse files to a non-NTFS or non-ReFS file system, set the IBM Spectrum Protect server communication time-out value (idletimeout) to the maximum value of 255 to avoid client session timeout.

**Windows**

## Restoring NTFS or ReFS volume mount points

---

When restoring a file system that contains a volume mount point, only the mount point (directory) is restored. The data on the volume mounted on that directory is not restored.

A mount point can also be restored individually. For example, C:\mount is a mount point and has been backed up as part of the C:\ drive on the system named STORMAN. The following command can be used to restore this mount point:

```
dsms restore {\\storman\c$}\mount
```

The braces ({ and }) are required if you also backed up the data on the mounted volume from the mount point. Without the braces, the client restores data from the file space with the longest name that matches the file specification. If you backed up the data through the mount point, the backups are stored in a file space named \\storman\c\$\mount. The braces are used to specify that the data be restored from the \\storman\c\$ file space.

The mount point cannot be restored if any of the following conditions is true:

- The mount point already exists.
- A non-empty directory matching the mount point name exists.
- A file matching the mount point name exists.
- Restoring data on NTFS mounted volumes  
The mount point must exist before the data on the mounted volume can be restored to its original location.

### Related concepts:

Restoring data on NTFS mounted volumes

Backing up NTFS or ReFS volume mount points

Backing up data on NTFS or ReFS mounted volumes

**Windows**

## Restore Microsoft Dfs junctions

---

To restore Microsoft Dfs junctions, you must restore Microsoft Dfs root.

If you select the junction point itself, the backup-archive client restores data under junction, but not the junction itself. If you select a junction point that no longer exists under Dfs root, the client creates a local directory under Dfs root with the same name as the junction before restoring data.

**Windows**

## Restore active files

---

When restoring active and inactive versions of the same file using the replace option, only the most recently restored file is replaced.



## Universal Naming Convention restores

The client stores files on the IBM Spectrum Protect™ server using the Windows Universal Naming Convention (UNC), not the drive letter. The UNC name is the network name for the file. The system name is a part of the UNC name. For example, if your system name is STAR and you have a file named c:\doc\h2.doc, the UNC name is \\star\c\$\doc\h2.doc.

When you restore files on the same system from which they were backed up, you can use the local drive letter or the UNC name to refer to the file. For example, either of the following will restore c:\doc\h2.doc to its original location:

```
dsmc restore c:\doc\h2.doc
dsmc restore \\star\c$\doc\h2.doc
```

When you restore files on a system with a different name, then you must use the UNC name to refer to the file. This is true even if you are restoring to the same physical system, but the system name has changed since the backup occurred.

For example, if you back up c:\doc\h2.doc on system STAR and you want to restore it to system METEOR then you must use the UNC name to refer to the file. You must also specify a destination restore location. This is because the default behavior is to restore the file to its original location, which would be on system STAR. To restore the file to system METEOR, you can run either of the following on METEOR:

```
dsmc restore \\star\c$\doc\h2.doc c:\
dsmc restore \\star\c$\doc\h2.doc \\meteor\c$\
```

## Restore from file spaces that are not Unicode-enabled

If you want to restore from file spaces that are not Unicode-enabled, you must specify the source on the server and a destination on the client, prior to installing the Unicode-enabled client.

**Mac OS X** Note: This Unicode section applies only to Mac OS X.

**Windows** If you want to restore from file spaces that are not Unicode-enabled, you must specify the source on the server and a destination on the client. For example, you backed up your H disk named \\your-node\h\$ prior to installing the Unicode-enabled client. After the installation, you issue the following command for a selective backup:

**Windows**

```
sel h:\logs\*.log
```

**Mac OS X** For example, assume that Jaguar is the name of your startup disk and you back up all of the .log files in the /Users/user5/Documents directory. Before the backup takes place, the server renames the file space to Jaguar\_OLD. The backup places the data specified in the current operation into the Unicode-enabled file space named /. The new Unicode-enabled file space now contains only the /Users/user5/Documents directory and the \*.log files specified in the operation.

**Mac OS X** If you want to restore a file from the *renamed* (old) file space to its original location, you must enter both the source and destination as follows:

```
restore Jaguar_OLD/Users/user5/Documents
/mylog.log /Users/user5/Documents/
```

**Windows** Before the backup takes place, the server renames the file space to \\your-node\h\$\_OLD. The backup continues placing the data specified in the current operation into the Unicode-enabled file space named \\your-node\h\$. That file space now contains only the \logs directory and the \*.log files. If you want to restore a file from the (old) *renamed* file space to its original location, you must enter both the source and destination as follows:

```
restore \\your-node\h$_OLD\docs\myresume.doc h:\docs\
```

**Windows**

## Restore named streams

The backup-archive client restores named streams on a file basis only.

Windows directories can contain named streams. Named streams attached to a directory will always be overwritten (regardless of the value of the prompt option) during a restore operation.

Windows

## Restore sparse files

When restoring sparse files to a non-NTFS or non-ReFS file system, set the IBM Spectrum Protect™ server communication timeout value (idletimeout) to the maximum value of 255 to avoid client session timeout.

The backup-archive client is restricted to restoring sparse files that are less than 4 gigabytes in size.

The following issues apply if more data is restored than the Microsoft disk quota allows:

- If the user who performs the restore has a disk quota (for example, the user belongs to the Backup Operator Group), the client does not restore any data that exceeds the disk quota of the restore user and displays a "Disk Full" message.
- If the user who performs the restore does not have a disk quota (for example, the user belongs to the Administrator Group), the client does restore all data and transfers ownership of the files that exceed the disk quota of the original owner to the user who is performing the restore (in this case, the Administrator).

Windows

## Restore Adobjects

Use the restore adobjects command to restore individual Active Directory objects from the local Deleted Objects container.

Backup-archive clients that run on Windows Server platforms can restore individual Active Directory objects from full system-state backups stored on the IBM Spectrum Protect™ server.

## Supported Clients

This command is valid for Windows Server OS clients.

## Syntax

```
>>-Restore ADOBJects--+-+-----+-----+-----<<  
                        '-sourcepathspec-' '-options-'
```

## Parameters

sourcepathspec

Specifies the Active Directory object or container to restore. If a container is specified, its contents are also restored. You can either specify the full distinguished name of an object or a container, or just the name attribute ('cn' or 'ou'), where the wildcard might be used. The following special characters require an escape character, the backslash, (\), if any of them are contained in the name:

- \
- #
- +
- =
- <
- >

For example, "cn=test#" is entered as "cn=test\#".

The client cannot display any object names that contain an asterisk (\*) as part of the name.

Do not use wildcards when you specify a distinguished name.

Table 1. Restore Adobjects command: Related options

Option	Where to use
--------	--------------

Option	Where to use
adlocation	Command line only.
dateformat (the option is ignored when adlocation is not specified)	Client options file (dsm.opt) or command line.
pitdate (the option is ignored when adlocation is not specified)	Command line only.
pittime (the option is ignored when adlocation is not specified)	Command line only.
replace	Client options file (dsm.opt) or command line.
timeformat (the option is ignored when adlocation is not specified)	Client options file (dsm.opt) or command line.

## Examples

### Task

Restore a specific deleted Active Directory object.

**Command:** `restore adobj "CN=Administrator,CN=Users,DC=bryan,DC=test,DC=ibm,DC=com"`

### Task

Restore all deleted objects that were originally located in the Users container.

**Command:** `restore adobj "CN=Users,DC=bryan,DC=test,DC=ibm,DC=com"`

### Task

Restore individual Active Directory objects from the IBM Spectrum Protect server. Use the pitdate and pittime options to select from a list of more recent and less recent backup versions.

**Command:** `restore adobj "cn=guest" -adloc=server -pitdate=03/17/2008 -pittime=11:11:11`

### Task

Restore all deleted users with the name starting with Fred.

**Command:** `restore adobjects "cn=Fred*"`

### Task

Restore all deleted organizational units with the name testou.

**Command:** `restore adobjects "ou=testou"`

## Restore Backupset

The restore backupset command restores a backup set from the IBM Spectrum Protect™ server, a local file, or a local tape device. You can restore the entire backup set, or, in some cases, specific files within the backup set.

AIX | Linux | Mac OS X | Solaris | Windows

## Supported Clients

This command is valid for all clients.

## Syntax

```
>>-REStore Backupset-----+----->
      '+-----+--sourcefilespec-'
      '-{filespaceName}-'

>--+-----+--+-----+-- -BACKUPSETName= ----->
      '-destinationfilespec-' '-options-'

>--+--backupsetName+--+-----+-----<
```

```

+-localfilename+  '- -LOcAtion= ---server--+'
'-tapedevice----'          +-file----+
                              '-tape----'

```

## Parameters

### {filespaceName}

Specifies the file space (enclosed in braces) on the server that contains the files you want to restore. This is the name on the workstation drive from which the files were backed up, or the virtual file space name for a group.

Specify a file space name when you restore a backup set containing a group.

Specify a file space name when the *sourcefilespec* does not exist on the target computer. This can occur if the drive label name has changed or if you are restoring files that were backed up from another node that had drive labels that are different from yours.

**Windows** Note: You must specify a mixed or lowercase NTFS or ReFS file space name that is enclosed in quotation marks and braces. For example, {"NTFSDrive"}. Single quotation marks are valid in loop mode. For example: {"NTFSDrive"} and {NTFSDrive} are both valid. In batch mode, only single quotation marks are valid. The single quotation marks requirement is a restriction of the operating system.

### sourcefilespec

Specifies the source path of a portion of the backup set. The default is to restore the entire backup set.

### destinationfilespec

Specifies the destination path for the restored files. If you do not specify a *sourcefilespec*, you cannot specify a *destinationfilespec*. If you do not specify a destination, the backup-archive client restores the files to the original source path. If you are restoring more than one file, you must end the file specification with a directory delimiter (/), otherwise, the client assumes that the last name is a file name and reports an error. If you are restoring a single file, you can optionally end the destination file specification with a file name if you want to give the restored file a new name. When the *sourcefilespec* does not exist on the target workstation, you must specify *destinationfilespec*.

### -BACKUPSETName=

Specifies the name of the backup set from which to perform a restore operation. You cannot use wildcard characters to specify the backup set name. The value of *backupsetname* depends on the location of the backup set, and corresponds to one of the following three choices:

#### *backupsetname*

Specifies the name of the backup set on the server from which to perform a restore operation. If location option is specified, you must set `-location=server`.

#### *localfilename*

Specifies the file name of the first backup set volume. You must set `-location=file`.

#### *tapedevice*

Specifies the name of the tape device containing the backup set volume. You must use a Windows-provided device driver, not the device driver that is provided by IBM. You must set `-location=tape`.

### -LOcAtion=

Specifies the location of the backup set. If you do not specify the location parameter, the client searches for backup sets on the IBM Spectrum Protect server. If you specify the location parameter, the value must be one of the following three choices:

#### server

Specifies that the backup set is on the IBM Spectrum Protect server. Server is the default location.

#### file

Specifies that the backup set is on an available file system.

#### tape

Specifies that the backup set is on an available tape device.

Table 1. Restore Backupset command: Related options

Option	Where to use
dirsonly	Command line only.
filesonly	Command line only.
ifnewer	Command line only.

Option	Where to use
preservepath	Command line only.
<b>Windows</b> quiet	<b>Windows</b> Client options file (dsm.opt) or command line.
<b>AIX</b> <b>Linux</b> <b>Solaris</b> <b>Mac OS X</b> quiet	<b>AIX</b> <b>Linux</b> <b>Solaris</b> <b>Mac OS X</b> Client user options file (dsm.opt) or command line.
<b>Windows</b> replace	<b>Windows</b> Client options file (dsm.opt) or command line.
<b>AIX</b> <b>Linux</b> <b>Solaris</b> <b>Mac OS X</b> replace	<b>AIX</b> <b>Linux</b> <b>Solaris</b> <b>Mac OS X</b> Client user options file (dsm.opt) or command line.
<b>Windows</b> skipntppermissions	<b>Windows</b> Client options file (dsm.opt) or command line.
<b>Windows</b> subdir	<b>Windows</b> Client options file (dsm.opt) or command line.
<b>AIX</b> <b>Linux</b> <b>Solaris</b> <b>Mac OS X</b> subdir	<b>AIX</b> <b>Linux</b> <b>Solaris</b> <b>Mac OS X</b> Client user options file (dsm.opt) or command line.

## Examples

### Task

Restore the entire backup set called monthly\_financial\_data.87654321 from the server.

```
dsmc restore backupset
-backupsetname=monthly_financial_data.87654321
-loc=server
```

**AIX** **Linux** **Solaris** **Mac OS X** Task

**AIX** **Linux** **Solaris** **Mac OS X** Restore the entire backup set contained in the file:  
/home/budget/weekly\_budget\_data.ost.

```
dsmc restore backupset
-backupsetname="/home/budget/weekly_budget_data.ost"
-loc=file
```

**AIX** **Linux** **Solaris** **Mac OS X** Task

**AIX** **Linux** **Solaris** **Mac OS X** Restore the entire backup set from the /dev/rmt0 device.

```
dsmc restore backupset
"-backupsetname=/dev/rmt0" -loc=tape
```

**AIX** **Linux** **Solaris** **Mac OS X** Task

**AIX** **Linux** **Solaris** **Mac OS X** Restore a single file named /home/jones/budget.dev from the /dev/rmt0 tape device, to the original source path.

```
dsmc restore backupset
-backupsetname=/dev/rmt0 "/home/jones/budget.dev"
-loc=tape
```

**AIX** **Linux** **Solaris** **Mac OS X** Task

**AIX** **Linux** **Solaris** **Mac OS X** Restore all files in the budget directory that contain a file extension of .txt from the tapes on the /dev/rmt0 device, to the original source path.

```
dsmc restore backupset "/home/budget/*.txt"
-backupsetname=/dev/rmt0 -loc=tape
```

**AIX** **Linux** **Solaris** **Mac OS X** Task

**AIX** **Linux** **Solaris** **Mac OS X** Restore the entire backup set contained in local file named  
"/home/jones/bset01.file"

```
dsmc restore backupset
-backupsetname="/home/jones/bset01.file"
-loc=file
```

**AIX** **Linux** **Solaris** **Mac OS X** Task

**AIX** **Linux** **Solaris** **Mac OS X** Restore groups from the backup set mybackupset.12345678 on the IBM Spectrum Protect server to the /home/devel/projectb directory. The groups' virtual file space is accounting.

```
dsmc restore backupset {/accounting}/*
/home/devel/projectb/
-backupsetname=mybackupset.12345678 -loc=server
-subdir=yes
```

**AIX** | **Linux** | **Solaris** | **Mac OS X** | **Task**

**AIX** | **Linux** | **Solaris** | **Mac OS X** Restore groups from the local backup set mybackupset.ost to the /home/devel/projectb/ directory. The groups' virtual file space is accounting.

```
dsmc restore backupset {/accounting}/*
/home/devel/projectb/
-backupsetname=mybackupset.ost
-loc=server -subdir=yes
```

**Windows** | **Task**

**Windows** Restore the entire backup set from the \\.\tape0 device.

```
dsmc restore backupset
-backupsetname=\\.\tape0 -loc=tape
```

**Windows** | **Task**

**Windows** Restore groups from the backup set mybackupset.12345678 on the IBM Spectrum Protect server to the c:\newdevel\projectn directory. The groups' virtual file space is accounting.

```
dsmc restore backupset {accounting}\*
c:\newdevel\projectn\
-backupsetname=mybackupset.12345678
-loc=server -subdir=yes
```

**Windows** | **Task**

**Windows** Restore the entire backup set contained in the file: c:\budget\weekly\_budget\_data.ost.

```
dsmc restore backupset
-backupsetname=c:\budget\weekly_budget_data.ost
-loc=file
```

**Windows** | **Task**

**Windows** Restore the \budget\ directory and subdirectories from the backup set contained in the file: c:\budget\weekly\_budget\_data.ost.

```
dsmc restore backupset m:\budget\*
-backupsetname=c:\budget\weekly_budget_data.ost
-loc=file -subdir=yes
```

**Windows** | **Task**

**Windows** Restore the file \budget\salary.xls from the backup set contained in the file: c:\budget\weekly\_budget\_data.ost.

```
dsmc restore backupset m:\budget\salary.xls
-backupsetname=c:\budget\weekly_budget_data.ost
-loc=file -subdir=yes
```

- Restore backup sets: considerations and restrictions  
This topic lists some considerations and restrictions that you must be aware of when restoring backup sets.
- **AIX** | **Linux** | **Solaris** | **Mac OS X** | **Windows** Restore backup sets in a SAN environment  
You can restore backup sets in a storage area network (SAN) in the following ways:
- Restore Backupset without the backupsetname parameter  
The restore backupset command can be used without the backupsetname parameter.

## Restore backup sets: considerations and restrictions

This topic lists some considerations and restrictions that you must be aware of when restoring backup sets.

### Backup set restore considerations

Consider the following when restoring backup sets:

- If the object you want to restore was generated from a client node whose name is different from your current node, specify the original node name with the filespace name parameter on any of the restore commands.

- If you are unable to restore a backup set from portable media, check with your IBM Spectrum Protect™ administrator to ensure that the portable media was created on a device using a compatible format.
- If you use the restore backupset command on the initial command line with the parameter `-location=tape` or `-location=file`, the client does not attempt to contact the IBM Spectrum Protect server.
- When restoring a group from a backup set:
  - The entire group, or all groups, in the virtual file space are restored. You cannot restore a single group by specifying the group name, if there are several groups in the same virtual file space. You cannot restore a part of a group by specifying a file path.
  - Specify a group by using the following values:
    - Specify the virtual file space name with the `filespace` parameter.
    - Use the `subdir` option to include subdirectories.
- Limited support is provided for restoring backup sets from tape devices attached to the client system. A native device driver provided by the device manufacturer must always be used. The device driver provided by IBM to be used with the IBM Spectrum Protect server cannot be used on the client system for restoring local backup sets.
- |          |     |       |         |
|----------|-----|-------|---------|
| Mac OS X | AIX | Linux | Solaris |
|----------|-----|-------|---------|

 If a backup set contains files from several owners, the backup set itself is owned by the root user ID, and non-root user IDs cannot see the backup set. In this case, non-root user IDs can restore their files by obtaining the backup set name from the IBM Spectrum Protect administrator. Non-root users can restore only their own files.
- |          |     |       |         |         |
|----------|-----|-------|---------|---------|
| Mac OS X | AIX | Linux | Solaris | Windows |
|----------|-----|-------|---------|---------|

 To enable the client GUI to restore a backup set from a local device, without requiring a server connection, use the `localbackupset` option.

## Backup set restore restrictions

Be aware of the following restrictions when restoring backup sets:

- A backup set data that was backed up with the API cannot be restored or used.
- |     |       |         |         |
|-----|-------|---------|---------|
| AIX | Linux | Solaris | Windows |
|-----|-------|---------|---------|

 You cannot restore image data from a backup set using the `restore backupset` command. You can restore image data from a backup set only with the `restore image` command.
- |     |       |         |         |
|-----|-------|---------|---------|
| AIX | Linux | Solaris | Windows |
|-----|-------|---------|---------|

 You cannot restore image data from a local backup set (`location=tape` or `location=file`). You can restore image data from a backup set only from the IBM Spectrum Protect server.

AIX	Linux	Solaris	Mac OS X	Windows
-----	-------	---------	----------	---------

## Restore backup sets in a SAN environment

You can restore backup sets in a storage area network (SAN) in the following ways:

- If the backup set is on a SAN-attached storage device, specify the device using the `filename` parameter and use the `location=tape` option, where applicable. The backup-archive client restores the backup set directly from the SAN-attached storage device, gaining high-speed restore performance.
 

AIX	Linux	Solaris
-----	-------	---------

 Note: You must ensure that the correct tape is mounted in the SAN-attached tape drive prior to issuing the restore command. The backup-archive client will not initiate a SCSI autochanger to mount the tape automatically.
- If the backup set is not on local media or a SAN-attached storage device, you can specify the backup set using the `backupsetname` option. Use the `location=server` option to restore the backup set directly from the server using the LAN.

## Restore Backupset without the backupsetname parameter

The `restore backupset` command can be used without the `backupsetname` parameter.

The preferred syntax for `restore backupset` command requires the `backupsetname` parameter. Before the introduction of the `backupsetname` parameter, the backup-archive client restored backup sets with a different syntax. The previous syntax is supported, but whenever possible, follow the syntax that requires the `backupsetname` parameter. The previous syntax is documented for those cases when it cannot be replaced by the preferred syntax.

AIX	Linux	Solaris	Mac OS X	Windows
-----	-------	---------	----------	---------

## Supported Clients

This command is valid for all clients.

## Syntax

---

```
>>-REStore Backupset--+-----+----->
      '+-----+--sourcefilespec-'
      '-{filespace}-'

>--+-----+-----+-----+-----+----->
  '-destinationfilespec-' '-options-' '+localfilename+'
                                   '-tapedevice----'

>--+-----+-----+-----><
  '-LOCation=--+server+-'
                +-file---+
                '-tape---'
```

## Parameters

---

### options

All options that are valid with the preferred syntax of restore backupset are valid with the previous syntax of restore backupset.

### {filespace}

Specifies the file space (enclosed in braces) on the server that contains the files you want to restore. This is the name on the workstation drive from which the files were backed up, or the virtual file space name for a group.

Specify a file space name when you restore a backup set containing a group.

Specify a file space name when the *sourcefilespec* does not exist on the target computer. This can occur if the drive label name has changed or if you are restoring files that were backed up from another node that had drive labels that are different from yours.

**Windows** Note: You must specify a mixed or lowercase NTFS or ReFS file space name that is enclosed in quotation marks and braces. For example, {"NTFSDrive"}. Single quotation marks are valid in loop mode. For example: {"NTFSDrive"} and {'NTFSDrive'} are both valid. In batch mode, only single quotation marks are valid. The single quotation marks requirement is a restriction of the operating system.

### sourcefilespec

Specifies the source path of a portion of the backup set. The default is to restore the entire backup set.

### destinationfilespec

Specifies the destination path for the restored files. If you do not specify a *sourcefilespec*, you cannot specify a *destinationfilespec*. If you do not specify a destination, the client restores the files to the original source path. If you are restoring more than one file, you must end the file specification with a directory delimiter (/), otherwise, the client assumes that the last name is a file name and reports an error. If you are restoring a single file, you can optionally end the destination file specification with a file name if you want to give the restored file a new name. When the *sourcefilespec* does not exist on the target workstation, you must specify the *destinationfilespec*.

### backupsetname

Specifies the name of the backup set from the IBM Spectrum Protect™ server. If the location parameter is specified, you must set `-location=server`.

### localfilename

Specifies the file name of the first backup set volume. You must set `-location=file`.

### tapedevice

Specifies the name of the tape device containing the backup set volume. You must use a Windows-provided device driver, not the device driver that is provided by IBM. You must set `-location=tape`.

### LOCation=

Specifies the location of the backup set. If you do not specify the location parameter, the client searches for backup sets on the IBM Spectrum Protect server. If you specify the location parameter, the value must be one of the following three choices:

#### server

Specifies that the backup set is on the server. Server is the default location.

#### file

Specifies that the backup set is on an available file system.

#### tape



Specifies that the backup set is on an available tape device.

## Examples

### Task

Restore the entire backup set called `monthly_financial_data.87654321` from the server.

```
dsmc restore backupset monthly_financial_data.87654321 -loc=server
```

**AIX** | **Linux** | **Solaris** | **Mac OS X** | **Task**

**AIX** | **Linux** | **Solaris** | **Mac OS X** | Restore the entire backup set contained in the file:  
`/home/budget/weekly_budget_data.ost`.

```
dsmc restore backupset "/home/budget/weekly_budget_data.ost" -loc=file
```

**AIX** | **Linux** | **Solaris** | **Mac OS X** | **Task**

**AIX** | **Linux** | **Solaris** | **Mac OS X** | Restore the entire backup set from the `/dev/rmt0` device.

```
dsmc restore backupset "/dev/rmt0" -loc=tape
```

**AIX** | **Linux** | **Solaris** | **Mac OS X** | **Task**

**AIX** | **Linux** | **Solaris** | **Mac OS X** | Restore a single file named `/home/jones/budget.dev` from the `/dev/rmt0` tape device, to the original source path.

```
dsmc restore backupset /dev/rmt0 "/home/jones/budget.dev" -loc=tape
```

**AIX** | **Linux** | **Solaris** | **Mac OS X** | **Task**

**AIX** | **Linux** | **Solaris** | **Mac OS X** | Restore all files in the budget directory that contain a file extension of `.txt` from the tape(s) on the `/dev/rmt0` device, to the original source path.

```
dsmc restore backupset /dev/rmt0 "/home/budget/*.txt" -loc=tape
```

**AIX** | **Linux** | **Solaris** | **Mac OS X** | **Task**

**AIX** | **Linux** | **Solaris** | **Mac OS X** | Restore the entire backup set contained in local file  
`"/home/jones/bset01.file"`

```
dsmc restore backupset "/home/jones/bset01.file" -loc=file
```

**AIX** | **Linux** | **Solaris** | **Mac OS X** | **Task**

**AIX** | **Linux** | **Solaris** | **Mac OS X** | Restore groups from the backup set `mybackupset.12345678` on the IBM Spectrum Protect server to the `/home/devel/projectb` directory. The groups' virtual file space is `accounting`.

```
dsmc restore backupset mybackupset.12345678 {/accounting}/* /home/devel/projectb/ -loc=server -subdir=yes
```

**AIX** | **Linux** | **Solaris** | **Mac OS X** | **Task**

**AIX** | **Linux** | **Solaris** | **Mac OS X** | Restore groups from the local backup set `mybackupset.ost` to the `/home/devel/projectb/` directory. The groups' virtual file space is `accounting`.

```
dsmc restore backupset mybackupset.ost {/accounting}/* /home/devel/projectb/ -loc=server -subdir=yes
```

**Windows** | **Task**

**Windows** | Restore the entire backup set from the `\\.\tape0` device.

```
dsmc restore backupset \\.\tape0 -loc=tape
```

**Windows** | **Task**

**Windows** | Restore groups from the backup set `mybackupset.12345678` on the IBM Spectrum Protect server to the `c:\newdevel\projectn` directory. The groups' virtual file space is `accounting`.

```
dsmc restore backupset mybackupset.12345678 {accounting}\* c:\newdevel\projectn\ -loc=server -subdir=yes
```

**Windows** | **Task**

**Windows** | Restore the entire backup set contained in the file: `c:\budget\weekly_budget_data.ost`.

```
dsmc restore backupset c:\budget\weekly_budget_data.ost -loc=file
```

**Windows** | **Task**

**Windows** Restore the \budget\ directory and subdirectories from the backup set contained in the file:  
c:\budget\weekly\_budget\_data.ost.

```
dsmc restore backupset c:\budget\weekly_budget_data.ost m:\budget\* -loc=file -subdir=yes
```

**Windows Task**

**Windows** Restore the file \budget\salary.xls from the backup set contained in the file:  
c:\budget\weekly\_budget\_data.ost.

```
dsmc restore backupset c:\budget\weekly_budget_data.ost m:\budget\salary.xls -loc=file -subdir=yes
```

## Restore Group

Use the restore group command to restore specific members or all members of a group backup.

Note:

1. Use the pick option to display a list of groups from which you can select one group to restore.
2. Use the showmembers option with the pick option to display and restore one or more members of a group. In this case, you first select the group from which you want to restore specific members, then you select one or more group members to restore.
3. You can restore a group from a backup set.

**AIX** | **Linux** | **Solaris** | **Windows**

## Supported Clients

**Mac OS X** | **AIX** | **Linux** | **Solaris** This command is valid for all clients, except Mac OS X.

**Windows** This command is valid for all clients.

## Syntax

```
>>-REStore GRoup-+-----+---source-----+-----+-----><
                    '-options-'                '-destination-'
```

## Parameters

**Mac OS X** | **AIX** | **Linux** | **Solaris** **source**

**Mac OS X** | **AIX** | **Linux** | **Solaris** Specifies the virtual file space name and the group name on the server that you want to restore.

**Windows** **source**

**Windows** Specifies the virtual file space name (enclosed in braces) and the group name on the server that you want to restore.

**destination**

Specifies the path where you want to place the group or one or more group members. If you do not specify a destination, the client restores the files to their original location.

Table 1. Restore Group command: Related options

Option	Where to use
backupsetname	Command line only.
<b>AIX</b>   <b>Linux</b>   <b>Solaris</b> followsymbolic	<b>AIX</b>   <b>Linux</b>   <b>Solaris</b> Client options file (dsm.opt) or command line.
fromdate	Command line only.
fromnode	Command line only.
<b>AIX</b>   <b>Linux</b>   <b>Solaris</b>   <b>Mac OS X</b> fromowner	<b>AIX</b>   <b>Linux</b>   <b>Solaris</b>   <b>Mac OS X</b> Command line only.
fromtime	Command line only.

Option	Where to use
ifnewer	Command line only.
inactive	Command line only.
latest	Command line only.
pick	Command line only.
pitdate	Command line only.
pittime	Command line only.
preservepath	Command line only.
<b>Windows</b> replace	<b>Windows</b> Client options file (dsm.opt) or command line.
<b>AIX</b>   <b>Linux</b>   <b>Solaris</b> replace	<b>AIX</b>   <b>Linux</b>   <b>Solaris</b> Client options file (dsm.opt) or command line.
<b>Windows</b> showmembers	<b>Windows</b> Command line only.
<b>AIX</b>   <b>Linux</b>   <b>Solaris</b> showmembers (does not apply to Mac OS X)	<b>AIX</b>   <b>Linux</b>   <b>Solaris</b> Command line only.
<b>Windows</b> skipntpermissions	<b>Windows</b> Client options file (dsm.opt) or command line.
<b>Windows</b> skipntsecuritycrc	<b>Windows</b> Client options file (dsm.opt) or command line.
<b>Windows</b> subdir	<b>Windows</b> Client options file (dsm.opt) or command line.
<b>AIX</b>   <b>Linux</b>   <b>Solaris</b> subdir	<b>AIX</b>   <b>Linux</b>   <b>Solaris</b> Client user options file (dsm.opt) or command line.
<b>Windows</b> tapeprompt	<b>Windows</b> Client options file (dsm.opt) or command line.
<b>AIX</b>   <b>Linux</b>   <b>Solaris</b> tapeprompt	<b>AIX</b>   <b>Linux</b>   <b>Solaris</b> Client user options file (dsm.opt) or command line.
todate	Command line only.
totime	Command line only.

## Examples

**AIX** | **Linux** | **Solaris** **Task**  
**AIX** | **Linux** | **Solaris** Restore all members in the /virtfs/group1 group backup to their original location on the client system.

**Command:**

```
restore group /virtfs/group1
```

**Windows** **Task**  
**Windows** Restore all members in the virtfs\group1 group backup to their original location on the client system.

**Command:**

```
restore group {virtfs}\group1
```

**AIX** | **Linux** | **Solaris** **Task**  
**AIX** | **Linux** | **Solaris** Display all groups within the /virtfs virtual file space. Use the showmembers option to display a list of group members from which you can select one or more to restore.

**Command:**

```
restore group /virtfs/  
* -pick -showmembers
```

**Windows** **Task**  
**Windows** Display all groups within the virtfs virtual file space. Use the showmembers option to display a list of group members from which you can select one or more to restore.

**Command:**

```
restore group {virtfs}\  
* -pick -showmembers
```

AIX Linux Solaris Task

AIX Linux Solaris Display a list of groups within the `/virtfs` virtual file space from which you can select one or more groups to restore.

**Command:**

```
restore group /virtfs/* -pick
```

Windows Task

Windows Display a list of groups within the `virtfs` virtual file space from which you can select one or more groups to restore.

**Command:**

```
restore group {virtfs}\* -pick
```

AIX Linux Solaris Windows

## Restore Image

The restore image command restores a file system or raw volume image that was backed up using the backup image command.

The restore obtains the backup image from the IBM Spectrum Protect™ server, or inside a backup set from the IBM Spectrum Protect server, when the `backupsetname` option is specified. This command can restore an active base image, or a point-in-time base image, with associated incremental updates.

Note:

1. **Windows** The account that runs the backup-archive client must have administrator authority to successfully perform any type of image restore.
2. **AIX Linux Solaris** Using the incremental option with the restore image command to perform a dynamic image backup is not supported.
3. If you use IBM Spectrum Protect HSM for Windows or IBM Spectrum Protect for Space Management, and you restore a file system image backup and plan to run reconciliation, you must restore the files that were backed up after the image backup. Otherwise, migrated files that were created after the image backup expire from the HSM archive storage on the IBM Spectrum Protect server.

You can use the `verifyimage` option with the restore image command to specify that you want to enable detection of bad sectors on the destination target volume. If bad sectors are detected on the target volume, the client issues a warning message on the console and in the error log.

If bad sectors are present on the target volume, you can use the `imagetofile` option with the restore image command to specify that you want to restore the source image to a file. Later, you can use a data copy utility of your choice to transfer the image from the file to a disk volume.

AIX Linux Solaris Considerations:

- The API must be installed to use the restore image command.
- **Solaris** Image restore is not supported for the Sun QFS file system.
- **Linux** Image restore is not supported for GPFS™ file systems on Linux x86\_64, Linux on POWER® and Linux on System z®.
- **Linux** On Linux systems, some file systems such as ext2, ext3, ext4, btrfs, and xfs use a universally unique identifier (UUID) to identify themselves to the operating system. If you create an image backup of such a volume and you restore it to a different location, you might have two volumes with the same UUID. If you use UUID to define your file systems in `/etc/fstab`, be aware that the backup-archive client might be unable to correctly mount the restored file system because the UUIDs conflict. To avoid this situation, restore the image to its original location. If you must restore it to a different location, change the UUID of either the original or restored volume before you mount the restored file system. Refer to the Linux documentation for instructions on how to change a UUID. You might also need to manually edit the `/etc/fstab` file so the original volume, the restored volume, or both volumes can be mounted.
- If you use the `pick` option, the following information is displayed for file system images that were backed up by the client:
  - Image Size
  - Stored Size - This value is the actual image size that is stored on the IBM Spectrum Protect server. The stored image on the server is the same size as the volume capacity.
  - File system type
  - Backup date and time
  - Management class that is assigned to image backups

- o Whether the image backup is an active or inactive copy
- o The image name
- If for some reason a restored image is corrupted, you can use the fsck tool to attempt to repair the image.

**Windows** Considerations:

- The IBM Spectrum Protect API must be installed to use the restore image command.
- You can restore an NTFS or ReFS file system to a FAT32 volume or vice versa.
- The destination volume to which you restore must exist and be the same size or larger than the source volume.
- The physical layout of the target volume (striped, mirrored) can differ.
- The target volume is overwritten with data contained in the image backup.
- You do not have to format a target volume before you restore an image backup that contains a file system.
- The client requires an exclusive lock to destination volume you are restoring. The client locks, restores, unlocks, unmounts, and mounts the volume during a restore operation. During the restore process, the destination volume is not available to other applications.
- If you use the pick option, the following information is displayed for file system images that are backed up by the client:
  - o Image Size
  - o Stored Size - This value is the actual image size that is stored on the server. The imagegapsize option can be set so only used blocks in a file system are backed up. So, the stored image size on the server might be smaller than the volume size. For online image backups, the stored image can be larger than the file system based on the size of the cache files.
  - o File system type
  - o Backup date and time
  - o Management class that is assigned to image backup
  - o Whether the image backup is an active or inactive copy
  - o The image name
- If a restored image is corrupted, use the chkdsk utility to check for and repair any bad sectors or data inconsistencies (unless the restored volume is RAW).

## Supported Clients

**AIX** | **Linux** | **Solaris** This option is valid for AIX®, Linux, and Oracle Solaris clients.

**Windows** This command is valid for all Windows clients.

## Syntax

```
>>-REStore Image-+-+-----+--+ --sourcefilespec-+-+----->
                '- --options-' '- --"sourcefilespec"-'
>--+-----+----->>
  '- --destinationfilespec-'
```

## Parameters

### sourcefilespec

Specifies the name of a source image file system to be restored. Only a single source image can be specified; you cannot use wildcard characters.

**AIX** | **Linux** | **Solaris** destinationfilespec

**AIX** | **Linux** | **Solaris** Specifies the name of an existing mounted file system or the path and file name to which the source file system is restored. The default is the original location of the file system.

**Windows** destinationfilespec

**Windows** Specifies the name of an existing mounted file system or the path and file name to which the source file system is restored. The default is the original location of the file system. You can restore an NTFS or ReFS file system to a FAT32 volume or vice versa.

Table 1. Restore Image command: Related options

Option	Where to use
backupsetname	Command line only.

Option	Where to use
<b>AIX</b>   <b>Linux</b>   <b>Solaris</b> dateformat	<b>AIX</b>   <b>Linux</b>   <b>Solaris</b> Client user option file (dsm.opt) or command line.
<b>Windows</b> dateformat	<b>Windows</b> Client option file (dsm.opt) or command line.
deletefiles	Command line only.
fromnode	Command line only.
<b>AIX</b>   <b>Linux</b>   <b>Solaris</b> fromowner	<b>AIX</b>   <b>Linux</b>   <b>Solaris</b> Command line only.
imagetofile	Command line only.
inactive	Command line only.
incremental	Command line only.
noprompt	Command line only.
pick	Command line only.
pitdate	Command line only.
pittime	Command line only.
<b>AIX</b>   <b>Linux</b>   <b>Solaris</b> timeformat	<b>AIX</b>   <b>Linux</b>   <b>Solaris</b> Client user option file (dsm.opt) or command line.
<b>Windows</b> timeformat	<b>Windows</b> Client option file (dsm.opt) or command line.
verifyimage	Command line only.

**AIX** | **Linux** | **Solaris** The restore image command does not define or mount the destination file space. The destination volume must exist, must be large enough to hold the source, and if it contains a file system, must be mounted. If an image backup contains a file system, and you restore them to a different location, be aware of the following points:

**Windows** The restore image command does not define or mount the destination file space. The destination volume must exist, must be large enough to hold the source, and if it contains a file system, must be mounted. The destination volume must be mapped to a drive letter. If an image backup contains a file system, and you restore them to a different location, be aware of the following points:

- If the destination volume is smaller than the source volume, the operation fails.
- **AIX** | **Linux** | **Solaris** If the destination volume is larger than the source, after the restore operation you lose the difference between the sizes. The lost space can be recovered by increasing the size of the volume, which also increases the size of the restored volume.
- **Windows** If the destination volume is larger than the source, after the restore operation you lose the difference between the sizes. If the destination volume is on a dynamic disk, the lost space can be recovered by increasing the size of the volume. Increasing the size of the volume also increases the size of the restored volume.

## Examples

**AIX** | **Linux** | **Solaris** **Task**

**AIX** | **Linux** | **Solaris** Restore the /home/test directory over which the logical volume is mounted, to its original location.

Command: `dsmc rest image /home/test`

**Windows** **Task**

**Windows** Restore the e: drive to its original location.

Command: `dsmc rest image e:`

**AIX** | **Linux** | **Solaris** **Task**

**AIX** | **Linux** | **Solaris** Restore the /home/proj directory over which the logical volume is mounted, to its original location and apply the changes from the last incremental backup of the original image that is recorded on the server. The changes include deletion of files.

Command: `dsmc restore image /home/proj -incremental -deletefiles`

#### Windows Task

**Windows** Restore the h: drive to its original location and apply the changes from the last incremental backup of the original image that is recorded on the server. The changes include deletion of files.

Command: `dsmc restore image h: -incremental -deletefiles`

#### AIX Linux Solaris Task

**AIX Linux Solaris** Restore the /usr file system to its original location. Use the `verifyimage` option to enable detection of bad sectors on the target volume.

Command: `dsmc restore image /usr -verifyimage`

#### Windows Task

**Windows** Restore the d: drive to its original location. Use the `verifyimage` option to enable detection of bad sectors on the target volume.

Command: `dsmc restore image d: -verifyimage`

#### AIX Linux Solaris Task

**AIX Linux Solaris** If bad sectors present on the target volume, use the `imagetofile` option to restore the /usr file system to the /home/usr.img file to avoid data corruption.

Command: `dsmc restore image /usr /home/usr.img -imagetofile`

#### Windows Task

**Windows** If bad sectors present on the target volume, use the `imagetofile` option to restore the d: drive to the e:\diskD.img file to avoid data corruption.

Command: `dsmc restore image d: e:\diskD.img -imagetofile`

#### Windows Task

**Windows** Restore the e: drive from the backup set `weekly_backup_data.12345678` to its original location.

Command: `restore image e: -backupsetname=weekly_backup_data.12345678`

#### AIX Solaris Windows

## Restore NAS

---

The `restore nas` command restores the image of a file system that belongs to a Network Attached Storage (NAS) file server. When you are using an interactive command-line session with a non-administrative ID, you are prompted for an administrator ID.

The NAS file server performs the outboard data movement. A server process performs the restore.

If you used the `toc` option with the `backup nas` command or the `include.fs.nas` option to save Table of Contents (TOC) information for each file system backup, you can use the `QUERY TOC server` command to determine the contents of a file system backup with the `RESTORE NODE server` command to restore individual files or directory trees. You can also use the web client to examine the entire file system tree and select files and directories to restore. If you do not save TOC information, you can still restore individual files or directory trees with the `RESTORE NODE server` command, if you know the fully qualified name of each file or directory and the image in which that object was backed up.

#### AIX Solaris

Use the `nasnodename` option to specify the node name for the NAS file server. The NAS node name identifies the NAS file server to the IBM Spectrum Protect™ server. You must register the NAS node name at the server. Place the `nasnodename` option in your client system-options file (`dsm.sys`). The value in the client system-options file is the default, but this value can be overridden on the command line.

#### Windows

Use the `nasnodename` option to specify the node name for the NAS file server. The NAS node name identifies the NAS file server to the IBM Spectrum Protect server. You must register the NAS node name at the server. Place the `nasnodename` option in your client options file (`dsm.opt`). The value in the client options file is the default, but this value can be overridden on the command line.

You can use the `pick` option to display a list of NAS images that are owned by the NAS node you specify. From this list, you can select one or more images to restore. If you select multiple images to restore with the `pick` option, do not use the `monitor` option or you serialize the restores. To start multiple restore processes simultaneously when you are restoring multiple images, do not specify `monitor=yes`.

Use the monitor option to specify whether you want to monitor a NAS file system image restore and display processing information on your screen.

Use the monitor process command to display a list of current restore processes for all NAS nodes for which your administrative user ID has authority. The administrative user ID should have at least client owner authority over both the NAS node and the client workstation node they are using either from command line or from the web.

Use the cancel process command to stop NAS restore processing.

**AIX** **Solaris** Regardless of client platform, NAS file system specifications use the forward slash (/) separator, as in this example: /vol/vol0.

**Windows** A NAS file system specification uses the following conventions:

- Regardless of client platform, NAS file system specifications use the forward slash (/) separator, as in this example: /vol/vol0.
- NAS file system designations on the command line require brace delimiters {} around the file system names, such as: {/vol/vol0}.

**AIX** **Solaris** **Windows**

## Supported Clients

**AIX** **Solaris** This command is valid for AIX®, and Solaris clients only.

**Windows** This command is valid for all Windows clients.

## Syntax

```
>>-REStore NAS--+-+-----+----- --sourcefilespec----->
                '- --options-'
>--+-----+-----<<
    '- --destinationfilespec-'
```

## Parameters

sourcefilespec

Specifies the name of the NAS file system image you want to restore. This parameter is required unless you use the pick option to display a list of NAS images from which to choose. You cannot use wildcard characters when you specify the sourcefilespec.

destinationfilespec

Specifies the name of an existing mounted file system on the NAS device over which you want to restore the image. This parameter is optional. The default is the original location of the file system on the NAS device.

Table 1. Restore NAS command: Related options

Option	Where to use
<b>AIX</b> <b>Solaris</b> dateformat	<b>AIX</b> <b>Solaris</b> Client user option file (dsm.opt) or command line.
<b>Windows</b> dateformat	<b>Windows</b> Client option file (dsm.opt) or command line.
inactive	Command line only.
mode	Command line only.
monitor	Command line only.
<b>AIX</b> <b>Solaris</b> nasnodename	<b>AIX</b> <b>Solaris</b> Client system options file (dsm.sys) or command line.
<b>Windows</b> nasnodename	<b>Windows</b> Client options file (dsm.opt) or command line.
<b>AIX</b> <b>Solaris</b> numberformat	<b>AIX</b> <b>Solaris</b> Client user option file (dsm.opt) or command line.
<b>Windows</b> numberformat	<b>Windows</b> Client option file (dsm.opt) or command line.
pick	Command line only.



Option	Where to use
pitdate	Command line only.
pittime	Command line only.
<b>AIX</b>   <b>Solaris</b> timeformat	<b>AIX</b>   <b>Solaris</b> Client user option file (dsm.opt) or command line.
<b>Windows</b> timeformat	<b>Windows</b> Client option file (dsm.opt) or command line.

## Examples

### **AIX** | **Solaris** Task

**AIX** | **Solaris** Restore the NAS file system image /vol/vol1 to the /vol/vol2 file system on the NAS file server called nas1.

**Command:** `restore nas -nasnodename=nas1 /vol/vol1 /vol/vol2`

### **Windows** Task

**Windows** Restore the NAS file system image /vol/vol1 to the /vol/vol2 file system on the NAS file server called nas1.

**Command:** `restore nas -nasnodename=nas1 {/vol/vol1} {/vol/vol2}`

### Task

Restore inactive NAS images.

**Command:** `restore nas -nasnodename=nas2 -pick -inactive`

### **Windows**

## Restore Systemstate

The restore systemstate command is deprecated for online system state restore operations.

### Restriction:

You can no longer restore the system state on a system that is still online. Instead, use the ASR-based recovery method to restore the system state in offline Windows PE mode. For more information, see the following IBM Spectrum Protect wiki articles:

- Best Practices for Recovering Windows Server 2012 and Windows 8
- Best Practices for Recovering Windows Server 2012 R2 and Windows 8.1

If you try to restore the system state with the dsmc restore systemstate command, from the backup-archive client GUI, or from the web client, the following message is displayed:

```
ANS5189E Online SystemState restore has been deprecated. Please use offline
WinPE method for performing system state restore.
```

### **Linux** | **Windows**

## Restore VM

Use the restore vm command to restore a virtual machine that was previously backed up.

### **Windows**

The restore VM command can be used to restore both Microsoft Hyper-V virtual machines and VMware virtual machines. The information for each type of restore is presented in its own heading. If you are restoring a virtual machine that is part of a Hyper-V setup, you can skip over the *Restore VM for VMware virtual machines* text. If you are restoring a VMware virtual machine, you do not need to read the *Restore VM for Hyper-V virtual machines* text.

 This feature is available only if the client operates as a data mover for IBM Spectrum Protect™ for Virtual Environments.

### **Linux** | **Windows**

## Restore VM for VMware virtual machines

The Restore VM command can be used to restore VMware virtual machines or VMware virtual machine templates.

If you have the backup-archive client installed on a separate system that is configured as a vStorage backup server, you can restore full virtual machine backups to the ESX or ESXi server that they came from, or to a different server. To restore a full virtual machine backup to a different server, use the `-host` option. The backup-archive client copies the data from the IBM Spectrum Protect server over either the LAN or SAN. The client then writes the data directly to the ESX server, by using the transport method that is specified in the client options file.

Restoring a full virtual machine backup creates a new virtual machine; the configuration information and content of the new machine is identical to what it was when the backup occurred. All virtual machine disks are restored to the specified point-in-time, as virtual disks in the newly created virtual machine.

When you restore a specific disk, by using the `:vmdk=` syntax, an existing virtual machine is updated with the specified virtual disk data. Only the specified disks are restored to the existing virtual machine; other disks in the virtual machine are not altered. The existing virtual machine that you are restoring the disk to must be powered off before you initiate the restore operation.

To create a new virtual machine, specify the `-vmname` parameter and provide a name for the new virtual machine. The `-vmname` parameter creates a new virtual machine with a configuration that is identical to what it was when the backup occurred. If you also specify the `:vmdk=` syntax, data is restored to any disks that are included in the `:vmdk=` parameters; disks that are not included are restored, but only as unformatted disks that do not contain data.

Virtual machines are restored to their original resource pool, cluster, or folder if the containers exist. During a restore operation, if the destination target (a vCenter or ESXi host) does not have the required containers, the virtual machine is restored to the top-level default location on the target ESXi host. If you use the command-line client to restore a virtual machine, and if the virtual machine cannot be restored to its original inventory location, an informational message (ANS20911) is displayed. If you use the Java™ GUI to restore a virtual machine, and if the virtual machine cannot be restored to its original inventory location, the informational message is not displayed, but the virtual machine is still restored to the top-level default location.

Data protection tags that were backed up with the `run backup vm` command are restored with the virtual machine. Data protection tags are used to exclude virtual machines from backups and to specify the retention policy of backups.

**Windows** Full virtual machine backups that were previously created by using VMware Consolidated Backup (VCB) can still be restored by using the original VCB restore steps. To restore full virtual machine backups that were created by VCB, see Restoring full VM backups that were created with VMware Consolidated Backup. If you use VCB to restore a virtual machine, use the VMware converter program on the client to move the restored files to a running state on a VMware server. If the backup-archive client is running in a virtual machine, and if you performed a file-level backup of the virtual machine's files with the version 7.1 or earlier client, you can restore the backup versions to the virtual machine by using the command-line interface or the Java GUI.

## Supported Clients

**Linux** This command is valid on supported Linux clients that are installed on a vStorage backup server for a VMware virtual machine.

**Windows** This command is valid on supported Windows clients that are installed on a vStorage backup server for a VMware virtual machine.

## Syntax

```

.-----
V .-:vmdk=all-vmdk----. |
>>-REStore VM--sourcevmspec-----+----->
      +-:vmdk=cnfg-----+
      +-:vmdk=disk label--+
      '-:-vmdk=disk label-'

>--+-----+----->
+- -- -VMName="newVMname" [* <timestamp>]-+
+- --DATACENTER="myDatacenter"-----+
+- --HOST="myHost"-----+
'- --DATASTORE="myDatastore"-----'

>--+-----+----->>
'- --options-' '-destinationfilespec-'

```

## Parameters

Any parameter that contains spaces must be enclosed in quotation marks (" ").

#### *sourcevmspec*

Specifies the name of the virtual machine (or virtual machine template) that you want to restore.

#### VMName \*timestamp

Specifies the new name for the virtual machine after it is restored, if you do not want to use the name specified by *sourcevmspec*.

You can use the \* (asterisk) symbol as a wildcard to represent the name of the virtual machine that is restored. Placing valid characters before or after the asterisk can create a prefix or suffix in the name of the restored virtual machine.

The following characters are not supported in names of restored virtual machines: <q>;\|\*?;</\| . A restore command that includes unsupported characters will fail with error message ANS9117E.

VMWare does not support virtual machine names of greater than 80 characters in length.

A timestamp option, recording the date and time of the restore, can be appended to the name of the virtual machine that is restored. The option output uses the DATEFORMAT and TIMEFORMAT formats defined in the options file to determine how to specify the timestamp string. A dash is used as a delimiter in the dates returned by the timestamp parameters.

Note: This parameter is not valid for restoring VMware virtual machines backed up using VCB or if the FROM parameter specifies LOCAL.

#### DATACENTER

Specifies the name of the data center to restore the virtual machine to as it is defined in the vSphere vCenter. If the data center is contained in a folder, you must specify the -datacenter option when you restore the virtual machine and include the folder structure of the data center in the data center name. For example, the following syntax is valid:

```
-datacenter=folder_name/datacenter_name
```

When you restore a virtual machine by using the GUI, you must restore the virtual machine to a different location. If you restore to the original location, you cannot specify the folder name of the data center. Without a folder name to help locate the original data center, the restore operation fails.

Note: This parameter is not valid for restoring VMware virtual machines that were backed up using VCB.

#### HOST

Specifies the domain name of the ESX host server to restore to as it is defined in the vSphere vCenter.

This parameter is case-sensitive and must be the same value as the host name that is shown in the VMware vSphere Web Client. To confirm the host name in the vSphere Web client, select a host and click Manage > Networking > TCP/IP configuration > DNS.

Note: This parameter is not valid for restoring VMware virtual machines that were backed up using VCB.

#### DATASTORE

Specifies the VMware datastore to restore the virtual machine to. The datastore can be on a SAN, NAS, iSCSI device, or VMware virtual volume (VVOL). You can specify only one datastore when you restore a virtual machine. If you do not specify a datastore parameter, the virtual machine's VMDK file is restored to the datastore it was on when the backup was created.

Note: This parameter is not valid for restoring VMware virtual machines that were backed up using VCB.

**Windows** *destinationfilespec*

**Windows** This parameter is for VMware VCB restores only. It specifies the location where VCB full virtual machine image files are restored. If this option is not specified the vbackdir option is used.

#### :vmdk=all-vmdk

This option specifies that all virtual disks (\*.vmdk files) are included when the virtual machine is restored. This is the default.

Note: This parameter is not valid for restoring VMware virtual machines that were backed up using VCB.

#### :vmdk=cnfg

This option specifies that the virtual machine configuration information is restored. The configuration information is always restored when a new virtual machine is created. However, by default the configuration is not restored when you update an existing virtual machine with selected virtual disks.

Ordinarily, restoring configuration information to an existing virtual machine fails because the restored configuration information conflicts with the existing virtual machine configuration information. Use this option if the existing configuration file for a virtual machine on the ESX server has been deleted, and you want to use the backed up configuration to re-create it.

Note: This parameter is not valid for restoring VMware virtual machines that were backed up using VCB.

#### :vmdk=*disk label*

This option is used to specify the disk label of the virtual disks to include in the restore operation. You specify this option only if you want to selectively restore data from specific disks.

Note: On the Restore VM command, the label names of the vmdk files that you want to include (:vmdk= parameter) in a Restore VM operation must be specified as the English-language label name, as it is displayed in the output of the Backup VM *vmname* -preview command. Examples of the English vmdk labels are "Hard Disk 1", "Hard Disk 2", and so on.

Note: This parameter is not valid for restoring VMware virtual machines that were backed up using VCB.

`:-vmdk=disk label`

This option is used to specify the disk label of one or more virtual disks to exclude from the restore operation.

Note: On the Restore VM command, the label names of the vmdk files that you want to exclude (`:-vmdk=` parameter) from a Restore VM operation must be specified as the English-language label name, as it is displayed in the output of the `Backup VM vmname -preview` command. Examples of the English vmdk labels are "Hard Disk 1", "Hard Disk 2", and so on.

Note: This parameter is not valid for restoring VMware virtual machines that were backed up using VCB.

Table 1. Restore VM command: Related options when restoring VMware virtual machines

Option	Where to use
datacenter	Command line or options file. This parameter is not valid for restoring VMware virtual machines that were backed up using VCB.
datastore	Command line or options file. This parameter is not valid for restoring VMware virtual machines that were backed up using VCB.
host	Command line or options file. This parameter is not valid for restoring VMware virtual machines that were backed up using VCB.
inactive	Command line.
pick	Command line. This parameter is not valid for restoring VMware virtual machines that were backed up using VCB.
pitdate	Command line. This parameter is not valid for restoring VMware virtual machines that were backed up using VCB.
pittime	Command line. This parameter is not valid for restoring VMware virtual machines that were backed up using VCB.
<b>Windows</b> vmautostartvm This parameter is only valid when instantaccess is specified as the vmrestoretype value.	<b>Windows</b> Command line or client options file.
vmbackdir	Command line or client options file.
vmbackuplocation	Command line.
vmbackuptype	Command line or client options file.
vmdefaultdvportgroup	Command line or client options file
vmdefaultdvswitch	Command line or client options file
vmdefaultnetwork	Command line or client options file
vmdiskprovision This parameter is only valid when instantrestore is specified for the vmrestoretype value.	Command line or client options file.
<b>Windows</b> vmiscsiserveraddress This parameter is only valid when either instantaccess or instantrestore is specified for the vmrestoretype value.	<b>Windows</b> Command line or client options file.
vmmaxrestoresessions	Command line or client options file.
<b>Windows</b> vmrestoretype	<b>Windows</b> Command line.
<b>Windows</b> vmtempdatastore This parameter is only valid when instantrestore is specified for the vmrestoretype value.	<b>Windows</b> Command line or client options file.
vmvstortransport	Command line or client options file. This parameter is not valid for restoring VMware virtual machines that were backed up using VCB.

## Examples

---

### Windows Task

**Windows** To perform an instant restore or instant access operation from the command line, see Scenarios for running full VM instant access and full VM instant restore from the backup-archive client command line.

#### Task

Restore the most recent backup version of *myVM* to its original name. Use the VMware management interface to delete the original virtual machine, before you restore it using this syntax.

```
dsmc restore vm myvm
```

#### Task

Restore the most recent backup version of *myvm* to a new machine that is created with the name "Test Machine", and with the restore target for the data center, ESX host, and datastore all specified on the command.

```
dsmc restore vm myvm -vmname="Test Machine"  
-datacenter="myDatacenter" -host="myHostName"  
-datastore="myDatastore"
```

#### Task

Restore the most recent backup version of *myvm* with the new name *myvm\_restored*.

```
dsmc restore vm myvm -vmname="*_restored"  
-datacenter="myDatacenter" -host="myHostName"  
-datastore="myDatastore"
```

#### Task

Restore the most recent backup version of *myvm* with a new name, showing date and time, similar to *myvm\_03-22-2017\_14-41-24*.

```
dsmc restore vm myvm -vmname="*_<timestamp>"  
-datacenter="myDatacenter" -host="myHostName"  
-datastore="myDatastore"
```

#### Task

Restore the most recent backup version of *myvm*. Restore to a data center named *mydatacenter*. The data center is within the vCenter; the relative path within the vCenter is *dirA/datacenters/*.

```
dsmc restore vm myvm -vmname="Test Machine"  
-datacenter="dirA/datacenters/myDatacenter"  
-host="myHostName" -datastore="myDatastore"
```

#### Task

Restore a virtual machine template back to the same location and name.

```
dsmc restore vm vmTemplateName
```

#### Task

Restore a virtual machine template to a new location.

```
dsmc restore vm vmTemplateName -vmname=newName  
-datastore=newDatastore -host=newHost  
-datacenter=newDatacenter
```

#### Task

Restore only Hard Disk 2 and Hard Disk 3 to the existing virtual machine that is named *vm1*.

```
dsmc restore vm "vm1:vmdk=Hard Disk 2:vmdk=Hard Disk 3"
```

#### Task

Restore all disks to the existing virtual machine named *vm1*, but do not restore the data from Hard Disk 4.

```
dsmc restore vm "vm1:-vmdk=Hard Disk 4"
```

#### Task

Restore only the data from hard Disk 1 to the existing virtual machine *vm1*; do not update any configuration information. Note: When you restore an existing virtual machine, the default behavior is to not update the configuration information.

```
dsmc restore vm "vm1:vmdk=Hard Disk 1:-vmdk=cnfg"
```

## Task

Restore all disks to the existing virtual machine named vm1.

```
dsmc restore vm "vm1:vmdk=all-vmdk"
```

This command updates all virtual disks on an existing virtual machine, named vm1. Note that this action is different from the action that is performed by `dsmc restore vm vm1`, which creates a new virtual machine named vm1 (vm1 must not exist in order for `dsmc restore vm vm1` to succeed).

## Task

Set a maximum of three sessions to be used for restore operations for virtual disks in the VM vm1:

```
dsmc restore vm vm1 -vmmaxrestoresessions=3
```

**Important:** For Windows virtual machines: If you attempt to run a full VM restore of an application protection backup that was created with 2 or more snapshot attempts, the system provider snapshot is present on the restored VM. As the application writes to the disk, the shadow storage space grows until it runs out of disk space.

In general, if application protection was used during a backup, use only application protection restore. When you restore the application, the volume is automatically reverted. However, if you must restore the full VM, you must either revert or delete the shadow copy.

After you restore the entire VM, verify that the restore was successful, and the data is not corrupted. If the data is not corrupted, delete the shadow copy. If the data is corrupted, revert the shadow copy to restore data integrity.

You can determine which shadow copy to delete or revert by looking for the `dsmShadowCopyID.txt` file in the root directory of each restored volume. This file contains the snapshot IDs of the shadow copies that were created during the snapshot attempts. You can use the `diskshadow` command `delete shadows` to delete these IDs, or the `revert` command to revert the shadow copy. After the delete or revert is completed, you can also delete the `dsmShadowCopyID.txt` file.

For more information, see `INCLUDE.VMSNAPSHOTATTEMPTS`.

Windows

## Restore VM for Microsoft Hyper-V virtual machines

---

Use the Restore VM command to restore Hyper-V guests. You can restore Hyper-V guests to a local disk, a SAN-attached disk, to a cluster shared volume, or to a remote file server share. Remote file server shares must be on a Windows Server 2012 or later system.

If the virtual machine that you are restoring exists, the backup-archive client shuts it down and deletes all files that comprise the virtual machine. The client then restores it from the image that is stored on the IBM Spectrum Protect server. If the virtual machine is a member of a Windows Server 2012 cluster, the virtual machine is taken offline from the cluster, which stops the virtual machine. The files are then deleted, and the client restores it from the IBM Spectrum Protect backup.

**Tip:** Even though the client shuts down the virtual machine before it deletes it, manually shutting down the virtual machine before you run the Restore VM command is a good practice to follow to bring any in-progress application activities to an orderly stop. Then, use the Restore VM command to restore the virtual machine such that its content and configuration are identical to what it was when it was backed up.

## Supported Clients

---

This command is valid on supported Windows clients that are installed on a Hyper-V host system.

## Syntax

---

```
>>-REStore VM-- --sourcevmspec----->
>--+-----+----->
  '- -targetpath=--path--+-----+-'
                                     '- -vmname=--new_vm_name-'
>--+-----+----->>
  '-+-----+-'
  '- --options-'
```

## Parameters

Any parameter that contains spaces must be enclosed in quotation marks (" ").

The *sourcevmspec* parameter is required. The other parameters are optional. Consider the following scenarios to determine the parameters to use:

- To restore the virtual machine to the original path using the original virtual machine name, use only the *sourcevmspec* parameter. The virtual machine is restored with its original VMware GUID.
- To restore the virtual machine to an alternate path using the original virtual machine name, use the *sourcevmspec* and *-targetpath* parameters. The virtual machine is restored to the specified path with a new VMware GUID. The virtual machine in the original path is not deleted.
- To restore the virtual machine to an alternate path using a new virtual machine name, use the *sourcevmspec*, *-targetpath*, and *-vmname* parameters. The virtual machine is restored to the specified path with the new name and a new VMware GUID. The virtual machine with the original name in the original path is not deleted.

The *-vmname* parameter is valid only for restoring virtual machines that were backed up by using *iffull* or *ifincremental* modes. This parameter is ignored for virtual machines that were backed up by using the *full* or *incremental* modes that were provided in previous product releases.

### *sourcevmspec*

Specifies the name of the virtual machine you want to restore. The virtual machine name is case-sensitive. You cannot use wildcards in the virtual machine name.

### *-targetpath=path*

Specifies the path that you want to restore the virtual machine to.

This parameter is required if the *-vmname* parameter is used and optional otherwise. Use this parameter to restore the virtual machine to an alternate path.

### *-vmname=new\_vm\_name*

Specifies a new name for the virtual machine. The name can contain 1-100 characters. The following characters are not valid: \ / : ; , \* ? " ' < > |

This parameter requires the *-targetpath* parameter.

Table 2. Restore VM command: Related options when restoring Hyper-V virtual machines

Option	Where to use
inactive	Command line
pick	Command line
pitdate	Command line
pittime	Command line
replace	Command line, client options file, or client preferences editor.
vmbackdir	Command line, client options file.

## Examples

### Task

Restore the most recent backup version of a virtual machine named VM1 to the drive and path it was in when it was backed up.

```
dsmc restore vm VM1
```

### Task

Restore the most recent backup version of a virtual machine named vm1 to the drive and path it was in when it was backed up. Replace the existing virtual machine without prompting.

```
dsmc restore vm vm1 -replace=yes
```

### Task

Restore the backed up virtual machine named VM1 to a new name (vm2):

```
dsmc restore vm VM1 -VmName=vm2
```

### Task

Restore the backed up virtual machine named vm1, and assign it a new name (vm2). Issue a prompt before overwriting vm2, if that virtual machine already exists.

```
dsmc restore vm vm1 -VmName=vm2 -replace=prompt
```

#### Task

Restore the virtual machine named vm1 to a specific drive and path, without renaming the virtual machine:

```
dsmc restore vm vm1 -targetpath="E:\New Path"
```

#### Task

Restore the virtual machine named vm1, but rename it as vm2 and restore it to a new path:

```
dsmc restore vm vm1 -VmName=vm2 -targetpath=F:\NewPath
```

#### Task

Use `-pick` and `-inactive` to show active and inactive backups for a virtual machine that is named vm1. You choose the backup to restore from a list:

```
dsmc restore vm vm1 -pick -inactive
```

## Retrieve

---

The `retrieve` command obtains copies of archived files from the IBM Spectrum Protect™ server. You can retrieve specific files or entire directories.

Use the `description` option to specify the descriptions that are assigned to the files you want to retrieve.

Use the `pick` option to display a list of your archives from which you can select an archive to retrieve.

Retrieve the files to the same directory from which they were archived, or to a different directory. The backup-archive client uses the `preservepath` option with the `subtree` value as the default for restoring files.

**Mac OS X** Note: When a directory is retrieved, its modification date and time is set to the date and time of the retrieval, not to the date and time the directory had when it was archived. This is because the backup-archive client retrieves the directories first, then adds the files to the directories.

**Windows** Note:

1. When a directory is retrieved, its modification date and time is set to the date and time of the retrieve, not to the date and time the directory had when it was archived. This is because the backup-archive client retrieves the directories first, then adds the files to the directories.
2. An error occurs if you attempt to retrieve a file whose name is the same as the short name of an existing file. For example, if you attempt to retrieve a file you specifically named ABCDEF~1.DOC into the same directory where a file named abcdefghijk.doc exists, the retrieve fails because the Windows operating system equates the file named abcdefghijk.doc to a short name of ABCDEF~1.DOC. The retrieve function treats this as a duplicate file.

If this error occurs, perform any of the following actions to correct it:

- o Retrieve the file with the short file name you specified to a different location.
- o Stop the retrieval, and change the name of the existing file.
- o Disable the short file name support on Windows.
- o Do not use file names that conflict with the short file naming convention. For example, do not use ABCDEF~1.DOC.

**Windows** The workstation name is part of the file name. Therefore, if you archive files on one workstation and you want to retrieve them to another workstation, you must specify a destination. This is true even if you are retrieving to the same physical workstation, but the workstation has a new name. For example, to retrieve the `c:\doc\h2.doc` file to its original directory on the workstation, named star, you would enter:

```
dsmc retrieve c:\doc\h2.doc \\star\c$\
```

The workstation named star has been renamed and the new name is meteor. To retrieve the `c:\doc\h2.doc` file to meteor, you would enter:

```
dsmc retrieve c:\doc\h2.doc \\meteor\c$\
```

You could also enter:

```
dsmc retrieve c:\doc\h2.doc \\star\c$\
```



You can enter the command in either of the preceding ways because if the workstation name is not included in the specification, the local workstation is assumed (meteor, in this case).

AIX Linux Solaris Mac OS X Windows

## Supported Clients

This command is valid for all clients.

Mac OS X AIX Linux Solaris Mac OS X

## Syntax

```
>>-REtrieve--+-----+--+ --sourcefilespec--+----->
      '- --options-' '- --"sourcefilespec"-'
>--+-----+-----><
      '- --destinationfilespec-'
```

Windows

## Syntax

```
>>-REtrieve--+-----+----->
      '- --options-'
>--+ --sourcefilespec--+-----+----->
      '- --{--filespace--}-sourcefilespec-'
>--+-----+-----><
      '- --destinationfilespec-'
```

## Parameters

AIX Linux Solaris Mac OS X sourcefilespec

AIX Linux Solaris Mac OS X Specifies the path and file name that you want to retrieve. Use wildcard characters to specify a group of files or all the files in a directory.

Windows sourcefilespec

Windows Specifies the path and file name that you want to retrieve. Use wildcard characters to specify a group of files or all the files in a directory.

Note: If you include filespace, do not include a drive letter in the file specification.

Windows {filespace}

Windows Specifies the file space (enclosed in braces) on the server that contains the files you want to retrieve. This name is the drive label on the workstation drive from which the files were archived.

Use the file space name if the drive label name has changed, or if you are retrieving files that were archived from another node that had drive label names that are different from yours.

Note: You must specify a mixed or lowercase NTFS or ReFS file space name that is enclosed in quotation marks and braces. For example, {"NTFSDrive"}. Single quotation marks or quotation marks are valid in loop mode. For example: {"NTFSDrive"} and {'NTFSDrive'} are both valid. In batch mode, only single quotation marks are valid. The single quotation marks requirement is a restriction of the operating system.

AIX Linux Solaris Mac OS X destinationfilespec

AIX Linux Solaris Mac OS X Specifies the path and file name where you want the files to be written. If you do not specify a destination, the client restores the files to the original source path.

Note: If you do not specify a destination, the backup-archive client determines whether the original file system can be reached. If the original file system cannot be reached, the client does not restore the file.

AIX Linux Solaris This failure can also occur if you remove the virtualmountpoint option from the dsm.sys file. In this case, you can specify a different destination, or restore the original virtualmountpoint option to the dsm.sys file, restart the client, and try the command again.

Windows destinationfilespec

Windows Specifies the path and file name where you want the files to be written. If you do not specify a destination, the client restores the files to the original source path.

When you enter the destinationfilespec string, consider the following points:

- If the sourcefilespec names a single file, the destinationfilespec can be a file or a directory.
- If the sourcefilespec is wildcarded or if you specify the `subdir=yes` option, the destinationfilespec must be a directory and end with a directory delimiter (\).

Note: If the destination path or any part of it does not exist, the client creates it.

Table 1. Retrieve command: Related options

Option	Where to use
<b>Windows</b> dateformat	<b>Windows</b> Client options file (dsm.opt) or command line.
<b>AIX</b> <b>Linux</b> <b>Solaris</b> <b>Mac OS X</b> dateformat	<b>AIX</b> <b>Linux</b> <b>Solaris</b> <b>Mac OS X</b> Client user options file (dsm.opt) or command line.
description	Command line only.
dirsonly	Command line only.
filelist	Command line only.
filesonly	Command line only.
<b>AIX</b> <b>Linux</b> <b>Solaris</b> <b>Mac OS X</b> followsymbolic	<b>AIX</b> <b>Linux</b> <b>Solaris</b> <b>Mac OS X</b> Client user options file (dsm.opt) or command line.
fromdate	Command line only.
fromnode	Command line only.
<b>AIX</b> <b>Linux</b> <b>Solaris</b> <b>Mac OS X</b> <b>Mac OS X</b> fromowner	<b>AIX</b> <b>Linux</b> <b>Solaris</b> <b>Mac OS X</b> <b>Mac OS X</b> Command line only.
fromtime	Command line only.
ifnewer	Command line only.
pick	Command line only.
preservepath	Command line only.
<b>Windows</b> replace	<b>Windows</b> Client options file (dsm.opt) or command line.
<b>AIX</b> <b>Linux</b> <b>Solaris</b> <b>Mac OS X</b> replace	<b>AIX</b> <b>Linux</b> <b>Solaris</b> <b>Mac OS X</b> Client user options file (dsm.opt) or command line.
<b>Windows</b> skipntpermissions	<b>Windows</b> Client options file (dsm.opt) or command line.
<b>Windows</b> skipntsecuritycrc	<b>Windows</b> Client options file (dsm.opt) or command line.
<b>Windows</b> subdir	<b>Windows</b> Client options file (dsm.opt) or command line.
<b>AIX</b> <b>Linux</b> <b>Solaris</b> <b>Mac OS X</b> subdir	<b>AIX</b> <b>Linux</b> <b>Solaris</b> <b>Mac OS X</b> Client user options file (dsm.opt) or command line.
<b>Windows</b> tapeprompt	<b>Windows</b> Client options file (dsm.opt) or command line.
<b>AIX</b> <b>Linux</b> <b>Solaris</b> <b>Mac OS X</b> tapeprompt	<b>AIX</b> <b>Linux</b> <b>Solaris</b> <b>Mac OS X</b> Client user options file (dsm.opt) or command line.
<b>Windows</b> timeformat	<b>Windows</b> Client options file (dsm.opt) or command line.
<b>AIX</b> <b>Linux</b> <b>Solaris</b> <b>Mac OS X</b> timeformat	<b>AIX</b> <b>Linux</b> <b>Solaris</b> <b>Mac OS X</b> Client user options file (dsm.opt) or command line.
todate	Command line only.
totime	Command line only.

## Examples

<b>AIX</b> <b>Linux</b> <b>Solaris</b> <b>Mac OS X</b> Task
<b>AIX</b> <b>Linux</b> <b>Solaris</b> <b>Mac OS X</b> Retrieve a single file named budget.

```
retrieve /home/devel/projecta/budget
```

**Windows Task**

**Windows** Retrieve a single file named budget.fin.

```
ret c:\devel\projecta\budget.fin
```

**AIX Linux Solaris Mac OS X Task**

**AIX Linux Solaris Mac OS X**

Retrieve all files with an extension of .c from the /home/devel/projecta directory.

```
retrieve "/home/devel/projecta/*.c"
```

**Windows Task**

**Windows** Retrieve all files with an extension of .c from the c:\devel\projecta directory.

```
ret c:\devel\projecta\*.c
```

**Windows Task**

**Windows** Retrieve all files with a file extension of .c from the \devel\projecta directory on the winnt file space.

```
ret {winnt}\devel\projecta\*.c
```

**AIX Linux Solaris Mac OS X Task**

**AIX Linux Solaris Mac OS X**

Retrieve all files in the /home directory.

```
retrieve /home/
```

**Windows Task**

**Windows** Retrieve all files in the c:\devel directory.

```
ret c:\devel\*
```

**Windows Task**

**Windows** Retrieve files from the abc file space proj directory.

```
ret {abc}\proj\*.*
```

**AIX Linux Solaris Mac OS X Task**

**AIX Linux Solaris Mac OS X**

Retrieve all files with a file extension of .c from the /home/devel/projecta directory to the /home/newdevel/projectn/projecta directory. If the /projectn or the /projectn/projecta directory does not exist, it is created.

```
retrieve "/home/devel/projecta/*.c" /home/newdevel/projectn/
```

**Windows Task**

**Windows** Retrieve all files with a file extension of .c from the c:\devel\projecta directory to the c:\newdevel\projectn\projecta directory. If the \projectn or the \projectn\projecta directory does not exist, it is created.

```
ret c:\devel\projecta\*.c c:\newdevel\projectn\
```

**AIX Linux Solaris Mac OS X Task**

**AIX Linux Solaris Mac OS X**

Retrieve files in the /user/project directory. Use the pick option.

```
ret "/user/project/*" -pick
```

**Windows Task**

**Windows** Retrieve files in the c:\project directory. Use the pick option.

```
ret c:\project\* -pick
```

**AIX Linux Solaris Mac OS X Task**

**AIX Linux Solaris Mac OS X**

Retrieve all files that were archived from the /proj directory with the description "2012 survey results".

```
retrieve "/proj/*" -desc="2012 survey results"
```

**AIX Linux Solaris Mac OS X Task**

**AIX Linux Solaris Mac OS X**

Retrieve archived file /home/devel/budget with description "my budget" to the /dev/rmt1 tape drive.

```
mkfifo fifo
dd if=fifo of=/dev/rmt1&
dsmc retrieve -replace=yes -description="mybudget"
/home/devel/budget fifo
```

#### Mac OS X Task

**Mac OS X** Retrieve a file from the renamed file space `Jaguar_OLD` to its original location. Enter both the source and destination as follows:

```
ret Jaguar_OLD/user5/Documents/myresume.doc /Users/user5/Documents/
```

#### Windows Task

**Windows** Retrieve a file from the renamed file space `\\your-node\h$_OLD` to its original location. Enter both the source and destination as follows:

```
ret \\your-node\h$_OLD\docs\myresume.doc h:\docs\
```

- **Mac OS X | Windows** Retrieve archives from file spaces that are not Unicode-enabled  
If you want to retrieve archives from file spaces that were renamed by the Unicode-enabled client, you must specify the source on the server and a destination on the client.
- **Windows** Retrieve named streams  
The backup-archive client retrieves named streams on a file basis only.
- **Windows** Retrieve sparse files  
When retrieving sparse files to a non-NTFS or non-ReFS file system, set the server communication time-out value (IDLETIMEOUT) to the maximum value of 255 to avoid client session timeout.

#### Mac OS X | Windows

## Retrieve archives from file spaces that are not Unicode-enabled

---

If you want to retrieve archives from file spaces that were renamed by the Unicode-enabled client, you must specify the source on the server and a destination on the client.

**Mac OS X** This section applies to Mac OS X only. For example, assume that `Jaguar` is the name of your startup disk and you archive all of the `.log` files in the `/Users/user5/Documents` directory. Before the archive takes place, the server renames the file space to `Jaguar_OLD`. The archive places the data specified in the current operation into the Unicode-enabled file space named `.`. The new Unicode-enabled file space now contains only the `Users/user5/Documents` directory and the `*.log` files specified in the operation.

**Mac OS X** If you want to retrieve a file from the *renamed* (old) file space to its original location, you must enter both the source and destination as follows:

**Windows** If you want to retrieve archives from file spaces that were renamed by the Unicode-enabled client, you must specify the source on the server and a destination on the client. For example, you archived files from your H-disk, named `\\your-node\h$` prior to installing the client. After the installation, you issue the following archive command:

```
arc h:\logs\*.log
```

**Windows** Before the archive takes place, the server renames the file space to `\\your-node\h$_OLD`. The archive continues placing the data specified in the current operation into the Unicode-enabled file space named `\\your-node\h$`. That file space now contains only the `\logs` directory and the `*.log` files. If you want to retrieve a file from the (old) *renamed* file space to its original location, you must enter both the source and destination as follows:

```
retrieve \\your-node\h$_OLD\docs\myresume.doc h:\docs\
```

#### Windows

## Retrieve named streams

---

The backup-archive client retrieves named streams on a file basis only.

Directories in Windows systems can contain named streams. Named streams attached to a directory will always be overwritten (regardless of the value of the prompt option) during the retrieve.

#### Windows

## Retrieve sparse files

---

When retrieving sparse files to a non-NTFS or non-ReFS file system, set the server communication time-out value (IDLETIMEOUT) to the maximum value of 255 to avoid client session timeout.

The following issues apply if more data is restored than the Microsoft disk quota allows:

- If the user who is performing the retrieve has a disk quota (for example, the user belongs to the Backup Operator Group), the backup-archive client does not retrieve any data that exceeds the disk quota of the retrieve user and displays a "Disk Full" message.
- If the user who is performing the retrieve does not have a disk quota (for example, the user belongs to the Administrator Group), the backup-archive client retrieves all data and transfers ownership of the files that exceed the disk quota of the original owner to the user who is performing the retrieve (in this case, the Administrator).

## Schedule

---

The schedule command starts the client scheduler on your workstation. The client scheduler must be running before scheduled work can start.

**AIX** | **Linux** | **Solaris** | **Mac OS X** **Authorized User:** The schedule command starts the client scheduler on your workstation. The client scheduler must be running before scheduled work can start.

Note:

1. The schedule command cannot be used if the managedservices option is set to `schedule`.
2. **Mac OS X** For Mac OSX only, to use the schedule command, specify `managedservices none` in the `dsm.sys` file.
3. This command is valid only on the initial command line. It is not valid in interactive mode or in a macro file.

**Windows** If the `schedmode` option is set to `polling`, the client scheduler contacts the server for scheduled events at the hourly interval you specified with the `querschedperiod` option in your client options file (`dsm.opt`). If your administrator sets the `querschedperiod` option for all nodes, that setting overrides the client setting.

**AIX** | **Linux** | **Solaris** | **Mac OS X** If the `schedmode` option is set to `polling`, the client scheduler contacts the server for scheduled events at the hourly interval you specified with the `querschedperiod` option in your client user-options file (`dsm.opt`). If your administrator sets the `querschedperiod` option for all nodes, that setting overrides the client setting.

**Windows** If you are using TCP/IP communications, the server can prompt your workstation when it is time to run a scheduled event. To do so, set the `schedmode` option to `prompted` in the client options file (`dsm.opt`) or on the schedule command.

**AIX** | **Linux** | **Solaris** | **Mac OS X** If you are using TCP/IP communications, the server can prompt your workstation when it is time to run a scheduled event. To do so, set the `schedmode` option to `prompted` in the client user-options file (`dsm.opt`) or on the schedule command.

**Windows** After you start the client scheduler, it continues to run and to start scheduled events until you press `Ctrl+Break`, restart the workstation, or turn off the workstation to end it.

**AIX** | **Linux** | **Solaris** | **Mac OS X** | **Mac OS X** You can use the `sessioninitiation` option with the schedule command to control whether the server or client initiates sessions through a firewall.

**AIX** | **Linux** | **Solaris** | **Mac OS X** After you start the client scheduler, it continues to run and to start scheduled events until you press `Ctrl+C`, stop the scheduler process with the UNIX kill command, start the workstation again, or turn off the workstation to end it.

**Mac OS X** After you start the client scheduler, it continues to run and to start scheduled events until you press `Ctrl+C`, press the `Q` key twice, start the workstation again, or turn off the workstation to end it.

**AIX** | **Linux** | **Solaris** | **Mac OS X** | **Windows** Note: You *cannot* enter this command in interactive mode.  
**AIX** | **Linux** | **Solaris** | **Mac OS X** | **Windows**

## Supported Clients

---

This command is valid for all clients.

## Syntax

---

```
>>-SCHEDULE----->>
      '- --options-'
```

## Parameters

Table 1. Schedule command: Related options

Option	Where to use
Windows maxcmdretries	Windows Client options file (dsm.opt) or command line.
AIX Linux Solaris Mac OS X maxcmdretries	AIX Linux Solaris Mac OS X Client system options file (dsm.sys) or command line.
Windows password	Windows client options file (dsm.opt)
AIX Linux Solaris Mac OS X password	AIX Linux Solaris Mac OS X client user options file (dsm.opt)
Windows queryschedperiod	Windows Client options file (dsm.opt) or command line.
AIX Linux Solaris Mac OS X queryschedperiod	AIX Linux Solaris Mac OS X Client system options file (dsm.sys) or command line.
Windows retryperiod	Windows Client options file (dsm.opt) or command line.
AIX Linux Solaris Mac OS X retryperiod	AIX Linux Solaris Mac OS X Client system options file (dsm.sys) or command line.
Windows schedlogname	Windows Client options file (dsm.opt) or command line.
AIX Linux Solaris Mac OS X schedlogname	AIX Linux Solaris Mac OS X Client system options file (dsm.sys) or command line.
Windows schedmode	Windows Client options file (dsm.opt) or command line.
AIX Linux Solaris Mac OS X schedmode	AIX Linux Solaris Mac OS X Client system options file (dsm.sys) or command line.
Windows sessioninitiation	Windows Client options file (dsm.opt) or command line.
AIX Linux Solaris Mac OS X sessioninitiation	AIX Linux Solaris Mac OS X Client system options file (dsm.sys) or command line.
Windows tcpclientport	Windows Client options file (dsm.opt) or command line.
AIX Linux Solaris Mac OS X tcpclientport	AIX Linux Solaris Mac OS X Client system options file (dsm.sys) or command line.

## Examples

Mac OS X Windows Task  
Mac OS X Windows Start the client scheduler.

**Command:** `dsmc sch -password=notell`

AIX Linux Solaris Mac OS X Task  
AIX Linux Solaris Mac OS X For AIX®: Start the scheduler at system bootup time by entering this command in the `/etc/inittab` file. Ensure that the **passwordaccess** option is set to *generate*.

**Command:** `tsm::once:/usr/bin/dsmc sched > /dev/null 2>&1 #TSM`

AIX Linux Solaris Mac OS X Task  
AIX Linux Solaris Mac OS X Interactively start the scheduler and keep it running in the background.

**Command:** `nohup dsmc sched 2> /dev/null &`

Windows When you run the schedule command, all messages that regard scheduled work are sent to the `dsmsched.log` file or to the file you specify with the `schedlogname` option in your client options file (dsm.opt). If you do not specify a directory path with the file name in the `schedlogname` option, the `dsmsched.log` resides in the current working directory.

**AIX** **Linux** **Solaris** **Mac OS X** When you run the schedule command, all messages that regard scheduled work are sent to the `dsmsched.log` file or to the file you specify with the `schedlogname` option in your client system-options file (`dsm.sys`). If you do not specify a directory path with the file name in the `schedlogname` option, the `dsmsched.log` resides in the current working directory, except for Mac OS X. For Mac OS X, the `dsmsched.log` resides in the `/Library/Logs/tivoli/tsm/` directory.

**AIX** **Linux** **Solaris** **Mac OS X** **Windows** Important: To prevent log write failures and process termination in certain cases, set the `DSM_LOG` environment variable to name a directory where default permissions allow the required access.

## Selective

The selective command backs up files that you specify. If you damage or mislay these files, you can replace them with backup versions from the server.

When you run a selective backup, all the files are candidates for backup unless you exclude them from backup, or they do not meet management class requirements for serialization.

During a selective backup, copies of the files are sent to the server even if they did not change since the last backup - which can result in more than one copy of the same file on the server. If this occurs, you might not have as many different down-level versions of the file on the server as you intended. Your version limit might consist of identical files. To avoid this, use the incremental command to back up only new and changed files.

**AIX** **Linux** **Solaris** **Mac OS X** **Windows** You can selectively back up single files or directories. You can also use wildcard characters to back up groups of related files.

If you set the `subdir` option to `yes` when you back up a specific path and file, the client recursively backs up all subdirectories under that path, and any instances of the specified file that exist under any of those subdirectories.

During a selective backup, a directory path might be backed up, even if the specific file that was targeted for backup is not found. For example, the following command still backs up `dir1` and `dir2` even if the file `bogus.txt` does not exist.

**Mac OS X**

```
selective /Users/user1/Documents/dir1/bogus.txt
```

**AIX** **Linux** **Solaris** **Mac OS X**

```
selective "/dir1/dir2/bogus.txt"
```

**Windows**

```
selective c:\dir1\dir2\bogus.txt
```

If the selective command is retried because of a communication failure or session loss, the transfer statistics displays the number of bytes that the client attempts to transfer during *all* command attempts. Therefore, the statistics for bytes transferred might not match the file statistics, such as those for file size.

**AIX** **Linux** **Solaris** **Mac OS X** You can use the `removeoperandlimit` option to specify that the 20-operand limit is removed. If you specify the `removeoperandlimit` option with the selective command, the 20-operand limit is not enforced and is restricted only by available resources or other operating system limits.

**AIX** **Linux** **Solaris** **Mac OS X** **Windows**

## Supported Clients

This command is valid for all clients.

## Syntax

```

      .-----
      v               |
>>>-Selective----- --filespec-----+-----+----->>>
                                   '- --options-'
```

## Parameters

## filespec

Specifies the path and name of the file you want to back up. Use wildcard characters to include a group of files or to include all files in a directory.

To include multiple file specifications, separate each filespec with a space character. If multiple file specifications are included, and two or more of the specifications have common parent directories, then it is possible for the common directory objects to be backed up more than once. The conditions under which this behavior occurs are runtime-dependent, but the behavior itself has no adverse effects.

**AIX** **Linux** **Mac OS X** **Solaris** For example, if the filespec is /home/amr/ice.doc /home/amr/fire.doc, then /home and /home/amr might be backed up twice. The file objects, ice.doc and fire.doc, are backed up only once.

**Windows** For example if the filespec is C:\proposals\drafts\ice.doc C:\proposals\drafts\fire.doc, then C:\proposals and C:\proposals\drafts might be backed up twice. The file objects ice.doc and fire.doc are backed up only once.

If you want to avoid including the shared parent directory more than once, use separate, non-overlapping selective commands to back up each file specification.

**AIX** **Linux** **Mac OS X** **Solaris** If you back up a file system, include a trailing slash (/home/).

**AIX** **Linux** **Mac OS X** **Solaris** There is a limit of 20 operands. This limit prevents excessive sessions that are caused when wildcards are expanded by the UNIX shell command processor. You can prevent shell expansion from causing you to go over the 20-operand limit by placing quotation marks around file specifications that contain wildcards ("home/docs/\*").

**AIX** **Linux** **Mac OS X** **Solaris** You can use the removeoperandlimit option to specify that the 20-operand limit is removed. If you specify the removeoperandlimit option, the 20-operand limit is not enforced and is restricted only by available resources or other operating system limits. For example, remove the 20 operand limit to backup 21 file specifications:

```
selective -removeoperandlimit filespec1 filespec2 ... filespec21
```

**Windows** If you back up a file system, include a trailing slash (C:\).

**Windows** You can specify as many file specifications as available resources or other operating system limits allow. You can use the filelist option, instead of file specifications, to identify which files to include in this operation. However, these two methods are mutually exclusive. You cannot include file specification parameters and use the filelist option. If the filelist option is specified, any file specifications that are included are ignored.

Table 1. Selective command: Related options

Option	Where to use
<b>Windows</b> changingretries	<b>Windows</b> Client options file (dsm.opt) or command line.
<b>AIX</b> <b>Linux</b> <b>Solaris</b> <b>Mac OS X</b> changingretries	<b>AIX</b> <b>Linux</b> <b>Solaris</b> <b>Mac OS X</b> Client system options file (dsm.sys) or command line.
<b>Windows</b> compressalways	<b>Windows</b> Client options file (dsm.opt) or command line.
<b>AIX</b> <b>Linux</b> <b>Solaris</b> <b>Mac OS X</b> compressalways	<b>AIX</b> <b>Linux</b> <b>Solaris</b> <b>Mac OS X</b> Client user options file (dsm.opt) or command line.
<b>Windows</b> compression	<b>Windows</b> Client options file (dsm.opt) or command line.
<b>AIX</b> <b>Linux</b> <b>Solaris</b> <b>Mac OS X</b> compression	<b>AIX</b> <b>Linux</b> <b>Solaris</b> <b>Mac OS X</b> Client user options file (dsm.opt) or command line.
dironly	Command line only.
filelist	Command line only.
filesonly	Command line only.
<b>Windows</b> postsnapshotcmd	<b>Windows</b> Client options file (dsm.opt) or with the include.fs option.
<b>AIX</b> <b>Linux</b> <b>Solaris</b> <b>Mac OS X</b> preservelastaccessdate	<b>AIX</b> <b>Linux</b> <b>Solaris</b> <b>Mac OS X</b> Client user options file (dsm.opt) or command line.
<b>Windows</b> preservelastaccessdate	<b>Windows</b> Client options file (dsm.opt) or command line.
<b>Windows</b> presnapshotcmd	<b>Windows</b> Client options file (dsm.opt) or with the include.fs option.
<b>AIX</b> <b>Linux</b> <b>Solaris</b> <b>Mac OS X</b> <b>Mac OS X</b> removeoperandlimit	<b>AIX</b> <b>Linux</b> <b>Solaris</b> <b>Mac OS X</b> <b>Mac OS X</b> Command line only.



Option	Where to use
<b>Windows</b> skipntppermissions	<b>Windows</b> Client options file (dsm.opt) or command line.
<b>Windows</b> skipntsecuritycrc	<b>Windows</b> Client options file (dsm.opt) or command line.
<b>AIX</b> <b>Linux</b> snapshotcachesize	<b>AIX</b> <b>Linux</b> Client options file (dsm.opt) or with the include.fs option.
<b>AIX</b> snapshotproviderfs	<b>AIX</b> System-options file (dsm.sys) within a server stanza or with the include.fs option.
<b>Windows</b> snapshotproviderfs	<b>Windows</b> Client options file (dsm.opt) or with the include.fs option.
<b>AIX</b> <b>Linux</b> <b>Solaris</b> <b>Mac OS X</b> <b>Windows</b> snapshotroot	<b>AIX</b> <b>Linux</b> <b>Solaris</b> <b>Mac OS X</b> <b>Windows</b> Command line only.
<b>Windows</b> subdir	<b>Windows</b> Client options file (dsm.opt) or command line.
<b>AIX</b> <b>Linux</b> <b>Solaris</b> <b>Mac OS X</b> subdir	<b>AIX</b> <b>Linux</b> <b>Solaris</b> <b>Mac OS X</b> Client user options file (dsm.opt) or command line.
<b>Windows</b> tapeprompt	<b>Windows</b> Client options file (dsm.opt) or command line.
<b>AIX</b> <b>Linux</b> <b>Solaris</b> <b>Mac OS X</b> tapeprompt	<b>AIX</b> <b>Linux</b> <b>Solaris</b> <b>Mac OS X</b> Client user options file (dsm.opt) or command line.

## Examples

**AIX** **Linux** **Solaris** **Mac OS X** Task

**AIX** **Linux** **Solaris** **Mac OS X** Back up the `proja` file in the `/home/devel` directory.

**Command:** `selective /home/devel/proja`

**Windows** Task

**Windows** Back up the `proja.dev` file in the `c:\devel` directory.

**Command:** `sel c:\devel\proja.dev`

**AIX** **Linux** **Solaris** **Mac OS X** Task

**AIX** **Linux** **Solaris** **Mac OS X** Back up all files in the `/home/devel` directory whose file names begin with `proj`.

**Command:** `selective "/home/devel/proj*"`

**Windows** Task

**Windows** Back up all files in the `c:\devel` directory whose file names begin with `proj`.

**Command:** `sel c:\devel\proj*.*`

**AIX** **Linux** **Solaris** **Mac OS X** Task

**AIX** **Linux** **Solaris** **Mac OS X** Back up all files in the `/home/devel` directory whose file names begin with `proj`. Back up the single file that is named `budget` in the `/user/home` directory.

**Command:** `selective "/home/devel/proj*" /user/home/budget`

**Windows** Task

**Windows** Back up all files in the `c:\devel` directory whose file names begin with `proj`. Back up all files with a file extension of `.fin` in the `c:\planning` directory.

**Command:** `sel c:\devel\proj* c:\planning\*.fin`

**AIX** **Linux** **Solaris** **Mac OS X** Task

**AIX** **Linux** **Solaris** **Mac OS X** Back up the `/home` file system.

**Command:** `selective /home/ -subdir=yes`

**AIX** **Linux** **Solaris** **Mac OS X** Task

**AIX** **Linux** **Solaris** **Mac OS X** Assuming that you initiated a snapshot of the `/usr` file system and mounted the snapshot as `/snapshot/day1`, run a selective backup of the `/usr/dir1/sub1` directory tree from the local snapshot and manage it on the IBM Spectrum Protect™ server under the file space name `/usr`.

**Command:** `dsmc sel "/usr/dir1/sub1/*" -subdir=yes -snapshotroot=/snapshot/day1`

#### Windows Task

**Windows** Assuming that you initiated a snapshot of the C:\ drive and mounted the snapshot as \\florence\c\$\snapshots\snapshot.0, run a selective backup of the c:\dir1\sub1 directory tree from the local snapshot and manage it on the IBM Spectrum Protect server under the file space name C:\.

**Command:** `dsmc sel c:\dir1\sub1\* -subdir=yes -snapshotroot=\\florence\c$\snapshots\snapshot.0`

- **Windows** Open file support  
If open file support is configured, the backup-archive client performs a snapshot backup or archive of files that are locked (or "in use") by other applications.
- Associate a local snapshot with a server file space  
Use the snapshotroot option with the selective command in conjunction with an independent software vendor application that provides a snapshot of a logical volume, to associate the data on the local snapshot with the real file space data that is stored on the IBM Spectrum Protect server. The snapshotroot option does not provide any facilities to take a volume snapshot, only to manage data created by a volume snapshot.

#### Windows

## Open file support

---

If open file support is configured, the backup-archive client performs a snapshot backup or archive of files that are locked (or "in use") by other applications.

Use VSS as the snapshot provider; set snapshotproviderimage or snapshotproviderfs to VSS.

Note:

1. You can use the include.fs option to set snapshot options on a per file system basis.
2. Open file support is only available for local fixed volumes (mounted to either drive letters or volume mount points) formatted with NTFS or ReFS file systems. This support includes SAN-attached volumes that meet these requirements.
3. If the client is unable to create a snapshot, failover to non-OFS backup occurs; the same backup support that would be done if the OFS feature was not configured.
4. To enable open file support in a cluster environment, all systems in the cluster should have the OFS feature configured.

## Associate a local snapshot with a server file space

---

Use the snapshotroot option with the selective command in conjunction with an independent software vendor application that provides a snapshot of a logical volume, to associate the data on the local snapshot with the real file space data that is stored on the IBM Spectrum Protect™ server. The snapshotroot option does not provide any facilities to take a volume snapshot, only to manage data created by a volume snapshot.

**AIX** AIX® only: You can perform a snapshot-based selective backup by specifying the option snapshotproviderfs=JFS2.

## Set Access

---

The set access command gives users at other nodes access to your backup versions or archived copies.

You can also use the set access command to give users at other nodes access to your backup images.

You can give another user access to a specific file or image, multiple files or images, or all files in a directory. When you give access to another user, that user can restore or retrieve your objects. Specify in the command whether you are giving access to archives or backups.

**Linux** **Windows** For VMware virtual machines, you can give a user at another node access to the backups of a specific virtual machine.

When a node is exported to another IBM Spectrum Protect™ server, the access rules can change on the importing server. If an access rule is applied to all file spaces on the exporting server, the access rule on the importing server is restricted to only those file spaces that are imported. The file spaces are restricted in the access rule on the importing server for security reasons. Additionally, the access rules do not recognize the first occurrence of a wildcard character in the file specification when you

restore or retrieve. This means that if you restore or retrieve with a wildcard character in the file specification, subdirectories are ignored.

Tip: If you export a node to another IBM Spectrum Protect server, do not use a single wildcard character as the file specification in the access rule. Instead, create an access rule for each filespace.

Note: You cannot give access to both archives and backups using a single command.

**Mac OS X** **Windows** When an existing file space is renamed during Unicode conversion, any access rules that are defined for the file space remain applicable to the original file space. However, new access rules must be defined to apply to the new Unicode file space.

## Supported Clients

This command is valid for all clients.

## Syntax

```
>>-SET Access--+- --Archive+----->
      '- --Backup--'

>--+- --filespec-----+-- --node--+-----+--<
+- --{--filespace--}-filespec+      '- --user-'
+-image-fs-----+
'-TYPE=VM-- --vmname-----'
```

## Parameters

### Archive

Permits access to archived files or images.

### Backup

Permits access to backup versions of files or images.

**AIX** **Linux** **Solaris** **Mac OS X** *filespec*

**AIX** **Linux** **Solaris** **Mac OS X** Specifies the path, file, image, or directory to which you are giving access to another node or user. Use wildcard characters to specify a group of files or images, or all files in a directory branch; or all objects in a file system. Use a single asterisk "\*" for the file spec to give access to all files or images owned by you and backed up on the server. When the command `set access backup "*" node` is entered, no check is made with the server; it is assumed you have at least one object backed up.

If you give access to a branch of the current working directory, you only need to specify the branch. If you give access to objects that are not in a branch of the current working directory, you must specify the complete path. The file spec to which you gave access must have at least one backup version or archive copy object (file or directory) on the server.

To specify all files in a named directory, enter `/home/mine/proj1/*` on the command line.

To give access to all objects below a certain level, use an asterisk, directory delimiter, and an asterisk at the end of your file spec. For example, to give access to all objects below `home/test`, use file spec `home/test/*/*`.

Important: Use of the form `/*/*` alone will not give access to objects in the named directory; only those in directories below the named directory are accessible.

The rules are essentially the same when considering the root directory. Enter `/*` on one set access command and `/*/*` on another if you want another user to have access to all files and directories in and below the root directory. The first `/*` gives access to all directories and all files in the root directory. The second `/*` allows access to all directories and files below the root directory.

For example:

- Your directory structure is multilevel: `/home/sub1/subsub1`.
- The `/home` directory contains the `h1.txt` and `h2.txt` files.
- The `/home/sub1` directory contains file `s1.htm`.
- The `/home/sub1/sub2` directory contains the `ss1.cpp` file.

To allow access to all files in the `/home/sub1/sub2` directory, enter:

```
set access backup /home/sub1/sub2/* * *
```

To allow access to only those files in the /home directory, enter:

```
set access backup /home/* * *
```

To allow access to all files in all directories in and below the /home directory, enter:

```
set access backup /home/* * *  
set access backup /home/*/* * * *
```

#### Windows **filespec**

**Windows** Specifies the path, file, image, or directory to which you are giving access to another node or user. Use wildcard characters to specify a group of files or images, or all files in a directory; all objects in a directory branch; or all objects in a drive. However, you cannot use a wildcard to specify all drives. Use a single asterisk "\*" for the file spec to give access to all files or images owned by you and backed up on the server. When the command `set access backup "*" node` is entered, no check is made with the server; it is assumed you have at least one object backed up.

If you give access to a branch of the current working directory, you only need to specify the branch. If you give access to objects that are not in a branch of the current working directory, you must specify the complete path. The file spec to which you gave access must have at least one backup version or archive copy object (file or directory) on the server.

To specify all files in a named directory, enter `d:\test\mine\proj1\*` on the command line.

To give access to all objects below a certain level, use an asterisk, directory delimiter, and an asterisk at the end of your file spec. For example, to give access to all objects below `d:\test` use file spec `d:\test\*\*`.

Important: Use of the form `\*\*` alone will not give access to objects in the named directory; only those in directories below the named directory are accessible.

The rules are essentially the same when considering the root directory. Enter `\*` on one set access command and `\*\*` on another if you want another user to have access to all files and directories in and below the root directory. The first `\*` gives access to all directories and all files in the root directory. The second `\*` allows access to all directories and files below the root directory.

Note:

1. Use the file space name if the drive label name has changed.
2. If you include filespace name, do not include a drive letter in the file specification.

For example:

- Your directory structure is multilevel: `d:\test\sub1\subsub1`.
- The `d:\test` directory contains the `h1.txt` and `h2.txt` files.
- The `d:\test\sub1` directory contains file `s1.htm`.
- The `d:\test\sub1\sub2` directory contains the `ss1.cpp` file.

To allow access to all files in the `d:\test\sub1\sub2` directory, enter:

```
set access backup d:\test\sub1\sub2\* * *
```

To allow access to only those files in the `d:\test` directory, enter:

```
set access backup d:\test\* * *
```

To allow access to all files in all directories in and below the `d:\test` directory, enter:

```
set access backup d:\test\* * *  
set access backup d:\test\*\* * * *
```

#### Windows **{filespace name}**

**Windows** Specifies the file space name (enclosed in braces) on the server that contains the files to which you are giving access. This name is the drive label name on the workstation drive from which the file was backed up or archived. Use the file space name if the drive label name has changed.

image-fs

The name of the image file system to be shared. This can be specified as an asterisk (\*) to allow access to all images owned by the user granting access.

Linux **Windows** -TYPE=VM *vmname*

**Linux** **Windows** This parameter is required if you are using this command to provide another user with access to VMware virtual machine backups. The *vmname* option can be specified only if `-TYPE=VM` is specified; *vmname* is the name of the VMware virtual machine that you are permitting access to.

node

Specifies the client node of the user to whom you are giving access. Use wildcards to give access to more than one node with similar node names. Use an asterisk (\*) to give access to all nodes.

**AIX** **Linux** **Solaris** **Mac OS X** user

**AIX** **Linux** **Solaris** **Mac OS X** This is an optional parameter that restricts access to the named user at the specified node. To allow any authorized user to access your backed up or archived data, specify `root` as the user.

## Examples

---

**Windows** Task

**Windows** Give the user at `node_2` authority to restore all files with an extension of `.c` from the `c:\devel\proja` directory.

```
set access backup c:\devel\proja\*.c node_2
```

**AIX** **Linux** **Solaris** **Mac OS X** Task

**AIX** **Linux** **Solaris** **Mac OS X** Give the user at `node_2` authority to restore the `budget` file from the `/home/user` directory.

```
set access backup /home/user/budget node_2
```

**AIX** **Linux** **Solaris** **Mac OS X** Task

**AIX** **Linux** **Solaris** **Mac OS X** Give `node_3` the authority to retrieve all files in the `/home/devel/proja` directory.

```
set ac archive /home/devel/proja/ node_3
```

**Windows** Task

**Windows** Give the user at `node_3` authority to retrieve all files in the `c:\devel` directory, but do not permit access to files in subdirectories of `c:\devel`, such as `c:\devel\proj`.

```
set access archive c:\devel\* node_3
```

**AIX** **Linux** **Solaris** **Mac OS X** Task

**AIX** **Linux** **Solaris** **Mac OS X** Give all nodes whose names end with `bldgb` the authority to restore all backup versions from directories with a file space name of `project`.

```
set ac b "{project}/*" "*bldgb"
```

**Windows** Task

**Windows** Give all nodes whose names end with `bldgb` the authority to restore all backup versions from all directories on the `d:` drive. The `d:` drive has the file space name of `project`.

```
set ac b {project}\*\* *bldgb
```

**AIX** **Linux** **Solaris** **Mac OS X** Task

**AIX** **Linux** **Solaris** **Mac OS X** Give any authorized user on `node1` authority to retrieve all files in the `/home/devel/projb` directory.

```
set access archive /home/devel/projb/ node1 root
```

**AIX** **Linux** **Solaris** **Mac OS X** Task

**AIX** **Linux** **Solaris** **Mac OS X** Give user `serena` at `node_5` authority to restore all images of the file space mounted on directory `/home/devel/proja`.

```
set acc backup "home/devel/proja/*/*" node_5 serena
```

**Linux** **Windows** Task

**Linux** **Windows** Give the node named `myOtherNode` the authority to restore files backed up by the VMware virtual machine named `myTestVM`.

```
set access backup -TYPE=VM myTestVM myOtherNode
```

## Set Event

---

Using the set event command, you can specify the circumstances for when archived data is deleted.

You can use the set event command in the following ways:

- Prevent the deletion of data at the end of its assigned retention period (Deletion hold)
- Allow the expiration to take place, as defined by the archive copy group (Release a deletion hold)
- Start the expiration clock to run when a particular event occurs (Notify the server that an event occurred)

Objects that are affected can be specified with a standard file specification (including wildcards), a list of files whose names are in the file that is specified using the filelist option, or a group of archived files with the description specified with the description option.

Note: When only a <filespec> is used, all archived copies of files or folders that match the filespec are affected. If you want to affect certain versions of a file, use the -pick option and select from the displayed list.

## Interaction with down-level servers

---

If the set event command is issued when the client is connected to a server that does not support event-based policy (previous to IBM Spectrum Protect™ 5.2.2), the command is rejected with an error message that indicates the current server does not support event-based policy.

## Supported Clients

---

This command is valid for all clients.

## Syntax

---

```
>>-SET Event---- -TYPE=---+Hold-----+----->
                               +-Release-----+
                               '-Activateretention-'
>-- --<filespec>-- -- -filelist=<filespec>-- -- -description---->
>-- -pick-----><
```

## Parameters

---

TYPE=

Specifies the event type setting. This parameter must be specified.

hold

Prevents the object from being deleted regardless of expiration policy.

release

Allows normal event-controlled expiration to take place.

*activateretention*

Signals the server that the controlling event occurred and starts to run the expiration clock.

-pick

Provides a list of objects from which the user can select to apply the event.

The following options can also be used and serve their usual purpose:

- Dateformat
- Numberformat
- Noprompt
- Subdir
- Timeformat

## Examples

**AIX** | **Linux** | **Solaris** | **Mac OS X** | **Task**

**AIX** | **Linux** | **Solaris** | **Mac OS X** The following example displays the verbose and statistics output from the set event command `set event type=hold /home/accounting/ledgers/*05.books`, with objects rebound (as opposed to archived or some other notation).

```
Rebinding--> 274 /home/accounting/ledgers/
  jan05.books
Rebinding--> 290 /home/accounting/ledgers/
  feb05.books

Total number of objects archived:      0
Total number of objects failed:        0
Total number of objects rebound:      2
Total number of bytes transferred:     0 B
Data transfer time:                    0.00 sec
Network data transfer rate:            0.00 KB/sec
Aggregate data transfer rate:          0.00 KB/sec
Objects compressed by:                 0%
Elapsed processing time:                00:00:02
```

**Windows** | **Task**

**Windows** The following example displays the verbose and statistics output from the set event command `set event type=hold \\user\c$\tsm521\debug\bin\winnt_unicode\dsm.opt`, with objects rebound (as opposed to archived or some other notation).

```
Rebinding--> 274 \\user\c$\tsm521\debug\
  bin\winnt_unicode\dsm.opt
Rebinding--> 290 \\user\c$\tsm521\debug\
  bin\winnt_unicode\dsm.opt

Total number of objects inspected:      2
Total number of objects archived:       0
Total number of objects updated:        0
Total number of objects rebound:       2
Total number of objects deleted:        0
Total number of objects expired:        0
Total number of objects failed:         0
Total number of bytes transferred:     0 B
Data transfer time:                    0.00 sec
Network data transfer rate:            0.00 KB/sec
Aggregate data transfer rate:          0.00 KB/sec
Objects compressed by:                 0%
Elapsed processing time:                00:00:02
```

**AIX** | **Linux** | **Solaris** | **Mac OS X** | **Task**

**AIX** | **Linux** | **Solaris** | **Mac OS X** The `-pick` option used with the set event command `set event type=activate /user/tsm521/common/unix` shows the event type instead of the command name:

```
Scrollable PICK Window - Retention Event : ACTIVATE

#   Archive Date/Time      File Size  File
-----
1. | 08/05/2003 08:47:46   766 B     /user/tsm521
   |                               /common/unix
2. | 08/01/2003 10:38:11   766 B     /user/tsm521
   |                               /common/unix
3. | 08/05/2003 08:47:46   5.79 KB   /user/tsm521
   |                               /common/unix
4. | 08/01/2003 10:38:11   5.79 KB   /user/tsm521
   |                               /common/unix
5. | 08/05/2003 08:47:46  10.18 KB  /user/tsm521
   |                               /common/unix
```

**Windows** | **Task**

**Windows** The `-pick` option used with the set event command `set event type=activate \\user\c$\tsm521\common\winnt` shows the event type instead of the command name:

```
Scrollable PICK Window - Retention Event : ACTIVATE
```

#	Archive Date/Time	File Size	File
1.	08/05/2003 08:47:46	766 B	\\user\c\$\tsm521 \common\winnt
2.	08/01/2003 10:38:11	766 B	\\user\c\$\tsm521 \common\winnt
3.	08/05/2003 08:47:46	5.79 KB	\\user\c\$\tsm521 \common\winnt
4.	08/01/2003 10:38:11	5.79 KB	\\user\c\$\tsm521 \common\winnt
5.	08/05/2003 08:47:46	10.18 KB	\\user\c\$\tsm521 \common\winnt

Linux Windows

## Set Netappsvm

The `set netappsvm` command associates the logon credentials for a cluster management server, which are specified on the `set password` command, with a NetApp storage virtual machine, and the data storage virtual machine (SVM) name (data Vserver). You must enter this command before you can create a snapshot difference incremental backup of a clustered NetApp volume.

This command is typically entered only once. The parameters are stored and are reused the next time that you backup a clustered volume that is managed by the storage virtual machine. If you move an storage virtual machine to another cluster management server, you must reenter this command and specify the new cluster management server. If necessary, change the login credentials by using the `set password` command.

## Supported clients

**Linux** This command is valid for Linux backup-archive clients that complete snapshot difference backups of clustered-data ONTAP-c-mode file-server volumes.

**Windows** This command is valid for Windows clients that perform snapshot difference backups of clustered-data ONTAP-c-mode file-server volumes.

## Syntax

```
>>-SET NETAPPSVM--+-svm_hostname--cms_hostname-- svm_name+----><
'- -remove--svm_hostname-----'
```

## Parameters

### *svm\_hostname*

Specifies the host name or IP address of the storage virtual machine that manages the volumes and logical interfaces (LIFs), for the volumes that you want to protect.

### *cms\_hostname*

Specifies the host name or IP address of the cluster management server. Specify the same host name that you specified for this cluster management server when you used the `set password` command to establish the login credentials.

### *svm\_name*

Specifies the name of the data SVM that manages the mounted volume. Contact the NetApp SVM administrator to obtain the data SVM name that is assigned to the virtual machine.

### *-remove svm\_hostname*

Disassociates the SVM from the cluster management server that it was previously associated with. Specify a SVM host-name

You can specify this parameter if you accidentally associated a storage virtual machine with a 7-mode file server. If you remove a 7-mode file server and then associate a cluster management server, set the logon credentials for the cluster management server by using the `set password` command.

## Examples

Configure the credentials and access to a storage virtual machine:



```
set netappsvm svm_example.com cms_filer1.example.com svm_2
dsmc set password cms_filer1.example.com user_name password
```

Remove the associations that were created for the storage virtual machine:

```
set netappsvm -remove svm_example.com
```

### Related tasks:

Protecting clustered-data ONTAP NetApp file server volumes

[AIX](#) | [Linux](#) | [Mac OS X](#) | [Solaris](#) | [Windows](#)

## Set Password

---

The set password command changes the IBM Spectrum Protect™ password for your workstation, or sets the credentials that are used to access another server.

If you omit the old and new passwords when you enter the set password command, you are prompted once for the old password and twice for the new password.

Passwords can be up to 63 character in length. Password constraints vary, depending on where the passwords are stored and managed, and depending on the version of the IBM Spectrum Protect server that your client connects to.

If your IBM Spectrum Protect server is at version 6.3.3 or later, and if you use an LDAP directory server to authenticate passwords Use any of the following characters to create a password:

```
a b c d e f g h i j k l m n o p q r s t u v w x y z
A B C D E F G H I J K L M N O P Q R S T U V W X Y Z
0 1 2 3 4 5 6 7 8 9 . ! @ # $ % ^ & * _ - + = ` ( )
| { } [ ] : ; < > , ? / ~
```

Passwords are case-sensitive and are subject to more restrictions that can be imposed by LDAP policies.

If your IBM Spectrum Protect server is at version 6.3.3 or later, and if you do not use an LDAP directory server to authenticate passwords

Use any of the following characters to create a password:

```
a b c d e f g h i j k l m n o p q r s t u v w x y z
A B C D E F G H I J K L M N O P Q R S T U V W X Y Z
0 1 2 3 4 5 6 7 8 9 . ! @ # $ % ^ & * _ - + = ` ( )
| { } [ ] : ; < > , ? / ~
```

Passwords are stored in the IBM Spectrum Protect server database and are not case-sensitive.

If your IBM Spectrum Protect server is earlier than version 6.3.3

Use any of the following characters to create a password:

```
a b c d e f g h i j k l m n o p q r s t u v w x y z
A B C D E F G H I J K L M N O P Q R S T U V W X Y Z
0 1 2 3 4 5 6 7 8 9
_ - & + .
```

Passwords are stored in the IBM Spectrum Protect server database and are not case-sensitive.

[AIX](#) | [Linux](#) | [Mac OS X](#) | [Solaris](#) | [Windows](#) Remember:

On the command line, enclose all parameters that contain one or more special characters in quotation marks. Without quotation marks, the special characters can be interpreted as shell escape characters, file redirection characters, or other characters that have significance to the operating system.

### Windows

On Windows systems:

Enclose the command parameters in quotation marks (").

Command line example:

```
dsmc set password "t67@#$%^&" "pass2<>w0rd"
```

[AIX](#) | [Linux](#) | [Solaris](#)

On AIX®, Linux, and Solaris systems:

Enclose the command parameters in single quotation marks (').

Command line example:

```
dsmc set password -type=vmguest 'Win 2012 SQL' 'tsml2dag\administrator' '7@#$$^&7'
```

Quotation marks are not required when you type a password with special characters in an options file.

## Supported Clients

---

This command is valid for all clients.

The following parameters apply to VMware operations, which are available only if you are using the client as a data mover for IBM Spectrum Protect for Virtual Environments: Data Protection for VMware.

- TYPE=DOMAIN
- TYPE=VM
- TYPE=VMGUEST

## Syntax

---

```
>>-SET Password--+-+-----+-----+----->
                    '-oldpw--newpw-'
>--+-+-----+-----+----->
    '-otherserver--otheruserid--otherpassword-'
. -TYPE=TSM-----
>--+-+-----+-----><
    +-TYPE=DOMAIN-----+
    +-TYPE=FASTBack-----+
    +-TYPE=FILER-----+
    +-TYPE=VM-----+
    '-TYPE=VMGUEST ALLVM-'
```

## Parameters

---

**oldpw**

Specifies the current password for your workstation.

**newpw**

Specifies the new password for your workstation.

**other\_server other\_user\_id other\_password**

These three parameters specify the attributes that the client uses to access another server, such as a filer or an ESXi host.

**other\_server**

Specifies the host name or IP address of the server that the client can access to protect files.

**other\_user\_id**

The user ID of an account on the server that the client uses to log on to the other server. The account must have the privileges that are necessary to perform the operations that are run after the user is logged on to the other server.

**other\_password**

The password that is associated with the user ID on the other server.

**TYPE**

Specifies whether this password is for the backup-archive client or for another type of server.

Use **TYPE=TSM** to specify the password for your backup-archive client. The default type is **TYPE=TSM**.

**Windows** Use **TYPE=DOMAIN** to set the Windows domain administrator credentials to enable users to log in to a remote Windows proxy node (the file restore interface), for file restore operations. This option requires a license for IBM Spectrum Protect for Virtual Environments: Data Protection for VMware.

Use the following format for the set password -type=domain command:

```
set password -type=domain -validate administrator_name password
```

where:

## VALidate

Validates the Windows domain administrator credentials before the credentials are stored. If the validation fails, the credentials are not stored, and users are not able to log in to the file restore interface. The validate parameter is valid only with the `TYPE=DOMAIN` parameter.

### *administrator\_name*

Specifies the account name of a domain administrator. The account name must contain the Windows domain name and the administrator ID. The account name must be in the following format:

```
domain_name\administrator_ID
```

### *password*

Specifies the password that is associated with the specified domain administrator account.

For more information about configuration requirements for remote mount proxy nodes, see the IBM Spectrum Protect for Virtual Environments: Data Protection for VMware documentation.

## Linux | Windows

Use `TYPE=FastBack`, on Linux and Windows clients, to store the Tivoli® Storage Manager FastBack credentials that are required for mounting and dismounting the FastBack volumes on the Windows FastBack Disaster Recovery Hub server.

The password file on the vStorage backup server must have either the Windows administrator ID for the VMware virtual center system, or the UNIX user ID for a specific ESX server. For a proxy backup for FastBack, the password file must contain the FastBack administrator ID and password. Here are some examples:

```
dsmc set password 192.0.2.24 admin admin 123 -type=fastback
```

```
dsmc set password 192.0.2.24 WORKGROUP:admin admin 123 -type=fastback
```

```
dsmc set password windserv administrator windpass4 -type=fastback
```

Important: You must define the user credentials that are required to mount and unmount FastBack volumes from a repository to the backup-archive client before you enter the backup-archive FastBack subcommand. Use the `fbserver` option to define the credentials.

Here is a brief description of the various configurations and credentials that you need:

- The backup-archive client is installed on a dedicated vStorage backup server. The client on the vStorage backup server must connect to multiple network share repositories.

Follow these steps for each of the network share repositories where the client is connected:

1. Configure the repository for remote network access from FastBack Manager. Refer to the Tivoli Storage Manager FastBack product documentation on IBM® Knowledge Center at <http://www.ibm.com/support/knowledgecenter/SS9NU9/welcome>.

This step establishes a domain name, a network share user ID, and a network share password to connect remotely to the repository.

2. On the backup-archive client workstation, manually enter the following command:

```
dsmc set password type=fastback FBServer domain:networkaccessuserid  
networkaccesspassword
```

The `fbserver` option specifies the short host name of the FastBack server workstation. For the FastBack DR Hub, the `fbserver` option specifies the short name of the workstation where the DR Hub is installed.

*Networkaccessuserid* is either the Windows administrator ID or the FastBack administration password.

*Domain* is the domain name of the user ID.

*Networkaccesspassword* is either the Windows administrator ID or the FastBack administration password.

3. These credentials are retrieved based on the short host name that you specify with the `fbserver` option.

## Linux | Windows

Use `TYPE=FILER`, on Linux and Windows systems to specify that this password is for snapshot difference operations on a file server.

For `TYPE=FILER`, you must specify a file server name, and the user ID and the password that is used to access the file server. For example: `dsmc set password -type=filer myfiler filerid filerpasswd.`

When you specify `TYPE=FILER`, the password is stored in the password (TSM.sth) file without validating that the password is valid. Passwords that are stored with `TYPE=FILER` can be shared between client nodes. For example, a password that is stored by `NODE_A` can be used by `NODE_B`. Only one set of credentials is stored per file server.

Linux | Windows

Use `TYPE=VM` to set the password that is used to log on to an ESX or vCenter server.

```
dsmc SET PASSWORD -type=VM hostname administrator password
```

where:

*hostname*

Specifies the VMware VirtualCenter or ESX server that you want to back up, restore, or query. This host name must match the host name syntax that is used in the `vmchost` option. That is, if `vmchost` uses an IP address instead of a host name, this command must provide the IP address, and not a short host name or a fully qualified host name.

*administrator*

Specifies the account that is needed to log on to the vCenter or ESXi host.

*password*

Specifies the password that is associated with the login account that you specified for the vCenter or ESXi administrator.

Use the Preferences editor to set the `vmchost`, `vmcuser`, and `vmcpw` options.

You can also set the `vmchost` option in the client options file and then use the `set password` command to associate that host name with the administrator account and the administrative account password that is used to log on to that host. For example, `set password TYPE=VM myvmchost.example.com administrator_name administrator_password.`

Linux | Windows

Use `TYPE=VMGUEST`, on Linux and Windows clients, if you use the `INCLUDE.VMTSMVSS` option to protect a virtual machine. Use the following format for the `set password` command:

```
set password -type=vmguest guest_VM_name administrator password
```

where:

*guest\_VM\_name*

Specifies the name of the virtual machine guest that you want to protect.

*administrator*

Specifies the account that is needed to log on to the guest VM.

*password*

Specifies the password that is associated with the login account.

If you use the same credentials to log on to multiple virtual machines that are protected by the `INCLUDE.VMTSMVSS` option, you can set the password for the all of the virtual machines by specifying the `ALLVM` parameter. The `ALLVM` parameter causes the same credentials to be used when the client logs on to any guest that is included in an `INCLUDE.VMTSMVSS` option. The following command `TYPE=TSM` is an example of how to use `ALLVM`. In this example, the user name "Administrator" and the password "Password" are used to log on to any virtual machine that you included on an `INCLUDE.VMTSMVSS` option:

```
set password -type=vmguest ALLVM Administrator Password
```

You can also set a combination of shared and individual credentials. For example, if most virtual machines in your environment use the same credentials, but a few virtual machines use different credentials, you can use multiple `set password` commands to specify the credentials. For example, assume that most virtual machines use "Administrator1" as the login name and "Password1" as the password. Assume also that one virtual machine, named VM2, uses "Administrator2" as the login name and "Password2" as the password. The following commands are used to set the credentials for this scenario:

- `set password -type=vmguest ALLVM Administrator1 Password1` (sets credentials for most of the VMs).
- `set password -type=vmguest VM2 Administrator2 Password2` (sets unique credentials for VM2).

## Examples

The following examples use the set password command.

**AIX** | **Linux** | **Mac OS X** | **Solaris** | **Windows** **Task**

**AIX** | **Linux** | **Mac OS X** | **Solaris** | **Windows** Change your password from `osecret` to `nsecret`.

```
set password osecret nsecret
```

**AIX** | **Linux** | **Solaris** | **Mac OS X** | **Windows** **Task**

**AIX** | **Linux** | **Solaris** | **Mac OS X** | **Windows** Set up a user ID and password for the root user on the file server `myFiler.example.com`.

```
dsmc set password -type=filer myFiler.example.com root
```

```
Please enter password for user id "root@myFiler.example.com": ***** Re-enter the password for verification:***** ANS0302I Successfully done.
```

**AIX** | **Linux** | **Solaris** | **Mac OS X** | **Windows** **Task**

**AIX** | **Linux** | **Solaris** | **Mac OS X** | **Windows** Set up a user ID and password for the root user on the file server `myFiler.example.com`.

```
dsmc set password -type=filer myFiler.example.com root secret
```

**Linux** | **Windows** **Task**

**Linux** | **Windows** Set up a user ID and password for the FastBack server `myFastBackServer`. Use the `-fbserver` option in the archive fastback and backup fastback commands for the server name.

```
Linux dsmc set password -type=FASTBack myFastBackServer myUserId 'pa$word' Windows dsmc set password -type=FASTBack myFastBackServer myUserId "pa$word"
```

Important:

1. The `dsmc set password -type=fastback` command must be repeated on a dedicated client proxy workstation once for each FastBack repository where the backup-archive client is expected to connect.
2. For network share repositories, issue the `dsmc set password -type=fastback` command in this format: `dsmc set password -type=fastback myFBServer domainName:userId password`.

The server name that is specified, which is `myFBServer` in this example, must match the name that you specify on the `-fbserver` option on a backup fastback or archive fastback command.

3. For the FastBack server or the FastBack Disaster Recovery Hub, the user ID and password that are specified must have FastBack administrator privileges. You must issue the `dsmc set password -type=fastback` command once for each FastBack Server branch repository on the FastBack DR Hub that the backup-archive client is expected to connect to.

**Linux** **Task**

**Linux** The backup-archive client is connecting to the FastBack server repository whose short host name is `myFBServer`. `user ID` is the FastBack network user ID that has read/write access to the repository share. `DOMAIN` is the domain to which the user ID belongs. `myNetworkPass` is the corresponding password for the user ID.

```
dsmc set password -type=fastback myFbServer DOMAIN:USERID myNetworkPass
```

**Linux** **Task**

**Linux** The backup-archive client is connecting to a repository on a DR Hub machine whose short host name is `myFbDrHub`. The user ID is the Windows administrator ID. `DOMAIN` is the domain to which the DR Hub machine belongs. `myNetworkPass` is the corresponding password for the administrator ID.

```
dsmc set password -type=fastback myFbDrHub DOMAIN:administrator adminPasswd
```

**Windows** **Task**

**Windows** Set up the Windows domain administrator credentials that are necessary for users to log in to the file restore interface and save the Windows domain credentials. In this example, the Windows domain in which all user accounts are registered is called `example_domain`. `Kev_the_admin` is the Windows domain administrator ID and `pas$word!` is the corresponding password for the administrator.

```
dsmc set password -type=domain -val "example_domain\Kev_the_admin" "pas$word!"
```

**Linux** | **Windows**

## Set Vmtags

---

The set vmtags command creates data protection tags and categories that can be added to VMware inventory objects. You can manage IBM Spectrum Protect™ backups of virtual machines in these VMware objects by specifying the tags with tools such as VMware vSphere PowerCLI Version 5.5 R2 or later.

 This feature is available only if the client operates as a data mover for IBM Spectrum Protect for Virtual Environments: Data Protection for VMware.

If you are using the IBM Spectrum Protect vSphere Client plug-in to manage backups, you do not need to run the set vmtags command first. The tags and categories are created for you.

If you are writing scripts to apply these tags to VMware inventory objects, you need only to issue the set vmtags command once so that data protection tags are created before they are added to the VMware inventory.

You can manage virtual machine backups at the following VMware inventory object levels:

- Datacenter
- Folder (Host and Cluster folders and VM and Template folders)
- Host
- Host cluster
- Resource pool
- Virtual machine

For the list of supported tags, see "Supported data protection tags."

For tags that are related to schedules, the virtual machines must be in a protection set that is protected by a schedule. A protection set consists of the virtual machines in a container that is assigned the `Schedule (IBM Spectrum Protect)` tag.

After running the set vmtags command, you can assign the tags to VMware objects to manage the protection of virtual machines. For example, you can exclude or include virtual machines in scheduled backup services, specify the retention policy for backups, set the data consistency of snapshots, or select the virtual machine disks to protect.

If the data protection tags already exist, running the set vmtags command does not create the tags again.

If you are upgrading from a previous version of the data mover, running the set vmtags command again will create any new tags that are available in the new version of the data mover.

Requirements: Before you run the set vmtags command, ensure that the following requirements are met:

- VMware vCenter Server must be at Version 6.0 Update 1 or later.
- The vmchost option must be configured in the dsm.opt file on Windows data movers or dsm.sys file on Linux data movers. The user name and password that are associated with the vmchost value must also be set. If not already set, you can use the dsmc set password command to set the user name and password.

## Supported clients

---

**Linux** This command is valid only on supported Linux x86\_64 clients that are installed on a vStorage backup server that protects VMware assets.

**Windows** This command is valid on supported Windows 64-bit clients that are installed on a vStorage backup server that protects VMware assets.

## Syntax

---

```
>>--SET VMTAGS----->>
```

## Parameters

---

No parameters are required for this command.

## Examples

---

## Task

Create data protection tags and categories that can be added to VMware inventory objects:

```
dsmc set vmtags
```

- **Linux** | **Windows** **Data protection tagging overview**  
To manage data protection of virtual machines, you can assign IBM Spectrum Protect tags to VMware inventory objects. You can assign tags to VMware objects by specifying data protection settings in the IBM Spectrum Protect vSphere Client plug-in of the vSphere Web Client. If you do not use the IBM Spectrum Protect vSphere Client plug-in, you can assign tags by using scripting tools such as VMware Power CLI.

### Related concepts:

Management classes and copy groups

### Related reference:

Supported data protection tags

Vmchost

Vmtagdatamover

Set Password

**Windows**

## IBM Spectrum Protect Client Service Configuration Utility

---

The following client services can be installed when you install the backup-archive client, or when you use the IBM Spectrum Protect™ Client Service Configuration Utility after the backup-archive client is installed:

- Backup-Archive Scheduler Service
- Client Acceptor Service
- Remote Client Agent Service
- Journal Engine Service

For more information about using the IBM Spectrum Protect Client Service Configuration Utility to install client services, see the related information about using the dsmcutil command.

- **Windows** **Install the backup-archive scheduler service**  
You can use either the backup-archive client GUI or the IBM Spectrum Protect Client Service Configuration Utility to install the scheduler.
- **Windows** **dsmcutil command**

The IBM Spectrum Protect Client Service Configuration Utility, dsmcutil, can be used to install backup-archive client services on local and remote Windows workstations.

### Related concepts:

dsmcutil command

**Windows**

## Install the backup-archive scheduler service

---

You can use either the backup-archive client GUI or the IBM Spectrum Protect™ Client Service Configuration Utility to install the scheduler.

### About this task

---

- From the backup-archive client GUI, click Utilities, and then click Setup Wizard. Select the Help me configure the Client Scheduler option.
- If you have an account that belongs to the Administrator/Domain Administrator group, you can use the IBM Spectrum Protect Client Service Configuration Utility to configure client services on both local and remote Windows workstations.
- **Windows** **Using the Client Service Configuration Utility (Windows)**  
This section provides the steps for using the Client Service Configuration Utility to automate backups, manage existing scheduler services, create a new scheduler, and associate a client acceptor to manage the scheduler.

**Windows**

## dsmcutil command

---

The IBM Spectrum Protect™ Client Service Configuration Utility, `dsmcutil`, can be used to install backup-archive client services on local and remote Windows workstations.

You can use the `dsmcutil` command to install the following client services:

- Backup-Archive Scheduler Service
- Client Acceptor Service
- Remote Client Agent Service
- Journal Engine Service

The Client Service Configuration Utility must be run from an account that belongs to the Administrator/Domain Administrator group. The syntax for the command is as shown in the following text:

```
                .-SCHEDuler---.
>>-dsmcutil-- --command--+service-----+-----><
                +-CAD-----+
                +-JOURnal-----+
                '-REMOTEagent-'
```

Note: Options that you specify with `dsmcutil` commands override option that you specify in your options file (`dsm.opt`).

The account that runs the utility must have the appropriate user rights for installing services and updating the Windows Registry on the target workstation.

If a remote workstation is specified, the account must be authorized to connect to the Windows Registry of the specified workstation.

Note: For the commands and options that are documented here, the minimum abbreviation that you can type is shown in uppercase letters.

- **Windows** Dsmcutil commands: Required options and examples  
Reference information for the `dsmcutil` commands and examples are provided.
- **Windows** Dsmcutil valid options  
This section lists the valid **dsmcutil** options that you can specify to use the scheduler service.

#### Related concepts:

Configure the IBM Spectrum Protect client

**Windows**

## Dsmcutil commands: Required options and examples

---

Reference information for the `dsmcutil` commands and examples are provided.

The `INSTall` command installs and configures backup-archive client services.

### INSTall Scheduler

---

Installs and configures the IBM Spectrum Protect™ Scheduler Service.

These are the required `INSTall` command options:

- `/name:service_name`
- `/password:password`
- `/clusternode:Yes | No` (required if running the Microsoft Cluster Server (MSCS) or Veritas Cluster Server (VCS)).
- `/clustername:cluster_name` (required if running the MSCS or VCS).

Restriction: Do not specify a clustername of more than 64 characters. If you specify more than 64 characters and you are using Veritas Storage Foundation with High Availability or a Microsoft Cluster Server configuration, you might not be able to install or start the scheduler service.

The `/clientdir:client_dir` option can also be used, the default is the current directory.

The following files must exist in the directory specified by `client_dir`:

- `dsmcsvc.exe`



- dscenu.txt
- dsm.opt
- dsmntapi.dll
- tsmutil1.dll

Note: If the service is being installed on a remote workstation, the fully qualified client directory path should be relative to the target workstation. UNC names are not allowed for the local system account. Multiple services can be installed on the same workstation.

Tip: In the commands that are provided in the following examples, the default location of the client installation program (c:\program files\tivoli\tsm\baclient) is used. If you installed the client to a different location, replace the default path with your custom installation path. If the path contains a space, enclose the path in double quotation marks (for example, "c:\program files\tivoli\tsm\baclient").

#### Task

Install a scheduler service that is named `TSM Central Scheduler Service` on the local workstation. Start the service automatically at system boot time. All required files must reside in the current directory and the client options file must point to the IBM Spectrum Protect server where node `ALPHA1` is defined with password `nodepw`. The server is contacted to verify that the specified node and password are valid. When the password is validated it is generated (encrypted) into the password store:

#### Command:

```
dsmcutil install scheduler /name:"TSM Central Scheduler Service"
/node:ALPHA1 /password:nodepw /autostart:yes
```

#### Task

Install a scheduler service named `TSM Central Scheduler Service` on remote workstation PDC. Start the service automatically at system boot time. The required scheduler service files and the specified options file must reside on the remote workstation in the `c:\program files\tivoli\tsm\baclient` directory. The password is encrypted into the password store. The IBM Spectrum Protect server is not contacted to validate the password.

#### Command:

```
dsmcutil install scheduler /name:"TSM Central Scheduler Service"
/machine:PDC /clientdir:"c:\program files\tivoli\tsm\baclient"
/optfile:"c:\program files\tivoli\tsm\baclient\dsm.opt"
/node:PDC /validate:no /autostart:yes /password:nodepassword
```

#### Task

Install a scheduler service named `TSM Central Scheduler Service` on remote workstation PDC. Start the service automatically at system boot time. The required scheduler service files and the specified options file must reside on the remote workstation in the `c:\program files\tivoli\tsm\baclient` directory. The password is encrypted into the password store. The IBM Spectrum Protect server residing at the specified TCP/IP host and port is contacted to validate the password.

#### Command:

```
dsmcutil install scheduler /name:"TSM Central Scheduler Service"
/machine:PDC /clientdir:"c:\program files\tivoli\tsm\baclient"
/optfile:"c:\program files\tivoli\tsm\baclient\dsm.opt"
/node:PDC /autostart:yes /password:nodepassword
/commmethod:tcpip /commserver:alpha1.example.com
/commport:1521
```

#### Task

Install the `TSM Central Scheduler Service` on one node of a MSCS (or VCS) cluster. For *group-a* from workstation *node-1*, ensure that *node-1* currently owns *group-a* and then issue the following command.

#### Command:

#### Command:

```
dsmcutil install scheduler /name:"TSM Central Scheduler Service:
group-a" /clientdir:"c:\program files\tivoli\tsm\baclient"
/optfile:"c:\program files\tivoli\tsm\baclient\dsm.opt"
/node:mscs-cluster-group-a /password:n
/validate:no /autostart:yes /startnow:yes
/clustername:yes /clusternode:mscs-cluster
```

Installs and configures the Client Acceptor Service. Required options are:

- /name:service\_name
- /node:node\_name
- /password:password

Other valid options are:

- /optfile:options\_file
- /httpport:http\_port
- /webports:web\_ports

#### Task

Install a Client Acceptor Service called `TSM CAD`. The client acceptor uses a node called `test` to connect to the IBM Spectrum Protect server. Use the options file `c:\program files\tivoli\tsm\baclient\dsm.opt` to connect to the server.

#### Command:

```
dsmcutil install cad /name:"TSM CAD" /node:test /password:test /optfile:"c:\program files\tivoli\tsm\baclient\dsm.opt"
```

## INSTall Journal

---

Installs a journaling engine service on all Windows clients. A journal database is created that stores information the client uses to determine which files are eligible for backup before an operation starts.

If necessary, you can use the `nojournal` option with the incremental command to specify that you want to perform a traditional full incremental backup.

The journaling engine service is named `TSM Journal Service` and uses the configuration file `tsmjbbd.ini` from the backup-archive client installation directory.

Note: The Journal Service is supported in a Microsoft Cluster Server environment. Multiple journal services can be installed by specifying unique pipe names using the `JournalPipe` journal config setting and client options.

There are no valid options for this command.

#### Task

Install the journal engine service (`TSM Journal Service`).

#### Command:

```
dsmcutil install journal
```

## INSTall REMOTEAgent

---

Installs and configures a Remote Client Agent Service. Required options are:

- /name:service\_name
- /node:node\_name
- /password:password
- /partnername:partner\_service\_name

Other valid options are:

- /optfile:options\_file

#### Task

Install a Remote Client Agent Service called `TSM AGENT`. The remote client agent uses a node called `test` to connect to the IBM Spectrum Protect server. The options file `c:\program files\tivoli\tsm\baclient\dsm.opt` is used to connect to. The partner client acceptor service is `TSM CAD`.

#### Command:

```
dsmcutil install remoteagent /name:"TSM AGENT" /node:test /password:test /optfile:"c:\program files\tivoli\tsm\baclient\dsm.opt" /partnername:"TSM CAD"
```

Note: Both the Remote Client Agent Service and the Client Acceptor Service must be installed to run the web client. The Client Acceptor Service must be installed before the Remote Client Agent Service. Use the /partername: option to specify the name of the partner Client Acceptor Service.

## REMove

---

Remove an installed Client Service. The required option is /name:service\_name.

### Task

Remove the specified scheduler service from the local workstation.

**Command:**

```
dsmcutil remove /name:"TSM Central Scheduler Service"
```

### Task

Remove the journaling engine service (TSM Journal Service) from the local workstation.

**Command:**

```
dsmcutil remove /name:"TSM Journal Service"
```

## UPDate

---

Updates Scheduler Service registry values. The required option for this command is /name:service\_name, and the registry values to update. Other valid options are:

- /clientdir:client\_dir
- /optfile::options\_file
- /eventlogging:Yes | No
- /node:node\_name
- /autostart:Yes | No
- /clusternode:Yes | No (required if running the MSCS or VCS).
- /clustername:cluster\_name (required if running the MSCS or VCS).

### Task

Update the client directory and options file for the specified scheduler service. All required client service files must reside in the specified directory.

Note: The communication options specified with the dsmcutil command here take precedence over those specified in the client options file.

**Command:**

```
dsmcutil update /name:"TSM Central Scheduler Service"  
/clientdir:"c:\program files\tivoli\tsm\baclient"  
/optfile:"c:\program files\tivoli\tsm\baclient\dsm.opt"
```

### Task

Update the specified scheduler service to use the TCP/IP protocol to connect to the IBM Spectrum Protect server at the specified host name on the specified port.

**Command:**

```
dsmcutil update /name:"TSM Central Scheduler Service"  
/commserver:ntl.example.com /commport:1521 /commmethod:  
tcpip
```

## UPDate CAD

---

Updates Client Acceptor Service registry values. The required option for this command is /name:service\_name, and the registry values to update. Other valid options are:

- /node:node\_name
- /password:password
- /optfile:options\_file
- /httpport:http\_port
- /webports:web\_ports
- /cadschedname:scheduler\_name

### Task

Update the Client Acceptor Service to use the specified client password and options file. All required client service files must reside in the specified directory.

**Command:**

```
dsmcutil update cad /name:"TSM CAD" /password:test  
/optfile:"c:\program files\tivoli\tsm\baclient\dsm.opt"
```

## UPDate REMOTEAgent

---

Updates Remote Client Agent Service registry values. The required option for this command is `/name:service_name`, and the registry values to update. Other valid options are:

- `/node:node_name`
- `/password:password`
- `/optfile:options_file`
- `/partnername:partner_service_name`

**Task**

Update a Remote Client Agent Service called TSM AGENT. The remote client agent service uses a node called `test` to connect to the IBM Spectrum Protect server. The options file `c:\program files\tivoli\tsm\baclient\dsm.opt` is used to connect to the server. The partner client acceptor service is TSM CAD.

**Command:**

```
dsmcutil update remoteagent /name:"TSM AGENT" /node:test  
/password:test /optfile:"c:\program files\tivoli\tsm\baclient\dsm.opt"  
/partnername:"TSM CAD"
```

## Query Scheduler

---

Query Scheduler Service registry values. Required options are: `/name:service_name`. Other valid options are:

- `/machine:machine_name`
- `/clientdir`
- `/optfile`
- `/eventlogging`
- `/node`
- `/commmethod`
- `/commport`
- `/commsserver`
- `/errorlog`
- `/schedlog`

Note: Do not specify a value for the non-required options. The client returns option registry values for the scheduler service you specify.

**Task**

Query registry settings for the scheduler service you specify.

**Command:**

```
dsmcutil query /name:"TSM Central Scheduler Service"
```

**Task**

Query the client directory registry setting for the scheduler service you specify.

**Command:**

```
dsmcutil query /name:"TSM Central Scheduler Service"
```

## Query CAD

---

Queries Client Acceptor Service registry values. The required option for this command is `/name:service_name`. Other valid options are:

- `/machine:machine_name`
- `/node`
- `/optfile`

- /httpport
- /webports
- /clientdir
- /partnername

Note: Do not specify a value for these options.

Task

Query registry settings for the Client Acceptor Service you specify.

**Command:**

```
dsmcutil query cad /name:"TSM CAD"
```

## Query Journal

---

Query the journaling engine service, *TSM Journal Service*, on a Windows system. There are no valid options for this command.

Task

Query the journaling engine service, *TSM Journal Service*.

**Command:**

```
dsmcutil query journal
```

## Query REMOTEAgent

---

Queries Remote Client Agent Service registry values. The required option for this command is */name:service\_name*. Other valid options are:

- */machine:machine\_name*
- */node*
- */optfile*
- */partnername*
- */clientdir*

Note: Do not specify a value for these options.

Task

Query registry settings for the specified Remote Client Agent Service.

**Command:**

```
dsmcutil query remoteagent /name:"TSM AGENT"
```

## List

---

Lists installed Client Services. There are no required options.

Task

Locate and list the installed backup-archive client services on the local workstation.

**Command:**

```
dsmcutil list
```

Task

List the installed backup-archive client services on remote workstation PDC.

**Command:**

```
dsmcutil list /MACHINE:PDC
```

## START

---

Use the Start command to start a client service. The Start command requires the */name:service\_name* option.

Task

Start the journaling engine service, *TSM Journal Service*.

**Command:**

```
dsmcutil start /name:"TSM Journal Service"
```

## STOP

---

Use the Stop command to stop a client service. The Stop command requires the `/name:service_name` option.

### Task

Stop the journaling engine service, TSM Journal Service.

#### Command:

```
dsmcutil stop /name:"TSM Journal Service"
```

## UPDATEPW

---

Generate an encrypted IBM Spectrum Protect password. The UPDATEPW command requires the `/node:node_name`, `/password:password`, and `/commserver:server_name` options. If the `clusternode` option is set to YES, the `/optfile:` parameter is also required.

Optionally, you can use the following options:

- `/validate:Yes | No`
- `/clusternode:Yes | No` (required if running the MSCS or VCS).
- `/clustername:cluster_name` (required if running the MSCS or VCS).
- `/force:Yes | No`
- `/optfile:` (for non-cluster operations)
- `/commmethod:`
- `/commport:`

The password is validated with the IBM Spectrum Protect server if `/validate:Yes` is specified. The password is updated on the server if you specify `/updateonserver:Yes`. If you specify this option, you must specify the current password with the `/oldpassword:` option.

### Task

Update the encrypted password for the specified node. Validate and update the password on the specified IBM Spectrum Protect server which resides on the specified TCP/IP hostname and port:

#### Command:

```
dsmcutil updatepw /node:alpha1 /commMethod:tcpip  
/commServer:alpha1.example.com /commPort:1500  
/password:newpw /oldpassword:oldpw /updateonserver:yes  
/validate:yes /optfile:"c:\program files\tivoli\tsm\baclient\dsm.opt"
```

## ADDACE

---

Grants access to the IBM Spectrum Protect backup-archive client password and the client SSL certificates for non-administrators.

Beginning with IBM Spectrum Protect Version 8.1.2, stricter access control is enforced for the IBM Spectrum Protect password storage on Windows operating systems. By default, only the Administrator, SYSTEM, or LocalSystem account has access to the password store and SSL certificates.

You can use the `addace` command to modify the access control list to allow additional users, such as non-administrative users, or processes such as the IBM Spectrum Protect Data Protection client processes to access the password store and SSL certificates.

The following options are required:

- `-entity:user | group`
- `-object:ALL | NODENAME | path\TSM.* | path\spclient.*`

Where:

`user | group`

The Windows user or user group that is given read/write access to the password store.

ALL

Grants access to all password files and SSL certificates in the subdirectories of the `C:\ProgramData\Tivoli\TSM\baclient` directory.

NODENAME

Grants access to all password files and SSL certificates that are found in the subdirectories of the C:\ProgramData\Tivoli\TSM\baclient\Nodes\*nodename* directory.

*path*\TSM.\* | *path*\spclient.\*

For cluster passwords that can exist on a shared resource directory, grants access to the password files or certificate files in a specific directory for a node.

For more information about the secure password locations on Windows, see Secure password storage.

Tip: The dsmcutil deleteace command revokes access to password files and SSL certificates.

#### Task

After you installed and configured the backup-archive client as Administrator, you need to give Susan, a non-administrative user on your Windows system, access to the password files and SSL certificates on the client node Alpha1.

#### Command:

```
dsmcutil addace -entity:Susan -object:Alpha1
```

#### Task

A non-administrative user of IBM Spectrum Protect for Databases: Data Protection for Microsoft SQL Server configured the IBM Spectrum Protect passwords but the administrator also needs access to the passwords. The Data Protection for Microsoft SQL Server user grants access to the password files to the administrator by issuing the following command:

#### Command:

```
dsmcutil addace -entity:Administrator -object:all
```

#### Task

During a cluster configuration, the Windows administrator needs to give the cluster node *clusnode\_A* access to the client SSL certificates.

#### Command:

```
dsmcutil addace -entity:Group_A  
-object:C:\ProgramData\Tivoli\TSM\baclient\Nodes\clusnode_A\spclient.*
```

If the client certificates are not in the default location (C:\ProgramData\Tivoli\TSM\baclient\Nodes\clusnode\_A\), they are located in the same directory as the dsm.opt file.

## DELETEACE

---

Revokes access to the IBM Spectrum Protect backup-archive client password and the client SSL certificates for non-administrators.

You can use the deleteace command to modify the access control list to remove access to the password store and client certificates for users, such as non-administrative users or processes such as the IBM Spectrum Protect Data Protection client processes.

The following options are required:

- **-entity:***user* | *group*
- **-object:**ALL | *NODENAME* | *path*\TSM.\* | *path*\spclient.\*

Where:

*user* | *group*

The Windows user or user group for which access to the password store and client certificates is removed.

ALL

Removes access to all password files and SSL certificates in the subdirectories of the C:\ProgramData\Tivoli\TSM\baclient directory.

*NODENAME*

Removes access to all password files and SSL certificates that are found in the subdirectories of the C:\ProgramData\Tivoli\TSM\baclient\Nodes\*nodename* directory.

*path*\TSM.\* | *path*\spclient.\*

For cluster passwords that can exist on a shared resource directory, removes access to the password files or certificate files in a specific directory for a node.

For more information about the secure password locations on Windows, see Secure password storage.

Tip: The dsmcutil addace command grants access to password files and SSL certificates.

#### Task

Susan, a non-administrative user, left the company two days ago and the administrator must revoke access to the password files and SSL certificates on the client node Alpha1.

**Command:**

```
dsmcutil deleteace -entity:Susan -object:Alpha1
```

**Task**

Cluster node `clusnode_Z` is moved out of the cluster configuration and no longer needs to access to the client SSL certificates. Issue the following command to remove access for `clusnode_Z`.

**Command:**

```
dsmcutil deleteace -entity:Group_Z  
-object:C:\ProgramData\Tivoli\TSM\baclient\Nodes\clusnode_Z\spclient.*
```

If the client certificates are not in the default location (`C:\ProgramData\Tivoli\TSM\baclient\Nodes\clusnode_Z\`), they are located in the same directory as the `dsm.opt` file.

**Related concepts:**

Journal-based backup

**Related tasks:**

Dsmcutil valid options

**Related reference:**

Incremental

Windows

## Dsmcutil valid options

---

This section lists the valid **dsmcutil** options that you can specify to use the scheduler service.

### About this task

---

***/autostart***: [Yes|No]

Specifies whether the Scheduler Service starts automatically at system boot time. The default is *No*.

***/cadschedname:schedulename***

Specifies the name of the scheduler service to manage with the client acceptor. Use this option when the ***managedservices*** option is set to *schedule* in the client options file `dsm.opt`. You can specify this option only with the client acceptor service.

***/clientdir***: clientdir

The fully qualified directory path where the Client Service files reside. This directory should be relative to the target workstation where the service is installed. UNC names are not allowed if the local system account is set to *logon*. The default is the current directory.

***/clustername***: clustername

This option replaces the ***/group*** option.

The ***/clustername*** option specifies the cluster name to which the system belongs. You can determine the cluster name in any of the following ways:

- On MSCS, run the MSCS command, `CLUSTER /LIST`, from the command line or use the Cluster Administrator utility. When the Cluster Administrator utility starts, it displays a tree-like structure with the cluster name at the top.
- On VCS, use the VCS Cluster Manager - Java™ Console or open the `main.cf` file in the `%VCS_HOME%\config` directory.
- On VCS, use the following command:

```
haclus -display
```

**Restriction:** Do not specify a clustername of more than 64 characters. If you specify more than 64 characters and you are using Veritas Storage Foundation with High Availability or a Microsoft Cluster Server configuration, you might not be able to install or start the IBM Spectrum Protect™ scheduler service.

This option must be used with the ***/clusternode:Yes*** option. This option must be specified when using the `INSTALL` command in a cluster environment. It must also be specified when using the `UPDATE` command to modify the cluster settings (***/clusternode*** and ***/clustername***).

This option can also be specified when using the `UPDATEPW` command in a cluster environment. Normally this is not required. However, if more than one scheduler service with different cluster settings are defined for a particular node, the utility cannot determine which settings are correct. In this case, correct the discrepancies between the services.



Alternatively, you can specify this option with **/clusternode:Yes** and **/force:Yes**, to force the utility to show or update the password with the specified cluster settings.

This option is not required if **/clusternode:No** is specified.

**/clusternode:Yes|No**

Specifies whether to enable support for cluster resources. The default value is *No*. You must be running the MSCS or VCS to specify **/clusternode:Yes**. This option must be specified when using the INSTALL command in a cluster environment. This option must also be specified when using the UPDATE command to modify the cluster settings (**/clusternode, /clustername**).

This option can also be specified when using the UPDATEPW command in a cluster environment. Normally this is not required. However, if more than one scheduler service with different cluster settings are defined for a particular node, the utility cannot determine which settings are correct. In this case, correct the discrepancies between the services.

Alternatively, you can specify this option with **/clustername** and **/force:Yes**, to force the utility to show or update the password with the specified cluster settings. If **/clusternode:No** is specified, **/clustername** is not required.

**/commmethod:protocol**

Specifies client communications protocol to communicate with the IBM Spectrum Protect server. Valid protocols are: TCP/IP and Named Pipes. If you do not specify a value, the value is obtained from the client options file or set to the default client value. You can also use this option with the UPDATEPW command to specify a communication protocol to connect to a server when updating passwords.

**/commport:serverport**

Specifies the protocol specific IBM Spectrum Protect server port. For TCP/IP, this is the port on the specified hostname. If this option is not specified, the value is obtained from the client options file or set to the default client value. You can also use this option with the UPDATEPW command to specify a protocol specific server port to connect to for updating passwords.

**/commserver:servername**

Specifies the protocol specific IBM Spectrum Protect server name. Depending on the protocol used, this can be a TCP/IP hostname or a Named Pipes name. If not specified, the value is obtained from the client options file or set to the default client value.

This option can also be used with the UPDATEPW command to specify a protocol specific server name to connect to for updating passwords.

**/copyfiles**

Specifies that the service installation is copied to another location prior to installing the service. Use the **/srcdir** option to specify the fully qualified source path.

**/errorlog:errorlog**

Specifies the fully qualified name of the client error log.

**/eventlogging:[Yes|No]**

Turns detailed event logging on or off for the specified scheduler service. The default is *Yes*.

**/force:[Yes|No]**

This option can also be specified when using the UPDATEPW command in a cluster environment. Normally this is not required. However, if more than one scheduler service with different cluster settings is defined for a particular node, the utility cannot determine which settings are correct. In this case, correct the discrepancies between the services.

Alternatively, you can specify this option with **/clusternode** and **/clustername** (if **/clusternode:Yes** is specified), to force the utility to show or update the password with the specified cluster settings.

**/httpport:httpport**

Specifies a TCP/IP port address for the web client.

**/machine:machinename**

Specifies the name of a remote workstation to connect to.

**/name:servicename**

Specifies the name of the Client service. The name must be quote delimited if it contains embedded spaces.

**/node:nodename**

Specifies the IBM Spectrum Protect node name the Client Service uses when connecting to the IBM Spectrum Protect server. Also used when displaying or updating the IBM Spectrum Protect password. The default is the workstation name.

**/ntaccount:ntaccount**

Specifies the Windows account which the service logs in as.

**/ntdomain:ntdomain**

Specifies the Windows domain which the service logs in as.

**/ntpassword:**ntpassword

Specifies the Windows password for the account under which the service logs in.

**/oldpassword:**oldpw

Current® IBM Spectrum Protect server password. Used in conjunction with the /updateonserver option when updating a password on the server.

**/optfile:**optionsfile

The fully qualified path of the client options file. This is the options file the specified Client Service uses to connect to the IBM Spectrum Protect server. The utility also uses the file to connect to the IBM Spectrum Protect server to validate and update passwords. Note that although this option overrides the default option file in the current directory (dsm.opt), the IBM Spectrum Protect API requires that a default option file exists in the current directory. UNC names are not allowed if the local system account is set to logon. The default is the dsm.opt file in the **/clientdir** directory.

**/partnername:**partner service name

This option is used when installing a Remote Client Agent Service to specify the partner Client Acceptor Service.

**/password:**password

The IBM Spectrum Protect password which is generated and encrypted.

**/schedlog:**schedlog

Specifies the fully qualified name of the client schedule log.

**/srcdir:**pathname

Use this option in conjunction with the **/copyfiles** option to specify the fully qualified source path to copy the service installation to another location prior to installing the service.

**/startnow:**[Yes|No]

Specifies whether dsmsutil starts the specified service after executing the command; the default is Yes. If you specify **No**, you must start the service manually using the services control panel applet, or the NET START **name of the service**.

**/updateonserver:**[Yes|No]

Specifies whether the specified password is updated on the IBM Spectrum Protect server. Requires using the **/oldpassword** option.

**/validate:**[Yes|No]

Specifies whether to perform validation when displaying or updating the encrypted password. The default is Yes.

**/webports:** webports

Specifies the TCP/IP port number used by the Client Acceptor service and the web client agent service for communications with the web GUI.

## Backup-archive clients documentation in PDF files

---

The information about backup-archive clients that is available in IBM Knowledge Center is also available in PDF files.

- [AIX](#) | [Linux](#) | [Mac OS X](#) | [Solaris](#) Backup-Archive Clients Installation and User's Guide
- [Windows](#) Backup-Archive Clients Installation and User's Guide
- Client Messages and Application Programming Interface Return Codes

### Related concepts:

Installing the IBM Spectrum Protect backup-archive clients (UNIX, Linux, and Windows)

### Related tasks:

Configuring backup-archive clients

IBM Spectrum Protect backup-archive clients

### Related reference:

Backup-archive client options and commands

### Related information:

Protection for workstations and file servers

## Developing solutions with the application programming interface

---

The IBM Spectrum Protect™ application programming interface (API) is packaged with the IBM Spectrum Protect backup-archive client. With the API, you can protect business applications such as databases in the IBM Spectrum Protect environment.

- What's new for IBM Spectrum Protect API  
Read about new and changed features. Review the release notes before installing the product.
- Installing the API  
Information about installing the IBM Spectrum Protect application programming interface (API) is provided in the installation procedures for the backup-archive client.

- **API overview**  
The IBM Spectrum Protect application program interface (API) enables an application client to use storage management functions.
- **Building and running the sample API application**  
The API package includes sample applications that demonstrate the API function calls in context. Install a sample application and review the source code to understand how you can use the function calls.
- **Considerations for designing an application**  
When you design an application, you must have a broad understanding of many aspects of the API.
- **Understanding interoperability**  
The API has two types of interoperability: between the backup-archive client and API applications and between different operating systems.
- **Using the API with Unicode**  
The IBM Spectrum Protect API supports Unicode UCS2, a fixed length, double-byte code page that has code points for all known code pages, such as Japanese, Chinese, or German. It supports as many as 65,535 unique code points.
- **API function calls**
- **API return codes source file: dsmerc.h**  
The dsmerc.h header file contains all return codes that the API can return to an application.
- **API type definitions source files**
- **API function definitions source file**  
This appendix contains the dsmapifp.h header file, so you can see the function definitions for the API.
- **API return codes reference**

**Related concepts:**

IBM Tivoli Storage Manager backup-archive clients

**Related reference:**

PDF files for printing

## What's new for IBM Spectrum Protect API

---

Read about new and changed features. Review the release notes before installing the product.

- **API updates**  
Learn about new features and updates for the application programming interface (API) in IBM Spectrum Protect Version 8.1.
- **Release notes for IBM Spectrum Protect Application Programming Interface Version 8.1**  
IBM Spectrum Protect Application Programming Interface (API) V8.1 is available. Read this document to find important installation information. You can also learn about product updates, compatibility issues, limitations, and known problems.
- **Readme files for IBM Spectrum Protect Version 8.1 Application Programming Interface fix packs**  
Readme files for the IBM Spectrum Protect Version 8.1 Application Programming Interface (API) fix packs are available in the Support knowledge base when there is a fix pack update.
- **Late-breaking documentation updates**  
Updates to the IBM Spectrum Protect application programming interface (API) documentation can occur after the documentation is published in IBM® Knowledge Center.

## API updates

---

Learn about new features and updates for the application programming interface (API) in IBM Spectrum Protect™ Version 8.1.

Release	New features and updates
---------	--------------------------

Release	New features and updates
8.1.2	<p>Enhanced client security settings</p> <p>Beginning in IBM Spectrum Protect Version 8.1.2, several changes are introduced in the backup-archive client to work with the IBM Spectrum Protect V8.1.2 server, which provides enhancements to improve the security between client and server communications. For more information, see <a href="#">Backup-archive client updates</a>.</p> <p>The Trusted Communication Agent (TCA) is deprecated</p> <p>Due to the enhanced communication that is introduced in IBM Spectrum Protect V8.1.2, the Trusted Communication Agent (TCA) is no longer available. For more information, see:</p> <ul style="list-style-type: none"> <li>• Secure password storage</li> <li>• Enable non-root users to manage their own data</li> </ul> <p>Maintenance updates</p> <p>The API documentation has been updated to include maintenance updates.</p>
8.1.0	<p>IBM® Tivoli® Storage Manager is now IBM Spectrum Protect</p> <p>IBM Spectrum Protect Version 8.1 is the next generation of Tivoli Storage Manager. This new release represents more than a name change in the user interface and documentation. It is an evolution to a higher level of data protection that is designed to meet the complex demands of today's world.</p> <p>For more information, see <a href="#">Meet IBM Spectrum Protect</a>.</p> <p>An administrative user ID is no longer created by default with the REGISTER NODE server command</p> <p>Beginning with IBM Spectrum Protect V8.1, the REGISTER NODE server command does not automatically create an administrative user ID that matches the node name. This product update is designed to optimize user authentication to a Lightweight Directory Access Protocol (LDAP) server.</p> <p>This product update does not affect existing client nodes, but can affect the process of registering new client nodes, including but not limited to nodes for IBM Spectrum Protect backup-archive clients. In some cases, you might have to create an administrative user ID when you register a node. You can create the administrative user ID by issuing the REGISTER NODE command and specifying the USERID parameter. For information about the types of clients that are affected, see <a href="#">technote 7048963</a>.</p> <p>For more information about creating an administrative user ID, see <a href="#">Creating an administrative user with client owner authority</a>.</p> <p>Discontinued support of client operating systems</p> <p>To take advantage of new product features, install the V8.1 backup-archive client and API on one of the supported operating systems. For the current list of supported operating systems, see <a href="#">technote 1243309</a>.</p> <p>The following operating systems are no longer supported by the backup-archive client:</p> <ul style="list-style-type: none"> <li>• Windows 32-bit operating systems (client and API).</li> <li>• Windows Server 2008, Windows Server 2008 R2, Windows 7, and Windows 8 operating systems.</li> <li>• HP-UX operating systems. You can still use the IBM Spectrum Protect API on an HP-UX operating system. For installation instructions, see <a href="#">Installing the HP-UX Itanium 2 API</a>.</li> <li>• Linux on Power Systems™ (big endian). You can still use the IBM Spectrum Protect API on Linux on Power Systems (big endian). For installation instructions, see <a href="#">Installing the API on Linux on Power Systems (Big Endian)</a>.</li> <li>• Solaris SPARC operating systems. You can still use the IBM Spectrum Protect API on Solaris SPARC operating systems. Instructions for installing the API are included in the topic, <a href="#">Installing the Oracle Solaris client</a>.</li> </ul>

## Release notes for IBM Spectrum Protect Application Programming Interface Version 8.1

IBM Spectrum Protect™ Application Programming Interface (API) V8.1 is available. Read this document to find important installation information. You can also learn about product updates, compatibility issues, limitations, and known problems.

## Contents

---

- Description
- Announcement
- Compatibility with earlier versions
- System requirements
- Installing the API
- Updates, limitations, and known problems

## Description

---

The IBM Spectrum Protect API enables an application client to use storage management functions. The API includes function calls that you can use in an application to run the following operations:

- Start or end a session
- Assign management classes to objects before they are stored on a server
- Back up or archive objects to a server
- Restore or retrieve objects from a server
- Query the server for information about stored objects
- Manage file spaces
- Send retention events

The API is used by software developers to create new applications that work with IBM Spectrum Protect.

The publication entitled *IBM Spectrum Protect Using the Application Programming Interface* provides information about how to use the IBM Spectrum Protect API.

The IBM Spectrum Protect API is available on the following operating systems:

- HP-UX
- IBM® AIX®
- Linux
- Mac OS X
- Microsoft Windows 64-bit operating systems
- Oracle Solaris

For a list of the APARs that are fixed in this release, see technote 1993247.

## Announcement

---

The announcement for the IBM Spectrum Protect V8.1 family of products includes the following information:

- Detailed product description, including a description of new functions
- Product-positioning statement
- Packaging and ordering details
- International compatibility information

To search for the product announcement, complete the following steps:

1. Go to the product announcement website.
2. In the Search for field, enter the product identifier (PID) for your product. The PID for IBM Spectrum Protect is 5725-W98.
3. In the Information Type field, select Announcement letters, and click Search.
4. From the Search in list, select Product Number.
5. Optional: In the Refine Your Search pane on the left side of the window, select the country where you reside.
6. In the Sort by section, select Newest first.

## Compatibility with earlier versions

---

For compatibility with earlier versions, see IBM Spectrum Protect Server/Client Compatibility and Upgrade Considerations.

## System requirements

---

For information about hardware and software compatibility, see the detailed system requirements document at the following web pages:

Apple Macintosh client requirements  
Technote 1053584

HP-UX Itanium API requirements  
Technote 1197146

IBM AIX client requirements  
Technote 1052226

Linux on Power® Systems client requirements  
Technote 1169963

Linux x86\_64 client requirements  
Technote 1052223

Linux on z Systems™ client requirements  
Technote 1066436

Microsoft Windows client requirements  
Technote 1197133

Oracle Solaris SPARC API requirements  
Technote 1052211

Oracle Solaris x86\_64 client requirements  
Technote 1232956

## Installing the API

---

For installation instructions, see [Installing the API](#).

## Updates, limitations, and known problems

---

Documentation updates, limitations, and known problems are documented as technotes in the Support knowledge base at the IBM Support Portal for IBM Spectrum Protect. As problems are discovered and resolved, IBM Software Support updates the knowledge base. By searching the knowledge base, you can find workarounds or solutions to problems.

Limitations and known problems

For the limitations and known problems that affect the IBM Spectrum Protect V8.1 API, see technote 1993248.

Documentation updates

For information that was not available at the time of publication, see the documentation updates at technote 7048957.

## Readme files for IBM Spectrum Protect Version 8.1 Application Programming Interface fix packs

---

Readme files for the IBM Spectrum Protect™ Version 8.1 Application Programming Interface (API) fix packs are available in the Support knowledge base when there is a fix pack update.

View IBM Spectrum Protect Version 8.1 API fix pack readme files

## Late-breaking documentation updates

---

Updates to the IBM Spectrum Protect™ application programming interface (API) documentation can occur after the documentation is published in IBM® Knowledge Center.

For late-breaking documentation updates, see technote 7048957 in the IBM Support Portal.

## Installing the API

---

Information about installing the IBM Spectrum Protect™ application programming interface (API) is provided in the installation procedures for the backup-archive client.

- [Installing the Tivoli Storage Manager backup-archive clients \(UNIX, Linux, and Windows\)](#)

## API overview

---

The IBM Spectrum Protect™ application program interface (API) enables an application client to use storage management functions.

The API includes function calls that you can use in an application to perform the following operations:

- Start or end a session
- Assign management classes to objects before they are stored on a server
- Back up or archive objects to a server
- Restore or retrieve objects from a server
- Query the server for information about stored objects
- Manage file spaces
- Send retention events

When you, as an application developer, install the API, you receive the files that an end user of an application needs:

- The API shared library.
- The messages file.
- The sample client options files.
- The source code for the API header files that your application needs.
- The source code for a sample application, and the makefile to build it.

For 64-bit applications, all compiles should be performed using compiler options that enable 64-bit support. For example, '-q64' should be used when building API applications on AIX®, and '-m64' should be used on Linux. See the sample make files for more information.

Important: When you install the API, ensure that all files are at the same level.

For information about installing the API, see [Installing the IBM Spectrum Protect backup-archive clients](#).

References to UNIX and Linux include AIX, HP-UX, Linux, Mac OS X, and Oracle Solaris operating systems.

- Understanding configuration and options files  
Configuration and options files set the conditions and boundaries under which your session runs.
- Setting up the API environment  
The API uses unique environment variables to locate files. You can use different files for API applications from those that the backup-archive client uses. Applications can use the `dsmSetup` function call to override the values that the environment variables set.

## Understanding configuration and options files

---

Configuration and options files set the conditions and boundaries under which your session runs.

You, an administrator, or an end user can set option values to:

- Set up the connection to a server
- Control which objects are sent to the server and the management class to which they are associated

You define options in one or two files when you install the API on your workstation.

On UNIX and Linux operating systems, the options reside in two options files:

- `dsm.opt` - the client options file
- `dsm.sys` - the client system options file

On other operating systems, the client options file (`dsm.opt`) contains all of the options.

Restriction: The API does not support the following backup-archive client options:

- `autofsrename`
- `changingretries`
- `domain`
- `eventlogging`
- `groups`

- subdir
- users
- virtualmountpoint

You also can specify options on the `dsmInitEx` function call. Use the option string parameter or the API configuration file parameter.

The same option can derive from more than one configuration source. When this happens, the source with the highest priority takes precedence. Table 1 lists the priority sequence.

Table 1. Configuration sources in order of decreasing priority

Priority	UNIX and Linux	Windows	Description
1	dsm.sys file (client system options)	not applicable	This file contains options that a system administrator sets only for UNIX and Linux.  Tip: If your dsm.sys file contains server stanzas, ensure that the passwordaccess option specifies the same value (either prompt or generate) in each of the stanzas.
2	Option string (client options)	Option string (all options)	One of these options takes effect when it is passed as a parameter to a <code>dsmInitEx</code> call. The list can contain client options such as <code>compressalways</code> , <code>servername</code> (UNIX and Linux only), or <code>tcpserveraddr</code> (non-UNIX).  With the API option string, an application client can make changes to the option values in the API configuration file and the client options file. For example, your application might query the end user if compression is required. Depending on the user responses, you can construct an API option string with this option and pass it into the call to <code>dsmInitEx</code> .  For information about the API option string format, see <code>dsmInitEx</code> . You also can set this parameter to NULL. This indicates that there is no API option string for this session.
3	API configuration file (client options)	API configuration file (all options)	The values that you set in the API configuration file override the values that you set in the client options file. Set up the options in the API configuration file with values that are appropriate in the IBM Spectrum Protect™ session for the user. The values take effect when the API configuration file name is passed as a parameter in the <code>dsmInitEx</code> call.  You also can set this parameter to NULL. This indicates that there is no API configuration file for this session.
4	dsm.opt file (client options)	dsm.opt file (all options)	On UNIX and Linux operating systems the <code>dsm.opt</code> file contains the user options only. On other operating systems, the <code>dsm.opt</code> file contains all options. To override the options in these files, follow the methods that are described in this table.

**Related concepts:**

Processing options

## Setting up the API environment

The API uses unique environment variables to locate files. You can use different files for API applications from those that the backup-archive client uses. Applications can use the `dsmSetup` function call to override the values that the environment variables set.

Tip: On Windows, the default installation directory is: `%SystemDrive%\Program Files\Common Files\Tivoli\TSM\api`  
Table 1 lists the API environment variables by operating system.

Table 1. API environment variables

Variables	UNIX and Linux	Windows
-----------	----------------	---------



Variables	UNIX and Linux	Windows
DSMI_CONFIG	The fully-qualified name for the client options file (dsm.opt).	The fully-qualified name for the client options file (dsm.opt).
DSMI_DIR	Points to the path that contains the dsm.sys, en_US subdirectory, and any other national language support (NLS) language. The en_US subdirectory must contain dsmclientV3.cat.	Points to the path that contains dscenu.txt and any NLS message file.
DSMI_LOG	Points to the path for the dserror.log file.	Points to the path for the dserror.log file.  If the client errorlogname option is set, the location specified by that option overrides the directory specified by DSMI_LOG.

## Building and running the sample API application

The API package includes sample applications that demonstrate the API function calls in context. Install a sample application and review the source code to understand how you can use the function calls.

Select one of the following sample API application packages:

- The interactive, single-threaded application package (dapi\*)
- The multithreaded application package (callmt\*)
- The logical object grouping test application (dsmgrp\*)
- The event-based retention policy sample application (callevnt)
- The deletion hold sample application (callhold)
- The data retention protection sample application (callret)
- The IBM Spectrum Protect™ data buffer sample program (callbuff)

To help you get started, review the procedure to build the sample dapismp sample application by your platform:

- For UNIX or Linux applications, see UNIX or Linux sample application source files.
- For Windows applications, see Windows 64-bit sample application.

The dapismp sample application creates its own data streams when backing up or archiving objects. It does not read or write objects to the local disk file system. The object name does not correspond to any file on your workstation. The "seed string" that you issue generates a pattern that can be verified when the object is restored or retrieved. Once you compile the sample application and run **dapismp** to start it, follow the instructions that display on your screen.

- UNIX or Linux sample application source files  
To build and run the sample UNIX or Linux sample application, you need to ensure you have certain source files. Once you build the sample application you can compile and run it.
- Windows 64-bit sample application  
To build and run the sample application for Microsoft Windows 64-bit systems, you must install the IBM Spectrum Protect API and ensure that you have certain source files.

## UNIX or Linux sample application source files

To build and run the sample UNIX or Linux sample application, you need to ensure you have certain source files. Once you build the sample application you can compile and run it.

The files that are listed in Table 1 include the source files and other files that you need to build the sample application that is included with the API package.

Table 1. Files that you need to build the UNIX or Linux API sample application

File names	Description
README_api_enu	README file

File names		Description
dsmrc.h dsmapitd.h dsmapips.h dsmapifp.h release.h		Return codes header file Common type definitions header file Operating system-specific type definitions header file Function prototype header file Release values header file
dapibkup.c dapidata.h dapiinit.c dapint64.h dapint64.c dapipref.c dapiproc.c dapiproc.h	dapipw.c dapiqry.c dapirc.c dapismp.c dapitype.h dapiutil.h dapiutil.c	Modules for the command line-driven sample application
makesmp[64].xxx		Makefile to build dapismp for your operating system. The xxx indicates the operating system.
callmt1.c callmt2.c		Multi-threaded sample files
callmtu1.c callmtu2.c		Multi-threaded Unicode sample files
libApiDS.xx libApiDS64.xx, or libApiTSM64.xx		Shared library (the suffix is platform-dependent)
dsmgrp.c callevnt.c callhold.c callret.c callbuff.c dpstthread.c		Grouping sample files Event-based retention policy sample source code Deletion hold sample source code Data retention protection sample source code

- Building the UNIX or Linux sample application  
You build the dapismp sample API application by using a compiler for your operating system.

## Windows 64-bit sample application

To build and run the sample application for Microsoft Windows 64-bit systems, you must install the IBM Spectrum Protect™ API and ensure that you have certain source files.

Restrictions:

- For best results, use dynamic loading. For an example, see the file dynaload.c and the implementation in the sample code.
- Files for the sample application are in the following directories:

api64\obj

Contains the API sample program object files.

api64\samprun

Contains the sample program dapismp. The sample program contains the execution directory.

- The DLL tsmapi64.dll is a 64-bit DLL.
- Use the Microsoft C/C++ Compiler Version 15 and the makefile makesmp64.mak to compile the API sample application dapismp. You might have to adjust the makefiles to fit your environment, specifically the library or the include directories.
- After you compile the application, run the sample application by issuing the command **dapismp** from the api64\samprun directory.
- Choose from the list of options displayed that are displayed. Ensure that you run the sign-on action before you run any other actions.
- Always prefix the file space, high-level, and low-level names with the correct path delimiter (\) when you enter the name, for example: \myfilespace. You must use this prefix even when you specify the asterisk (\*) wildcard character.

For Windows operating systems, the source files that you must have to build the sample application are listed in Table 1. The sample application is included in the API package. For your convenience, a precompiled executable (dapismp.exe) is also included.

Table 1. Files for building the Windows 64-bit API sample application

File names	Description
api.txt	README file
tsmapi64.dll	API DLLs
dsmrc.h	Return codes header file
dsmapi64.h	Common type definitions header file
dsmapi64.h	Operating system-specific type definitions header file
dsmapi64.h	Function prototype header file
dsmapi64.h	Dynamically loaded function prototype header file
release.h	Release values header file
dapidata.h dapint64.h dapitype.h dapiutil.h	Source code header files
tsmapi64.lib	Implicit library
dapibkup.c dapiinit.c dapint64.c dapipref.c dapiproc.c dapiproc.h dapipw.c dapiqry.c dapirc.c dapismp64.c dapiutil.c dynaload.c	Source code files for dapismp.exe
makesmpx64.mak (Windows x64) makesmp64.mak (Windows IA64)	Makefiles to build sample applications
callmt1.c callmt2.c callmtu164.c callmtu264.c	Multithreaded sample files
dpstthread.c	Sample file source code
callevnt.c callhold.c callret.c callbuff.c	Event-Based retention policy source code Deletion hold sample source code Data retention protection sample source code Shared buffer ( no copy) sample source code.

## Considerations for designing an application

When you design an application, you must have a broad understanding of many aspects of the API.

To gain an understanding of the API, review the following topics:

- Determining size limits
- Maintaining API version control
- Using multithreading
- Signals and signal handlers
- Starting or ending a session
- Object names and IDs
- Controlling access to password files
- Accessing objects as session owner
- Accessing objects across nodes and owners
- Managing file spaces
- Associating objects with management classes
- Expiration/deletion hold and release
- Querying the IBM Spectrum Protect system
- Sending data to a server
- Example flow diagrams for backup and archive
- File grouping
- State diagram summary for the IBM Spectrum Protect API

When you design your application, review the considerations in Table 1. Start structures with memset fields might change in subsequent releases. The stVersion value increments with each product enhancement.

Table 1. API Considerations for designing an application

Design item	Considerations
<b>Setting locale</b>	<p>The application must set the locale before the API is called. To set the locale to the default value, add the following code to the application:</p> <pre data-bbox="464 898 740 926">setlocale(LC_ALL, "");</pre> <p>To set the locale to another value, use the same call with the proper locale in the second parameter. Check for specifics in the documentation for each operating system that you are using.</p>

Design item	Considerations
<b>Session control</b>	<p>Apply the following guidelines to session control:</p> <ul style="list-style-type: none"> <li>• Assign a unique node name for each IBM Spectrum Protect backup-archive client and IBM Spectrum Protect API client product that you use. The following products are examples of these clients: <ul style="list-style-type: none"> <li>◦ IBM Spectrum Protect for Mail</li> <li>◦ or IBM Spectrum Protect HSM for Windows</li> </ul> </li> <li>• Use a consistent owner name across a backup and restore procedure.</li> <li>• Use the passwordaccess option to manage access to the protected password file.</li> <li>• Ensure that sessions for data movement end when the task is completed so that devices on the server are freed for use by other sessions.</li> <li>• To permit LAN-free data transfer, use the dsmSetup function call with the multithread flag set to on.</li> <li>• On AIX®, when you are using multithreaded applications or LAN-free, especially running on machines with multiple processors, set the environment variable AIXTHREAD_SCOPE to S in the environment before you start the application, for better performance and more solid scheduling. For example: <pre style="margin-left: 40px;">EXPORT AIXTHREAD_SCOPE=S</pre> <p>By setting AIXTHREAD_SCOPE to S, user threads that are created with default attributes are placed into system-wide contention scope. If a user thread is created with system-wide contention scope, the user thread is bound to a kernel thread and is scheduled by the kernel. The underlying kernel thread is not shared with any other user thread. For more information about this environment variable, see the following topic:</p> <p>Using multithreading</p> </li> </ul> <ul style="list-style-type: none"> <li>• Ensure that only one thread in a session calls any API function at any time. Applications that use multiple threads with the same session handle must synchronize the API calls. For example, use a mutex to synchronize API calls: <ul style="list-style-type: none"> <li>◦ getTSMMutex()</li> <li>◦ issue TSM API call</li> <li>◦ releaseTSMMutex()</li> </ul> <p>Use this approach only when the threads share a handle. You can use parallel calls to API functions if the calls have different session handles.</p> </li> <li>• Implement a threaded consumer/producer model for data movement. API calls are synchronous and the calls for dsmGetData function and dsmSendData function block until they are finished. By using a consumer/producer model, the application can read the next buffer during waiting periods for the network. Also, decoupling the data read/write and the network increases performance when there is a network bottleneck or delays. In general, the following holds: <pre style="margin-left: 40px;">Data thread &lt;---&gt; shared queue of buffers &lt;---&gt; communication thread (issue calls to the IBM Spectrum Protect API)</pre> </li> <li>• Use the same session for multiple operations to avoid incurring an overhead. For applications that deal with many small objects, implement session-pooling so that the same session can be used across multiple small operations. An overhead is associated with opening and closing a session to the IBM Spectrum Protect server. The dsmInit/dsmInitEX call is serialized so even in a multithreaded application only one thread can sign on at any time. Also, during sign-on the API sends a number of one-time queries to the server so that the server can do all operations. These queries include policy, option, file spaces, and local configuration.</li> </ul>

Design item	Considerations
<b>Operation sequence</b>	<p>The IBM Spectrum Protect server locks file space database entries during some operations. The following rules apply when you are designing IBM Spectrum Protect API applications:</p> <ul style="list-style-type: none"> <li>• Queries lock the file space during the entire transaction.</li> <li>• The query lock can be shared with other query operations, so multiple query operations on the same file space can execute concurrently.</li> <li>• The following operations are used to modify the IBM Spectrum Protect server database (DB Chg): send, get, rename, update, and delete.</li> <li>• Completion of a DB Chg operation requires a file space lock during the database change at the end of the transaction.</li> <li>• Multiple DB Chg operations on the same file space can execute concurrently. There might be a delay while the sequence waits for the lock at the end transaction.</li> <li>• The query lock cannot be shared with DB Chg operations. A DB Chg operation delays the beginning of a query on the same file space, so design your applications to separate and serialize queries from DB Chg operations on the same file space.</li> </ul>
<b>Object naming</b>	<p>When you name objects, consider the following factors:</p> <ul style="list-style-type: none"> <li>• The specific object names are the high-level and low-level object names. If a unique identifier, such as a date stamp, is included in the name, then backup objects are always active. The objects expire only when they are marked inactive by the <code>dsmDeleteObj</code> function call.</li> <li>• The restore method for objects determines how to format the name for easy queries. If you plan to use a partial object restore (POR), you cannot use compression. To suppress compression, use the <code>dsmSendObj objAttr objCompressed=bTrue</code> function.</li> </ul>
<b>Object grouping</b>	<p>Group objects logically by using file spaces. A file space is a container on the server that provides a grouping category for the objects. The API queries all file spaces during the initial sign-on and also during queries, so the number of file spaces must be restricted. A reasonable assumption is that an application sets up 20 - 100 file spaces per node. The API can cater for more file spaces, but each file space incurs an overhead for the session. To create a more granular separation, use the <code>directory</code> object in the application.</p>
<b>Object handling</b>	<p>Do not store <code>objectID</code> values to use for future restores. These values are not guaranteed to be persistent during the life of the object.</p> <p>During a restore, pay special attention to the restore order. After the query, sort on this value before the restore. If you are using multiple types of serial media, then access the different types of media in separate sessions. For more information, see the following topic:</p> <p>Selecting and sorting objects by restore order</p>
<b>Management class</b>	<p>Consider how much control the application must have over the management class that is associated with the application objects. You can define include statements, or you can specify a name on the <code>dsmSendObj</code> function call.</p>
<b>Object size</b>	<p>IBM Spectrum Protect needs to know a size estimate for each object. Consider how your application estimates the size of an object. An overestimation of the object size is better than an underestimation.</p>

- **Determining size limits**  
Certain data structures or fields in the API have size limits. These structures are often names or other text fields that cannot exceed a predetermined length.
- **Maintaining API version control**  
All APIs have some form of version control. The API version that you use in your application must be compatible with the version of the API library that is installed on the user workstation.
- **Using multithreading**  
The multithreaded API permits applications to create multiple sessions with the IBM Spectrum Protect server within the same process. The API can be entered again. Any calls can run in parallel from within different threads.
- **Signals and signal handlers**  
The application handles signals from the user or the operating system. If the user enters a CTRL+C keystroke sequence, the application must catch the signal and send `dsmTerminate` calls for each of the active threads. Then, call `dsmCleanup` to exit. If sessions are not closed properly, unexpected results might occur on the server.

- Starting or ending a session  
IBM Spectrum Protect is a session-based product, and all activities must be performed within an IBM Spectrum Protect session. To start a session, the application starts the `dsmInitEx` call. This call must be performed before any other API call other than `dsmQueryApiVersionEx`, `dsmQueryCliOptions`, or `dsmSetUp`.
- Object names and IDs  
The IBM Spectrum Protect server is an object storage server whose primary function is to efficiently store and retrieve named objects. The object ID is unique for each object and remains with the object for the life of the object *except* when you use export or import.
- Accessing objects as session owner  
Each object has an owner name associated with it. The rules determining what objects are accessed depend on what owner name is used when a session is started. Use this session owner value to control access to the object.
- Accessing objects across nodes and owners  
Three function calls support cross-node, cross-owner access on the same platform: **`dsmSetAccess`**, **`dsmDeleteAccess`**, and **`dsmQueryAccess`**. These functions, along with the `-fromnode` and `-fromowner` string options that are passed on **`dsmInitEx`**, permit a complete cross-node query, restore and retrieve process through the API.
- Managing file spaces  
Because file spaces are important to the operation of the system, a separate set of calls is used to register, update, and delete file space identifiers. Before you can store any objects that are associated with a file space on the system, you must first register the file space with IBM Spectrum Protect.
- Associating objects with management classes  
A primary feature of IBM Spectrum Protect is the use of policies (management classes) to define how objects are stored and managed in IBM Spectrum Protect storage. An object is associated with a management class when the object is backed up or archived.
- Expiration/deletion hold and release  
You can hold deletion and expiration of specific archive objects in response to a pending or ongoing action that requires that particular data be held. In the event an action is initiated that might require access to data, that data must be available until the action is concluded and access to the data is no longer required as part of that process. After determining that the suspension is no longer required (released), normal deletion and expiration timing resumes per the original retention period.
- Querying the IBM Spectrum Protect system  
The API has several queries, such as management class query, that applications can use.
- Server efficiency  
Use these guidelines when you retrieve from, or send objects to, the IBM Spectrum Protect server.
- Sending data to a server  
The API permits application clients to send data or named objects and their associated data to IBM Spectrum Protect server storage.
- Set up the API to send performance data to the client performance monitor  
The client performance monitor is a component of the Tivoli® Storage Manager Administration Center that is used to display performance data that is collected by the API. The client performance monitor records and displays performance data for client backup, archive, and restore operations.
- Sending objects to the server  
Application clients can send data or named objects and their associated data to IBM Spectrum Protect storage by using the API backup and archive functions. The backup and archive components of the system permit use of different management procedures for data that is sent to storage.
- Data deduplication  
Data deduplication is a method of reducing storage needs by eliminating redundant data.
- Application failover  
When the IBM Spectrum Protect server becomes unavailable because of an outage, applications that use the API can automatically fail over to a secondary server for data recovery.
- Example flow diagrams for backup and archive  
The API is designed for straightforward logic flows and clear transitions between the various states of the application client. This clean state transition catches logic flaws and program errors early in the development cycle, greatly enhancing the quality and reliability of the system.
- File grouping  
The IBM Spectrum Protect API has a logical file grouping protocol that relates several individual objects together. You can reference and manage these groups as a logical group on the server. A logical group requires that all group members and the group leader belong to the same node and file space on the server.
- Receiving data from a server  
Application clients can receive data or named objects and their associated data from IBM Spectrum Protect storage by using the restore and retrieve functions. The restore function accesses objects that previously were backed up, and the retrieve function accesses objects that previously were archived.

- Updating and deleting objects on the server  
Your API applications can use the **dsmUpdateObj** or **dsmUpdateObjEx** function call to update objects that were archived or backed up. Use either call in the session state only, updating one object at a time. Use **dsmUpdateObjEx** to update any of several archive objects containing the same name.
- Logging events  
An API application can log event messages to central locations. The application can direct logging to the IBM Spectrum Protect server, the local machine, or both. The **dsmLogEventEx** function call is performed in a session. To view messages logged on the server, use the query **actlog** command through the administrative client.
- State diagram summary for the IBM Spectrum Protect API  
Once you review all the considerations for creating your own application with the IBM Spectrum Protect API, review this state diagram summary of an entire application.

## Determining size limits

Certain data structures or fields in the API have size limits. These structures are often names or other text fields that cannot exceed a predetermined length.

The following fields are examples of data structures that have size limits:

- Application type
- Archive description
- Copy group destination
- Copy group name
- File space information
- Management class name
- Object owner name
- Password

These limits are defined as constants within the header file **dsmapi.h**. Any storage allocation is based on these constants rather than on numbers that you enter. For more information, see API type definitions source files.

## Maintaining API version control

All APIs have some form of version control. The API version that you use in your application must be compatible with the version of the API library that is installed on the user workstation.

The **dsmQueryApiVersionEx** should be the first API call that you enter when you use the API. This call performs the following tasks:

- Confirms that the API library is installed and available on the end user's system
- Returns the version level of the API library that the application accesses

The API is designed to be upwardly compatible. Applications that are written to older versions or releases of the API library operate correctly when you run a later version.

Determining the release of the API library is very important because some releases might have different memory requirements and data structure definitions. Downward compatibility is unlikely. See Table 1 for information about your platform.

Table 1. Platform compatibility information

Platform	Description
Windows	The message files must be at the same level as the library (DLL).
UNIX or Linux	The API library and the message files must be at the same level.

The **dsmQueryApiVersionEx** call returns the version of the API library that is installed on the end user workstation. You can then compare the returned value with the version of the API that the application client is using.

The API version number of the application client is entered in the compiled object code as a set of four constants defined in **dsmapi.h**:

```
DSM_API_VERSION
DSM_API_RELEASE
DSM_API_LEVEL
DSM_API_SUB_LEVEL
```



See API type definitions source files.

The API version of the application client should be less than, or equal to, the API library that is installed on the user's system. Be careful about any other condition. You can enter the **dsmQueryApiVersionEx** call at any time, whether the API session has been started or not.

Data structures that the API uses also have version control information in them. Structures have version information as the first field. As enhancements are made to structures, the version number is increased. When initializing the version field, use the defined structure Version value in `dsmapi.h`.

Figure 1 demonstrates the type definition of the structure, `dsmApiVersionEx` from the header file, `dsmapi.h`. The example then defines a global variable that is named **apiLibVer**. It also demonstrates how you can use it in a call to **dsmQueryApiVersionEx** to return the version of the end user's API library. Finally, the returned value is compared to the API version number of the application client.

Figure 1. An example of obtaining the version level of the API

```
typedef struct
{
    dsUin16_t stVersion;      /* Structure version          */
    dsUin16_t version;       /* API version                */
    dsUin16_t release;       /* API release                */
    dsUin16_t level;        /* API level                  */
    dsUin16_t subLevel;     /* API sub level              */
} dsmApiVersionEx;

dsmApiVersionEx apiLibVer;

memset(&apiLibVer, 0x00, sizeof(dsmApiVersionEx));
dsmQueryApiVersionEx(&apiLibVer);

/* check for compatibility problems */
dsInt16_t appVersion= 0, libVersion = 0;
appVersion=(DSM_API_VERSION * 10000)+(DSM_API_RELEASE * 1000) +
            (DSM_API_LEVEL * 100) + (DSM_API_SUBLEVEL);
libVersion = (apiLibVer.version * 10000) + (apiLibVer.release * 1000) +
            (apiLibVer.level * 100) + (apiLibVer.subLevel);
if (libVersion < appVersion)
{
    printf("\n*****\n");
    printf("The IBM Spectrum Protect API library is lower than the application version\n");
    printf("Install the current library version.\n");
    printf("*****\n");
    return 0;
}

printf("* API Library Version = %d.%d.%d.%d *\n",
    apiLibVer.version,
    apiLibVer.release,
    apiLibVer.level,
    apiLibVer.subLevel);
```

## Using multithreading

---

The multithreaded API permits applications to create multiple sessions with the IBM Spectrum Protect™ server within the same process. The API can be entered again. Any calls can run in parallel from within different threads.

Tip: When you run applications that assume a multithreaded API, use the **dsmQueryAPIVersionEx** call.

To run the API in multithreaded mode, set the *mtflag* value to `DSM_MULTITHREAD` on the **dsmSetUp** call. The **dsmSetUp** call must be the first call after the **dsmQueryAPIVersionEx** call. This call must return before any thread calls the **dsmInitEx** call. When all threads complete processing, enter a call to **dsmCleanUp**. The primary process should not end before all the threads complete processing. See `callmt1.c` in the sample application.

Restriction: The default for the API is single-thread mode. If an application does not call **dsmSetUp** with the *mtflag* value set to `DSM_MULTITHREAD`, the API permits only one session for each process.

Once **dsmSetUp** successfully completes, the application can begin multiple threads and enter multiple **dsmInitEx** calls. Each **dsmInitEx** call returns a handle for that session. Any subsequent calls on that thread for that session must use that handle value.

Certain values are process-wide, environmental variables (values that are set on **dsmSetUp**). Each **dsmInitEx** call parses options again. Each thread can run with different options by specifying an overwrite file or an options string on the **dsmInitEx** call. This enables different threads to go to different servers, or use different node names.

Recommendation: On HP, set the thread stack to 64K or greater. The default value of the thread stack (32K) might not be sufficient

To permit application users to have a LAN-free session, use **dsmSetUp** *mtFlag DSM\_MULTITHREAD* in your application. This is necessary even if the application is single threaded. This flag activates the threading necessary for the IBM Spectrum Protect LAN-free interface.

## Signals and signal handlers

---

The application handles signals from the user or the operating system. If the user enters a CTRL+C keystroke sequence, the application must catch the signal and send **dsmTerminate** calls for each of the active threads. Then, call **dsmCleanUp** to exit. If sessions are not closed properly, unexpected results might occur on the server.

The application requires signal handlers, such as SIGPIPE and SIGUSR1, for signals that cause the application to end. The application then receives the return code from the API. For example, to ignore SIGPIPE add the following instruction in your application: `signal(SIGPIPE, SIG_IGN)`. After this information is added, instead of the application exiting on a broken pipe, the proper return code is returned.

## Starting or ending a session

---

IBM Spectrum Protect™ is a session-based product, and all activities must be performed within an IBM Spectrum Protect session. To start a session, the application starts the **dsmInitEx** call. This call must be performed before any other API call other than **dsmQueryApiVersionEx**, **dsmQueryCliOptions**, or **dsmSetUp**.

The **dsmQueryCliOptions** function can be called only before the **dsmInitEx** call. The function returns the values of important options, such as option files, compression settings, and communication parameters. The **dsmInitEx** call sets up a session with the server as indicated in the parameters that are passed in the call or defined in the options files.

The client node name, the owner name, and the password parameters are passed to the **dsmInitEx** call. The owner name is case-sensitive, but the node name and password are not. The application client nodes must be registered with the server before a session starts.

Each time an API application client starts a session with the server, the client application type is registered with the server. Always specify an operating system abbreviation for the application type value because this value is entered in the platform field on the server. The maximum string length is `DSM_MAX_PLATFORM_LENGTH`.

The **dsmInitEx** function call establishes the IBM Spectrum Protect session with the API configuration file and option list of the application client. The application client can use the API configuration file and option list to set a number of IBM Spectrum Protect options. These values override the values that are set in the user configuration files during installation. Users cannot change the options that the administrator defines. If the application client does not have a specific configuration file and option list, you can set both of these parameters to NULL. For more information about configuration files, see the following topic:

Understanding configuration and options files

The **dsmInitEx** function call establishes the IBM Spectrum Protect session, by using parameters that permit extended verification.

Check the **dsmInitEx** function call and the **dsmInitExOut** information return code. The administrator canceled the last session if the return code is okay (RC=ok) and the information return code (infoRC) is `DSM_RC_REJECT_LASTSESS_CANCELED`. To end the current session immediately, call **dsmTerminate**.

The **dsmQuerySessOptions** call returns the same fields as the **dsmQueryCliOptions** call. The call can be sent only within a session. The values reflect the client options that are valid during that session, from option files, and from any overrides from the **dsmInitEx** call.

After a session starts, the application can send a call to **dsmQuerySessInfo** to determine the server parameters that are set for this session. Items such as the policy domain and transaction limits are returned to the application with this call.

End sessions with a **dsmTerminate** call. Any connection with the server is closed and all resources that are associated with this session are freed.

For an example of starting and ending a session, see the following topic:

Figure 1

The example defines a number of global and local variables that are used in calls to `dsmInitEx` and `dsmTerminate`. The `dsmInitEx` call takes a pointer to `dsmHandle` as a parameter, while the `dsmTerminate` call takes the `dsmHandle` as a parameter. The example in Figure 2 displays the details of `rcApiOut`. The function `rcApiOut` calls the API function `dsmRCMsg`, which translates a return code into a message. The `rcApiOut` call then prints the message for the user. A version of `rcApiOut` is included in the API sample application. The `dsmApiVersion` function is a type definition that is found in the header file `dsmapi.h`.

- Session security  
The IBM Spectrum Protect session-based system has security components that permit applications to start sessions in a secure manner. These security measures prohibit unauthorized access to the server and help to insure system integrity.
- Controlling access to password files  
To control access to the protected password files on UNIX and Linux systems, you can log on as an authorized user and set the `passwordaccess` option to `generate`.
- Creating an administrative user with client owner authority  
An administrative user with client owner authority can set parameters on the `dsmInitEx` function call to start sessions. This user can function as an "administrative user" with backup and restore authority for the defined nodes.

## Session security

---

The IBM Spectrum Protect™ session-based system has security components that permit applications to start sessions in a secure manner. These security measures prohibit unauthorized access to the server and help to insure system integrity.

Every session that is started with the server must complete a sign-on process, requires a password. When the password is coupled with the node name of the client, it insures proper authorization when connecting to the server. The application client provides this password to the API to start the session.

Two methods of password processing are available: `passwordaccess=prompt` or `passwordaccess=generate`. If you use the `passwordaccess=prompt` option, you must include the password value on each **dsmInitEx** call. Or, you can supply the node name and owner name on the **dsmInitEx** call.

Passwords have expiration times associated with them. If a **dsmInitEx** call fails with a password-expired return code (DSM\_RC\_REJECT\_VERIFIER\_EXPIRED), the application client must enter the `dsmChangePW` call using the handle that is returned by **dsmInitEx**. This updates the password before the session can be established successfully. The example in Figure 3 demonstrates the procedure to change a password by using **dsmChangePW**. The login owner must use a root user ID or an authorized user ID to change the password.

The second method, `passwordaccess=generate`, encrypts and stores the password value in a file. The node name and owner name cannot be supplied on the **dsmInitEx** call, and the system default values are used. This protects the security of the password file. When the password expires, the `generate` parameter creates a new one and updates the password file automatically.

Tips:

1. If two different physical machines have the same IBM Spectrum Protect node name or multiple paths are defined on one node using several server stanzas, `passwordaccess=generate` might only work for the stanza which is used first after password expiration. During the first client-server contact, the user is prompted for the same password for each server stanza separately, and for each stanza, a copy of the password is stored separately. When the password expires, a new password is generated for the stanza which connects the first client-server contact. All subsequent attempts to connect via other server stanzas fail, because there is no logical link between their respective copies of the old password, and the updated copy generated by the stanza used first after password expiration. In this case, you must update the passwords prior to expiration or after expiration as a recovery from the situation, as follows:
  - a. Run **dsmdm** and update the password on the server.
  - b. Run **dsmc -servername=stanza1** and use the new password to generate a proper entry.
  - c. Run **dsmc -servername=stanza2** and use the new password to generate a proper entry.
2. For UNIX or Linux: Only the root user or an authorized user can change the password when using `passwordaccess=prompt`. Only the root user or an authorized user can start the password file when using `passwordaccess=generate`.  
Restriction: The options `users` and `groups` are not recognized.

An application can restrict user access by other means, such as setting access filters.

Applications that use multiple IP connections to a single IBM Spectrum Protect server should use the same node name and IBM Spectrum Protect client password for each session. Follow these steps to enable this support:

1. Define one IBM Spectrum Protect server stanza in the dsm.sys file.
2. For the connections not using the default IP address, specify the option values for *TCPserver* address and *TCPport* on the **dsmInitEx** call.

These values override the IP connection information, but the session still uses the same dsm.sys stanza node and password information.

Note: Nodes in a cluster share a single password.

Figure 1. An example of starting and ending a session

```

dsmApiVersionEx * apiApplVer;
char *node;
char *owner;
char *pw;
char *confFile = NULL;
char *options = NULL;
dsInt16_t rc = 0;
dsUInt32_t dsmHandle;
dsmInitExIn_t initIn;
dsmInitExOut_t initOut;
char *userName;
char *userNamePswd;

memset(&initIn, 0x00, sizeof(dsmInitExIn_t));
memset(&initOut, 0x00, sizeof(dsmInitExOut_t));
memset(&apiApplVer, 0x00, sizeof(dsmapiVersionEx));
apiApplVer.version = DSM_API_VERSION; /* Set the applications compile */
apiApplVer.release = DSM_API_RELEASE; /* time version. */
apiApplVer.level = DSM_API_LEVEL;
apiApplVer.subLevel= DSM_API_SUBLEVEL;

printf("Doing signon for node %s, owner %s, with password %s\n", node,owner,pw);

initIn.stVersion = dsmInitExInVersion;
initIn.dsmApiVersionP = &apiApplVer
initIn.clientNodeNameP = node;
initIn.clientOwnerNameP = owner ;
initIn.clientPasswordP = pw;
initIn.applicationTypeP = "Sample-API AIX";
initIn.configfile = confFile;
initIn.options = options;
initIn.userNameP = userName;
initIn.userPasswordP = userNamePswd;
rc = dsmInitEx(&dsmHandle, &initIn, &initOut);

if (rc == DSM_RC_REJECT_VERIFIER_EXPIRED)
{
    printf("*** Password expired. Select Change Password.\n");
    return(rc);
}
else if (rc)
{
    printf("*** Init failed: ");
    rcApiOut(dsmHandle, rc); /* Call function to print error message */
    dsmTerminate(dsmHandle); /* clean up memory blocks */
    return(rc);
}

```

Figure 2. Details of rcApiOut

```

void rcApiOut (dsUInt32_t handle, dsInt16_t rc)
{
    char *msgBuf ;

    if ((msgBuf = (char *)malloc(DSM_MAX_RC_MSG_LENGTH+1)) == NULL)
    {
        printf("Abort: Not enough memory.\n") ;
        exit(1) ;
    }

    dsmRCMsg(handle, rc, msgBuf);
    printf("
    free(msgBuf) ;

```

```

    return;
}

```

Figure 3. An example of changing a password

```

printf("Enter your current password:");
gets(current_pw);
printf("Enter your new password:");
gets(new_pw1);
printf("Enter your new password again:");
gets(new_pw2);
/* If new password entries don't match, try again or exit. */
/* If they do match, call dsmChangePW. */

rc = dsmChangePW(dsmHandle, current_pw, new_pw1);
if (rc)
{
    printf("*** Password change failed. Rc =
}
else
{
    printf("*** Your new password has been accepted and updated.\n");
}
return 0;

```

## Controlling access to password files

---

To control access to the protected password files on UNIX and Linux systems, you can log on as an authorized user and set the `passwordaccess` option to generate.

### Procedure

---

Complete the following steps when you set the `passwordaccess` to generate:

1. Write the application with a call to `dsmSetUp` which passes `argv[0]`. The `argv[0]` contains the name of the application that calls the API. The application is permitted to run as an authorized user; however, the administrator must decide on the login name for the authorized user.
2. Set the effective user ID bit (S bit) for the application executable to On. The owner of the application executable file can then become an authorized user and can create a password file, update passwords, and run applications. The owner of the application executable file must be the same as the user ID that runs the program. In the following example, `User` is `user1`, the name of the application executable file is `applA`, and `user1` has read/write permissions on the `/home/user1` directory. The `applA` executable file has the following permissions:

```
-rwsr-xr-x user1 group1 applA
```

3. Instruct the users of the application to use the authorized user name to log in. IBM Spectrum Protect™ verifies that the login ID matches the application executable owner before it permits access to the protected password file.
4. Set the `passworddir` option in the `dsm.sys` file to point to a directory where this user has read/write access. For example, enter the following line in the server stanza of the `dsm.sys` file:

```
passworddir /home/user1
```

5. Create the password file and ensure that the authorized user owns the file.
6. Log on as `user1` and run `applA`.
7. Call `dsmSetUp` and pass in `argv`.

## Creating an administrative user with client owner authority

---

An administrative user with client owner authority can set parameters on the `dsmInitEx` function call to start sessions. This user can function as an "administrative user" with backup and restore authority for the defined nodes.

### Procedure

---

To receive client owner authority, complete the following steps on the server:

1. Define the administrative user:

```
REGister Admin admin_name password
```

Where:

- *admin\_name* is the administrative user name.
- *password* is the admin password.

2. Define the authority level. Users with system or policy authority also have client owner authority.

```
Grant Authority admin_name classes authority node
```

Where:

- *admin\_name* is the administrative user.
- *classes* is the node.
- *authority* has one of the following levels of authority:
  - **owner**: full backup and restore authority for the node
  - **node**: single node
  - **domain**: group of nodes

3. Define access to a single node.

```
Register Node node_name password userid=user_id
```

Where:

- *node\_name* is the client user node
- *password* is the client user node password
- *user\_id* is the administrative user name

## Results

---

When the application uses the administrative user, the `dsmInitEx` function is called with the `userName` and `userNamePswd` parameters.

```
dsmInitEx
    clientNodeName = NULL
    clientOwnerName = NULL
    clientPassword = NULL
    userName = 'administrative user' name
    userNamePswd = 'administrative user' password
```

You can set the `passwordaccess` option to generate or prompt. With either parameter, the `userNamePswd` value starts the session. When the session starts, any backup or restore process can occur for that node.

## Object names and IDs

---

The IBM Spectrum Protect™ server is an object storage server whose primary function is to efficiently store and retrieve named objects. The object ID is unique for each object and remains with the object for the life of the object *except* when you use export or import.

To meet this requirement IBM Spectrum Protect has two main storage areas, database and data storage.

- The database contains all metadata, such as the name or attributes associated with objects.
- The data storage contains the object data. The data storage is actually a storage hierarchy that the system administrator defines. Data are efficiently stored and managed on either online or offline media, depending on cost and access needs.

Each object that is stored on the server has a name associated with it. The client controls the following key components of that name:

- File space name
- High-level name
- Low-level name
- Object type

When making decisions about naming objects for an application, you might need to use an external name for the full object names to the end user. Specifically, the end user might need to specify the object in an Include or Exclude statement when the application is run. The exact syntax of the object name in these statements is platform-dependent. On the Windows operating system, the drive letter associated with the file space rather than the file space name itself is used in the Include or Exclude statement.

The object ID value that was assigned when you created the object might not be the same as when you perform a restore process. Applications should save the object name and then query to obtain the current object ID before doing a restore.

- File space name  
The file space name is one of the most important storage components. It can be the name of a file system, disk drive, or any other high-level qualifier that groups related data together.
- High-level and low-level names  
Two other components of the object name are the high-level name qualifier and the low-level name qualifier. The high-level name qualifier is the directory path in which the object belongs, and the low-level name qualifier is the actual name of the object in that directory path.
- Object type  
The object type identifies the object as either a file or a directory. A file is an object that contains both attributes and binary data, and a directory is an object that contains only attributes.

## File space name

---

The file space name is one of the most important storage components. It can be the name of a file system, disk drive, or any other high-level qualifier that groups related data together.

IBM Spectrum Protect™ uses the file space to identify the file system or disk drive on which the data are located. In this way, actions can be performed on all entities within a file space, such as querying all objects within a specified file space. Because the file space is such an important component of the IBM Spectrum Protect naming convention, you use special calls to register, update, query, and delete file spaces.

The server also has administrative commands to query the file spaces on any node in IBM Spectrum Protect storage, and delete them if necessary. All data stored by the application client must have a file space name associated with it. Select the name carefully to group similar data together in the system.

To avoid possible interference, an application client should select different file space names from those that a backup-archive client would use. The application client should publish its file space names so that end users can identify the objects for include-exclude statements, if necessary.

Note: On Windows platforms, a drive letter is associated with a file space. When you register or update a file space, you must supply the drive letter. Because the include-exclude list refers to the drive letter, you must keep track of each letter and its associated file space. In the sample program `dapismp`, the drive letter is set to "G" by default.

See [Building and running the sample API application](#) for more information on the sample programs.

## High-level and low-level names

---

Two other components of the object name are the high-level name qualifier and the low-level name qualifier. The high-level name qualifier is the directory path in which the object belongs, and the low-level name qualifier is the actual name of the object in that directory path.

When the file space name, high-level name, and low-level name are concatenated, they must form a syntactically correct name on the operating system on which the client runs. It is not necessary for the name to exist as an object on the system or resemble the actual data on the local file system. However, the name must meet the standard naming rules to be properly processed by the **dsmBindMC** calls. See [Understanding backup and archive objects for naming considerations that are related to policy management](#).

## Object type

---

The object type identifies the object as either a file or a directory. A file is an object that contains both attributes and binary data, and a directory is an object that contains only attributes.

Table 1 shows what the application client would code is for object names by platform.

Table 1. Application object name examples by platform

Platform	Client code for object name
UNIX or Linux	/myfs/highlev/lowlev

Platform	Client code for object name
Windows	"myvol\\highlev\\lowlev" Note: On a Windows platform, a double backslash translates into a single backslash, because a backslash is the escape character. File space names start with a slash on the UNIX or Linux platform, but do not start with a slash on the Windows platform.

## Accessing objects as session owner

Each object has an owner name associated with it. The rules determining what objects are accessed depend on what owner name is used when a session is started. Use this session owner value to control access to the object.

The session owner is set during the call to **dsmInitEx** in the *clientOwnerNameP* parameter. If you start a session with **dsmInitEx** owner name of *NULL* and you use *passwordaccess=prompt*, that session owner is handled with session (root or authorized user) authority. This is also true if you log in with a root user ID or an authorized user ID and you use *passwordaccess=generate*. During a session started in this manner, you can perform any action on any object that is owned by this node regardless of the actual owner of that object.

If a session is started with a specific owner name, the session can only perform actions on objects that have that object owner name associated with them. Backups or archives into the system all must have this owner name associated with them. Any queries performed return only the values that have this owner name associated with them. The object owner value is set during the **dsmSendObj** call in the **Owner** field of the **ObjAttr** structure. An owner name is case-sensitive. Table 1 summarizes the conditions under which a user has access to an object.

Table 1. Summary of user access to objects

Session owner	Object owner	User access
NULL (root, system owner)	" " (empty string)	Yes
NULL	Specific name	Yes
Specific name	" " (empty string)	No
Specific name	Same name	Yes
Specific name	Different name	No

## Accessing objects across nodes and owners

Three function calls support cross-node, cross-owner access on the same platform: **dsmSetAccess**, **dsmDeleteAccess**, and **dsmQueryAccess**. These functions, along with the *-fromnode* and *-fromowner* string options that are passed on **dsmInitEx**, permit a complete cross-node query, restore and retrieve process through the API.

For example, User A on node A uses the **dsmSetAccess** function call to give access to its backups under the /db file space to User B from Node B. The access rule is displayed as:

ID	Type	Node	User	Path
1	Backup	Node B	User B	/db/*/*

When User B logs on at Node B, the option string to **dsmInitEx** is:

```
-fromnode=nodeA -fromowner=userA
```

These options are set for this session. Any queries access the file spaces, and files of Node A. Backups and archives are not permitted. Only query, restore, and retrieve processes are permitted from the file spaces for which User B has access. If the application tries to execute any operation using a **dsmBeginTxn** (for examples, backup or update) while signed in with a *-fromnode* or *-fromowner* option set, then the **dsmBeginTxn** fails with the return code `DSM_RC_ABORT_NODE_NOT_AUTHORIZED`. See the individual function calls and **dsmInitEx** for more information.

Tip: On UNIX and Linux you can specify *-fromowner=root* in the option string that is passed on the **dsmInitEx** function call. This permits non-root users access to files that the root owns if a set access was performed.

Use the *asnodename* option on the **dsmInitEx** option string with the appropriate function to back up, archive, restore, retrieve, query or delete data under the target node name on the IBM Spectrum Protect™ server. See Backing up multiple nodes with client node proxy support for information on enabling this option.



## Managing file spaces

Because file spaces are important to the operation of the system, a separate set of calls is used to register, update, and delete file space identifiers. Before you can store any objects that are associated with a file space on the system, you must first register the file space with IBM Spectrum Protect™.

Use the `dsmRegisterFS` call to accomplish this task. For more information about object names and IDs, see [Object names and IDs](#).

The file space identifier is the top-level qualifier in a three-part name hierarchy. Grouping related data together within a file space makes management of that data much easier. For example, either the application client or the IBM Spectrum Protect server administrator can delete a file space and all the objects within that file space.

File spaces also permit the application client to provide information about the file space to the server that the administrator can then query. This information is returned on the query in the `qryRespFSData` structure and includes the following file system information:

Type	Definition
<code>fstype</code>	The file space type. This field is a character string that the application client sets.
<code>fsAttr[platform].fsInfo</code>	A client information field that is used for client-specific data.
<code>capacity</code>	The total amount of space in the file space.
<code>occupancy</code>	The amount of space that is currently occupied in the file space.
<code>backStartDate</code>	The time stamp when the latest backup started (set by sending a <code>dsmUpdateFS</code> call).
<code>backCompleteDate</code>	The time stamp when the latest backup completed (set by sending a <code>dsmUpdateFS</code> call).

Using `capacity` and `occupancy` depends on the application client. Some applications might not need information about the size of the file space, in which case these fields can default to 0. For more information about querying file spaces, see [Querying the IBM Spectrum Protect system](#).

After a file space is registered with the system, you can back up or archive objects at any time. To update the `occupancy` and the `capacity` fields of the file space after a backup or archive operation, call `dsmUpdateFS`. This call ensures that the values for the `occupancy` and `capacity` of the file system are current. You can also update the `fsinfo`, `backupstart`, and `backupcomplete` fields.

If you want to monitor your last backup dates, enter a `dsmUpdateFS` call before you start the backup. Set the update action to `DSM_FSUPD_BACKSTARTDATE`. This forces the server to set the `backStartDate` field of the file space to the current time. After the backup is complete for that file space, enter a `dsmUpdateFS` call with the update action that is set to `DSM_FSUPD_BACKCOMPLETEDATE`. This call creates a time stamp on the end of the backup.

If a file space is no longer needed, you can delete it with the `dsmDeleteFS` command. On a UNIX or Linux operating system, only the root user or authorized users can delete file spaces.

The examples in [Figure 1](#) demonstrate how to use the three file space calls for UNIX or Linux. For an example of how to use the three file space calls for Windows, see the sample program code that is installed on your system.

Figure 1. An example of working with file spaces, Part 1

```
/* Register the file space if it has not already been done. */

dsInt16      rc;
regFSData    fsData;
char         fsName[DSM_MAX_FSNAME_LENGTH];
char         smpAPI[] = "Sample-API";

strcpy(fsName, "/home/tallan/text");
memset(&fsData, 0x00, sizeof(fsData));
fsData.stVersion = regFSDataVersion;
fsData.fsName = fsName;
fsData.fsType = smpAPI;
strcpy(fsData.fsAttr.unixFSAttr.fsInfo, "Sample API FS Info");
fsData.fsAttr.unixFSAttr.fsInfoLength =
    strlen(fsData.fsAttr.unixFSAttr.fsInfo) + 1;
fsData.occupancy.hi=0;
fsData.occupancy.lo=100;
fsData.capacity.hi=0;
fsData.capacity.lo=300;
```

```

rc = dsmRegisterFS(dsmHandle,fsData);
if (rc == DSM_RC_FS_ALREADY_REGED) rc = DSM_RC_OK; /* already done */
if (rc)
{
    printf("Filespace registration failed: ");
    rcApiOut(dsmHandle, rc);
    free(bkup_buff);
    return (RC_SESSION_FAILED);
}

```

Figure 2. An example of working with file spaces, Part 2

```

/* Update the file space. */

dsmFSUpd    updFilespace;          /* for update FS */

updFilespace.stVersion = dsmFSUpdVersion;
updFilespace.fsType = 0;           /* no change */
updFilespace.occupancy.hi = 0;
updFilespace.occupancy.lo = 50;
updFilespace.capacity.hi = 0;
updFilespace.capacity.lo = 200;
strcpy(updFilespace.fsAttr.unixFSAttr.fsInfo,
       "My update for filesystem");
updFilespace.fsAttr.unixFSAttr.fsInfoLength =
    strlen(updFilespace.fsAttr.unixFSAttr.fsInfo);

updAction = DSM_FSUPD_FSINFO |
            DSM_FSUPD_OCCUPANCY |
            DSM_FSUPD_CAPACITY;

rc = dsmUpdateFS (handle, fsName, &updFilespace, updAction);
printf("dsmUpdateFS rc=%d\n", rc);

```

Figure 3. An example of working with file spaces, Part 3

```

/* Delete the file space. */

printf("\nDeleting file space
rc = dsmDeleteFS (dsmHandle, fsName, DSM_REPOS_ALL);
if (rc)
{
    printf(" FAILED!!! ");
    rcApiOut(dsmHandle, rc);
}
else printf(" OK!\n");

```

## Associating objects with management classes

---

A primary feature of IBM Spectrum Protect™ is the use of policies (management classes) to define how objects are stored and managed in IBM Spectrum Protect storage. An object is associated with a management class when the object is backed up or archived.

This management class determines:

- How many versions of the object are kept if backed up
- How long to keep archive copies
- Where to insert the object in the storage hierarchy on the server

Management classes consist of both backup copy groups and archive copy groups. A copy group is a set of attributes that define the management policies for an object that is being backed up or archived. If a backup operation is being performed, the attributes in the backup copy group apply. If an archive operation is being performed, the attributes in the archive copy group apply.

The backup or archive copy group in a particular management class can be empty or NULL. If an object is bound to the NULL backup copy group, that object cannot be backed up. If an object is bound to the NULL archive copy group, the object cannot be archived.

Because the use of a policy is a very important component of IBM Spectrum Protect, the API requires that all objects sent to the server are first assigned a management class by using the **dsmBindMC** call. With IBM Spectrum Protect software, you can use an include-exclude list to affect management class binding. The **dsmBindMC** call uses the current Include-Exclude list to perform management class binding.

Include statements can associate a specific management class with a backup or archive object. Exclude statements can prevent objects from being backed up but not from being archived.

The API requires that **dsmBindMC** is called before you back up or archive an object. The **dsmBindMC** call returns a `mcBindKey` structure that contains information on management class and copy groups that are associated with the object. Check the copy group destination before proceeding with a send. When you send multiple objects in a single transaction, they must have the same copy group destination. The **dsmBindMC** function call returns the following information:

Table 1. Information returned on the `dsmBindMC` call

Information	Description
Management Class	The name of the management class that was bound to the object. The application client can send the <b>dsmBeginQuery</b> call to determine all attributes of this management class.
Backup Copy Group	Informs you if a backup copy group exists for this management class. If a backup operation is being performed and a backup copy group does not exist, this object cannot be sent to storage. You receive an error code if you attempted to send it using the <b>dsmSendObj</b> call.
Backup Copy Destination	This field identifies the storage pool to which the data is sent. If you are performing a multiple object backup transaction, all copy destinations within that transaction must be the same. If an object has a different copy destination than previous objects in the transaction, end the current transaction and begin a new transaction before you can send the object. You receive an error code if you attempt to send objects to different copy destinations within the same transaction.
Archive Copy Group	Informs you if an archive copy group exists for this management class. If an archive operation is being performed and an archive copy group does not exist, this object cannot be sent to storage. You receive an error code if you attempted to send it using the <b>dsmSendObj</b> call.
Archive Copy Destination	This field identifies the storage pool to which the data are sent. If you are performing a multiple object archive transaction, all copy destinations within that transaction must be the same. If an object has a different copy destination than previous objects in the transaction, end the current transaction and begin a new transaction before you send the object. You receive an error code if you attempt to send objects to different copy destinations within the same transaction.

Backup copies of an object can be rebound to a different management class if a subsequent back up with the same object name is done that uses a management class different than the original. For example, if you back up ObjectA and bind it to `Mgmtclass1`, and later you back up ObjectA and bind it to `Mgmtclass2`, the most current backup rebinds any inactive copies to `Mgmtclass2`. The parameters defined in `Mgmtclass2` would now control all copies. However the data does not move if the destination is different.

You can also rebind backup copies to a different management class using the **dsmUpdateObj** or **dsmUpdateObjEx** call with the `DSM_BACKUPD_MC` action.

- Query management classes  
Applications can query management classes to determine what management classes are possible for a given node and to determine what the attributes are within the management class.

**Related reference:**  
Deduplication option

## Expiration/deletion hold and release

You can hold deletion and expiration of specific archive objects in response to a pending or ongoing action that requires that particular data be held. In the event an action is initiated that might require access to data, that data must be available until the action is concluded and access to the data is no longer required as part of that process. After determining that the suspension is no longer required (released), normal deletion and expiration timing resumes per the original retention period.

### Before you begin

Verify that the server is licensed by issuing a test `dsmRetentionEvent` call:

1. Query for one object you want to hold and get the ID.
2. Issue the `dsmBeginTxn`, `dsmRetentionEvent` with Hold, and `dsmEndTxn`.
3. If the server is not licensed, you receive a vote of abort with reason code `DSM_RC_ABORT_LICENSE_VIOLATION`.

Restrictions:

1. You cannot issue more than one `dsmRetentionEvent` call in a single transaction.
2. You cannot issue a hold on an object that is already under hold.

## Procedure

---

1. To hold objects, complete the following steps:
    - a. Query the server for all the objects that you want to place under hold. Get the object ID for each object.
    - b. Issue a `dsmBeginTxn` call, then issue a `dsmRetentionEvent` call with the list of objects, followed by a `dsmEventType: eventHoldObj` call. If the number of objects exceeds the value of `maxObjPerTxn`, use multiple transactions.
    - c. Use the `qryRespArchiveData` response on the `dsmGetNextQObj` function call to confirm that the objects are put under hold. Check the value of `objHeld` in `qryRespArchiveData`.
  2. To release objects from hold, complete the following steps:
    - a. Query the server for all the objects that you want to release from hold. Get the object ID for each object.
    - b. Issue a `dsmBeginTxn` call, then issue a `dsmRetentionEvent` call with the list of objects, followed by a `dsmEventType: eventReleaseObj` call. If the number of objects exceeds the value of `maxObjPerTxn`, use multiple transactions.
    - c. Use the `qryRespArchiveData` response on the `dsmGetNextQObj` function call to confirm if the objects were released from hold. Check the value of `objHeld` in `qryRespArchiveData`.
- Archive data retention protection  
Data that is under the control of IBM Spectrum Protect™ cannot be modified by unauthorized agents, such as an individual or a program. This protection extends to preventing the deletion of data, such as archive objects, by any agent before the expiration of the retention period.

## Querying the IBM Spectrum Protect™ system

---

The API has several queries, such as management class query, that applications can use.

## Procedure

---

All queries that use the `dsmBeginQuery` call follow these steps:

1. Send the `dsmBeginQuery` call with the appropriate query type:
  - Backup
  - Archive
  - Active backed-up objects
  - File space
  - Management class

The `dsmBeginQuery` call informs the API of the data format that is returned from the server. The appropriate fields can be placed in the data structures that are passed by the `dsmGetNextQObj` calls. The begin query call also permits the application client to set the scope of the query by properly specifying the parameters on the begin query call.

Restriction: On UNIX or Linux systems, only the root user can query active backed-up objects. This query type is known as "fast path".

2. Enter the `dsmGetNextQObj` call to obtain each record from the query. This call passes a buffer that is large enough to hold the data that is returned from the query. Each query type has a corresponding data structure for the data returned. For example, a backup query type has an associated `qryRespBackupData` structure that is populated when the `dsmGetNextQObj` call is sent.
3. The `dsmGetNextQObj` call usually returns one of the following codes:
  - `DSM_RC_MORE_DATA`: Send the `dsmGetNextQObj` call again.
  - `DSM_RC_FINISHED`: There is no more data. Send the `dsmEndQuery` call.
4. Send the `dsmEndQuery` call. When all query data are retrieved or more query data are not needed, enter the `dsmEndQuery` call to end the query process. The API flushes any remaining data from the query stream and releases any resources that were used for the query.

## Results

---

Figure 1 displays the state diagram for query operations.

Figure 1. State diagram for general queries

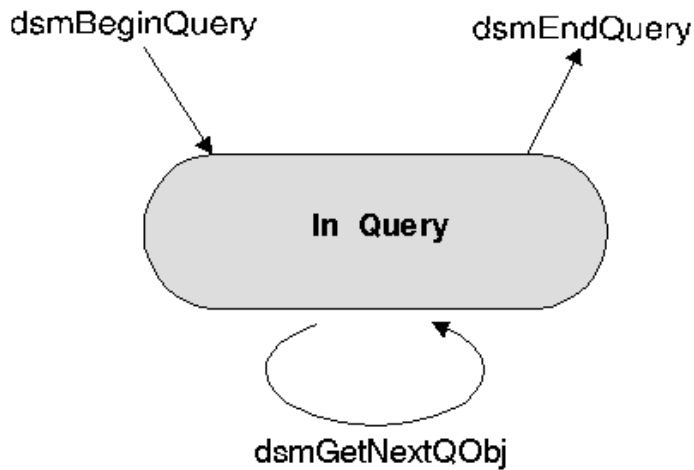
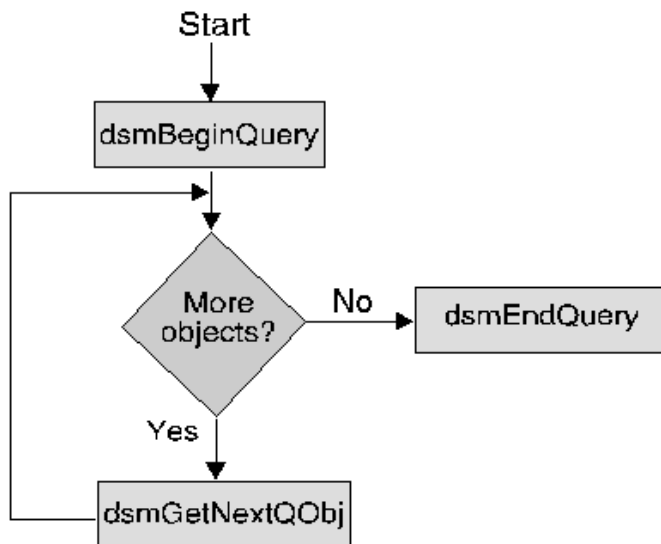

Figure 2 displays the flowchart for query operations.

Figure 2. Flowchart for general queries



- Example of querying the system  
In this example a management class query prints out the values of all the fields in the backup and archive copy groups for a particular management class.

## Server efficiency

Use these guidelines when you retrieve from, or send objects to, the IBM Spectrum Protect™ server.

- When you retrieve objects from the IBM Spectrum Protect server, follow these guidelines:
  - Retrieve data in the restore order that is provided by the IBM Spectrum Protect server. The restore order is especially important for tape devices, because retrieving data that is not ordered can result in tape rewinds and mounts.
  - Even when data is stored on a disk device, you can save time when the retrieves are ordered.
  - Perform as much work as possible in a single IBM Spectrum Protect server session.
  - Do not start and stop multiple sessions.
- When you send objects to the IBM Spectrum Protect server, follow these guidelines:
  - Send multiple objects in a single transaction.
  - Avoid sending one object per transaction, especially when the data is sent directly to a tape device. Part of the tape device transaction is to ensure that the data in the RAM buffers of the tape is written to media.

### Related concepts:

Selecting and sorting objects by restore order

### Related information:

## Sending data to a server

---

The API permits application clients to send data or named objects and their associated data to IBM Spectrum Protect™ server storage.

Tip: You can either back up or archive data. Perform all send operations within a transaction.

- The transaction model  
All data sent to IBM Spectrum Protect storage during a backup or archive operation is done within a transaction. A transaction model provides a high level of data integrity, but it does impose some restrictions that an application client must take into consideration.
- File aggregation  
IBM Spectrum Protect servers use a function that is called file aggregation. With file aggregation, all objects sent in a single transaction are stored together, which saves space and improves performance. You can still query and restore the objects separately.
- LAN-free data transfer  
The API can take advantage of LAN-free data transfer if the **dsmSetUp** option for multithreading is ON. The API returns the existence of a LAN-free destination in the **Query Mgmt Class** response structure **archDetailCG** or **backupDetailCG** field **bLanFreeDest**.
- Simultaneous-write operations  
You can configure IBM Spectrum Protect server storage pools to write simultaneously to a primary storage pool and copy storage pool or pools during a backup or archive. Use this configuration to create multiple copies of the object.
- Enhancing API performance  
You can use the **tcpbuffsize** and **tcpnodelay** client options and the **DataBlk** API parameter to enhance API performance.

## The transaction model

---

All data sent to IBM Spectrum Protect™ storage during a backup or archive operation is done within a transaction. A transaction model provides a high level of data integrity, but it does impose some restrictions that an application client must take into consideration.

Start a transaction by a call to **dsmBeginTxn** or end a transaction by a call to **dsmEndTxn**. A single transaction is an atomic action. Data sent within the boundaries of a transaction is either committed to the system at the end of the transaction or rolled back if the transaction ends prematurely.

Transactions can consist of either single object sends or multiple object sends. To improve system performance by decreasing system overhead, send smaller objects in a multiple object transaction. The application client determines whether single or multiple transactions are appropriate.

Send all objects within a multiple object transaction to the same copy destination. If you need to send an object to a different destination than the previous object, end the current transaction and start a new one. Within the new transaction, you can send the object to the new copy destination.

Note: Objects that do not contain any bit data ( *sizeEstimate=0* ) are not checked for copy destination consistency.

IBM Spectrum Protect limits the number of objects that can be sent in a multiple object transaction. To find this limit, call **dsmQuerySessInfo** and examine the **maxObjPerTxn** field. This field displays the value of the **TXNGroupmax** option that is set on your server.

The application client must keep track of the objects sent within a transaction to perform retry processing or error processing if the transaction ends prematurely. Either the server or the client can stop a transaction at any time. The application client must be prepared to handle sudden transaction ends that it did not start.

## File aggregation

---

IBM Spectrum Protect™ servers use a function that is called file aggregation. With file aggregation, all objects sent in a single transaction are stored together, which saves space and improves performance. You can still query and restore the objects separately.

To use this function, all of the objects in a transaction should have the same file space name. If the file space name changes within a transaction, the server closes the existing aggregated object and begins a new one.

## LAN-free data transfer

The API can take advantage of LAN-free data transfer if the **dsmSetUp** option for multithreading is ON. The API returns the existence of a LAN-free destination in the **Query Mgmt Class** response structure **archDetailCG** or **backupDetailCG** field **bLanFreeDest**.

You can use LAN-free operations on platforms that are supported by the storage agent. Macintosh platform is excluded.

LAN-free information is provided in the following output structures. The out structure (**dsmEndGetDataExOut\_t**) for **dsmEndGetData** includes the field, **totalLFBytesRecv**. This is the total number of LAN-free bytes that are received. The out structure (**dsmEndSendObjExOut\_t**) for **dsmEndSendObjEx** includes the field, **totalLFBytesSent**. This is the total number of LAN-free bytes that were sent.

### Related information:

[LAN-free data movement: Storage agent overview](#)

## Simultaneous-write operations

You can configure IBM Spectrum Protect™ server storage pools to write simultaneously to a primary storage pool and copy storage pool or pools during a backup or archive. Use this configuration to create multiple copies of the object.

If a simultaneous-write operation fails, the return code on the **dsmEndTxn** function might be **DSM\_RC\_ABORT\_STGPOOL\_COPY\_CONT\_NO**, which indicates that the write to one of the copy storage pools failed, and the IBM Spectrum Protect storage pool option **COPYCONTINUE** was set to **NO**. The application terminates and the problem must be resolved by the IBM Spectrum Protect server administrator.

For more information about setting up simultaneous-write operations, see the IBM Spectrum Protect server documentation.

## Enhancing API performance

You can use the **tcpbuffsize** and **tcpnodelay** client options and the **DataBlk** API parameter to enhance API performance.

Table 1 describes the actions that you can take to enhance the API performance.

Table 1. Backup-archive options and the API parameter that enhance performance

Backup-archive client options	Description
<b>tcpbuffsize</b>	Specifies the size of the TCP buffer. The default value is 31 KB. To enhance performance, set the value to 32 KB.
<b>tcpnodelay</b>	Specifies whether to send small buffers to the server rather than holding them. To enhance performance, set this option to <i>yes</i> for all platforms. This option is valid for Windows and AIX® only.
API parameter	Description
<b>DataBlk</b>	This parameter is used with the <b>dsmSendData</b> function call to determine the application buffer size. For best results, set the parameter as a multiple of the <i>tcpbuffsize</i> value that is specified with the <i>tcpbuffsize</i> minus 4 bytes. For example, set a value of 28 for this parameter when the value of <i>tcpbuffsize</i> is set to 32 KB.

Each **dsmSendData** call is synchronous and does not return until the data transferred to the API in the **dataBlkPtr** is flushed to the network. The API adds a 4-byte overhead to each transaction buffer that is placed on the network.

For example, when the transaction buffer size is 32 KB and the application **DataBlk** buffer size is 31 KB, then each application **DataBlk** buffer fits in a communications buffer and can be flushed immediately. However, if the application **DataBlk** buffer is exactly 32 KB, and because the API is adding 4 bytes per transaction buffer, two flushes are required; one of 32 KB and one of 4 bytes. Also, if you set the **tcpnodelay** option to **no**, flushing the 4 bytes might take up to 200 milliseconds.

## Set up the API to send performance data to the client performance monitor

---

The client performance monitor is a component of the Tivoli® Storage Manager Administration Center that is used to display performance data that is collected by the API. The client performance monitor records and displays performance data for client backup, archive, and restore operations.

With performance monitoring enabled, you can display performance data that is collected by the API by using the performance monitor; the performance monitor is available in the Tivoli Storage Manager Administration Center. Starting with version 7.1, the Administration Center component is no longer included in Tivoli Storage Manager or IBM Spectrum Protect™ distributions. If you have an Administration Center that was installed with a previous server release, you can continue to use it to display performance data. If you do not already have an Administration Center installed, you can download the previously-released version from <ftp://public.dhe.ibm.com/storage/tivoli-storage-management/maintenance/admincenter/v6r3/>. For information about using the performance monitor, see the Tivoli Storage Manager Version 6.3 server documentation.

- Configuring client performance monitor options  
You enable IBM Spectrum Protect clients to use the performance monitor by specifying parameters in the client options file. You specify these options for each client that you want to monitor.

## Sending objects to the server

---

Application clients can send data or named objects and their associated data to IBM Spectrum Protect™ storage by using the API backup and archive functions. The backup and archive components of the system permit use of different management procedures for data that is sent to storage.

The size estimate attribute is an estimate of the total size of the data object to send to the server. If the application does not know the exact object size, set the *sizeEstimate* to a higher estimate. If the estimate is smaller than the actual size, the IBM Spectrum Protect server uses extra resources to manage extra space allocations.

Tips:

- Be as accurate as is possible when you make this size estimate. The server uses this attribute for efficient space allocation and object placement within its storage resources.
- If the estimate is smaller than the actual size, a server with caching does not allocate extra space and stops the send.

You might encounter problems if the *sizeEstimate* is much too large. The server might not have enough space for the estimated size but does have space for the actual size; or the server might use slower devices.

You can back up or archive objects that are larger than two gigabytes in size. The objects can be either compressed or uncompressed.

To start a send operation, call **dsmSendObj**. If you have more data than you can send at one time, you can make repeated calls to **dsmSendData** to transfer the remainder of the information. Call **dsmEndSendObj** to complete the send operation.

- Understanding backup and archive objects  
The backup component of the IBM Spectrum Protect system supports several versions of named objects that are stored on the server.
- Compression  
Configuration options on a given node and the `dsmSendObj objCompressed` option, determine whether IBM Spectrum Protect compresses the object during a send. Also, objects with a `sizeEstimate` less than `DSM_MIN_COMPRESS_SIZE` are never compressed.
- Buffer copy elimination  
The buffer copy elimination function removes the copy of data buffers between an application and the IBM Spectrum Protect server, which results in better processor utilization. For maximum effect, use this approach in a LAN-free environment.
- API encryption  
Two methods are available to encrypt data: application-managed encryption and IBM Spectrum Protect client encryption.

## Understanding backup and archive objects

---

The backup component of the IBM Spectrum Protect™ system supports several versions of named objects that are stored on the server.

Any object backed up to the server that has the same name as an object that is already stored on the server from that client is subject to version control. Objects are considered to be in active or inactive states on the server. The latest copy of an object on



the server that has not been deactivated is in the active state. Any other object with the same name, whether it is an older version or a deactivated copy, is considered inactive. Management class constructs define different management criteria. They are assigned to active and inactive objects on the server.

Table 1 lists the copy group fields that apply to active and inactive states:

Table 1. Backup copy group fields

Field	Description
VEREXISTS	The number of inactive versions if active versions exist.
VERDELETED	The number of inactive versions if active versions do not exist.
RETEXTRA	The number of days to keep inactive versions.
REONLY	The number of days to keep the last inactive versions if active versions do not exist.

If backup versions each have a unique name, such as using a time stamp in the name, then versioning does not happen automatically: every object is active. Active objects never expire, so an application would be responsible for deactivating these with the **dsmDeleteObj** call. In this situation, the application would need the deactivated objects to expire as soon as possible. The user would define a backup copy group with VERDELETED=0 and RETONLY=0.

The archive component of the IBM Spectrum Protect system permits objects to be stored on the server with retention or expiration period controls instead of version control. Each object stored is unique, even though its name might be the same as an object already archived. Archive objects have a description field associated with the metadata that can be used during query to identify a specific object.

Every object on the IBM Spectrum Protect server is assigned a unique object ID. The persistence of the original value is not guaranteed during the life of an object (specifically, after an export or import). Therefore, an application should not query and save the original object ID for use on later restores. Rather, an application should save the object name and insert date. You can use this information during a restore to query objects and verify the insert date. Then, the current object ID can be used to restore the object.

## Compression

---

Configuration options on a given node and the **dsmSendObj objCompressed** option, determine whether IBM Spectrum Protect™ compresses the object during a send. Also, objects with a **sizeEstimate** less than **DSM\_MIN\_COMPRESS\_SIZE** are never compressed.

If the object is compressed already (**objCompressed=bTrue**), it is not compressed again. If it is not compressed, IBM Spectrum Protect decides whether to compress the object, based on the values of the compression option that is set by the administrator and that is set in the API configuration sources.

The administrator can change compression thresholds on the server by using the register node command (**compression=yes, no, or client-determined**). If this is client-determined, then the compression behavior is determined by the compression option value in the configuration sources.

Some types of data, such as data that is already compressed, might actually get bigger when processed with the compression algorithm. When this happens, the return code **DSM\_RC\_COMPRESS\_GREW** is generated. If you realize that this might happen, but you want the send operation to continue anyway, tell the end users to specify the following option in their options file:

```
COMPRESSAlways Yes
```

If, during a **dsmSendData** function, with compression enabled, you get **DSM\_RC\_COMPRESS\_GREW** return code, you might want to start over and send the object again without compression. To enforce this, set the **dsmSendObj ObjAttr.objCompressed** to **bTrue**.

Information about the actual compression behavior during a **dsmSendObj** is returned by the **dsmEndSendObjEx** call. **objCompressed** specifies if compression was done. **totalBytesSent** is the number of bytes sent by the application. **totalCompressedSize** is the number of bytes after compression. The **dsmEndSendObjEx** call also has a **totalLFBytesSent** field that contains the total bytes sent over LAN-free.

Attention: If your application plans to use partial object restore or retrieve, you cannot compress the data while sending it. To enforce this, set the **dsmSendObj ObjAttr.objCompressed** to **bTrue**.

- Compression type  
The type of compression that the client uses is determined by the combination of compression and client-side data deduplication that is used during backup or archive processing.

## Buffer copy elimination

---

The buffer copy elimination function removes the copy of data buffers between an application and the IBM Spectrum Protect™ server, which results in better processor utilization. For maximum effect, use this approach in a LAN-free environment.

The buffers for data movement are allocated by IBM Spectrum Protect and a pointer is passed back to the application. The application places the data in the provided buffer, and that buffer is passed through the communication layers to the storage agent by using shared memory. The data is then moved to the tape device, which eliminates copies of data. This function can be used with either backup or archive operations.

Attention: When you use this method, pay extra attention to proper buffer handling and sizes of buffers. The buffers are shared between the components and any memory overwrite that is a result of a programming error results in severe errors.

The overall sequence of calls for backup/archive is as follows:

```
dsmInitEx (UseTsmBuffers = True, numTsmBuffers = [how many IBM Spectrum Protect
        -allocated buffers the application needs to allocate])
dsmBeginTxn
for each object in the txn
    dsmBindMC
        dsmSendObject
            dsmRequestBuffer
            dsmSendBufferData (sends and release the buffer used)
        dsmEndSendObjEx
    dsmEndTxn
for each buffer still held
    dsmReleaseBuffer
dsmTerminate
```

The `dsmRequestBuffer` function can be called multiple times, up to the value that is specified by the `numTsmBuffers` option. An application can have two threads: a producer thread that fills buffers with data; and a consumer thread that sends those buffers to IBM Spectrum Protect with the `dsmSendBufferData` call. When a `dsmRequestBuffer` call is issued and the `numTsmBuffers` is reached, the `dsmRequestBuffer` call blocks until a buffer is released. The buffer release can happen by either calling `dsmSendBufferData`, which sends and releases a buffer or by calling `dsmReleaseBuffer`. For more information, see `callbuff.c` in the API sample directory.

If at any point there is a failure in the send, the application must release all the buffers that are held and terminate the session. For example:

```
If failure
    for each data buffer held by application
        call dsmReleaseBuffer
dsmTerminate
```

If an application calls `dsmTerminate` and a buffer is still held, the API does not exit. The following code is returned: `DSM_RC_CANNOT_EXIT_MUST_RELEASE_BUFFER`. If the application cannot release the buffer, the application must exit the process to force a cleanup.

- Buffer copy elimination and restore and retrieve  
The IBM Spectrum Protect server controls the amount of data to be placed in the buffer, based on tape access optimization with restore and retrieve. This method is not as beneficial to the application as the normal method of getting data. During prototyping, check the performance of the buffer copy elimination method and use this method only if you see a worthwhile improvement.

## API encryption

---

Two methods are available to encrypt data: application-managed encryption and IBM Spectrum Protect™ client encryption.

Select and use only one of these methods to encrypt data. The methods are mutually exclusive and if you encrypt data by using both methods, you will be unable to restore or retrieve some data. For example, assume that an application uses application-managed encryption to encrypt object A, and then uses IBM Spectrum Protect client encryption to encrypt object B. During a

restore operation, if the application sets the option to use IBM Spectrum Protect client encryption and it tries to restore both objects, only object B can be restored; object A cannot be restored because it was encrypted by the application, not by the client.

Regardless of the encryption method that is used, the IBM Spectrum Protect must enable password authentication. By default, the server uses `SET AUTHENTICATION ON`.

The API uses either AES 128-bit or AES 256-bit encryption. AES 256-bit data encryption provides a higher level of data encryption than AES 128-bit data encryption. Files that are backed up by using AES 256-bit encryption cannot be restored with an earlier client. Encryption can be enabled with or without compression. If you use encryption, you cannot use the partial object restore and retrieve and buffer copy elimination functions.

- Application-managed encryption  
With application-managed encryption, the application provides the key password to the API (using key `DSM_ENCRYPT_USER`) and it is the application's responsibility to manage the key password.
- IBM Spectrum Protect client encryption  
IBM Spectrum Protect client encryption uses the key that is managed by the `DSM_ENCRYPT_CLIENTENCRKEY` value to protect your data. Client encryption is transparent to the application that is using the API, with the exception that partial object restore operations and retrieve operations are not possible for objects that were encrypted or compressed.

## Application-managed encryption

With application-managed encryption, the application provides the key password to the API (using key `DSM_ENCRYPT_USER`) and it is the application's responsibility to manage the key password.

Attention: If the encryption key is not saved, and you forgot the key, your data is unrecoverable.

The application provides the key password in the `dsmInitEx` call and must provide the proper key password at restore time.

Attention: If the key password is lost, there is no way to restore the data.

The same key password must be used for backup and restore (or archive and retrieve) operations for the same object. This method does not have a dependency on the IBM Spectrum Protect™ server level. To set up this method, the application needs to follow these steps:

1. Set the `bEncryptKeyEnabled` variable to `bTrue` in the call to `dsmInitEx`, and set the `encryptionPasswordP` variable to point to a string with the encrypt key password.
2. Set the `include.encrypt` for the objects to encrypt. For example, to encrypt all data, set:

```
include.encrypt /.../* (UNIX)
```

and

```
include.encrypt *\...\* (Windows)
```

To encrypt the object `/FS1/DB2/FULL`, set:

```
include.encrypt /FS1/DB2/FULL
```

3. Set `ENCRYPTKEY=PROMPT|SAVE` in the option string that is passed to the API in the `dsmInitEx` call on Windows. This option can also be set in `dsm.opt` (Windows) or `dsm.sys` (UNIX or Linux).

By default, the `encryptkey` option is set to `prompt`. This setting ensures that the key does not get stored automatically. If `encryptkey save` is specified, the key is stored by IBM Spectrum Protect on the local machine but then only one key can be valid for all IBM Spectrum Protect operations with the same node name.

After a send of an object, the `dsmEndSendObjEx` specifies whether an object was encrypted and which method was used. Possible values in the `encryptionType` field:

- `DSM_ENCRYPT_NO`
- `DSM_ENCRYPT_USER`
- `DSM_ENCRYPT_CLIENTENCRKEY`

The following table lists the API encryption types, prerequisites, and the functions that are available.

Table 1. API encryption types, prerequisites, and functions available

Type	Prerequisite	Function available
------	--------------	--------------------

Type	Prerequisite	Function available
ENCRYPTIONTYPE	None	Set the ENCRYPTIONTYPE in the option string that is passed to the API in the dsminitEx call on Windows. ENCRYPTIONTYPE=AES128 by default.
EncryptKey=save	None	API and backup-archive
EncryptKey=prompt	None	API and backup-archive
EncryptKey=generate	None	API and backup-archive
EnableClientEncryptKey	None	API only

Note: It is advised that the server has authentication turned ON. If authentication is turned OFF, the key is not encrypted, but the data is still encrypted. However, this is not recommended.

Table 2 shows how both Authorized Users and non-Authorized Users can encrypt or decrypt data during a backup or restore operation, depending on the value that is specified for the passwordaccess option. The TSM.PWD file must exist to perform the following authorized-user and non-authorized-user operations. The authorized user creates the TSM.PWD file and sets the encryptkey option to save and the passwordaccess option to generate.

Table 2. Encrypting or decrypting data with application managed key on UNIX or Linux

Operation	passwordaccess option	encryptkey option	Result
Authorized user backup	generate	save	Data encrypted.
	generate	prompt	Data encrypted if encryptionPasswordP contains an encryption password.
	prompt	save	Data encrypted if encryptionPasswordP contains an encryption password.
	prompt	prompt	Data encrypted if encryptionPasswordP contains an encryption password.
Authorized user restore	generate	save	Data encrypted.
	generate	prompt	Data encrypted if encryptionPasswordP contains an encryption password.
	prompt	save	Data encrypted if encryptionPasswordP contains an encryption password.
	prompt	prompt	Data encrypted if encryptionPasswordP contains an encryption password.
Non-authorized user backup	generate	save	Data encrypted.
	generate	prompt	Data encrypted if encryptionPasswordP contains an encryption password.
	prompt	save	Data encrypted if encryptionPasswordP contains an encryption password.
	prompt	prompt	Data encrypted if encryptionPasswordP contains an encryption password.
Non-authorized user restore	generate	save	Data encrypted.
	generate	prompt	Data encrypted if encryptionPasswordP contains an encryption password.
	prompt	save	data encrypted if encryptionPasswordP contains an encryption password.
	prompt	prompt	Data encrypted if encryptionPasswordP contains an encryption password.

## IBM Spectrum Protect client encryption

IBM Spectrum Protect™ client encryption uses the key that is managed by the DSM\_ENCRYPT\_CLIENTENCRKEY value to protect your data. Client encryption is transparent to the application that is using the API, with the exception that partial object restore operations and retrieve operations are not possible for objects that were encrypted or compressed.

For both IBM Spectrum Protect client encryption and application-managed encryption, the encryption password refers to a string value that is used to generate the actual encryption key. The value for the encryption password option is 1-63 characters in length, but the key that is generated from it is always 8 bytes for 56 DES, 16 bytes for 128 AES, and 32 bytes for 256 AES.

Attention: If the encryption key is not available, data cannot be restored or retrieved. When you use ENABLECLIENTENCRYPTKEY for encryption, the encryption key is stored on the server database. For objects that use this method, the server database must exist and have the proper values for the objects for a proper restore. Ensure that you back up the server database frequently to prevent data loss.

This is the simpler method to implement, where one random encryption key is generated per session and it is stored on the IBM Spectrum Protect server with the object in the server database. During restore, the stored key is used for decryption. Using this method, the management of the key is the responsibility of IBM Spectrum Protect, and the application does not have to deal with the key at all. Because the key is stored in the server database, you must have a valid IBM Spectrum Protect database for a restore operation of an encrypted object. When the key is transmitted between the API and the server, it is also encrypted. The transmission of the key is secure, and when the key is stored in the IBM Spectrum Protect server database it is encrypted. The only time that the key is placed in the clear with the export data stream is when a node's data are exported between servers.

To enable IBM Spectrum Protect client encryption, complete the following steps:

1. Specify -ENABLECLIENTENCRYPTKEY=YES in the option string that is passed to the API on the dsmInitEx call or set the option in the system option file dsm.opt (Windows) or dsm.sys (UNIX or Linux).
2. Set the include.encrypt for the objects to encrypt. For example, to encrypt all data, set:

```
include.encrypt /.../* (UNIX)
```

and

```
include.encrypt *\.../* (Windows)
```

To encrypt the object /FS1/DB2/FULL, set:

```
include.encrypt /FS1/DB2/FULL
```

## Data deduplication

---

Data deduplication is a method of reducing storage needs by eliminating redundant data.

### Overview

---

Two types of data deduplication are available on IBM Spectrum Protect™: *client-side data deduplication* and *server-side data deduplication*.

*Client-side data deduplication* is a data deduplication technique that is used on the backup-archive client to remove redundant data during backup and archive processing before the data is transferred to the IBM Spectrum Protect server. Using client-side data deduplication can reduce the amount of data that is sent over a local area network.

*Server-side data deduplication* is a data deduplication technique that is done by the server. The IBM Spectrum Protect administrator can specify the data deduplication location (client or server) to use with the DEDUP parameter on the REGISTER NODE or UPDATE NODE server command.

### Enhancements

---

With client-side data deduplication, you can:

- Exclude specific files on a client from data deduplication.
- Enable a data deduplication cache that reduces network traffic between the client and the server. The cache contains extents that were sent to the server in previous incremental backup operations. Instead of querying the server for the existence of an extent, the client queries its cache.

Specify a size and location for a client cache. If an inconsistency between the server and the local cache is detected, the local cache is removed and repopulated.

Note: For applications that use the IBM Spectrum Protect API, the data deduplication cache must not be used because of the potential for backup failures caused by the cache being out of sync with the IBM Spectrum Protect server. If multiple, concurrent backup-archive client sessions are configured, there must be a separate cache configured for each session.

- Enable both client-side data deduplication and compression to reduce the amount of data that is stored by the server. Each extent is compressed before it is sent to the server. The trade-off is between storage savings and the processing power that is required to compress client data. In general, if you compress and deduplicate data on the client system, you are using approximately twice as much processing power as data deduplication alone.

The server can work with deduplicated, compressed data. In addition, backup-archive clients earlier than V6.2 can restore deduplicated, compressed data.

Client-side data deduplication uses the following process:

- The client creates extents. *Extents* are parts of files that are compared with other file extents to identify duplicates.
- The client and server work together to identify duplicate extents. The client sends non-duplicate extents to the server.
- Subsequent client data-deduplication operations create new extents. Some or all of those extents might match the extents that were created in previous data-deduplication operations and sent to the server. Matching extents are not sent to the server again.

## Benefits

---

Client-side data deduplication provides several advantages:

- It can reduce the amount of data that is sent over the local area network (LAN).
- The processing power that is required to identify duplicate data is offloaded from the server to client nodes. Server-side data deduplication is always enabled for deduplication-enabled storage pools. However, files that are in the deduplication-enabled storage pools and that were deduplicated by the client, do not require additional processing.
- The processing power that is required to remove duplicate data on the server is eliminated, allowing space savings on the server to occur immediately.

Client-side data deduplication has a possible disadvantage. The server does not have whole copies of client files *until* you back up the primary storage pools that contain client extents to a non-deduplicated copy storage pool. (*Extents* are parts of a file that are created during the data-deduplication process.) During storage pool backup to a non-deduplicated storage pool, client extents are reassembled into contiguous files.

By default, primary sequential-access storage pools that are set up for data deduplication must be backed up to non-deduplicated copy storage pools before they can be reclaimed and before duplicate data can be removed. The default ensures that the server has copies of whole files at all times, in either a primary storage pool or a copy storage pool.

Important: For further data reduction, you can enable client-side data deduplication and compression together. Each extent is compressed before it is sent to the server. Compression saves space, but it increases the processing time on the client workstation.

The following options pertain to data deduplication:

- Deduplication
- Dedupcachepath
- Dedupcachesize
- Enablededupcache
- Exclude.dedup
- Include.dedup
  
- API client-side data deduplication  
*Client-side data deduplication* is used by the API on the backup-archive client, to remove redundant data during backup and archive processing before the data is transferred to the IBM Spectrum Protect server.
- Server-side data deduplication  
Server-side data deduplication is data deduplication that is performed by the server.

## API client-side data deduplication

---

*Client-side data deduplication* is used by the API on the backup-archive client, to remove redundant data during backup and archive processing before the data is transferred to the IBM Spectrum Protect™ server.

Client-side data deduplication is used by the API, to remove redundant data during backup and archive processing before the data is transferred to the IBM Spectrum Protect server. Using client-side data deduplication can reduce the amount of data that is sent over a local area network. Using client-side data deduplication can also reduce the IBM Spectrum Protect server storage space.

When the client is enabled for client-side data deduplication, and you perform a backup or archive operation, the data is sent to the server as extents. The next time a backup or archive operation is performed, the client and server identify which data extents have already been backed up or archived, and send only the unique extents of data to the server.

For client-side data deduplication, the server and API must be at version 6.2 or later.

Before you use client-side data deduplication to back up or archive your files, the system must meet the following requirements:

- The client must have the deduplication option enabled.
- The server must enable the client for client-side data deduplication with the DEDUP=CLIENTORSERVER parameter on either the REGISTER NODE or UPDATE NODE command.
- The storage pool destination for the data must be a data deduplication-enabled storage pool. The data deduplication-enabled storage pool is file device type only.
- Ensure that the files are bound to the correct management class.
- A file can be excluded from client-side data deduplication processing. By default, all files are included.
- Files must be larger than 2 KB.
- The server can limit the maximum transaction size for data deduplication by setting the CLIENTDEDUPTXNLIMIT option on the server. See the server documentation information about this option.

If any of these requirements are not met, data is processed normally, with no client-side data deduplication.

Here are some data deduplication restrictions:

- LAN-free data movement and client-side data deduplication are mutually exclusive. If you enable both LAN-free data movement and client-side data deduplication, LAN-free data movement operations complete and client-side data deduplication is ignored.
- Encryption and client-side data deduplication are mutually exclusive. If you enable both encryption and client-side data deduplication, encryption operations complete and client-side data deduplication is ignored. Encrypted files, and files that are eligible for client-side data deduplication, can be processed in the same operation, but are done in separate transactions.

Requirements:

1. In any transaction, all files must be either included for data deduplication or excluded. If the transaction has mixed files, the transaction fails, and a return code of DSM\_RC\_NEEDTO\_ENDTXN is returned by the API.
  2. Use storage device encryption together with client-side data deduplication. Because SSL is used in combination with client-side deduplication, there is no need for client encryption.
- The following functions are not available for client-side data deduplication:
    - IBM Spectrum Protect for Space Management (HSM) client
    - API shared buffer
    - NAS
    - Subfile backup
  - Buffer copy elimination cannot be used with data transformations like compression, encryption, and data deduplication.
  - If you use client-side deduplication, the API detects and fails (with RC=254) backups of file extents that are marked as expired on the server during sending data to the server. If you want to retry the operation, you need to include that programming in the calling application.
  - Simultaneous-write operations on the server takes precedence over client-side data deduplication. If simultaneous-write operations are enabled, client-side data deduplication does not occur.  
Restriction: When client side data deduplication is enabled, the API cannot recover from a state where the server has run out of storage on the destination pool, even if there is a next pool defined. A stop reason code of DSM\_RS\_ABORT\_DESTINATION\_POOL\_CHANGED is returned and the operation fails. There are two ways to recover from this situation:
    1. Ask the administrator to add more scratch volumes to the original filepool.
    2. Retry the operation with data deduplication disabled.

For even greater bandwidth savings, you can enable a local cache for data deduplication. The local cache saves queries from going to the IBM Spectrum Protect server. The default value for ENABLEDEDUPCACHE is NO, so that the cache is not out of sync with the server. If the cache is out of sync with the server, the application resends all data. If your application can retry on a failed transaction, and you want to use the local cache, set the ENABLEDEDUPCACHE option to YES in the dsm.opt (Windows) or dsm.sys (UNIX) file.

At the end of a restore, if *all* of the data was restored through the API, and the object was deduplicated by the client, an end-to-end digest is calculated and compared to the value calculated at backup time. If those values do not match, error DSM\_RC\_DIGEST\_VALIDATION\_ERROR is returned. If an application receives this error, the data is corrupt. This error can also be a result of a transient error on the network, so try the restore or retrieve again.

Here is an example of the query session command showing data deduplication information:

```
dsmQuerySessInfo Values:
Server Information:
Server name: SERVER1
Server Host: AVI
Server port: 1500
Server date: 2009/10/6 20:48:51
Server type: Windows
Server version: 6.2.0.0
Server Archive Retention Protection : NO
Client Information:
Client node type: API Test1
Client filespace delimiter: :
Client hl & ll delimiter: \
Client compression: Client determined (3u)
Client archive delete: Client can delete archived objects
Client backup delete: Client CANNOT delete backup objects
Maximum objects in multiple object transactions: 4096
Lan free Enabled: NO
Deduplication : Client Or Server
General session info:
Node: AVI
Owner:
API Config file:
```

Here is an example of the query management class command showing data deduplication information:

```
Policy Information:
Domain name: DEDUP
Policysset name: DEDUP
Policy activation date: 0/0/0 0:0:0
Default management class: DEDUP
Backup retention grace period: 30 days
Archive retention grace period: 365 days
Mgmt. Class 1:
Name: DEDUP
Description: dedup - values like standard
Backup CG Name: STANDARD
Frequency: 0
Ver. Data Exists: 2
Ver. Data Deleted: 1
Retain Extra Ver: 30
Retain Only Ver: 60
Copy Destination: AVIFILEPOOL
Lan free Destination: NO
Deduplicate Data: YES

Archive CG Name: STANDARD
Frequency: 10000
Retain versions: 365
Copy Destination: AVIFILEPOOL
Lan free Destination: NO
Retain Init : CREATE
Retain Minimum : 65534
Deduplicate Data: YES
```

- Exclude files from data deduplication  
You can choose to exclude backup or archive files from data deduplication.
- Include files for data deduplication  
You can choose to include backup or archive files for data deduplication.

**Related reference:**

Deduplication option  
Exclude option  
Dedupcachepath option  
Dedupcachesize option



Enablededupcache option  
Ieobjtype option

## Exclude files from data deduplication

---

You can choose to exclude backup or archive files from data deduplication.

To exclude files from data deduplication processing, follow these steps:

1. Set the `exclude.dedup` option for the objects to exclude.

For example, to exclude all dedup data for UNIX systems, set:

```
exclude.dedup /.../*
```

2. To exclude all dedup data for Windows systems, set:

```
exclude.dedup *\\...\\*
```

Important: If an object is sent to a data deduplication pool, data deduplication occurs on the server, even if the object is excluded from client-side data deduplication.

## Include files for data deduplication

---

You can choose to include backup or archive files for data deduplication.

To refine the list of files to be included, the `include.dedup` option can be used in combination with the `exclude.dedup` option.

By default, all eligible objects are included for data deduplication.

Here are some UNIX and Linux examples:

```
exclude.dedup /FS1/.../*
```

```
include.dedup /FS1/archive/*
```

Here are some Windows examples:

```
exclude.dedup E:\myfiles\...\\*
```

```
include.dedup E:\myfiles\archive\\*
```

## Server-side data deduplication

---

Server-side data deduplication is data deduplication that is performed by the server.

The IBM Spectrum Protect™ administrator can specify the data deduplication location (client or server) to use with the `DEDUP` parameter on the `REGISTER NODE` or `UPDATE NODE` server command.

In a data deduplication-enabled storage pool (file pool), only one instance of a data extent is retained. Other instances of the same data extent are replaced with a pointer to the retained instance.

For more information about server-side data deduplication, see the IBM Spectrum Protect server documentation.

## Application failover

---

When the IBM Spectrum Protect™ server becomes unavailable because of an outage, applications that use the API can automatically fail over to a secondary server for data recovery.

The IBM Spectrum Protect server that the client and API connects to during normal production processes is called the *primary server*. When the primary server is set up for node replication, that server is also known as the *source replication server*. The client node data on the source replication server can be replicated to the *target replication server*. This server is also known as the *secondary server*, and is the server that the client automatically fails over to when the primary server fails.

The client and API must be configured for automated client failover, and must connect to a version 7.1 (or later) server that replicates client node data. The configuration for the API is the same as the configuration for the backup-archive client.

During normal operations, connection information for the secondary server is automatically sent to the client from the primary server during the logon process. The secondary server information is automatically saved to the client options file.

Each time the client application logs on to the IBM Spectrum Protect server, it attempts to contact the primary server. If the primary server is unavailable, the application automatically fails over to the secondary server by using the secondary server information in the client options file. In failover mode, the application can query the secondary server and restore or retrieve replicated data.

You must back up the application at least one time to the primary server. The API can fail over to the secondary server to recover data only if the data from the client node was replicated from the primary server to the secondary server.

- Failover status information  
The API provides status information that applications can use to determine the failover status and the status of replicated client data on the secondary server.

**Related concepts:**

Automated client failover configuration and use

## Example flow diagrams for backup and archive

---

The API is designed for straightforward logic flows and clear transitions between the various states of the application client. This clean state transition catches logic flaws and program errors early in the development cycle, greatly enhancing the quality and reliability of the system.

For example, you cannot make a **dsmSendObj** call unless a transaction was started and a **dsmBindMC** call was previously made for the object that you are backing up.

Figure 1 displays the state diagram for performing backup or archive operations within a transaction. The arrow pointing from "In Send Object" to **dsmEndTxn** indicates that a **dsmEndTxn** call can be started after a call to **dsmSendObj** or **dsmSendData**. You might want to do this if an error condition occurred during the send of an object and you want to stop the entire operation. In this case, you must use a vote of DSM\_VOTE\_ABORT. In normal circumstances, however, call **dsmEndSendObj** before you end the transaction.

Figure 1. State diagram for backup and archive operations

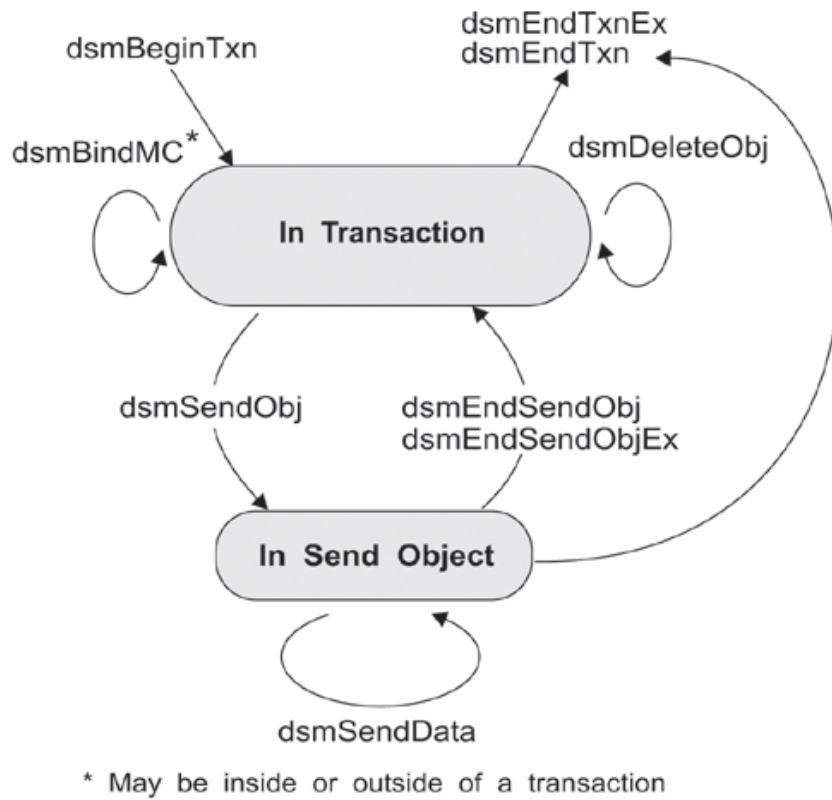
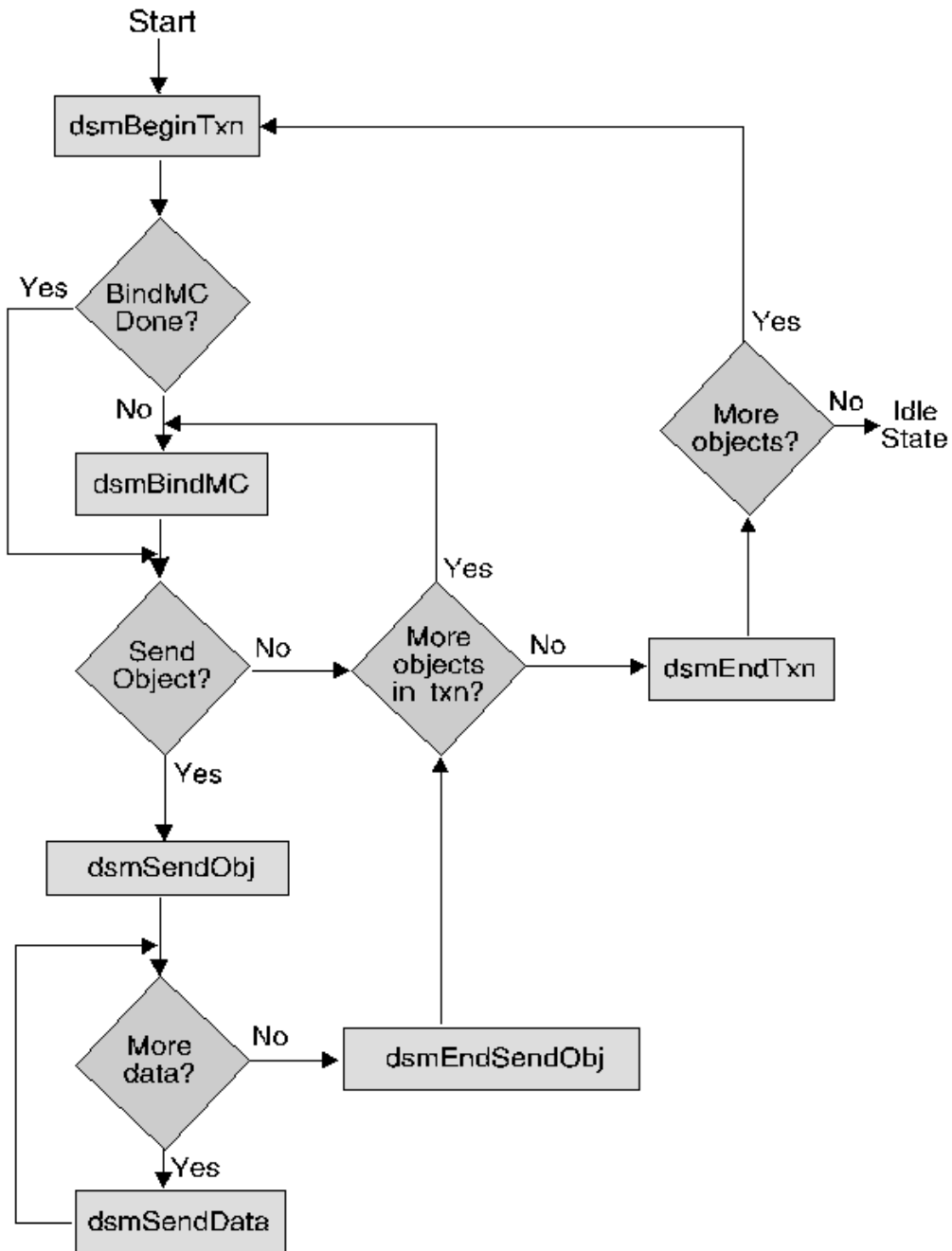

Figure 2 displays the flowchart for performing backup or archive operations within a transaction.

Figure 2. Flowchart for backup and archive operations



The primary feature in these two diagrams is the loop between the following API calls from within a transaction:

- **dsmBindMC**
- **dsmSendObj**
- **dsmSendData**
- **dsmEndSendObj**

The **dsmBindMC** call is unique in that you can start it from inside or outside of a transaction boundary. You can also start it from a different transaction, if required. The only requirement for the **dsmBindMC** call is that it is made prior to backing up or archiving an object. If the object that you are backing up or archiving is not associated with a management class, an error code is returned from **dsmSendObj**. In this situation, the transaction is ended by calling **dsmEndTxn** (this error condition is not shown in the flowchart).

The flowchart illustrates how an application would use multiple object transactions. It shows where decision points can be placed to determine if the object that is sent fits within the transaction or whether to start a new transaction.

- Code example of API functions that send data to IBM Spectrum Protect storage  
This example demonstrates the use of the API functions that send data to IBM Spectrum Protect™ storage. The **dsmSendObj** call appears inside a switch statement, so that different parameters can be called depending on whether a backup or archive operation is being performed.

## File grouping

The IBM Spectrum Protect™ API has a logical file grouping protocol that relates several individual objects together. You can reference and manage these groups as a logical group on the server. A logical group requires that all group members and the group leader belong to the same node and file space on the server.

Each logical group has a group leader. If the group leader is deleted, the group is deleted. You cannot delete a member that is part of a group. Expiration of all members in a group is dependent on the group leader. For example, if a member is marked for expiration, the member does not expire unless the group leader expires. However, if a member is not marked for expiration, and the group leader is expired, then all members are expired.

File groups contain backup data only, and cannot contain archive data. Archive objects can use the **Archive Description** field to facilitate a type of grouping if required by an application.

The **dsmGroupHandler** call groups the operations. The **dsmGroupHandler** function must be called from within a transaction. Most group error conditions are caught on either the **dsmEndTxnI** or **dsmEndTxnEx** calls.

The `out` structure in **dsmEndTxnEx** includes a new field, **groupLeaderObjId**. This field contains the object ID of the group leader if a group was opened in that transaction. You can create a group across more than one transaction. A group is not committed, or saved, on the server until a close is performed. The **dsmGroupHandler** is an interface that can accept five different operations. They include:

- DSM\_GROUP\_ACTION\_OPEN
- DSM\_GROUP\_ACTION\_CLOSE
- DSM\_GROUP\_ACTION\_ADD
- DSM\_GROUP\_ACTION\_ASSIGNTO
- DSM\_GROUP\_ACTION\_REMOVE

Table 1 lists the **dsmGroupHandler** function call actions:

Table 1. dsmGroupHandler functions

Action	Description
OPEN	The OPEN action creates a group. The next object that is sent becomes the group leader. The group leader cannot have content. All objects after the first object become members that are added to the group. To create a group, open a group and pass in a unique string to identify the group. This unique identifier allows several groups with the same name to be opened. After the group is opened, the next object that is sent is the group leader. All other objects that are sent are group members.
CLOSE	The CLOSE action commits and saves an open group. To close the group, pass in the object name and the unique string that is used in the open operation. The application must check for open groups and, if necessary, close or delete the groups. A group is not committed or saved until the group is closed. A CLOSE action fails in the following conditions: <ul style="list-style-type: none"> <li>• The group that you are trying to close has the same name as an existing open group.</li> <li>• A management class incompatibility exists between the current closed group and the new group to be closed of the same name. In this case, complete the following steps: <ol style="list-style-type: none"> <li>1. Query the previous closed group.</li> <li>2. If the management class of the existing closed group is different from the management class associated with the current open group, issue a <b>dsmUpdateObject</b> with type <code>DSM_BACKUPD_MC</code>. This command updates the existing group to the new management class.</li> <li>3. Issue the CLOSE action.</li> </ol> </li> </ul>
ADD	The ADD action appends an object to a group. All objects that are sent after the ADD action are assigned to the group.

Action	Description
ASSIGNTO	<p>The ASSIGNTO action permits the client to assign objects that exist on the server to the declared peer group. This transaction sets up the PEER group relationship. The ASSIGNTO action is similar to the ADD action, with the following exceptions:</p> <ul style="list-style-type: none"> <li>• The ADD action applies to objects within an in-flight transaction.</li> <li>• The ASSIGNTO action applies to an object that is on the server.</li> </ul>
REMOVE	<p>The REMOVE action removes a member, or a list of members, from a group. A group leader cannot be removed from a group. A group member must be removed before the member can be deleted.</p>

Use the following query types for group support:

- **qtBackupGroups**
- **qtOpenGroups**

The **qtBackupGroups** queries groups that are closed while **qtOpenGroups** queries groups that are open. The query buffer for the new types has fields for **groupLeaderObjId** and **objType**. The query performs differently depending on the values for these two fields. The following table includes some query possibilities:

Table 2. Examples of queries

groupLeaderObjId.hi	groupLeaderObjId.lo	objType	Result
0	0	NULL	Returns a list of all group leaders
grpLdrObjId.hi	grpLdrObjId.lo	0	Returns a list for all group members that are assigned to the specified group leader ( <b>grpLdrObjId</b> ).
grpLdrObjId.hi	grpLdrObjId.lo	objType	Returns a list by using <b>BackQryRespEnhanced3</b> , for each group member that is assigned to the specified group leader ( <b>grpLdrObjId</b> ), and matching the object type ( <b>objType</b> ).

The response structure (**qryRespBackupData**) from **dsmGetNextQObj** includes two fields for group support:

- **isGroupLeader**
- **isOpenGroup**

These fields are Boolean flags. The following example displays the creation of the group, adding members to the group, and closing the group to commit the group on the IBM Spectrum Protect server.

Figure 1. Example of pseudo-code that is used to create a group

```

dsmBeginTxn
    dsmGroupHandler (PEER, OPEN, leader, uniqueId)
    dsmBeginSendObj
        dsmEndSendObj
    dsmEndTxnEx (With objId of leader)
Loop for multiple txns
{
    dsmBeginTxn
        dsmGroupHandler (PEER, ADD, member, groupLeaderObjID)
        Loop for multiple objects
        {
            dsmBeginSendObj
            Loop for data
            {
                dsmSendData
            }
            dsmEndSendObj
        }
    dsmEndTxn
}
dmBeginTxn
    dsmGroupHandler (CLOSE)
dsmEndTxn

```

For a code example, see the sample group program `dsmgrp.c` that is included in the API `sampsr` directory.

## Receiving data from a server

---

Application clients can receive data or named objects and their associated data from IBM Spectrum Protect™ storage by using the restore and retrieve functions. The restore function accesses objects that previously were backed up, and the retrieve function accesses objects that previously were archived.

Restriction: The API can only restore or retrieve objects that were backed up or archived using API calls.

Both restore and retrieve functions start with a query operation. The query returns different information depending on whether the data was originally backed up or archived. For instance, a query on backup objects returns information on whether an object is active or inactive, while a query on archive objects returns information such as object descriptions. Both queries return object IDs that are used to uniquely identify the object on the server.

- Partial object restore or retrieve  
The application client can receive only a portion of the object. This is called a partial object restore or a partial object retrieve.
- Restoring or retrieving data  
After a query is made and a session is established with the IBM Spectrum Protect server, you can run a procedure to restore or retrieve data.
- Example flow diagrams for restore and retrieve  
A state diagram and a flowchart can be used to illustrate how to perform restore or retrieve operations.
- Code example of receiving data from a server  
This example demonstrates using the API functions to retrieve data from IBM Spectrum Protect storage.

## Partial object restore or retrieve

---

The application client can receive only a portion of the object. This is called a partial object restore or a partial object retrieve.

Attention: Partial restore or retrieve of compressed or encrypted objects produces unpredictable results.

Note: If you code your application to use a partial object restore or retrieve, you cannot compress the data while sending it. To enforce this, set *ObjAttr.objCompressed* to *bTrue*.

To perform a partial object restore or retrieve, associate the following two data fields with each object **GetList** entry:

offset

The byte offset into the object from which to begin returning data.

length

The number of object bytes to return.

Use `DSM_MAX_PARTIAL_GET_OBJ` to determine the maximum number of objects that can perform a partial object restore or retrieve for a specific **dsmBeginGetData** list.

The following data fields, used on the **dsmBeginGetData** call, determine what portion of the object is restored or retrieved:

- If both the offset and length are zero, the entire object is restored or retrieved from IBM Spectrum Protect™ storage.
- If the offset is greater than zero, but the length is zero, the object is restored or retrieved from the offset to the end.
- If the length is greater than zero, only the portion of the object from the offset for the specified length is restored or retrieved.

## Restoring or retrieving data

---

After a query is made and a session is established with the IBM Spectrum Protect™ server, you can run a procedure to restore or retrieve data.

### Procedure

---

To restore or retrieve data, complete the following steps:

1. Query the IBM Spectrum Protect server for either backup or archive data.
2. Determine the objects to restore or retrieve from the server.
3. Sort the objects on the Restore Order field.
4. Send the **dsmBeginGetData** call with the list of objects that you want to access.

5. Send the `dsmGetObj` call to obtain each object from the system. Multiple `dsmGetData` calls might be needed for each object to obtain all associated object data. Send the `dsmEndGetObj` call after all data for an object is obtained.
  6. Send the `dsmEndGetData` call after all data for all objects is received, or to end the receive operation.
- Querying the server  
Before you begin any restore or retrieve operation, first query the IBM Spectrum Protect server to determine what objects you can receive from storage.
  - Selecting and sorting objects by restore order  
After the backup or archive query is performed, the application client must determine which objects, if any, are to be restored or retrieved.
  - Starting the `dsmBeginGetData` call  
After you select and sort the objects to receive, submit them to IBM Spectrum Protect for either a restore or retrieve operation. The **`dsmBeginGetData`** call begins a restore or retrieve operation. The objects are returned to the application client in the order you requested.
  - Receiving each object to restore or retrieve  
After the `dsmBeginGetData` call is sent, you can perform a procedure to receive each object that is sent from the server.

## Querying the server

Before you begin any restore or retrieve operation, first query the IBM Spectrum Protect™ server to determine what objects you can receive from storage.

To send the query, the application must enter the parameter lists and structures for the `dsmBeginQuery` call. The structure must include the file space that the query examines and pattern-match entries for the high-level and low-level name fields. If the session was initialized with a NULL owner name, you do not need to specify the owner field. However, if the session was initialized with an explicit owner name, only objects that are associated with that owner name are returned.

The point-in-time `BackupQuery` query provides a snapshot of the system at a specific time. By specifying a valid date, you can query all files that are backed up to that time. Even if an object has an active backup from a later date, point-in-time overrides an object state so that the previous inactive copy is returned. For more information, see the following example: `pitDate`.

A query returns all information that is stored with the object, in addition to the information in the following table.

Table 1. Query to the server return information

Field	Description
<code>copyId</code>	The <code>copyIdHi</code> and <code>copyIdLo</code> values provide an 8-byte number that uniquely identifies this object for this node in IBM Spectrum Protect storage. Use this ID to request a specific object from storage for restore or retrieve processing.
<code>restoreOrderExt</code>	The <code>restoreOrderExt</code> value provides a mechanism for receiving objects from IBM Spectrum Protect storage in the most efficient manner possible. Sort the objects to restore on this value to ensure that tapes are mounted only one time and are read from front to back.

You must keep some or all of the query information for later processing. Keep the `copyId` and `restoreOrderExt` fields because they are needed for the actual restore operation. You must also keep any other information needed to open a data file or identify a destination.

Call `dsmEndQuery` to finish the query operation.

## Selecting and sorting objects by restore order

After the backup or archive query is performed, the application client must determine which objects, if any, are to be restored or retrieved.

Then you sort the objects in ascending order (low to high). This sorting is very important to the performance of the restore operation. Sorting the objects on the **`restoreOrderExt`** fields ensures that the data is read from the server in the most efficient order.

All data on disk is restored first, followed by data on media classes that require volume mounts (such as tape). The **`restoreOrderExt`** field also ensures that data on tape is read in order with processing starting at the front of a tape and progressing towards the end.



Properly sorting on the **restoreOrderExt** field means that duplicate tape mounts and unnecessary tape rewinds do not occur.

A non-zero value in the **restoreOrderExt.top** field correlates to a unique serial access device on the IBM Spectrum Protect™ server. Since a serial access device can only be used by one session / mount point at a time, the application should ensure that if it uses multiple sessions there are not concurrent restores with the same **restoreOrderExt.top** value. Otherwise the first session are able to access the objects, but other sessions wait until the first session terminates and the device becomes available.

The following example shows how to sort objects by using **Restore Order** fields.

Figure 1. Sorting objects with the restore order fields

```
typedef struct {
dsStruct64_t      objId;
dsUint160_t      restoreOrderExt;

} SortOrder;          /* struct used for sorting */

=====
/* the code for sorting starts from here */
dsmQueryType      queryType;
qryBackupData     queryBuffer;
DataBlk          qDataBlkArea;
qryRespBackupData qbDataArea;
dsInt16_t        rc;
dsBool_t         done = bFalse;
int i = 0;
int qry_item;
SortOrder  sortorder[100]; /* sorting can be done up to 100 items
                           only right now. Set appropriate
                           array size to fit your needs */

/*-----+
| NOTE: Make sure that proper initializations have been done to
|   queryType,
|   queryBuffer, qDataBlkArea, and qbDataArea.
|
|-----*/

qDataBlkArea.bufferPtf = (char*) &qbDataArea;

rc = dsmBeginQuery(dsmHandle, queryType, (void *) &queryBuffer);

/*-----+
| Make sure to check rc from dsmBeginQuery
+-----*/
while (!done)
{
rc = dsmGetNextQObj(dsmHandle, &qDataBlkArea);
if ((rc == DSM_RC_MORE_DATA) ||
(rc == DSM_RC_FINISHED))
&&( qDataBlkArea.numBytes)
{
/*****/
/* transferring restoreOrderExt and objId */
/*****/
sortorder[i].restoreOrderExt = qbDataArea.restoreOrderExt;
sortorder[i].objId = qbDataArea.objId;

} /* if ((rc == DSM_RC_MORE_DATA) || (rc == DSM_RC_FINISHED)) */
else
{
done = bTrue;
/*****/
/* take appropriate action. */
/*****/
}

i++;
qry_item++;

} /* while (!done) */
rc = dsmEndQuery(dsmHandle);
/*check rc */
/*****/
```

```

/* sorting the array using qsort. After the call, */
/* sortorder will be sorted by restoreOrderExt field */
/******/

    qsort(sortorder, qry_item, sizeof(SortOrder), SortRestoreOrder);

/*-----+
| NOTE: Make sure to extract sorted object ids and store them in
|       any data structure you want.
|-----*/

/*-----+
| int SortRestoreOrder(SortOrder *a, SortOrder *b)
|
| This function compares restoreOrder fields from two structures.
| if (a > b)
|     return(GREATERTHAN);
|| if (a < b)
|     return(LESSTHAN);
|| if (a == b)
|     return(EQUAL);
|-----*/
int SortRestoreOrder(SortOrder *a, SortOrder *b)
{
    if (a->restoreOrderExt.top > b->restoreOrderExt.top)
        return(GREATERTHAN);
    else if (a->restoreOrderExt.top < b->restoreOrderExt.top)
        return(LESSTHAN);
    else if (a->restoreOrderExt.hi_hi > b->restoreOrderExt.hi_hi)
        return(GREATERTHAN);
    else if (a->restoreOrderExt.hi_hi < b->restoreOrderExt.hi_hi)
        return(LESSTHAN);
    else if (a->restoreOrderExt.hi_lo > b->restoreOrderExt.hi_lo)
        return(GREATERTHAN);
    else if (a->restoreOrderExt.hi_lo < b->restoreOrderExt.hi_lo)
        return(LESSTHAN);
    else if (a->restoreOrderExt.lo_hi > b->restoreOrderExt.lo_hi)
        return(GREATERTHAN);
    else if (a->restoreOrderExt.lo_hi < b->restoreOrderExt.lo_hi)
        return(LESSTHAN);
    else if (a->restoreOrderExt.lo_lo > b->restoreOrderExt.lo_lo)
        return(GREATERTHAN);
    else if (a->restoreOrderExt.lo_lo < b->restoreOrderExt.lo_lo)
        return(LESSTHAN);
    else
        return(EQUAL);
}

```

## Starting the dsmBeginGetData call

---

After you select and sort the objects to receive, submit them to IBM Spectrum Protect™ for either a restore or retrieve operation. The **dsmBeginGetData** call begins a restore or retrieve operation. The objects are returned to the application client in the order you requested.

Complete the information for these two parameters in these calls:

**mountWait**

This parameter tells the server whether the application client waits for offline media to be mounted in order to obtain data for an object, or whether that object should be skipped during processing of the restore or retrieve operation.

**dsmGetObjListP**

This parameter is a data structure that contains the **objId** field which is a list of all object IDs that are restored or retrieved. Each **objId** is associated with a **partialObjData** structure that describes whether the entire **objId** or only a particular section of the object will be retrieved.

Each **objId** is eight bytes in length, so a single restore or retrieve request can contain thousands of objects. The number of objects to request in a single call is limited to DSM\_MAX\_GET\_OBJ or DSM\_MAX\_PARTIAL\_GET\_OBJ.

## Receiving each object to restore or retrieve

---

After the `dsmBeginGetData` call is sent, you can perform a procedure to receive each object that is sent from the server.

## About this task

The `DSM_RC_MORE_DATA` return code means that a buffer was returned and that you should call `dsmGetData` again. Check the `DataBlk.numBytes` for the actual number of returned bytes.

When you obtain all data for an object, you must send a `dsmEndGetObj` call. If more objects will be received, send `dsmGetObj` again.

If you want to stop the process, for example, to discard any remaining data in the restore stream for all objects that are not yet received, send the `dsmEndGetData` call. This call flushes the data from the server to the client. However, using this method might take time to complete. If you want to end a restore operation, use `dsmTerminate` to close the session.

## Procedure

1. Send the `dsmGetObj` call to identify the object that you requested from the data stream and to obtain the first block of data that is associated with the object.
2. Send more `dsmGetData` calls, as necessary to obtain the remaining object data.

## Example flow diagrams for restore and retrieve

A state diagram and a flowchart can be used to illustrate how to perform restore or retrieve operations.

The arrow pointing from "In Get Object" to `dsmEndGetData` indicates that you can send a `dsmEndGetData` call after a call to `dsmGetObj` or `dsmGetData`. You might need to do this if an error condition occurred while getting an object from IBM Spectrum Protect™ storage and you want to stop the operation. In normal circumstances, however, call `dsmEndGetObj` first.

Figure 1. State diagram for restore and retrieve operations

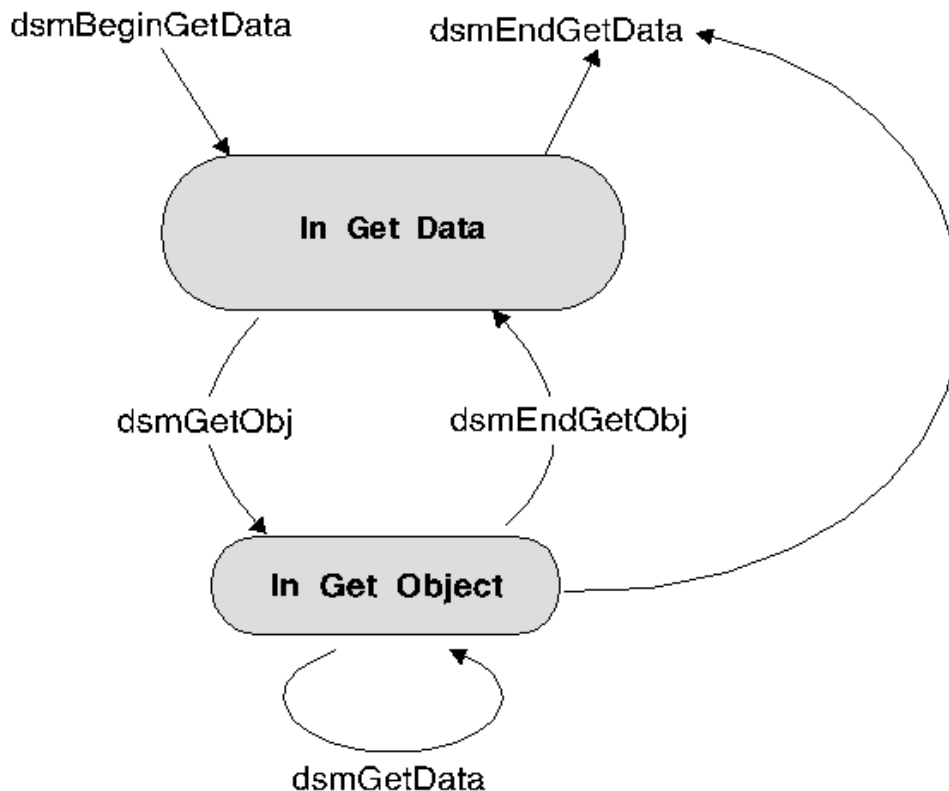
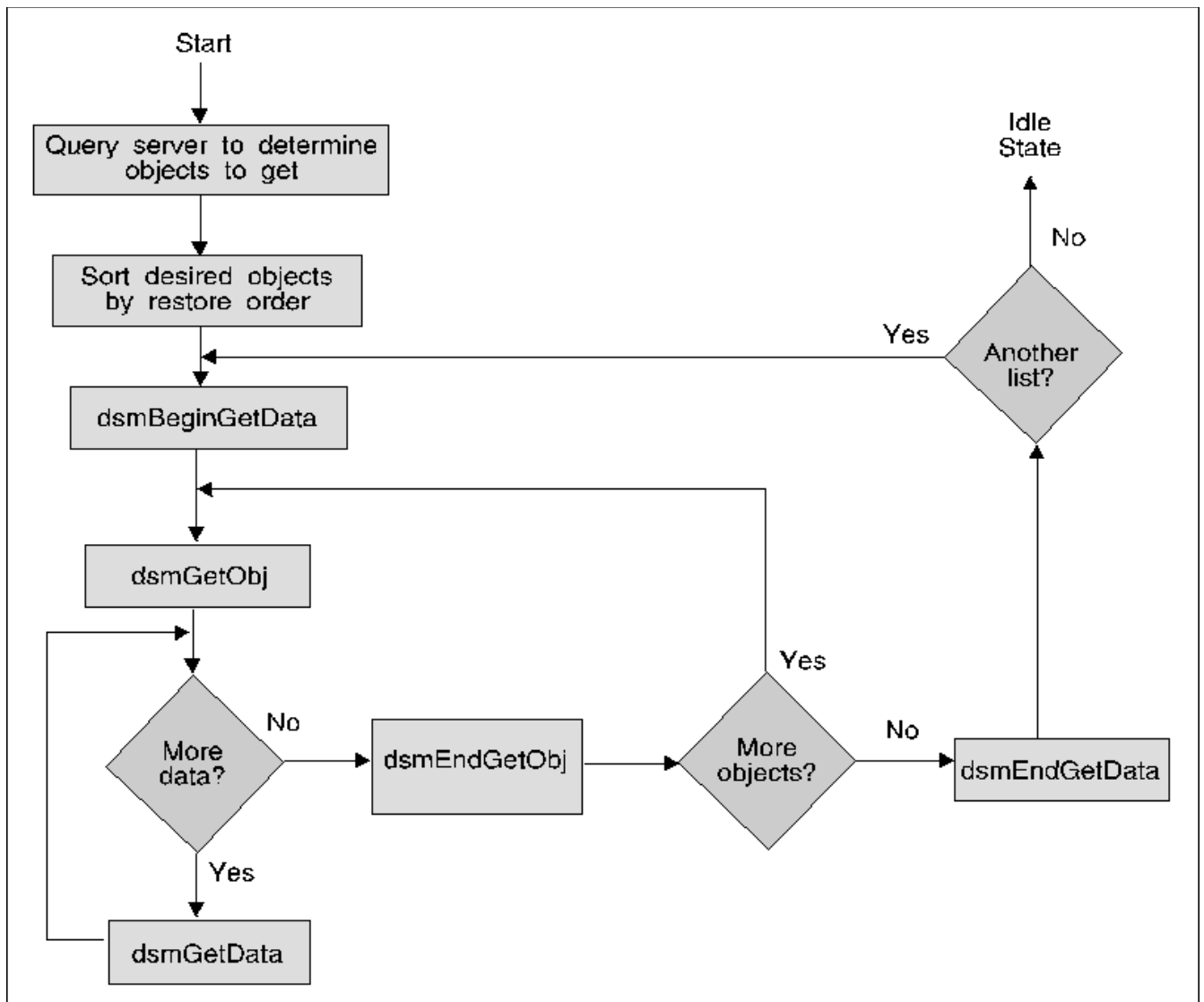

Figure 2 displays the flowchart for performing restore or retrieve operations.

Figure 2. Flowchart for restore and retrieve operations



## Code example of receiving data from a server

This example demonstrates using the API functions to retrieve data from IBM Spectrum Protect™ storage.

The **dsmBeginGetData** function call appears inside a switch statement, so that different parameters can be called depending on whether a restore or retrieve operation is being performed. The **dsmGetData** function call is called from inside a loop that repeatedly gets data from the server until a flag is set that permits the program execution to exit the loop.

Figure 1. An example of receiving data from a server

```

/* Call dsmBeginQuery and create a linked list of objects to restore. */
/* Process this list to create the proper list for the GetData calls. */
/* Set up the getList structure to point to this list. */
/* This example is set up to perform a partial object retrieve. To */
/* retrieve only complete objects, set up: */
/*     getList.stVersion = dsmGetListVersion; */
/*     getList.partialObjData = NULL; */
dsmGetList getList;
getList.stVersion = dsmGetListPORVersion; /* structure version */
getList.numObjId = items; /* number of items in list */
getList.objId = (ObjID *)rest_ibuff;
getList.partialObjData = (PartialObjData *) part_ibuff;
/* list of object IDs to restore */
/* list of partial object data */
switch(get_type)
{
case (Restore_Get) :
    rc = dsmBeginGetData(dsmHandle,bFalse,gtBackup,&getList);

```

```

        break;
    case (Retrieve_Get) :
        rc = dsmBeginGetData (dsmHandle,bFalse,gtArchive, &getList);
        break;
    default : ;
}
if (rc)
{
    printf("*** dsmBeginGetData failed: ");
    rcApiOut(dsmHandle, rc);
    return rc;
}
/* Get each object from the list and verify whether it is on the */
/* server. If so, initialize structures with object attributes for */
/* data validation checks. When done, call dsmGetObj. */
rc = dsmGetObj (dsmHandle,objId,&dataBlk);
done = bFalse;
while(!done)
{
    if ( (rc == DSM_RC_MORE_DATA)
        || (rc == DSM_RC_FINISHED))
    {
        if (rc == DSM_RC_MORE_DATA)
        {
            dataBlk.numBytes = 0;
            rc = dsmGetData (dsmHandle,&dataBlk);
        }
        else
            done = bTrue;
    }
    else
    {
        printf("*** dsmGetObj or dsmGetData failed: ");
        rcApiOut(dsmHandle, rc);
        done = bTrue;
    }
} /* while */
rc = dsmEndGetObj (dsmHandle);
/* check rc from dsmEndGetObj */
/* check rc from dsmEndGetData */
rc = dsmEndGetData (dsmHandle);
return 0;

```

## Updating and deleting objects on the server

---

Your API applications can use the **dsmUpdateObj** or **dsmUpdateObjEx** function call to update objects that were archived or backed up. Use either call in the session state only, updating one object at a time. Use **dsmUpdateObjEx** to update any of several archive objects containing the same name.

To select an archive object, set the **dsmSendType** function call to **stArchive**.

- With **dsmUpdateObj**, only the latest archive object with the assigned name is updated.
- With **dsmUpdateObjEx**, any archived object can be updated by specifying the proper object ID.

For an archived object, the application can update the following fields:

- Description
- Object information
- Owner

To select a backup object, set **dsmSendType** to **stBackup**. For backed-up objects, only the active copy is updated.

For a backed-up object, the application can update the following fields:

- Management class
- Object information
- Owner

- Deleting objects from the server

API applications can make calls to either delete objects that were archived or turn off objects that were backed up. Deleting

archived objects is dependent on the node authorization that was given when the administrator registered the node. Administrators can specify that nodes can delete archived objects.

## Logging events

---

An API application can log event messages to central locations. The application can direct logging to the IBM Spectrum Protect™ server, the local machine, or both. The `dsmLogEventEx` function call is performed in a session. To view messages logged on the server, use the `query actlog` command through the administrative client.

Use the IBM Spectrum Protect client option, `errorlogretention`, to prune the client error log file if the application writes numerous client messages to the client log `dsmLogType`, either `logLocal` or `logBoth`.

For more information about IBM Spectrum Protect logs, see the IBM Spectrum Protect server documentation.

## State diagram summary for the IBM Spectrum Protect API

---

Once you review all the considerations for creating your own application with the IBM Spectrum Protect™ API, review this state diagram summary of an entire application.

Figure 1 contains the state diagram for the API. It contains all previously displayed state diagrams in addition to several other calls previously not displayed.

The points in this diagram include:

- Call **`dsmQueryApiVersionEx`** at any time. It has no state associated with it. See Figure 1 for an example.
- Call **`dsmQueryCliOptions`** before a **`dsmInitEx`** call only.
- Use **`dsmRegisterFS`**, **`dsmUpdateFS`**, and **`dsmDeleteFS`** to manage file spaces. These calls are made from within an idle session state. Use the **`dsmBeginQuery`** call to query file spaces. For more information about file space calls, see [Managing file spaces](#).
- Send the **`dsmBindMC`** call from within an idle session state or from within a send object transaction state. See the example in Figure 1.
- Send the **`dsmChangePW`** call from within an idle session state.  
Note: If the **`dsmInitEx`** call returns with a password-expired return code, the **`dsmChangePW`** call must be made before you start a valid session. See Figure 3 for an example that uses **`dsmChangePW`**.
- If a call returns with an error, the state remains as it was. For example, if **`dsmGetObj`** returns with an error, the state remains In Get Data, and a call to **`dsmEndGetObj`** is a call sequence error.

Figure 1. Summary state diagram for the API

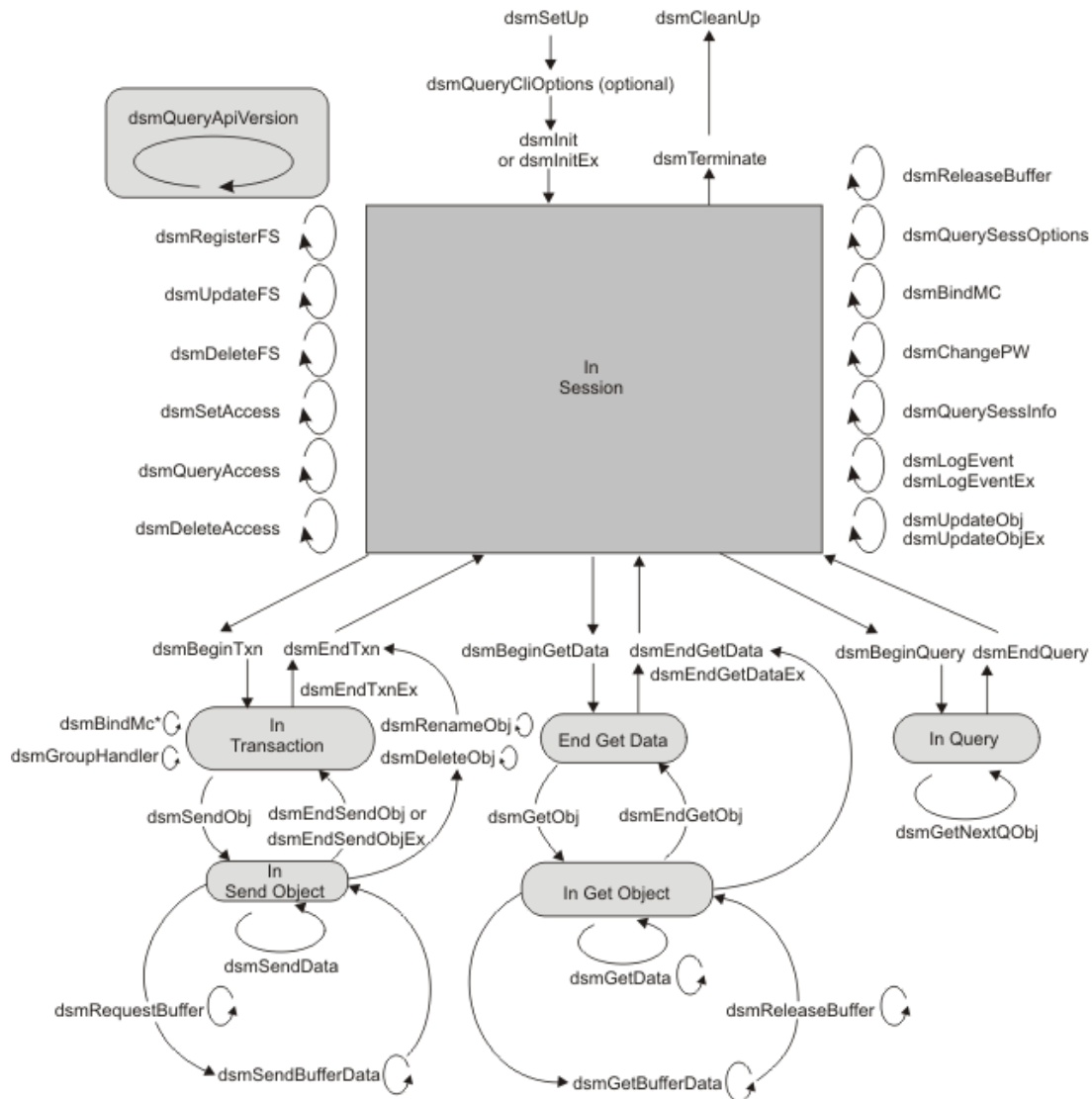

\* Can be inside or outside of a transaction

## Understanding interoperability

The API has two types of interoperability: between the backup-archive client and API applications and between different operating systems.

- Backup-archive client interoperability  
The backup-archive command line can access API objects to provide limited interoperability. API objects can only be viewed and accessed from the backup-archive command line client and cannot be viewed or accessed from any of the graphical interfaces. The backup-archive command-line client can only restore content of the file and nothing else, so you should only use it for a salvage type of operation.
- Operating system interoperability  
The IBM Spectrum Protect API supports cross-platform interoperability. Applications on a UNIX or Linux system can operate on file spaces and objects that are backed up from a Windows system. Similarly, a Windows system can operate on file spaces and objects that are backed up from a UNIX or Linux system.
- Backing up multiple nodes with client node proxy support  
Backups of multiple nodes which share storage can be consolidated to a common target node name on the IBM Spectrum

Protect server. This method is useful when the system that runs the backup can change over time, such as with a cluster. You can also use the `asnodename` option to restore data from a different system other than the one which ran the backup.

## Backup-archive client interoperability

---

The backup-archive command line can access API objects to provide limited interoperability. API objects can only be viewed and accessed from the backup-archive command line client and cannot be viewed or accessed from any of the graphical interfaces. The backup-archive command-line client can only restore content of the file and nothing else, so you should only use it for a salvage type of operation.

The following command-line actions are provided:

- Delete archive
- Delete filespace
- Query
- Restore
- Retrieve
- Set access

The path information is actual directories for backup-archive client objects. In contrast, the API object path information might not have any relationship to existing directories: the path might be completely contrived. Interoperability does not change this aspect of these object types. To use this feature successfully, follow the restrictions and conventions.

Notes:

1. There is no interoperability between the backup-archive client and API objects stored on a retention protection server.
  2. You cannot use the backup-archive client GUIs to access files that were stored using the API client. You can only use the command line to access these files.
- Naming your API objects  
Establish a consistent naming convention for API object names. The naming convention must cater for the file space name, the high-level qualifier, and the low-level qualifier. The file space name and high-level qualifiers can refer to actual directory names. Each object name can consist of more than one directory name that applies to the low-level qualifier.
  - Backup-archive client commands you can use with the API  
You can use a subset of backup-archive client commands within an application. For example, you can view and manage objects that other users own either on the same node or on a different node.

## Naming your API objects

---

Establish a consistent naming convention for API object names. The naming convention must cater for the file space name, the high-level qualifier, and the low-level qualifier. The file space name and high-level qualifiers can refer to actual directory names. Each object name can consist of more than one directory name that applies to the low-level qualifier.

For convenience, use the name of the object that is not prefixed with directory information as the low-level qualifier. For more information, see Object names and IDs.

File space names must be fully qualified when they are referred to from either the API or the backup-archive command line. For example, on a UNIX or Linux operating system, you register the following file spaces:

- `/a`
- `/a/b`

When you refer to `/a`, objects that are related only to file space `/a` are displayed. To view objects that are related to `/a/b`, you must specify `/a/b` as the file space name.

After you register both file spaces, if you back up object `b` into file space `/a`, then a query for `/a/b` continues to display objects that are related only to file space `/a/b`.

The exception to this restriction occurs in file space references when you attempt to query or delete file spaces with the API. In both cases, the file space names do not have to be fully qualified if you use a wildcard character. For example, `/a*` refers to both `/a` and `/a/b`.

Tip: If interoperability is important for you, then avoid file space names that overlap.



On Windows systems, enclose file space names in braces { } for API objects when you access the objects from the backup-archive command line interface. Windows operating systems automatically place file space names in uppercase letters when you register or refer the names. However, this automatic function does not occur for the remainder of the object name specification. If you want full interoperability, place the high-level qualifier and the low-level qualifier in uppercase letters in the application when you back up API objects. If your application does not uppercase high-level qualifiers (directory names) and low-level qualifiers (file names) before it sends objects to the server, you will be unable to access the objects directly by name through the backup-archive client.

For example, if an object is stored on the server as {"FileSpaceName"}\TEST\MYDIRNAME\file.txt, you cannot directly restore or query the file.txt object because your application did not uppercase the file name before the file was copied to the server. The only way to manipulate these objects is to use wildcard characters. For example, to query \TEST\MYDIRNAME\file.txt, a backup-archive client user must use wildcard characters for all parts of the object name that were not uppercased before they were sent to the server. The following command must be used to query this file.txt file:

```
dsmc query backup {"FileSpaceName"}\TEST\MYDIRNAME\*
```

If any other of the other qualifiers are also saved in lowercase text, those qualifiers must also be queried by using wildcards. For example, to query an object that is stored as {"FileSpaceName"}\TEST\mydirname\file.txt, use the following command:

```
dsmc query backup {"FileSpaceName"}\TEST\*\*
```

The examples that follow demonstrate these concepts. In both Windows and UNIX or Linux environments, you do not have to specify either the complete high-level or low-level qualifier. However, if you do not specify the complete qualifier, then you must use the wildcard character.

Platform	Example
Windows	To query all backed-up files in file space MYFS, enter the following string:  <pre>dsmc q ba "{MYFS}\*\**"</pre> You must use at least one asterisk (*) for each of the high-level and low-level qualifiers.
UNIX or Linux	To query all backed-up files in file space /A, enter the following string:  <pre>dsmc q ba "/A/*/*"</pre> You must use at least one asterisk (*) for each of the high-level and low-level qualifiers.

## Backup-archive client commands you can use with the API

You can use a subset of backup-archive client commands within an application. For example, you can view and manage objects that other users own either on the same node or on a different node.

To view and manage objects that other users own either on the same node or on a different node, perform these steps:

1. Give access with the set access command.
2. Specify the owner and the node. Use the *fromowner* and *fromnode* options from the backup-archive command line to specify the owner and the node. For example:

```
dsmc q ba "/A/*/*" -fromowner=other_owner -fromnode=other_node
```

Table 1 describes the commands that you can use with API objects.

Table 1. Backup-archive client commands you can use with API objects

Command	Description
Delete Archive	Archived files that the current user owns can be deleted. The set access command settings have no effect on this command.
Delete Filespace	The delete filespace command affects API objects.

Command	Description
Query	<p>From the backup-archive command line, you can query backed up and archived API objects and objects that other users own, or that exist on other nodes. See Naming your API objects for information about querying API objects.</p> <p>Use the existing <i>-fromowner</i> option to query objects that a different user owns for which the set access permission has been given. Use the existing <i>-fromnode</i> option to query objects that exist on another node for which the set access permission has been given. For more information, see <code>dsmInitEx</code>.</p>
Restore Retrieve	<p>Note: Use these commands only for exception situations. API objects that are encrypted using the application managed key can be restored or retrieved if the encryption key is known or saved in the password file or registry. API objects encrypted by using transparent encryption cannot be restored or retrieved by using the backup-archive client.</p> <p>These commands return data as bit files that are created by using default file attributes. You can restore or retrieve API objects that other users own, or that are from a different node. The set access command determines which objects qualify.</p>
Set Access	The set access command permits users to manage API objects that another user owns, or that are from another node.

## Operating system interoperability

The IBM Spectrum Protect™ API supports cross-platform interoperability. Applications on a UNIX or Linux system can operate on file spaces and objects that are backed up from a Windows system. Similarly, a Windows system can operate on file spaces and objects that are backed up from a UNIX or Linux system.

### About this task

By default, the names of objects from one UNIX system are compatible with the names of objects from other UNIX systems. By default, names of objects from Windows systems are not compatible with names of objects from UNIX systems. Several parameters control the naming of objects in IBM Spectrum Protect file spaces. If you set up an application appropriately, the names of objects can be used by applications that run on both Windows systems and UNIX systems. Use the same parameters to back up and restore objects.

Restriction: A Windows application that uses Unicode creates a file space that is not compatible with applications that run on UNIX systems.

### Procedure

To achieve interoperability, complete the following setup tasks:

1. Establish a consistent naming convention. Select a character for the `dir` delimiter, such as forward slash (/) or backslash (\). Place the directory delimiter character in front of the file space name, the high-level qualifier, and the low-level qualifier.
2. When you call `dsmInitEx`, set the value of the `dirDelimiter` field to the directory delimiter character that you selected and set `bCrossPlatform` to `bTrue`.
3. Set the `useUnicode` flag to `bFalse` when you use the IBM Spectrum Protect interface. Unicode file names are not compatible with non-Unicode file names.

## Backing up multiple nodes with client node proxy support

Backups of multiple nodes which share storage can be consolidated to a common target node name on the IBM Spectrum Protect™ server. This method is useful when the system that runs the backup can change over time, such as with a cluster. You can also use the `asnodename` option to restore data from a different system other than the one which ran the backup.

### About this task

Use the `asnodename` option on the `dsmInitEx` option string to back up, archive, restore, and retrieve, query, or delete data under the target node name on the IBM Spectrum Protect server. You can also specify the `asnodename` option in the `dsm.opt` or `dsm.sys` file.

Restriction: Do not use target nodes as traditional nodes, especially if you encrypt your files before you back up to the server.

## Procedure

---

To enable this option, complete the following steps:

1. Install the API client on all nodes in a shared data environment.
2. If not already registered, register each node with the IBM Spectrum Protect server. Register the common "target" node name to be shared by each of the agent nodes that are used in your shared data environment.
3. Register each of the agent nodes in the shared data environment with the server. The agent node name is used for authentication. Data is not stored by using the agent node name when the `asnodename` option is used.
4. Ask your administrator to grant proxy authority to all nodes in the shared environment to access the target node name on the IBM Spectrum Protect server, by using the `grant proxynode` command.
5. Use the query `proxynode` administrative client command to display the client nodes that have the authority to perform client operations on behalf of another node. This authority is granted by the `grant proxynode` command. Or use the `dsmQuery` command with the query type `qtProxyNodeAuth` to see the nodes to which this node can proxy.
6. If the application is using user encryption of data, not `TSMENCRKEY`, ensure that all nodes use the same encryption key. You must use the same encryption key for all files that are backed up in the shared node environment.

### Related tasks:

Backing up data with client-node proxy support (UNIX and Linux systems)

Backing up data with client-node proxy support (Windows systems)

## Using the API with Unicode

---

The IBM Spectrum Protect™ API supports Unicode UCS2, a fixed length, double-byte code page that has code points for all known code pages, such as Japanese, Chinese, or German. It supports as many as 65,535 unique code points.

Restriction: This feature is only available on Windows.

With Unicode, your application can back up and restore file names in any character set from the same machine. For example, on an English machine, you can back up and restore file names in any other language code page.

- **When to use Unicode**  
You can simplify your application that supports multiple languages by writing a Unicode application and by taking advantage of the IBM Spectrum Protect Unicode interface.
- **Setting up Unicode**  
To set up and use Unicode you must perform a particular procedure so the API registers a Unicode file space on the server and all file names in that file space become Unicode strings.

## When to use Unicode

---

You can simplify your application that supports multiple languages by writing a Unicode application and by taking advantage of the IBM Spectrum Protect™ Unicode interface.

Use the IBM Spectrum Protect Unicode interface if any of the following conditions are true:

- If your application is already compiled for Unicode and it was converting to a multibyte character set (mbcs) before calling the IBM Spectrum Protect API.
- If you are writing a new application and want to enable your application to support Unicode.
- If your application uses a string passed to it from an operating system or other application that uses Unicode.

If you do not need Unicode, it is not necessary to compile your application again.

The API continues to support the `dsm` interface. The API SDK contains `callmtu1.c` and `callmtu2.c` sample programs that demonstrate how to use the Unicode API. Use **makemtu** to compile these programs.

## Setting up Unicode

---

To set up and use Unicode you must perform a particular procedure so the API registers a Unicode file space on the server and all file names in that file space become Unicode strings.

Restriction: You cannot store Unicode and non-Unicode file names in the same file space.

1. Compile the code with the `-DUNICODE` flag.
2. All strings in your application must be `wchar` strings.
3. Follow the structures in the `tmapitd.h` file, and the function definitions in the `tmapifp.h` file for calls to the API.
4. Set the `useUnicode` flag to `bTrue` on the `tsmInitEx` function call. Any new file space is registered as a Unicode file space.

When you send data to previously registered, non-Unicode file spaces, the API continues to send file names as non-Unicode. Rename the old file spaces on the server to `fsname_old` and start a new Unicode file space for new data. The API restores non-Unicode data from the old file spaces. Use the `bIsUnicode` field in the `tsmQryRespFSDData` structure that is returned on a query file space to determine whether or not a file space is Unicode.

Each `dsmXXX` function call has a matching `tsmXXX` function call. The difference between the two are the structures that are used. All `tsmXXX` function call structures have `dsChar_t` types for string values when they are compiled with the `UNICODE` flag. The `dsChar_r` maps to `wchar`. There is no other difference between these interfaces.

Restriction: Use either one interface or the other. Do not mix the `dsmXXX` function call and `tsmXXX` function call interfaces. Ensure that you use the IBM Spectrum Protect™ structures and IBM Spectrum Protect version definitions.

Some constants continue to be defined in the `dsmapi.h` file, so you need both the `dsmapi.h` and the `tmapitd.h` files when you compile.

You can use the IBM Spectrum Protect interface on other operating systems, such as UNIX or Linux, but on these operating systems, the `dsChar_t` type maps to `char` because Unicode is supported on Windows operating systems. You can write only one variation of the application and compile on more than one operating system using the IBM Spectrum Protect interface. If you are writing a new application, use the IBM Spectrum Protect interface.

If you are upgrading an existing application:

1. Convert the `dsmXXX` function call structures and calls to the IBM Spectrum Protect interface.
2. Migrate existing file spaces.
3. Back up new file spaces with the `useUnicode` flag set to `true`.

Note: After you use a Unicode-enabled client to access a node, you cannot connect to the same node name with an older version of the API or with an API from another operating system. If your application uses cross-platform capability, do not use the Unicode flag. There is no cross-platform support between Unicode and non-Unicode operating systems.

When you enable the `useUnicode` flag, all string structures are treated as Unicode strings. On the server, only the following fields are true Unicode:

- File space name
- High level
- Low level
- Archive description

All remaining fields convert to `mbcs` in the local code page before they are sent to the server. Fields, such as `nodename`, are `wchar` strings. They must be valid in the current locale. For example, on a Japanese machine, you can back up files with Chinese names, but the node name must be a valid string in Japanese. The option file remains in the current code page. If you need to create a Unicode include-exclude list, use the `inlexcl` option with a file name and create a Unicode file with Unicode patterns in it.

**Related reference:**

`Inlexcl` option

## API function calls

Table 1 provides an alphabetical list of the API function calls, a brief description and the location of more detailed information about the function call, which includes:

Element	Description
<b>Purpose</b>	Describes the function call.
<b>Syntax</b>	Contains the actual C code for the function call. This code is copied from the UNIX or Linux version of the <code>dsmapi.h</code> header file. See API function definitions source file.  This file differs slightly on other operating systems. Application programmers for other operating systems should check their version of the header file, <code>dsmapi.h</code> , for the exact syntax of the API definitions.

Element	Description
<b>Parameters</b>	Describes each parameter in the function call, identifying it as either input (I) or output (O), depending on how it is used. Some parameters are designated as both input and output (I/O). The data types that are referenced in this section are defined in the dsmapitd.h header file. See API type definitions source files.
<b>Return codes</b>	Contains a list of the return codes that are specific to the function call. General system errors, such as communication errors, server problems, or user errors that might appear on any call are not listed. The return codes are defined in the dsmsrc.h header file. See API return codes source file: dsmsrc.h.

Table 1. API function calls

Function call and link	Description
dsmBeginGetData	Starts a restore or retrieve operation on a list of objects in storage.
dsmBeginQuery	Starts a query request to IBM Spectrum Protect™ for information.
dsmBeginTxn	Starts one or more transactions that begins a complete action. Either all of the actions succeed, or none succeed.
dsmBindMC	Associates, or binds, a management class to the object that is passed.
dsmChangePW	Changes an IBM Spectrum Protect password.
dsmCleanUp	This call is used if <b>dsmSetUp</b> was called.
dsmDeleteAccess	Deletes current authorization rules for backup versions or archived copies of your objects.
dsmDeleteFS	Deletes a file space from storage.
dsmDeleteObj	Turns off backup objects, or deletes archive objects in storage.
dsmEndGetData	Ends a <b>dsmBeginGetData</b> session that gets objects from storage.
dsmEndGetDataEx	Provides the total of LAN-free bytes that were sent.
dsmEndGetObj	Ends a <b>dsmGetObj</b> session that obtains data for a specified object.
dsmEndQuery	Signifies the end of a <b>dsmBeginQuery</b> action.
dsmEndSendObj	Indicates the end of data that is sent to storage.
dsmEndSendObjEx	Provides compression information and the number of bytes that were sent.
dsmEndTxn	Ends an IBM Spectrum Protect transaction.
dsmEndTxnEx	Provides group leader object ID information to use with the <b>dsmGroupHandlerfunction</b> call.
dsmGetData	Obtains a byte stream of data from IBM Spectrum Protect and place it in the caller's buffer.
dsmGetBufferData	Gets an IBM Spectrum Protect-allocated buffer of data from the IBM Spectrum Protect server.
dsmGetNextQObj	Gets the next query response from a previous <b>dsmBeginQuery</b> call and places it in the caller's buffer.
dsmGetObj	Obtains the requested object data from the data stream and places it in the caller's buffer.
dsmGroupHandler	Performs an action on a logical file group depending on the input that is given.
dsmInit	Starts an API session and connects the client to storage.
dsmInitEx	Starts an API session using the additional parameters that permit extended verification.
dsmLogEvent	Logs a user message to the server log file, to the local error log, or to both.
dsmLogEventEx	Logs a user message to the server log file, to the local error log, or to both.
dsmQueryAccess	Queries the server for all access authorization rules for either backup versions or archived copies of your objects.

Function call and link	Description
dsmQueryApiVersion	Performs a query request for the API library version that the application client accesses.
dsmQueryApiVersionEx	Performs a query request for the API library version that the application client accesses.
dsmQueryCliOptions	Queries important option values in the user's option files.
dsmQuerySessInfo	Starts a query request to IBM Spectrum Protect for information that is related to the operation of the specified session in <b>dsmHandle</b> .
dsmQuerySessOptions	Queries important option values that are valid in the specified session in <b>dsmHandle</b> .
dsmRCMsg	Obtains the message text that is associated with an API return code.
dsmRegisterFS	Registers a new file space with the server.
dsmReleaseBuffer	Returns an IBM Spectrum Protect-allocated buffer.
dsmRenameObj	Renames the high-level or low-level object name.
dsmRequestBuffer	Obtains an IBM Spectrum Protect-allocated buffer for buffer copy elimination.
dsmRetentionEvent	Sends a list of object IDs to the server with a retention event operation to be performed on these objects.
dsmSendBufferData	Sends data from an IBM Spectrum Protect-allocated buffer.
dsmSendData	Sends a byte stream of data to IBM Spectrum Protect via a buffer.
dsmSendObj	Starts a request to send a single object to storage.
dsmSetAccess	Gives other users, or nodes, access to backup versions or archived copies of your objects, access to all your objects, or access to a selective set.
dsmSetUp	Overwrites environment variable values.
dsmTerminate	Ends a session with the server and cleans up the IBM Spectrum Protect environment.
dsmUpdateFS	Updates a file space in storage.
dsmUpdateObj	Updates the objInfo information that is associated with an active backup object already on the server, or it updates archived objects.
dsmUpdateObjEx	Updates the objInfo information that is associated with a specific archive object even when there are multiple objects with same name, or it updates active backup objects.

- dsmBeginGetData  
The **dsmBeginGetData** function call starts a restore or retrieve operation on a list of objects in storage. This list of objects is contained in the **dsmGetList** structure. The application creates this list with values from the query that preceded a call to **dsmBeginGetData**.
- dsmBeginQuery  
The **dsmBeginQuery** function call starts a query request to the server for information about data, file spaces, and management classes.
- dsmBeginTxn  
The **dsmBeginTxn** function call begins one or more IBM Spectrum Protect transactions that begin a complete action; either all the actions succeed or none succeed. An action can be either a single call or a series of calls. For example, a **dsmSendObj** call that is followed by a number of **dsmSendData** calls can be considered a single action. Similarly, a **dsmSendObj** call with a **dataBlkPtr** that indicates a data area containing the object to back up is also considered a single action.
- dsmBindMC  
The **dsmBindMC** function call associates, or binds, a management class to the passed object. The object is passed through the include-exclude list that is pointed to in the options file. If a match is not found in the Include list for a specific management class, the default management class is assigned. The Exclude list can prevent objects from a backup but not from an archive.

- **dsmChangePW**  
The **dsmChangePW** function call changes an IBM Spectrum Protect password. On a multiple-user operating system such as UNIX or Linux, only the root user or the authorized user can use this call.
- **dsmCleanUp**  
The **dsmCleanUp** function call is used if **dsmSetUp** was called. The **dsmCleanUp** function call should be called after **dsmTerminate**. You cannot make any other calls after you call **dsmCleanUp**.
- **dsmDeleteAccess**  
The **dsmDeleteAccess** function call deletes current authorization rules for backup versions or archived copies of your objects. When you delete an authorization rule, you revoke the access a user has to any files that are specified by the rule.
- **dsmDeleteFS**  
The **dsmDeleteFS** function call deletes a file space from storage. To delete a file space, you must have the appropriate permissions that your IBM Spectrum Protect administrator gave you. To determine whether you have the necessary permissions, call **dsmQuerySessInfo**. This function call returns a data structure of type *ApiSessInfo*, that includes two fields, *archDel* and *backDel*.
- **dsmDeleteObj**  
The **dsmDeleteObj** function call inactivates backup objects, deletes backup objects, or it deletes archive objects in storage. The **dtBackup** type inactivates the currently active backup copy only. The **dtBackupID** type removes from the server whichever object ID is specified. Call this function from within a transaction.
- **dsmEndGetData**  
The **dsmEndGetData** function call ends a **dsmBeginGetData** session that obtains objects from storage.
- **dsmEndGetDataEx**  
The **dsmEndGetDataEx** function call provides the total of LAN-free bytes that were sent. It is an extension of the **dsmEndGetData** function call.
- **dsmEndGetObj**  
The **dsmEndGetObj** function call ends a **dsmGetObj** session that obtains data for a specified object.
- **dsmEndQuery**  
The **dsmEndQuery** function call signifies the end of a **dsmBeginQuery** action. The application client sends **dsmEndQuery** to complete a query. This call either is sent after all query responses are obtained through **dsmGetNextQObj**, or it is sent to end a query before all data are returned.
- **dsmEndSendObj**  
The **dsmEndSendObj** function call indicates the end of data that is sent to storage.
- **dsmEndSendObjEx**  
The **dsmEndSendObjEx** function call provides additional information regarding the number of bytes processed. The information includes: total bytes sent, compression information, lan-free bytes, and deduplication information.
- **dsmEndTxn**  
The **dsmEndTxn** function call ends an IBM Spectrum Protect transaction. Pair the **dsmEndTxn** function call with **dsmBeginTxn** to identify the call or set of calls that are considered a transaction. The application client can specify on the **dsmEndTxn** call whether the transaction must be committed or ended.
- **dsmEndTxnEx**  
The **dsmEndTxnEx** function call provides group leader object ID information for you to use with the **dsmGroupHandler** function call. It is an extension of the **dsmEndTxn** function call.
- **dsmGetData**  
The **dsmGetData** function call obtains a byte stream of data from IBM Spectrum Protect and places it in the caller's buffer. The application client calls **dsmGetData** when there is more data to receive from a previous **dsmGetObj** or **dsmGetData** call.
- **dsmGetBufferData**  
The **dsmGetBufferData** function call receives a byte stream of data from IBM Spectrum Protect through a buffer. After each call the application needs to copy the data and release the buffer through a call to **dsmReleaseBuffer**. If the number of buffers held by the application equals the **numTsmBuffers** specified in the **dsmInitEx** call, the **dsmGetBufferData** function blocks until a **dsmReleaseBuffer** is called.
- **dsmGetNextQObj**  
The **dsmGetNextQObj** function call gets the next query response from a previous **dsmBeginQuery** call and places the response in the caller buffer.
- **dsmGetObj**  
The **dsmGetObj** function call obtains the requested object data from the IBM Spectrum Protect data stream and places it in the caller's buffer. The **dsmGetObj** call uses the object ID to obtain the next object or partial object from the data stream.
- **dsmGroupHandler**  
The **dsmGroupHandler** function call performs an action on a logical file group depending on the input that is given. The client relates a number of individual objects together to reference and manage on the IBM Spectrum Protect server as a logical group.
- **dsmInit**  
The **dsmInit** function call starts an API session and connects the client to IBM Spectrum Protect storage. The application

client can have only one active session open at a time. To open another session with different parameters, use the **dsmTerminate** call first to end the current session.

- **dsmInitEx**  
The **dsmInitEx** function call starts an API session by using the additional parameters for extended verification.
- **dsmLogEvent**  
The **dsmLogEvent** function call logs a user message (ANE4991 I) to the server log file, to the local error log, or to both. A structure of type **logInfo** is passed in the call. This call must be performed while at **InSession** state inside a session. Do not perform it within a send, get, or query. To retrieve messages logged on the server, use the **query actlog** command through the administrative client.
- **dsmLogEventEx**  
The **dsmLogEventEx** function call logs a user message to the server log file, to the local error log, or to both. This call must be made while at an **InSession** state within a session. The call cannot be made within a send, get, or query call.
- **dsmQueryAccess**  
The **dsmQueryAccess** function call queries the server for all access authorization rules for either backup versions or archived copies of your objects. A pointer to an array of access rules is passed in to the call, and the completed array is returned. A pointer to the number of rules is passed in to indicate how many rules are in the array.
- **dsmQueryApiVersion**  
The **dsmQueryApiVersion** function call performs a query request for the API library version that the application client accesses.
- **dsmQueryApiVersionEx**  
The **dsmQueryApiVersionEx** function call performs a query request for the API library version that the application client accesses.
- **dsmQueryCliOptions**  
The **dsmQueryCliOptions** function call queries important option values in the user's option files. A structure of type **optStruct** is passed in the call and contains the information. This call is performed before **dsmInitEx** is called, and it determines the setup before the session.
- **dsmQuerySessInfo**  
The **dsmQuerySessInfo** function call starts a query request to IBM Spectrum Protect for information related to the operation of the specified session in **dsmHandle**. A structure of type **ApiSessInfo** is passed in the call, with all available session related information entered. This call is started after a successful **dsmInitEx** call.
- **dsmQuerySessOptions**  
The **dsmQuerySessOptions** function call queries important option values that are valid in the specified session in **dsmHandle**. A structure of type **optStruct** is passed in the call and contains the information.
- **dsmRCMsg**  
The **dsmRCMsg** function call obtains the message text that is associated with an API return code.
- **dsmRegisterFS**  
The **dsmRegisterFS** function call registers a new file space with the IBM Spectrum Protect server. Register a file space first before you can back up any data to it.
- **dsmReleaseBuffer**  
The **dsmReleaseBuffer** function returns a buffer to IBM Spectrum Protect. The application calls **dsmReleaseBuffer** after a **dsmGetDataEx** was called and the application has moved all the data out of the buffer and is ready to release it. **dsmReleaseBuffer** requires that **dsmInitEx** was called with the **UseTsmBuffers** set to *true* and a non-zero value was provided for **numTsmBuffers**. **dsmReleaseBuffer** should also be called if the application is about to call **dsmTerminate** and it still holds data buffers.
- **dsmRenameObj**  
The **dsmRenameObj** function call renames the high-level or low-level object name. For backup objects, pass in the current object name and changes either for high-level or low-level object names. For archive objects, pass in the current object file space name and object ID, and changes either for high-level or low-level object names. Use this function call within **dsmBeginTxn** and **dsmEndTxn** calls.
- **dsmRequestBuffer**  
The **dsmRequestBuffer** function returns a buffer to IBM Spectrum Protect. The application calls **dsmRequestBuffer** after a **dsmGetDataEx** was called and the application has moved all the data out of the buffer and is ready to release it.
- **dsmRetentionEvent**  
The **dsmRetentionEvent** function call sends a list of object IDs to the IBM Spectrum Protect server, with a retention event operation to be performed on these objects. Use this function call within **dsmBeginTxn** and **dsmEndTxn** calls.
- **dsmSendBufferData**  
The **dsmSendBufferData** function call sends a byte stream of data to IBM Spectrum Protect through a buffer that was provided in a previous **dsmReleaseBuffer** call. The application client can pass any type of data for storage on the server. Usually this data are file data, but it is not limited to file data. You can call **dsmSendBufferData** several times, if the byte stream of data that you are sending is large. Regardless of whether the call succeeds or fails, the buffer is released.
- **dsmSendData**  
The **dsmSendData** function call sends a byte stream of data to IBM Spectrum Protect through a buffer. The application



client can pass any type of data for storage on the server. Usually, these data are file data, but are not limited to such. You can call **dsmSendData** several times, if the byte stream of data that you want to send is large.

- **dsmSendObj**  
The **dsmSendObj** function call starts a request to send a single object to storage. Multiple **dsmSendObj** calls and associated **dsmSendData** calls can be made within the bounds of a transaction for performance reasons.
- **dsmSetAccess**  
The **dsmSetAccess** function call gives other users or nodes access to backup versions or archived copies of your objects, access to all your objects, or access to a selective set. When you give access to another user, that user can query, restore, or retrieve your files. This command supports wildcards for the following fields: *fs, hl, ll, node, owner*.
- **dsmSetUp**  
The **dsmSetUp** function call overwrites environment variable values. Call **dsmSetUp** before **dsmInitEx**. The values that were passed in the **envSetUp** structure overwrite any existing environment variables or defaults. If you specify NULL for a field, values are taken from the environment. If you do not set a value, the values are taken from the defaults.
- **dsmTerminate**  
The **dsmTerminate** function call ends a session with the IBM Spectrum Protect server and cleans up the IBM Spectrum Protect environment.
- **dsmUpdateFS**  
The **dsmUpdateFS** function call updates a file space in IBM Spectrum Protect storage. This update ensures that the administrator has a current record of your file space.
- **dsmUpdateObj**  
The **dsmUpdateObj** function call updates the meta information associated with an active backup or archive object already on the server. The application bit data is not affected. To update an object, you must give a specific non-wildcard name. To update an archived object, set the **dsmSendType** to **stArchive**. Only the latest named archive object is updated.
- **dsmUpdateObjEx**  
The **dsmUpdateObjEx** function call updates the meta information that is associated with an active backup or archive object that is on the server. The application bit data is not affected. To update an object, you must specify a non-wildcard name, or you can specify the object ID to update a specific archived object. You cannot use wildcard characters when specifying the name. To update a backup object, set the **dsmSendType** parameter to **stBackup**. To update an archived object, set the **dsmSendType** parameter to **stArchive**.

**Related reference:**

API return codes

## dsmBeginGetData

---

The **dsmBeginGetData** function call starts a restore or retrieve operation on a list of objects in storage. This list of objects is contained in the **dsmGetList** structure. The application creates this list with values from the query that preceded a call to **dsmBeginGetData**.

The caller first must use the restore order fields that are obtained from the object query to sort the list that is contained in this call. This ensures that the objects are restored from storage in the most efficient way possible without rewinding or remounting data tapes.

When getting whole objects, the maximum *dsmGetList.numObjID* is **DSM\_MAX\_GET\_OBJ**. When getting partial objects, the maximum is **DSM\_MAX\_PARTIAL\_GET\_OBJ**.

Follow the call to **dsmBeginGetData** with one or more calls to **dsmGetObj** to obtain each object within the list. After each object is obtained, or additional data for the object is not needed, the **dsmEndGetObj** call is sent.

When all objects are obtained, or the **dsmEndGetObj** is canceled, the **dsmEndGetData** call is sent. You then can start the cycle again.

## Syntax

---

```
dsInt16_t dsmBeginGetData (dsUInt32_t          dsmHandle,  
                          dsBool_t          mountWait,  
                          dsmGetType      getType,  
                          dsmGetList      *dsmGetObjListP);
```

## Parameters

---

dsUInt32\_t dsmHandle (I)

The handle that associates this call with a previous **dsmInitEx** call.

dsBool\_t mountWait (I)

A Boolean true or false value indicates whether or not the application client waits for offline media to be mounted if the data that is needed is currently offline. If mountWait is true, the application waits for the server to mount the required media. The application waits until the media is mounted or the request is canceled.

dsmGetType getType (I)

An enumerated type consisting of gtBackup and gtArchive that indicates what type of object to get.

dsmGetList \*dsmGetObjListP (I)

The structure that contains information about the objects or partial objects to restore or retrieve. The structure points to a list of object IDs and, in the case of a partial object restore or retrieve, a list of associated offsets and lengths. If your application uses the partial object restore or retrieve function, set the **dsmGetList.stVersion** field to **dsmGetListPORVersion**. In a partial object restore or retrieve, you cannot compress data while sending it. To enforce this, set **ObjAttr.objCompressed** to *bTrue*.

See Figure 1 and API type definitions source files for more information on this structure.

See Partial object restore or retrieve for more information on partial object restore or retrieve.

## Return codes

The return code numbers are provided in parentheses ( ).

Table 1. Return codes for dsmBeginGetData

Return code	Explanation
DSM_RC_ABORT_INVALID_OFFSET (33)	The offset that was specified during a partial object retrieve is greater than the length of the object.
DSM_RC_ABORT_INVALID_LENGTH (34)	The length that was specified during a partial object retrieve is greater than the length of the object, or the offset in addition to the length extends past the end of the object.
DSM_RC_NO_MEMORY (102)	There is no RAM remaining to complete the request.
DSM_RC_NUMOBJ_EXCEED (2029)	The <b>dsmGetList.numObjId</b> is greater than DSM_MAX_GET_OBJ.
DSM_RC_OBJID_NOTFOUND (2063)	The object ID was not found. The object was not restored.
DSM_RC_WRONG_VERSION_PARM (2065)	The API version of the application client is different from the IBM Spectrum Protect™ library version.

## dsmBeginQuery

The dsmBeginQuery function call starts a query request to the server for information about data, file spaces, and management classes.

Specifically, dsmBeginQuery can query:

- Archived data
- Backed-up data
- Active backed-up data
- File spaces
- Management classes

The query data that is returned from the call is obtained by one or more calls to dsmGetNextQObj. When the query is complete, the dsmEndQuery call is sent.

## Syntax

```
dsInt16_t dsmBeginQuery (dsUInt32_t dsmHandle,  
    dsmQueryType queryType,  
    dsmQueryBuff *queryBuffer);
```

## Parameters

dsUInt32\_t dsmHandle (I)

The handle that associates this call with a previous `dsmInitEx` call.

`dsmQueryType` queryType (I)

Identifies the type of query to run. Assign one of the following options:

`qtArchive`

Queries archived objects.

`qtBackup`

Queries backed-up objects.

`qtBackupActive`

Queries active, backed-up objects only for the entire file space name that you pass. This query is called a "fast path" and is an efficient way to query active objects from storage.

Prerequisite: You must be logged on as a root user on a UNIX or Linux operating system.

`qtFilespace`

Queries registered file spaces.

`qtMC`

Queries defined management classes.

`qtBackupGroups`

Queries groups that are closed.

`qtOpenGroups`

Queries groups that are open.

`qtProxyNodeAuth`

Queries nodes to which this node can proxy.

`qtProxyNodePeer`

Queries peer nodes with the same target.

`dsmQueryBuff *queryBuffer` (I)

Identifies a pointer to a buffer that is mapped to a particular data structure. This structure is associated with the query type that you pass. These structures contain the selection criteria for each query type. Complete the fields in each structure to specify the scope of the query that you want to run. The `stVersion` field in each structure contains the structure version number.

The data structures and their related fields include the following items:

`qryArchiveData`

`objName`

The complete object name. You can use a wildcard character, such as an asterisk (\*) or a question mark (?), in the high-level or low-level portion of the name. An asterisk matches zero or more characters, and a question mark matches one character. The `objType` field of `objName` can have one of the following values:

- `DSM_OBJ_FILE`
- `DSM_OBJ_DIRECTORY`
- `DSM_OBJ_ANY_TYPE`

For more information about high-level and low-level names, see the following topic: High-level and low-level names.

`owner`

The owner name of the object.

#### insDateLowerBound

The lower boundary for the insert date that the object was archived. To obtain the default lower boundary, set the year component to `DATE_MINUS_INFINITE`.

#### insDateUpperBound

The upper boundary for the insert date that the object was archived. To obtain the default upper boundary, set the year component to `DATE_PLUS_INFINITE`.

#### expDateLowerBound

The lower boundary for the expiration date. The default values for both expiration date fields are the same as for the insert date fields.

#### expDateUpperBound

The upper boundary for the expiration date.

#### descr

The archive description. Enter an asterisk (\*) to search all descriptions.

#### qryBackupData

##### objName

The complete object name. You can use a wildcard character, such as an asterisk (\*) or a question mark (?), in the high-level or low-level portion of the name. An asterisk matches zero or more characters, and a question mark matches one character. The `objType` field of `objName` can have one of the following values:

- `DSM_OBJ_FILE`
- `DSM_OBJ_DIRECTORY`
- `DSM_OBJ_ANY_TYPE`

For more information about high-level and low-level names, see the following topic: High-level and low-level names.

##### owner

The owner name of the object.

##### objState

You can query for one of the following object states:

- `DSM_ACTIVE`
- `DSM_INACTIVE`
- `DSM_ANY_MATCH`

##### pitDate

The point-in-time value. A query with this field returns the most recent object that is backed up before this date and time. The `objState` can be active or inactive. Objects that are deleted before the `pitDate` are not returned. For example:

```
Mon - backup ABC(1), DEF, GHI
Tue - backup ABC(2), delete DEF
Thr - backup ABC(3)
```

On Friday, call the query with a point-in-time value of Wednesday at 12:00:00 a.m. The call returns the following information:

```
ABC(2) - an Inactive copy
GHI    - an Active copy
```

The call does not return `DEF` because that object was deleted prior to the point-in-time value.

#### qryABackupData

##### objName

The complete object name. You can use a wildcard character, such as an asterisk (\*) or a question mark (?), in the high-level or low-level portion of the name. An asterisk matches zero or more characters, and a question mark matches one character. The objType field of objName can have one of the following values:

- DSM\_OBJ\_FILE
- DSM\_OBJ\_DIRECTORY
- DSM\_OBJ\_ANY\_TYPE

For more information about high-level and low-level names, see the following topic: High-level and low-level names.

#### qryFSData

##### fsName

Enter the name of a specific file space in this field, or enter an asterisk (\*) to retrieve information about all registered file spaces.

#### qryMCData

##### mcName

Enter the name of a specific management class, or enter an empty string (" ") to retrieve information about all management classes.

Note: You cannot use an asterisk (\*).

##### mcDetail

Determines whether information on the backup and archive copy groups of the management class is returned. The following values are valid:

- bTrue
- bFalse

#### qryBackupGroup:

##### groupType

The group type is DSM\_GROUPTYPE\_PEER.

##### fsName

The file space name.

##### owner

The owner ID.

##### groupLeaderObjId

The group leader object ID.

##### objType

The object type.

#### qryProxyNodeAuth:

##### targetNodeName

The target node name.

##### peerNodeName

The peer node name.

##### hlAddress

The peer address of the high-level name.

##### llAddress

The peer address of the low-level name.

qryProxyNodePeer:

targetNodeName

The target node name.

peerNodeName

The peer node name.

hlAddress

The peer address of the high-level name.

llAddress

The peer address of the low-level name.

## Return codes

---

The following table describes the return codes for the `dsmBeginQuery` function call.

Table 1. Return codes for `dsmBeginQuery`

Return code	Return code number	Explanation
DSM_RC_NO_MEMORY	102	There is not enough memory to complete the request.
DSM_RC_FILE_SPACE_NOT_FOUND	124	The specified file space was not found.
DSM_RC_NO_POLICY_BLK	2007	Server policy information was not available.
DSM_RC_INVALID_OBJTYPE	2010	Invalid object type.
DSM_RC_INVALID_OBJOWNER	2019	Invalid object owner name.
DSM_RC_INVALID_OBJSTATE	2024	Invalid object condition.
DSM_RC_WRONG_VERSION_PARM	2065	The API version of the application client is different from the IBM Spectrum Protect™ library version.

## dsmBeginTxn

---

The `dsmBeginTxn` function call begins one or more IBM Spectrum Protect™ transactions that begin a complete action; either all the actions succeed or none succeed. An action can be either a single call or a series of calls. For example, a `dsmSendObj` call that is followed by a number of `dsmSendData` calls can be considered a single action. Similarly, a `dsmSendObj` call with a `dataBlkPtr` that indicates a data area containing the object to back up is also considered a single action.

Try to group more than one object together in a single transaction for data transfer operations. Grouping objects results in significant performance improvements in the IBM Spectrum Protect system. From both a client and a server perspective, a certain amount of overhead is incurred by starting and ending each transaction.

There are limits to what you can perform within a single transaction. These restrictions include:

- A maximum number of objects that you can send or delete in a single transaction. This limit is located in the data that `dsmQuerySessInfo` returns in the `ApiSessInfo.maxObjPerTxn` field. This corresponds to the `TxnGroupMax` server option.
- All objects that are sent to the server (either backup or archive) within a single transaction must have the same copy destination that is defined in the management class binding for the object. This value is located in the data that `dsmBindMC` returns in the `mcBindKey.backup_copy_dest` or `mcBindKey.archive_copy_dest` fields.

With the API, either the application client can monitor and control these restrictions, or the API can monitor these restrictions. If the API is monitoring restrictions, appropriate return codes from the API calls inform the application client when one or more restrictions are reached.

Always match a `dsmBeginTxn` call with a `dsmEndTxn` call to optimize the set of actions within a pair of `dsmBeginTxn` and `dsmEndTxn` calls.

## Syntax

---

```
dsInt16_t dsmBeginTxn (dsUInt32_t dsmHandle);
```

## Parameters

dsUInt32\_t dsmHandle (I)

The handle that associates this call with a previous **dsmInitEx** call.

## Return codes

The return code numbers are provided in parentheses ().

Table 1. Return codes for dsmBeginTxn

Return code	Explanation
DSM_RC_ABORT_NODE_NOT_AUTHORIZED (36)	FROMNODE or FROMOWNER is not allowed for TXN operations.

## dsmBindMC

The **dsmBindMC** function call associates, or binds, a management class to the passed object. The object is passed through the include-exclude list that is pointed to in the options file. If a match is not found in the Include list for a specific management class, the default management class is assigned. The Exclude list can prevent objects from a backup but not from an archive.

The application client can use the parameters that are returned in the `mcBindKey` structure to determine if this object should be backed up or archived, or whether a new transaction must be started because of different copy destinations. See **dsmBeginTxn** for more information.

Call **dsmBindMC** before you call **dsmSendObj** because every object must have a management class associated with it. This call can be performed within a transaction or outside of a transaction. For example, within a multiple object transaction, if **dsmBindMC** indicates that the object has a different copy destination than the previous object, the transaction must be ended and a new transaction started. In this case, another **dsmBindMC** is not required because one has already been performed for this object.

## Syntax

```
dsInt16_t dsmBindMC (dsUInt32_t dsmHandle,  
    dsmObjName *objNameP,  
    dsmSendType sendType,  
    mcBindKey *mcBindKeyP);
```

## Parameters

dsUInt32\_t dsmHandle (I)

The handle that associates this call with a previous **dsmInitEx** call.

dsmObjName \*objNameP (I)

A pointer to the structure that contains the file space name, high-level object name, low-level object name, and object type.

dsmSendType sendType (I)

Identifies whether this management class bind is performed for archive or backup sends. The possible values for this call include:

Name	Description
<b>stBackup</b>	A backup object
<b>stArchive</b>	An archive object
<b>stBackupMountWait</b>	A backup object
<b>stArchiveMountWait</b>	An archive object

For the **dsmBindMC** call, `stBackup` and `stBackupMountWait` are equivalent, and `stArchive` and `stArchiveMountWait` are equivalent.

mcBindKey \*mcBindKeyP (O)

This is the address of an `mcBindKey` structure where the management class information is returned. The application client can use the information that is returned here to determine if this object fits within a multiple object transaction, or to

perform a management class query on the management class that is bound to the object.

## Return codes

The return code numbers are provided in parentheses ().

Table 1. Return codes for dsmBindMC

Return code	Explanation
DSM_RC_NO_MEMORY (102)	There is no RAM remaining to complete the request.
DSM_RC_INVALID_PARM (109)	One of the parameters that was passed has an invalid value.
DSM_RC_TL_EXCLUDED (185)	The backup object is excluded and cannot be sent.
DSM_RC_INVALID_OBJTYPE (2010)	Invalid object type.
DSM_RC_INVALID_SENDTYPE (2022)	Invalid send type.
DSM_RC_WRONG_VERSION_PARM (2065)	Application client API version is different from the IBM Spectrum Protect™ library version.

## dsmChangePW

The **dsmChangePW** function call changes an IBM Spectrum Protect™ password. On a multiple-user operating system such as UNIX or Linux, only the root user or the authorized user can use this call.

On Windows operating systems, you can specify the password in the dsm.opt file. In this situation, **dsmChangePW** does not update the dsm.opt file. After the call to **dsmChangePW** is made, you must update the dsm.opt file separately.

This call must process successfully if **dsmInitEx** returns DSM\_RC\_VERIFIER\_EXPIRED. The session ends if the **dsmChangePW** call fails in this situation.

If **dsmChangePW** is called for some other reason, the session remains open regardless of the return code.

## Syntax

```
dsInt16_t dsmChangePW (dsUInt32_t dsmHandle,  
    char *oldPW,  
    char *newPW);
```

## Parameters

dsUInt32\_t dsmHandle (I)

The handle that associates this call with a previous **dsmInitEx** call.

char \*oldPW (I)

The old password of the caller. The maximum length is DSM\_MAX\_VERIFIER\_LENGTH.

char \*newPW (I)

The new password of the caller. The maximum length is DSM\_MAX\_VERIFIER\_LENGTH.

## Return codes

The return code numbers are provided in parentheses ().

Table 1. Return codes for dsmChangePW

Return code	Explanation
DSM_RC_ABORT_BAD_VERIFIER (6)	An incorrect password was entered.
DSM_RC_AUTH_FAILURE (137)	Authentication failure. Old password is incorrect.
DSM_RC_NEWPW_REQD (2030)	A value must be entered for the new password.
DSM_RC_OLDPW_REQD (2031)	A value must be entered for the old password.
DSM_RC_PASSWD_TOOLONG (2103)	The specified password is too long.



Return code	Explanation
DSM_RC_NEED_ROOT (2300)	The API caller must be a root user or an authorized user.

## dsmCleanUp

The **dsmCleanUp** function call is used if **dsmSetUp** was called. The **dsmCleanUp** function call should be called after **dsmTerminate**. You cannot make any other calls after you call **dsmCleanUp**.

There are no return codes that are specific to this call.

### Syntax

```
dsInt16_t DSMLINKAGE dsmCleanUp
(dsBool_t          mtFlag);
```

### Parameters

dsBool\_t mtFlag (I)

This parameter specifies that the API was used either in a single thread or a multithread mode. Possible values include:

- DSM\_SINGLETHREAD
- DSM\_MULTITHREAD

## dsmDeleteAccess

The **dsmDeleteAccess** function call deletes current authorization rules for backup versions or archived copies of your objects. When you delete an authorization rule, you revoke the access a user has to any files that are specified by the rule.

When you use **dsmDeleteAccess**, you can only delete one rule at a time. Obtain the rule ID through the **dsmQueryAccess** command.

There are no return codes that are specific to this call.

### Syntax

```
dsInt16_t DSMLINKAGE dsmDeleteAccess
(dsUInt32_t          dsmHandle,
 dsUInt32_t          ruleNum) ;
```

### Parameters

dsUInt32\_t dsmHandle (I)

The handle that associates this call with a previous **dsmInitEx** call.

dsUInt32\_t ruleNum (I)

The rule ID for the access rule that is deleted. This value is obtained from a **dsmQueryAccess** function call.

## dsmDeleteFS

The **dsmDeleteFS** function call deletes a file space from storage. To delete a file space, you must have the appropriate permissions that your IBM Spectrum Protect™ administrator gave you. To determine whether you have the necessary permissions, call **dsmQuerySessInfo**. This function call returns a data structure of type *ApiSessInfo*, that includes two fields, *archDel* and *backDel*.

Note:

- On a UNIX or Linux operating system, only a root user or an authorized user can delete a file space.
- If the file space that you need to delete contains backup versions, you must have backup delete authority (**backDel** = BACKDEL\_YES). If the file space contains archive copies, you must have archive delete authority (*archDel* = ARCHDEL\_YES). If the file space contains both backup versions and archive copies, you must have both types of delete authority.

- When using an archive manager server, a file space cannot actually be removed. This function call returns *rc=0* even though the file space was not actually deleted. The only way to verify that the file space has been deleted is to issue a filespace query to the server.
- The IBM Spectrum Protect server delete file-space function is a background process. If errors other than those detected before passing a return code happen, they are recorded in the IBM Spectrum Protect server log.

## Syntax

```
dsInt16_t dsmDeleteFS (dsUint32_t dsmHandle,
char *fsName,
unsigned char repository);
```

## Parameters

dsUint32\_t dsmHandle (I)

The handle that associates this call with a previous **dsmInitEx** call.

char \*fsName (I)

A pointer to the file space name to delete. The wildcard character is not permitted.

unsigned char repository (I)

Indicates whether the file space to delete is a backup repository, archive repository, or both. The possible values for this field include:

```
DSM_ARCHIVE_REP /* archive repository */
DSM_BACKUP_REP /* backup repository */
DSM_REPOS_ALL /* all repository types */
```

## Return codes

The return code numbers are provided in parentheses ().

Table 1. Return codes for dsmDeleteFS

Return code	Explanation
DSM_RC_ABORT_NOT_AUTHORIZED (27)	You do not have the necessary authority to delete the file space.
DSM_RC_INVALID_REPOS (2015)	Invalid value for repository.
DSM_RC_FSNAME_NOTFOUND (2060)	File space name not found.
DSM_RC_NEED_ROOT (2300)	API caller must be a root user.

## dsmDeleteObj

The **dsmDeleteObj** function call inactivates backup objects, deletes backup objects, or it deletes archive objects in storage. The **dtBackup** type inactivates the currently active backup copy only. The **dtBackupID** type removes from the server whichever object ID is specified. Call this function from within a transaction.

See **dsmBeginTxn** for more information.

Before you send **dsmDeleteObj**, send the query sequence that is described in Querying the IBM Spectrum Protect system to obtain the information for **delInfo**. The call to **dsmGetNextQObj** returns a data structure named **qryRespBackupData** for backup queries or **qryRespArchiveData** for archive queries. These data structures contain the information that you need for **delInfo**.

The value of **maxObjPerTxn** determines the maximum number of objects that you can delete in a single transaction. To obtain this value, call **dsmQuerySessInfo**.

Tip: Your node must have the appropriate permission that your administrator set. To delete archive objects, you must have archive delete authority. You do not need backup delete authority to inactivate a backup object.

## Syntax

```
dsInt16_t dsmDeleteObj (dsUint32_t dsmHandle,
dsmDelType delType,
dsmDelInfo delInfo)
```

## Parameters

dsUInt32\_t dsmHandle (I)

The handle that associates this call with a previous **dsmInitEx** call.

dsmDelType delType (I)

Indicates what type of object (backup or archive) to delete. Possible values include:

Name	Description
<b>dtArchive</b>	The object to delete was previously archived.
<b>dtBackup</b>	The object to inactivate was previously backed up.
<b>dtBackupID</b>	The object to delete was previously backed up. Restriction: Using this <b>delType</b> with <i>objID</i> removes the backup object from the server. Only an owner of an object can delete it.  You can delete any version (active or inactive) of an object. The server reconciles the versions. If you delete an active version of an object, the first inactive version becomes active. If you delete an inactive version of an object, all older versions will advance. The node must be registered with <b>backDel</b> permission.

dsmDelInfo delInfo (I)

A structure whose fields identify the object. The fields are different, depending on whether the object is a backup object or an archive object. The structure to inactivate a backup object, *delBack*, contains the object name and the object copy group. The structure for an archive object, *delArch*, contains the object ID.

The structure to remove a backup object, *delBackID*, contains the object ID.

## Return codes

The return code numbers are provided in parentheses ( ).

Table 1. Return codes for *dsmDeleteObj*

Return code	Explanation
DSM_RC_FS_NOT_REGISTERED (2061)	File space name is not registered.
DSM_RC_WRONG_VERSION_PARM (2065)	Application client API version is different from the IBM Spectrum Protect™ library version.

## dsmEndGetData

The **dsmEndGetData** function call ends a **dsmBeginGetData** session that obtains objects from storage.

The **dsmEndGetData** function call starts after all objects that you want to restore are processed, or ends the get process prematurely. Call **dsmEndGetData** to end a **dsmBeginGetData** session before you can continue other processing.

Depending on when **dsmEndGetData** is called, the API might need to finish processing a partial data stream before the process can be stopped. The caller, therefore, should not expect an immediate return from this call. Use **dsmTerminate** if the application needs to close the session and end the restore immediately.

There are no return codes that are specific to this call.

## Syntax

```
dsInt16_t dsmEndGetData (dsUInt32_t dsmHandle);
```

## Parameters

dsUInt32\_t dsmHandle (I)

The handle that associates this call with a previous **dsmInitEx** call.

## dsmEndGetDataEx

The **dsmEndGetDataEx** function call provides the total of LAN-free bytes that were sent. It is an extension of the **dsmEndGetData** function call.

## Syntax

---

There are no return codes that are specific to this call.

```
dsInt16_t dsmEndGetDataEx (dsmEndGetDataExIn_t * dsmEndGetDataExInP,  
                           dsmEndGetDataExOut_t * dsmEndGetDataExOutP);
```

## Parameters

---

dsmEndGetDataExIn\_t \*dsmEndGetDataExInP (I)

Passes the end get object dsmHandle that identifies the session and associates it with subsequent calls.

dsmEndGetDataExOut\_t \*dsmEndGetDataExOutP (O)

This structure contains this input parameter:

totalLFBytesRecv

The total LAN-free bytes that are received.

## dsmEndGetObj

---

The **dsmEndGetObj** function call ends a **dsmGetObj** session that obtains data for a specified object.

Start the **dsmEndGetObj** call after an end of data is received for the object. This indicates that all data was received, or that no more data will be received for this object. Before you can start another **dsmGetObj** call, you must call **dsmEndGetObj**.

Depending on when **dsmEndGetObj** is called, the API might need to finish processing a partial data stream before the process can stop. Do not expect an immediate return from this call.

## Syntax

---

```
dsInt16_t dsmEndGetObj (dsUInt32_t dsmHandle);
```

## Parameters

---

dsUInt32\_t dsmHandle (I)

The handle that associates this call with a previous **dsmInitEx** call.

## Return codes

---

The return code numbers are provided in parentheses ().

Table 1. Return codes for dsmEndGetObj

Return code	Explanation
DSM_RC_NO_MEMORY (102)	There is no RAM remaining to complete the request.

## dsmEndQuery

---

The **dsmEndQuery** function call signifies the end of a **dsmBeginQuery** action. The application client sends **dsmEndQuery** to complete a query. This call either is sent after all query responses are obtained through **dsmGetNextQObj**, or it is sent to end a query before all data are returned.

Tip: IBM Spectrum Protect™ continues to send the query data from the server to the client in this case, but the API discards any remaining data.

Once a **dsmBeginQuery** is sent, a **dsmEndQuery** must be sent before any other activity can start.

There are no return codes that are specific to this call.

## Syntax

---

```
dsInt16_t dsmEndQuery (dsUInt32_t dsmHandle);
```

## Parameters

---

dsUInt32\_t dsmHandle (I)

The handle that associates this call with a previous **dsmInitEx** call.

## dsmEndSendObj

---

The **dsmEndSendObj** function call indicates the end of data that is sent to storage.

Enter the **dsmEndSendObj** function call to indicate the end of data from the **dsmSendObj** and **dsmSendData** calls. A protocol violation occurs if this is not performed. The exception to this rule is if you call **dsmEndTxn** to end the transaction. Doing this discards all data that was sent for the transaction.

## Syntax

---

```
dsInt16_t dsmEndSendObj (dsUInt32_t dsmHandle);
```

## Parameters

---

dsUInt32\_t dsmHandle (I)

The handle that associates this call with a previous **dsmInitEx** call.

## Return codes

---

The return code numbers are provided in parentheses ().

Table 1. Return codes for dsmEndSendObj

Return code	Explanation
DSM_RC_NO_MEMORY (102)	There is no RAM remaining to complete this request.

## dsmEndSendObjEx

---

The **dsmEndSendObjEx** function call provides additional information regarding the number of bytes processed. The information includes: total bytes sent, compression information, lan-free bytes, and deduplication information.

The **dsmEndSendObjEx** function call is an extension of the **dsmEndSendObj** function call.

## Syntax

---

```
dsInt16_t dsmEndSendObjEx (dsmEndSendObjExIn_t *dsmEndSendObjExInP,  
                           dsmEndSendObjExOut_t *dsmEndSendObjExOutP);
```

## Parameters

---

dsmEndSendObjExIn\_t \*dsmEndSendObjExInP (I)

This parameter passes the end send object dsmHandle that identifies the session and associates it with subsequent calls.

dsmEndSendObjExOut\_t \*dsmEndSendObjExOutP (O)

This parameter passes the end send object information:

Name	Description
<b>totalBytesSent</b>	The total number of bytes that are read from the application.
<b>objCompressed</b>	A flag that displays if the object was compressed.
<b>totalCompressedSize</b>	The total byte size after compression.
<b>totalLFBytesSent</b>	The total LAN-free bytes that were sent.
<b>objDeduplicated</b>	A flag that displays if the object was deduplicated by the API.

	Name	Description
	<b>totalDedupSize</b>	Total bytes sent after deduplication.

## Return codes

The return code numbers are provided in parentheses ().

Table 1. Return codes for dsmEndSendObjEx

Return code	Explanation
DSM_RC_NO_MEMORY (102)	There is no RAM remaining to complete this request.

## dsmEndTxn

The dsmEndTxn function call ends an IBM Spectrum Protect™ transaction. Pair the dsmEndTxn function call with dsmBeginTxn to identify the call or set of calls that are considered a transaction. The application client can specify on the dsmEndTxn call whether the transaction must be committed or ended.

Perform all of the following calls within the bounds of a transaction:

- **dsmSendObj**
- **dsmSendData**
- **dsmEndSendObj**
- **dsmDeleteObj**

## Syntax

```
dsInt16_t dsmEndTxn (dsUInt32_t dsmHandle,
                    dsUInt8_t vote,
                    dsUInt16_t *reason);
```

## Parameters

dsUInt32\_t dsmHandle (I)

The handle that associates this call with a previous dsmInitEx call.

dsUInt8\_t vote (I)

Indicates whether the application client commits all the actions that are done between the previous dsmBeginTxn call and this call. The following values are possible:

```
DSM_VOTE_COMMIT /* commit current transaction */
DSM_VOTE_ABORT /* roll back current transaction */
```

Use DSM\_VOTE\_ABORT only if your application finds a reason to stop the transaction.

dsUInt16\_t \*reason (O)

If the call to dsmEndTxn ends with an error, or the value of vote is not agreed to, this parameter has a reason code that indicates why the vote failed. The return code for the call might be zero, and the reason code might be non-zero. Therefore, the application client must always check for errors on both the return code and the reason (if (rc || reason)) before you can assume a successful completion.

If the application specifies a vote of DSM\_VOTE\_ABORT, the reason code is DSM\_RS\_ABORT\_BY\_CLIENT (3). See API return codes source file: dsmsrc.h for a list of the possible reason codes. Numbers 1 through 50 in the return codes list are reserved for the reason codes. If the server ends the transaction, the return code is DSM\_RC\_CHECK\_REASON\_CODE. In this case, the reason value contains more information on the cause of the abort.

## Return codes

The return code numbers are provided in parentheses ().

Table 1. Return codes for dsmEndTxn

Return code	Explanation
-------------	-------------

Return code	Explanation
DSM_RC_ABORT_CRC_FAILED (236)	The CRC that was received from the server does not match the CRC that was calculated by the client.
DSM_RC_INVALID_VOTE (2011)	The value that was specified for <code>vote</code> is not valid.
DSM_RC_CHECK_REASON_CODE (2302)	The transaction was aborted. Check the reason field.
DSM_RC_ABORT_STGPOOL_COPY_CONT_NO (241)	The write to one of the copy storage pools failed, and the IBM Spectrum Protect storage pool option COPYCONTINUE is set to NO. The transaction terminates.
DSM_RC_ABORT_RETRY_SINGLE_TXN (242)	This abort code indicates that the current transaction was aborted because of a problem during a store operation. The problem can be resolved by sending each file in an individual transaction. This error is typical in the following circumstances: <ul style="list-style-type: none"> <li>• The next storage pool has a different copy storage pool list.</li> <li>• The operation is switched to this pool in the middle of a transaction.</li> </ul>

## dsmEndTxnEx

The **dsmEndTxnEx** function call provides group leader object ID information for you to use with the **dsmGroupHandler** function call. It is an extension of the **dsmEndTxn** function call.

### Syntax

```
dsInt16_t dsmEndTxnEx (dsmEndTxnExIn_t *dsmEndTxnExInP
                      dsmEndTxnExOut_t *dsmEndTxnExOutP);
```

### Parameters

**dsmEndTxnExIn\_t \*dsmEndTxnExInP (I)**

This structure contains the following parameters:

**dsmHandle**

The handle that identifies the session and associates it with subsequent IBM Spectrum Protect™ calls.

**dsUInt8\_t vote (I)**

Indicates whether or not the application client commits all the actions that are done between the previous **dsmBeginTxn** call and this call. The possible values are:

```
DSM_VOTE_COMMIT    /* commit current transaction */
DSM_VOTE_ABORT     /* roll back current transaction */
```

Use **DSM\_VOTE\_ABORT** only if your application has found a reason to stop the transaction.

**dsmEndTxnExOut\_t \*dsmEndTxnExOutP (O)**

This structure contains the following parameters:

**dsUInt16\_t \*reason (O)**

If the call to **dsmEndTxnEx** ends with an error or the value of `vote` is not agreed to, this parameter has a reason code indicating why the vote failed.

Tip: The return code for the call might be zero, and the reason code might be non-zero. Therefore, the application client must always check for errors on both the return code and the reason (`if (rc || reason)`) before you can assume a successful completion.

If the application specifies a vote of **DSM\_VOTE\_ABORT**, the reason code is **DSM\_RS\_ABORT\_BY\_CLIENT** (3). See API return codes source file: `dsmrc.h` for a list of the possible reason codes. Numbers 1 through 50 in the return codes list are reserved for the reason codes. If the server ends the transaction, the return code is **DSM\_RC\_CHECK\_REASON\_CODE**. In this case, the reason value contains more information on the cause of the abort.

groupLeaderObjId

The group leader object ID that is returned when the DSM\_ACTION\_OPEN flag is used with the **dsmGroupHandler** call.

## Return codes

The return code numbers are provided in parentheses ( ).

Table 1. Return codes for dsmEndTxnEx

Return code	Explanation
DSM_RC_INVALID_VOTE (2011)	The value that was specified for vote is invalid.
DSM_RC_CHECK_REASON_CODE (2302)	The transaction was aborted. Check the reason field.
DSM_RC_ABORT_STGPOOL_COPY_CONT_NO (241)	The write to one of the copy storage pools failed, and the IBM Spectrum Protect storage pool option COPYCONTINUE was set to NO. The transaction terminates.
DSM_RC_ABORT_RETRY_SINGLE_TXN (242)	During a simultaneous-write operation, an object in the transaction is going to a destination with different copy storage pools. End the current transaction and send each object again in its own transaction.

## dsmGetData

The **dsmGetData** function call obtains a byte stream of data from IBM Spectrum Protect™ and places it in the caller's buffer. The application client calls **dsmGetData** when there is more data to receive from a previous **dsmGetObj** or **dsmGetData** call.

## Syntax

```
dsInt16_t dsmGetData (dsUInt32_t dsmHandle,  
DataBlk *dataBlkPtr);
```

## Parameters

dsUInt32\_t dsmHandle (I)

The handle that associates this call with a previous **dsmInitEx** call.

DataBlk \*dataBlkPtr (I/O)

Points to a structure that includes both a pointer to the buffer for the data that is received and the size of the buffer. On return, this structure contains the number of bytes that is actually transferred. See API type definitions source files for the type definition.

## Return codes

The return code numbers are provided in parentheses ( ).

Table 1. Return codes for dsmGetData

Return code	Explanation
DSM_RC_ABORT_INVALID_OFFSET (33)	The offset that was specified during a partial object retrieve is greater than the length of the object.
DSM_RC_ABORT_INVALID_LENGTH (34)	The length that was specified during a partial object retrieve is greater than the length of the object, or the offset in addition to the length extends beyond the end of the object.
DSM_RC_FINISHED (121)	Finished processing. The last buffer was received. Check <code>numBytes</code> for the amount of data and then call IBM Spectrum Protect <code>dsmEndGetObj</code> .
DSM_RC_NULL_DATABLKPTR (2001)	Datablock pointer is null.
DSM_RC_ZERO_BUFLen (2008)	Buffer length is zero for datablock pointer.
DSM_RC_NULL_BUFPtr (2009)	Buffer pointer is null for datablock pointer.



Return code	Explanation
DSM_RC_WRONG_VERSION_PARM (2065)	The application client's API version is different from the IBM Spectrum Protect library version.
DSM_RC_MORE_DATA (2200)	There is more data to get.

## dsmGetBufferData

The **dsmGetBufferData** function call receives a byte stream of data from IBM Spectrum Protect™ through a buffer. After each call the application needs to copy the data and release the buffer through a call to **dsmReleaseBuffer**. If the number of buffers held by the application equals the numTsmBuffers specified in the **dsmInitEx** call, the **dsmGetBufferData** function blocks until a **dsmReleaseBuffer** is called.

### Syntax

```
dsInt16_t dsmGetBufferData (getDataExIn_t *dsmGetBufferDataExInP,
                           getDataExOut_t *dsmGetBufferDataExOutP) ;
```

### Parameters

getDataExIn\_t \* dsmGetBufferDataExInP (I)

This structure contains the following input parameter.

dsUInt32\_t dsmHandle

The handle that identifies the session and associates it with a previous **dsmInitEx** call.

getDataExOut\_t \* dsmGetBufferDataExOutP (O)

This structure contains the following output parameters.

dsUInt8\_t tsmBufferHandle(0)

The handle that identifies the buffer received.

char \*dataPtr(0)

The address to which the data was written.

dsUInt32\_t numBytes(0)

Actual number of bytes written by IBM Spectrum Protect.

### Return codes

The return code numbers are provided in parentheses ().

Table 1. Return codes for dsmGetBufferData

Return code	Explanation
DSM_RC_BAD_CALL_SEQUENCE (2041)	The call was not issued in the proper state.
DSM_RC_OBJ_ENCRYPTED (2049)	This function cannot be used for encrypted objects.
DSM_RC_OBJ_COMPRESSED (2048)	This function cannot be used for compressed objects.
DSM_RC_BUFF_ARRAY_ERROR (2045)	A buffer array error occurred.

## dsmGetNextQObj

The **dsmGetNextQObj** function call gets the next query response from a previous **dsmBeginQuery** call and places the response in the caller buffer.

The **dsmGetNextQObj** call is called one or more times. Each time the function is called, either a single query record is retrieved, or an error or a **DSM\_RC\_FINISHED** reason code is returned. If **DSM\_RC\_FINISHED** is returned, there is no more data to process. When all query data is retrieved, or if no more query data is needed, send the **dsmEndQuery** call to end the query process.

The dataBlkPtr parameter must point to a buffer that is defined with the qryResp\*Data structure type. The context in which **dsmGetNextQObj** is called determines the type of structure that is entered on the query response.

## Syntax

```
dsInt16_t dsmGetNextQObj (dsUInt32_t dsmHandle,  
DataBlk *dataBlkPtr);
```

## Parameters

dsUInt32\_t dsmHandle (I)

The handle that associates this call with a previous dsmInitEx call.

DataBlk \*dataBlkPtr (I/O)

Points to a structure that includes both a pointer to the buffer for the data to be received and the size of the buffer. This buffer is the qryResp\*Data response structure. On return, this structure contains the number of bytes that is transferred. The structure that is associated with each type of query is described in the following table. For more information about the type definition of DataBlk, see the following topic: API type definitions source files.

Table 1. DataBlk pointer structure

Query	Response structure	Fields of special interest
qtArchive	qryRespArchiveData	sizeEstimate Contains the value that is passed on a previous dsmSendObj call. mediaClass Can have a value of MEDIA_FIXED if the object is on disk, or MEDIA_LIBRARY if the object is on tape. clientDeduplicated Indicates whether this object is deduplicated by the client.
qtBackup	qryRespBackupData	restoreOrderExt Is of type dsUInt16_t. Sort on this field when several objects are restored on a dsmBeginGetData call. An example of sorting code for this call is in the API sample, dapiqry.c. For a sorting example, see the following topic: Figure 1. sizeEstimate Contains the value that is passed on a previous dsmSendObj call. mediaClass Can have a value of MEDIA_FIXED if the object is on disk or MEDIA_LIBRARY if the object is on tape. clientDeduplicated Indicates whether this object is deduplicated by the client.
qtBackupActive	qryARespBackupData	
qtBackupGroups	qryRespBackupData	dsBool_t isGroupLeader If true, signifies this object is a group leader.
qtOpenGroups	qryRespBackupData	dsBool_t isOpenGroup; If true, signifies this group is open and not complete.

Query	Response structure	Fields of special interest
qtFilespace	qryRespFSData	<p>backStartDate Contains the server time stamp when the file space is updated with the backStartDate action.</p> <p>backCompleteDate Contains the server time stamp when the file space is updated with the backCompleteDate action.</p> <p>lastReplStartDate Contains the time stamp for the last time that replication was started on the server.</p> <p>lastReplCmpltDate Contains the time stamp for the last time that replication was completed, even if there was a failure.</p> <p>lastBackOpDateFromServer Contains the last store time stamp that was saved on the server.</p> <p>lastBackOpDateFromLocal Contains the last store time stamp that was saved on the client.</p>
qtMC	qryRespMCData qryRespMCDetailData	
qtProxyNodeAuth	qryRespProxyNodeData targetNodeName peerNodeName hlAddress llAddress	
qtProxyNodePeer	qryRespProaxyNodeData targetNodeName peerNodeName hlAddress llAddress	

## Return codes

The following table describes the return codes for the dsmGetNextQObj function call.

Table 2. Return codes for the dsmGetNextQObj function call

Return code	Return code number	Description
DSM_RC_ABORT_NO_MATCH	2	No match for the query was requested.
DSM_RC_FINISHED	121	Finished processing (start dsmEndQuery). There is no more data to process.
DSM_RC_UNKNOWN_FORMAT	122	The file that IBM Spectrum Protect™ attempted to restore or retrieve has an unknown format.
DSM_RC_COMM_PROTOCOL_ERROR	136	Communication protocol error.
DSM_RC_NULL_DATA_BLKPTR	2001	Pointer is not pointing to a data block.
DSM_RC_INVALID_MCNAME	2025	Invalid management class name.
DSM_RC_BAD_CALL_SEQUENCE	2041	The sequence of calls is invalid.
DSM_RC_WRONG_VERSION_PARM	2065	The version of the application client API is different from the IBM Spectrum Protect library version.
DSM_RC_MORE_DATA	2200	There is more data to get.

Return code	Return code number	Description
DSM_RC_BUFF_TOO_SMALL	2210	Buffer is too small.

## dsmGetObj

The **dsmGetObj** function call obtains the requested object data from the IBM Spectrum Protect™ data stream and places it in the caller's buffer. The **dsmGetObj** call uses the object ID to obtain the next object or partial object from the data stream.

The data for the indicated object is placed in the buffer to which **DataBlk** points. If more data is available, you must make one or more calls to **dsmGetData** to receive the remaining object data until a return code of DSM\_RC\_FINISHED is returned. Check the `numBytes` field in **DataBlk** to see whether any data remains in the buffer.

Objects should be asked for in the order that they were listed on the **dsmBeginGetData** call in the **dsmGetList** parameter. The exception is when the application client needs to pass over an object in the data stream to get to an object later in the list. If the object that is indicated by the object ID is not the next object in the stream, the data stream is processed until the object is located, or the stream is completed. Use this feature with care, because it might be necessary to process and discard large amounts of data to locate the requested object.

Requirement: If **dsmGetObj** returns a failure code (NOT FINISHED or MORE\_DATA), the session must be terminated to stop the restore operation. This is especially important when you use encryption and receive a RC\_ENC\_WRONG\_KEY. You must start a new session with the proper key.

## Syntax

```
dsInt16_t dsmGetObj (dsUInt32_t dsmHandle,
    ObjID *objIdP,
    DataBlk *dataBlkPtr);
```

## Parameters

- dsUInt32\_t dsmHandle (I)  
The handle that associates this call with a previous **dsmInitEx** call.
- ObjID \*objIdP (I)  
A pointer to the ID of the object to restore.
- DataBlk \*dataBlkPtr (I/O)  
A pointer to the buffer where the restored data are placed.

## Return codes

The return code numbers are provided in parentheses ().

Table 1. Return codes for dsmGetObj

Return code	Explanation
DSM_RC_ABORT_INVALID_OFFSET (33)	The offset that is specified during a partial object retrieve is greater than the length of the object.
DSM_RC_ABORT_INVALID_LENGTH (34)	The length that is specified during a partial object retrieve is greater than the length of the object, or the offset in addition to the length extends past the end of the object.
DSM_RC_FINISHED (121)	Finished processing (start <b>dsmEndGetObj</b> ).
DSM_RC_WRONG_VERSION_PARM (2065)	Application client's API version is different from the IBM Spectrum Protect library version.
DSM_RC_MORE_DATA (2200)	There is more data to get.
RC_ENC_WRONG_KEY (4580)	The key provided in the <b>dsmInitEx</b> call, or the saved key, does not match the key that was used to encrypt this object. Terminate the session and provide the proper key.

## dsmGroupHandler

The **dsmGroupHandler** function call performs an action on a logical file group depending on the input that is given. The client relates a number of individual objects together to reference and manage on the IBM Spectrum Protect™ server as a logical group.

For more information, see File grouping.

## Syntax

---

```
dsInt16_t dsmGroupHandler (dsmGroupHandlerIn_t *dsmGroupHandlerInP,  
                           dsmGroupHandlerOut_t *dsmGroupHandlerOutP);
```

## Parameters

---

dsmGroupHandlerIn\_t \*dsmGroupHandlerInP (I)

Passes group attributes to the API.

groupType

The type of the group. Values include:

- DSM\_GROUPTYPE\_PEER - peer group

actionType

The action to be executed. Values include:

- DSM\_GROUP\_ACTION\_OPEN - creates a new group
- DSM\_GROUP\_ACTION\_CLOSE - commits and saves an open group
- DSM\_GROUP\_ACTION\_ADD - appends to a group
- DSM\_GROUP\_ACTION\_ASSIGNTO - assigns to another group
- DSM\_GROUP\_ACTION\_REMOVE - removes a member from a group

memberType.

The group type of the object. Values include:

- DSM\_MEMBERTYPE\_LEADER - group leader
- DSM\_MEMBERTYPE\_MEMBER - group member

\*uniqueGroupTagP

A unique string ID that is associated with a group.

leaderObjId

The Object ID for the group leader.

\*objNameP

A pointer to the object name of the group leader.

memberObjList

A list of objects to remove or assign.

dsmGroupHandlerOut\_t \*dsmGroupHandlerOutP (O)

Passes the address of the structure that the API completes. The structure version number is returned.

## Return codes

---

The return code numbers are provided in parentheses ().

Table 1. Return codes for dsmGroupHandler

Return code	Explanation
DSM_RC_ABORT_INVALID_GROUP_ACTION (237)	An invalid operation was attempted on a group leader or member.

## dsmInit

---

The **dsmInit** function call starts an API session and connects the client to IBM Spectrum Protect™ storage. The application client can have only one active session open at a time. To open another session with different parameters, use the **dsmTerminate** call first to end the current session.

To permit cross-node query and restore or retrieve, use the *-fromnode* and *-fromowner* string options. See Accessing objects across nodes and owners for more information.

## Syntax

---

```
dsInt16_t dsmInit (dsUint32_t *dsmHandle,  
    dsmApiVersion *dsmApiVersionP,  
    char *clientNodeNameP,  
    char *clientOwnerNameP,  
    char *clientPasswordP,  
    char *applicationType,  
    char *configfile,  
    char *options);
```

## Parameters

---

dsUint32\_t \*dsmHandle (O)

The handle that identifies this initialization session and associates it with subsequent IBM Spectrum Protect calls.

dsmApiVersion \*dsmApiVersionP (I)

A pointer to the data structure identifying the version of the API that the application client is using for this session. The structure contains the values of the three constants, DSM\_API\_VERSION, DSM\_API\_RELEASE, and DSM\_API\_LEVEL, that are set in the dsmapi.h file. A previous call to **dsmQueryApiVersion** must be performed to ensure that compatibility exists between the application client API version and the version of the API library that is installed on the user's workstation.

char \*clientNodeNameP (I)

This parameter is a pointer to the node for the IBM Spectrum Protect session. All sessions must have a node name associated with them. The constant, DSM\_MAX\_NODE\_LENGTH, in the dsmapi.h file sets the maximum size that is permitted for a node name.

The node name is not case-sensitive.

If this parameter is set both to NULL and *passwordaccess* is set to *prompt*, the API attempts to obtain the node name first from the options string that was passed. If it is not there, the API then attempts to obtain the node name from the configuration file or options files. If these attempts to find the node name fail, the UNIX or Linux API uses the system host name, while APIs on other operating systems return the DSM\_RC\_REJECT\_ID\_UNKNOWN code.

This parameter must be NULL if the *passwordaccess* option in the dsm.sys file is set to *generate*. The API uses the system host name.

char \*clientOwnerNameP (I)

This parameter is a pointer to the owner of the IBM Spectrum Protect session. If the operating system on which the session starts is a multi-user operating system, an owner name of NULL (the root user) has the authority to back up, archive, restore, or retrieve any objects belonging to the application, regardless of the owner of the object.

The owner name is case-sensitive.

This parameter must be NULL if the *passwordaccess* option in the dsm.sys file is set to *generate*. The API then uses the login user ID.

Note: On a multi-user operating system, if *passwordaccess* is set to *prompt*, it is not necessary for the owner name to match the active user ID of the session running the application.

char \*clientPasswordP (I)

This parameter is a pointer to the password of the node on which the IBM Spectrum Protect session runs. The DSM\_MAX\_VERIFIER\_LENGTH constant in the dsmapi.h file sets the maximum size that is permitted for a password.

The password is not case-sensitive.

Except when the password file is first started, the value of this parameter is ignored if *passwordaccess* is set to *generate*.

char \*applicationType (I)

This parameter identifies the application that is running the session. The application client defines the value.

Each time an API application client starts a session with the server, the application type (or platform) of the client is updated on the server. We recommend that the application type value contain an operating system abbreviation because this value is entered in the **platform** field on the server. The maximum string length is DSM\_MAX\_PLATFORM\_LENGTH.

To see the current value of the application type, call **dsmQuerySessInfo**.

char \*configfile (I)

This parameter points to a character string that contains the fully-qualified name of an API configuration file. Options specified in the API configuration file override their specification in the client options file. Options files are defined when IBM Spectrum Protect (client or API) is installed.

char \*options (I)

Points to a character string that can contain user options such as:

- *Compressalways*
- *Servername* (UNIX or Linux only)
- *TCPServeraddr*
- *Fromnode*
- *Fromowner*
- *EnableClientEncryptKey*

The application client can use the option list to override the values of these options that the configuration file sets.

The format of the options is:

1. Each option that is specified in the option list begins with a dash (-) and is followed by the option keyword.
2. The keyword, in turn, is followed by an equal sign (=) and then followed by the option parameter.
3. If the option parameter contains a blank space, enclose the parameter with single or double quotes.
4. If more than one option is specified, separate the options with blanks.

If options are NULL, values for all options are taken from the user options file or the API configuration file.

## Return codes

The return code numbers are provided in parentheses ( ).

Table 1. Return codes for dsmInit

Return code	Explanation
DSM_RC_ABORT_SYSTEM_ERROR (1)	The server has detected a system error and has notified the clients.
DSM_RC_REJECT_VERIFIER_EXPIRED (52)	Password has expired and must be updated.
DSM_RC_REJECT_ID_UNKNOWN (53)	Could not find the node name.
DSM_RC_AUTH_FAILURE (137)	There was an authentication failure.
DSM_RC_NO_STARTING_DELIMITER (148)	There is no starting delimiter in pattern.
DSM_RC_NEEDED_DIR_DELIMITER (149)	A directory delimiter is needed immediately before and after the "match directories" meta-string ("...") and one was not located.
DSM_RC_NO_PASS_FILE (168)	The password file is not available.
DSM_RC_UNMATCHED_QUOTE (177)	An unmatched quote is in the option string.
DSM_RC_NLS_CANT_OPEN_TXT (0610)	Unable to open the message text file.
DSM_RC_INVALID_OPT (400)	An entry in the option string is invalid.
DSM_RC_INVALID_DS_HANDLE (2014)	Invalid DSM handle.
DSM_RC_NO_OWNER_REQD (2032)	Owner parameter must be NULL when <i>passwordaccess</i> is set to <i>generate</i> .
DSM_RC_NO_NODE_REQD (2033)	Node parameter must be NULL when <i>passwordaccess</i> is set to <i>generate</i> .
DSM_RC_WRONG_VERSION (2064)	The API version for the application client has a higher value than the IBM Spectrum Protect version.
DSM_RC_PASSWD_TOOLONG (2103)	The password that was specified is too long.
DSM_RC_NO_OPT_FILE (2220)	A configuration file could not be located.
DSM_RC_INVALID_KEYWORD (2221)	A keyword that was specified in an options string is invalid.
DSM_RC_PATTERN_TOO_COMPLEX (2222)	The include-exclude pattern is too complex for IBM Spectrum Protect to interpret.
DSM_RC_NO_CLOSING_BRACKET (2223)	There is no closing bracket in the pattern.

Return code	Explanation
DSM_RC_INVALID_SERVER (2225)	For a multi-user environment, the server in the system configuration file was not found.
DSM_RC_NO_HOST_ADDR (2226)	Not enough information to connect to host.
DSM_RC_MACHINE_SAME (2227)	The nodename that is defined in the options file cannot be the same as the system host name.
DSM_RC_NO_API_CONFIGFILE (2228)	Cannot open the configuration file.
DSM_RC_NO_INCLEXCL_FILE (2229)	The include-exclude file was not found.
DSM_RC_NO_SYS_OR_INCLEXCL (2230)	Either the dsm.sys file or the include-exclude file was not found.

**Related concepts:**

Client options file overview  
Processing options

## dsmInitEx

The dsmInitEx function call starts an API session by using the additional parameters for extended verification.

### Syntax

```
dsInt16_t dsmInitEx (dsUInt32_t *dsmHandleP,
                    dsmInitExIn_t *dsmInitExInP,
                    dsmInitExOut_t *dsmInitExOutP) ;
```

### Parameters

dsUInt32\_t \*dsmHandleP (O)

The handle that identifies this initialization session and associates it with subsequent IBM Spectrum Protect™ calls.

dsmInitExIn\_t \*dsmInitExInP

This structure contains the following input parameters:

dsmApiVersion \*dsmApiVersionP (I)

This parameter is a pointer to the data structure that identifies the version of the API that the application client is using for this session. The structure contains the values of the four constants, DSM\_API\_VERSION, DSM\_API\_RELEASE, DSM\_API\_LEVEL, and DSM\_API\_SUBLEVEL that are set in the dsmapitd.h file. Call dsmQueryApiVersionEx and verify that the API version of the application client and the version of the API library that is installed on the user's workstation is compatible.

char \*clientNodeNameP (I)

This parameter is a pointer to the node for the IBM Spectrum Protect session. All sessions must be associated with a node name. The DSM\_MAX\_NODE\_LENGTH constant in the dsmapitd.h file sets the maximum size for a node name.

The node name is not case-sensitive.

If this parameter is set to NULL, and passwordaccess is set to prompt, the API attempts to obtain the node name first from the options string that was passed. If it is not there, the API then attempts to obtain the node name from the configuration file or options files. If these attempts to find the node name fail, the UNIX or Linux API uses the system host name, while the APIs from other operating systems return DSM\_RC\_REJECT\_ID\_UNKNOWN.

This parameter must be NULL if the passwordaccess option in the dsm.sys file is set to generate. The API then uses the system host name.

char \*clientOwnerNameP (I)

This parameter is a pointer to the owner of the IBM Spectrum Protect session. If the operating system is a multi-user platform, an owner name of NULL (the root user) has the authority to back up, archive, restore, or retrieve any objects that belong to the application, regardless of the owner of the object.

The owner name is case-sensitive.

This parameter must be NULL if the passwordaccess option in the dsm.sys file is set to generate. The API then uses the login user ID.



Tip: On a multi-user platform, if passwordaccess is set to prompt, it is not necessary for the owner name to match the active user ID of the session that is running the application.

char \*clientPasswordP (I)

A pointer to the password of the node on which the IBM Spectrum Protect session runs. The DSM\_MAX\_VERIFIER\_LENGTH constant in the dsmapitd.h file sets the maximum size that is allowed for a password.

The password is not case-sensitive.

Except when the password file is first started, the value of this parameter is ignored if passwordaccess is set to generate.

char \*userNameP;

A pointer to the administrative user name that has client authority for this node.

char \*userPasswordP;

A pointer to the password for the userName parameter, if a value is supplied.

char \*applicationType (I)

Identifies the application that is running the IBM Spectrum Protect session. The application client identifies the value.

Each time an API application client starts a session with the server, the application type (or operating system) of the client is updated on the server. The value is entered in the platform field on the server. Consider using an operating system ID in the value. The maximum string length is defined in the DSM\_MAX\_PLATFORM\_LENGTH constant.

To view the current value of the application type, call dsmQuerySessInfo.

char \*configfile (I)

Points to a character string that contains the fully qualified name of an API configuration file. Options that are specified in the API configuration file override their specification in the client options file. Options files are defined when IBM Spectrum Protect (client or API) is installed.

char \*options (I)

Points to a character string that can contain user options such as:

- Compressalways
- Servername (UNIX and Linux systems only)
- TCPServeraddr (not for UNIX systems)
- Fromnode
- Fromowner

The application client can use the options list to override the values of these options that the configuration file sets.

Options have the following format:

1. Each option that is specified in the option list begins with a dash (-) and is followed by the option keyword.
2. The keyword is followed by an equal sign (=) and then the option parameter.
3. If the option parameter contains a blank space, enclose the parameter with single or double quotation marks.
4. If more than one option is specified, separate the options with blanks.

If options are NULL, the values for all options are taken from the user options file or the API configuration file.

dirDelimiter

The directory delimiter that is prefixed on the file space, high-level or low-level names. You must specify the dirDelimiter parameter only if the application overrides the system defaults. In a UNIX or Linux environment, the default is forward slash (/). In a Windows environment, the default is backslash (\).

useUnicode

A Boolean flag that indicates whether Unicode is enabled. The useUnicode flag must be false to achieve cross-platform interoperability between UNIX and Windows systems.

bCrossPlatform

A Boolean flag that must be set (bTrue) to achieve cross-platform interoperability between UNIX and Windows systems. When the bCrossPlatform flag is set, the API ensures that the file spaces are not Unicode and that the application does not use Unicode. A Windows application that uses Unicode is not compatible with applications that use non-Unicode encodings. The bCrossPlatform flag must not be set for a Windows application that uses Unicode.

UseTsmBuffers

Indicates whether to use buffer copy elimination.

numTsmBuffers

Number of buffers when useTsmBuffers=bTrue.

bEncryptKeyEnabled

Indicates whether encryption with application-managed key is used.

encryptionPasswordP

The encryption password.

Restriction: When `encryptkey=save`, if an encrypt key exists, the value that is specified in the `encryptionPasswordP` is ignored.

dsmAppVersion \*appVersionP (I)

This parameter is a pointer to the data structure that identifies the version information of the application that is starting an API session. The structure contains the values of the four constants, `applicationVersion`, `applicationRelease`, `applicationLevel`, and `applicationSubLevel`, which are set in the `tsmapitd.h` file.

dsmInitExOut\_t \*dsmInitExOut P

This structure contains the output parameters.

dsUint32\_t \*dsmHandle (0)

The handle that identifies this initialization session and associates it with subsequent API calls.

infoRC

Additional information about the return code. Check both the function return code and the value of `infoRC`. An `infoRC` value of `DSM_RC_REJECT_LASTSESS_CANCELED` (69), the IBM Spectrum Protect indicates that the administrator canceled the last session.

## Return codes

The return code numbers are provided in parentheses ( ).

Table 1. Return codes for dsmInitEx

Return code	Explanation
DSM_RC_ABORT_SYSTEM_ERROR (1)	The IBM Spectrum Protect server detected a system error and notified the clients.
DSM_RC_REJECT_VERIFIER_EXPIRED (52)	Password expired and must be updated. The next call must be <code>dsmChangePW</code> with the handle returned on this call.
DSM_RC_REJECT_ID_UNKNOWN (53)	Cannot not find the node name.
DSM_RC_TA_COMM_DOWN (103)	The communications link is down.
DSM_RC_AUTH_FAILURE (137)	There was an authentication failure.
DSM_RC_NO_STARTING_DELIMITER (148)	There is no starting delimiter in pattern.
DSM_RC_NEEDED_DIR_DELIMITER (149)	A directory delimiter is needed immediately before and after the "match directories" meta-string ("..."), but was not found.
DSM_RC_NO_PASS_FILE (168)	The password file is not available.
DSM_RC_UNMATCHED_QUOTE (177)	An unmatched quotation mark is in the option string.
DSM_RC_NLS_CANT_OPEN_TXT (0610)	Unable to open the message text file.
DSM_RC_INVALID_OPT (2013)	An entry in the option string is invalid.
DSM_RC_INVALID_DS_HANDLE (2014)	Invalid DSM handle.
DSM_RC_NO_OWNER_REQD (2032)	Owner parameter must be NULL when <code>passwordaccess</code> is set to <code>generate</code> .
DSM_RC_NO_NODE_REQD (2033)	Node parameter must be NULL when <code>passwordaccess</code> is set to <code>generate</code> .
DSM_RC_WRONG_VERSION (2064)	Application client's API version has a higher value than the IBM Spectrum Protect version.
DSM_RC_PASSWD_TOOLONG (2103)	The specified password is too long.
DSM_RC_NO_OPT_FILE (2220)	No configuration file is found.
DSM_RC_INVALID_KEYWORD (2221)	A keyword that is specified in an options string is invalid.
DSM_RC_PATTERN_TOO_COMPLEX (2222)	Include-exclude pattern too complex to be interpreted by IBM Spectrum Protect.
DSM_RC_NO_CLOSING_BRACKET (2223)	There is no closing bracket in the pattern.

Return code	Explanation
DSM_RC_INVALID_SERVER (2225)	For a multi-user environment, the server in the system configuration file was not found.
DSM_RC_NO_HOST_ADDR (2226)	Not enough information to connect to the host.
DSM_RC_MACHINE_SAME (2227)	The node name that is defined in the options file cannot be the same as the system host name.
DSM_RC_NO_API_CONFIGFILE (2228)	Cannot open the configuration file.
DSM_RC_NO_INCLEXCL_FILE (2229)	The include-exclude file was not found.
DSM_RC_NO_SYS_OR_INCLEXCL (2230)	Either the dsm.sys or the include-exclude file was not found.

**Related concepts:**

Client options file overview  
Processing options

## dsmLogEvent

The **dsmLogEvent** function call logs a user message (ANE4991 I) to the server log file, to the local error log, or to both. A structure of type **logInfo** is passed in the call. This call must be performed while at **InSession** state inside a session. Do not perform it within a send, get, or query. To retrieve messages logged on the server, use the **query actlog** command through the administrative client.

See the summary state diagram, Figure 1.

### Syntax

```
dsInt16_t dsmLogEvent
(dsUInt32_t dsmHandle,
logInfo *logInfoP);
```

### Parameters

dsUInt32\_t dsmHandle(I)

The handle that associates this call with a previous **dsmInitEx** call.

logInfo \*logInfoP (I)

Passes the message and destination. The application client is responsible for allocating storage for the structure.

The fields in the **logInfo** structure are:

message

The text of the message to be logged. This must be a null-ended string. The maximum length is DSM\_MAX\_RC\_MSG\_LENGTH.

dsmLogtype

Specifies where to log the message. Possible values include: **logServer**, **logLocal**, **logBoth**.

### Return codes

The return code numbers are provided in parentheses ().

Table 1. Return codes for dsmLogEvent

Return code	Explanation
DSM_RC_STRING_TOO_LONG (2120)	The message string is too long.

## dsmLogEventEx

The **dsmLogEventEx** function call logs a user message to the server log file, to the local error log, or to both. This call must be made while at an **InSession** state within a session. The call cannot be made within a send, get, or query call.

Summary state diagram: For an overview of the session interactions, see the summary state diagram in the following topic:

Figure 1

The severity determines the IBM Spectrum Protect™ message number. To view messages that are logged on the server, use the query actlog command through the administrative client. Use the IBM Spectrum Protect client option, errorlogretention, to prune the client error log file if the application generates numerous client messages written to the client log, dsmLogType either logLocal or logBoth. For more information, see the IBM Spectrum Protect server documentation.

## Syntax

```
extern dsInt16_t DSMLINKAGE dsmLogEventEx(  
    dsUInt32_t dsmHandle,  
    dsmLogExIn_t *dsmLogExInP,  
    dsmLogExOut_t *dsmLogExOutP  
);
```

## Parameters

dsUInt32\_t dsmHandle(I)

The handle that associates this call with a previous dsmInitEx call.

dsmLogExIn\_t \*dsmLogExInP

This structure contains the input parameters.

dsmLogSeverity severity;

This parameter is the event severity. The possible values are:

```
    logSevInfo,          /* information ANE4990 */  
    logSevWarning,      /* warning ANE4991 */  
    logSevError,        /* Error ANE4992 */  
    logSevSevere        /* severe ANE4993 */
```

char appMsgID[8];

This parameter is a string to identify the specific application message. A suitable format is three characters that are followed by four numbers, for example: DSM0250.

dsmLogType logType;

This parameter specifies where to direct the event. The parameter has the following possible values:

- logServer
- logLocal
- logBoth

char \*message;

This parameter is the text of the event message to log. The text must be a null-ended string. The maximum length is DSM\_MAX\_RC\_MSG\_LENGTH.

Restriction: Messages that go to the server must be in English. Non-English messages do not display correctly.

dsmLogExOut\_t \*dsmLogExOutP

This structure contains the output parameters. Currently, there are no output parameters.

## Return codes

The return code numbers are provided in parentheses ().

Table 1. Return codes for dsmLogEventEx

Return code	Explanation
DSM_RC_STRING_TOO_LONG (2120)	The message string is too long.

## dsmQueryAccess

The **dsmQueryAccess** function call queries the server for all access authorization rules for either backup versions or archived copies of your objects. A pointer to an array of access rules is passed in to the call, and the completed array is returned. A pointer to the number of rules is passed in to indicate how many rules are in the array.

There are no return codes that are specific to this call.

## Syntax

---

```
dsInt16_t DSMLINKAGE dsmQueryAccess
                    (dsUInt32_t      dsmHandle),
                    qryRespAccessData **accessListP,
                    dsUInt16_t      *numberOfRules) ;
```

## Parameters

---

dsUInt32\_t dsmHandle (I)

The handle that associates this call with a previous **dsmInitEx** call.

qryRespAccessData \*\*accessListP (O)

A pointer to an array of `qryRespAccessData` elements that the API library allocates. Each element corresponds to an access rule. The number of elements in the array is returned in the **numberOfRules** parameter. The information that is returned in each `qryRespAccessData` element includes the following:

	Name	Description
	<b>ruleNumber</b>	The ID for the access rule. This identifies the rule for deletion.
	<b>AccessType</b>	The backup or archive type.
	<b>Node</b>	The node on which you gave access.
	<b>Owner</b>	The user to whom you gave access.
	<b>objName</b>	The high-level, or low-level file space descriptors.

dsUInt32\_t \*numberOfRules (O)

Returns the number of rules in the `accessList` array.

## dsmQueryApiVersion

---

The **dsmQueryApiVersion** function call performs a query request for the API library version that the application client accesses.

All updates to the API are made in an upward-compatible format. Any application client with an API version or release less than, or equal to, the API library on the end user's workstation operates without change. Be aware before you proceed that should the **dsmQueryApiVersion** call return a version or version release older than that of the application clients, some API calls might be enhanced in a manner that is not supported by the end user's older version of the API.

The application API version number is stored in the `dsmapi.h` header file as constants `DSM_API_VERSION`, `DSM_API_RELEASE`, and `DSM_API_LEVEL`.

There are no return codes that are specific to this call.

## Syntax

---

```
void dsmQueryApiVersion (dsmApiVersion *apiVersionP);
```

## Parameters

---

dsmApiVersion \*apiVersionP (O)

This parameter is a pointer to the structure that contains the API library version, release, and level components. For example, if the library is version 1.1.0, then, after returning from the call, the fields of the structure contain the following values:

```
dsmApiVersionP->version = 1
dsmApiVersionP->release = 1
dsmApiVersionP->level   = 0
```

## dsmQueryApiVersionEx

---

The **dsmQueryApiVersionEx** function call performs a query request for the API library version that the application client accesses.

All updates to the API are made in an upward-compatible format. Any application client that has an API version or release less than or equal to the API library on the end user's workstation operates without change. See Summary of Code Changes in the README\_api\_enu file for exceptions to upward compatibility. If the **dsmQueryApiVersionEx** call returns a version or version release that is different from that of the application client, be aware before you proceed that some API calls might be enhanced in a manner that is not supported by the end user's older version of the API.

The application API version number is stored in the dsmapi.h header file as constants DSM\_API\_VERSION, DSM\_API\_RELEASE, DSM\_API\_LEVEL, and DSM\_API\_SUBLEVEL.

There are no return codes that are specific to this call.

## Syntax

```
void dsmQueryApiVersionEx (dsmApiVersionEx *apiVersionP);
```

## Parameters

dsmApiVersionEx \*apiVersionP (O)

This parameter is a pointer to the structure that contains the API library's version, release, level, and sublevel components. For example, if the library is Version 5.5.0.0, then, after returning from the call, the fields of the structure contain the following values:

- ApiVersionP->version = 5
- ApiVersionP->release = 5
- ApiVersionP->level = 0
- ApiVersionP->subLevel = 0

## dsmQueryCliOptions

The **dsmQueryCliOptions** function call queries important option values in the user's option files. A structure of type **optStruct** is passed in the call and contains the information. This call is performed before **dsmInitEx** is called, and it determines the setup before the session.

There are no return codes that are specific to this call.

## Syntax

```
dsInt16_t dsmQueryCliOptions  
(optStruct *optstructP);
```

## Parameters

optStruct \*optstructP (I/O)

This parameter passes the address of the structure that the API completes. The application client is responsible for allocating storage for the structure. On successful return, the appropriate information is entered in the fields in the structure.

The following information is returned in the **optStruct** structure:

	Name	Description
	<b>dsmiDir</b>	The value of the environment DSMI_DIR variable.
	<b>dsmiConfig</b>	The client option file as specified by the DSMI_CONFIG environment variable.
	<b>serverName</b>	The name of the IBM Spectrum Protect™ server.
	<b>commMethod</b>	The communication method selected. See the #defines for DSM_COMM_* in the dsmapi.h file.
	<b>serverAddress</b>	The address of the server that is based on the communication method.
	<b>nodeName</b>	The client node (machine) name.
	<b>compression</b>	This field provides information regarding the compression option.
	<b>passwordAccess</b>	The values are: <i>bTrue</i> for generate, and <i>bFalse</i> for prompt.

**Related concepts:**  
Processing options

## dsmQuerySessInfo

The **dsmQuerySessInfo** function call starts a query request to IBM Spectrum Protect™ for information related to the operation of the specified session in **dsmHandle**. A structure of type **ApiSessInfo** is passed in the call, with all available session related information entered. This call is started after a successful **dsmInitEx** call.

The information that is returned in the **ApiSessInfo** structure includes the following:

- Server information: port number, date and time, and type
- Client defaults: application type, delete permissions, delimiters, and transaction limits
- Session information: login ID, and owner
- Policy data: domain, active policy set, and retention grace period

See API type definitions source files for information about the content of the structure that is passed and each field within it.

## Syntax

```
dsInt16_t dsmQuerySessInfo (dsUInt32_t      dsmHandle,  
                           ApiSessInfo *SessInfoP);
```

## Parameters

dsUInt32\_t dsmHandle (I)

The handle that associates this call with a previous **dsmInitEx** call.

ApiSessInfo \*SessInfoP (I/O)

This parameter passes the address of the structure that the API enters. The application client is responsible for allocating storage for the structure and for completing the field entries that indicate the version of the structure that is used. On successful return, the fields in the structure are completed with the appropriate information. The **adsmServerName** is the name that is given in the **define server** command on the IBM Spectrum Protect server. If the **archiveRetentionProtection** field is true, the server is enabled for retention protection.

## Return codes

The return code numbers are provided in parentheses ().

Table 1. Return codes for dsmQuerySessInfo

Return code	Explanation
DSM_RC_NO_SESS_BLK (2006)	No server session block information.
DSM_RC_NO_POLICY_BLK (2007)	No server policy information available.
DSM_RC_WRONG_VERSION_PARM (2065)	Application client's API version is different from the IBM Spectrum Protect library version.

## dsmQuerySessOptions

The **dsmQuerySessOptions** function call queries important option values that are valid in the specified session in **dsmHandle**. A structure of type **optStruct** is passed in the call and contains the information.

This call is started after a successful **dsmInitEx** call. The values that are returned might be different from the values returned on a **dsmQueryCliOptions** call, depending on values that are passed to the **dsmInitEx** call, primarily **optString**, and **optFile**. For information about option precedence, see [Understanding configuration and options files](#).

There are no return codes that are specific to this call.

## Syntax

```
dsInt16_t dsmQuerySessOptions  
(dsUInt32_t      dsmHandle,
```

```
optStruct *optstructP);
```

## Parameters

---

`dsUInt32_t dsmhandle(I)`

The handle that associates this call with a previous `dsmInitEx` call.

`optStruct *optstructP (I/O)`

This parameter passes the address of the structure that the API completes. The application client is responsible for allocating storage for the structure. On successful return, the fields in the structure are completed with the appropriate information.

The information returned in the `optStruct` structure is:

Name	Description
<code>dsmiDir</code>	The value of the <code>DSMI_DIR</code> environment variable.
<code>dsmiConfig</code>	The <code>dsm.opt</code> file that the <code>DSMI_CONFIG</code> environment variable specifies.
<code>serverName</code>	The name of the IBM Spectrum Protect™ server stanza in the options file.
<code>commMethod</code>	The communication method that was selected. See the #defines for <code>DSM_COMM_*</code> in the <code>dsmapi.h</code> file.
<code>serverAddress</code>	The address of the server that is based on the communication method.
<code>nodeName</code>	The name of the client's node (machine).
<code>compression</code>	The value of the compression option ( <code>bTrue=on</code> and <code>bFalse=off</code> ).
<code>compressAlways</code>	The value of the <code>compressalways</code> option ( <code>bTrue=on</code> and <code>bFalse=off</code> ).
<code>passwordAccess</code>	Value <code>bTrue</code> for generate, and <code>bFalse</code> for prompt.

### Related concepts:

Processing options

## dsmRCMsg

---

The `dsmRCMsg` function call obtains the message text that is associated with an API return code.

The `msg` parameter displays the message prefix return code in parentheses ( ), followed by the message text. For example, a call to `dsmRCMsg` might return the following:

```
ANS0264E (RC2300) Only root user can execute dsmChangePW or dsmDeleteFS.
```

For some languages where characters are different in ANSI and OEM code pages, it might be necessary to convert strings from ANSI to OEM before printing them out (for example, Eastern European single-byte character sets). The following is an example:

```
dsmRCMsg(dsmHandle, rc, msgBuf);  
#ifdef WIN32  
#ifndef WIN64  
CharToOemBuf(msgBuf, msgBuf, strlen(msgBuf));  
#endif  
#endif  
printf("
```

## Syntax

---

```
dsInt16_t dsmRCMsg (dsUInt32_t dsmHandle,  
dsInt16_t dsmRC,  
char *msg);
```

## Parameters

---

`dsUInt32_t dsmHandle (I)`

The handle that associates this call with a previous `dsmInitEx` call.

`dsInt16_t dsmRC (I)`

The API return code of the associated message text. The API return codes are listed in the `dsmrc.h` file. See API return codes source file: `dsmrc.h` for more information.



char \*msg (O)

This parameter is the message text that is associated with the return code, dsmRC. The caller is responsible for allocating enough space for the message text.

The maximum length for **msg** is defined as DSM\_MAX\_RC\_MSG\_LENGTH.

On platforms that have National Language Support and a choice of language message files, the API returns a message string in the national language.

## Return codes

The return code numbers are provided in parentheses ().

Table 1. Return codes for dsmRCMsg

Return code	Explanation
DSM_RC_NULL_MSG (2002)	The <b>msg</b> parameter for dsmRCMsg call is a NULL pointer.
DSM_RC_INVALID_RETCODE (2021)	Return code that was passed to <b>dsmRCMsg</b> call is an invalid code.
DSM_RC-NLS_CANT_OPEN_TXT (0610)	Unable to open the message text file.

## dsmRegisterFS

The **dsmRegisterFS** function call registers a new file space with the IBM Spectrum Protect™ server. Register a file space first before you can back up any data to it.

Application clients should not use the same file space names that a backup-archive client would use.

- On UNIX or Linux, run the **df** command for these names.
- On Windows, these names are generally the volume labels that are associated with the different drives on your system.

## Syntax

```
dsInt16_t dsmRegisterFS (dsUInt32_t dsmHandle,  
regFSData *regFilespaceP);
```

## Parameters

dsUInt32\_t dsmHandle (I)

The handle that associates this call with a previous **dsmInitEx** call.

regFSData \*regFilespaceP (I)

This parameter passes the name of the file space and associated information that you need to register with the IBM Spectrum Protect server.

Tip: The *fstype* field includes the prefix, "**API:**". All file space queries display this string. For example, if the user passes *myfstype* for *fstype* in **dsmRegisterFS**, the actual value string on the server is returned as `API:myfstype` when queried. This prefix distinguishes API objects from backup-archive objects.

The usable area for **fsInfo** is now DSM\_MAX\_USER\_FSINFO\_LENGTH.

## Return codes

The return code numbers are provided in parentheses ().

Table 1. Return codes for dsmRegisterFS

Return code	Explanation
DSM_RC_INVALID_FSNAME (2016)	Invalid file space name.
DSM_RC_INVALID_DRIVE_CHAR (2026)	Drive letter is not an alphabetic character.
DSM_RC_NULL_FSNAME (2027)	Null file space name.
DSM_RC_FS_ALREADY_REGED (2062)	File space is already registered.

Return code	Explanation
DSM_RC_WRONG_VERSION_PARM (2065)	Application client's API version is different from the IBM Spectrum Protect library version.
DSM_RC_FSINFO_TOOLONG (2106)	File space information is too long.

## dsmReleaseBuffer

The **dsmReleaseBuffer** function returns a buffer to IBM Spectrum Protect™. The application calls **dsmReleaseBuffer** after a **dsmGetDataEx** was called and the application has moved all the data out of the buffer and is ready to release it. **dsmReleaseBuffer** requires that **dsmInitEx** was called with the *UseTsmBuffers* set to *btrue* and a non-zero value was provided for *numTsmBuffers*. **dsmReleaseBuffer** should also be called if the application is about to call **dsmTerminate** and it still holds data buffers.

## dsmReleaseBufferSyntax

```
dsInt16_t dsmReleaseBuffer (releaseBufferIn_t *dsmReleaseBufferInP,
                           releaseBufferOut_t *dsmReleaseBufferOutP) ;
```

## Parameters

releaseBufferIn\_t \* dsmReleaseBufferInP (I)  
 This structure contains the following input parameters.

dsUInt32\_t dsmHandle (I)  
 The handle that associates this call with a previous **dsmInitEx** call.

dsUInt8\_t tsmBufferHandle(I)  
 The handle that identifies this buffer.

char \*dataPtr(I)  
 The address to which the application is written.

## Return codes

The return code numbers are provided in parentheses ( ).

Table 1. Return codes for dsmReleaseBuffer

Return code	Explanation
DSM_RC_BAD_CALL_SEQUENCE	The call was not issued in the proper state.
DSM_RC_INVALID_TSMBUFFER	The handle or the value of <b>dataPtr</b> are invalid.
DSM_RC_BUFF_ARRAY_ERROR	A buffer array error occurred.

## dsmRenameObj

The **dsmRenameObj** function call renames the high-level or low-level object name. For backup objects, pass in the current object name and changes either for high-level or low-level object names. For archive objects, pass in the current object file space name and object ID, and changes either for high-level or low-level object names. Use this function call within **dsmBeginTxn** and **dsmEndTxn** calls.

The merge flag determines whether or not a duplicate backup object name is merged with the existing backups. If the new name corresponds to an existing object and merge is true, the current object is converted to the new name and it becomes the active version of the new name while the existing active object that had that name becomes the top most inactive copy of the object. If the new name corresponds to an existing object and merge is false, the function then returns the return code, DSM\_RC\_ABORT\_DUPLICATE\_OBJECT.

Restrictions:

- Only the owner of the object can rename it.
- The **dsmRenameObj** function is not supported if data retention protection is enabled on the IBM Spectrum Protect™ server or if you are connected to the IBM Spectrum Protect for Data Retention server.

The **dsmRenameObj** function call tests for these merge conditions:

- The current **dsmObjName** object and the new high-level or low-level object must match on owner, copy group, and management class.
- The current **dsmObjName** must have been backed up more recently than the currently active object with the new name.
- There must be only an active copy of the current **dsmObjName** with no inactive copies.

## Syntax

```
dsInt16_t dsmRenameObj (dsmRenameIn_t      *dsmRenameInP,  
                        dsmRenameOut_t     *dsmRenameOutP);
```

## Parameters

dsUInt32\_t dsmHandle (I)

The handle that associates this call with a previous **dsmInitEx** call.

dsmRenameIn\_t \*dsmRenameInP

This structure contains the input parameters.

dsUInt8\_t repository (I);

This parameter indicates whether the file space to delete is in the backup repository or the archive repository.

dsmObjName \*objNameP (I);

This parameter is a pointer to the structure that contains the current file space name, high-level object name, low-level object name, and object type.

char newHL [DSM\_MAX\_HL\_LENGTH + 1];

This parameter specifies the new high-level name.

char newLL [DSM\_MAX\_LL\_LENGTH + 1];

This parameter specifies the new low-level name.

dsBool\_t merge;

This parameter determines whether or not a backup object is merged with duplicate named objects. The values are either true or false.

ObjID;

The object ID for archive objects.

dsmRenameOut\_t \*dsmRnameOutP

This structure contains the output parameters.

Note: There are no output parameters.

## Return codes

The return code numbers are provided in parentheses ( ).

Table 1. Return codes for dsmRenameObj

Return code	Explanation
DSM_RC_ABORT_MERGE_ERROR (45)	Server detected a merge error.
DSM_RC_ABORT_DUPLICATE_OBJECT (32)	Object already exists and merge is false.
DSM_RC_ABORT_NO_MATCH (2)	Object not found.
DSM_RC_REJECT_SERVER_DOWNLEVEL (58)	The IBM Spectrum Protect server must be at V3.7.4.0 or later for this function to work.

## dsmRequestBuffer

The **dsmRequestBuffer** function returns a buffer to IBM Spectrum Protect™. The application calls **dsmRequestBuffer** after a **dsmGetDataEx** was called and the application has moved all the data out of the buffer and is ready to release it.

**dsmReleaseBuffer** requires that **dsmInitEx** was called with the *UseTsmBuffers* set to *btrue* and a non-zero value was provided for *numTsmBuffers*. **dsmReleaseBuffer** should also be called if the application is about to call **dsmTerminate** and it still holds IBM Spectrum Protect buffers.

## Syntax

```
dsInt16_t dsmRequestBuffer (getBufferIn_t *dsmRequestBufferInP,  
                           getBufferOut_t *dsmRequestBufferOutP) ;
```

## Parameters

getBufferIn\_t \*dsmRequestBufferInP (I)

This structure contains the following input parameter:

dsUInt32\_t dsmHandle

The handle that identifies the session and associates it with a previous **dsmInitEx** call.

getBufferOut\_t \*dsmRequestBufferOutP (O)

This structure contains the output parameters.

dsUInt8\_t tsmBufferHandle(0)

The handle that identifies this buffer.

char \*dataPtr(0)

The address to which application is written.

dsUInt32\_t \*bufferLen(0)

Maximum number of bytes that can be written to this buffer.

## Return codes

The return code numbers are provided in parentheses ().

Table 1. Return codes for dsmRequestBuffer

Return code	Explanation
DSM_RC_BAD_CALL_SEQUENCE (33)	The call was not issued in the proper state.
DSM_RC_SENDDATA_WITH_ZERO_SIZE (34)	If the object being sent is 0 length, no calls to <b>dsmReleaseBuffer</b> are allowed.
DSM_RC_BUFF_ARRAY_ERROR (121)	A valid buffer could not be obtained.

## dsmRetentionEvent

The **dsmRetentionEvent** function call sends a list of object IDs to the IBM Spectrum Protect™ server, with a retention event operation to be performed on these objects. Use this function call within **dsmBeginTxn** and **dsmEndTxn** calls.

Note: The server must be at version 5.2.2.0 or later for this function to work.

The maximum number of objects in a call is limited to the value of *maxObjPerTxn* that is returned in the *ApisessInfo* structure from a **dsmQuerySessInfo** call.

Only an owner of an object can send an event on that object.

The following events are possible:

eventRetentionActivate

Can be issued only for objects that are bound to an event based management class. Sending this event activates the event for this object and the state of the retention for this object changes from DSM\_ARCH\_RETINIT\_PENDING to DSM\_ARCH\_RETINIT\_STARTED.

eventHoldObj

This event issues a retention or deletion hold on the object so that, until a release is issued, the object is not expired and cannot be deleted.

eventReleaseObj

This event can only be issued for an object that has a value of DSM\_ARCH\_HELD\_TRUE in the *objectHeld* field and removes the hold on the object resuming the original retention policy.

Before you send *dsmRetentionEvent*, send the query sequence that is described in Querying the IBM Spectrum Protect system to obtain the information for the object. The call to **dsmGetNextQObj** returns a data structure named **qryRespArchiveData** for

archive queries. This data structure contains the information that is needed for **dsmRetentionEvent**.

## Syntax

```
extern dsInt16_t DSMLINKAGE dsmRetentionEvent(  
    dsmRetentionEventIn_t      *ddsRetentionEventInP,  
    dsmRetentionEventOut_t     *dsmRetentionEventOutP  
);
```

## Parameters

dsmRetentionEventIn\_t \*dsmRetentionEventP

This structure contains the following input parameters:

dsUInt16\_t stVersion;

This parameter indicates the structure version.

dsUInt32\_t dsmHandle (I)

The handle that associates this call with a previous dsmInitEx call.

dsmEventType\_t eventType (I);

This parameter indicates the event type. See the beginning of this section for the meaning of these possible values:

**eventRetentionActivate, eventHoldObj, eventReleaseObj**

dsmObjList\_t objList;

This parameter indicates a list of object IDs to signal.

## Return codes

The return code numbers are provided in parentheses ().

Table 1. Return codes for dsmRetentionEvent

Return code	Explanation
DSM_RC_ABORT_NODE_NOT_AUTHORIZED (36)	The node or user does not have proper authority.
DSM_RC_ABORT_TXN_LIMIT_EXCEEDED (249)	Too many objects in the transaction.
DSM_RC_ABORT_OBJECT_ALREADY_HELD (250)	Object is already held, cannot issue another hold.
DSM_RC_REJECT_SERVER_DOWNLEVEL (58)	The server must be at V5.2.2.0 or later for this function to work.

## dsmSendBufferData

The **dsmSendBufferData** function call sends a byte stream of data to IBM Spectrum Protect™ through a buffer that was provided in a previous **dsmReleaseBuffer** call. The application client can pass any type of data for storage on the server. Usually this data are file data, but it is not limited to file data. You can call **dsmSendBufferData** several times, if the byte stream of data that you are sending is large. Regardless of whether the call succeeds or fails, the buffer is released.

Restriction: When you use the *useTsmBuffers* option, even if an object is included for compression, the object is not compressed.

## Syntax

```
dsInt16_t dsmSendBufferData (sendBufferDataIn_t      *dsmSendBufferDataExInP,  
                             sendBufferDataOut_t     *dsmSendBufferDataOutP) ;
```

## Parameters

sendBufferDataIn\_t \*dsmSendBufferDataInP (I)

This structure contains the following input parameters.

dsUInt32\_t dsmHandle (I)

The handle that associates this call with a previous **dsmInitEx** call.

dsUInt8\_t tsmBufferHandle(I)

The handle that identifies the buffer to send.

char \*dataPtr(I)

The address to which application data was written.

dsUInt32\_t numBytes(I)

The actual number of bytes written by the application (should always be less than the value provided in **dsmReleaseBuffer**).

## Return codes

The return code numbers are provided in parentheses ( ).

Table 1. Return codes for dsmSendBufferData

Return code	Explanation
DSM_RC_BAD_CALL_SEQUENCE (2041)	The call was not issued in the proper state.
DSM_RC_INVALID_TSMBUFFER (2042)	The handle or the value of <b>dataPtr</b> are invalid.
DSM_RC_BUFF_ARRAY_ERROR (2045)	A buffer array error occurred.
DSM_RC_TOO_MANY_BYTES (2043)	The value of <i>numBytes</i> is bigger than the size of the buffer provided in the <b>dsmReleaseBuffer</b> call.

## dsmSendData

The **dsmSendData** function call sends a byte stream of data to IBM Spectrum Protect™ through a buffer. The application client can pass any type of data for storage on the server. Usually, these data are file data, but are not limited to such. You can call **dsmSendData** several times, if the byte stream of data that you want to send is large.

Restriction: The application client cannot reuse the buffer that is specified in **dsmSendData** until the **dsmSendData** call returns.  
Tip: If IBM Spectrum Protect returns code 157 (DSM\_RC\_WILL\_ABORT), start a call to **dsmEndSendObj** and then to **dsmEndTxn** with a vote of DSM\_VOTE\_COMMIT. The application then receives return code 2302 (DSM\_RC\_CHECK\_REASON\_CODE) and passes the reason code back to the application user. This informs the user why the server is ending the transaction.

## Syntax

```
dsInt16_t dsmSendData (dsUInt32_t dsmHandle,  
DataBlk *dataBlkPtr);
```

## Parameters

dsUInt32\_t dsmHandle (I)

The handle that associates this call with a previous **dsmInitEx** call.

DataBlk \*dataBlkPtr (I/O)

This parameter points to a structure that includes both a pointer to the buffer from which the data are to be sent, as well as the size of the buffer. On return, this structure contains the number of bytes that is actually transferred. See API type definitions source files for the type definition.

## Return codes

The return code numbers are provided in parentheses ( ).

Table 1. Return codes for dsmSendData

Return code	Explanation
DSM_RC_NO_COMPRESS_MEMORY (154)	Insufficient memory available to perform data compression or expansion.
DSM_RC_COMPRESS_GREW (155)	During compression the compressed data grew in size compared to the original data.
DSM_RC_WILL_ABORT (157)	An unknown and unexpected error occurred, causing the transaction to halt.
DSM_RC_WRONG_VERSION_PARM (2065)	Application client's API version is different than the IBM Spectrum Protect library version.
DSM_RC_NEEDTO_ENDTXN (2070)	Need to end the transaction.

Return code	Explanation
DSM_RC_OBJ_EXCLUDED (2080)	The include-exclude list excludes the object.
DSM_RC_OBJ_NOBCG (2081)	The object has no backup copy group and will not be sent to the server.
DSM_RC_OBJ_NOACG (2082)	The object has no archive copy group and is not sent to the server.
DSM_RC_SENDDATA_WITH_ZERO_SIZE (2107)	The object cannot send data with a zero byte <i>sizeEstimate</i> .

## dsmSendObj

The **dsmSendObj** function call starts a request to send a single object to storage. Multiple **dsmSendObj** calls and associated **dsmSendData** calls can be made within the bounds of a transaction for performance reasons.

The **dsmSendObj** call processes the data for the object as a byte stream passed in memory buffers. The **dataBlkPtr** parameter in the **dsmSendObj** call permits the application client to either:

- Pass the data and the attributes (the attributes are passed through the **objAttrPtr**) of the object in a single call.
- Specify part of the object data through the **dsmSendObj** call and the remainder of the data through one or more **dsmSendData** calls.

Alternatively, the application client can specify only the attributes through the **dsmSendObj** call and specify the object data through one or more calls to **dsmSendData**. For this method, set **dataBlkPtr** to NULL on the **dsmSendObj** call.

Tip: For certain object types, byte stream data might not be associated with the data; for example, a directory entry with no extended attributes.

Before **dsmSendObj** is called, a preceding **dsmBindMC** call must be made to properly bind a management class to the object that you want to back up or archive. The API keeps this binding so that it can associate the proper management class with the object when it is sent to the server. If you permit the management class that is bound on a **dsmSendObj** call to default for an object type of directory (DSM\_OBJ\_DIRECTORY), the default might not be the default management class. Instead, the management class with the greatest retention time is used. If more than one management class exists with this retention time, the first one that is encountered is used.

Follow all object data that is sent to storage with a **dsmEndSendObj** call. If you do not have object data to send to the server, or all data was contained within the **dsmSendObj** call, start a **dsmEndSendObj** call before you can start another **dsmSendObj** call. If multiple data sends were required through the **dsmSendData** call, the **dsmEndSendObj** follows the last send to indicate the state change.

Tip: If IBM Spectrum Protect™ returns code 157 (DSM\_RC\_WILL\_ABORT), start a call to **dsmEndTxn** with a vote of DSM\_VOTE\_COMMIT. The application receives return code 2302 (DSM\_RC\_CHECK\_REASON\_CODE) and passes the reason code back to the application user. This informs the user why the server is ending the transaction.

If the reason code is 11 (DSM\_RS\_ABORT\_NO\_REPOSIT\_SPACE), it is possible that the *sizeEstimate* is too small for the actual amount of data. The application needs to determine a more accurate *sizeEstimate* and send the data again.

## Syntax

```
dsInt16_t dsmSendObj (dsUInt32_t      dsmHandle,
                    dsmSendType sendType,
                    void          *sendBuff,
                    dsmObjName   *objNameP,
                    ObjAttr      *objAttrPtr,
                    DataBlk      *dataBlkPtr);
```

## Parameters

dsUInt32\_t dsmHandle (I)

The handle that associates this call with a previous **dsmInitEx** call.

dsmSendType sendType (I)

This parameter specifies the type of send that is being performed. Possible values include:

Name	Description
<b>stBackup</b>	A backup object that is sent to the server.

	Name	Description
	<b>stArchive</b>	An archive object that is sent to the server.
	<b>stBackupMountWait</b>	A backup object for which you want the server to wait until the necessary device, such as a tape, is mounted.
	<b>stArchiveMountWait</b>	An archive object for which you want the server to wait until the necessary device, such as a tape, is mounted.

Note: Use the **MountWait** types if there is any possibility that your application user might send data to a tape.

void \*sendBuff (I)

This parameter is a pointer to a structure that contains other information specific to the **sendType** on the call. Currently, only a **sendType** of **stArchive** has an associated structure. This structure is called **sndArchiveData** and it contains the archive description.

dsmObjName \*objNameP (I)

This parameter is a pointer to the structure that contains the file space name, high-level object name, low-level object name, and object type. See Object names and IDs for more information.

ObjAttr \*objAttrPtr (I)

This parameter passes object attributes of interest to the application. See API type definitions source files for the type definition.

The attributes are:

- **owner** refers to the owner of the object. Determining whether the owner is declared to be a specific name or an empty string is important when getting the object back from IBM Spectrum Protect storage. See Accessing objects as session owner for more information.
- **sizeEstimate** is a best estimate of the total size of the data object to send to the server. Be as accurate as possible on this size, because the server uses this attribute for efficient space allocation and object placement within its storage resources.

If the size estimate that you specified is significantly smaller than the actual number of bytes that are sent, the server might have difficulty allocating enough space and end the transaction with a reason code of 11 (DSM\_RS\_ABORT\_NO\_REPOSIT\_SPACE).

Note: The size estimate is for the total size of the data object in bytes.

Objects with a size smaller than DSM\_MIN\_COMPRESS\_SIZE do not compress.

If your object has no bit data (only the attribute information from this call), the **sizeEstimate** should be zero.

Note: Starting with Version 5.1.0, the copy destination within a transaction is not checked for consistency on zero-length objects.

- **objCompressed** is a Boolean value that states whether or not the object data have already been compressed.

If the object is compressed (object *compressed=bTrue*), IBM Spectrum Protect does not try to compress it again. If it is not compressed, IBM Spectrum Protect decides whether to compress the object, based on the values of the compression option set by the administrator and set in the API configuration sources.

If your application plans to use partial object restore or retrieve, you cannot compress the data while sending it. To enforce this, set *ObjAttr.objCompressed* to *bTrue*.

- **objInfo** saves information about the particular object.  
Restriction: Information is not stored here automatically. When this attribute is used, you must set the attribute, *objInfoLength*, to show the length of *objInfo*.
- **mcNameP** contains the name of a management class that overrides the management class that is obtained from **dsmBindMC**.
- **disableDeduplication** is a Boolean value. When it is set to true, this object is not deduplicated by the client.

DataBlk \*dataBlkPtr (I/O)

This parameter points to a structure that includes both a pointer to the buffer of data that is to be backed up or archived and the size of that buffer. This parameter applies to **dsmSendObj** only. If you want to begin sending data on a subsequent **dsmSendData** call, rather than on the **dsmSendObj** call, set the buffer pointer in the DataBlk structure to NULL. On return, this structure contains the number of bytes that is actually transferred. See API type definitions source files for the type definition.

## Return codes

The return code numbers are provided in parentheses ( ).



Table 1. Return codes for dsmSendObj

Return code	Explanation
DSM_RC_NO_COMPRESS_MEMORY (154)	Insufficient memory available to perform data compression or expansion.
DSM_RC_COMPRESS_GREW (155)	During compression, the compressed data grew in size compared to the original data.
DSM_RC_WILL_ABORT (157)	An unknown and unexpected error occurred, causing the transaction to be halted.
DSM_RC_TL_NOACG (186)	The management class for this file does not have a valid copy group for the send type.
DSM_RC_NULL_OBJNAME (2000)	Null object name.
DSM_RC_NULL_OBJATTRPTR (2004)	Null object attribute pointer.
DSM_RC_INVALID_OBJTYPE (2010)	Invalid object type.
DSM_RC_INVALID_OBJOWNER (2019)	Invalid object owner.
DSM_RC_INVALID_SENDDTYPE (2022)	Invalid send type.
DSM_RC_WILDCHAR_NOTALLOWED (2050)	Wildcard characters not allowed.
DSM_RC_FS_NOT_REGISTERED (2061)	File space not registered.
DSM_RC_WRONG_VERSION_PARM (2065)	Application client's API version is different from the IBM Spectrum Protect library version.
DSM_RC_NEEDTO_ENDTXN (2070)	Need to end transaction.
DSM_RC_OBJ_EXCLUDED (2080)	The include-exclude list excluded the object.
DSM_RC_OBJ_NOBCG (2081)	The object has no backup copy group, and it is not sent to the server.
DSM_RC_OBJ_NOACG (2082)	The object has no archive copy group, and it is not sent to the server.
DSM_RC_DESC_TOOLONG (2100)	Description is too long.
DSM_RC_OBJINFO_TOOLONG (2101)	Object information is too long.
DSM_RC_HL_TOOLONG (2102)	High-level qualifier is too long.
DSM_RC_FILESPACE_TOOLONG (2104)	File space name is too long.
DSM_RC_LL_TOOLONG (2105)	Low-level qualifier is too long.
DSM_RC_NEEDTO_CALL_BINDMC (2301)	<b>dsmBindMC</b> must be called first.

## dsmSetAccess

The **dsmSetAccess** function call gives other users or nodes access to backup versions or archived copies of your objects, access to all your objects, or access to a selective set. When you give access to another user, that user can query, restore, or retrieve your files. This command supports wildcards for the following fields: *fs*, *hl*, *ll*, *node*, *owner*.

Note: You cannot give access to both backup versions and archive copies by using a single command. You must specify either backup or archive.

### Syntax

```
dsInt16_t DSMLINKAGE dsmSetAccess
    (dsUInt32_t          dsmHandle,
     dsmSetAccessType   accessType,
     dsmObjName         *objNameP,
     char               *node,
     char               *owner);
```

### Parameters

**dsUInt32\_t dsmHandle (I)**  
The handle that associates this call with a previous **dsmInitEx** call.

dsmAccessType accessType (I)

This parameter specifies the type of objects for which you want to give access. Possible values include:

Name	Description
<i>atBackup</i>	Specifies that access is being set to backup objects.
<i>atArchive</i>	Specifies that the access is being set for archive objects.

dsmObjName \*objNameP (I)

This parameter is a pointer to the structure that contains the file space name, the high-level object name, and the low-level object name.

Note: To specify all file spaces, use an asterisk (\*) for the file space name.

char \*node (I)

This parameter is a pointer to the node name for which access is given. For any node, specify an asterisk (\*).

char \*owner (I)

This parameter is a pointer to the user name on the node to which you gave access. For all users, specify an asterisk (\*).

## Return codes

The return code numbers are provided in parentheses ( ).

Table 1. Return codes for dsmSetAccess

Return code	Explanation
DSM_RC_INVALID_ACCESS_TYPE (2110)	Invalid access type specified.
DSM_RC_FILE_SPACE_NOT_FOUND (124)	Specified file space was not found on the server.
DSM_RC_QUERY_COMM_FAILURE (2111)	Communication error during server query.
DSM_RC_NO_FILES_BACKUP (2112)	No files were backed up for this file space.
DSM_RC_NO_FILES_ARCHIVE (2113)	No files were archived for this file space.
DSM_RC_INVALID_SETACCESS (2114)	Invalid formulation of set access.

## dsmSetUp

The **dsmSetUp** function call overwrites environment variable values. Call **dsmSetUp** before **dsmInitEx**. The values that were passed in the **envSetUp** structure overwrite any existing environment variables or defaults. If you specify NULL for a field, values are taken from the environment. If you do not set a value, the values are taken from the defaults.

Requirements:

1. If you use **dsmSetUp**, always call **dsmTerminate** before **dsmCleanUp**.
2. API instrumentation can only be activated if the testflag INSTRUMENT: API is set in the configuration file and the **dsmSetUp** or **dsmCleanUp** calls are used in the application.

## Syntax

```
dsInt16_t DSMLINKAGE dsmSetUp
(dsBool_t mtFlag,
 envSetUp *envSetUpP);
```

## Parameters

dsBool\_t mtFlag (I)

This parameter specifies if the API will be used in a single thread, or a multithread mode. Values include:

```
DSM_SINGLETHREAD
DSM_MULTITHREAD
```

Requirement: The multithread flag must be on for LAN-free data transfer to occur.

envSetUp \*envSetUpP(I)

This parameter is a pointer to the structure that holds the overwrite values. Specify NULL if you do not want to override existing environment variables. The fields in the **envSetUp** structure include:

	Name	Description
	<b>dsmiDir</b>	A fully-qualified directory path that contains a message file on UNIX or Linux. It also specifies the dsm.sys directories.
	<b>dsmiConfig</b>	The fully-qualified name of the client options file.
	<b>dsmiLog</b>	The fully-qualified path of the error log directory.
	<b>argv</b>	Pass the argv[0] name of the calling program if the application must run with authorized user authority. See Controlling access to password files for more information.
	<b>logName</b>	The file name for an error log if the application does not use dsiererror.log.
	<b>inclExclCaseSensitive</b>	Indicates whether include/exclude rules are case-sensitive or case-insensitive. This parameter can be used on Windows only, it is ignored elsewhere.

## Return codes

The return code numbers are provided in parentheses ().

Table 1. Return codes for dsmSetUp

Return code	Explanation
DSM_RC_ACCESS_DENIED (106)	Access to the specified file or directory is denied.
DSM_RC_INVALID_OPT (0400)	An invalid option was found.
DSM_RC_NO_HOST_ADDR (0405)	The TCPSEVERADDRESS for this server is not defined in the server name stanza in the system options file.
DSM_RC_NO_OPT_FILE (0406)	The options file specified by filename cannot be found.
DSM_RC_MACHINE_SAME (0408)	The NODENAME defined in the options file cannot be the same as the system <i>HostName</i> .
DSM_RC_INVALID_SERVER (0409)	The system options file does not contain the SERVERNAME option.
DSM_RC_INVALID_KEYWORD (0410)	An invalid option keyword was found in the <b>dsmInitEx</b> configuration file, the option string, dsm.sys, or dsm.opt.
DSM_RC_PATTERN_TOO_COMPLEX (0411)	The include or exclude pattern issued is too complex to be accurately interpreted by IBM Spectrum Protect™.
DSM_RC_NO_CLOSING_BRACKET (0412)	The include or exclude pattern is incorrectly constructed. The closing bracket is missing.
DSM_RC-NLS_CANT_OPEN_TXT (0610)	The system is unable to open the message text file.
DSM_RC-NLS_INVALID_CNTL_REC (0612)	The system is unable to use the message text file.
DSM_RC_NOT_ADSM_AUTHORIZED (0927)	You must be the authorized user to have multithreading and <i>passwordaccess</i> generate.
DSM_RC_NO_INCLEXCL_FILE (2229)	The include-exclude file was not found.
DSM_RC_NO_SYS_OR_INCLEXCL (2230)	Either the dsm.sys or the include-exclude file was not found.

## dsmTerminate

The **dsmTerminate** function call ends a session with the IBM Spectrum Protect™ server and cleans up the IBM Spectrum Protect environment.

## Syntax

There are no return codes that are specific for this call.

```
dsInt16_t dsmTerminate (dsUInt32_t dsmHandle);
```

## Parameters

---

dsUInt32\_t dsmHandle (I)

The handle that associates this call with a previous **dsmInitEx** call.

## dsmUpdateFS

---

The **dsmUpdateFS** function call updates a file space in IBM Spectrum Protect™ storage. This update ensures that the administrator has a current record of your file space.

## Syntax

---

```
dsInt16_t dsmUpdateFS (dsUInt32_t      dsmHandle,  
                      char            *fs,  
                      dsmFSUpd       *fsUpdP,  
                      dsUInt32_t      fsUpdAct);
```

## Parameters

---

dsUInt32\_t dsmHandle (I)

The handle that associates this call with a previous **dsmInitEx** call.

char \*fs (I)

This parameter is a pointer to the file space name.

dsmFSUpd \*fsUpdP (I)

This parameter is a pointer to the structure that has the correct fields for the update that you want. Complete only those fields that need updating.

dsUInt32\_t fsUpdAct (I)

A 2-byte bit map that indicates which of the fields to update. The bit masks have the following values:

- DSM\_FSUPD\_FSTYPE
- DSM\_FSUPD\_FSINFO  
Tip: For Windows operating systems, the drive letter value from **dsmDOSAttrib** is also updated when **FSINFO** is selected.
- DSM\_FSUPD\_OCCUPANCY
- DSM\_FSUPD\_CAPACITY
- DSM\_FSUPD\_BACKSTARTDATE
- DSM\_FSUPD\_BACKCOMPLETEDATE

For a description of these bit masks, see the **DSM\_FSUPD** definitions in the following topic: [API type definitions source files](#).

## Return codes

---

The following table lists return codes for the **dsmUpdateFS** function call.

Table 1. Return codes for **dsmUpdateFS**

Return code	Return code number	Description
DSM_RC_FS_NOT_REGISTERED	2061	File space name is not registered.
DSM_RC_WRONG_VERSION_PARM	2065	The API version of the application client is different from the IBM Spectrum Protect library version.
DSM_RC_FSINFO_TOOLONG	2106	File space information is too long.

## dsmUpdateObj

---

The **dsmUpdateObj** function call updates the meta information associated with an active backup or archive object already on the server. The application bit data is not affected. To update an object, you must give a specific non-wildcard name. To update an archived object, set the **dsmSendType** to **stArchive**. Only the latest named archive object is updated.

You can only start the **dsmUpdateObj** call in the session state; it cannot be called inside a transaction because it performs its own transaction. And, you can update only one object at a time.

Restriction: On a UNIX or Linux operating system, if you change the owner field, you cannot query or restore the object unless you are the root user.

## Syntax

```
dsInt16_t dsmUpdateObj
(dsUInt32_t dsmHandle,
 dsmSendType sendType,
 void *sendBuff,
 dsmObjName *objNameP,
 ObjAttr *objAttrPtr, /* objInfo */
 dsUInt16_t objUpdAct); /* action bit vector */
```

## Parameters

The field descriptions are the same as those in **dsmSendObj**, with the following exceptions:

dsmObjName \*objNameP (I)

You cannot use a wildcard.

ObjAttr \*objAttrPtr (I)

The **objCompressed** field is ignored for this call.

Other differences are:

- **owner**. If you specify a new **owner** field, the owner changes.
- **sizeEstimate**. If you specify a non-zero value it should be the actual amount of data sent, in bytes. The value is stored in the IBM Spectrum Protect™ metadata for future use.
- **objInfo**. This attribute contains the new information to be placed in the **objInfo** field. Set the **objInfoLength** to the length of the new **objInfo**.

dsUInt16\_t objUpdAct

The bit masks and possible actions for **objUpdAct** are:

DSM\_BACKUPD\_MC

Updates the management class for the object.

DSM\_BACKUPD\_OBJINFO

Updates **objInfo**, **objInfoLength**, and **sizeEstimate**.

DSM\_BACKUPD\_OWNER

Updates the owner of the object.

DSM\_ARCHUPD\_DESCR

Updates the **Description** field. Enter the value for the new description through the **SendBuff** parameter. See the sample program for proper use.

DSM\_ARCHUPD\_OBJINFO

Updates **objInfo**, **objInfoLength**, and **sizeEstimate**.

DSM\_ARCHUPD\_OWNER

Updates the owner of the object.

## Return codes

The return code numbers are provided in parentheses ( ).

Table 1. Return codes for dsmUpdateObj

Return code	Explanation
DSM_RC_INVALID_ACTION (2232)	Invalid action.
DSM_RC_FS_NOT_REGISTERED (2061)	File space not registered.
DSM_RC_BAD_CALL_SEQUENCE (2041)	Sequence of calls is invalid.
DSM_RC_WILDCHAR_NOTALLOWED (2050)	Wildcard characters are not allowed.
DSM_RC_ABORT_NO_MATCH (2)	Previous query does not match.

# dsmUpdateObjEx

---

The **dsmUpdateObjEx** function call updates the meta information that is associated with an active backup or archive object that is on the server. The application bit data is not affected. To update an object, you must specify a non-wildcard name, or you can specify the object ID to update a specific archived object. You cannot use wildcard characters when specifying the name. To update a backup object, set the **dsmSendType** parameter to **stBackup**. To update an archived object, set the **dsmSendType** parameter to **stArchive**.

You can only start the **dsmUpdateObjEx** call in the session state; it cannot be called inside a transaction because it performs its own transaction. You can update only one object at a time.

Restriction: On a UNIX or Linux operating system, if you change the owner field, you cannot query or restore the object unless you are the root user. Only the current active version of a backup object can be updated.

## Syntax

---

```
dsInt16_t dsmUpdateObjEx
(dsmUpdateObjExIn_t *dsmUpdateObjExInP,
 dsmUpdateObjExOut_t *dsmUpdateObjExOutP);
```

## Parameters

---

dsmUpdateObjExIn\_t \*dsmUpdateObjExInP

This structure contains the following input parameters:

dsUInt16\_t stVersion (I)

The current version of the structure that is used.

dsUInt32\_t dsmHandle (I)

The handle that associates this call with a previous **dsmInitEx** call.

dsmSendType sendType (I)

The type of send that is being performed. The value can be:

stBackup

A backup object that is sent to the server.

stArchive

An archive object that is sent to the server.

dsmObjName \*objNameP (I)

A pointer to the structure that contains the filespace name, high-level object name, low-level object name, and object type. You cannot use a wildcard.

ObjAttr \*objAttrPtr (I)

Passes object attributes to the application. The values that are updated depend on the flags in the **objUpdAct** field. The **objCompressed** attribute is ignored for this call.

The attributes are:

- **owner** changes the owner if a new name is entered.
- **sizeEstimate** is the actual amount of data that is sent in bytes. The value is stored in the IBM Spectrum Protect™ meta data for future use.
- **objCompressed** is a Boolean value that states whether or not the object data have already been compressed.
- **objInfo** is an attribute that contains the new information to be placed in the **objInfo** field. Set the **objInfoLength** to the length of the new **objInfo**.
- **mcNameP** contains the name of a management class that overrides the management class that is obtained from **dsmBindMC**.

dsUInt32\_t objUpdAct

Specifies the bit masks and actions for **objUpdAct** are:

DSM\_BACKUPD\_MC

Updates the management class for the object.

DSM\_BACKUPD\_OBJINFO

Updates the information object (**objInfo**), the length of the information object (**objInfoLength**), and the amount of data that is sent (**sizeEstimate**) for the backup object.

DSM\_BACKUPD\_OWNER

Updates the owner for the backup object.

DSM\_ARCHUPD\_DESCR  
Updates the **Description** field for the archive object. Enter the value for the new description through the **sendBuff** parameter.

DSM\_ARCHUPD\_OBJINFO  
Updates the information object (**objInfo**), the length of the information object (**objInfoLength**), and the amount of data that is sent (**sizeEstimate**) for the archive object.

DSM\_ARCHUPD\_OWNER  
Updates the owner of the archive object.

ObjID archObjId

Specifies the unique object ID for a specific archive object. Because multiple archive objects can have the same name, this parameter identifies a specific one. You can obtain the object ID by using a query archive call.

dsmUpdateObjExOut\_t \*dsmUpdateObjExOutP

This structure contains the output parameter:

dsUInt16\_t stVersion (I)

The current version of the structure that is used.

## Return codes

The return code numbers are provided in parentheses ( ) in the following table.

Table 1. Return codes for dsmUpdateObjEx

Return code	Explanation
DSM_RC_INVALID_ACTION (2012)	Invalid action.
DSM_RC_FS_NOT_REGISTERED (2061)	File space not registered.
DSM_RC_BAD_CALL_SEQUENCE (2041)	Sequence of calls is invalid.
DSM_RC_WILDCHAR_NOTALLOWED (2050)	Wildcard characters are not allowed.
DSM_RC_ABORT_NO_MATCH (2)	Previous query does not match.

## API return codes source file: dsmerc.h

The dsmerc.h header file contains all return codes that the API can return to an application.

The information that is provided here contains a point-in-time copy of the dsmerc.h file that is distributed with the API. View the file in the API distribution package for the latest version.

```

/*****
* Tivoli Storage Manager                                     *
* API Client Component                                     *
*                                                         *
* (C) Copyright IBM Corporation 1993,2010                 *
*****/

/*****
/* Header File Name:  dsmerc.h                             */
/*                                                         */
/* Descriptive-name:  Return codes from Tivoli Storage Manager APIs */
*****/
#ifndef _H_DSMMC
#define _H_DSMMC

#ifndef DSMAPILIB

#ifndef _H_ANSMACH
typedef int RetCode ;
#endif

#endif

#endif

```

```

#define DSM_RC_SUCCESSFUL          0 /* successful completion */
#define DSM_RC_OK                  0 /* successful completion */

#define DSM_RC_UNSUCCESSFUL        -1 /* unsuccessful completion */

/* dsmEndTxn reason code */
#define DSM_RS_ABORT_SYSTEM_ERROR  1
#define DSM_RS_ABORT_NO_MATCH      2
#define DSM_RS_ABORT_BY_CLIENT     3
#define DSM_RS_ABORT_ACTIVE_NOT_FOUND 4
#define DSM_RS_ABORT_NO_DATA       5
#define DSM_RS_ABORT_BAD_VERIFIER  6
#define DSM_RS_ABORT_NODE_IN_USE   7
#define DSM_RS_ABORT_EXPDATE_TOO_LOW 8
#define DSM_RS_ABORT_DATA_OFFLINE  9
#define DSM_RS_ABORT_EXCLUDED_BY_SIZE 10
#define DSM_RS_ABORT_NO_STO_SPACE_SKIP 11
#define DSM_RS_ABORT_NO_REPOSIT_SPACE DSM_RS_ABORT_NO_STO_SPACE_SKIP
#define DSM_RS_ABORT_MOUNT_NOT_POSSIBLE 12
#define DSM_RS_ABORT_SIZEESTIMATE_EXCEED 13
#define DSM_RS_ABORT_DATA_UNAVAILABLE 14
#define DSM_RS_ABORT_RETRY         15
#define DSM_RS_ABORT_NO_LOG_SPACE  16
#define DSM_RS_ABORT_NO_DB_SPACE   17
#define DSM_RS_ABORT_NO_MEMORY     18

#define DSM_RS_ABORT_FS_NOT_DEFINED 20
#define DSM_RS_ABORT_NODE_ALREADY_DEFED 21
#define DSM_RS_ABORT_NO_DEFAULT_DOMAIN 22
#define DSM_RS_ABORT_INVALID_NODENAME 23
#define DSM_RS_ABORT_INVALID_POL_BIND 24
#define DSM_RS_ABORT_DEST_NOT_DEFINED 25
#define DSM_RS_ABORT_WAIT_FOR_SPACE  26
#define DSM_RS_ABORT_NOT_AUTHORIZED  27
#define DSM_RS_ABORT_RULE_ALREADY_DEFED 28
#define DSM_RS_ABORT_NO_STOR_SPACE_STOP 29

#define DSM_RS_ABORT_LICENSE_VIOLATION 30
#define DSM_RS_ABORT_EXTOBJID_ALREADY_EXISTS 31
#define DSM_RS_ABORT_DUPLICATE_OBJECT 32

#define DSM_RS_ABORT_INVALID_OFFSET 33 /* Partial Object Retrieve */
#define DSM_RS_ABORT_INVALID_LENGTH 34 /* Partial Object Retrieve */
#define DSM_RS_ABORT_STRING_ERROR 35
#define DSM_RS_ABORT_NODE_NOT_AUTHORIZED 36
#define DSM_RS_ABORT_RESTART_NOT_POSSIBLE 37
#define DSM_RS_ABORT_RESTORE_IN_PROGRESS 38
#define DSM_RS_ABORT_SYNTAX_ERROR 39

#define DSM_RS_ABORT_DATA_SKIPPED 40
#define DSM_RS_ABORT_EXCEED_MAX_MP 41
#define DSM_RS_ABORT_NO_OBJSET_MATCH 42
#define DSM_RS_ABORT_PVR_ERROR 43
#define DSM_RS_ABORT_BAD_RECOGTOKEN 44
#define DSM_RS_ABORT_MERGE_ERROR 45
#define DSM_RS_ABORT_FSRENAME_ERROR 46
#define DSM_RS_ABORT_INVALID_OPERATION 47
#define DSM_RS_ABORT_STGPOOL_UNDEFINED 48
#define DSM_RS_ABORT_INVALID_DATA_FORMAT 49
#define DSM_RS_ABORT_DATAMOVER_UNDEFINED 50

#define DSM_RS_ABORT_INVALID_MOVER_TYPE 231
#define DSM_RS_ABORT_ITEM_IN_USE 232
#define DSM_RS_ABORT_LOCK_CONFLICT 233
#define DSM_RS_ABORT_SRV_PLUGIN_COMM_ERROR 234
#define DSM_RS_ABORT_SRV_PLUGIN_OS_ERROR 235
#define DSM_RS_ABORT_CRC_FAILED 236
#define DSM_RS_ABORT_INVALID_GROUP_ACTION 237
#define DSM_RS_ABORT_DISK_UNDEFINED 238
#define DSM_RS_ABORT_BAD_DESTINATION 239
#define DSM_RS_ABORT_DATAMOVER_NOT_AVAILABLE 240
#define DSM_RS_ABORT_STGPOOL_COPY_CONT_NO 241
#define DSM_RS_ABORT_RETRY_SINGLE_TXN 242

```



```

#define DSM_RS_ABORT_TOC_CREATION_FAIL 243
#define DSM_RS_ABORT_TOC_LOAD_FAIL 244
#define DSM_RS_ABORT_PATH_RESTRICTED 245
#define DSM_RS_ABORT_NO_LANFREE_SCRATCH 246
#define DSM_RS_ABORT_INSERT_NOT_ALLOWED 247
#define DSM_RS_ABORT_DELETE_NOT_ALLOWED 248
#define DSM_RS_ABORT_TXN_LIMIT_EXCEEDED 249
#define DSM_RS_ABORT_OBJECT_ALREADY_HELD 250
#define DSM_RS_ABORT_INVALID_CHUNK_REFERENCE 254
#define DSM_RS_ABORT_DESTINATION_NOT_DEDUP 255
#define DSM_RS_ABORT_DESTINATION_POOL_CHANGED 257
#define DSM_RS_ABORT_NOT_ROOT 258

```

```
/* RETURN CODE */
```

```

#define DSM_RC_ABORT_SYSTEM_ERROR DSM_RS_ABORT_SYSTEM_ERROR
#define DSM_RC_ABORT_NO_MATCH DSM_RS_ABORT_NO_MATCH
#define DSM_RC_ABORT_BY_CLIENT DSM_RS_ABORT_BY_CLIENT
#define DSM_RC_ABORT_ACTIVE_NOT_FOUND DSM_RS_ABORT_ACTIVE_NOT_FOUND
#define DSM_RC_ABORT_NO_DATA DSM_RS_ABORT_NO_DATA
#define DSM_RC_ABORT_BAD_VERIFIER DSM_RS_ABORT_BAD_VERIFIER
#define DSM_RC_ABORT_NODE_IN_USE DSM_RS_ABORT_NODE_IN_USE
#define DSM_RC_ABORT_EXPDATE_TOO_LOW DSM_RS_ABORT_EXPDATE_TOO_LOW
#define DSM_RC_ABORT_DATA_OFFLINE DSM_RS_ABORT_DATA_OFFLINE
#define DSM_RC_ABORT_EXCLUDED_BY_SIZE DSM_RS_ABORT_EXCLUDED_BY_SIZE

#define DSM_RC_ABORT_NO_REPOSIT_SPACE DSM_RS_ABORT_NO_STO_SPACE_SKIP
#define DSM_RC_ABORT_NO_STO_SPACE_SKIP DSM_RS_ABORT_NO_STO_SPACE_SKIP

#define DSM_RC_ABORT_MOUNT_NOT_POSSIBLE DSM_RS_ABORT_MOUNT_NOT_POSSIBLE
#define DSM_RC_ABORT_SIZEESTIMATE_EXCEED DSM_RS_ABORT_SIZEESTIMATE_EXCEED
#define DSM_RC_ABORT_DATA_UNAVAILABLE DSM_RS_ABORT_DATA_UNAVAILABLE
#define DSM_RC_ABORT_RETRY DSM_RS_ABORT_RETRY
#define DSM_RC_ABORT_NO_LOG_SPACE DSM_RS_ABORT_NO_LOG_SPACE
#define DSM_RC_ABORT_NO_DB_SPACE DSM_RS_ABORT_NO_DB_SPACE
#define DSM_RC_ABORT_NO_MEMORY DSM_RS_ABORT_NO_MEMORY

#define DSM_RC_ABORT_FS_NOT_DEFINED DSM_RS_ABORT_FS_NOT_DEFINED
#define DSM_RC_ABORT_NODE_ALREADY_DEFED DSM_RS_ABORT_NODE_ALREADY_DEFED
#define DSM_RC_ABORT_NO_DEFAULT_DOMAIN DSM_RS_ABORT_NO_DEFAULT_DOMAIN
#define DSM_RC_ABORT_INVALID_NODENAME DSM_RS_ABORT_INVALID_NODENAME
#define DSM_RC_ABORT_INVALID_POL_BIND DSM_RS_ABORT_INVALID_POL_BIND
#define DSM_RC_ABORT_DEST_NOT_DEFINED DSM_RS_ABORT_DEST_NOT_DEFINED
#define DSM_RC_ABORT_WAIT_FOR_SPACE DSM_RS_ABORT_WAIT_FOR_SPACE
#define DSM_RC_ABORT_NOT_AUTHORIZED DSM_RS_ABORT_NOT_AUTHORIZED
#define DSM_RC_ABORT_RULE_ALREADY_DEFED DSM_RS_ABORT_RULE_ALREADY_DEFED
#define DSM_RC_ABORT_NO_STOR_SPACE_STOP DSM_RS_ABORT_NO_STOR_SPACE_STOP

#define DSM_RC_ABORT_LICENSE_VIOLATION DSM_RS_ABORT_LICENSE_VIOLATION
#define DSM_RC_ABORT_EXTOBJID_ALREADY_EXISTS DSM_RS_ABORT_EXTOBJID_ALREADY_EXISTS
#define DSM_RC_ABORT_DUPLICATE_OBJECT DSM_RS_ABORT_DUPLICATE_OBJECT

#define DSM_RC_ABORT_INVALID_OFFSET DSM_RS_ABORT_INVALID_OFFSET
#define DSM_RC_ABORT_INVALID_LENGTH DSM_RS_ABORT_INVALID_LENGTH

#define DSM_RC_ABORT_STRING_ERROR DSM_RS_ABORT_STRING_ERROR
#define DSM_RC_ABORT_NODE_NOT_AUTHORIZED DSM_RS_ABORT_NODE_NOT_AUTHORIZED
#define DSM_RC_ABORT_RESTART_NOT_POSSIBLE DSM_RS_ABORT_RESTART_NOT_POSSIBLE
#define DSM_RC_ABORT_RESTORE_IN_PROGRESS DSM_RS_ABORT_RESTORE_IN_PROGRESS
#define DSM_RC_ABORT_SYNTAX_ERROR DSM_RS_ABORT_SYNTAX_ERROR

#define DSM_RC_ABORT_DATA_SKIPPED DSM_RS_ABORT_DATA_SKIPPED
#define DSM_RC_ABORT_EXCEED_MAX_MP DSM_RS_ABORT_EXCEED_MAX_MP
#define DSM_RC_ABORT_NO_OBJSET_MATCH DSM_RS_ABORT_NO_OBJSET_MATCH
#define DSM_RC_ABORT_PVR_ERROR DSM_RS_ABORT_PVR_ERROR
#define DSM_RC_ABORT_BAD_RECOGTOKEN DSM_RS_ABORT_BAD_RECOGTOKEN
#define DSM_RC_ABORT_MERGE_ERROR DSM_RS_ABORT_MERGE_ERROR
#define DSM_RC_ABORT_FSRENAME_ERROR DSM_RS_ABORT_FSRENAME_ERROR
#define DSM_RC_ABORT_INVALID_OPERATION DSM_RS_ABORT_INVALID_OPERATION
#define DSM_RC_ABORT_STGPOOL_UNDEFINED DSM_RS_ABORT_STGPOOL_UNDEFINED
#define DSM_RC_ABORT_INVALID_DATA_FORMAT DSM_RS_ABORT_INVALID_DATA_FORMAT
#define DSM_RC_ABORT_DATAMOVER_UNDEFINED DSM_RS_ABORT_DATAMOVER_UNDEFINED

```

```

#define DSM_RC_ABORT_INVALID_MOVER_TYPE          DSM_RS_ABORT_INVALID_MOVER_TYPE
#define DSM_RC_ABORT_ITEM_IN_USE                DSM_RS_ABORT_ITEM_IN_USE
#define DSM_RC_ABORT_LOCK_CONFLICT              DSM_RS_ABORT_LOCK_CONFLICT
#define DSM_RC_ABORT_SRV_PLUGIN_COMM_ERROR      DSM_RS_ABORT_SRV_PLUGIN_COMM_ERROR
#define DSM_RC_ABORT_SRV_PLUGIN_OS_ERROR        DSM_RS_ABORT_SRV_PLUGIN_OS_ERROR
#define DSM_RC_ABORT_CRC_FAILED                  DSM_RS_ABORT_CRC_FAILED
#define DSM_RC_ABORT_INVALID_GROUP_ACTION        DSM_RS_ABORT_INVALID_GROUP_ACTION
#define DSM_RC_ABORT_DISK_UNDEFINED             DSM_RS_ABORT_DISK_UNDEFINED
#define DSM_RC_ABORT_BAD_DESTINATION            DSM_RS_ABORT_BAD_DESTINATION
#define DSM_RC_ABORT_DATAMOVER_NOT_AVAILABLE    DSM_RS_ABORT_DATAMOVER_NOT_AVAILABLE
#define DSM_RC_ABORT_STGPOOL_COPY_CONT_NO       DSM_RS_ABORT_STGPOOL_COPY_CONT_NO
#define DSM_RC_ABORT_RETRY_SINGLE_TXN           DSM_RS_ABORT_RETRY_SINGLE_TXN
#define DSM_RC_ABORT_TOC_CREATION_FAIL          DSM_RS_ABORT_TOC_CREATION_FAIL
#define DSM_RC_ABORT_TOC_LOAD_FAIL              DSM_RS_ABORT_TOC_LOAD_FAIL
#define DSM_RC_ABORT_PATH_RESTRICTED            DSM_RS_ABORT_PATH_RESTRICTED
#define DSM_RC_ABORT_NO_LANFREE_SCRATCH          DSM_RS_ABORT_NO_LANFREE_SCRATCH
#define DSM_RC_ABORT_INSERT_NOT_ALLOWED         DSM_RS_ABORT_INSERT_NOT_ALLOWED
#define DSM_RC_ABORT_DELETE_NOT_ALLOWED         DSM_RS_ABORT_DELETE_NOT_ALLOWED
#define DSM_RC_ABORT_TXN_LIMIT_EXCEEDED         DSM_RS_ABORT_TXN_LIMIT_EXCEEDED
#define DSM_RC_ABORT_OBJECT_ALREADY_HELD        DSM_RS_ABORT_OBJECT_ALREADY_HELD
#define DSM_RC_ABORT_INVALID_CHUNK_REFERENCE     DSM_RS_ABORT_INVALID_CHUNK_REFERENCE
#define DSM_RC_ABORT_DESTINATION_NOT_DEDUP      DSM_RS_ABORT_DESTINATION_NOT_DEDUP
#define DSM_RC_ABORT_DESTINATION_POOL_CHANGED   DSM_RS_ABORT_DESTINATION_POOL_CHANGED
#define DSM_RC_ABORT_NOT_ROOT                    DSM_RS_ABORT_NOT_ROOT

#define DSM_RC_ABORT_CERTIFICATE_NOT_FOUND      DSM_RS_ABORT_CERTIFICATE_NOT_FOUND

/* Definitions for server signon reject codes */
/* These error codes are in the range (51 to 99) inclusive. */
#define DSM_RC_REJECT_NO_RESOURCES              51
#define DSM_RC_REJECT_VERIFIER_EXPIRED          52
#define DSM_RC_REJECT_ID_UNKNOWN                53
#define DSM_RC_REJECT_DUPLICATE_ID              54
#define DSM_RC_REJECT_SERVER_DISABLED           55
#define DSM_RC_REJECT_CLOSED_REGISTER           56
#define DSM_RC_REJECT_CLIENT_DOWNLEVEL         57
#define DSM_RC_REJECT_SERVER_DOWNLEVEL         58
#define DSM_RC_REJECT_ID_IN_USE                 59
#define DSM_RC_REJECT_ID_LOCKED                 61
#define DSM_RC_SIGNONREJECT_LICENSE_MAX         62
#define DSM_RC_REJECT_NO_MEMORY                 63
#define DSM_RC_REJECT_NO_DB_SPACE               64
#define DSM_RC_REJECT_NO_LOG_SPACE              65
#define DSM_RC_REJECT_INTERNAL_ERROR            66
#define DSM_RC_SIGNONREJECT_INVALID_CLI         67 /* client type not licensed */
#define DSM_RC_CLIENT_NOT_ARCHRETPROT           68
#define DSM_RC_REJECT_LASTSESS_CANCELED         69
#define DSM_RC_REJECT_UNICODE_NOT_ALLOWED       70
#define DSM_RC_REJECT_NOT_AUTHORIZED            71
#define DSM_RC_REJECT_TOKEN_TIMEOUT             72
#define DSM_RC_REJECT_INVALID_NODE_TYPE         73
#define DSM_RC_REJECT_INVALID_SESSIONINIT       74
#define DSM_RC_REJECT_WRONG_PORT                75
#define DSM_RC_CLIENT_NOT_SPMRETPROT           79

#define DSM_RC_USER_ABORT                       101 /* processing aborted by user */
#define DSM_RC_NO_MEMORY                         102 /* no RAM left to complete request */
#define DSM_RC_TA_COMM_DOWN                      2021 /* no longer used */
#define DSM_RC_FILE_NOT_FOUND                    104 /* specified file not found */
#define DSM_RC_PATH_NOT_FOUND                    105 /* specified path doesn't exist */
#define DSM_RC_ACCESS_DENIED                     106 /* denied due to improper permission */
#define DSM_RC_NO_HANDLES                        107 /* no more file handles available */
#define DSM_RC_FILE_EXISTS                       108 /* file already exists */
#define DSM_RC_INVALID_PARM                      109 /* invalid parameter passed. CRITICAL*/
#define DSM_RC_INVALID_HANDLE                    110 /* invalid file handle passed */
#define DSM_RC_DISK_FULL                         111 /* out of disk space */
#define DSM_RC_PROTOCOL_VIOLATION                113 /* call protocol violation. CRITICAL */
#define DSM_RC_UNKNOWN_ERROR                     114 /* unknown system error. CRITICAL */
#define DSM_RC_UNEXPECTED_ERROR                 115 /* unexpected error. CRITICAL */
#define DSM_RC_FILE_BEING_EXECUTED              116 /* No write is allowed */
#define DSM_RC_DIR_NO_SPACE                      117 /* directory can't be expanded */
#define DSM_RC_LOOPED_SYM_LINK                   118 /* too many symbolic links were

```

```

encountered in translating path. */
#define DSM_RC_FILE_NAME_TOO_LONG 119 /* file name too long */
#define DSM_RC_FILE_SPACE_LOCKED 120 /* filespace is locked by the system */
#define DSM_RC_FINISHED 121 /* finished processing */
#define DSM_RC_UNKNOWN_FORMAT 122 /* unknown format */
#define DSM_RC_NO_AUTHORIZATION 123 /* server response when the client has
no authorization to read another
host's owner backup/archive data */
#define DSM_RC_FILE_SPACE_NOT_FOUND 124 /* specified file space not found */
#define DSM_RC_TXN_ABORTED 125 /* transaction aborted */
#define DSM_RC_SUBDIR_AS_FILE 126 /* Subdirectory name exists as file */
#define DSM_RC_PROCESS_NO_SPACE 127 /* process has no more disk space. */
#define DSM_RC_PATH_TOO_LONG 128 /* a directory path being build became
too long */
#define DSM_RC_NOT_COMPRESSED 129 /* file thought to be compressed is
actually not */
#define DSM_RC_TOO_MANY_BITS 130 /* file was compressed using more bits
then the expander can handle */
#define DSM_RC_SYSTEM_ERROR 131 /* internal system error */
#define DSM_RC_NO_SERVER_RESOURCES 132 /* server out of resources. */
#define DSM_RC_FS_NOT_KNOWN 133 /* the file space is not known by the
server */
#define DSM_RC_NO_LEADING_DIRSEP 134 /* no leading directory separator */
#define DSM_RC_WILDCARD_DIR 135 /* wildcard character in directory
path when not allowed */
#define DSM_RC_COMM_PROTOCOL_ERROR 136 /* communications protocol error */
#define DSM_RC_AUTH_FAILURE 137 /* authentication failure */
#define DSM_RC_TA_NOT_VALID 138 /* TA not a root and/or SUID program */
#define DSM_RC_KILLED 139 /* process killed. */

#define DSM_RC_RETRY 143 /* retry same operation again */

#define DSM_RC_WOULD_BLOCK 145 /* operation would cause the system to
block waiting for input. */
#define DSM_RC_TOO_SMALL 146 /* area for compiled pattern small */
#define DSM_RC_UNCLOSED 147 /* no closing bracket in pattern */
#define DSM_RC_NO_STARTING_DELIMITER 148 /* pattern has to start with
directory delimiter */
#define DSM_RC_NEEDED_DIR_DELIMITER 149 /* a directory delimiter is needed
immediately before and after the
"match directories" metastring
("...") and one wasn't found */
#define DSM_RC_UNKNOWN_FILE_DATA_TYPE 150 /* structured file data type is
unknown */
#define DSM_RC_BUFFER_OVERFLOW 151 /* data buffer overflow */

#define DSM_RC_NO_COMPRESS_MEMORY 154 /* Compress/Expand out of memory */
#define DSM_RC_COMPRESS_GREW 155 /* Compression grew */
#define DSM_RC_INV_COMM_METHOD 156 /* Invalid comm method specified */
#define DSM_RC_WILL_ABORT 157 /* Transaction will be aborted */
#define DSM_RC_FS_WRITE_LOCKED 158 /* File space is write locked */
#define DSM_RC_SKIPPED_BY_USER 159 /* User wanted file skipped in the
case of ABORT_DATA_OFFLINE */
#define DSM_RC_TA_NOT_FOUND 160 /* TA not found in it's directory */
#define DSM_RC_TA_ACCESS_DENIED 161 /* Access to TA is denied */
#define DSM_RC_FS_NOT_READY 162 /* File space not ready */
#define DSM_RC_FS_IS_BAD 163 /* File space is bad */
#define DSM_RC_FIO_ERROR 164 /* File input/output error */
#define DSM_RC_WRITE_FAILURE 165 /* Error writing to file */
#define DSM_RC_OVER_FILE_SIZE_LIMIT 166 /* File over system/user limit */
#define DSM_RC_CANNOT_MAKE 167 /* Could not create file/directory,
could be a bad name */
#define DSM_RC_NO_PASS_FILE 168 /* password file needed and user is
not root */
#define DSM_RC_VERFILE_OLD 169 /* password stored locally doesn't
match the one at the host */
#define DSM_RC_INPUT_ERROR 173 /* unable to read keyboard input */
#define DSM_RC_REJECT_PLATFORM_MISMATCH 174 /* Platform name doesn't match
up with what the server says
is the platform for the client */
#define DSM_RC_TL_NOT_FILE_OWNER 175 /* User trying to backup a file is not
the file's owner. */
#define DSM_RC_COMPRESSED_DATA_CORRUPTED 176 /* Compressed data is corrupted */

```

```

#define DSM_RC_UNMATCHED_QUOTE      177      /* missing starting or ending quote */

#define DSM_RC_SIGNON_FAILOVER_MODE 178      /* Failed over to the replication server,
running in failover mode */

#define DSM_RC_FAILOVER_MODE_FUNC_BLOCKED 179 /* function is blocked because
session is in failover mode */

/*-----*/
/* Return codes 180-199 are reserved for Policy Set handling */
/*-----*/
#define DSM_RC_PS_MULTBCG          181 /* Multiple backup copy groups in 1 MC*/
#define DSM_RC_PS_MULTACG          182 /* Multiple arch. copy groups in 1 MC*/
#define DSM_RC_PS_NODFLTMC        183 /* Default MC name not in policy set */
#define DSM_RC_TL_NOBCG           184 /* Backup req, no backup copy group */
#define DSM_RC_TL_EXCLUDED        185 /* Backup req, excl. by in/ex filter */
#define DSM_RC_TL_NOACG           186 /* Archive req, no archive copy group */
#define DSM_RC_PS_INVALID_ARCHMC  187 /* Invalid MC name in archive override*/
#define DSM_RC_NO_PS_DATA         188 /* No policy set data on the server */
#define DSM_RC_PS_INVALID_DIRMC   189 /* Invalid directory MC specified in
the options file. */
#define DSM_RC_PS_NO_CG_IN_DIR_MC 190 /* No backup copy group in directory MC.
Must specify an MC using DirMC
option. */

#define DSM_RC_WIN32_UNSUPPORTED_FILE_TYPE 280 /* File is not of
Win32 type FILE_TYPE_DISK */

/*-----*/
/* Return codes for the Trusted Communication Agent */
/*-----*/
#define DSM_RC_TCA_NOT_ROOT        161 /* Access to TA is denied */
#define DSM_RC_TCA_ATTACH_SHR_MEM_ERR 200 /* Error attaching shared memory */
#define DSM_RC_TCA_SHR_MEM_BLOCK_ERR 200 /* Shared memory block error */
#define DSM_RC_TCA_SHR_MEM_IN_USE   200 /* Shared memory block error */
#define DSM_RC_TCA_SHARED_MEMORY_ERROR 200 /* Shared memory block error */
#define DSM_RC_TCA_SEGMENT_MISMATCH 200 /* Shared memory block error */
#define DSM_RC_TCA_FORK_FAILED      292 /* Error forking off TCA process */
#define DSM_RC_TCA_DIED             294 /* TCA died unexpectedly */
#define DSM_RC_TCA_INVALID_REQUEST  295 /* Invalid request sent to TCA */
#define DSM_RC_TCA_SEMGET_ERROR     297 /* Error getting semaphores */
#define DSM_RC_TCA_SEM_OP_ERROR     298 /* Error in semaphore set or wait */
#define DSM_RC_TCA_NOT_ALLOWED      299 /* TCA not allowed (multi thread) */

/*-----*/
/* 400-430 for options */
/*-----*/
#define DSM_RC_INVALID_OPT          400 /* invalid option */
#define DSM_RC_NO_HOST_ADDR        405 /* Not enuf info to connect server */
#define DSM_RC_NO_OPT_FILE         406 /* No default user configuration file*/
#define DSM_RC_MACHINE_SAME        408 /* -MACHINENAME same as real name */
#define DSM_RC_INVALID_SERVER      409 /* Invalid server name from client */
#define DSM_RC_INVALID_KEYWORD     410 /* Invalid option keyword */
#define DSM_RC_PATTERN_TOO_COMPLEX 411 /* Can't match Include/Exclude entry*/
#define DSM_RC_NO_CLOSING_BRACKET  412 /* Missing closing bracket inc/excl */
#define DSM_RC_OPT_CLIENT_NOT_ACCEPTING 417/* Client doesn't accept this option
from the server */
#define DSM_RC_OPT_CLIENT_DOES_NOT_WANT 418/* Client doesn't want this value
from the server */
#define DSM_RC_OPT_NO_INCLEXCL_FILE 419 /* inclexcl file not found */
#define DSM_RC_OPT_OPEN_FAILURE    420 /* can't open file */
#define DSM_RC_OPT_INV_NODENAME    421/* used for Windows if nodename=local
machine when CLUSTERNODE=YES */
#define DSM_RC_OPT_NODENAME_INVALID 423/* generic invalid nodename */
#define DSM_RC_OPT_ERRORLOG_CONFLICT 424/* both logmax & retention specified */
#define DSM_RC_OPT_SCHEDLOG_CONFLICT 425/* both logmax & retention specified */
#define DSM_RC_CANNOT_OPEN_TRACEFILE 426/* cannot open trace file */
#define DSM_RC_CANNOT_OPEN_LOGFILE 427/* cannot open error log file */
#define DSM_RC_OPT_SESSINIT_LF_CONFLICT 428/* both sessioninit=server and
enablelanfree=yes are specified*/
#define DSM_RC_OPT_OPTION_IGNORE   429/* option will be ignored */
#define DSM_RC_OPT_DEDUP_CONFLICT  430/* cannot open error log file */
#define DSM_RC_OPT_HSMLOG_CONFLICT 431/* both logmax & retention specified */

```

```

/*-----*/
/* 600 to 610 for volume label codes */
/*-----*/
#define DSM_RC_DUP_LABEL          600 /* duplicate volume label found */
#define DSM_RC_NO_LABEL          601 /* drive has no label */

/*-----*/
/* Return codes for message file processing */
/*-----*/
#define DSM_RC-NLS_CANT_OPEN_TXT  610 /* error trying to open msg txt file */
#define DSM_RC-NLS_CANT_READ_HDR  611 /* error trying to read header */
#define DSM_RC-NLS_INVALID_CNTL_REC 612 /* invalid control record */
#define DSM_RC-NLS_INVALID_DATE_FMT 613 /* invalid default date format */
#define DSM_RC-NLS_INVALID_TIME_FMT 614 /* invalid default time format */
#define DSM_RC-NLS_INVALID_NUM_FMT 615 /* invalid default number format */

/*-----*/
/* Return codes 620-630 are reserved for log message return codes */
/*-----*/
#define DSM_RC_LOG_CANT_BE_OPENED  620 /* error trying to open error log */
#define DSM_RC_LOG_ERROR_WRITING_TO_LOG 621 /* error occurred writing to
log file */
#define DSM_RC_LOG_NOT_SPECIFIED   622 /* no error log file was specified */

/*-----*/
/* Return codes 900-999 TSM CLIENT ONLY */
/*-----*/
#define DSM_RC_NOT_ADSM_AUTHORIZED  927 /* Must be ADSM authorized to perform*/
/* action : root user or pwd auth */
#define DSM_RC_REJECT_USERID_UNKNOWN 940 /* userid unknown on server */
#define DSM_RC_FILE_IS_SYMLINK      959 /* errorlog or trace is a symbolic
link
*/

#define DSM_RC_DIRECT_STORAGE_AGENT_UNSUPPORTED 961 /* Direct connection to SA not supported */
#define DSM_RC_FS_NAMESPACE_DOWNLEVEL 963 /* Long namespace has been removed from
from the Netware volume */
#define DSM_RC_CONTINUE_NEW_CONSUMER 972 /* Continue processing using a new consumer */
#define DSM_RC_CONTINUE_NEW_CONSUMER_NODEDUP 973 /* Continue processing using a new consumer no
dedup*/
#define DSM_RC_CONTINUE_NEW_CONSUMER_NOCOMPRESS 976 /* Continue processing using a new consumer no
compression */

#define DSM_RC_SERVER_SUPPORTS_FUNC 994 /* the server supports this function */
#define DSM_RC_SERVER_AND_SA_SUPPORT_FUNC 995 /* Both server and SA support func */
#define DSM_RC_SERVER_DOWNLEVEL_FUNC 996 /* The server is downlevel for func */
#define DSM_RC_STORAGEAGENT_DOWNLEVEL 997 /* the storage agent is downlevel */
#define DSM_RC_SERVER_AND_SA_DOWNLEVEL 998 /* both server and SA downlevel */

/* TCP/IP error codes */
#define DSM_RC_TCPIP_FAILURE -50 /* TCP/IP communications failure */
#define DSM_RC_CONN_TIMEDOUT -51 /* TCP/IP connection attempt timedout */
#define DSM_RC_CONN_REFUSED -52 /* TCP/IP connection refused by host */
#define DSM_RC_BAD_HOST_NAME -53 /* TCP/IP invalid host name specified */
#define DSM_RC_NETWORK_UNREACHABLE -54 /* TCP/IP host name unreachable */
#define DSM_RC_WINSOCK_MISSING -55 /* TCP/IP WINSOCK.DLL missing */
#define DSM_RC_TCPIP_DLL_LOADFAILURE -56 /* Error from LoadLibrary */
#define DSM_RC_TCPIP_LOADFAILURE -57 /* Error from GetProcAddress */
#define DSM_RC_TCPIP_USER_ABORT -58 /* User aborted while in TCP/IP layer */

/*-----*/
/* Return codes (-71)-(-90) are reserved for CommTSM error codes */
/*-----*/
#define DSM_RC_TSM_FAILURE -71 /* TSM communications failure */
#define DSM_RC_TSM_ABORT -72 /* Session aborted abnormally */

/*comm3270 error codes - no longer used*/
#define DSM_RC_COMM_TIMEOUT 2021 /* no longer used */
#define DSM_RC_EMULATOR_INACTIVE 2021 /* no longer used */
#define DSM_RC_BAD_HOST_ID 2021 /* no longer used */

```

```

#define DSM_RC_HOST_SESS_BUSY      2021 /* no longer used */
#define DSM_RC_3270_CONNECT_FAILURE 2021 /* no longer used */
#define DSM_RC_NO_ACS3ELKE_DLL    2021 /* no longer used */
#define DSM_RC_EMULATOR_ERROR    2021 /* no longer used */
#define DSM_RC_EMULATOR_BACKLEVEL 2021 /* no longer used */
#define DSM_RC_CKSUM_FAILURE      2021 /* no longer used */

/* The following Return codes are for EHLAPI for Windows */
#define DSM_RC_3270COMMErrors_DLL 2021 /* no longer used */
#define DSM_RC_3270COMMErrors_GetProc 2021 /* no longer used */
#define DSM_RC_EHLAPIError_DLL    2021 /* no longer used */
#define DSM_RC_EHLAPIError_GetProc 2021 /* no longer used */
#define DSM_RC_EHLAPIError_HostConnect 2021 /* no longer used */
#define DSM_RC_EHLAPIError_AllocBuff 2021 /* no longer used */
#define DSM_RC_EHLAPIError_SendKey 2021 /* no longer used */
#define DSM_RC_EHLAPIError_PacketChk 2021 /* no longer used */
#define DSM_RC_EHLAPIError_ChkSum 2021 /* no longer used */
#define DSM_RC_EHLAPIError_HostTimeOut 2021 /* no longer used */
#define DSM_RC_EHLAPIError_Send 2021 /* no longer used */
#define DSM_RC_EHLAPIError_Recv 2021 /* no longer used */
#define DSM_RC_EHLAPIError_General 2021 /* no longer used */
#define DSM_RC_PC3270_MISSING_DLL 2021 /* no longer used */
#define DSM_RC_3270COMM_MISSING_DLL 2021 /* no longer used */

/* NETBIOS error codes */
#define DSM_RC_NETB_ERROR -151 /* Could not add node to LAN */
#define DSM_RC_NETB_NO_DLL -152 /* The ACSNETB.DLL could not be loaded */
#define DSM_RC_NETB_LAN_ERR -155 /* LAN error detected */
#define DSM_RC_NETB_NAME_ERR -158 /* Netbios error on Add Name */
#define DSM_RC_NETB_TIMEOUT -159 /* Netbios send timeout */
#define DSM_RC_NETB_NOTINST -160 /* Netbios not installed - DOS */
#define DSM_RC_NETB_REBOOT -161 /* Netbios config err - reboot DOS */

/* Named Pipe error codes */
#define DSM_RC_NP_ERROR -190

/* CPIC error codes */
#define DSM_RC_CPIC_ALLOCATE_FAILURE 2021 /* no longer used */
#define DSM_RC_CPIC_TYPE_MISMATCH 2021 /* no longer used */
#define DSM_RC_CPIC_PIP_NOT_SPECIFY_ERR 2021 /* no longer used */
#define DSM_RC_CPIC_SECURITY_NOT_VALID 2021 /* no longer used */
#define DSM_RC_CPIC_SYNC_LVL_NO_SUPPORT 2021 /* no longer used */
#define DSM_RC_CPIC_TPN_NOT_RECOGNIZED 2021 /* no longer used */
#define DSM_RC_CPIC_TP_ERROR 2021 /* no longer used */
#define DSM_RC_CPIC_PARAMETER_ERROR 2021 /* no longer used */
#define DSM_RC_CPIC_PROD_SPECIFIC_ERR 2021 /* no longer used */
#define DSM_RC_CPIC_PROGRAM_ERROR 2021 /* no longer used */
#define DSM_RC_CPIC_RESOURCE_ERROR 2021 /* no longer used */
#define DSM_RC_CPIC_DEALLOCATE_ERROR 2021 /* no longer used */
#define DSM_RC_CPIC_SVC_ERROR 2021 /* no longer used */
#define DSM_RC_CPIC_PROGRAM_STATE_CHECK 2021 /* no longer used */
#define DSM_RC_CPIC_PROGRAM_PARAM_CHECK 2021 /* no longer used */
#define DSM_RC_CPIC_UNSUCCESSFUL 2021 /* no longer used */
#define DSM_RC_UNKNOWN_CPIC_PROBLEM 2021 /* no longer used */
#define DSM_RC_CPIC_MISSING_LU 2021 /* no longer used */
#define DSM_RC_CPIC_MISSING_TP 2021 /* no longer used */
#define DSM_RC_CPIC_SNA6000_LOAD_FAIL 2021 /* no longer used */
#define DSM_RC_CPIC_STARTUP_FAILURE 2021 /* no longer used */

/*-----*/
/* Return codes -300 to -307 are reserved for IPX/SPX communications */
/*-----*/
#define DSM_RC_TLI_ERROR 2021 /* no longer used */
#define DSM_RC_IPXSPX_FAILURE 2021 /* no longer used */
#define DSM_RC_TLI_DLL_MISSING 2021 /* no longer used */
#define DSM_RC_DLL_LOADFAILURE 2021 /* no longer used */
#define DSM_RC_DLL_FUNCTION_LOADFAILURE 2021 /* no longer used */
#define DSM_RC_IPXCONN_REFUSED 2021 /* no longer used */
#define DSM_RC_IPXCONN_TIMEDOUT 2021 /* no longer used */
#define DSM_RC_IPXADDR_UNREACHABLE 2021 /* no longer used */
#define DSM_RC_CPIC_MISSING_DLL 2021 /* no longer used */
#define DSM_RC_CPIC_DLL_LOADFAILURE 2021 /* no longer used */

```

```

#define DSM_RC_CPIC_FUNC_LOADFAILURE          2021 /* no longer used      */

/*==== Shared Memory Protocol error codes  ====*/
#define DSM_RC_SHM_TCPIP_FAILURE             -450
#define DSM_RC_SHM_FAILURE                   -451
#define DSM_RC_SHM_NOTAUTH                   -452

#define DSM_RC_NULL_OBJNAME                  2000 /* Object name pointer is NULL    */
#define DSM_RC_NULL_DATABLKPTR              2001 /* dataBlkPtr is NULL             */
#define DSM_RC_NULL_MSG                      2002 /* msg parm in dsmRCMsg is NULL   */

#define DSM_RC_NULL_OBJATTRPTR              2004 /* Object Attr Pointer is NULL    */

#define DSM_RC_NO_SESS_BLK                   2006 /* no server session info         */
#define DSM_RC_NO_POLICY_BLK                2007 /* no policy hdr info             */
#define DSM_RC_ZERO_BUFLEN                   2008 /* bufferLen is zero for dataBlkPtr */
#define DSM_RC_NULL_BUFPTR                  2009 /* bufferPtr is NULL for dataBlkPtr */

#define DSM_RC_INVALID_OBJTYPE               2010 /* invalid object type            */
#define DSM_RC_INVALID_VOTE                 2011 /* invalid vote                   */
#define DSM_RC_INVALID_ACTION               2012 /* invalid action                 */
#define DSM_RC_INVALID_DS_HANDLE            2014 /* invalid ADSM handle           */
#define DSM_RC_INVALID_REPOS                2015 /* invalid value for repository   */
#define DSM_RC_INVALID_FSNAME               2016 /* fs should start with dir delim */
#define DSM_RC_INVALID_OBJNAME              2017 /* invalid full path name         */
#define DSM_RC_INVALID_LLNAME               2018 /* ll should start with dir delim */
#define DSM_RC_INVALID_OBJOWNER             2019 /* invalid object owner name      */
#define DSM_RC_INVALID_ACTYPE               2020 /* invalid action type            */
#define DSM_RC_INVALID_RETCODE              2021 /* dsmRC in dsmRCMsg is invalid  */
#define DSM_RC_INVALID_SENDTYPE             2022 /* invalid send type              */
#define DSM_RC_INVALID_PARAMETER            2023 /* invalid parameter              */
#define DSM_RC_INVALID_OBJSTATE             2024 /* active, inactive, or any match? */
#define DSM_RC_INVALID_MCNAME               2025 /* Mgmt class name not found      */
#define DSM_RC_INVALID_DRIVE_CHAR           2026 /* Drive letter is not alphabet   */
#define DSM_RC_NULL_FSNAME                  2027 /* Filespace name is NULL         */
#define DSM_RC_INVALID_HLNAME               2028 /* hl should start with dir delim */

#define DSM_RC_NUMOBJ_EXCEED                2029 /* BeginGetData num objs exceeded */

#define DSM_RC_NEWPW_REQD                   2030 /* new password is required       */
#define DSM_RC_OLDPW_REQD                   2031 /* old password is required       */
#define DSM_RC_NO_OWNER_REQD                2032 /* owner not allowed. Allow default */
#define DSM_RC_NO_NODE_REQD                 2033 /* node not allowed w/ pw=generate */
#define DSM_RC_KEY_MISSING                   2034 /* key file can't be found        */
#define DSM_RC_KEY_BAD                       2035 /* content of key file is bad     */

#define DSM_RC_BAD_CALL_SEQUENCE            2041 /* Sequence of DSM calls not allowed*/
#define DSM_RC_INVALID_TSMBUFFER            2042 /* invalid value for tsmbuffhandle or dataPtr */
#define DSM_RC_TOO_MANY_BYTES               2043 /* too many bytes copied to buffer */
#define DSM_RC_MUST_RELEASE_BUFFER           2044 /* cant exit app needs to release buffers */
#define DSM_RC_BUFF_ARRAY_ERROR              2045 /* internal buff array error      */
#define DSM_RC_INVALID_DATABLK              2046 /* using tsmbuff datablk should be null */
#define DSM_RC_ENCR_NOT_ALLOWED              2047 /* when using tsmbuffers encryption not allowed */
#define DSM_RC_OBJ_COMPRESSED                2048 /* Can't restore using tsmBuff on compressed object */
#define DSM_RC_OBJ_ENCRYPTED                  2049 /* Cant restore using tsmbuff an encr obj */
#define DSM_RC_WILDCHAR_NOTALLOWED          2050 /* Wild card not allowed for hl,ll */
#define DSM_RC_POR_NOT_ALLOWED               2051 /* Can't use partial object restore with tsmBuffers */
#define DSM_RC_NO_ENCRYPTION_KEY            2052 /* Encryption key not found*/
#define DSM_RC_ENCR_CONFLICT                 2053 /* mutually exclusive options */

#define DSM_RC_FSNAME_NOTFOUND              2060 /* Filespace name not found       */
#define DSM_RC_FS_NOT_REGISTERED            2061 /* Filespace name not registered   */
#define DSM_RC_FS_ALREADY_REGED             2062 /* Filespace already registered    */
#define DSM_RC_OBJID_NOTFOUND               2063 /* No object id to restore         */
#define DSM_RC_WRONG_VERSION                 2064 /* Wrong level of code            */
#define DSM_RC_WRONG_VERSION_PARM           2065 /* Wrong level of parameter struct */

#define DSM_RC_NEEDTO_ENDTXN                2070 /* Need to call dsmEndTxn         */

#define DSM_RC_OBJ_EXCLUDED                  2080 /* Object is excluded by MC        */
#define DSM_RC_OBJ_NOBCG                     2081 /* Object has no backup copy group */
#define DSM_RC_OBJ_NOACG                     2082 /* Object has no archive copy group */

#define DSM_RC_APISYSTEM_ERROR              2090 /* API internal error             */

```

```

#define DSM_RC_DESC_TOOLONG          2100 /* description is too long          */
#define DSM_RC_OBJINFO_TOOLONG       2101 /* object attr objinfo too long      */
#define DSM_RC_HL_TOOLONG            2102 /* High level qualifier is too long  */
#define DSM_RC_PASSWD_TOOLONG        2103 /* password is too long              */
#define DSM_RC_FILESPACE_TOOLONG     2104 /* filesystem name is too long       */
#define DSM_RC_LL_TOOLONG            2105 /* Low level qualifier is too long   */
#define DSM_RC_FSINFO_TOOLONG        2106 /* filesystem length is too big      */
#define DSM_RC_SENDDATA_WITH_ZERO_SIZE 2107 /* send data w/ zero est            */

/*=== new return codes for dsmaccess ===*/
#define DSM_RC_INVALID_ACCESS_TYPE  2110 /* invalid access type              */
#define DSM_RC_QUERY_COMM_FAILURE    2111 /* communication error during query  */
#define DSM_RC_NO_FILES_BACKUP       2112 /* No backed up files for this fs    */
#define DSM_RC_NO_FILES_ARCHIVE      2113 /* No archived files for this fs     */
#define DSM_RC_INVALID_SETACCESS     2114 /* invalid set access format         */

/*=== new return codes for dsmaccess ===*/
#define DSM_RC_STRING_TOO_LONG       2120 /* String parameter too long        */

#define DSM_RC_MORE_DATA              2200 /* There are more data to restore   */

#define DSM_RC_BUFF_TOO_SMALL        2210 /* DataBlk buffer too small for qry */

#define DSM_RC_NO_API_CONFIGFILE     2228 /*specified API cfg file not found*/
#define DSM_RC_NO_INCLEXCL_FILE      2229 /* specified inclexcl file not found*/
#define DSM_RC_NO_SYS_OR_INCLEXCL    2230 /* either dsm.sys or inclexcl file
                                     specified in dsm.sys not found */
#define DSM_RC_REJECT_NO_POR_SUPPORT 2231 /* server doesn't have POR support*/

#define DSM_RC_NEED_ROOT              2300 /* API caller must be root          */
#define DSM_RC_NEEDTO_CALL_BINDMC    2301 /* dsmBindMC must be called first   */
#define DSM_RC_CHECK_REASON_CODE     2302 /* check reason code from dsmEndTxn */
#define DSM_RC_NEEDTO_ENDTXN_DEDUP_SIZE_EXCEEDED 2303 /* max dedup bytes exceeded */

/*=== return codes 2400 - 2410 used by lic file see agentrc.h ===*/

/*=== return codes 2410 - 2430 used by Oracle agent see agentrc.h ===*/

#define DSM_RC_ENC_WRONG_KEY          4580 /* the key provided is incorrect    */
#define DSM_RC_ENC_NOT_AUTHORIZED     4582 /* user is not allowed to decrypt   */
#define DSM_RC_ENC_TYPE_UNKNOWN       4584 /* encryption type unknown          */

/*=====
   Return codes (4600)-(4624) are reserved for clustering
=====*/
#define DSM_RC_CLUSTER_INFO_LIBRARY_NOT_LOADED 4600
#define DSM_RC_CLUSTER_LIBRARY_INVALID        4601
#define DSM_RC_CLUSTER_LIBRARY_NOT_LOADED     4602
#define DSM_RC_CLUSTER_NOT_MEMBER_OF_CLUSTER  4603
#define DSM_RC_CLUSTER_NOT_ENABLED            4604
#define DSM_RC_CLUSTER_NOT_SUPPORTED         4605
#define DSM_RC_CLUSTER_UNKNOWN_ERROR         4606

/*=====
   Return codes (5200)-(5600) are reserved for new Server ABORT codes (dsmcomm.h)
=====*/
#define DSM_RS_ABORT_CERTIFICATE_NOT_FOUND 5200

/*=====
   Return codes (5701)-(5749) are reserved for proxy
=====*/
#define DSM_RC_PROXY_REJECT_NO_RESOURCES      5702
#define DSM_RC_PROXY_REJECT_DUPLICATE_ID     5705
#define DSM_RC_PROXY_REJECT_ID_IN_USE        5710
#define DSM_RC_PROXY_REJECT_INTERNAL_ERROR   5717
#define DSM_RC_PROXY_REJECT_NOT_AUTHORIZED   5722
#define DSM_RC_PROXY_INVALID_FROMNODE       5746
#define DSM_RC_PROXY_INVALID_SERVERFREE     5747
#define DSM_RC_PROXY_INVALID_CLUSTER        5748
#define DSM_RC_PROXY_INVALID_FUNCTION       5749

/*=====
   Return codes 5801 - 5849 are reserved for cryptography/security
=====*/

```



```

=====*/
#define DSM_RC_CRYPTO_ICC_ERROR                5801
#define DSM_RC_CRYPTO_ICC_CANNOT_LOAD        5802
#define DSM_RC_SSL_NOT_SUPPORTED            5803
#define DSM_RC_SSL_INIT_FAILED              5804
#define DSM_RC_SSL_KEYFILE_OPEN_FAILED      5805
#define DSM_RC_SSL_KEYFILE_BAD_PASSWORD    5806
#define DSM_RC_SSL_BAD_CERTIFICATE          5807

/*=====
   Return codes 6300 - 6399 are reserved for client-side deduplication
=====*/
#define DSM_RC_DIGEST_VALIDATION_ERROR      6300 /* End-to-end digest validation err */
#define DSM_RC_DATA_FINGERPRINT_ERROR      6301 /* Failure in Rabin fingerprinting */
#define DSM_RC_DATA_DEDUP_ERROR            6302 /* Error converting data into chunks */

#endif /* _H_DSMRC */

```

**Related reference:**  
API return codes

## API type definitions source files

---

This appendix contains structure definitions, type definitions, and constants for the API. The first header files, dsmapitd.h and tsmapitd.h, illustrate the definitions that are common to all operating systems.

The second header file, dsmapips.h, provides an example of definitions that are specific to a particular operating system; in this example, the Windows platform.

The third header file, release.h, includes the version and release information.

The information that is provided here contains a point-in-time copy of the files that are distributed with the API. View the files in the API distribution package for the latest version.

```

/*****
 * Tivoli Storage Manager                                *
 * API Client Component                                *
 *                                                    *
 * (C) Copyright IBM Corporation 1993,2010            *
 *****/

/*****
 * Header File Name: dsmapitd.h
 *
 * Environment: ****
 *                ** This is a platform-independent source file **
 *
 *                ****
 *
 * Design Notes:  This file contains basic data types and constants
 *                includable by all client source files. The constants
 *                within this file should be set properly for the
 *                particular machine and operating system on which the
 *                client software is to be run.
 *
 *                Platform specific definitions are included in dsmapips.h
 *
 * Descriptive-name: Definitions for Tivoli Storage manager API constants
 *-----*/

#ifndef _H_DSMAPITD
#define _H_DSMAPITD

#include "dsmapips.h" /* Platform specific definitions*/
#include "release.h"

/*=== set the structure alignment to pack the structures ===*/
#if (_OPSYS_TYPE == DS_WINNT) && !defined(_WIN64)

```



```

/*-----+
| Values for object type in dsmObjName structure |
| Note: These values must be kept in sync with dsmcomm.h |
+-----*/
#define DSM_OBJ_FILE          0x01 /*object has attrib info & data*/
#define DSM_OBJ_DIRECTORY    0x02 /*obj has only attribute info */
#define DSM_OBJ_RESERVED1    0x04 /* for future use */
#define DSM_OBJ_RESERVED2    0x05 /* for future use */
#define DSM_OBJ_RESERVED3    0x06 /* for future use */
#define DSM_OBJ_WILDCARD     0xFE /* Any object type */
#define DSM_OBJ_ANY_TYPE     0xFF /* for future use */

/*-----+
| Type definition for compressedState in QryResp |
+-----*/
#define DSM_OBJ_COMPRESSED_UNKNOWN  0
#define DSM_OBJ_COMPRESSED_YES      1
#define DSM_OBJ_COMPRESSED_NO       2

/*-----+
| Definitions for "group type" field in tsmGroupHandlerIn_t |
+-----*/

#define DSM_GROUPTYPE_NONE          0x00 /* Not a group member */
#define DSM_GROUPTYPE_RESERVED1    0x01 /* for future use */
#define DSM_GROUPTYPE_PEER         0x02 /* Peer group */
#define DSM_GROUPTYPE_RESERVED2    0x03 /* for future use */

/*-----+
| Definitions for "member type" field in tsmGroupHandlerIn_t |
+-----*/

#define DSM_MEMBERTYPE_LEADER       0x01 /* group leader */
#define DSM_MEMBERTYPE_MEMBER       0x02 /* group member */

/*-----+
| Definitions for "operation type" field in tsmGroupHandlerIn_t |
+-----*/

#define DSM_GROUP_ACTION_BEGIN      0x01
#define DSM_GROUP_ACTION_OPEN       0x02 /* create new group */
#define DSM_GROUP_ACTION_CLOSE      0x03 /* commit and save an open group */
#define DSM_GROUP_ACTION_ADD        0x04 /* Append to a group */
#define DSM_GROUP_ACTION_ASSIGNTO   0x05 /* Assign to a another group */
#define DSM_GROUP_ACTION_REMOVE     0x06 /* remove a member from a group */

/*-----+
| Values for copySer in DetailCG structures for Query Mgmt Class response |
+-----*/
#define Copy_Serial_Static          1 /*Copy Serialization Static */
#define Copy_Serial_Shared_Static   2 /*Copy Serialization Shared Static*/
#define Copy_Serial_Shared_Dynamic  3 /*Copy Serialization Shared Dynamic*/
#define Copy_Serial_Dynamic         4 /*Copy Serialization Dynamic */

/*-----+
| Values for copyMode in DetailCG structures for Query Mgmt Class response |
+-----*/
#define Copy_Mode_Modified          1 /*Copy Mode Modified */
#define Copy_Mode_Absolute          2 /*Copy Mode Absolute */

/*-----+
| Values for objState in qryBackupData structure |
+-----*/
#define DSM_ACTIVE                  0x01 /* query only active objects */
#define DSM_INACTIVE                0x02 /* query only inactive objects */
#define DSM_ANY_MATCH               0xFF /* query all backup objects */

/*-----+
| Boundary values for dsmDate.year field in qryArchiveData structure |
+-----*/
#define DATE_MINUS_INFINITE         0x0000 /* lowest boundary */
#define DATE_PLUS_INFINITE          0xFFFF /* highest upper boundary */

/*-----+
| Bits masks for update action parameter on dsmUpdateFS() |

```

```

+-----*/
#define DSM_FSUPD_FSTYPE                ((unsigned) 0x00000002)
#define DSM_FSUPD_FSINFO                 ((unsigned) 0x00000004)
#define DSM_FSUPD_BACKSTARTDATE         ((unsigned) 0x00000008)
#define DSM_FSUPD_BACKCOMPLETEDATE     ((unsigned) 0x00000010)
#define DSM_FSUPD_OCCUPANCY             ((unsigned) 0x00000020)
#define DSM_FSUPD_CAPACITY              ((unsigned) 0x00000040)
#define DSM_FSUPD_RESERVED1            ((unsigned) 0x00000100)

/*-----+
| Bits mask for backup update action parameter on dsmUpdateObj() |
+-----*/
#define DSM_BACKUPD_OWNER                ((unsigned) 0x00000001)
#define DSM_BACKUPD_OBJINFO             ((unsigned) 0x00000002)
#define DSM_BACKUPD_MC                  ((unsigned) 0x00000004)

#define DSM_ARCHUPD_OWNER                ((unsigned) 0x00000001)
#define DSM_ARCHUPD_OBJINFO             ((unsigned) 0x00000002)
#define DSM_ARCHUPD_DESCR                ((unsigned) 0x00000004)

/*-----+
| Values for repository parameter on dsmDeleteFS() |
+-----*/
#define DSM_ARCHIVE_REP                 0x0A /* archive repository */
#define DSM_BACKUP_REP                  0x0B /* backup repository */
#define DSM_REPOS_ALL                     0x01 /* all repository types */

/*-----+
| Values for vote parameter on dsmEndTxn() |
+-----*/
#define DSM_VOTE_COMMIT 1 /* commit current transaction */
#define DSM_VOTE_ABORT 2 /* roll back current transaction */

/*-----+
| Values for various flags returned in ApiSessInfo structure. |
+-----*/
/* Client compression field codes */
#define COMPRESS_YES 1 /* client must compress data */
#define COMPRESS_NO 2 /* client must NOT compress data */
#define COMPRESS_CD 3 /* client determined */

/* Archive delete permission codes. */
#define ARCHDEL_YES 1 /* archive delete allowed */
#define ARCHDEL_NO 2 /* archive delete NOT allowed */

/* Backup delete permission codes. */
#define BACKDEL_YES 1 /* backup delete allowed */
#define BACKDEL_NO 2 /* backup delete NOT allowed

/*-----+
| Values for various flags returned in optStruct structure. |
+-----*/
#define DSM_PASSWD_GENERATE 1
#define DSM_PASSWD_PROMPT 0

#define DSM_COMM_TCP 1 /* tcpip */
#define DSM_COMM_NAMEDPIPE 2 /* Named pipes */
#define DSM_COMM_SHM 3 /* Shared Memory */

/* obsolete commmethods */
#define DSM_COMM_PVM_IUCV 12
#define DSM_COMM_3270 12
#define DSM_COMM_IUCV 12
#define DSM_COMM_PWSCS 12
#define DSM_COMM_SNA_LU6_2 12
#define DSM_COMM_IPXSPX 12 /* For IPX/SPX support */
#define DSM_COMM_NETBIOS 12 /* NETBIOS */
#define DSM_COMM_400COMM 12
#define DSM_COMM_CLIO 12 /* CLIO/S */

/*-----+
| Values for userNameAuthorities in dsmInitEx for future use |
+-----*/
#define DSM_USERAUTH_NONE ((dsInt16_t)0x0000)

```

```

#define DSM_USERAUTH_ACCESS    ((dsInt16_t)0x0001)
#define DSM_USERAUTH_OWNER    ((dsInt16_t)0x0002)
#define DSM_USERAUTH_POLICY    ((dsInt16_t)0x0004)
#define DSM_USERAUTH_SYSTEM    ((dsInt16_t)0x0008)

/*-----+
| Values for encryptionType on dsmEndSendObjEx, queryResp |
+-----*/
#define DSM_ENCRYPT_NO          ((dsUInt8_t)0x00)
#define DSM_ENCRYPT_USER        ((dsUInt8_t)0x01)
#define DSM_ENCRYPT_CLIENTENCRKEY ((dsUInt8_t)0x02)
#define DSM_ENCRYPT_DES_56BIT    ((dsUInt8_t)0x04)
#define DSM_ENCRYPT_AES_128BIT    ((dsUInt8_t)0x08)
#define DSM_ENCRYPT_AES_256BIT    ((dsUInt8_t)0x10)

/*-----+
| Definitions for mediaClass field. |
+-----*/
/*
 * The following constants define a hierarchy of media access classes.
 * Lower numbers indicate media which can supply faster access to data.
 */

/* Fixed: represents the class of on-line, fixed media (such as
   hard disks). */
#define MEDIA_FIXED            0x10

/* Library: represents the class of mountable media accessible
   through a mechanical mounting device. */
#define MEDIA_LIBRARY          0x20

/* future use */
#define MEDIA_NETWORK          0x30

/* future use */
#define MEDIA_SHELF            0x40

/* future use */
#define MEDIA_OFFSITE          0x50

/* future use */
#define MEDIA_UNAVAILABLE      0xF0

/*-----+
| Type definition for partial object data for dsmBeginGetData() |
+-----*/
typedef struct
{
    dsUInt16_t    stVersion;          /* Structure version */
    dsStruct64_t  partialObjOffset;   /* offset into object to begin reading */
    dsStruct64_t  partialObjLength;   /* amount of object to read */
} PartialObjData ;                  /* partial object data */

#define PartialObjDataVersion 1 /*

/*-----+
| Type definition for date structure |
+-----*/
typedef struct
{
    dsUInt16_t    year;              /* year, 16-bit integer (e.g., 1990) */
    dsUInt8_t     month;             /* month, 8-bit integer (1 - 12) */
    dsUInt8_t     day;              /* day. 8-bit integer (1 - 31) */
    dsUInt8_t     hour;             /* hour, 8-bit integer (0 - 23) */
    dsUInt8_t     minute;           /* minute, 8-bit integer (0 - 59) */
    dsUInt8_t     second;           /* second, b-bit integer (0 - 59) */
} dsmDate ;

/*-----+
| Type definition for Object ID on dsmGetObj() and in dsmGetList structure |
+-----*/
typedef dsStruct64_t  ObjID ;

```

```

/*-----+
| Type definition for dsmQueryBuff on dsmBeginQuery() |
+-----*/
typedef void dsmQueryBuff ;

/*-----+
| Type definition for dsmGetType parameter on dsmBeginGetData() |
+-----*/
typedef enum
{
    gtBackup = 0x00,          /* Backup processing type */
    gtArchive                /* Archive processing type */
} dsmGetType ;

/*-----+
| Type definition for dsmQueryType parameter on dsmBeginQuery() |
+-----*/
typedef enum
{
    qtArchive = 0x00,        /* Archive query type */
    qtBackup,                /* Backup query type */
    qtBackupActive,         /* Fast query for active backup files */
    qtFilespace,            /* Filespace query type */
    qtMC,                    /* Mgmt. class query type */
    qtReserved1,            /* future use */
    qtReserved2,            /* future use */
    qtReserved3,            /* future use */
    qtReserved4,            /* future use */
    qtBackupGroups,         /* group leaders in a specific fs */
    qtOpenGroups,           /* Open groups in a specific fs */
    qtReserved5,            /* future use */
    qtProxyNodeAuth,        /* nodes that his node can proxy to */
    qtProxyNodePeer,        /* Peer nodes with the same target */
    qtReserved6,            /* future use */
    qtReserved7,            /* future use */
    qtReserved8             /* future use */
} dsmQueryType ;

/*-----+
| Type definition sendType parameter on dsmBindMC() and dsmSendObj() |
+-----*/
typedef enum
{
    stBackup = 0x00,         /* Backup processing type */
    stArchive,               /* Archive processing type */
    stBackupMountWait,       /* Backup processing with mountwait on */
    stArchiveMountWait       /* Archive processing with mountwait on */
} dsmSendType ;

/*-----+
| Type definition for delType parameter on dsmDeleteObj() |
+-----*/
typedef enum
{
    dtArchive = 0x00,        /* Archive delete type */
    dtBackup,                /* Backup delete (deactivate) type */
    dtBackupID               /* Backup delete (remove) type */
} dsmDelType ;

/*-----+
| Type definition sendType parameter on dsmSetAccess() |
+-----*/
typedef enum
{
    atBackup = 0x00,         /* Backup processing type */
    atArchive                /* Archive processing type */
} dsmAccessType;

/*-----+
| Type definition for API Version on dsmInit() and dsmQueryApiVersion() |
+-----*/
typedef struct
{
    dsUInt16_t version;      /* API version */
}

```

```

    dsUInt16_t release;          /* API release          */
    dsUInt16_t level;           /* API level           */
}dsmApiVersion;

/*-----+
| Type definition for API Version on dsmInit() and dsmQueryApiVersion() |
+-----*/
typedef struct
{
    dsUInt16_t stVersion;        /* Structure version    */
    dsUInt16_t version;         /* API version         */
    dsUInt16_t release;         /* API release         */
    dsUInt16_t level;          /* API level           */
    dsUInt16_t subLevel;        /* API sub level       */
    dsmBool_t  unicode;         /* API unicode?        */
}dsmApiVersionEx;

#define apiVersionExVer      2

/*-----+
| Type definition for Application Version on dsmInit()                   |
+-----*/
typedef struct
{
    dsUInt16_t  stVersion;        /* Structure version    */
    dsUInt16_t  applicationVersion; /* application version number */
    dsUInt16_t  applicationRelease; /* application release number */
    dsUInt16_t  applicationLevel;  /* application level number */
    dsUInt16_t  applicationSubLevel; /* application sub level number */
} dsmAppVersion;

#define appVersionVer      1

/*-----+
| Type definition for object name used on BindMC, Send, Delete, Query    |
+-----*/
typedef struct S_dsmObjName
{
    char        fs[DSM_MAX_FSNAME_LENGTH + 1] ;          /* Filespace name */
    char        hl[DSM_MAX_HL_LENGTH + 1] ;              /* High level name */
    char        ll[DSM_MAX_LL_LENGTH + 1] ;              /* Low level name */
    dsUInt8_t   objType;          /* for object type values, see defines above */
}dsmObjName;

/*-----+
| Type definition for Backup delete info on dsmDeleteObj()               |
+-----*/
typedef struct
{
    dsUInt16_t      stVersion ;          /* structure version    */
    dsmObjName      *objNameP ;          /* object name          */
    dsUInt32_t      copyGroup ;          /* copy group           */
}delBack ;

#define delBackVersion      1

/*-----+
| Type definition for Archive delete info on dsmDeleteObj()              |
+-----*/
typedef struct
{
    dsUInt16_t      stVersion ;          /* structure version    */
    dsStruct64_t    objId ;              /* object ID            */
}delArch ;

#define delArchVersion      1

/*-----+
| Type definition for Backup ID delete info on dsmDeleteObj()            |
+-----*/
typedef struct
{

```

```

    dsUint16_t      stVersion ;          /* structure version      */
    dsStruct64_t    objId ;             /* object ID              */
}delBackID;

#define delBackIDVersion 1

/*-----+
| Type definition for delete info on dsmDeleteObj() |
+-----*/
typedef union
{
    delBack    backInfo ;
    delArch    archInfo ;
    delBackID  backIDInfo ;
}dsmDelInfo ;

/*-----+
| Type definition for Object Attribute parameter on dsmSendObj() |
+-----*/
typedef struct
{
    dsUint16_t    stVersion;           /* Structure version */
    char          owner[DSM_MAX_OWNER_LENGTH + 1]; /* object owner */
    dsStruct64_t  sizeEstimate;        /* Size estimate in bytes of the object */
    dsmBool_t     objCompressed;       /* Is object already compressed? */
    dsUint16_t    objInfoLength;       /* length of object-dependent info */
    char          *objInfo;            /* object-dependent info */
    char          *mcNameP;            /* mgmnt class name for override */
    dsmBool_t     disableDeduplication; /* force no dedup for this object */
    dsmBool_t     useExtObjInfo;       /* use ext obj info up to 1536 */
}ObjAttr;

#define ObjAttrVersion 4

/*-----+
| Type definition for mcBindKey returned on dsmBindMC() |
+-----*/
typedef struct
{
    dsUint16_t    stVersion;           /* structure version      */
    char          mcName[DSM_MAX_MC_NAME_LENGTH + 1]; /* Name of mc bound to object. */
                                           /* True/false */
    dsmBool_t     backup_cg_exists;    /* True/false */
    dsmBool_t     archive_cg_exists;   /* True/false */
    char          backup_copy_dest[DSM_MAX_CG_DEST_LENGTH + 1]; /* Backup copy dest. name */
    char          archive_copy_dest[DSM_MAX_CG_DEST_LENGTH + 1]; /* Arch copy dest.name */
}mcBindKey;

#define mcBindKeyVersion 1

/*-----+
| Type definition for object list on dsmBeginGetData() |
+-----*/
typedef struct
{
    dsUint16_t      stVersion ;          /* structure version      */
    dsUint32_t      numObjId ;          /* number of object IDs in the list */
    ObjID           *objId ;            /* list of object IDs to restore*/
    PartialObjData  *partialObjData;    /*list of partial obj data info */
}dsmGetList ;

#define dsmGetListVersion 2 /* default if not using Partial Obj data */
#define dsmGetListPORVersion 3 /* version if using Partial Obj data */

/*-----+
| Type definition for DataBlk used to Get or Send data |
+-----*/
typedef struct
{

```



```

    dsUInt16_t stVersion; /* structure version */
    dsUInt32_t buflen; /* Length of buffer passed below */
    dsUInt32_t numBytes; /* Actual number of bytes read from */
                        /* or written to the buffer */

    char *bufferPtr; /* Data buffer */
    dsUInt32_t numBytesCompressed; /* on send actual bytes compressed */
    dsUInt16_t reserved; /* for future use */
}DataBlk;

#define DataBlkVersion 3

/*-----+
| Type definition for Mgmt Class queryBuffer on dsmBeginQuery() |
+-----*/
typedef struct S_qryMCData
{
    dsUInt16_t stVersion; /* structure version */
    char *mcName; /* Mgmt class name */
    dsMBool_t mcDetail; /* single name to get one or empty string to get all*/
                        /* Want details or not? */
}qryMCData;

#define qryMCDataVersion 1

/*=== values for RETINIT ===*/
#define ARCH_RETINIT_CREATE 0
#define ARCH_RETINIT_EVENT 1

/*-----+
| Type definition for Archive Copy Group details on Query MC response |
+-----*/
typedef struct S_archDetailCG
{
    char cgName[DSM_MAX_CG_NAME_LENGTH + 1]; /* Copy group name */
    dsUInt16_t frequency; /* Copy (archive) frequency */
    dsUInt16_t retainVers; /* Retain version */
    dsUInt8_t copySer; /* for copy serialization values, see defines */
    dsUInt8_t copyMode; /* for copy mode values, see defines above */
    char destName[DSM_MAX_CG_DEST_LENGTH + 1]; /* Copy dest name */
    dsMBool_t bLanFreeDest; /* Destination has lan free path? */
    dsMBool_t reserved; /* Not currently used */
    dsUInt8_t retainInit; /* possible values see above */
    dsUInt16_t retainMin; /* if retInit is EVENT num of days */
    dsMBool_t bDeduplicate; /* destination has dedup enabled */
}archDetailCG;

/*-----+
| Type definition for Backup Copy Group details on Query MC response |
+-----*/
typedef struct S_backupDetailCG
{
    char cgName[DSM_MAX_CG_NAME_LENGTH + 1]; /* Copy group name */
    dsUInt16_t frequency; /* Backup frequency */
    dsUInt16_t verDataExst; /* Versions data exists */
    dsUInt16_t verDataDltd; /* Versions data deleted */
    dsUInt16_t retXtraVers; /* Retain extra versions */
    dsUInt16_t retOnlyVers; /* Retain only versions */
    dsUInt8_t copySer; /* for copy serialization values, see defines */
    dsUInt8_t copyMode; /* for copy mode values, see defines above */
    char destName[DSM_MAX_CG_DEST_LENGTH + 1]; /* Copy dest name */
    dsMBool_t bLanFreeDest; /* Destination has lan free path? */
    dsMBool_t reserved; /* Not currently used */
    dsMBool_t bDeduplicate; /* destination has dedup enabled */
}backupDetailCG;

/*-----+
| Type definition for Query Mgmt Class detail response on dsmGetNextQObj() |
+-----*/
typedef struct S_qryRespMCDetailData
{
    dsUInt16_t stVersion; /* structure version */
    char mcName[DSM_MAX_MC_NAME_LENGTH + 1]; /* mc name */

```

```

    char          mcDesc[DSM_MAX_MC_DESCR_LENGTH + 1]; /*mc description */
    archDetailCG  archDet;                          /* Archive copy group detail */
    backupDetailCG backupDet;                        /* Backup copy group detail */
}qryRespMCDetailData;

#define qryRespMCDetailDataVersion 4

/*-----+
| Type definition for Query Mgmt Class summary response on dsmGetNextQObj() |
+-----*/
typedef struct S_qryRespMCData
{
    dsUInt16_t    stVersion;                          /* structure version */
    char          mcName[DSM_MAX_MC_NAME_LENGTH + 1]; /* mc name */
    char          mcDesc[DSM_MAX_MC_DESCR_LENGTH + 1]; /* mc description */
}qryRespMCData;

#define qryRespMCDataVersion 1

/*-----+
| Type definition for Archive queryBuffer on dsmBeginQuery() |
+-----*/
typedef struct S_qryArchiveData
{
    dsUInt16_t    stVersion;                          /* structure version */
    dsmObjName    *objName;                          /* Full dsm name of object */
    char          *owner;                             /* owner name */
    /* for maximum date boundaries, see defines above */
    dsmDate       insDateLowerBound;                 /* low bound archive insert date */
    dsmDate       insDateUpperBound;                 /* hi bound archive insert date */
    dsmDate       expDateLowerBound;                 /* low bound expiration date */
    dsmDate       expDateUpperBound;                 /* hi bound expiration date */
    char          *descr;                            /* archive description */
} qryArchiveData;

#define qryArchiveDataVersion 1

/*=== values for retentionInitiated field ===*/
#define DSM_ARCH_RETINIT_UNKNOWN 0 /* ret init is unknown (down-level srv) */
#define DSM_ARCH_RETINIT_STARTED 1 /* retention clock is started */
#define DSM_ARCH_RETINIT_PENDING 2 /* retention clock is not started */

/*=== Values for objHeld ===*/
#define DSM_ARCH_HELD_UNKNOWN 0 /* unknown hold status (down-level srv) */
#define DSM_ARCH_HELD_FALSE 1 /* object is NOT in a delete hold state */
#define DSM_ARCH_HELD_TRUE 2 /* object is in a delete hold state */

/*-----+
| Type definition for Query Archive response on dsmGetNextQObj() |
+-----*/
typedef struct S_qryRespArchiveData
{
    dsUInt16_t    stVersion;                          /* structure version */
    dsmObjName    objName;                          /* Filespace name qualifier */
    dsUInt32_t    copyGroup;                         /* copy group number */
    char          mcName[DSM_MAX_MC_NAME_LENGTH + 1]; /* mc name */
    char          owner[DSM_MAX_OWNER_LENGTH + 1];  /* owner name */
    dsStruct64_t  objId;                             /* Unique copy id */
    dsStruct64_t  reserved;                          /* backward compatability */
    dsUInt8_t     mediaClass;                        /* media access class */
    dsmDate       insDate;                          /* archive insertion date */
    dsmDate       expDate;                          /* expiration date for object */
    char          descr[DSM_MAX_DESCR_LENGTH + 1];  /* archive description */
    dsUInt16_t    objInfolen;                       /* length of object-dependent info*/
    char          reservedObjInfo[DSM_MAX_OBJINFO_LENGTH]; /*object-dependent info */
    dsUInt160_t   restoreOrderExt;                  /* restore order */
    dsStruct64_t  sizeEstimate;                      /* size estimate stored by user*/
    dsUInt8_t     compressType;                      /* Compression flag*/
    dsUInt8_t     retentionInitiated;               /* object waiting on retention event*/
}

```

```

    dsUInt8_t      objHeld; /*object is on retention "hold" see values above*/
    dsUInt8_t      encryptionType; /* type of encryption */
    dsmBool_t      clientDeduplicated; /* obj deduplicated by API*/
    char           objInfo[DSM_MAX_EXT_OBJINFO_LENGTH]; /*object-dependent info */
    char           compressAlg[DSM_MAX_COMPRESSTYPE_LENGTH + 1]; /* compression algorithm name */
}qryRespArchiveData;

#define qryRespArchiveDataVersion 7

/*-----+
| Type definition for Archive sendBuff parameter on dsmSendObj() |
+-----*/
typedef struct S_sndArchiveData
{
    dsUInt16_t     stVersion; /* structure version */
    char           *descr; /* archive description */
}sndArchiveData;

#define sndArchiveDataVersion 1

/*-----+
| Type definition for Backup queryBuffer on dsmBeginQuery() |
+-----*/
typedef struct S_qryBackupData
{
    dsUInt16_t     stVersion; /* structure version */
    dsmObjName     *objName; /* full dsm name of object */
    char           *owner; /* owner name */
    dsUInt8_t      objState; /* object state selector */
    dsmDate        pitDate; /* Date value for point in time restore */
/* for possible values, see defines above */
}qryBackupData;

#define qryBackupDataVersion 2

typedef struct
{
    dsUInt8_t      reserved1;
    dsStruct64_t   reserved2;
} reservedInfo_t; /* for future use */

/*-----+
| Type definition for Query Backup response on dsmGetNextQObj() |
+-----*/
typedef struct S_qryRespBackupData
{
    dsUInt16_t     stVersion; /* structure version */
    dsmObjName     objName; /* full dsm name of object */
    dsUInt32_t     copyGroup; /* copy group number */
    char           mcName[DSM_MAX_MC_NAME_LENGTH + 1]; /* mc name */
    char           owner[DSM_MAX_OWNER_LENGTH + 1]; /* owner name */
    dsStruct64_t   objId; /* Unique object id */
    dsStruct64_t   reserved; /* backward compatability */
    dsUInt8_t      mediaClass; /* media access class */
    dsUInt8_t      objState; /* Obj state, active, etc. */
    dsmDate        insDate; /* backup insertion date */
    dsmDate        expDate; /* expiration date for object */
    dsUInt16_t     objInfolen; /* length of object-dependent info*/
    char           reservedObjInfo[DSM_MAX_OBJINFO_LENGTH]; /*object-dependent info */
    dsUInt160_t    restoreOrderExt; /* restore order */
    dsStruct64_t   sizeEstimate; /* size estimate stored by user */
    dsStruct64_t   baseObjId;
    dsUInt16_t     baseObjInfolen; /* length of base object-dependent info*/
    dsUInt8_t      baseObjInfo[DSM_MAX_OBJINFO_LENGTH]; /* base object-dependent info */
    dsUInt160_t    baseRestoreOrder; /* restore order */
    dsUInt32_t     fsID;
    dsUInt8_t      compressType;
    dsmBool_t      isGroupLeader;
    dsmBool_t      isOpenGroup;
    dsUInt8_t      reserved1; /* for future use */
    dsmBool_t      reserved2; /* for future use */
    dsUInt16_t     reserved3; /* for future use */
    reservedInfo_t *reserved4; /* for future use */
    dsUInt8_t      encryptionType; /* type of encryption */
}

```

```

    dsmBool_t      clientDeduplicated;      /* obj deduplicated by API*/
    char           objInfo[DSM_MAX_EXT_OBJINFO_LENGTH]; /*object-dependent info */
    char           compressAlg[DSM_MAX_COMPRESSTYPE_LENGTH + 1]; /* compression algorithm name */
}qryRespBackupData;

#define qryRespBackupDataVersion 8

/*-----+
| Type definition for Active Backup queryBuffer on dsmBeginQuery()
|
| Notes: For the active backup query, only the fs (filesystem) and objType
|        fields of objName need be set. objType can only be set to
|        DSM_OBJ_FILE or DSM_OBJ_DIRECTORY. DSM_OBJ_ANY_TYPE will not
|        find a match on the query.
|-----*/
typedef struct S_qryABackupData
{
    dsUInt16_t      stVersion;                /* structure version */
    dsmObjName      *objName;                /* Only fs and objtype used */
}qryABackupData;

#define qryABackupDataVersion 1

/*-----+
| Type definition for Query Active Backup response on dsmGetNextQObj()
|-----*/
typedef struct S_qryARespBackupData
{
    dsUInt16_t      stVersion;                /* structure version */
    dsmObjName      objName;                /* full dsm name of object */
    dsUInt32_t      copyGroup;              /* copy group number */
    char            mcName[DSM_MAX_MC_NAME_LENGTH + 1]; /*management class name*/
    char            owner[DSM_MAX_OWNER_LENGTH + 1]; /* owner name */
    dsmDate         insDate;                /* backup insertion date */
    dsUInt16_t      objInfolen;            /* length of object-dependent info*/
    char            reservedObjInfo[DSM_MAX_OBJINFO_LENGTH]; /*object-dependent info */
    char            objInfo[DSM_MAX_EXT_OBJINFO_LENGTH]; /*object-dependent info */
}qryARespBackupData;

#define qryARespBackupDataVersion 2

/*-----+
| Type definition for Backup queryBuffer on dsmBeginQuery()
|-----*/
typedef struct qryBackupGroups
{
    dsUInt16_t      stVersion;                /* structure version */
    dsUInt8_t       groupType;
    char            *fsName;
    char            *owner;
    dsStruct64_t    groupLeaderObjId;
    dsUInt8_t       objType;
    dsmBool_t       noRestoreOrder;
    dsmBool_t       noGroupInfo;
    char            *hl;
}qryBackupGroups;

#define qryBackupGroupsVersion 3

/*-----+
| Type definition for proxynode queryBuffer on dsmBeginQuery()
|-----*/
typedef struct qryProxyNodeData
{
    dsUInt16_t      stVersion;                /* structure version */
    char            *targetNodeName;        /* target node name */
}qryProxyNodeData;

#define qryProxyNodeDataVersion 1

/*-----+
| Type definition for qryRespProxyNodeData parameter used on dsmGetNextQObj()
|-----*/

```

```

typedef struct
{
    dsUInt16_t    stVersion ;                /* structure version */
    char          targetNodeName[DSM_MAX_ID_LENGTH+1]; /* target node name */
    char          peerNodeName[DSM_MAX_ID_LENGTH+1]; /* Peer node name */
    char          hlAddress[DSM_MAX_ID_LENGTH+1]; /* peer hlAddress */
    char          llAddress[DSM_MAX_ID_LENGTH+1]; /* peer hlAddress */
}qryRespProxyNodeData;

#define qryRespProxyNodeDataVersion 1

/*-----+
| Type definition for WINNT and OS/2 Filespace attributes |
+-----*/
typedef struct
{
    char          driveLetter ;              /* drive letter for filespace */
    dsUInt16_t    fsInfoLength;             /* fsInfo length used */
    char          fsInfo[DSM_MAX_FSINFO_LENGTH]; /* caller-determined data */
}dsmDosFSAttrib ;

/*-----+
| Type definition for UNIX Filespace attributes |
+-----*/
typedef struct
{
    dsUInt16_t    fsInfoLength;             /* fsInfo length used */
    char          fsInfo[DSM_MAX_FSINFO_LENGTH]; /* caller-determined data */
}dsmUnixFSAttrib ;

/*-----+
| Type definition for NetWare Filespace attributes |
+-----*/
typedef dsmUnixFSAttrib dsmNetwareFSAttrib;

/*-----+
| Type definition for Filespace attributes on all Filespace calls |
+-----*/
typedef union
{
    dsmNetwareFSAttrib  netwareFSAttr;
    dsmUnixFSAttrib     unixFSAttr ;
    dsmDosFSAttrib      dosFSAttr ;
}dsmFSAttr ;

/*-----+
| Type definition for fsUpd parameter on dsmUpdateFS() |
+-----*/
typedef struct S_dsmFSUpd
{
    dsUInt16_t    stVersion ;                /* structure version */
    char          *fsType ;                  /* filespace type */
    dsStruct64_t  occupancy ;                /* occupancy estimate */
    dsStruct64_t  capacity ;                 /* capacity estimate */
    dsmFSAttr     fsAttr ;                  /* platform specific attributes */
}dsmFSUpd ;

#define dsmFSUpdVersion 1

/*-----+
| Type definition for Filespace queryBuffer on dsmBeginQuery() |
+-----*/
typedef struct S_qryFSData
{
    dsUInt16_t    stVersion;                /* structure version */
    char          *fsName;                  /* File space name */
}qryFSData;

#define qryFSDataVersion 1

/*-----+
| Type definition for Query Filespace response on dsmGetNextQObj() |

```

```

+-----*/
typedef struct S_qryRespFSDData
{
    dsUInt16_t    stVersion;                /* structure version */
    char          fsName[DSM_MAX_FSNAME_LENGTH + 1]; /* Filespace name */
    char          fsType[DSM_MAX_FSTYPE_LENGTH + 1]; /* Filespace type */
    dsStruct64_t  occupancy;                /* Occupancy est. in bytes.*/
    dsStruct64_t  capacity;                /* Capacity est. in bytes.*/
    dsmFSAttr     fsAttr ;                 /* platform specific attributes */
    dsmDate       backStartDate;           /* start backup date */
    dsmDate       backCompleteDate;       /* end backup Date */
    dsmDate       reserved1;              /* For future use */
    dsmDate       lastReplStartDate;      /* The last time replication was started */
    dsmDate       lastReplCmpltDate;     /* The last time replication completed */
                                           /* (could have had a failure, */
                                           /* but it still completes) */
    dsmDate       lastBackOpDateFromServer; /* The last store time stamp the client */
                                           /* saved on the server */
    dsmDate       lastArchOpDateFromServer; /* The last store time stamp the client */
                                           /* saved on the server */
    dsmDate       lastSpMgOpDateFromServer; /* The last store time stamp the client */
                                           /* saved on the server */
    dsmDate       lastBackOpDateFromLocal; /* The last store time stamp the client */
                                           /* saved on the Local */
    dsmDate       lastArchOpDateFromLocal; /* The last store time stamp the client */
                                           /* saved on the Local */
    dsmDate       lastSpMgOpDateFromLocal; /* The last store time stamp the client */
                                           /* saved on the Local */
    dsInt32_t     failOverWriteDelay;     /* Minutes for client to wait before allowed */
                                           /* to store to this Repl srvr, Specail codes: */
                                           /* NO_ACCESS(-1), ACCESS_RDONLY (-2) */
}qryRespFSDData;

#define qryRespFSDDataVersion 4

/*-----+
| Type definition for regFilespace parameter on dsmRegisterFS()
+-----*/
typedef struct S_regFSDData
{
    dsUInt16_t    stVersion;                /* structure version */
    char          *fsName;                 /* Filespace name */
    char          *fsType;                 /* Filespace type */
    dsStruct64_t  occupancy;                /* Occupancy est. in bytes.*/
    dsStruct64_t  capacity;                /* Capacity est. in bytes.*/
    dsmFSAttr     fsAttr ;                 /* platform specific attributes */
}regFSDData;

#define regFSDDataVersion 1

/*-----+
| Type definition for dedupType used in apisessInfo
+-----*/
typedef enum
{
    dedupServerOnly= 0x00,                /* dedup only done on server */
    dedupClientOrServer                    /* dedup can be done on client or server */
}dsmDedupType ;

/*-----+
| Type definition for fail over configuration and status
+-----*/
typedef enum
{
    failOvrNotConfigured = 0x00,
    failOvrConfigured,
    failOvrConnectedToReplServer
}dsmFailOvrCfgType ;

/*-----+
| Type definition for session info response on dsmQuerySessionInfo()
+-----*/
typedef struct
{

```

```

dsUint16_t    stVersion;          /* Structure version          */
/*-----*/
/*          Server information          */
/*-----*/
char          serverHost[DSM_MAX_SERVERNAME_LENGTH+1];
/* Network host name of DSM server */
dsUint16_t    serverPort;         /* Server comm port on host   */
dsmDate       serverDate;         /* Server's date/time         */
char          serverType[DSM_MAX_SERVERTYPE_LENGTH+1];
/* Server's execution platform    */
dsUint16_t    serverVer;          /* Server's version number    */
dsUint16_t    serverRel;         /* Server's release number    */
dsUint16_t    serverLev;         /* Server's level number      */
dsUint16_t    serverSubLev;       /* Server's sublevel number   */
/*-----*/
/*          Client Defaults          */
/*-----*/
char          nodeType[DSM_MAX_PLATFORM_LENGTH+1]; /*node/application type*/
char          fsdelim;           /* File space delimiter       */
char          hldelim;          /* Delimiter betw highlev & lowlev */
dsUint8_t     compression;      /* Compression flag           */
dsUint8_t     archDel;          /* Archive delete permission  */
dsUint8_t     backDel;          /* Backup delete permission   */
dsUint32_t    maxBytesPerTxn;   /* for future use             */
dsUint16_t    maxObjPerTxn;     /* The max objects allowed in a txn */
/*-----*/
/*          Session Information          */
/*-----*/
char          id[DSM_MAX_ID_LENGTH+1]; /* Sign-in id node name      */
char          owner[DSM_MAX_OWNER_LENGTH+1]; /* Sign-in owner            */
/*          (for multi-user platforms) */
char          confFile[DSM_PATH_MAX + DSM_NAME_MAX + 1];
/* len is platform dep           */
/* dsInit name of appl config file */
dsUint8_t     opNoTrace;        /* dsInit option - NoTrace = 1 */
/*-----*/
/*          Policy Data          */
/*-----*/
char          domainName[DSM_MAX_DOMAIN_LENGTH+1]; /* Domain name              */
char          policySetName[DSM_MAX_PS_NAME_LENGTH+1];
/* Active policy set name        */
dsmDate       polActDate;        /* Policy set activation date */
char          dfltMCName[DSM_MAX_MC_NAME_LENGTH+1]; /* Default Mgmt Class      */
dsUint16_t    gpBackRetn;        /* Grace-period backup retention */
dsUint16_t    gpArchRetn;        /* Grace-period archive retention */
char          adsmServerName[DSM_MAX_SERVERNAME_LENGTH+1]; /* adsm server name */
dsmBool_t     archiveRetentionProtection; /* is server Retention protection enabled */
dsStruct64_t  maxBytesPerTxn_64; /* for future use             */
dsmBool_t     lanFreeEnabled;     /* lan free option is set     */
dsmDupType    dedupType;         /* server or clientOrServer   */
char          accessNode[DSM_MAX_ID_LENGTH+1]; /* as node node name        */

/*-----*/
/*          Replication and fail over information          */
/*-----*/
dsmFailOvrCfgType failOverCfgType; /* status of fail over */
char          replServerName[DSM_MAX_SERVERNAME_LENGTH+1]; /* repl server name */
char          homeServerName[DSM_MAX_SERVERNAME_LENGTH+1]; /* home server name */
char          replServerHost[DSM_MAX_SERVERNAME_LENGTH+1]; /* Network host name of DSM server */
*/
dsInt32_t     replServerPort;     /* Server comm port on host   */
*/

}ApiSessInfo;

#define ApiSessInfoVersion 6

/*-----+
| Type definition for Query options response on dsmQueryCliOptions() |
| and dsmQuerySessOptions() |
+-----*/

```

```

typedef struct
{
    char          dsmdir[DSM_PATH_MAX + DSM_NAME_MAX +1];
    char          dsmiConfig[DSM_PATH_MAX + DSM_NAME_MAX +1];
    char          serverName[DSM_MAX_SERVERNAME_LENGTH+1];
    dsInt16_t     commMethod;
    char          serverAddress[DSM_MAX_SERVER_ADDRESS];
    char          nodeName[DSM_MAX_NODE_LENGTH+1];
    dsmBool_t     compression;
    dsmBool_t     compressalways;
    dsmBool_t     passwordAccess;
}optStruct ;

/*-----+
| Type definition for LogType used in logInfo                                     |
+-----*/
typedef enum
{
    logServer = 0x00,          /* log msg only to server      */
    logLocal,                 /* log msg only to local error log */
    logBoth,                  /* log msg to server and to local error log */
    logNone
}dsmLogType ;

/*-----+
| Type definition for logInfo parameter used on dsmLogEvent()                 |
+-----*/

typedef struct
{
    char          *message;    /* text of message to be logged */
    dsmLogType    logType;     /* log type : local, server, both */
}logInfo;

/*-----+
| Type definition for qryRespAccessData parameter used on dsmQueryAccess() |
+-----*/

typedef struct
{
    dsUInt16_t     stVersion ;          /* structure version      */
    char          node[DSM_MAX_ID_LENGTH+1]; /* node name              */
    char          owner[DSM_MAX_OWNER_LENGTH+1]; /* owner                  */
    dsmObjName     objName ;           /* object name            */
    dsmAccessType  accessType;         /* archive or backup     */
    dsUInt32_t     ruleNumber ;        /* Access rule id        */
}qryRespAccessData;

#define qryRespAccessDataVersion 1

/*-----+
| Type definition for envSetUp parameter on dsmSetUp()                       |
+-----*/
typedef struct S_envSetUp
{
    dsUInt16_t     stVersion;          /* structure version */
    char          dsmdir[DSM_PATH_MAX + DSM_NAME_MAX +1];
    char          dsmiConfig[DSM_PATH_MAX + DSM_NAME_MAX +1];
    char          dsmiLog[DSM_PATH_MAX + DSM_NAME_MAX +1];
    char          **argv; /* for executables name argv[0] */
    char          logName[DSM_NAME_MAX +1];
    dsmBool_t     reserved1; /* for future use */
    dsmBool_t     reserved2; /* for future use */
}envSetUp;

#define envSetUpVersion 4

/*-----+
| Type definition for dsmInitExIn_t                                         |
+-----*/
typedef struct dsmInitExIn_t
{
    dsUInt16_t     stVersion;          /* structure version */
    dsmApiVersionEx *apiVersionEx;

```



```

char          *clientNodeNameP;
char          *clientOwnerNameP;
char          *clientPasswordP;
char          *userNameP;
char          *userPasswordP;
char          *applicationTypeP;
char          *configfile;
char          *options;
char          dirDelimiter;
dsmBool_t    useUnicode;
dsmBool_t    bCrossPlatform;
dsmBool_t    bService;
dsmBool_t    bEncryptKeyEnabled;
char          *encryptionPasswordP;
dsmBool_t    useTsmBuffers;
dsUint8_t    numTsmBuffers;
dsmAppVersion *appVersionP;
}dsmInitExIn_t;

#define dsmInitExInVersion 5

/*-----+
| Type definition for dsmInitExOut_t
+-----*/
typedef struct dsmInitExOut_t
{
    dsUint16_t    stVersion;          /* structure version */
    dsInt16_t     userNameAuthorities;
    dsInt16_t     infoRC;            /* error return code if encountered */
    char          adsmServerName[DSM_MAX_SERVERNAME_LENGTH+1];
    dsUint16_t    serverVer;         /* Server's version number */
    dsUint16_t    serverRel;         /* Server's release number */
    dsUint16_t    serverLev;         /* Server's level number */
    dsUint16_t    serverSubLev;     /* Server's sublevel number */

    dsmBool_t     bIsFailOverMode; /* true if failover has occured */
    char          replServerName[DSM_MAX_SERVERNAME_LENGTH+1]; /* repl server name */
    char          homeServerName[DSM_MAX_SERVERNAME_LENGTH+1]; /* home server name */
}dsmInitExOut_t;

#define dsmInitExOutVersion 3

/*-----+
| Type definition for LogType used in logInfo
+-----*/
typedef enum
{
    logSevInfo = 0x00,             /* information ANE4991 */
    logSevWarning,                 /* warning ANE4992 */
    logSevError,                   /* Error ANE4993 */
    logSevSevere,                  /* severe ANE4994 */
    logSevLicense,                 /* License ANE4995 */
    logSevTryBuy                   /* try Buy ANE4996 */
}dsmLogSeverity ;

/*-----+
| Type definition for dsmLogExIn_t
+-----*/
typedef struct dsmLogExIn_t
{
    dsUint16_t    stVersion; /* structure version */
    dsmLogSeverity severity;
    char          appMsgID[8];
    dsmLogType    logType; /* log type : local, server, both */
    char          *message; /* text of message to be logged */
    char          appName[DSM_MAX_PLATFORM_LENGTH];
    char          osPlatform[DSM_MAX_PLATFORM_LENGTH];
    char          appVersion[DSM_MAX_PLATFORM_LENGTH];
}dsmLogExIn_t;

#define dsmLogExInVersion 2

```

```

/*-----+
| Type definition for dsmLogExOut_t
+-----*/
typedef struct dsmLogExOut_t
{
    dsUInt16_t          stVersion; /* structure version */
}dsmLogExOut_t;

#define dsmLogExOutVersion 1

/*-----+
| Type definition for dsmRenameIn_t
+-----*/
typedef struct dsmRenameIn_t
{
    dsUInt16_t          stVersion; /* structure version */
    dsUInt32_t          dsmHandle; /* handle for session */
    dsUInt8_t           repository; /* Backup or Archive */
    dsmObjNameP         *objNameP ; /* object name */
    char                newHl[DSM_MAX_HL_LENGTH + 1]; /* new High level name */
    char                newLl[DSM_MAX_LL_LENGTH + 1]; /* new Low level name */
    dsmBool_t           merge; /* merge into existing name*/
    ObjID               objId; /* objId for Archive */
}dsmRenameIn_t;

#define dsmRenameInVersion 1

/*-----+
| Type definition for dsmRenameOut_t
+-----*/
typedef struct dsmRenameOut_t
{
    dsUInt16_t          stVersion; /* structure version */
}dsmRenameOut_t;

#define dsmRenameOutVersion 1

/*-----+
| Type definition for dsmEndSendObjExIn_t
+-----*/
typedef struct dsmEndSendObjExIn_t
{
    dsUInt16_t          stVersion; /* structure version */
    dsUInt32_t          dsmHandle; /* handle for session */
}dsmEndSendObjExIn_t;

#define dsmEndSendObjExInVersion 1

/*-----+
| Type definition for dsmEndSendObjExOut_t
+-----*/
typedef struct dsmEndSendObjExOut_t
{
    dsUInt16_t          stVersion; /* structure version */
    dsStruct64_t        totalBytesSent; /* total bytes read from app */
    dsmBool_t           objCompressed; /* was object compressed */
    dsStruct64_t        totalCompressSize; /* total size after compress */
    dsStruct64_t        totalLFBytesSent; /* total bytes sent Lan Free */
    dsUInt8_t           encryptionType; /* type of encryption used */
    dsmBool_t           objDeduplicated; /* was object processed for dist. data dedup */
    dsStruct64_t        totalDedupSize; /* total size after de-dup */
}dsmEndSendObjExOut_t;

#define dsmEndSendObjExOutVersion 3

/*-----+
| Type definition for dsmGroupHandlerIn_t
+-----*/
typedef struct dsmGroupHandlerIn_t
{
    dsUInt16_t          stVersion; /* structure version */
    dsUInt32_t          dsmHandle; /* handle for session */
    dsUInt8_t           groupType; /* Type of group */
    dsUInt8_t           actionType; /* Type of group operation */
    dsUInt8_t           memberType; /* Type of member: Leader or member */
}

```

```

    dsStruct64_t    leaderObjId;    /* OBJID of the groupleader when manipulating a member */
    char            *uniqueGroupTagP; /* Unique group identifier */
    dsmObjName     *objNameP;      /* group leader object name */
    dsmGetList     memberObjList;  /* list of objects to remove, assign */
}dsmGroupHandlerIn_t;

#define dsmGroupHandlerInVersion 1

/*-----+
| Type definition for dsmGroupHandlerExOut_t
+-----*/
typedef struct dsmGroupHandlerOut_t
{
    dsUInt16_t      stVersion;      /* structure version */
}dsmGroupHandlerOut_t;

#define dsmGroupHandlerOutVersion 1

/*-----+
| Type definition for dsmEndTxnExIn_t
+-----*/
typedef struct dsmEndTxnExIn_t
{
    dsUInt16_t      stVersion;      /* structure version */
    dsUInt32_t      dsmHandle;      /* handle for session */
    dsUInt8_t       vote;
}dsmEndTxnExIn_t;

#define dsmEndTxnExInVersion 1

/*-----+
| Type definition for dsmEndTxnExOut_t
+-----*/
typedef struct dsmEndTxnExOut_t
{
    dsUInt16_t      stVersion;      /* structure version */
    dsUInt16_t      reason;         /* reason code */
    dsStruct64_t    groupLeaderObjId; /* groupLeader obj id returned on */
                                     /* DSM_ACTION_OPEN */
    dsUInt8_t       reserved1;     /* future use */
    dsUInt16_t      reserved2;     /* future use */
}dsmEndTxnExOut_t;

#define dsmEndTxnExOutVersion 1

/*-----+
| Type definition for dsmEndGetDataExIn_t
+-----*/
typedef struct dsmEndGetDataExIn_t
{
    dsUInt16_t      stVersion;      /* structure version */
    dsUInt32_t      dsmHandle;      /* handle for session */
}dsmEndGetDataExIn_t;

#define dsmEndGetDataExInVersion 1

/*-----+
| Type definition for dsmEndGetDataExOut_t
+-----*/
typedef struct dsmEndGetDataExOut_t
{
    dsUInt16_t      stVersion;      /* structure version */
    dsUInt16_t      reason;         /* reason code */
    dsStruct64_t    totalLFBBytesRecv; /* total lan free bytes recieved */
}dsmEndGetDataExOut_t;

#define dsmEndGetDataExOutVersion 1

/*-----+
| Type definition for object list on dsmRetentionEvent()
+-----*/
typedef struct dsmObjList
{
    dsUInt16_t      stVersion;      /* structure version */

```

```

    dsUInt32_t      numObjId;          /* number of object IDs in the list */
    ObjID           *objId;           /* list of object IDs to signal */
}dsmObjList_t ;

#define dsmObjlistVersion 1

/*-----+
| Type definition eventType used on dsmRetentionEvent |
+-----*/
typedef enum
{
    eventRetentionActivate = 0x00,    /* signal the server that the event has occurred */
    eventHoldObj,                    /* suspend delete/expire of the object */
    eventReleaseObj                  /* Resume normal delete/expire processing */
}dsmEventType_t;

/*-----+
| Type definition for on dsmRetentionEvent() |
+-----*/
typedef struct dsmRetentionEventIn_t
{
    dsUInt16_t      stVersion;          /* structure version */
    dsUInt32_t      dsmHandle;          /* session Handle */
    dsmEventType_t  eventType;          /* Event type */
    dsmObjList_t    objList;           /* object ID */
}dsmRetentionEventIn_t;

#define dsmRetentionEventInVersion 1

/*-----+
| Type definition for on dsmRetentionEvent() |
+-----*/
typedef struct dsmRetentionEventOut_t
{
    dsUInt16_t      stVersion ;          /* structure version */
}dsmRetentionEventOut_t;

#define dsmRetentionEventOutVersion 1

/*-----+
| Type definition for on dsmRequestBuffer() |
+-----*/
typedef struct requestBufferIn_t
{
    dsUInt16_t      stVersion;          /* structure version */
    dsUInt32_t      dsmHandle;          /* session Handle */
}requestBufferIn_t;

#define requestBufferInVersion 1

/*-----+
| Type definition for on dsmRequestBuffer() |
+-----*/
typedef struct requestBufferOut_t
{
    dsUInt16_t      stVersion ;          /* structure version */
    dsUInt8_t       tsmBufferHandle;     /* handle to tsm Data buffer */
    char            *dataPtr;           /* Address to write data to */
    dsUInt32_t      bufferLen;          /* Max length of data to be written */
}requestBufferOut_t;

#define requestBufferOutVersion 1

/*-----+
| Type definition for on dsmReleaseBuffer() |
+-----*/
typedef struct releaseBufferIn_t
{
    dsUInt16_t      stVersion;          /* structure version */
    dsUInt32_t      dsmHandle;          /* session Handle */
    dsUInt8_t       tsmBufferHandle;     /* handle to tsm Data buffer */
    char            *dataPtr;           /* Address to write data to */
}releaseBufferIn_t;

```

```

#define releaseBufferInVersion 1

/*-----+
| Type definition for on dsmReleaseBuffer() |
+-----*/
typedef struct releaseBufferOut_t
{
    dsUInt16_t      stVersion ;                /* structure version */
}releaseBufferOut_t;

#define releaseBufferOutVersion 1

/*-----+
| Type definition for on dsmGetBufferData() |
+-----*/
typedef struct getBufferDataIn_t
{
    dsUInt16_t      stVersion;                /* structure version */
    dsUInt32_t      dsmHandle;                /* session Handle */
}getBufferDataIn_t;

#define getBufferDataInVersion 1

/*-----+
| Type definition for on dsmGetBufferData() |
+-----*/
typedef struct getBufferDataOut_t
{
    dsUInt16_t      stVersion ;                /* structure version */
    dsUInt8_t       tsmBufferHandle;          /* handle to tsm Data buffer */
    char            *dataPtr;                 /* Address of actual data to read */
    dsUInt32_t      numBytes;                 /* Actual number of bytes to read from dataPtr*/
}getBufferDataOut_t;

#define getBufferDataOutVersion 1

/*-----+
| Type definition for on dsmSendBufferData() |
+-----*/
typedef struct sendBufferDataIn_t
{
    dsUInt16_t      stVersion;                /* structure version */
    dsUInt32_t      dsmHandle;                /* session Handle */
    dsUInt8_t       tsmBufferHandle;          /* handle to tsm Data buffer */
    char            *dataPtr;                 /* Address of actual data to send */
    dsUInt32_t      numBytes;                 /* Actual number of bytes to send from dataPtr*/
}sendBufferDataIn_t;

#define sendBufferDataInVersion 1

/*-----+
| Type definition for on dsmSendBufferData() |
+-----*/
typedef struct sendBufferDataOut_t
{
    dsUInt16_t      stVersion ;                /* structure version */
}sendBufferDataOut_t;

#define sendBufferDataOutVersion 1

/*-----+
| Type definition for dsmUpdateObjExIn_t |
+-----*/
typedef struct dsmUpdateObjExIn_t
{
    dsUInt16_t      stVersion;                /* structure version */
    dsUInt32_t      dsmHandle;                /* session Handle */
    dsmSendType     sendType;                 /* send type back/arch */
    char            *descrP;                  /* archive description */
    dsmObjName      *objNameP;               /* objName */
    ObjAttr         *objAttrPtr;             /* attribute */
    dsUInt32_t      objUpdAct;                /* update action */
    ObjID           archObjId;                /* objId for archive */
}

```

```

}dsmUpdateObjExIn_t;

#define dsmUpdateObjExInVersion 1

/*-----+
| Type definition for dsmUpdateObjExOut_t
+-----*/
typedef struct dsmUpdateObjExOut_t
{
    dsUint16_t      stVersion;      /* structure version */
}dsmUpdateObjExOut_t;

#define dsmUpdateObjExOutVersion 1

#if (_OPSYS_TYPE == DS_WINNT) && !defined(_WIN64)
#pragma pack()
#endif

#ifdef _MAC
#pragma options align=reset
#endif
#endif /* _H_DSMAPITD */

/*****
 * Tivoli Storage Manager
 * API Client Component
 *
 * (C) Copyright IBM Corporation 1993,2010
 *****/

/*****
 * Header File Name: tsmapitd.h
 *
 * Environment:
 * *****
 * ** This is a platform-independent source file **
 * *****
 *
 * Design Notes: This file contains basic data types and constants
 *               includable by all client source files. The constants
 *               within this file should be set properly for the
 *               particular machine and operating system on which the
 *               client software is to be run.
 *
 *               Platform specific definitions are included in dsmapips.h
 *
 * Descriptive-name: Definitions for Tivoli Storage manager API constants
 *-----*/

#ifdef _H_TSMAPITD
#define _H_TSMAPITD

/*=== set the structure alignment to pack the structures ===*/
#if _OPSYS_TYPE == DS_WINNT
#ifdef _WIN64
#pragma pack(8)
#else
#pragma pack(1)
#endif
#endif

#ifdef _MAC
#pragma options align = packed
#endif

/*=====
Win32 applications using the tsm interface must use the
-DUNICODE flag during compilation.
=====*/
#if _OPSYS_TYPE == DS_WINNT && !defined(DSMAPILIB)

```

```

#ifndef UNICODE
#error "Win32 applications using the TSM interface MUST be compiled with the -DUNICODE flag"
#endif
#endif

/*=====
Mac OS X applications using the tsm interface must use the
-DUNICODE flag during compilation.
=====*/
#if _OPSYS_TYPE == DS_MACOS && !defined(DSMAPILIB)
#ifndef UNICODE
#error "Mac OS X applications using the TSM interface MUST be compiled with the -DUNICODE flag"
#endif
#endif

/*-----+
| Type definition for dsmGetType parameter on tsmBeginGetData() |
+-----*/
typedef enum
{
    gtTsmBackup = 0x00,          /* Backup processing type */
    gtTsmArchive          /* Archive processing type */
} tsmGetType ;

/*-----+
| Type definition for dsmQueryType parameter on tsmBeginQuery() |
+-----*/
typedef enum
{
    qtTsmArchive = 0x00,          /* Archive query type */
    qtTsmBackup,                /* Backup query type */
    qtTsmBackupActive,          /* Fast query for active backup files */
    qtTsmFilespace,            /* Filespace query type */
    qtTsmMC,                    /* Mgmt. class query type */
    qtTsmReserved1,            /* future use */
    qtTsmReserved2,            /* future use */
    qtTsmReserved3,            /* future use */
    qtTsmReserved4,            /* future use */
    qtTsmBackupGroups,          /* All group leaders in a specific filesystem */
    qtTsmOpenGroups,           /* All group members associated with a leader */
    qtTsmReserved5,            /* future use */
    qtTsmProxyNodeAuth,         /* nodes that this node can proxy to */
    qtTsmProxyNodePeer,         /* peer nodes under this target node */
    qtTsmReserved6,            /* future use */
    qtTsmReserved7,            /* future use */
    qtTsmReserved8,            /* future use */
} tsmQueryType ;

/*-----+
| Type definition sendType parameter on tsmBindMC() and tsmSendObj() |
+-----*/
typedef enum
{
    stTsmBackup = 0x00,          /* Backup processing type */
    stTsmArchive,                /* Archive processing type */
    stTsmBackupMountWait,        /* Backup processing with mountwait on */
    stTsmArchiveMountWait        /* Archive processing with mountwait on */
} tsmSendType ;

/*-----+
| Type definition for delType parameter on tsmDeleteObj() |
+-----*/
typedef enum
{
    dtTsmArchive = 0x00,          /* Archive delete type */
    dtTsmBackup,                /* Backup delete (deactivate) type */
    dtTsmBackupID                /* Backup delete (remove) type */
} tsmDelType ;

/*-----+
| Type definition sendType parameter on tsmSetAccess() |
+-----*/
typedef enum
{

```

```

        atTsmBackup = 0x00,                /* Backup processing type */
        atTsmArchive /* Archive processing type */
}tsmAccessType;

/*-----+
| Type definition for Overwrite parameter on tsmSendObj() |
+-----*/
typedef enum
{
    owIGNORE = 0x00,
    owYES,
    owNO
}tsmOwType;

/*-----+
| Type definition for API Version on tsmInit() and tsmQueryApiVersion() |
+-----*/
typedef struct
{
    dsUInt16_t stVersion; /* Structure version */
    dsUInt16_t version; /* API version */
    dsUInt16_t release; /* API release */
    dsUInt16_t level; /* API level */
    dsUInt16_t subLevel; /* API sub level */
    dsmBool_t unicode; /* API unicode? */
} tsmApiVersionEx;

#define tsmApiVersionExVer 2

/*-----+
| Type definition for Application Version on tsmInit() |
+-----*/
typedef struct
{
    dsUInt16_t stVersion; /* Structure version */
    dsUInt16_t applicationVersion; /* application version number */
    dsUInt16_t applicationRelease; /* application release number */
    dsUInt16_t applicationLevel; /* application level number */
    dsUInt16_t applicationSubLevel; /* application sub level number */
} tsmAppVersion;

#define tsmAppVersionVer 1

/*-----+
| Type definition for object name used on BindMC, Send, Delete, Query |
+-----*/

typedef struct tsmObjName
{
    dsChar_t fs[DSM_MAX_FSNAME_LENGTH + 1]; /* Filespace name */
    dsChar_t hl[DSM_MAX_HL_LENGTH + 1]; /* High level name */
    dsChar_t ll[DSM_MAX_LL_LENGTH + 1]; /* Low level name */
    dsUInt8_t objType; /* for object type values, see defines above */
    dsChar_t dirDelimiter;
} tsmObjName;

/*-----+
| Type definition for Backup delete info on dsmDeleteObj() |
+-----*/
typedef struct tsmDelBack
{
    dsUInt16_t stVersion; /* structure version */
    tsmObjName *objNameP; /* object name */
    dsUInt32_t copyGroup; /* copy group */
} tsmDelBack;

#define tsmDelBackVersion 1

/*-----+
| Type definition for Archive delete info on dsmDeleteObj() |
+-----*/
typedef struct

```



```

{
    dsUInt16_t      stVersion ;                               /* structure version      */
    dsStruct64_t   objId ;                                   /* object ID              */
} tsmDelArch ;

#define tsmDelArchVersion 1

/*-----+
| Type definition for Backup ID delete info on dsmDeleteObj() |
+-----*/
typedef struct
{
    dsUInt16_t      stVersion ;                               /* structure version      */
    dsStruct64_t   objId ;                                   /* object ID              */
} tsmDelBackID;

#define tsmDelBackIDVersion 1

/*-----+
| Type definition for delete info on dsmDeleteObj() |
+-----*/
typedef union
{
    tsmDelBack    backInfo ;
    tsmDelArch    archInfo ;
    tsmDelBackID  backIDInfo;
} tsmDelInfo ;

/*-----+
| Type definition for Object Attribute parameter on dsmSendObj() |
+-----*/
typedef struct tsmObjAttr
{
    dsUInt16_t      stVersion;                               /* Structure version      */
    dsChar_t        owner[DSM_MAX_OWNER_LENGTH + 1];        /* object owner          */
    dsStruct64_t    sizeEstimate;                            /* Size estimate in bytes of the object */
    dsmBool_t       objCompressed;                          /* Is object already compressed? */
    dsUInt16_t      objInfoLength;                          /* length of object-dependent info */
    char            *objInfo;                               /* object-dependent info byte buffer */
    dsChar_t        *mcNameP;                               /* mgmnt class name for override */
    tsmOwType       reserved1;                              /* for future use        */
    tsmOwType       reserved2;                              /* for future use        */
    dsmBool_t       disableDeduplication;                   /* force no dedup for this object */
    dsmBool_t       useExtObjInfo;                          /* use ext objinfo up to 1536 */
} tsmObjAttr;

#define tsmObjAttrVersion 5

/*-----+
| Type definition for mcBindKey returned on dsmBindMC() |
+-----*/
typedef struct tsmMcBindKey
{
    dsUInt16_t      stVersion;                               /* structure version      */
    dsChar_t        mcName[DSM_MAX_MC_NAME_LENGTH + 1];    /* Name of mc bound to object. */
    dsmBool_t       backup_cg_exists;                       /* True/false */
    dsmBool_t       archive_cg_exists;                      /* True/false */
    dsChar_t        backup_copy_dest[DSM_MAX_CG_DEST_LENGTH + 1];
    /* Backup copy dest. name */
    dsChar_t        archive_copy_dest[DSM_MAX_CG_DEST_LENGTH + 1];
    /* Arch copy dest.name */
} tsmMcBindKey;

#define tsmMcBindKeyVersion 1

/*-----+
| Type definition for Mgmt Class queryBuffer on dsmBeginQuery() |
+-----*/
typedef struct tsmQryMCData
{
    dsUInt16_t      stVersion;                               /* structure version */

```

```

    dsChar_t      *mcName;                /* Mgmt class name */
    /* single name to get one or empty string to get all*/
    dsmBool_t     mcDetail;               /* Want details or not? */
} tsmQryMCData;

#define tsmQryMCDataVersion 1

/*-----+
| Type definition for Archive Copy Group details on Query MC response |
+-----*/
typedef struct tsmArchDetailCG
{
    dsChar_t      cgName[DSM_MAX_CG_NAME_LENGTH + 1];    /* Copy group name */
    dsUInt16_t    frequency;                             /* Copy (archive) frequency */
    dsUInt16_t    retainVers;                            /* Retain version */
    dsUInt8_t     copySer;                               /* for copy serialization values, see defines */
    dsUInt8_t     copyMode;                             /* for copy mode values, see defines above */
    dsChar_t      destName[DSM_MAX_CG_DEST_LENGTH + 1];  /* Copy dest name */
    dsmBool_t     bLanFreeDest;                         /* Destination has lan free path? */
    dsmBool_t     reserved;                             /* Not currently used */
    dsUInt8_t     retainInit;                           /* possible values see dsmapi.td.h */
    dsUInt16_t    retainMin;                            /* if retInit is EVENT num of days */
    dsmBool_t     bDeduplicate;                         /* destination has dedup enabled */
} tsmArchDetailCG;

/*-----+
| Type definition for Backup Copy Group details on Query MC response |
+-----*/
typedef struct tsmBackupDetailCG
{
    dsChar_t      cgName[DSM_MAX_CG_NAME_LENGTH + 1];    /* Copy group name */
    dsUInt16_t    frequency;                             /* Backup frequency */
    dsUInt16_t    verDataExst;                          /* Versions data exists */
    dsUInt16_t    verDataDltd;                          /* Versions data deleted */
    dsUInt16_t    retXtraVers;                          /* Retain extra versions */
    dsUInt16_t    retOnlyVers;                         /* Retain only versions */
    dsUInt8_t     copySer;                               /* for copy serialization values, see defines */
    dsUInt8_t     copyMode;                             /* for copy mode values, see defines above */
    dsChar_t      destName[DSM_MAX_CG_DEST_LENGTH + 1];  /* Copy dest name */
    dsmBool_t     bLanFreeDest;                         /* Destination has lan free path? */
    dsmBool_t     reserved;                             /* Not currently used */
    dsmBool_t     bDeduplicate;                         /* destination has dedup enabled */
} tsmBackupDetailCG;

/*-----+
| Type definition for Query Mgmt Class detail response on dsmGetNextQObj() |
+-----*/
typedef struct tsmQryRespMCDetailData
{
    dsUInt16_t     stVersion;                            /* structure version */
    dsChar_t       mcName[DSM_MAX_MC_NAME_LENGTH + 1];  /* mc name */
    dsChar_t       mcDesc[DSM_MAX_MC_DESCR_LENGTH + 1]; /* mc description */
    archDetailCG  archDet;                              /* Archive copy group detail */
    backupDetailCG backupDet;                           /* Backup copy group detail */
} tsmQryRespMCDetailData;

#define tsmQryRespMCDetailDataVersion 4

/*-----+
| Type definition for Query Mgmt Class summary response on dsmGetNextQObj() |
+-----*/
typedef struct tsmQryRespMCData
{
    dsUInt16_t     stVersion;                            /* structure version */
    dsChar_t       mcName[DSM_MAX_MC_NAME_LENGTH + 1];  /* mc name */
    dsChar_t       mcDesc[DSM_MAX_MC_DESCR_LENGTH + 1]; /* mc description */
} tsmQryRespMCData;

#define tsmQryRespMCDataVersion 1

/*-----+
| Type definition for Archive queryBuffer on tsmBeginQuery() |

```

```

+-----*/
typedef struct tsmQryArchiveData
{
    dsUint16_t    stVersion;                /* structure version */
    tsmObjName    *objName;                /* Full dsm name of object */
    dsChar_t      *owner;                  /* owner name */
    /* for maximum date boundaries, see defines above */
    dsmDate       insDateLowerBound;       /* low bound archive insert date */
    dsmDate       insDateUpperBound;       /* hi bound archive insert date */
    dsmDate       expDateLowerBound;       /* low bound expiration date */
    dsmDate       expDateUpperBound;       /* hi bound expiration date */
    dsChar_t      *descr;                  /* archive description */
} tsmQryArchiveData;

#define tsmQryArchiveDataVersion 1

/*-----+
| Type definition for Query Archive response on dsmGetNextQObj() |
+-----*/
typedef struct tsmQryRespArchiveData
{
    dsUint16_t    stVersion;                /* structure version */
    tsmObjName    objName;                  /* Filespace name qualifier */
    dsUint32_t    copyGroup;                /* copy group number */
    dsChar_t      mcName[DSM_MAX_MC_NAME_LENGTH + 1]; /* mc name */
    dsChar_t      owner[DSM_MAX_OWNER_LENGTH + 1]; /* owner name */
    dsStruct64_t  objId;                    /* Unique copy id */
    dsStruct64_t  reserved;                  /* backward compatibility */
    dsUint8_t     mediaClass;                /* media access class */
    dsmDate       insDate;                  /* archive insertion date */
    dsmDate       expDate;                  /* expiration date for object */
    dsChar_t      descr[DSM_MAX_DESCR_LENGTH + 1]; /* archive description */
    dsUint16_t    objInfolen;               /* length of object-dependent info*/
    dsUint8_t     reservedObjInfo[DSM_MAX_OBJINFO_LENGTH]; /*object-dependent info */
    dsUint160_t   restoreOrderExt;          /* restore order */
    dsStruct64_t  sizeEstimate;              /* size estimate stored by user*/
    dsUint8_t     compressType;              /* Compression flag */
    dsUint8_t     retentionInitiated; /* object waiting on retention event */
    dsUint8_t     objHeld; /* object is on "hold" see dsmapitd.h for values */
    dsUint8_t     encryptionType;          /* type of encryption */
    dsmBool_t     clientDeduplicated;        /* obj deduplicated by API*/
    dsUint8_t     objInfo[DSM_MAX_EXT_OBJINFO_LENGTH]; /*object-dependent info */
    dsChar_t      compressAlg[DSM_MAX_COMPRESSTYPE_LENGTH + 1]; /* compression algorithm name */
} tsmQryRespArchiveData;

#define tsmQryRespArchiveDataVersion 7

/*-----+
| Type definition for Archive sendBuff parameter on dsmSendObj() |
+-----*/
typedef struct tsmSndArchiveData
{
    dsUint16_t    stVersion;                /* structure version */
    dsChar_t      *descr;                  /* archive description */
} tsmSndArchiveData;

#define tsmSndArchiveDataVersion 1

/*-----+
| Type definition for Backup queryBuffer on dsmBeginQuery() |
+-----*/
typedef struct tsmQryBackupData
{
    dsUint16_t    stVersion;                /* structure version */
    tsmObjName    *objName;                /* full dsm name of object */
    dsChar_t      *owner;                  /* owner name */
    dsUint8_t     objState;                /* object state selector */
    dsmDate       pitDate;                 /* Date value for point in time restore */
    /* for possible values, see defines above */
    dsUint32_t    reserved1;
    dsUint32_t    reserved2;
} tsmQryBackupData;

#define tsmQryBackupDataVersion 3

```

```

/*-----+
| Type definition for Query Backup response on dsmGetNextQObj() |
+-----*/
typedef struct tsmQryRespBackupData
{
    dsUInt16_t      stVersion;                          /* structure version */
    tsmObjName      objName;                            /* full dsm name of object */
    dsUInt32_t      copyGroup;                          /* copy group number */
    dsChar_t        mcName[DSM_MAX_MC_NAME_LENGTH + 1]; /* mc name */
    dsChar_t        owner[DSM_MAX_OWNER_LENGTH + 1];   /* owner name */
    dsStruct64_t    objId;                              /* Unique object id */
    dsStruct64_t    reserved;                           /* backward compatability */
    dsUInt8_t       mediaClass;                         /* media access class */
    dsUInt8_t       objState;                          /* Obj state, active, etc. */
    dsmDate         insDate;                            /* backup insertion date */
    dsmDate         expDate;                           /* expiration date for object */
    dsUInt16_t      objInfolen;                        /* length of object-dependent info*/
    dsUInt8_t       reservedObjInfo[DSM_MAX_OBJINFO_LENGTH]; /*object-dependent info */
    dsUInt160_t     restoreOrderExt;                  /* restore order */
    dsStruct64_t    sizeEstimate;                      /* size estimate stored by user */
    dsStruct64_t    baseObjId;
    dsUInt16_t      baseObjInfolen;                   /* length of base object-dependent info*/
    dsUInt8_t       baseObjInfo[DSM_MAX_OBJINFO_LENGTH]; /* base object-dependent info */
    dsUInt160_t     baseRestoreOrder;                 /* restore order */
    dsUInt32_t      fsID;
    dsUInt8_t       compressType;
    dsmBool_t       isGroupLeader;
    dsmBool_t       isOpenGroup;
    dsUInt8_t       reserved1;                        /* for future use */
    dsmBool_t       reserved2;                        /* for future use */
    dsUInt16_t      reserved3;                        /* for future use */
    reservedInfo_t  *reserved4;                       /* for future use */
    dsUInt8_t       encryptionType;                   /* type of encryption */
    dsmBool_t       clientDeduplicated;               /* obj deduplicated by API*/
    dsUInt8_t       objInfo[DSM_MAX_EXT_OBJINFO_LENGTH]; /*object-dependent info */
    dsChar_t        compressAlg[DSM_MAX_COMPRESSTYPE_LENGTH + 1]; /* compression algorithm name */
} tsmQryRespBackupData;

#define tsmQryRespBackupDataVersion 8
/*-----+
| Type definition for Active Backup queryBuffer on dsmBeginQuery()
|
| Notes: For the active backup query, only the fs (filesystem) and objType
|        fields of objName need be set.  objType can only be set to
|        DSM_OBJ_FILE or DSM_OBJ_DIRECTORY.  DSM_OBJ_ANY_TYPE will not
|        find a match on the query.
+-----*/
typedef struct tsmQryABackupData
{
    dsUInt16_t      stVersion;                          /* structure version */
    tsmObjName      *objName;                          /* Only fs and objtype used */
} tsmQryABackupData;

#define tsmQryABackupDataVersion 1
/*-----+
| Type definition for Query Active Backup response on dsmGetNextQObj() |
+-----*/
typedef struct tsmQryARespBackupData
{
    dsUInt16_t      stVersion;                          /* structure version */
    tsmObjName      objName;                            /* full dsm name of object */
    dsUInt32_t      copyGroup;                          /* copy group number */
    dsChar_t        mcName[DSM_MAX_MC_NAME_LENGTH + 1]; /*management class name*/
    dsChar_t        owner[DSM_MAX_OWNER_LENGTH + 1];   /* owner name */
    dsmDate         insDate;                            /* backup insertion date */
    dsUInt16_t      objInfolen;                        /* length of object-dependent info*/
    dsUInt8_t       reservedObjInfo[DSM_MAX_OBJINFO_LENGTH]; /*object-dependent info */
    dsUInt8_t       objInfo[DSM_MAX_EXT_OBJINFO_LENGTH]; /*object-dependent info */
} tsmQryARespBackupData;

#define tsmQryARespBackupDataVersion 2

```

```

/*-----+
| Type definition for Backup queryBuffer on dsmBeginQuery() |
+-----*/
typedef struct tsmQryBackupGroups
{
    dsUInt16_t    stVersion;          /* structure version */
    dsUInt8_t     groupType;
    dsChar_t      *fsName;
    dsChar_t      *owner;
    dsStruct64_t  groupLeaderObjId;
    dsUInt8_t     objType;
    dsUInt32_t    reserved1;
    dsUInt32_t    reserved2;
    dsmBool_t     noRestoreOrder;
    dsmBool_t     noGroupInfo;
    dsChar_t      *hl;
} tsmQryBackupGroups;

#define tsmQryBackupGroupsVersion 4

/*-----+
| Type definition for proxynode queryBuffer on tsmBeginQuery() |
+-----*/
typedef struct tsmQryProxyNodeData
{
    dsUInt16_t    stVersion;          /* structure version */
    dsChar_t      *targetNodeName;    /* target node name */
} tsmQryProxyNodeData;

#define tsmQryProxyNodeDataVersion 1

/*-----+
| Type definition for qryRespProxyNodeData parameter used on tsmGetNextQObj() |
+-----*/

typedef struct tsmQryRespProxyNodeData
{
    dsUInt16_t    stVersion ;          /* structure version */
    dsChar_t      targetNodeName[DSM_MAX_ID_LENGTH+1]; /* target node name */
    dsChar_t      peerNodeName[DSM_MAX_ID_LENGTH+1]; /* peer node name */
    dsChar_t      hlAddress[DSM_MAX_ID_LENGTH+1]; /* peer hlAddress */
    dsChar_t      llAddress[DSM_MAX_ID_LENGTH+1]; /* peer llAddress */
} tsmQryRespProxyNodeData;

#define tsmQryRespProxyNodeDataVersion 1

/*-----+
| Type definition for WINNT and OS/2 Filespace attributes |
+-----*/
typedef struct tsmDosFSAttrib
{
    osChar_t      driveLetter ;          /* drive letter for filespace */
    dsUInt16_t    fsInfoLength;          /* fsInfo length used */
    osChar_t      fsInfo[DSM_MAX_FSINFO_LENGTH]; /* caller-determined data */
} tsmDosFSAttrib ;

/*-----+
| Type definition for UNIX Filespace attributes |
+-----*/
typedef struct tsmUnixFSAttrib
{
    dsUInt16_t    fsInfoLength;          /* fsInfo length used */
    osChar_t      fsInfo[DSM_MAX_FSINFO_LENGTH]; /* caller-determined data */
} tsmUnixFSAttrib ;

/*-----+
| Type definition for NetWare Filespace attributes |
+-----*/
typedef tsmUnixFSAttrib tsmNetwareFSAttrib;

/*-----+
| Type definition for Filespace attributes on all Filespace calls |
+-----*/
typedef union

```

```

{
    tsmNetwareFSAttr  netwareFSAttr;
    tsmUnixFSAttr    unixFSAttr ;
    tsmDosFSAttr     dosFSAttr ;
} tsmFSAttr ;

/*-----+
| Type definition for fsUpd parameter on dsmUpdateFS()
+-----*/
typedef struct    tsmFSUpd
{
    dsUint16_t     stVersion ;           /* structure version          */
    dsChar_t       *fsType ;            /* filesystem type            */
    dsStruct64_t   occupancy ;          /* occupancy estimate         */
    dsStruct64_t   capacity ;           /* capacity estimate         */
    tsmFSAttr     fsAttr ;              /* platform specific attributes */
} tsmFSUpd ;

#define tsmFSUpdVersion 1

/*-----+
| Type definition for Filespace queryBuffer on dsmBeginQuery()
+-----*/
typedef struct tsmQryFSData
{
    dsUint16_t     stVersion;           /* structure version */
    dsChar_t       *fsName;            /* File space name */
} tsmQryFSData;

#define tsmQryFSDataVersion 1

/*-----+
| Type definition for Query Filespace response on dsmGetNextQObj()
+-----*/
typedef struct tsmQryRespFSData
{
    dsUint16_t     stVersion;           /* structure version          */
    dsChar_t       fsName[DSM_MAX_FSNAME_LENGTH + 1]; /* Filespace name          */
    dsChar_t       fsType[DSM_MAX_FSTYPE_LENGTH + 1]; /* Filespace type          */
    dsStruct64_t   occupancy;           /* Occupancy est. in bytes.  */
    dsStruct64_t   capacity;            /* Capacity est. in bytes.   */
    tsmFSAttr     fsAttr ;              /* platform specific attributes */
    dsmDate        backStartDate;        /* start backup date         */
    dsmDate        backCompleteDate;     /* end backup Date           */
    dsmDate        reserved1 ;           /* For future use            */
    dsmBool_t      bIsUnicode;
    dsUint32_t     fsID;
    dsmDate        lastReplStartDate;     /* The last time replication was started */
    dsmDate        lastReplCmpltDate;     /* The last time replication completed */
                                           /* (could have had a failure, */
                                           /* but it still completes) */
    dsmDate        lastBackOpDateFromServer; /* The last store time stamp the client */
                                           /* saved on the server */
    dsmDate        lastArchOpDateFromServer; /* The last store time stamp the client */
                                           /* saved on the server */
    dsmDate        lastSpMgOpDateFromServer; /* The last store time stamp the client */
                                           /* saved on the server */
    dsmDate        lastBackOpDateFromLocal; /* The last store time stamp the client */
                                           /* saved on the Local */
    dsmDate        lastArchOpDateFromLocal; /* The last store time stamp the client */
                                           /* saved on the Local */
    dsmDate        lastSpMgOpDateFromLocal; /* The last store time stamp the client */
                                           /* saved on the Local */
    dsInt32_t      failOverWriteDelay;    /* Minutes for client to wait before allowed */
                                           /* to store to this Repl srvr, Specail codes: */
                                           /* NO_ACCESS(-1), ACCESS_RDONLY (-2) */
} tsmQryRespFSData;

#define tsmQryRespFSDataVersion 5

/*-----+
| Type definition for regFilespace parameter on dsmRegisterFS()
+-----*/
typedef struct tsmRegFSData

```

```

{
    dsUInt16_t    stVersion;                /* structure version */
    dsChar_t     *fsName;                  /* Filespace name */
    dsChar_t     *fsType;                 /* Filespace type */
    dsStruct64_t occupancy;                /* Occupancy est. in bytes. */
    dsStruct64_t capacity;                 /* Capacity est. in bytes. */
    tsmFSAttr    fsAttr ;                 /* platform specific attributes */
} tsmRegFSData;

#define tsmRegFSDataVersion 1

/*-----+
| Type definition for session info response on dsmQuerySessionInfo() |
+-----*/
typedef struct
{
    dsUInt16_t    stVersion;                /* Structure version */
    /*-----*/
    /*          Server information          */
    /*-----*/
    dsChar_t     serverHost[DSM_MAX_SERVERNAME_LENGTH+1];
    /* Network host name of DSM server */
    dsUInt16_t   serverPort;                /* Server comm port on host */
    dsmDate      serverDate;               /* Server's date/time */
    dsChar_t     serverType[DSM_MAX_SERVERTYPE_LENGTH+1];
    /* Server's execution platform */
    dsUInt16_t   serverVer;                /* Server's version number */
    dsUInt16_t   serverRel;                /* Server's release number */
    dsUInt16_t   serverLev;                /* Server's level number */
    dsUInt16_t   serverSubLev;            /* Server's sublevel number */
    /*-----*/
    /*          Client Defaults          */
    /*-----*/
    dsChar_t     nodeType[DSM_MAX_PLATFORM_LENGTH+1]; /*node/application type*/
    dsChar_t     fsdelim;                  /* File space delimiter */
    dsChar_t     hldelim;                  /* Delimiter betw highlev & lowlev */
    dsUInt8_t    compression;              /* Compression flag */
    dsUInt8_t    archDel;                  /* Archive delete permission */
    dsUInt8_t    backDel;                  /* Backup delete permission */
    dsUInt32_t   maxBytesPerTxn;           /* for future use */
    dsUInt16_t   maxObjPerTxn;            /* The max objects allowed in a txn */
    /*-----*/
    /*          Session Information      */
    /*-----*/
    dsChar_t     id[DSM_MAX_ID_LENGTH+1];  /* Sign-in id node name */
    dsChar_t     owner[DSM_MAX_OWNER_LENGTH+1]; /* Sign-in owner */
    /* (for multi-user platforms) */
    dsChar_t     confFile[DSM_PATH_MAX + DSM_NAME_MAX +1];
    /* len is platform dep */
    /* dsInit name of appl config file */
    dsUInt8_t    opNoTrace;                /* dsInit option - NoTrace = 1 */
    /*-----*/
    /*          Policy Data              */
    /*-----*/
    dsChar_t     domainName[DSM_MAX_DOMAIN_LENGTH+1]; /* Domain name */
    dsChar_t     policySetName[DSM_MAX_PS_NAME_LENGTH+1];
    /* Active policy set name */
    dsmDate      polActDate;                /* Policy set activation date */
    dsChar_t     dfltMCName[DSM_MAX_MC_NAME_LENGTH+1]; /* Default Mgmt Class */
    dsUInt16_t   gpBackRetn;                /* Grace-period backup retention */
    dsUInt16_t   gpArchRetn;                /* Grace-period archive retention */
    dsChar_t     admServerName[DSM_MAX_SERVERNAME_LENGTH+1]; /* adm server name */
    dsmBool_t    archiveRetentionProtection; /* is server Retention protection enabled */
    dsUInt64_t   maxBytesPerTxn_64;         /* for future use */
    dsmBool_t    lanFreeEnabled;            /* lan free option is set */
    dsmDedupType dedupType;                /* server or clientOrServer */
    dsChar_t     accessNode[DSM_MAX_ID_LENGTH+1]; /* as node node name */

    /*-----*/
    /*          Replication and fail over information          */
    /*-----*/
    dsmFailOvrCfgType failOverCfgType; /* status of fail over */
    dsChar_t     replServerName[DSM_MAX_SERVERNAME_LENGTH+1]; /* repl server name */
    dsChar_t     homeServerName[DSM_MAX_SERVERNAME_LENGTH+1]; /* home server name */

```

```

    dsChar_t      replServerHost[DSM_MAX_SERVERNAME_LENGTH+1]; /* Network host name of DSM server
*/
    dsInt32_t     replServerPort;                               /* Server comm port on host
*/

} tsmApiSessInfo;

#define tsmApiSessInfoVersion 6

/*-----+
| Type definition for Query options response on dsmQueryCliOptions() |
| and dsmQuerySessOptions() |
+-----*/

typedef struct
{
    dsUInt16_t    stVersion;
    dsChar_t      dsmiDir[DSM_PATH_MAX + DSM_NAME_MAX +1];
    dsChar_t      dsmiConfig[DSM_PATH_MAX + DSM_NAME_MAX +1];
    dsChar_t      serverName[DSM_MAX_SERVERNAME_LENGTH+1];
    dsInt16_t     commMethod;
    dsChar_t      serverAddress[DSM_MAX_SERVER_ADDRESS];
    dsChar_t      nodeName[DSM_MAX_NODE_LENGTH+1];
    dsmBool_t     compression;
    dsmBool_t     compressalways;
    dsmBool_t     passwordAccess;
} tsmOptStruct ;

#define tsmOptStructVersion 1

/*-----+
| Type definition for qryRespAccessData parameter used on dsmQueryAccess() |
+-----*/

typedef struct
{
    dsUInt16_t     stVersion ;                               /* structure version */
    dsChar_t       node[DSM_MAX_ID_LENGTH+1];               /* node name */
    dsChar_t       owner[DSM_MAX_OWNER_LENGTH+1];          /* owner */
    tsmObjName     objName ;                                /* object name */
    dsmAccessType  accessType;                              /* archive or backup */
    dsUInt32_t     ruleNumber ;                             /* Access rule id */
} tsmQryRespAccessData;

#define tsmQryRespAccessDataVersion 1

/*-----+
| Type definition for envSetUp parameter on dsmSetUp() |
+-----*/

typedef struct tsmEnvSetUp
{
    dsUInt16_t     stVersion;                               /* structure version */
    dsChar_t       dsmiDir[DSM_PATH_MAX + DSM_NAME_MAX +1];
    dsChar_t       dsmiConfig[DSM_PATH_MAX + DSM_NAME_MAX +1];
    dsChar_t       dsmiLog[DSM_PATH_MAX + DSM_NAME_MAX +1];
    char           **argv; /* for executables name argv[0] */
    dsChar_t       logName[DSM_NAME_MAX +1];
    dsmBool_t      reserved1; /* for future use */
    dsmBool_t      reserved2; /* for future use */
} tsmEnvSetUp;

#define tsmEnvSetUpVersion 4

/*-----+
| Type definition for dsmInitExIn_t |
+-----*/

typedef struct tsmInitExIn_t
{
    dsUInt16_t     stVersion;                               /* structure version */
    tsmApiVersionEx *apiVersionExp;
    dsChar_t       *clientNodeNameP;
    dsChar_t       *clientOwnerNameP;
    dsChar_t       *clientPasswordP;
}

```



```

    dsChar_t      *userNameP;
    dsChar_t      *userPasswordP;
    dsChar_t      *applicationTypeP;
    dsChar_t      *configfile;
    dsChar_t      *options;
    dsChar_t      dirDelimiter;
    dsmBool_t     useUnicode;
    dsmBool_t     bCrossPlatform;
    dsmBool_t     bService;
    dsmBool_t     bEncryptKeyEnabled;
    dsChar_t      *encryptionPasswordP;
    dsmBool_t     useTsmBuffers;
    dsUInt8_t     numTsmBuffers;
    tsmAppVersion appVersionP;
} tsmInitExIn_t;

#define tsmInitExInVersion 5

/*-----+
| Type definition for dsmInitExOut_t
+-----*/
typedef struct tsmInitExOut_t
{
    dsUInt16_t     stVersion; /* structure version */
    dsInt16_t      userNameAuthorities;
    dsInt16_t      infoRC; /* error return code if encountered */
    /* adsm server name */
    dsChar_t       adsmServerName[DSM_MAX_SERVERNAME_LENGTH+1];
    dsUInt16_t     serverVer; /* Server's version number */
    dsUInt16_t     serverRel; /* Server's release number */
    dsUInt16_t     serverLev; /* Server's level number */
    dsUInt16_t     serverSubLev; /* Server's sublevel number */
    dsmBool_t      bIsFailOverMode; /* true if failover has occurred */
    dsChar_t       replServerName[DSM_MAX_SERVERNAME_LENGTH+1]; /* repl server name */
    dsChar_t       homeServerName[DSM_MAX_SERVERNAME_LENGTH+1]; /* home server name */
} tsmInitExOut_t;

#define tsmInitExOutVersion 3

/*-----+
| Type definition for dsmLogExIn_t
+-----*/
typedef struct tsmLogExIn_t
{
    dsUInt16_t     stVersion; /* structure version */
    dsmLogSeverity severity;
    dsChar_t       appMsgID[8];
    dsmLogType     logType; /* log type : local, server, both */
    dsChar_t       *message; /* text of message to be logged */
    dsChar_t       appName[DSM_MAX_PLATFORM_LENGTH];
    dsChar_t       osPlatform[DSM_MAX_PLATFORM_LENGTH];
    dsChar_t       appVersion[DSM_MAX_PLATFORM_LENGTH];
} tsmLogExIn_t;

#define tsmLogExInVersion 2

/*-----+
| Type definition for dsmLogExOut_t
+-----*/
typedef struct tsmLogExOut_t
{
    dsUInt16_t     stVersion; /* structure version */
} tsmLogExOut_t;

#define tsmLogExOutVersion 1

/*-----+
| Type definition for dsmRenameIn_t
+-----*/
typedef struct tsmRenameIn_t
{
    dsUInt16_t     stVersion; /* structure version */
    dsUInt32_t     tsmHandle; /* handle for session */
}

```

```

    dsUInt8_t      repository;          /* Backup or Archive */
    tsmObjName     *objNameP ;         /* object name */
    dsChar_t      newHl[DSM_MAX_HL_LENGTH + 1]; /* new High level name */
    dsChar_t      newLl[DSM_MAX_LL_LENGTH + 1]; /* new Low level name */
    dsmBool_t     merge;              /* merge into existing name*/
    ObjID         objId;              /* objId for Archive */
} tsmRenameIn_t;

#define tsmRenameInVersion 1

/*-----+
| Type definition for dsmRenameOut_t
+-----*/
typedef struct tsmRenameOut_t
{
    dsUInt16_t     stVersion;          /* structure version */
} tsmRenameOut_t;

#define tsmRenameOutVersion 1

/*-----+
| Type definition for tsmEndSendObjExIn_t
+-----*/
typedef struct tsmEndSendObjExIn_t
{
    dsUInt16_t     stVersion;          /* structure version */
    dsUInt32_t     tsmHandle;         /* handle for session */
} tsmEndSendObjExIn_t;

#define tsmEndSendObjExInVersion 1

/*-----+
| Type definition for dsmEndSendObjExOut_t
+-----*/
typedef struct tsmEndSendObjExOut_t
{
    dsUInt16_t     stVersion;          /* structure version */
    dsStruct64_t   totalBytesSent;     /* total bytes read from app */
    dsmBool_t      objCompressed;      /* was object compressed */
    dsStruct64_t   totalCompressSize; /* total size after compress */
    dsStruct64_t   totalLFBytesSent;  /* total bytes sent Lan Free */
    dsUInt8_t     encryptionType;     /* type of encryption used */
    dsmBool_t     objDeduplicated;     /* was object processed for dist. data dedup */
    dsStruct64_t   totalDedupSize;    /* total size after de-dup */
} tsmEndSendObjExOut_t;

#define tsmEndSendObjExOutVersion 3

/*-----+
| Type definition for tsmGroupHandlerIn_t
+-----*/
typedef struct tsmGroupHandlerIn_t
{
    dsUInt16_t     stVersion;          /* structure version */
    dsUInt32_t     tsmHandle;         /* handle for session */
    dsUInt8_t     groupType;         /* Type of group */
    dsUInt8_t     actionType;        /* Type of group operation */
    dsUInt8_t     memberType;        /* Type of member: Leader or member */
    dsStruct64_t   leaderObjId;      /* OBJID of the groupleader */
    dsChar_t      *uniqueGroupTagP; /* Unique group identifier */
    tsmObjName     *objNameP ;      /* group leader object name */
    dsmGetList     memberObjList;    /* list of objects to remove, assign */
} tsmGroupHandlerIn_t;

#define tsmGroupHandlerInVersion 1

/*-----+
| Type definition for tsmGroupHandlerExOut_t
+-----*/
typedef struct tsmGroupHandlerOut_t
{
    dsUInt16_t     stVersion;          /* structure version */
} tsmGroupHandlerOut_t;

```

```

#define tsmGroupHandlerOutVersion 1

/*-----+
| Type definition for tsmEndTxnExIn_t
+-----*/
typedef struct tsmEndTxnExIn_t
{
    dsUint16_t      stVersion;          /* structure version */
    dsUint32_t      tsmHandle;         /* handle for session */
    dsUint8_t       vote;
} tsmEndTxnExIn_t;

#define tsmEndTxnExInVersion 1

/*-----+
| Type definition for tsmEndTxnExOut_t
+-----*/
typedef struct tsmEndTxnExOut_t
{
    dsUint16_t      stVersion;          /* structure version */
    dsUint16_t      reason;             /* reason code */
    dsStruct64_t    groupLeaderObjId;   /* groupLeader obj id returned on */
    /* DSM_ACTION_OPEN */
    dsUint8_t       reserved1;          /* future use */
    dsUint16_t      reserved2;         /* future use */
} tsmEndTxnExOut_t;

#define tsmEndTxnExOutVersion 1

/*-----+
| Type definition for tsmEndGetDataExIn_t
+-----*/
typedef struct tsmEndGetDataExIn_t
{
    dsUint16_t      stVersion;          /* structure version */
    dsUint32_t      tsmHandle;         /* handle for session */
} tsmEndGetDataExIn_t;

#define tsmEndGetDataExInVersion 1

/*-----+
| Type definition for tsmEndGetDataExOut_t
+-----*/
typedef struct tsmEndGetDataExOut_t
{
    dsUint16_t      stVersion;          /* structure version */
    dsUint16_t      reason;             /* reason code */
    dsStruct64_t    totalLFBytesRecv;   /* total lan free bytes recieved */
} tsmEndGetDataExOut_t;

#define tsmEndGetDataExOutVersion 1

/*-----+
| Type definition for on tsmRetentionEvent()
+-----*/
typedef struct tsmRetentionEventIn_t
{
    dsUint16_t      stVersion;          /* structure version */
    dsUint32_t      tsmHandle;         /* session Handle */
    dsmEventType_t  eventType;         /* Event type */
    dsmObjList_t    objList;          /* object ID */
} tsmRetentionEventIn_t;

#define tsmRetentionEventInVersion 1

/*-----+
| Type definition for on tsmRetentionEvent()
+-----*/
typedef struct tsmRetentionEventOut_t
{
    dsUint16_t      stVersion;          /* structure version */
} tsmRetentionEventOut_t;

#define tsmRetentionEventOutVersion 1

```



```

#if !defined(DSMAPILIB) || defined (XOPEN_BUILD)

/* support for linkage */
#include <windows.h>
#define DSMLINKAGE WINAPI

#define DS_WINNT 22
#define _OPSYS_TYPE DS_WINNT

typedef signed char dsInt8_t;
typedef unsigned char dsUInt8_t;
typedef signed short dsInt16_t;
typedef unsigned short dsUInt16_t;
typedef signed long dsInt32_t;
typedef unsigned long dsUInt32_t;

/*=== Character and string types ===*/
#ifdef UNICODE
typedef wchar_t dsChar_t;
#define dsTEXT(x) L##x
#else
typedef char dsChar_t;
#define dsTEXT(x) x
#endif /* !UNICODE */

/*=== Common typedefs and defines derived from dsChar_t ===*/
typedef dsChar_t dsString_t;

/* added for the extended restore order */
typedef struct
{
    dsUInt32_t top;
    dsUInt32_t hi_hi;
    dsUInt32_t hi_lo;
    dsUInt32_t lo_hi;
    dsUInt32_t lo_lo;
} dsUInt160_t ;

#if defined(_LONG_LONG)
typedef __int64 dsInt64_t;
typedef unsigned __int64 dsUInt64_t;
/*=== A "true" unsigned 64-bit integer ===*/
typedef __int64 dsLongLong_t;
#else
typedef struct tagUINT64_t
{
    dsUInt32_t hi; /* Most significant 32 bits. */
    dsUInt32_t lo; /* Least significant 32 bits. */
} dsUInt64_t;
#endif

/*-----+
| Type definition for bool_t |
+-----*/
/*
 * Had to create a Boolean type that didn't clash with any other predefined
 * version in any operating system or windowing system.
 */
typedef enum
{
    dsmFalse = 0x00,
    dsmTrue = 0x01
}dsmBool_t ;

/*=== for backward compatability ===*/
#define uint8 dsUInt8_t
#define int8 dsInt8_t
#define uint16 dsUInt16_t
#define int16 dsInt16_t
#define uint32 dsUInt32_t

```

```

#define int32      dsInt32_t
#define uint64     dsStruct64_t
#define bool_t    dsBool_t
#define dsBool_t  dsmBool_t
#define bTrue     dsmTrue
#define bFalse    dsmFalse

typedef struct
{
    dsUint32_t hi;          /* Most significant 32 bits. */
    dsUint32_t lo;        /* Least significant 32 bits. */
}dsStruct64_t ;

#endif /* DSMAPILIB */

#ifdef _WIN64
#pragma pack()
#endif
#endif /* _H_DSMAPIPS */

/*****
 * IBM Spectrum Protect
 * Common Source Component
 *
 * (C) Copyright IBM Corporation 1993,2016
 *****/

/*****
 * Header File Name: release.h
 *
 * Environment:
 *
 * ** This is a platform-independent source file **
 *
 * Design Notes: This file contains the common information about
 * the actual version.release.level.sublevel
 *
 * Descriptive-name: Definitions for Tivoli Storage manager version
 *
 * Note: This file should contain no LOG or CMVC information. It is
 * shipped with the API code.
 *
 *-----*/

#ifdef _H_RELEASE
#define _H_RELEASE

#define COMMON_VERSION      8
#define COMMON_RELEASE      1
#define COMMON_LEVEL        2
#define COMMON_SUBLEVEL     0
#define COMMON_DRIVER       dsTEXT("")

#define COMMON_VERSIONTXT "8.1.2.0"

#define SHIPYEARTXT "2017"
#define SHIPYEARTXTW dsTEXT("2017")
#define TSMPRODTXT "IBM Spectrum Protect"

/*=====
The following string definitions are used for VERSION information
and should not be converted to dsTEXT or osTEXT. They are used
only at link time.

These are also used when the Jar file is built on Unix. See the
the perl script tools/unx/mzbuild/createReleaseJava
=====*/
#define COMMON_VERSION_STR "8"
#define COMMON_RELEASE_STR "1"
#define COMMON_LEVEL_STR "2"
#define COMMON_SUBLEVEL_STR "0"
#define COMMON_DRIVER_STR ""

```

```

/*=== product names definitions ===*/
#define COMMON_NAME_DFDSM      1
#define COMMON_NAME_ADSM      2
#define COMMON_NAME_TSM       3
#define COMMON_NAME_ITSM      4
#define COMMON_NAME           COMMON_NAME_ITSM

/*=====
Internal version, release, and level (build) version. This
should be unique for every version+release+ptf of a product.
This information is recorded in the file attributes and data
stream for diagnostic purposes.
NOTE: DO NOT MODIFY THESE VALUES. YOU CAN ONLY ADD NEW ENTRIES!
=====*/
#define COMMON_BUILD_TSM_510    1
#define COMMON_BUILD_TSM_511    2
#define COMMON_BUILD_TSM_515    3
#define COMMON_BUILD_TSM_516    4
#define COMMON_BUILD_TSM_520    5
#define COMMON_BUILD_TSM_522    6
#define COMMON_BUILD_TSM_517    7
#define COMMON_BUILD_TSM_523    8
#define COMMON_BUILD_TSM_530    9
#define COMMON_BUILD_TSM_524   10
#define COMMON_BUILD_TSM_532   11
#define COMMON_BUILD_TSM_533   12
#define COMMON_BUILD_TSM_525   13
#define COMMON_BUILD_TSM_534   14
#define COMMON_BUILD_TSM_540   15
#define COMMON_BUILD_TSM_535   16
#define COMMON_BUILD_TSM_541   17
#define COMMON_BUILD_TSM_550   18
#define COMMON_BUILD_TSM_542   19
#define COMMON_BUILD_TSM_551   20
#define COMMON_BUILD_TSM_610   21
#define COMMON_BUILD_TSM_552   22
#define COMMON_BUILD_TSM_611   23
#define COMMON_BUILD_TSM_543   24
#define COMMON_BUILD_TSM_620   25
#define COMMON_BUILD_TSM_612   26
#define COMMON_BUILD_TSM_553   27
#define COMMON_BUILD_TSM_613   28
#define COMMON_BUILD_TSM_621   29
#define COMMON_BUILD_TSM_622   30
#define COMMON_BUILD_TSM_614   31
#define COMMON_BUILD_TSM_623   32
#define COMMON_BUILD_TSM_630   33
#define COMMON_BUILD_TSM_615   34
#define COMMON_BUILD_TSM_624   35
#define COMMON_BUILD_TSM_631   36
#define COMMON_BUILD_TSM_640   37
#define COMMON_BUILD_TSM_710   38
#define COMMON_BUILD_TSM_625   39
#define COMMON_BUILD_TSM_641   40
#define COMMON_BUILD_TSM_711   41
#define COMMON_BUILD_TSM_712   42
#define COMMON_BUILD_TSM_713   43
#define COMMON_BUILD_TSM_714   44
#define COMMON_BUILD_TSM_720   45
#define COMMON_BUILD_TSM_721   46
#define COMMON_BUILD_TSM_642   47
#define COMMON_BUILD_TSM_643   48
#define COMMON_BUILD_TSM_715   49
#define COMMON_BUILD_TSM_716   50
#define COMMON_BUILD_TSM_810   51
#define COMMON_BUILD_TSM_811   52
#define COMMON_BUILD_TSM_812   53
#define COMMON_BUILD           COMMON_BUILD_TSM_812

/*=== define VRL as an Int for bitmap version compares ===*/
static const int VRL_712 = 712;
static const int VRL_713 = 713;
static const int VRL_714 = 714;

```

```

static const int VRL_715 = 715;
static const int VRL_716 = 716;
static const int VRL_810 = 810;
static const int VRL_811 = 811;
static const int VRL_812 = 812;

#define TDP4VE_PLATFORM_STRING_MBCS "TDP VMware"
#define TDP4VE_PLATFORM_STRING dsTEXT("TDP VMware")

#define TDP4HYPERV_PLATFORM_STRING_MBCS "TDP HyperV"
#define TDP4HYPERV_PLATFORM_STRING dsTEXT("TDP HyperV")

#endif /* _H_RELEASE */

```

## API function definitions source file

---

This appendix contains the dsmapifp.h header file, so you can see the function definitions for the API.

Note: DSMLINKAGE is defined differently for each operating system. See the definitions in the dsmapi.h file for your specific operating system.

The information that is provided here contains a point-in-time copy of the files that are distributed with the API. View the files in the API distribution package for the latest version.

```

/*****
 * Tivoli Storage Manager
 * API Client Component
 *
 * (C) Copyright IBM Corporation 1993,2002
 *****/

/*****
/* Header File Name: dsmapifp.h
/*
/*
/* Descriptive-name: Tivoli Storage Manager API function prototypes
*****/
#ifndef _H_DSMAPIFP
#define _H_DSMAPIFP

#if defined(__cplusplus)
extern "C" {
#endif

#ifdef DYNALOAD_DSMAPI

/* function will be dynamically loaded */
#include "dsmapidl.h"

#else

/* functions will be implicitly loaded from library */

/*=====
/* PUBLIC FUNCTIONS
/*=====

extern dsInt16_t DSMLINKAGE dsmBeginGetData(
    dsUInt32_t dsmHandle,
    dsBool_t mountWait,
    dsmGetType_t getType,
    dsmGetList_t *dsmGetObjListP
);

extern dsInt16_t DSMLINKAGE dsmBeginQuery(
    dsUInt32_t dsmHandle,
    dsmQueryType_t queryType,
    dsmQueryBuff_t *queryBuffer
);

extern dsInt16_t DSMLINKAGE dsmBeginTxn(

```



```

        dsUint32_t          dsmHandle
    );

extern dsInt16_t DSMLINKAGE dsmBindMC(
    dsUint32_t          dsmHandle,
    dsmObjName         *objNameP,
    dsmSendType        sendType,
    mcBindKey          *mcBindKeyP
);

extern dsInt16_t DSMLINKAGE dsmChangePW(
    dsUint32_t          dsmHandle,
    char                *oldPW,
    char                *newPW
);

extern dsInt16_t DSMLINKAGE dsmCleanUp(
    dsBool_t           mtFlag
);

extern dsInt16_t DSMLINKAGE dsmDeleteAccess(
    dsUint32_t          dsmHandle,
    dsUint32_t          ruleNum
);

extern dsInt16_t DSMLINKAGE dsmDeleteObj(
    dsUint32_t          dsmHandle,
    dsmDelType         delType,
    dsmDelInfo         delInfo
);

extern dsInt16_t DSMLINKAGE dsmDeleteFS(
    dsUint32_t          dsmHandle,
    char                *fsName,
    dsUint8_t           repository
);

extern dsInt16_t DSMLINKAGE dsmEndGetData(
    dsUint32_t          dsmHandle
);

extern dsInt16_t DSMLINKAGE dsmEndGetDataEx(
    dsmEndGetDataExIn_t *dsmEndGetDataExInP,
    dsmEndGetDataExOut_t *dsmEndGetDataExOutP
);

extern dsInt16_t DSMLINKAGE dsmEndGetObj(
    dsUint32_t          dsmHandle
);

extern dsInt16_t DSMLINKAGE dsmEndQuery(
    dsUint32_t          dsmHandle
);

extern dsInt16_t DSMLINKAGE dsmEndSendObj(
    dsUint32_t          dsmHandle
);

extern dsInt16_t DSMLINKAGE dsmEndSendObjEx(
    dsmEndSendObjExIn_t *dsmEndSendObjExInP,
    dsmEndSendObjExOut_t *dsmEndSendObjExOutP
);

extern dsInt16_t DSMLINKAGE dsmEndTxnEx(
    dsmEndTxnExIn_t     *dsmEndTxnExInP,
    dsmEndTxnExOut_t    *dsmEndTxnExOutP
);

extern dsInt16_t DSMLINKAGE dsmEndTxn(
    dsUint32_t          dsmHandle,
    dsUint8_t           vote,
    dsUint16_t          *reason
);

```

```

extern dsInt16_t DSMLINKAGE dsmGetData (
    dsUInt32_t          dsmHandle,
    DataBlk            *dataBlkPtr
);

extern dsInt16_t DSMLINKAGE dsmGetBufferData (
    getBufferDataIn_t  *dsmGetBufferDataInP,
    getBufferDataOut_t *dsmGetBufferDataOutP
);

extern dsInt16_t DSMLINKAGE dsmGetNextQObj (
    dsUInt32_t          dsmHandle,
    DataBlk            *dataBlkPtr
);

extern dsInt16_t DSMLINKAGE dsmGetObj (
    dsUInt32_t          dsmHandle,
    ObjID              *objIdP,
    DataBlk            *dataBlkPtr
);

extern dsInt16_t DSMLINKAGE dsmGroupHandler (
    dsmGroupHandlerIn_t *dsmGroupHandlerInP,
    dsmGroupHandlerOut_t *dsmGroupHandlerOutP
);

extern dsInt16_t DSMLINKAGE dsmInit (
    dsUInt32_t          *dsmHandle,
    dsmApiVersion       *dsmApiVersionP,
    char                *clientNodeNameP,
    char                *clientOwnerNameP,
    char                *clientPasswordP,
    char                *applicationType,
    char                *configfile,
    char                *options
);

extern dsInt16_t DSMLINKAGE dsmInitEx (
    dsUInt32_t          *dsmHandleP,
    dsmInitExIn_t      *dsmInitExInP,
    dsmInitExOut_t     *dsmInitExOutP
);

extern dsInt16_t DSMLINKAGE dsmLogEvent (
    dsUInt32_t          dsmHandle,
    logInfo             *logInfoP
);

extern dsInt16_t DSMLINKAGE dsmLogEventEx (
    dsUInt32_t          dsmHandle,
    dsmLogExIn_t       *dsmLogExInP,
    dsmLogExOut_t      *dsmLogExOutP
);

extern dsInt16_t DSMLINKAGE dsmQueryAccess (
    dsUInt32_t          dsmHandle,
    qryRespAccessData  **accessListP,
    dsUInt16_t          *numberOfRules
);

extern void DSMLINKAGE dsmQueryApiVersion (
    dsmApiVersion       *apiVersionP
);

extern void DSMLINKAGE dsmQueryApiVersionEx (
    dsmApiVersionEx    *apiVersionP
);

extern dsInt16_t DSMLINKAGE dsmQueryCliOptions (
    optStruct           *optstructP
);

```

```

extern dsInt16_t DSMLINKAGE dsmQuerySessInfo(
    dsUInt32_t          dsmHandle,
    ApiSessInfo         *SessInfoP
);

extern dsInt16_t DSMLINKAGE dsmQuerySessOptions(
    dsUInt32_t          dsmHandle,
    optStruct           *optstructP
);

extern dsInt16_t DSMLINKAGE dsmRCMsg(
    dsUInt32_t          dsmHandle,
    dsInt16_t           dsmRC,
    char                *msg
);

extern dsInt16_t DSMLINKAGE dsmRegisterFS(
    dsUInt32_t          dsmHandle,
    regFSData           *regFilespaceP
);

extern dsInt16_t DSMLINKAGE dsmReleaseBuffer(
    releaseBufferIn_t   *dsmReleaseBufferInP,
    releaseBufferOut_t  *dsmReleaseBufferOutP
);

extern dsInt16_t DSMLINKAGE dsmRenameObj(
    dsmRenameIn_t       *dsmRenameInP,
    dsmRenameOut_t      *dsmRenameOutP
);

extern dsInt16_t DSMLINKAGE dsmRequestBuffer(
    requestBufferIn_t   *dsmRequestBufferInP,
    requestBufferOut_t  *dsmRequestBufferOutP
);

extern dsInt16_t DSMLINKAGE dsmRetentionEvent(
    dsmRetentionEventIn_t *dsmRetentionEventInP,
    dsmRetentionEventOut_t *dsmRetentionEventOutP
);

extern dsInt16_t DSMLINKAGE dsmSendBufferData(
    sendBufferDataIn_t  *dsmSendBufferDataInP,
    sendBufferDataOut_t *dsmSendBufferDataOutP
);

extern dsInt16_t DSMLINKAGE dsmSendData(
    dsUInt32_t          dsmHandle,
    DataBlk             *dataBlkPtr
);

extern dsInt16_t DSMLINKAGE dsmSendObj(
    dsUInt32_t          dsmHandle,
    dsmSendType         sendType,
    void                *sendBuff,
    dsmObjName          *objNameP,
    ObjAttr             *objAttrPtr,
    DataBlk             *dataBlkPtr
);

extern dsInt16_t DSMLINKAGE dsmSetAccess(
    dsUInt32_t          dsmHandle,
    dsmAccessType       accessType,
    dsmObjName          *objNameP,
    char                *node,
    char                *owner
);

extern dsInt16_t DSMLINKAGE dsmSetUp(
    dsBool_t            mtFlag,
    envSetUp            *envSetUpP
);

extern dsInt16_t DSMLINKAGE dsmTerminate(

```

```

        dsUint32_t          dsmHandle
    );

extern dsInt16_t DSMLINKAGE dsmUpdateFS(
    dsUint32_t          dsmHandle,
    char                *fs,
    dsmFSUpd           *fsUpdP,
    dsUint32_t          fsUpdAct
);

extern dsInt16_t DSMLINKAGE dsmUpdateObj(
    dsUint32_t          dsmHandle,
    dsmSendType         sendType,
    void                *sendBuff,
    dsmObjName          *objNameP,
    ObjAttr             *objAttrPtr,
    dsUint32_t          objUpdAct
);

extern dsInt16_t DSMLINKAGE dsmUpdateObjEx(
    dsmUpdateObjExIn_t *dsmUpdateObjExInP,
    dsmUpdateObjExOut_t *dsmUpdateObjExOutP
);

```

```
#endif /* ifdef DYNALOAD */
```

```

#if defined(__cplusplus)
}
#endif

```

```
#endif /* _H_DSMAPIFP */
```

This section contains the function definitions for the API. It is a copy of the tsmapifp.h header file.

Note: DSMLINKAGE is defined differently for each operating system. See the definitions in the tsmapifs.h file for your specific operating system.

```

/*****
 * Tivoli Storage Manager
 * API Client Component
 *
 * (C) Copyright IBM Corporation 1993,2002
 *****/

/*****
/* Header File Name: tsmapifp.h
/*
/* Descriptive-name: Tivoli Storage Manager API function prototypes
*****/
#ifndef _H_TSMAPIFP
#define _H_TSMAPIFP

#if defined(__cplusplus)
extern "C" {
#endif

#ifdef DYNALOAD_DSMAPI

/* function will be dynamically loaded */
#include "dsmapidl.h"

#else

/* functions will be implicitly loaded from library */

/*****
/* P U B L I C   F U N C T I O N S
*****/

typedef void tsmQueryBuff;

extern dsInt16_t DSMLINKAGE tsmBeginGetData(

```

```

        dsUint32_t      tsmHandle,
        dsBool_t       mountWait,
        tsmGetType     getType,
        dsmGetList     *dsmGetObjListP
    );

extern dsInt16_t DSMLINKAGE tsmBeginQuery(
    dsUint32_t      tsmHandle,
    tsmQueryType   queryType,
    tsmQueryBuff   *queryBuffer
);

extern dsInt16_t DSMLINKAGE tsmBeginTxn(
    dsUint32_t      tsmHandle
);

extern dsInt16_t DSMLINKAGE tsmBindMC(
    dsUint32_t      tsmHandle,
    tsmObjName      *objNameP,
    tsmSendType     sendType,
    tsmMcBindKey    *mcBindKeyP
);

extern dsInt16_t DSMLINKAGE tsmChangePW(
    dsUint32_t      tsmHandle,
    dsChar_t        *oldPW,
    dsChar_t        *newPW
);

extern dsInt16_t DSMLINKAGE tsmCleanup(
    dsBool_t        mtFlag
);

extern dsInt16_t DSMLINKAGE tsmDeleteAccess(
    dsUint32_t      tsmHandle,
    dsUint32_t      ruleNum
);

extern dsInt16_t DSMLINKAGE tsmDeleteObj(
    dsUint32_t      tsmHandle,
    tsmDelType      delType,
    tsmDelInfo      delInfo
);

extern dsInt16_t DSMLINKAGE tsmDeleteFS(
    dsUint32_t      tsmHandle,
    dsChar_t        *fsName,
    dsUint8_t       repository
);

extern dsInt16_t DSMLINKAGE tsmEndGetData(
    dsUint32_t      tsmHandle
);

extern dsInt16_t DSMLINKAGE tsmEndGetDataEx(
    tsmEndGetDataExIn_t *tsmEndGetDataExInP,
    tsmEndGetDataExOut_t *tsmEndGetDataExOutP
);

extern dsInt16_t DSMLINKAGE tsmEndGetObj(
    dsUint32_t      tsmHandle
);

extern dsInt16_t DSMLINKAGE tsmEndQuery(
    dsUint32_t      tsmHandle
);

extern dsInt16_t DSMLINKAGE tsmEndSendObj(
    dsUint32_t      tsmHandle
);

extern dsInt16_t DSMLINKAGE tsmEndSendObjEx(
    tsmEndSendObjExIn_t *tsmEndSendObjExInP,

```

```

        tsmEndSendObjExOut_t      *tsmEndSendObjExOutP
    );

extern dsInt16_t DSMLINKAGE tsmEndTxn(
    dsUint32_t      tsmHandle,
    dsUint8_t       vote,
    dsUint16_t      *reason
);

extern dsInt16_t DSMLINKAGE tsmEndTxnEx(
    tsmEndTxnExIn_t *tsmEndTxnExInP,
    tsmEndTxnExOut_t *tsmEndTxnExOutP
);

extern dsInt16_t DSMLINKAGE tsmGetData(
    dsUint32_t      tsmHandle,
    DataBlk*dataBlkPtr
);

extern dsInt16_t DSMLINKAGE tsmGetBufferData(
    getBufferDataIn_t *tsmGetBufferDataInP,
    getBufferDataOut_t *tsmGetBufferDataOutP
);

extern dsInt16_t DSMLINKAGE tsmGetNextQObj(
    dsUint32_t      tsmHandle,
    DataBlk*dataBlkPtr
);

extern dsInt16_t DSMLINKAGE tsmGetObj(
    dsUint32_t      tsmHandle,
    ObjID           *objIdP,
    DataBlk         *dataBlkPtr
);

extern dsInt16_t DSMLINKAGE tsmGroupHandler(
    tsmGroupHandlerIn_t *tsmGroupHandlerInP,
    tsmGroupHandlerOut_t *tsmGroupHandlerOutP
);

extern dsInt16_t DSMLINKAGE tsmInitEx(
    dsUint32_t      *tsmHandleP,
    tsmInitExIn_t   *tsmInitExInP,
    tsmInitExOut_t  *tsmInitExOutP
);

extern dsInt16_t DSMLINKAGE tsmLogEventEx(
    dsUint32_t      tsmHandle,
    tsmLogExIn_t    *tsmLogExInP,
    tsmLogExOut_t   *tsmLogExOutP
);

extern dsInt16_t DSMLINKAGE tsmQueryAccess(
    dsUint32_t      tsmHandle,
    tsmQryRespAccessData **accessListP,
    dsUint16_t      *numberOfRules
);

extern void DSMLINKAGE tsmQueryApiVersionEx(
    tsmApiVersionEx *apiVersionP
);

extern dsInt16_t DSMLINKAGE tsmQueryCliOptions(
    tsmOptStruct *optstructP
);

extern dsInt16_t DSMLINKAGE tsmQuerySessInfo(
    dsUint32_t      tsmHandle,
    tsmApiSessInfo *SessInfoP
);

extern dsInt16_t DSMLINKAGE tsmQuerySessOptions(

```

```

        dsUint32_t          tsmHandle,
        tsmOptStruct      *optstructP
    );

extern dsInt16_t DSMLINKAGE tsmRCMsg(
    dsUint32_t          tsmHandle,
    dsInt16_t          tsmRC,
    dsChar_t           *msg
);

extern dsInt16_t DSMLINKAGE tsmRegisterFS(
    dsUint32_t          tsmHandle,
    tsmRegFSData       *regFilespaceP
);

extern dsInt16_t DSMLINKAGE tsmReleaseBuffer(
    releaseBufferIn_t  *tsmReleaseBufferInP,
    releaseBufferOut_t *tsmReleaseBufferOutP
);

extern dsInt16_t DSMLINKAGE tsmRenameObj(
    tsmRenameIn_t      *tsmRenameInP,
    tsmRenameOut_t     *tsmRenameOutP
);

extern dsInt16_t DSMLINKAGE tsmRequestBuffer(
    requestBufferIn_t  *tsmRequestBufferInP,
    requestBufferOut_t *tsmRequestBufferOutP
);

extern dsInt16_t DSMLINKAGE tsmRetentionEvent(
    tsmRetentionEventIn_t *tsmRetentionEventInP,
    tsmRetentionEventOut_t *tsmRetentionEventOutP
);

extern dsInt16_t DSMLINKAGE tsmSendBufferData(
    sendBufferDataIn_t  *tsmSendBufferDataInP,
    sendBufferDataOut_t *tsmSendBufferDataOutP
);

extern dsInt16_t DSMLINKAGE tsmSendData(
    dsUint32_t          tsmHandle,
    DataBlk            *dataBlkPtr
);

extern dsInt16_t DSMLINKAGE tsmSendObj(
    dsUint32_t          tsmHandle,
    tsmSendType        sendType,
    void               *sendBuff,
    tsmObjName         *objNameP,
    tsmObjAttr         *objAttrPtr,
    DataBlk            *dataBlkPtr
);

extern dsInt16_t DSMLINKAGE tsmSetAccess(
    dsUint32_t          tsmHandle,
    tsmAccessType       accessType,
    tsmObjName         *objNameP,
    dsChar_t           *node,
    dsChar_t           *owner
);

extern dsInt16_t DSMLINKAGE tsmSetUp(
    dsBool_t           mtFlag,
    tsmEnvSetUp        *envSetUpP
);

extern dsInt16_t DSMLINKAGE tsmTerminate(
    dsUint32_t          tsmHandle
);

extern dsInt16_t DSMLINKAGE tsmUpdateFS(
    dsUint32_t          tsmHandle,
    dsChar_t           *fs,

```

```

        tsmFSUpd          *fsUpdP,
        dsUint32_t        fsUpdAct
    );

extern dsInt16_t DSMLINKAGE tsmUpdateObj(
    dsUint32_t            tsmHandle,
    tsmSendType          sendType,
    void                  *sendBuff,
    tsmObjName            *objNameP,
    tsmObjAttr            *objAttrPtr,
    dsUint32_t            objUpdAct
);

extern dsInt16_t DSMLINKAGE tsmUpdateObjEx(
    tsmUpdateObjExIn_t    *tsmUpdateObjExInP,
    tsmUpdateObjExOut_t   *tsmUpdateObjExOutP
);

#endif /* ifdef DYNALOAD */

#ifdef __cplusplus
}
#endif

#endif /* _H_TSMAPIFP */

```

## Application programming interface documentation in PDF files

---

The information about the IBM Spectrum Protect™ application programming interface (API) that is available in IBM Knowledge Center is also available in PDF files.

- Using the Application Programming Interface
- Client Messages and Application Programming Interface Return Codes

### Related information:

Developing solutions with the application programming interface

## Wydajność

---

Na wydajność serwera i klientów ma wpływ wiele czynników, takich jak system operacyjny, sprzęt, konfiguracja sieci, typy pamięci masowej oraz liczba i wielkość plików klientów. Interakcje między tymi czynnikami mogą utrudnić optymalizację wydajności.

To wydanie nie zawiera zaktualizowanej wersji komponentu wydajności. Dokumentację dotyczącą wydajności można znaleźć w serwisie wersja 8.1.0.

## Rozwiązywanie problemów

---

Dostępne są procedury lokalizowania i rozwiązywania problemów.

To wydanie nie zawiera zaktualizowanej wersji komponentu rozwiązywania problemów. Dokumentację rozwiązywania problemów można znaleźć w serwisie wersja 8.1.0.

## Messages, return codes, and error codes

---

Explanations and suggested actions are available for messages that are issued by IBM Spectrum Protect™ components.

- Introduction to messages
- IBM Global Security Kit return codes
  - The server and client use the IBM Global Security Kit (GSKit) for SSL (Secure Sockets Layer) processing between the server and the backup-archive client. Some messages that are issued for SSL processing include GSKit return codes.
- ANE: Client events logged to the server
- ANR: Server common and platform-specific messages
- ANS: Client messages



- API return codes
- I/O error code descriptions in server messages
- Device error codes in the AIX system error log
- [🔗 Troubleshooting \(V8.1.0 is the most recent publication\)](#)

## Introduction to messages

---

Messages, error codes, and return codes are issued by the IBM Spectrum Protect™ server and clients.

Messages and codes can appear on the server console, the administrative client, an operator terminal, the administrative graphical user interface, the backup-archive client, or the hierarchical storage management client (HSM client).

IBM Spectrum Protect provides an activity log to help the administrator track server activity and monitor the system. The activity log contains messages generated by the server, and is stored in the database. The server automatically deletes messages from the activity log after they have passed the specified retention period. Any messages sent to the server console are stored in the activity log. Examples of the types of messages stored in the activity log include:

- When client sessions start or end
- When migration starts or ends
- When backed up files are expired from server storage
- Any output generated from background processes

Some messages have no explanations and are not published. The client can send statistics to the server providing information about a backup or restore. These statistics are informational messages that can be enabled or disabled to the various event logging receivers. These messages are not published.

- IBM Spectrum Protect server and client messages format
- Interpreting return code messages

### Related tasks:

- [🔗 Using the activity log \(V7.1.1\)](#)

## IBM Spectrum Protect server and client messages format

---

IBM Spectrum Protect™ server and client messages consist of the following elements:

- A three-letter prefix. Messages have different prefixes to help you identify the IBM Spectrum Protect component that issues the message. Typically, all messages for a component have the same prefix. Sometimes a component issues messages with two or three different prefixes.

For example, backup-archive clients issue messages with the ANS prefix. Backup-archive client events that are logged to the server have the ANE prefix. Server common and server platform-specific messages have the ANR prefix.

- A numeric message identifier.
- A one-letter severity code. The following codes indicate the severity of the action that generated the message:

Code	Severity	Meaning
S	Severe	The product or a product function cannot continue. User response is required.
E	Error	An error is encountered during processing. Processing might stop. User response might be required.
W	Warning	Processing continues, but problems might occur later as a result of the warning.
I	Information	Processing continues. User response is not necessary.

- Message text that is displayed on screen and written to message logs.
- Explanation, System Action, and User Response texts. These texts elaborate on the message text, and are available in the product messages publications and in the command line help.

The following image presents a typical IBM Spectrum Protect server message.

The callouts identify each element of the message.

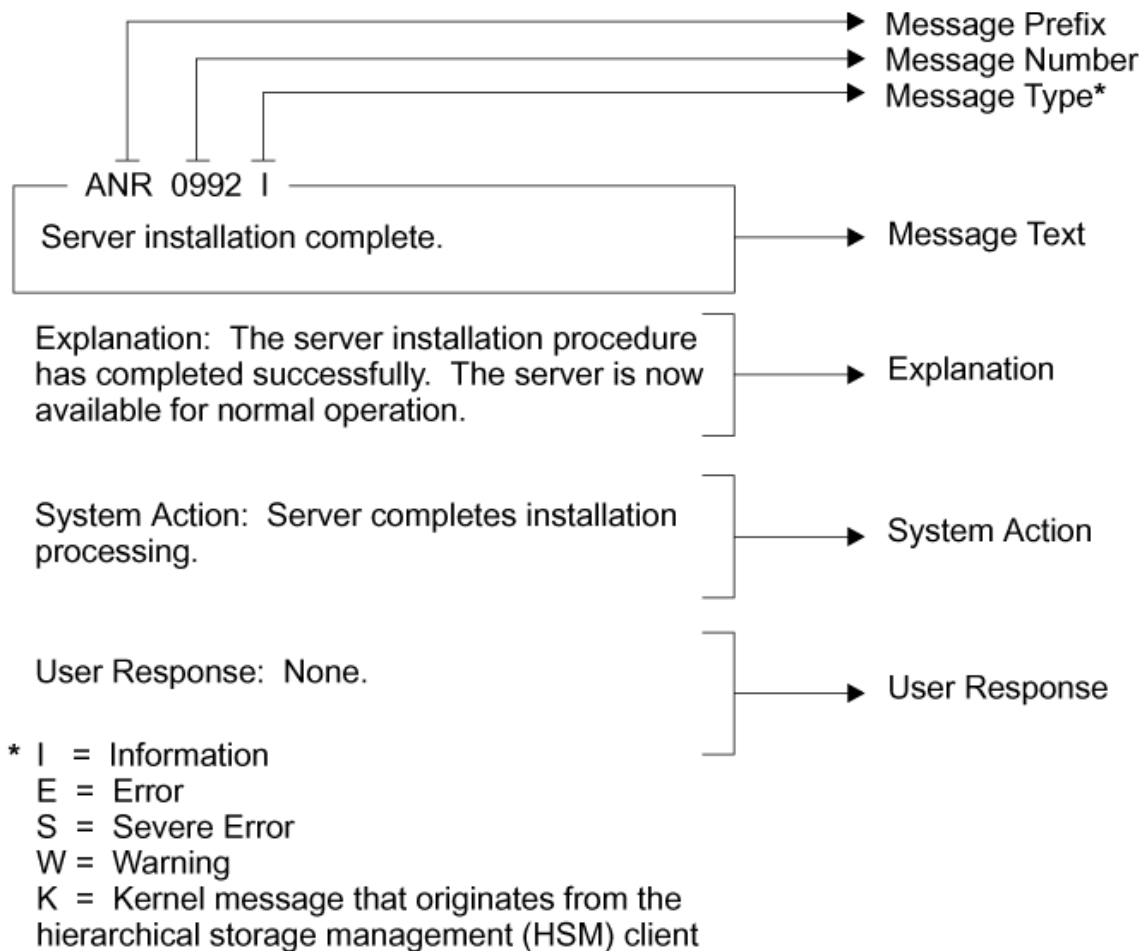

Message variables in the message text appear in italics.

## Interpreting return code messages

Many different commands can generate the same *return code*. The following examples are illustrations of two different commands issued that result in the same return code; therefore, you must read the *descriptive message* for the command.

In these examples, two different commands yield the same return code, but they also return descriptive messages that are unique to each command. The two commands are `q event standard dddd` and `def vol cstg05 primary`. Both yield a generic message with return code:

```
ANS5102I: Return Code 11.
```

But the first command also yields a descriptive message:

```
ANR2034I: QUERY EVENT: No match found for this query.
```

And the second command also yields a unique, descriptive message:

```
ANRxxxx: DEFINE VOLUME: Storage pool CSTG05 is not defined.
```

- Example one for QUERY EVENT command
- Example two for DEFINE VOLUME command

## Example one for QUERY EVENT command

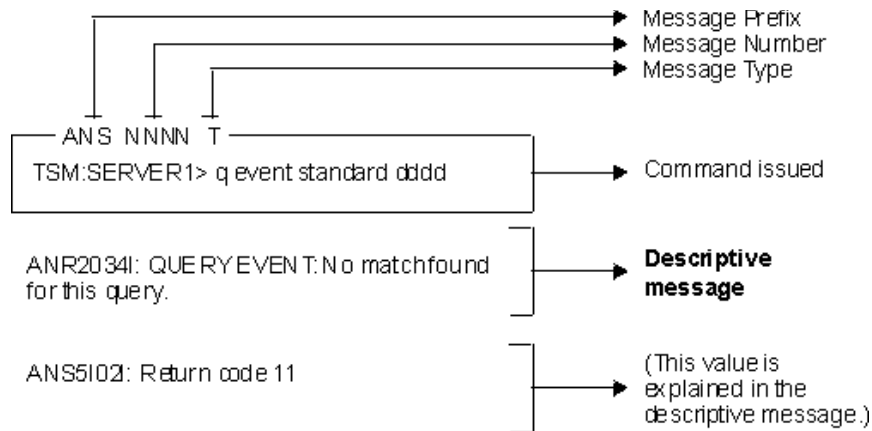

## Example two for DEFINE VOLUME command

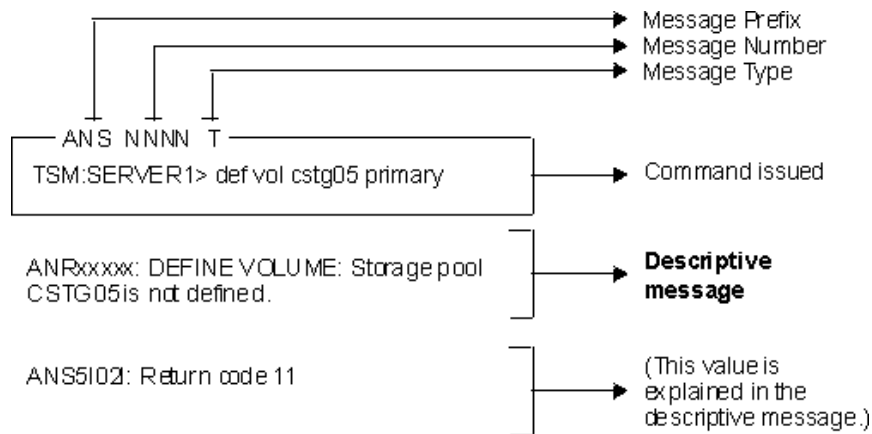

## ANE messages

ANE messages are issued by the server. All messages with the ANE prefix are client events logged to the server.

- ANE messages list

## ANR messages

ANR messages are issued by the server. Some ANR messages are common to all operating systems, and some are specific to a single operating system.

- ANR messages list

## ANS 0000-9999 messages

ANS messages with message numbers in the range 0000-9999 are issued by the following IBM Spectrum Protect™ clients:

- Administrative clients
- Application programming interface clients
- Backup–archive clients
- IBM Spectrum Protect for Space Management (HSM) clients

A list of new and changed messages since the previous product modification level is available in the client\_message.chg file in the product installation directory. The lists of new and changed client messages for V8.1.2 and later are also available in the IBM developerWorks wiki.

- ANS messages list

## API return codes

---

IBM Spectrum Protect™ V8.1.2 API return codes are listed. The format of the return codes is described.

In addition, some messages that are issued for SSL processing include GSKit return codes. See IBM Global Security Kit return codes for details.

- API return code format
- API return codes

## API return code format

---

This section explains the API (Application Programming Interface) return code format. For each return code, the following information is provided:

- The return code number. This number corresponds to the number in the **dsmrc.h** header file.
- The severity code. This letter is an indication of the severity that generated the return code. The severity codes and their meanings are:

<b>S</b>	Severe error	Processing cannot continue.
<b>E</b>	Error	Processing cannot continue.
<b>W</b>	Warning	Processing can continue, but problems might develop later. You should be cautious.
<b>I</b>	Information	Processing continues. User response is not necessary.

- The symbolic name. This name corresponds to the definition in the header file, **dsmrc.h**. *Always use the symbolic name for a return code in your application rather than the return code number.*
- The explanation. This field explains the circumstances under which this return code might be generated.
- The system action. This field describes what action IBM Spectrum Protect™ is going to take in response to the return code.
- The user response. This field explains how you should respond to the system action.

Many of the return codes describe errors that cause processing to stop. You can send a message to the end user that describes the problem and suggest a course of action. To identify different messages, use these return code values or develop your own numbering system.

## API return codes

---

IBM Spectrum Protect™ V8.1.2 API return codes are listed in ascending numeric order. The complete return code is documented.

- -452 E  
DSM\_RC\_SHM\_NOTAUTH Insufficient authority to connect to the shared memory region
- -451 E  
DSM\_RC\_SHM\_FAILURE An error occurred using the Shared Memory protocol
- -450 E  
DSM\_RC\_SHM\_TCPIP\_FAILURE Session rejected: TCP/IP connection failure for Shared Memory
- -190 E  
DSM\_RC\_NP\_ERROR Session rejected: Named Pipes connection failure.
- -057 E  
DSM\_RC\_TCPIP\_LOADFAILURE The TCP/IP load function failed.
- -056 E  
DSM\_RC\_TCPIP\_DLL\_LOADFAILURE An error occurred while loading a library.
- -055 E  
DSM\_RC\_WINSOCK\_MISSING The TCP/IP WINSOCK.DLL file cannot be found.
- -054 E  
DSM\_RC\_NETWORK\_UNREACHABLE The specified TCP/IP host name is unreachable
- -053 E  
DSM\_RC\_BAD\_HOST\_NAME An invalid TCP/IP address was specified.
- -052 E  
DSM\_RC\_CONN\_REFUSED An attempt to establish a TCP/IP connection was rejected by the host
- -051 E  
DSM\_RC\_CONN\_TIMEDOUT The attempt to establish a TCP/IP connection timed out before the connection was made.

- -050 E  
DSM\_RC\_TCPIP\_FAILURE Session rejected: TCP/IP connection failure.
- 0000 I  
DSM\_RC\_OK Successfully done.
- 0001 E  
DSM\_RC\_ABORT\_SYSTEM\_ERROR This operation cannot continue due to an error on the IBM Spectrum Protect server. See your IBM Spectrum Protect server administrator for assistance.
- 0002 E  
DSM\_RC\_ABORT\_NO\_MATCH No objects on server match query
- 0003 E  
DSM\_RC\_ABORT\_BY\_CLIENT Client ended transaction
- 0004 W  
DSM\_RC\_ABORT\_ACTIVE\_NOT\_FOUND An active backup version could not be found.
- 0005 E  
DSM\_RC\_ABORT\_NO\_DATA The IBM Spectrum Protect server has no data for the object.
- 0006 E  
DSM\_RC\_ABORT\_BAD\_VERIFIER You entered an incorrect password.
- 0007 E  
DSM\_RC\_ABORT\_NODE\_IN\_USE Node in use
- 0008 E  
DSM\_RC\_ABORT\_EXPIRATE\_TOO\_LOW Expiration date must be greater than today's date
- 0009 W  
DSM\_RC\_ABORT\_DATA\_OFFLINE The requested data is offline.
- 0010 E  
DSM\_RC\_ABORT\_EXCLUDED\_BY\_SIZE Object too large for server limits
- 0011 E  
DSM\_RC\_ABORT\_NO\_REPOSIT\_SPACE Server out of data storage space
- 0012 E  
DSM\_RC\_ABORT\_MOUNT\_NOT\_POSSIBLE Server media mount not possible
- 0013 E  
DSM\_RC\_ABORT\_SIZEESTIMATE\_EXCEED Size estimate exceeded
- 0014 E  
DSM\_RC\_ABORT\_DATA\_UNAVAILABLE File data currently unavailable on server
- 0015 E  
DSM\_RC\_ABORT\_RETRY Unexpected retry request. The IBM Spectrum Protect server found an error while writing the data.
- 0016 E  
DSM\_RC\_ABORT\_NO\_LOG\_SPACE The server does not have enough recovery log space to continue the current operation
- 0017 E  
DSM\_RC\_ABORT\_NO\_DB\_SPACE The server does not have enough database space to continue the current operation
- 0018 E  
DSM\_RC\_ABORT\_NO\_MEMORY The server does not have enough memory to continue the current operation.
- 0020 E  
DSM\_RC\_ABORT\_FS\_NOT\_DEFINED The specified file space does not exist on the server. The file space might have been deleted by another client or an administrator.
- 0021 S  
DSM\_RC\_ABORT\_NODE\_ALREADY\_DEFINED Open Registration failed because the specified node name is defined in the server
- 0022 S  
DSM\_RC\_ABORT\_NO\_DEFAULT\_DOMAIN Open Registration failed because no default domain exists
- 0023 S  
DSM\_RC\_ABORT\_INVALID\_NODENAME Open Registration failed because an invalid node name was specified
- 0024 S  
DSM\_RC\_ABORT\_INVALID\_POL\_BIND A policy management problem has occurred on the IBM Spectrum Protect server.
- 0024 E  
DSM\_RC\_ABORT\_NO\_INVALID\_POL\_BIND An object in the transaction has been bound to an invalid management class.
- 0025 E  
DSM\_RC\_ABORT\_DEST\_NOT\_DEFINED Server problem: Destination not defined.
- 0026 S  
DSM\_RC\_ABORT\_WAIT\_FOR\_SPACE The IBM Spectrum Protect server does not currently have space in the storage pool for this file. This may be a temporary condition.
- 0027 E  
DSM\_RC\_ABORT\_NOT\_AUTHORIZED The file space cannot be deleted because this node does not have permission to

delete archived or backed up data.

- 0028 E  
DSM\_RS\_ABORT\_RULE\_ALREADY\_DEFED 'Access rule' Access Rule already defined for node 'node'. Old rule must be deleted before new one can be defined.
- 0029 S  
DSM\_RC\_ABORT\_NO\_STOR\_SPACE\_STOP Server out of data storage space
- 0030 E  
DSM\_RC\_ABORT\_LICENSE\_VIOLATION The operation is not permitted due to server licenses values.
- 0032 E  
DSM\_RC\_ABORT\_DUPLICATE\_OBJECT A duplicate object was found, operation cannot complete.
- 0033 E  
DSM\_RC\_ABORT\_INVALID\_OFFSET partialObjOffset value for partial object retrieve is invalid.
- 0034 E  
DSM\_RC\_ABORT\_INVALID\_LENGTH partialObjLength value for partial object retrieve is invalid.
- 0036 E  
DSM\_RC\_END\_NODE\_NOT\_AUTHORIZED The node or user does not have proper authority to perform this operation
- 0041 E  
DSM\_RC\_ABORT\_EXCEED\_MAX\_MP This node has exceeded its maximum number of mount points.
- 0045 E  
DSM\_RC\_ABORT\_MERGE\_ERROR The specified objects failed the merge test.
- 0047 E  
DSM\_RC\_ABORT\_INVALID\_OPERATION An invalid operation was attempted on a node
- 0048 E  
DSM\_RC\_ABORT\_STGPOOL\_UNDEFINED The specified target storage pool is not defined.
- 0049 E  
DSM\_RC\_ABORT\_INVALID\_DATA\_FORMAT A target storage pool does not have the correct data format for the given node type.
- 0050 E  
DSM\_RC\_ABORT\_DATAMOVER\_UNDEFINED No associated data mover is defined for the given node.
- 0051 E  
DSM\_RC\_REJECT\_NO\_RESOURCES Session rejected: All server sessions are currently in use
- 0052 E  
DSM\_RC\_REJECT\_VERIFIER\_EXPIRED The session is rejected. Your password has expired.
- 0053 E  
DSM\_RC\_REJECT\_ID\_UNKNOWN Session rejected: User ID is incorrect, does not have admin authority, or is not known by the server
- 0054 E  
DSM\_RC\_REJECT\_DUPLICATE\_ID Session rejected: Duplicate ID entered
- 0055 E  
DSM\_RC\_REJECT\_SERVER\_DISABLED Session rejected: Server disabled.
- 0056 E  
DSM\_RC\_REJECT\_CLOSED\_REGISTER The server is not configured to allow open registration
- 0057 S  
DSM\_RC\_REJECT\_CLIENT\_DOWNLEVEL Session rejected: Downlevel client code version
- 0058 S  
DSM\_RC\_REJECT\_SERVER\_DOWNLEVEL Session rejected: Downlevel server code version
- 0059 E  
DSM\_RC\_REJECT\_ID\_IN\_USE Session Rejected: The specified node name is currently in use
- 0061 E  
DSM\_RC\_REJECT\_ID\_LOCKED Session Rejected: The specified node name is currently locked.
- 0062 S  
DSM\_RC\_SIGNONREJECT\_LICENSE\_MAX SLM LICENSE EXCEEDED: The client licenses for IBM Spectrum Protect are exceeded. See your system administrator.
- 0063 E  
DSM\_RC\_REJECT\_NO\_MEMORY Session Rejected: The server does not have enough memory to allow a connection to be established.
- 0064 E  
DSM\_RC\_REJECT\_NO\_DB\_SPACE Session Rejected: The server does not have enough database space to allow a connection to be established.
- 0065 E  
DSM\_RC\_REJECT\_NO\_LOG\_SPACE Session Rejected: The server does not have enough recovery log space to allow a connection to be established.

- 0066 E  
DSM\_RC\_REJECT\_INTERNAL\_ERROR The session is rejected. The IBM Spectrum Protect server has an internal error.
- 0067 S  
DSM\_RC\_SIGNONREJECT\_INVALID\_CLI Session Rejected: The server is not licensed for this platform type. See your system administrator.
- 0068 E  
DSM\_RC\_CLIENT\_NOT\_ARCHRETPROT The session is rejected. The server does not allow a signon of a client that is not archive-retention protection enabled.
- 0069 E  
DSM\_RC\_SESSION\_CANCELED Session Rejected: The session was canceled by the server administrator.
- 0073 E  
DSM\_RC\_REJECT\_INVALID\_NODE\_TYPE An inconsistency was detected between the client node and the node that is registered to the IBM Spectrum Protect server.
- 0074 E  
DSM\_RC\_REJECT\_INVALID\_SESSIONINIT Server does not allow client-initiated connections for this node.
- 0075 E  
DSM\_RC\_REJECT\_WRONG\_PORT Wrong server port.
- 0079 E  
DSM\_RC\_CLIENT\_NOT\_SPMRETPROT The session is rejected. The server does not allow a signon of a client that is not enabled for space-management retention-protection.
- 0101 W  
DSM\_RC\_USER\_ABORT The operation was stopped by the user.
- 0102 E  
DSM\_RC\_NO\_MEMORY file name(line number)The operating system refused a IBM Spectrum Protect request for memory allocation.
- 0104 E  
DSM\_RC\_FILE\_NOT\_FOUND File not found during Backup, Archive or Migrate processing
- 0105 E  
DSM\_RC\_PATH\_NOT\_FOUND The specified directory path 'pathname' could not be found.
- 0106 E  
DSM\_RC\_ACCESS\_DENIED Access to the specified file or directory is denied
- 0106 E  
DSM\_RC\_ACCESS\_DENIED The specified file is being used by another process
- 0107 E  
DSM\_RC\_NO\_HANDLES No file handles available
- 0108 E  
DSM\_RC\_FILE\_EXISTS The file exists and cannot be overwritten.
- 0109 E  
DSM\_RC\_INVALID\_PARM Invalid parameter was found.
- 0110 E  
DSM\_RC\_INVALID\_HANDLE An invalid file handle was passed; system error.
- 0111 E  
DSM\_RC\_DISK\_FULL Processing stopped; Disk full condition
- 0113 E  
DSM\_RC\_PROTOCOL\_VIOLATION Protocol violation
- 0114 E  
DSM\_RC\_UNKNOWN\_ERROR An unknown system error has occurred from which IBM Spectrum Protect cannot recover.
- 0115 E  
DSM\_RC\_UNEXPECTED\_ERROR An unexpected error occurred.
- 0116 E  
DSM\_RC\_FILE\_BEING\_EXECUTED File is in use; Write permission denied.
- 0117 E  
DSM\_RC\_DIR\_NO\_SPACE No more files can be restored or retrieved since the destination directory is full.
- 0118 E  
DSM\_RC\_LOOPED\_SYM\_LINK Too many symbolic links were detected while resolving name
- 0119 E  
DSM\_RC\_FILE\_NAME\_TOO\_LONG The file name is too long and can not be processed by IBM Spectrum Protect
- 0120 E  
DSM\_RC\_FILE\_SPACE\_LOCKED File system is locked by system
- 0121 I  
DSM\_RC\_FINISHED The operation is finished.

- 0122 E  
DSM\_RC\_UNKNOWN\_FORMAT The file has an unknown format.
- 0123 E  
DSM\_RC\_NO\_AUTHORIZATION Not authorized to restore the other node's data.
- 0124 E  
DSM\_RC\_FILE\_SPACE\_NOT\_FOUND File space 'filespace-name' does not exist
- 0125 E  
DSM\_RC\_TXN\_ABORTED Transaction aborted
- 0126 E  
DSM\_RC\_SUBDIR\_AS\_FILE IBM Spectrum Protect cannot build a directory path because a file exists with the same name as the directory.
- 0127 E  
DSM\_RC\_PROCESS\_NO\_SPACE Disk space limit for this process reached
- 0128 E  
DSM\_RC\_PATH\_TOO\_LONG Destination directory path length exceeds system maximum
- 0129 E  
DSM\_RC\_NOT\_COMPRESSED File is not compressed; System failure.
- 0130 E  
DSM\_RC\_TOO\_MANY\_BITS File compressed on a different client machine that has more memory
- 0131 E  
DSM\_RC\_COMPRESSED\_DATA\_CORRUPTED The compressed file is corrupted and cannot be expanded correctly.
- 0131 S  
DSM\_RC\_SYSTEM\_ERROR An internal program error occurred.
- 0132 E  
DSM\_RC\_NO\_SERVER\_RESOURCES The IBM Spectrum Protect server is out of resources.
- 0133 E  
DSM\_RC\_FS\_NOT\_KNOWN The file space for domain 'domain-name' could not be found on the IBM Spectrum Protect server.
- 0134 E  
DSM\_RC\_NO\_LEADING\_DIRSEP The objName field has no leading directory separator.
- 0135 E  
DSM\_RC\_WILDCARD\_DIR Wildcards are not allowed in the objName directory path.
- 0136 E  
DSM\_RC\_COMM\_PROTOCOL\_ERROR The session is rejected: There was a communications protocol error.
- 0137 E  
DSM\_RC\_AUTH\_FAILURE Session rejected: Authentication failure
- 0138 E  
DSM\_RC\_TA\_NOT\_VALID The dsmtca execution/owner permissions are invalid.
- 0139 S  
DSM\_RC\_KILLED Process killed.
- 0145 S  
DSM\_RC\_WOULD\_BLOCK The dsmtca would block the operation.
- 0146 S  
DSM\_RC\_TOO\_SMALL The area for the include/exclude pattern is too small.
- 0147 S  
DSM\_RC\_UNCLOSED There is no closing bracket in the pattern.
- 0148 S  
DSM\_RC\_NO\_STARTING\_DELIMITER Include/Exclude pattern must start with a directory delimiter
- 0149 S  
DSM\_RC\_NEEDED\_DIR\_DELIMITER A beginning or ending directory delimiter is missing from the Include/Exclude pattern.
- 0151 S  
DSM\_RC\_BUFFER\_OVERFLOW The data buffer overflowed.
- 0154 E  
DSM\_RC\_NO\_COMPRESS\_MEMORY Insufficient memory for file compression/expansion
- 0155 T  
DSM\_RC\_COMPRESS\_GREW Compressed Data Grew
- 0156 E  
DSM\_RC\_INV\_COMM\_METHOD An unsupported communications method was specified.
- 0157 S  
DSM\_RC\_WILL\_ABORT The transaction will be aborted.
- 0158 E  
DSM\_RC\_FS\_WRITE\_LOCKED Destination file or directory is write locked



- 0159 I  
DSM\_RC\_SKIPPED\_BY\_USER A file was skipped during a restore operation because the file is off line and the application has chosen not to wait for a tape mount.
- 0160 E  
DSM\_RC\_TA\_NOT\_FOUND Unable to find the dsmtca module.
- 0162 E  
DSM\_RC\_FS\_NOT\_READY File system/drive not ready
- 0164 E  
DSM\_RC\_FIO\_ERROR File input/output error
- 0165 E  
DSM\_RC\_WRITE\_FAILURE File write error
- 0166 E  
DSM\_RC\_OVER\_FILE\_SIZE\_LIMIT File exceeds system/user file limits
- 0167 E  
DSM\_RC\_CANNOT\_MAKE Cannot make file/directory
- 0168 E  
DSM\_RC\_NO\_PASS\_FILE Password file is not available.
- 0169 E  
DSM\_RC\_VERFILE\_OLD PASSWORDACCESS is GENERATE, but password needed for server 'server-name'. Either the password is not stored locally, or it was changed at the server.
- 0173 E  
DSM\_RC\_INPUT\_ERROR The process is running in a non-interactive mode, but requires user input.
- 0174 E  
DSM\_RC\_REJECT\_PLATFORM\_MISMATCH Session rejected: Node type mismatch
- 0175 E  
DSM\_RC\_TL\_NOT\_FILE\_OWNER Not file owner
- 0177 S  
DSM\_RC\_UNMATCHED\_QUOTE Quotes are not matched
- 0184 E  
DSM\_RC\_TL\_NOBCG The management class for this file does not have a valid backup copy group. This file will not be backed up.
- 0185 W  
DSM\_RC\_TL\_EXCLUDED File 'file-namefile-namefile-name' excluded by Include/Exclude list
- 0186 E  
DSM\_RC\_TL\_NOACG The management class for this file does not have a valid archive copy group. This file will not be archived.
- 0187 E  
DSM\_RC\_PS\_INVALID\_ARCHMC Invalid management class entered
- 0188 S  
DSM\_RC\_NO\_PS\_DATA Either the node does not exist on the server or there is no active policy set for the node.
- 0189 S  
DSM\_RC\_PS\_INVALID\_DIRMC The management class assigned to directories does not exist.
- 0190 S  
DSM\_RC\_PS\_NO\_CG\_IN\_DIR\_MC There is no backup copy group in the management class used for directories.
- 0231 E  
DSM\_RC\_ABORT\_MOVER\_TYPE Unknown Remote Mover type
- 0232 E  
DSM\_RC\_ABORT\_ITEM\_IN\_USE An Operation for the requested node and file space is already in progress.
- 0233 E  
DSM\_RC\_ABORT\_LOCK\_CONFLICT System resource in use
- 0234 E  
DSM\_RC\_ABORT\_SRV\_PLUGIN\_COMM\_ERROR Server plugin communication error
- 0235 E  
DSM\_RC\_ABORT\_SRV\_PLUGIN\_OS\_ERROR Server plugin detected unsupported NAS filer operating system.
- 0236E  
DSM\_RC\_ABORT\_CRC\_FAILED The CRC received from the Server does not match the CRC calculated by the client.
- 0237E  
DSM\_RC\_ABORT\_INVALID\_GROUP\_ACTION An invalid operation was attempted on a group leader or group member.
- 0238E  
DSM\_RC\_ABORT\_DISK\_UNDEFINED Remote disk not defined.
- 0239E  
DSM\_RC\_ABORT\_BAD\_DESTINATION Input destination does not match expected destination.

- 0240E  
DSM\_RC\_ABORT\_DATAMOVER\_NOT\_AVAILABLE Data mover is not available.
- 0241E  
DSM\_RC\_ABORT\_STGPOOL\_COPY\_CONT\_NO Operation failed because the copy continue option was set to NO.
- 0242E  
DSM\_RC\_ABORT\_RETRY\_SINGLE\_TXN Transaction failed because of a problem during a store operation.
- 0245 E  
DSM\_RC\_ABORT\_PATH\_RESTRICTED The current client configuration does not comply with the value of the DATAWRITEPATH or DATAREADPATH server option for this node.
- 0247 E  
DSM\_RC\_ABORT\_INSERT\_NOT\_ALLOWED This server does not support backup operations.
- 0248 E  
DSM\_RC\_ABORT\_DELETE\_NOT\_ALLOWED Deleting this object: "fshlll" is not allowed.
- 0249 E  
DSM\_RC\_ABORT\_TXN\_LIMIT\_EXCEEDED The number of objects in this transaction exceed TXNGROUPMAX values.
- 0250 E  
DSM\_RC\_ABORT\_OBJECT\_ALREADY\_HELD fshlll is already under hold.
- 0292 E  
DSM\_RC\_TCA\_FORK\_FAILED Error starting the dsmtca or dsmenc process.
- 0295 E  
DSM\_RC\_TCA\_INVALID\_REQUEST The IBM Spectrum Protect dsmtca received an invalid request.
- 0296 E  
DSM\_RC\_TCA\_NOT\_ROOT This action requires IBM Spectrum Protect administrative authority on this system.
- 0297 E  
DSM\_RC\_TCA\_SEMGET\_ERROR Error allocating semaphores.
- 0298 E  
DSM\_RC\_TCA\_SEM\_OP\_ERROR Error setting semaphore value or waiting on semaphore.
- 0400 E  
DSM\_RC\_INVALID\_OPT An invalid option was found during option parsing.
- 0405 E  
DSM\_RC\_NO\_HOST\_ADDR TCPSERVERADDRESS not defined for this server in the System Options File
- 0406 S  
DSM\_RC\_NO\_OPT\_FILE Options file 'file-name' could not be found, or it cannot be read.
- 0408 E  
DSM\_RC\_MACHINE\_SAME A virtual node name must not equal either a node name or the system host name.
- 0409 E  
DSM\_RC\_INVALID\_SERVER Server name not found in System Options File
- 0410 E  
DSM\_RC\_INVALID\_KEYWORD An invalid option keyword was found during option parsing.
- 0411 S  
DSM\_RC\_PATTERN\_TOO\_COMPLEX The include or exclude pattern cannot be parsed.
- 0412 S  
DSM\_RC\_NO\_CLOSING\_BRACKET Include/Exclude pattern is missing a closing bracket
- 0426 E  
DSM\_RC\_CANNOT\_OPEN\_TRACEFILE Initialization functions cannot open the trace file specified.
- 0427 E  
DSM\_RC\_CANNOT\_OPEN\_LOGFILE Initialization functions cannot open the error log file specified.
- 0600 E  
DSM\_RC\_DUP\_LABEL A duplicate volume label exists. The operation cannot continue.
- 0601 E  
DSM\_RC\_NO\_LABEL The drive has no label. The operation cannot continue.
- 0610 E  
DSM\_RC-NLS\_CANT\_OPEN\_TXT Unable to open message text file.
- 0611 E  
DSM\_RC-NLS\_CANT\_READ\_HDR Unable to use message text file.
- 0612 E  
DSM\_RC-NLS\_INVALID\_CNTL\_REC Unable to use message text file.
- 0613 E  
DSM\_RC-NLS\_INVALID\_DATE\_FMT Invalid value for DATEFORMAT specified.
- 0614 E  
DSM\_RC-NLS\_INVALID\_TIME\_FMT Invalid value for TIMEFORMAT specified.

- 0615 E  
DSM\_RC-NLS\_INVALID\_NUM\_FMT Invalid value for NUMBERFORMAT specified.
- 0620 E  
DSM\_RC\_LOG\_CANT\_BE\_OPENED Unable to open error log file.
- 0621 E  
DSM\_RC\_LOG\_ERROR\_WRITING\_TO\_LOG The log file cannot be written to.
- 0622 E  
DSM\_RC\_LOG\_NOT\_SPECIFIED The log file name was not specified.
- 0927 E  
DSM\_RC\_NOT\_ADSM\_AUTHORIZED Only a IBM Spectrum Protect authorized user can perform this Action.
- 961 E  
DSM\_RC\_DIRECT\_STORAGE\_AGENT\_UNSUPPORTED Direct connection to the Storage Agent is not allowed.
- 963 E  
DSM\_RC\_FS\_NAMESPACE\_DOWNLEVEL The long namespace has been removed from the local file space. If you wish to proceed with the backup/archive operation, rename your file space on the server.
- 0996 E  
DSM\_RC\_SERVER\_DOWNLEVEL\_FUNC The IBM Spectrum Protect server is downlevel and does not support the requested function. See error log for version information.
- 0997 E  
DSM\_RC\_STORAGEAGENT\_DOWNLEVEL The IBM Spectrum Protect Storage Agent is downlevel and does not support the requested function. See error log for version information.
- 0998 E  
DSM\_RC\_SERVER\_AND\_SA\_DOWNLEVEL The IBM Spectrum Protect Server and IBM Spectrum Protect Storage agent are downlevel and do not support the requested function. See error log for version information.
- 1376 E  
DSM\_RC\_DIGEST\_VALIDATION\_ERROR Error processing 'filespace namepath-namefile-name'; end-to-end digest validation failed.
- 2000 E  
DSM\_RC\_NULL\_OBJNAME The object name pointer is NULL.
- 2001 E  
DSM\_RC\_NULL\_DATABLKPTR The data block pointer is NULL.
- 2002 E  
DSM\_RC\_NULL\_MSG msg parameter for dsmRCMsg is a NULL pointer.
- 2004 E  
DSM\_RC\_NULL\_OBJATTRPTR The object attribute pointer is NULL.
- 2006 E  
DSM\_RC\_NO\_SESS\_BLK There is no server session information.
- 2007 E  
DSM\_RC\_NO\_POLICY\_BLK There is no server policy information.
- 2008 E  
DSM\_RC\_ZERO\_BUFLLEN The dataBlk bufferLen value is zero.
- 2009 E  
DSM\_RC\_NULL\_BUFPTR The dataBlk bufferPtr is NULL.
- 2010 E  
DSM\_RC\_INVALID\_OBJTYPE The objType is invalid.
- 2011 E  
DSM\_RC\_INVALID\_VOTE The dsmEndTxn vote is invalid.
- 2012 E  
DSM\_RC\_INVALID\_ACTION The update action is invalid.
- 2014 E  
DSM\_RC\_INVALID\_DS\_HANDLE There was an error in the IBM Spectrum Protect API internals.
- 2015 E  
DSM\_RC\_INVALID\_REPOS The repository type is invalid.
- 2016 E  
DSM\_RC\_INVALID\_FSNAME Filespace name should start with the directory delimiter.
- 2017 E  
DSM\_RC\_INVALID\_OBJNAME The object name is either an empty string or has no leading delimiter.
- 2018 E  
DSM\_RC\_INVALID\_LLNAME Low level qualifier of the object name should start with the directory delimiter.
- 2019 E  
DSM\_RC\_INVALID\_OBJOWNER The object owner is invalid.

- 2020 E  
DSM\_RC\_INVALID\_ACTYPE The dsmBindMC sendType is invalid.
- 2021 E  
DSM\_RC\_INVALID\_RETCODE no text available for this return code.
- 2022 E  
DSM\_RC\_INVALID\_SENDDTYPE The dsmSendObj sendType is invalid.
- 2023 E  
DSM\_RC\_INVALID\_PARAMETER The dsmDeleteObj delType is invalid.
- 2024 E  
DSM\_RC\_INVALID\_OBJSTATE The query Backup objState is invalid.
- 2025 E  
DSM\_RC\_INVALID\_MCNAME The management class name was not found.
- 2026 E  
DSM\_RC\_INVALID\_DRIVE\_CHAR The drive letter is not an alphabetic character.
- 2027 E  
DSM\_RC\_NULL\_FSNAME The Register Filespace name is NULL.
- 2028 E  
DSM\_RC\_INVALID\_HLNAME High level qualifier of the object name should start with the directory delimiter.
- 2029 E  
DSM\_RC\_NUMOBJ\_EXCEED The number of objects on dsmBeginGetData exceeds DSM\_MAX\_GET\_OBJ | DSM\_MAX\_PARTIAL\_GET\_OBJ.
- 2030 E  
DSM\_RC\_NEWPW\_REQD The new password value is NULL or blank.
- 2031 E  
DSM\_RC\_OLDPW\_REQD The old password value is NULL or blank.
- 2032 E  
DSM\_RC\_NO\_OWNER\_REQD On dsmInit, the owner is not allowed to establish a session when PASSWORDACCESS=generate.
- 2033 E  
DSM\_RC\_NO\_NODE\_REQD On dsmInit, the node is not allowed when PASSWORDACCESS=generate.
- 2034 E  
DSM\_RC\_KEY\_MISSING The key file is missing.
- 2035 E  
DSM\_RC\_KEY\_BAD The key file content is invalid.
- 2041 E  
DSM\_RC\_BAD\_CALL\_SEQUENCE The sequence of calls is invalid.
- 2042 E  
DSM\_RC\_INVALID\_TSMBUFFER The tsmBuffHandle is invalid, or the value of dataPtr is invalid.
- 2043 E  
DSM\_RC\_TOO\_MANY\_BYTES The number of bytes copied into the tsmBuffer is larger than the allowed value.
- 2044 E  
DSM\_RC\_MUST\_RELEASE\_BUFFER dsmTerminate cannot finish because the application is holding on to 1 or more tsmBuffers.
- 2045 E  
DSM\_RC\_BUFF\_ARRAY\_ERROR An internal error occurred in the tsmBuffer array.
- 2046 E  
DSM\_RC\_INVALID\_DATA\_BLK When using useTsmBuffers, dataBlk must be NULL in calls to dsmSendObj and dsmGetObj.
- 2047 E  
DSM\_RC\_ENCR\_NOT\_ALLOWED Encryption is not allowed when using useTsmBuffers.
- 2048 E  
DSM\_RC\_OBJ\_COMPRESSED This object cannot be restored/retrieved using useTsmBuffers, because it is compressed.
- 2049 E  
DSM\_RC\_OBJ\_ENCRYPTED This object cannot be restored/retrieved using useTsmBuffers, because it is encrypted.
- 2050 E  
DSM\_RC\_WILDCHAR\_NOTALLOWED On dsmSendObj, wildcards are not allowed for the objName.
- 2051 E  
DSM\_RC\_POR\_NOT\_ALLOWED When using useTsmBuffers, a restore/retrieve with partial object restore is not allowed.
- 2052 E  
DSM\_RC\_NO\_ENCRYPTION\_KEY No encryption key was found. If you are using -encryptkey=prompt make sure there is a value in the encryptionPasswordP field and that bEncryptKeyEnabled is set to true.
- 2053 E  
DSM\_RC\_ENCR\_CONFLICT Conflicting encryption key options have been specified.

- 2060 E  
DSM\_RC\_FSNAME\_NOTFOUND The filesystem to delete/set access cannot be found.
- 2061 E  
DSM\_RC\_FS\_NOT\_REGISTERED On dsmSendObj, dsmDeleteObj, or dsmUpdateFS the filesystem is not registered.
- 2062 W  
DSM\_RC\_FS\_ALREADY\_REGISTERED On dsmRegisterFS the filesystem is already registered.
- 2063 E  
DSM\_RC\_OBJID\_NOTFOUND On dsmBeginGetData the objID is NULL.
- 2064 E  
DSM\_RC\_WRONG\_VERSION On dsmInit, the caller API version is different than the IBM Spectrum Protect library version.
- 2065 E  
DSM\_RC\_WRONG\_VERSION\_PARM The caller's structure version is different than the IBM Spectrum Protect library version.
- 2070 E  
DSM\_RC\_NEEDTO\_ENDTXN Issue dsmEndTxn and then begin a new transaction session.
- 2080 E  
DSM\_RC\_OBJ\_EXCLUDED The backup or archive object is excluded from processing.
- 2081 E  
DSM\_RC\_OBJ\_NOBCG The backup object does not have a copy group.
- 2082 E  
DSM\_RC\_OBJ\_NOACG The archive object does not have a copy group.
- 2090 E  
DSM\_RC\_APISYSTEM\_ERROR Memory used by the IBM Spectrum Protect API has been corrupted.
- 2100 E  
DSM\_RC\_DESC\_TOOLONG The sendObj Archive description is too long.
- 2101 E  
DSM\_RC\_OBJINFO\_TOOLONG The sendObj ObjAttr.objInfo is too long.
- 2102 E  
DSM\_RC\_HL\_TOOLONG The sendObj dsmObjName.hl is too long.
- 2103 E  
DSM\_RC\_PASSWD\_TOOLONG The password, or encryptionPassword string provided is too long.
- 2104 E  
DSM\_RC\_FILESPACE\_TOOLONG The sendObj dsmObjName.fs is too long.
- 2105 E  
DSM\_RC\_LL\_TOOLONG The sendObj dsmObjName.ll is too long.
- 2106 E  
DSM\_RC\_FSINFO\_TOOLONG On RegisterFS or UpdateFS the fsAttr's fsInfo is too long.
- 2107 E  
DSM\_RC\_SENDDATA\_WITH\_ZERO\_SIZE Cannot Send data with a zero byte sizeEstimate.
- 2110 E  
DSM\_RC\_INVALID\_ACCESS\_TYPE The dsmSetAccess access Type is invalid.
- 2111 E  
DSM\_RC\_QUERY\_COMM\_FAILURE Communications error with server during object query
- 2112 E  
DSM\_RC\_NO\_FILES\_BACKUP No files have been previously backed up for this filename/filespace.
- 2113 E  
DSM\_RC\_NO\_FILES\_ARCHIVE No files have been previously archived for this filename/filespace.
- 2114 E  
DSM\_RC\_INVALID\_SETACCESS Invalid format for Set Access command.
- 2120 E  
DSM\_RC\_STRING\_TOO\_LONG The following message was too long to log to the server: 'shortened message with message number'
- 2200 I  
DSM\_RC\_MORE\_DATA On dsmGetNextQObj or dsmGetData there is more available data.
- 2210 E  
DSM\_RC\_BUFF\_TOO\_SMALL The dataBlk buffer is too small for the query response.
- 2228 E  
DSM\_RC\_NO\_API\_CONFIGFILE The configuration file specified on dsmInit cannot be opened.
- 2229 E  
DSM\_RC\_NO\_INCLEXCL\_FILE The Include/Exclude definition file was not found.
- 2230 E  
DSM\_RC\_NO\_SYS\_OR\_INCLEXCL Either the dsm.sys file was not found, or the Inclexcl file specified in dsm.sys was not

- found.
- 2231 E  
DSM\_RC\_REJECT\_NO\_POR\_SUPPORT Partial Object Retrieve is not supported on this server.
  - 2300 E  
DSM\_RC\_NEED\_ROOT Only a UNIX root user can execute dsmChangePW or dsmDeleteFS.
  - 2301 E  
DSM\_RC\_NEEDTO\_CALL\_BINDMC You must issue dsmBindMC before dsmSendObj.
  - 2302 I  
DSM\_RC\_CHECK\_REASON\_CODE The dsmEndTxn vote is ABORT, so check the reason field.
  - 2400 E  
DSM\_RC\_ALMGR\_OPEN\_FAIL License file could not be opened.
  - 2401 E  
DSM\_RC\_ALMGR\_READ\_FAIL Read failure on the license file.
  - 2402 E  
DSM\_RC\_ALMGR\_WRITE\_FAIL Write failure on the license file.
  - 2403 E  
DSM\_RC\_\_ALMGR\_DATA\_FMT Data in the license file is not in a valid format.
  - 2404 E  
DSM\_RC\_ALMGR\_CKSUM\_BAD The checksum in the license file does not match the licenseregistration string.
  - 2405 E  
DSM\_RC\_ALMGR\_TRIAL\_EXPRD This is an expired try and buy license.
  - 4580 E  
DSM\_RC\_ENC\_WRONG\_KEY Error processing 'filespace namepath-namefile-name'; invalid encryption key.
  - 4582 E  
DSM\_RC\_ENC\_NOT\_AUTHORIZED User is not authorized to encrypt file-space namedirectory\_pathfile\_name.
  - 4584 E  
DSM\_RC\_ENC\_TYPE\_UNKOWN Error processing 'filespace namepath-namefile-name': unsupported encryption type.
  - 4600 E  
DSM\_RC\_CLUSTER\_INFO\_LIBRARY\_NOT\_LOADED CLUSTERNODE is set to YES but the Cluster Information Daemon is notstarted.
  - 4601 E  
DSM\_RC\_CLUSTER\_LIBRARY\_INVALID CLUSTERNODE is set to YES but the cluster load library is not valid.
  - 4602 E  
DSM\_RC\_CLUSTER\_LIBRARY\_NOT\_LOADED CLUSTERNODE is set to YES but the cluster software is not availableon this system.
  - 4603 E  
DSM\_RC\_CLUSTER\_NOT\_MEMBER\_OF\_CLUSTER CLUSTERNODE is set to YES but this machine is not a member of acluster.
  - 4604 E  
DSM\_RC\_CLUSTER\_NOT\_ENABLED CLUSTERNODE is set to YES but the cluster service is not enabledon this system.
  - 4605 E  
DSM\_RC\_CLUSTER\_NOT\_SUPPORTED The CLUSTERNODE option is not supported on this system.
  - 4606 E  
DSM\_RC\_CLUSTER\_UNKNOWN\_ERROR An unexpected error (retcode) occurred while the program was trying to obtain the cluster name from the system.
  - 5200 E  
DSM\_RC\_ABORT\_CERTIFICATE\_NOT\_FOUND The remote node is not properly configured on the IBM Spectrum Protect server.
  - 5702 E  
DSM\_RC\_PROXY\_REJECT\_NO\_RESOURCES Proxy Rejected: The IBM Spectrum Protect server has run out of memory.
  - 5705 E  
DSM\_RC\_PROXY\_REJECT\_DUPLICATE\_ID Proxy Rejected: The ASNODENAME and NODENAME options have the same value.
  - 5710 E  
DSM\_RC\_PROXY\_REJECT\_ID\_IN\_USE Proxy Rejected: The node name you specified in the ASNODENAME option is locked.
  - 5717 E  
DSM\_RC\_PROXY\_REJECT\_INTERNAL\_ERROR Proxy Rejected: The server has an internal error.
  - 5722 E  
DSM\_RC\_PROXY\_REJECT\_NOT\_AUTHORIZED Proxy Rejected: Proxy authority has not been granted to this node.
  - 5746 E  
DSM\_RC\_PROXY\_INVALID\_FROMNODE The ASNODENAME option is not valid with the FROMNODE option.
  - 5748 E  
DSM\_RC\_PROXY\_INVALID\_CLUSTER The ASNODENAME option cannot be used with the CLUSTERNODE option.

- 5749 E  
DSM\_RC\_PROXY\_INVALID\_FUNCTION The operation that is being attempted cannot be invoked using the ASNODENAME option.
- 5801 E  
DSM\_RC\_CRYPTO\_ICC\_ERROR Unexpected error in cryptography library.

## **-452 E DSM\_RC\_SHM\_NOTAUTH Insufficient authority to connect to the shared memory region**

---

### **Explanation**

The user issuing the command does not have authority to connect to the shared memory segment. When the shared memory segment is created by the server, it will be owned by the effective uid of the server process (dsmserv). Only processes running under this uid or root will be allowed to connect to the segment (and thus to the server).

### **System action**

The session is rejected and processing stops.

### **User response**

Run the command under the uid of the processing running dsmserv, if possible. Otherwise contact your system administrator for further help.

## **-451 E DSM\_RC\_SHM\_FAILURE An error occurred using the Shared Memory protocol**

---

### **Explanation**

An error has occurred while reading or writing data through the Shared Memory communications protocol.

### **System action**

IBM Spectrum Protect cannot complete the requested operation.

### **User response**

Check the trace log for additional information and retry the operation. If the problem continues, see your system administrator for further help.

## **-450 E DSM\_RC\_SHM\_TCPIP\_FAILURE Session rejected: TCP/IP connection failure for Shared Memory**

---

### **Explanation**

An attempt to connect to the local server using the Shared Memory protocol has failed during initial TCP/IP communications. This error can occur if the server is not listening on the correct port, or if the server is down.

### **System action**

Session rejected. Processing stopped.

### **User response**

Retry the operation, or wait until the server comes back up and retry the operation. If the problem continues, see your system administrator for further help.

## **-190 E DSM\_RC\_NP\_ERROR Session rejected: Named Pipes connection failure.**

---

### **Explanation**

An attempt to connect to the server using Named Pipes communications failed. This might have occurred if an incorrect NAMEDPIPENAME was specified in the options files or if your system administrator canceled a backup operation.

### **System action**

Processing stopped.

### **User response**

Retry the operation, or wait until the server comes back up and retry the operation. Ensure that the value specified on the NAMEDPIPENAME option is the same as the one used by the server. If the problem continues, contact your system administrator for further help.

## **-057 E DSM\_RC\_TCPIP\_LOADFAILURE The TCP/IP load function failed.**

---

### **Explanation**

An error occurred while locating a function. The TCP/IP load function failed.

### **System action**

Processing stopped.

### **User response**

Verify your TCP/IP installation.

## **-056 E DSM\_RC\_TCPIP\_DLL\_LOADFAILURE An error occurred while loading a library.**

---

### **Explanation**

An error occurred while loading a library. The TCP/IP DLL load failed.

### **System action**

Processing stopped.

### **User response**

Verify your TCP/IP installation.

## **-055 E DSM\_RC\_WINSOCK\_MISSING The TCP/IP WINSOCK.DLL file cannot be found.**

---



## Explanation

The TCP/IP WINSOCK.DLL file cannot be found.

## System action

Processing stopped.

## User response

Verify your TCP/IP installation.

## **-054 E DSM\_RC\_NETWORK\_UNREACHABLE The specified TCP/IP host name is unreachable**

---

## Explanation

The TCP/IP host name specified in the TCPSERVERADDRESS statement cannot be reached.

## System action

Processing stopped.

## User response

Check your options file for the correct TCPSERVERADDRESS statement. See your administrator for the correct name of the server.

## **-053 E DSM\_RC\_BAD\_HOST\_NAME An invalid TCP/IP address was specified.**

---

## Explanation

The TCP/IP address specified by the IBM Spectrum Protect client's TCPSERVERADDRESS setting could not be found on the network. Common reasons for this error include:

- The TCPSERVERADDRESS client option specifies the wrong TCP/IP address for the IBM Spectrum Protect server".
- The machine that hosts the IBM Spectrum Protect server is not on the network.
- A network problem is preventing the IBM Spectrum Protect client from reaching the machine that hosts the IBM Spectrum Protect server.

## System action

processing stops.

## User response

Verify that the TCPSERVERADDRESS and TCPPORT settings have the correct values for your IBM Spectrum Protect server. Use your operating system's "ping" (or similar) utility to ensure that your machine can locate the machine that hosts the IBM Spectrum Protect server across the network. Try the operating again. If the problem persists, ask your IBM Spectrum Protect administrator for further assistance.

## **-052 E DSM\_RC\_CONN\_REFUSED An attempt to establish a TCP/IP connection was rejected by the host**

---

## Explanation

An attempt to establish a TCP/IP connection was rejected by the server.

## System action

Processing stopped.

## User response

The server was not fully initialized, is not currently running, was not enabled for TCP/IP communications, or an incorrect TCP/IP port number was specified. If the problem continues, see your system administrator.

## **-051 E DSM\_RC\_CONN\_TIMEDOUT The attempt to establish a TCP/IP connection timed out before the connection was made.**

---

## Explanation

The Object of the connection attempt failed to respond within the the allotted wait time. In the case of the B/A client, this message is preceded in dsmerror.log by message ANS5216E that gives details of the connection that failed. The condition may be temporary.

## System action

processing stops.

## User response

- Restart the IBM Spectrum Protect client and retry the operation.
- Check the client options file and verify that TCPSERVERADDRESS and TCPPORT specify the correct TCP/IP address and port number for your IBM Spectrum Protect server.
- Verify that network connectivity exists between the IBM Spectrum Protect client machine and the IBM Spectrum Protect server machine.
- If the problem persists, see your IBM Spectrum Protect administrator for further assistance.

## **-050 E DSM\_RC\_TCPIP\_FAILURE Session rejected: TCP/IP connection failure.**

---

## Explanation

An attempt to connect to the server using TCP/IP communications failed. This can be a result of incorrect TCP/IP option settings in your client options file. This error can also occur if the LAN connection went down or if your system administrator canceled a backup operation.

## System action

Session rejected. Processing stopped.

## User response

Retry the operation, or wait until the server comes back up and retry the operation. If the problem continues, see your system administrator for further help.

## **0000 I DSM\_RC\_OK Successfully done.**

---

## Explanation

The operation successfully completed.

## System action

None.

## User response

None.

## **0001 E DSM\_RC\_ABORT\_SYSTEM\_ERROR This operation cannot continue due to an error on the IBM Spectrum Protect server. See your IBM Spectrum Protect server administrator for assistance.**

---

## Explanation

The IBM Spectrum Protect server encountered an error condition that prevents the IBM Spectrum Protect client operation from continuing. Your IBM Spectrum Protect server administrator can review the IBM Spectrum Protect server activity log for more details about the error.

## System action

Processing stopped.

## User response

Contact your IBM Spectrum Protect server administrator for assistance. The administrator can review the IBM Spectrum Protect server activity log for further information about the conditions that lead to this error.

## **0002 E DSM\_RC\_ABORT\_NO\_MATCH No objects on server match query**

---

## Explanation

No objects on the server match the query operation being performed. If this object is part of a backupset generated on a node, and the node name is changed on the server, any backup set objects that were generated prior to the name change will not match the new node name.

## System action

Processing stopped.

## User response

Ensure the names are properly entered. If the object is part of a backupset generated prior to a node name change, ensure that the node name is the same as the node for which the backup set was generated.

## **0003 E DSM\_RC\_ABORT\_BY\_CLIENT Client ended transaction**

---

## Explanation

The client system ended the operation with the server and ended the current transaction.

## System action

Processing stopped.

## User response

Restart the session.

# 0004 W DSM\_RC\_ABORT\_ACTIVE\_NOT\_FOUND An active backup version could not be found.

---

## Explanation

An attempt was made to expire an object, but the IBM Spectrum Protect server was unable to find an active backup version of the object. This message is preceded by message ANS1228E which specifies the object name.

For instance, this message could be issued if two separate client processes are backing up the same file system at the same time. If one of the processes expires a file, then the IBM Spectrum Protect server will make that file inactive. If the second process subsequently attempts to expire that same file, the IBM Spectrum Protect server will not find an active version of the file, so the second process will issue this message for that file.

## System action

The object is not expired. Processing continues with the next object.

## User response

- Review the console output, schedule log, or error log and locate the ANS1228E message that immediately precedes this message. ANS1228E will identify the object that could not be expired.
- Examine the conditions under which the problem occurred and assess whether those conditions explain the occurrence of this message. For example, this message could appear if multiple instances of the client were attempting to back up the file system concurrently.
- If the reason this message occurred can not be determined and the message occurs when the operation is tried again, then contact IBM support for further assistance. Also try searching for this message number on <http://www.ibm.com> for possible solutions.

# 0005 E DSM\_RC\_ABORT\_NO\_DATA The IBM Spectrum Protect server has no data for the object.

---

## Explanation

IBM Spectrum Protect tried to do a restore or retrieve on an object that has no data associated with it. If a corrective action is possible, it is with the IBM Spectrum Protect server.

## System action

IBM Spectrum Protect ends the current operation.

## User response

Ask the IBM Spectrum Protect administrator to check the IBM Spectrum Protect activity log for any messages related to this error that might help identify the problem.

## 0006 E DSM\_RC\_ABORT\_BAD\_VERIFIER You entered an incorrect password.

---

### Explanation

You entered an incorrect current password or you entered a new password that does not fulfill the password length requirements set on the server.

### System action

Processing stops.

### User response

Retry the session with the correct password. If this fails or you have forgotten your password, ask the IBM Spectrum Protect administrator to assign a new password.

## 0007 E DSM\_RC\_ABORT\_NODE\_IN\_USE Node in use

---

### Explanation

The node you are running on is in use by another operation on the server. This might be from another client or from some activity on the server.

### System action

Processing stopped.

### User response

Retry the operation, or see your system administrator to see what other operations are running for your node.

## 0008 E DSM\_RC\_ABORT\_EXPIRATE\_TOO\_LOW Expiration date must be greater than today's date

---

### Explanation

Archive expiration date is too low, the date must be greater than today's date.

### System action

IBM Spectrum Protect canceled the current operation.

### User response

Retry archiving the file with an expiration date that is higher than today's date.

## 0009 W DSM\_RC\_ABORT\_DATA\_OFFLINE The requested data is offline.

---

### Explanation

For the restore or retrieve operation, one or more of the requested files must be recalled from offline storage media (generally tape). The wait time depends on your site's offline storage management policies.

### **System action**

IBM Spectrum Protect waits for offline storage media to become available and then continues.

### **User response**

None.

## **0010 E DSM\_RC\_ABORT\_EXCLUDED\_BY\_SIZE Object too large for server limits**

---

### **Explanation**

The object is too large. The configuration of the server does not have any data storage space that accepts the object.

### **System action**

File skipped.

### **User response**

See your system administrator to determine the maximum file (object) size for which your site's server is configured.

## **0011 E DSM\_RC\_ABORT\_NO\_REPOSIT\_SPACE Server out of data storage space**

---

### **Explanation**

The server does not have any space available to store the object.

### **System action**

Processing Ends.

### **User response**

You can take any of the following actions:

- Request the system administrator to add space to the storage pool.
- For IBM Spectrum Protect client, set COMPRESSALWAYS=NO and COMPRESSIon=YES in the options file (DSM.OPT), then the file will be resent uncompressed if it grows during compression.
- For API Applications, consult the application's documentation for recommendations regarding compression.
- Turn off disk caching in the disk storage pool, and issue MOVE DATA commands to each disk pool volume to clear out the cached bitfiles.

## **0012 E DSM\_RC\_ABORT\_MOUNT\_NOT\_POSSIBLE Server media mount not possible**

---

### **Explanation**

Server media mount not possible. The server timed out waiting for a mount of an offline volume.

### System action

File skipped.

### User response

Retry later when server volumes can be mounted. Ensure that the MAXNUMMP (maximum number of mount points) defined on the server for this node is greater than 0.

## 0013 E DSM\_RC\_ABORT\_SIZEESTIMATE\_EXCEED Size estimate exceeded

---

### Explanation

The total amount of data for a backup or archive operation exceeds the estimated size originally sent to the server for allocating data storage space. This happens when many files are growing by large amounts while the backup or archive operation is in session.

### System action

Processing stopped.

### User response

Retry the operation. If the problem continues, check what other processes are running on the client machine that are generating large amounts of data. Disable those operations while the backup or archive operation is taking place.

## 0014 E DSM\_RC\_ABORT\_DATA\_UNAVAILABLE File data currently unavailable on server

---

### Explanation

The file data is currently unavailable on the server. A retrieve or restore operation was attempted. Possible causes are:

- Data was corrupted at the server
- Server found a read error
- File is temporarily involved in a reclaim operation at the server
- Server requested a tape volume that was marked unavailable.

### System action

Processing stopped.

### User response

Retry the operation. If the problem continues, see your system administrator to determine the problem from the server console or the activity log. Check whether any requests were made for a tape volume that was unavailable. A tape volume may be marked unavailable if prior read errors were encountered or the volume is checked out of the tape library.

## 0015 E DSM\_RC\_ABORT\_RETRY Unexpected retry request. The IBM Spectrum Protect server found an error while writing the data.

---

**Explanation**

None.

**System action**

If the current operation supports another attempt, the client tries the operation again. Otherwise, processing stops.

**User response**

None.

## **0016 E DSM\_RC\_ABORT\_NO\_LOG\_SPACE The server does not have enough recovery log space to continue the current operation**

---

**Explanation**

The server ran out of recovery log space.

**System action**

Processing ends.

**User response**

This error is a temporary problem. Retry later or see your system administrator.

## **0017 E DSM\_RC\_ABORT\_NO\_DB\_SPACE The server does not have enough database space to continue the current operation**

---

**Explanation**

The server ran out of database space.

**System action**

Processing ends.

**User response**

See your system administrator.

## **0018 E DSM\_RC\_ABORT\_NO\_MEMORY The server does not have enough memory to continue the current operation.**

---

**Explanation**

The server ran out of memory.



**System action**

Processing ends.

**User response**

This is a temporary problem. Retry later or see your system administrator.

---

**0020 E DSM\_RC\_ABORT\_FS\_NOT\_DEFINED The specified file space does not exist on the server. The file space might have been deleted by another client or an administrator.**

---

**Explanation**

The specified file space does not exist on the server. Your system administrator deleted the file space or another client using your client's node name deleted it.

**System action**

Current operation has been cancelled.

**User response**

Check the file space name to see if it is correct, and retry the operation.

---

**0021 S DSM\_RC\_ABORT\_NODE\_ALREADY\_DEFED Open Registration failed because the specified node name is defined in the server**

---

**Explanation**

Open registration failed because a node is defined in the server with the same name.

**System action**

Current operation has been cancelled.

**User response**

Retry with another node name.

---

**0022 S DSM\_RC\_ABORT\_NO\_DEFAULT\_DOMAIN Open Registration failed because no default domain exists**

---

**Explanation**

Open registration failed because a default policy domain does not exist for you to place your node.

**System action**

Current operation has been cancelled.

## User response

See your system administrator.

## **0023 S DSM\_RC\_ABORT\_INVALID\_NODENAME Open Registration failed because an invalid node name was specified**

---

### Explanation

Open registration failed because the specified node name contains invalid characters.

### System action

Current operation has been cancelled.

## User response

Retry with another node name that does not have any invalid characters.

## **0024 S DSM\_RC\_ABORT\_INVALID\_POL\_BIND A policy management problem has occurred on the IBM Spectrum Protect server.**

---

### Explanation

The client error log and IBM Spectrum Protect server activity log may contain additional information about this error.

### System action

Processing is stops.

## User response

Try the operation again. If the problem persists, examine the client error log and IBM Spectrum Protect server activity log for additional information about this error. If the problem cannot be resolved, then obtain a SERVICE trace that captures the problem and contact IBM technical support for additional assistance. Your IBM Spectrum Protect administrator can help you configure the trace.

## **0024 E DSM\_RC\_ABORT\_NO\_INVALID\_POL\_BIND An object in the transaction has been bound to an invalid management class.**

---

### Explanation

One of the objects in the transaction is bound to a management class that is not part of this node's policy, or the management class type is not supported for this client level.

### System action

The current operation ends.

## User response

Make sure all objects are bound to a valid management class, or upgrade the client to the proper level.

## 0025 E DSM\_RC\_ABORT\_DEST\_NOT\_DEFINED Server problem: Destination not defined.

---

### Explanation

Server problem: Destination not defined.

### System action

Processing stopped.

### User response

Have your service representative check the error log.

## 0026 S DSM\_RC\_ABORT\_WAIT\_FOR\_SPACE The IBM Spectrum Protect server does not currently have space in the storage pool for this file. This may be a temporary condition.

---

### Explanation

This message is typically issued when the storage pool in which the data is being placed does not have sufficient space to store the data, but the space will be available soon. For example, a storage pool migration might free up sufficient space to store the data.

### System action

Current operation has been cancelled.

### User response

Try the operation at a later time. If this fails, contact the IBM Spectrum Protect administrator and request more storage pool space.

## 0027 E DSM\_RC\_ABORT\_NOT\_AUTHORIZED The file space cannot be deleted because this node does not have permission to delete archived or backed up data.

---

### Explanation

You cannot delete the file space data unless your IBM Spectrum Protect administrator has authorized your node to do so. Authorization permits you to delete backup data, archive data, or both.

### System action

Delete processing fails.

### User response

Use the DSMC QUERY SESSION command to verify your authorization. Ask your IBM Spectrum Protect administrator to provide the necessary authorization or to delete the file space for you.

## **0028 E DSM\_RS\_ABORT\_RULE\_ALREADY\_DEFED 'Access rule' Access Rule already defined for node 'node'. Old rule must be deleted before new one can be defined.**

---

### **Explanation**

You are trying to define authorization for the specified node, which already has authorization defined.

### **System action**

IBM Spectrum Protect did not redefine authorization for the specified node.

### **User response**

Update the authorization, or delete the old rule and define a new one, or use the current authorization.

## **0029 S DSM\_RC\_ABORT\_NO\_STOR\_SPACE\_STOP Server out of data storage space**

---

### **Explanation**

The server does not have space available to store the object.

### **System action**

Processing Ends.

### **User response**

Report to your system administrator that a storage pool on the server is full.

## **0030 E DSM\_RC\_ABORT\_LICENSE\_VIOLATION The operation is not permitted due to server licenses values.**

---

### **Explanation**

The node or user is trying to perform an operation that either exceeds license values, or is not licensed.

### **System action**

The session is rejected or the transaction is cancelled, ending the current operation.

### **User response**

See your system administrator.

## **0032 E DSM\_RC\_ABORT\_DUPLICATE\_OBJECT A duplicate object was found, operation cannot complete.**

---

### **Explanation**

A duplicate object was found, operation cannot complete.

### **System action**

The requested operation failed.

### **User response**

Try the operation with a different file specification.

## **0033 E DSM\_RC\_ABORT\_INVALID\_OFFSET partialObjOffset value for partial object retrieve is invalid.**

---

### **Explanation**

The partialObjOffset value for partial object retrieve is invalid.

### **System action**

The system returns to the calling procedure.

### **User response**

Specify a valid value.

## **0034 E DSM\_RC\_ABORT\_INVALID\_LENGTH partialObjLength value for partial object retrieve is invalid.**

---

### **Explanation**

partialObjLength value for partial object retrieve is invalid.

### **System action**

The system returns to the calling procedure.

### **User response**

Specify a valid value.

## **0036 E DSM\_RC\_END\_NODE\_NOT\_AUTHORIZED The node or user does not have proper authority to perform this operation**

---

### **Explanation**

The node or user does not have proper authority to perform this operation.

### **System action**

The transaction is ended.

### **User response**

Check the authority for the specified object.

## **0041 E DSM\_RC\_ABORT\_EXCEED\_MAX\_MP This node has exceeded its maximum number of mount points.**

---

### **Explanation**

Either no tape or sequential disk mount points are permitted for this operation, or the maximum number of mount points allowed are already in use. The operation can not be completed. The IBM Spectrum Protect administrator defines the maximum number of mount points with the MAXNUMMP property of your node definition.

### **System action**

The object is skipped

### **User response**

If you are performing any other operations that might be using mount points, wait until those operations are complete, then try the failed operation again. Otherwise contact your IBM Spectrum Protect administrator for further assistance

## **0045 E DSM\_RC\_ABORT\_MERGE\_ERROR The specified objects failed the merge test.**

---

### **Explanation**

The specified objects failed the merge test, operation cannot complete.

### **System action**

The requested operation failed.

### **User response**

See documentation for the merge test parameters.

## **0047 E DSM\_RC\_ABORT\_INVALID\_OPERATION An invalid operation was attempted on a node**

---

### **Explanation**

The operation is not valid.

### **System action**

Current operation has ended.

### **User response**

Contact your system administrator for more information.

## **0048 E DSM\_RC\_ABORT\_STGPOOL\_UNDEFINED The specified target storage pool is not defined.**

---

### **Explanation**

The storage pool is not defined.

### **System action**

Current operation has ended.

### **User response**

Contact your system administrator for more information.

## **0049 E DSM\_RC\_ABORT\_INVALID\_DATA\_FORMAT A target storage pool does not have the correct data format for the given node type.**

---

### **Explanation**

none

### **System action**

Current operation has ended.

### **User response**

Contact your system administrator for more information.

## **0050 E DSM\_RC\_ABORT\_DATAMOVER\_UNDEFINED No associated data mover is defined for the given node.**

---

### **Explanation**

none

### **System action**

Current operation has ended.

### **User response**

Contact your system administrator for more information.

## **0051 E DSM\_RC\_REJECT\_NO\_RESOURCES Session rejected: All server sessions are currently in use**

---

### **Explanation**

IBM Spectrum Protect has all available sessions in use and cannot accept a new one at this time.

### System action

Current operation has been cancelled.

### User response

Retry the operation. If the problem continues, see your system administrator to increase the number of concurrently active sessions to the server.

## 0052 E DSM\_RC\_REJECT\_VERIFIER\_EXPIRED The session is rejected. Your password has expired.

---

### Explanation

The password for IBM Spectrum Protect user ID has expired. It can be either IBM Spectrum Protect node name password or administrative user ID password or both.

### System action

Current operation has been cancelled. You are not allowed to connect to the server until the password is updated.

### User response

Update your password. It may require updating the node name password or the correspondent administrative ID password or both. You may use the SET PASSWORD command, or have the IBM Spectrum Protect administrator update your node or your administrative ID.

## 0053 E DSM\_RC\_REJECT\_ID\_UNKNOWN Session rejected: User ID is incorrect, does not have admin authority, or is not known by the server

---

### Explanation

The user ID, which is either IBM Spectrum Protect node name or administrative user ID, is not known by the server. Possible reasons for this include:

- Your node name is not registered with the IBM Spectrum Protect server
- The node name is correct but does not have a corresponding administrative ID with the same name and client owner authority
- you are attempting to access a file that was migrated to a different node.

### System action

Current operation has been cancelled.

### User response

Do the following checks:

- Check that your IBM Spectrum Protect user ID is entered correctly.
- Check the administrative ID associated with your IBM Spectrum Protect node and verify that the IBM Spectrum Protect node name has a matching administrative ID with client owner authority for the node. If it does not, your IBM Spectrum Protect administrator needs to create it.
- Check that the server is using closed registration and that your node name is registered with the server.



- If attempting to access a migrated file, your node name must be the same node that migrated the file.

## 0054 E DSM\_RC\_REJECT\_DUPLICATE\_ID Session rejected: Duplicate ID entered

---

### Explanation

Another process using this node name is active with the server.

### System action

IBM Spectrum Protect cannot connect to the server. Current operation has been cancelled.

### User response

If you are running a UNIX-based system, ensure that another process is not active with IBM Spectrum Protect under the same name. Also, ensure that your node name is unique to the server so that it cannot be used by another person. See your system administrator to identify the owner of that node name.

## 0055 E DSM\_RC\_REJECT\_SERVER\_DISABLED Session rejected: Server disabled.

---

### Explanation

The server is in a disabled state and cannot be accessed for normal activity.

### System action

Current operation has been cancelled.

### User response

On the IBM Spectrum Protect server, run the ENABLE SESSIONS administrative command. Try the operation again after the server returns to an enabled state. If the problem continues, see your system administrator.

## 0056 E DSM\_RC\_REJECT\_CLOSED\_REGISTER The server is not configured to allow open registration

---

### Explanation

No authorization. Registration is required by your system administrator. The server is not configured to allow open registration.

### System action

Session not started.

### User response

You must obtain a IBM Spectrum Protect node and password from your system administrator.

## 0057 S DSM\_RC\_REJECT\_CLIENT\_DOWNLEVEL Session rejected: Downlevel client code version

---

### Explanation

The server version and your client version do not match. The client code is downlevel.

### System action

Current operation has been cancelled.

### User response

See your system administrator to see what version of IBM Spectrum Protect to run for your location.

## 0058 S DSM\_RC\_REJECT\_SERVER\_DOWNLEVEL Session rejected: Downlevel server code version

---

### Explanation

The server version and your client version do not match. The server code is downlevel.

### System action

Current operation has been cancelled.

### User response

See your system administrator to see what version of IBM Spectrum Protect to run for your location.

## 0059 E DSM\_RC\_REJECT\_ID\_IN\_USE Session Rejected: The specified node name is currently in use

---

### Explanation

The node name you specified is in use on the server.

### System action

Session was not started.

### User response

The server is probably performing a task that prevents your node from establishing a session. Retry later or check with your system administrator.

## 0061 E DSM\_RC\_REJECT\_ID\_LOCKED Session Rejected: The specified node name is currently locked.

---

### Explanation

The node name you specified is currently locked on the server.

### **System action**

Session was not started.

### **User response**

Check with your system administrator to find out why your node name is locked.

**0062 S DSM\_RC\_SIGNONREJECT\_LICENSE\_MAX SLM LICENSE EXCEEDED: The client licenses for IBM Spectrum Protect are exceeded. See your system administrator.**

---

### **Explanation**

Adding a new enrollment will exceed the product license count for IBM Spectrum Protect.

### **System action**

Execution of the client enrollment or connection request ends.

### **User response**

See your system administrator.

**0063 E DSM\_RC\_REJECT\_NO\_MEMORY Session Rejected: The server does not have enough memory to allow a connection to be established.**

---

### **Explanation**

The server does not have enough memory to allow your client to establish a connection with the server.

### **System action**

Session was not started.

### **User response**

Retry later or see your system administrator.

**0064 E DSM\_RC\_REJECT\_NO\_DB\_SPACE Session Rejected: The server does not have enough database space to allow a connection to be established.**

---

### **Explanation**

The server ran out of database space.

**System action**

Session was not started.

**User response**

See your system administrator.

**0065 E DSM\_RC\_REJECT\_NO\_LOG\_SPACE Session Rejected: The server does not have enough recovery log space to allow a connection to be established.**

---

**Explanation**

The server ran out of recovery log space.

**System action**

Session was not started.

**User response**

This error is a temporary problem. Retry later or see your system administrator.

**0066 E DSM\_RC\_REJECT\_INTERNAL\_ERROR The session is rejected. The IBM Spectrum Protect server has an internal error.**

---

**Explanation**

The client cannot establish a connection to the IBM Spectrum Protect server because of an internal server error.

**System action**

The session was not started.

**User response**

Notify your IBM Spectrum Protect administrator of this error.

**0067 S DSM\_RC\_SIGNONREJECT\_INVALID\_CLI Session Rejected: The server is not licensed for this platform type. See your system administrator.**

---

**Explanation**

The server is not licensed for the requesting client type.

**System action**

Execution of the client enrollment or connection request ends.

## User response

See your system administrator.

## **0068 E DSM\_RC\_CLIENT\_NOT\_ARCHRETPROT The session is rejected. The server does not allow a signon of a client that is not archive-retention protection enabled.**

---

### Explanation

The client cannot establish a connection to the server because the server is enabled for archive-retention protection enabled and the client is not.

### System action

The session is not started.

## User response

See your system administrator.

## **0069 E DSM\_RC\_SESSION\_CANCELED Session Rejected: The session was canceled by the server administrator.**

---

### Explanation

The server administrator canceled the current client session.

### System action

Execution of the client connection request ends.

## User response

See your system administrator.

## **0073 E DSM\_RC\_REJECT\_INVALID\_NODE\_TYPE An inconsistency was detected between the client node and the node that is registered to the IBM Spectrum Protect server.**

---

### Explanation

The user has probably coded the node option incorrectly. For instance, the node that is registered to the IBM Spectrum Protect server might be a type of NAS, but the node is actually a non-NAS client.

### System action

Operation ends.

## User response

Ensure that the node name is correct in the client options file. Make sure to use a node of type NAS only with the nasnodename option.

## **0074 E DSM\_RC\_REJECT\_INVALID\_SESSIONINIT Server does not allow client-initiated connections for this node.**

---

### **Explanation**

The node is not allowed to initiate connections due to the configuration parameters for this node on the server. Server is able to initiate connections to the client scheduler running in prompted mode.

### **System action**

The IBM Spectrum Protect operation ends.

### **User response**

Contact your systems administrator to enable client-initiated sessions for your node or update the SESSIONINITIATION option and run the client scheduler.

## **0075 E DSM\_RC\_REJECT\_WRONG\_PORT Wrong server port.**

---

### **Explanation**

You were trying to open a backup/archive client session on the server port set up for administrative sessions only.

### **System action**

The IBM Spectrum Protect operation ends.

### **User response**

Contact your systems administrator and/or use the correct values for TCP port and TCP Admin Port.

## **0079 E DSM\_RC\_CLIENT\_NOT\_SPMRETPROT The session is rejected. The server does not allow a signon of a client that is not enabled for space-management retention-protection.**

---

### **Explanation**

The client cannot establish a connection to the server because the server is enabled for space-management retention-protection and the client is not.

### **System action**

The session is not started.

### **User response**

See your system administrator.

## **0101 W DSM\_RC\_USER\_ABORT The operation was stopped by the user.**

---

## Explanation

The operation was stopped at the request of the user. This usually occurs when the 'Q' key is pressed two times.

## System action

Processing stopped.

## User response

None.

## **0102 E DSM\_RC\_NO\_MEMORY *file name(line number)*The operating system refused a IBM Spectrum Protect request for memory allocation.**

---

## Explanation

IBM Spectrum Protect requires access to memory in order to store information as processing proceeds. In this case, more memory was requested than the operating system would allocate. Possible reasons include:

- The system is low on memory.
- The process in which the program runs has exceeded the maximum allocated memory.
- Some other error condition occurred. No memory is available.

## System action

IBM Spectrum Protect cannot complete the requested operation.

## User response

Close all unneeded applications and try the operation again. If the operation still fails, try dividing the task into several smaller units. For example, if a file specification contains several high-level directories, run the IBM Spectrum Protect task serially for each directory. If the IBM Spectrum Protect task is an incremental backup, use the option "-memoryefficientbackup=yes".

For UNIX systems that support resource limits, you can check if the memory resource limit is too low by entering the following command: `ulimit -a`

Based on the resulting data, you can ask the UNIX system root user to increase the resource limit above the current default limit. The UNIX system root user has the authority to increase resource limits.

## **0104 E DSM\_RC\_FILE\_NOT\_FOUND File not found during Backup, Archive or Migrate processing**

---

## Explanation

The file being processed for backup, archive or migrate no longer exists on the client. Another process deleted the file before it could be backed up, archived or migrated by IBM Spectrum Protect.

## System action

File skipped.

## User response

None.

## 0105 E DSM\_RC\_PATH\_NOT\_FOUND The specified directory path '*pathname*' could not be found.

---

### Explanation

An invalid or unreachable directory path was specified.

### System action

Processing stopped.

### User response

Try the operation again using a valid directory path.

## 0106 E DSM\_RC\_ACCESS\_DENIED Access to the specified file or directory is denied

---

### Explanation

Access to the specified file or directory is denied. You tried to read from or write to a file and you do not have access permission for either the file or the directory.

### System action

Processing stopped.

### User response

Ensure that you specified the correct file or directory name, correct the permissions, or specify a new location.

## 0106 E DSM\_RC\_ACCESS\_DENIED The specified file is being used by another process

---

### Explanation

The specified file is being used by another process. You tried to read from or write to a file that is currently being used by another process.

### System action

Processing stopped.

### User response

Ensure that you specified the correct file or directory name, correct the permissions, or specify a new location.

## 0107 E DSM\_RC\_NO\_HANDLES No file handles available

---

### Explanation



All file handles for your system are currently in use. No more are available.

### **System action**

Processing stopped.

### **User response**

Either free some file handles by ending other processes, or modify your system setup to allow for more files to be open at the same time.

## **0108 E DSM\_RC\_FILE\_EXISTS The file exists and cannot be overwritten.**

---

### **Explanation**

The file being restored or retrieved exists and cannot be overwritten due to lack of authority or access permissions.

### **System action**

The file is skipped.

### **User response**

Verify that you have sufficient access permissions to overwrite the file, then try the operation again. If the problem persists, contact your system administrator or IBM Spectrum Protect administrator for further assistance.

## **0109 E DSM\_RC\_INVALID\_PARM Invalid parameter was found.**

---

### **Explanation**

The system encountered an internal program error due to an invalid parameter.

### **System action**

The system returns to the calling procedure.

### **User response**

Ask your service representative to check the error log.

## **0110 E DSM\_RC\_INVALID\_HANDLE An invalid file handle was passed; system error.**

---

### **Explanation**

An internal system error occurred: A file operation failed because of an invalid file handle.

### **System action**

processing stops.

### **User response**

Try the operation again. If the failure persists, obtain a service trace that captures the problem and contact IBM technical support for additional assistance. Your IBM Spectrum Protect administrator can help you configure the trace.

## **0111 E DSM\_RC\_DISK\_FULL Processing stopped; Disk full condition**

---

### **Explanation**

No more files can be restored or retrieved because the destination disk is full.

### **System action**

Processing stopped.

### **User response**

Free up disk space, or restore or retrieve the file to another disk.

## **0113 E DSM\_RC\_PROTOCOL\_VIOLATION Protocol violation**

---

### **Explanation**

A communications protocol error occurred. The communication subsystem is not properly defined or is itself in error.

### **System action**

Processing Ends.

### **User response**

Verify that the communication processes are operating properly, and then retry the operation.

## **0114 E DSM\_RC\_UNKNOWN\_ERROR An unknown system error has occurred from which IBM Spectrum Protect cannot recover.**

---

### **Explanation**

An unknown error occurred. This might be a low-level system or communication error from which IBM Spectrum Protect cannot recover.

### **System action**

Processing stops.

### **User response**

Try the operation again. If the problem persists, review the IBM Spectrum Protect error log for any related messages. Obtain a service trace that captures the problem and contact IBM technical support for additional assistance. Your IBM Spectrum Protect administrator can help you configure the trace.

## **0115 E DSM\_RC\_UNEXPECTED\_ERROR An unexpected error occurred.**

---

### **Explanation**

This is usually caused by a low-level system error or communication error from which IBM Spectrum Protect cannot recover.

### **System action**

Processing stopped.

### **User response**

Examine the client error log for any additional messages that might be related to this problem. Try the operation again. If the problem persists, contact IBM Spectrum Protect technical support for further assistance.

## **0116 E DSM\_RC\_FILE\_BEING\_EXECUTED File is in use; Write permission denied.**

---

### **Explanation**

The current file cannot be opened to write to because it is currently being run by another operation.

### **System action**

File skipped.

### **User response**

Stop the operation that is running the file and retry the operation, or restore or retrieve the file to a different name or directory.

## **0117 E DSM\_RC\_DIR\_NO\_SPACE No more files can be restored or retrieved since the destination directory is full.**

---

### **Explanation**

No more files can be restored or retrieved since the destination directory is full.

### **System action**

Processing stopped.

### **User response**

Free up disk space, or restore or retrieve the file to another disk.

## **0118 E DSM\_RC\_LOOPED\_SYM\_LINK Too many symbolic links were detected while resolving name**

---

### **Explanation**

While trying to resolve the file name, too many symbolic links were found.

### **System action**

File skipped.

## User response

Ensure that you do not have a looping symbolic link for the file.

## **0119 E DSM\_RC\_FILE\_NAME\_TOO\_LONG** The file name is too long and can not be processed by IBM Spectrum Protect

---

### Explanation

The size limit for file names may vary by operating system. The most common limit is 256 characters. The file name being processed exceeds the limit supported by IBM Spectrum Protect on this system.

### System action

The file is skipped.

## User response

Enter HELP FILE SPEC or see the client manual for the operating system on which you are receiving this error. The "File specification syntax" section of the manual explains file name lengths supported by IBM Spectrum Protect.

## **0120 E DSM\_RC\_FILE\_SPACE\_LOCKED** File system is locked by system

---

### Explanation

File system cannot be accessed because it is locked by the system.

### System action

The operation cannot be completed.

## User response

See your system administrator.

## **0121 I DSM\_RC\_FINISHED** The operation is finished.

---

### Explanation

The operation is finished.

### System action

The system returns to the calling procedure.

## User response

Proceed with next function call.

## **0122 E DSM\_RC\_UNKNOWN\_FORMAT** The file has an unknown format.

---

### Explanation

The process tried to restore or retrieve a file, but it had an unknown format.

### **System action**

The file is skipped.

### **User response**

The file was either backed up by another application, or the data is invalid. If the file belongs to this system, try the operation again. If the problem persists, contact IBM technical support for further assistance.

## **0123 E DSM\_RC\_NO\_AUTHORIZATION Not authorized to restore the other node's data.**

---

### **Explanation**

The client is not authorized to restore the other node's data.

### **System action**

The system returns to the calling procedure.

### **User response**

Get authorization from the other node.

## **0124 E DSM\_RC\_FILE\_SPACE\_NOT\_FOUND File space '*filespace-name*' does not exist**

---

### **Explanation**

The specified file space (domain) is incorrect or does not exist on the machine.

### **System action**

Processing stopped.

### **User response**

Retry the operation specifying an existing domain (drive letter or file system name).

## **0125 E DSM\_RC\_TXN\_ABORTED Transaction aborted**

---

### **Explanation**

The current transaction between the server and the client stopped. A server, client, or communication failure cannot be recovered.

### **System action**

Current operation has been cancelled.

### **User response**

Retry the operation. If the problem continues, see your system administrator to isolate the problem.

## 0126 E DSM\_RC\_SUBDIR\_AS\_FILE IBM Spectrum Protect cannot build a directory path because a file exists with the same name as the directory.

---

### Explanation

None

### System action

Processing stopped.

### User response

Remove or rename the file that has the same name as the directory. Alternatively, you can restore the directory to a different location.

## 0127 E DSM\_RC\_PROCESS\_NO\_SPACE Disk space limit for this process reached

---

### Explanation

The disk space allocated for the client owner is full.

### System action

Processing stopped.

### User response

Free up disk space and retry the restore or retrieve operation.

## 0128 E DSM\_RC\_PATH\_TOO\_LONG Destination directory path length exceeds system maximum

---

### Explanation

The path name specified plus the path name in the restored file name combine to create a name whose length exceeds the system maximum.

### System action

Processing stopped.

### User response

Specify a destination path that, when combined, is less than the system maximum.

## 0129 E DSM\_RC\_NOT\_COMPRESSED File is not compressed; System failure.

---

### Explanation

A file that was flagged as compressed was not compressed, and the system failed.

### System action

Processing stopped.

### User response

See your system administrator to report this problem. This error is a system failure.

## 0130 E DSM\_RC\_TOO\_MANY\_BITS File compressed on a different client machine that has more memory

---

### Explanation

You are trying to restore a file that was backed up and compressed on another client workstation that had more memory than your client workstation. You cannot restore this file. When the file is restored, it is expanded and your workstation does not have enough memory.

### System action

Current operation has been cancelled.

### User response

Obtain a machine with more memory and retry the operation.

## 0131 E DSM\_RC\_COMPRESSED\_DATA\_CORRUPTED The compressed file is corrupted and cannot be expanded correctly.

---

### Explanation

The compressed file cannot be expanded correctly due to one of the following reasons:

- There is a problem on the tape.
- There is a communications problem.
- The compressed file was corrupted on the IBM Spectrum Protect Server.

### System action

File skipped.

### User response

1) The compressed file is corrupted because there is a problem on the tape. To know if this is the problem, please issue the following command on the IBM Spectrum Protect Server: audit volume <volume\_name> fix=no If there is any problem reported, you could move the data from that volume to a new one (see command MOVE DATA) and try again the restore. 2) There are communications problems between the IBM Spectrum Protect Server and the IBM Spectrum Protect Client and the results is that

the file is corrupted during the transmission. If you use a gigabit Ethernet adapter on the Server please upgrade the card driver (AIX platform) or add provided by SUN suggested changes to some system network options which have resolved this problem (SUN platform). 3) Please verify with your network support if during the restore there are no any problems between the IBM Spectrum Protect Client/Server that is originating the file corruption.

## **0131 S DSM\_RC\_SYSTEM\_ERROR An internal program error occurred.**

---

### **Explanation**

An unexpected condition was encountered and the operation can not continue. This might be a programming error.

### **System action**

processing stops.

### **User response**

Try the operation again. If the problem persists, contact your IBM Spectrum Protect administrator or IBM technical support for further assistance.

## **0132 E DSM\_RC\_NO\_SERVER\_RESOURCES The IBM Spectrum Protect server is out of resources.**

---

### **Explanation**

A lack of a storage resource or a maximum value condition does not allow any new activity.

### **System action**

Current operation has been cancelled.

### **User response**

Try the operation again at a later time. If the problem continues, contact your IBM Spectrum Protect administrator to isolate what resource is unavailable. The IBM Spectrum Protect administrator can check the IBM Spectrum Protect server activity log for messages that might explain the problem.

## **0133 E DSM\_RC\_FS\_NOT\_KNOWN The file space for domain '*domain-name*' could not be found on the IBM Spectrum Protect server.**

---

### **Explanation**

The specified file space was expected to be found on the server, but it no longer exists. It is possible that a command was issued to delete the file space from the server while the current operation was in progress.

### **System action**

IBM Spectrum Protect processing stops.

### **User response**

Try the operation again. If the problem recurs, check the error log for any other messages that might indicate a reason for the failure. Try to correct any indicated problems, then try the operation again. If the problem persists, contact IBM technical support



for further assistance.

## **0134 E DSM\_RC\_NO\_LEADING\_DIRSEP The objName field has no leading directory separator.**

---

### **Explanation**

The objName field does not have a leading directory separator.

### **System action**

The system returns to the calling procedure.

### **User response**

Correct the value for the objName.

## **0135 E DSM\_RC\_WILDCARD\_DIR Wildcards are not allowed in the objName directory path.**

---

### **Explanation**

Wildcards are not allowed in the objName directory path.

### **System action**

The system returns to the calling procedure.

### **User response**

Correct the value for the objName.

## **0136 E DSM\_RC\_COMM\_PROTOCOL\_ERROR The session is rejected: There was a communications protocol error.**

---

### **Explanation**

An unexpected network message was received by the client. This could be caused by network problems or a programming error.

### **System action**

The current operation has been cancelled.

### **User response**

Verify that your communication path is functioning properly and try the operation again. If the problem persists, contact your IBM Spectrum Protect administrator for further assistance.

## **0137 E DSM\_RC\_AUTH\_FAILURE Session rejected: Authentication failure**

---

## Explanation

Authentication failure. You entered an incorrect user id or password.

## System action

Current operation has been cancelled.

## User response

Enter your correct user id and password. If you cannot remember the correct user id or password, see your system administrator to have new credentials assigned for your node name.

## **0138 E DSM\_RC\_TA\_NOT\_VALID The dsmtca execution/owner permissions are invalid.**

---

## Explanation

The dsmtca execution/owner permissions are invalid.

## System action

Processing stopped.

## User response

Have your system administrator check the installation instructions for the client to ensure that the dsmtca permissions are set correctly.

## **0139 S DSM\_RC\_KILLED Process killed.**

---

## Explanation

Processing stopped. This is a programming failure and the client program ends.

## System action

Processing stopped.

## User response

Retry the operation. If the problem continues, contact your system administrator.

## **0145 S DSM\_RC\_WOULD\_BLOCK The dsmtca would block the operation.**

---

## Explanation

The dsmtca blocks the operation. This is a programming failure and the client program ends.

## System action

Processing stopped.

### User response

Retry the operation. If the problem continues, contact your system administrator.

## **0146 S DSM\_RC\_TOO\_SMALL The area for the include/exclude pattern is too small.**

---

### Explanation

The area for the include/exclude pattern is too small. This is a programming failure and the client program ends.

### System action

Processing stopped.

### User response

Retry the operation. If the problem continues, contact your system administrator.

## **0147 S DSM\_RC\_UNCLOSED There is no closing bracket in the pattern.**

---

### Explanation

There is no closing bracket in the pattern. This is a programming failure and the client program ends.

### System action

Processing stopped.

### User response

Retry the operation. If the problem continues, contact your system administrator.

## **0148 S DSM\_RC\_NO\_STARTING\_DELIMITER Include/Exclude pattern must start with a directory delimiter**

---

### Explanation

The include or exclude pattern must start with a directory delimiter.

### System action

Processing stopped.

### User response

Correct the syntax for the pattern.

## **0149 S DSM\_RC\_NEEDED\_DIR\_DELIMITER A beginning or ending directory delimiter is missing from the Include/Exclude pattern.**

---

## Explanation

1. The include/exclude pattern has a '..' without a beginning or ending directory delimiter.
2. For Windows, the drive separator is not immediately followed by a directory delimiter.

## System action

Processing stopped.

## User response

Correct the syntax for the pattern.

## **0151 S DSM\_RC\_BUFFER\_OVERFLOW The data buffer overflowed.**

---

## Explanation

The data buffer overflowed. This is a programming failure and the client program ends.

## System action

Processing stopped.

## User response

Retry the operation. If the problem continues, contact your system administrator.

## **0154 E DSM\_RC\_NO\_COMPRESS\_MEMORY Insufficient memory for file compression/expansion**

---

## Explanation

Not enough memory is available to do data compression or expansion. For a restore or retrieve, the file cannot be recalled from the server until more storage is made available. For a backup or archive, try running without compression if storage cannot be made available.

## System action

Processing stopped.

## User response

Free up extra storage for the operation to continue, or run the backup or archive process without compression enabled.

## **0155 T DSM\_RC\_COMPRESS\_GREW Compressed Data Grew**

---

## Explanation

The size of the file after compression is greater than the size of the file before compressed.

## System action

Even though the size of the file increased, the file is compressed.

## User response

None.

## 0156 E DSM\_RC\_INV\_COMM\_METHOD An unsupported communications method was specified.

---

### Explanation

None.

### System action

processing stops.

## User response

Specify a communications interface that is supported by the IBM Spectrum Protect client on your operating system. See the IBM Spectrum Protect client manual for your operating system for further information on configuring IBM Spectrum Protect client communications.

## 0157 S DSM\_RC\_WILL\_ABORT The transaction will be aborted.

---

### Explanation

The server encountered an error and will abort the transaction.

### System action

The transaction will be aborted. The reason code is passed on the dsmEndTxn call.

## User response

Issue the dsmEndTxn with a vote of DSM\_VOTE\_COMMIT and examine the reason code.

## 0158 E DSM\_RC\_FS\_WRITE\_LOCKED Destination file or directory is write locked

---

### Explanation

The file or directory being restored or retrieved from the server cannot be written to because the destination is write locked. Another operation might have the file open and will not allow it to be updated.

### System action

File skipped.

## User response

Either determine which operation has the file write locked, or restore the file to another name or location.

## **0159 I DSM\_RC\_SKIPPED\_BY\_USER A file was skipped during a restore operation because the file is off line and the application has chosen not to wait for a tape mount.**

---

### **Explanation**

A file was skipped during a restore operation because the file is off line and the application has chosen not to wait for a tape mount.

### **System action**

File skipped.

### **User response**

Verify the application sets the mountWait value correctly on dsmBeginGetData.

## **0160 E DSM\_RC\_TA\_NOT\_FOUND Unable to find the dsmtca module.**

---

### **Explanation**

IBM Spectrum Protect was unable to find the dsmtca module in the specified directory.

### **System action**

Processing ends.

### **User response**

Make sure the dsmtca module is in the directory specified by DSMI\_DIR.

## **0162 E DSM\_RC\_FS\_NOT\_READY File system/drive not ready**

---

### **Explanation**

The file system/drive was not ready for access.

### **System action**

Processing stopped.

### **User response**

Ensure that the drive is available , and then retry the operation.

## **0164 E DSM\_RC\_FIO\_ERROR File input/output error**

---

### **Explanation**

An error was found while reading from or writing to the file.

### **System action**

File or file system is skipped.

### **User response**

Check your system to ensure that it is operating properly. For OS/2, run CHKDSK /F for the failing drive which can be found in dsmerror.log.

## **0165 E DSM\_RC\_WRITE\_FAILURE File write error**

---

### **Explanation**

An error was found while writing to the file.

### **System action**

File skipped.

### **User response**

Check your system to ensure that it is operating properly.

## **0166 E DSM\_RC\_OVER\_FILE\_SIZE\_LIMIT File exceeds system/user file limits**

---

### **Explanation**

A file being restored or retrieved exceeds system set limits for this user.

### **System action**

File skipped.

### **User response**

Ensure that the system limits are set properly.

## **0167 E DSM\_RC\_CANNOT\_MAKE Cannot make file/directory**

---

### **Explanation**

The directory path for files being restored or retrieved cannot be created.

### **System action**

File skipped.

### **User response**

Ensure that you have the proper authorization to create the directory for file being restored or retrieved. Make sure that you have write access.

## **0168 E DSM\_RC\_NO\_PASS\_FILE Password file is not available.**

---

## Explanation

The file containing the stored password for the specified *server-name* is unavailable.

## System action

Processing ends.

## User response

The root user must set and store a new password.

**0169 E DSM\_RC\_VERFILE\_OLD PASSWORDACCESS is GENERATE, but password needed for server '*server-name*'.  
Either the password is not stored locally, or it was changed at the server.**

---

## Explanation

Either the password is not stored locally, or it was changed at the server.

## System action

IBM Spectrum Protect prompts you for the password if IBM Spectrum Protect is running in the foreground.

## User response

If IBM Spectrum Protect was running as a background process, issue any IBM Spectrum Protect command from the foreground. Enter the password in answer to the prompt. Then try your background IBM Spectrum Protect command again.

**0173 E DSM\_RC\_INPUT\_ERROR The process is running in a non-interactive mode, but requires user input.**

---

## Explanation

This process requires keyboard input, but non-interactive processes are unable to read input from keyboard.

## System action

processing stops.

## User response

Perform the following actions to resolve this error:

- Run the product in interactive mode.
- Ensure your password is set correctly.

**0174 E DSM\_RC\_REJECT\_PLATFORM\_MISMATCH Session rejected: Node type mismatch**

---

## Explanation



Your node name is associated with a different type of operating system and cannot be used on this system.

### **System action**

Current operation has been cancelled.

### **User response**

If you need a new node name, see your system administrator to assign a new one to you. Generally, you have a unique node name for each machine and operating system pair that requires access to the server.

## **0175 E DSM\_RC\_TL\_NOT\_FILE\_OWNER Not file owner**

---

### **Explanation**

The file cannot be backed up because the client is not the file owner.

### **System action**

The file is skipped.

### **User response**

None.

## **0177 S DSM\_RC\_UNMATCHED\_QUOTE Quotes are not matched**

---

### **Explanation**

The quotes specified in the pattern are not the same and do not make a set.

### **System action**

Processing stopped.

### **User response**

Correct the pattern by using matching quotes in the syntax.

## **0184 E DSM\_RC\_TL\_NOBCG The management class for this file does not have a valid backup copy group. This file will not be backed up.**

---

### **Explanation**

The management class for this file does not have a backup copy group specified. This file will not be backed up.

### **System action**

Processing stopped.

### **User response**

Add a valid backup copy group to the management class, and then retry the operation.

## **0185 W DSM\_RC\_TL\_EXCLUDED File '*file-namefile-namefile-name*' excluded by Include/Exclude list**

---

### **Explanation**

You can not back up, archive, or migrate files that are excluded.

### **System action**

The file can not be processed.

### **User response**

If the file is intentionally excluded, then this message can be ignored. Otherwise modify the include/exclude list, restart the client, and try the operation again. Contact your IBM Spectrum Protect administrator for further assistance.

## **0186 E DSM\_RC\_TL\_NOACG The management class for this file does not have a valid archive copy group. This file will not be archived.**

---

### **Explanation**

The management class for this file does not have an archive copy group specified. This file will not be archived.

### **System action**

Processing stopped.

### **User response**

Add a valid archive copy group to the management class, and then retry the operation.

## **0187 E DSM\_RC\_PS\_INVALID\_ARCHMC Invalid management class entered**

---

### **Explanation**

You entered an invalid management class.

### **System action**

Requested operation is not possible.

### **User response**

Retry the operation using a valid management class.

## 0188 S DSM\_RC\_NO\_PS\_DATA Either the node does not exist on the server or there is no active policy set for the node.

---

### Explanation

This error occurs when you try to access another node's data. Either the node is not registered with the IBM Spectrum Protect server, or there is no active policy set for the node.

### System action

Processing stops.

### User response

Verify that the node whose data you are trying to access is registered with the IBM Spectrum Protect server. If you have more than one IBM Spectrum Protect server, make sure you are connecting to the correct server, then try the operation again. If the problem persists, contact your IBM Spectrum Protect administrator for further assistance.

## 0189 S DSM\_RC\_PS\_INVALID\_DIRMC The management class assigned to directories does not exist.

---

### Explanation

The management class named on the DIRMC option does not exist in your assigned policy set on the server. The error log contains an entry showing the invalid management class name.

### System action

processing stops.

### User response

Remove the current DIRMC option from the client options file, then run `DSMC QUERY MGMTCLASS -DETAIL` to view information about available management classes. Make sure the management class you select has a backup copy group. If you have more than one IBM Spectrum Protect server, make sure you are connecting to the correct server. If you are unable to find a suitable management class, contact your IBM Spectrum Protect administrator for further assistance.

## 0190 S DSM\_RC\_PS\_NO\_CG\_IN\_DIR\_MC There is no backup copy group in the management class used for directories.

---

### Explanation

The DIRMC option names a management class that contains no backup copy group.

### System action

processing stops.

### User response

Remove the current DIRMC option from the client options file, then run `DSMC QUERY MGMTCLASS -DETAIL` to view information about available management classes. Make sure the management class you select has a backup copy group. If you have more

than one IBM Spectrum Protect server, make sure you are connecting to the correct server. If you are unable to find a suitable management class, contact your IBM Spectrum Protect administrator for further assistance.

## **0231 E DSM\_RC\_ABORT\_MOVER\_TYPE Unknown Remote Mover type**

---

### **Explanation**

The specified Remote Mover type is unknown.

### **System action**

Current operation has ended.

### **User response**

Contact your system administrator for more information.

## **0232 E DSM\_RC\_ABORT\_ITEM\_IN\_USE An Operation for the requested node and file space is already in progress.**

---

### **Explanation**

A request has been made to use a data mover to perform an operation for the indicated node and file space. Since an operation for this node and file space is already in progress, the new operation cannot be performed.

### **System action**

Current operation has ended.

### **User response**

Retry the operation at a later time.

## **0233 E DSM\_RC\_ABORT\_LOCK\_CONFLICT System resource in use**

---

### **Explanation**

A required resource is in use by another command or process.

### **System action**

Current operation has ended.

### **User response**

Retry the operation at a later time.

## **0234 E DSM\_RC\_ABORT\_SRV\_PLUGIN\_COMM\_ERROR Server plugin communication error**

---

### **Explanation**

Communication between a server plugin module and a NAS filer failed.

### **System action**

Current operation has ended.

### **User response**

Contact your system administrator for more information.

## **0235 E DSM\_RC\_ABORT\_SRV\_PLUGIN\_OS\_ERROR Server plugin detected unsupported NAS filer operating system.**

---

### **Explanation**

A plugin module detected that a NAS filer is running an unsupported operating system or operating system level.

### **System action**

Current operation has ended.

### **User response**

Contact your system administrator for more information.

## **0236E DSM\_RC\_ABORT\_CRC\_FAILED The CRC received from the Server does not match the CRC calculated by the client.**

---

### **Explanation**

The server sent a CRC for a buffer. The client calculated a CRC for the same buffer. These did not match. The mismatch indicates a communication failure.

### **System action**

In some cases, the client can indicate the failure to the server and retry the operation.

### **User response**

Check the trace log for additional information and retry the operation. If the problem persists, contact your system administrator.

## **0237E DSM\_RC\_ABORT\_INVALID\_GROUP\_ACTION An invalid operation was attempted on a group leader or group member.**

---

### **Explanation**

An invalid operation was attempted on a logical group.

### **System action**

The current operation stops.

**User response**

Retry a valid operation.

**0238E DSM\_RC\_ABORT\_DISK\_UNDEFINED Remote disk not defined.**

---

**Explanation**

An operation was attempted on a remote disk that is not defined.

**System action**

The current operation stops.

**User response**

Define the proper remote disk.

**0239E DSM\_RC\_ABORT\_BAD\_DESTINATION Input destination does not match expected destination.**

---

**Explanation**

Input destination does not match expected destination.

**System action**

The current operation stops.

**User response**

Retry operation with proper destination.

**0240E DSM\_RC\_ABORT\_DATAMOVER\_NOT\_AVAILABLE Data mover is not available.**

---

**Explanation**

Data mover is not available.

**System action**

The current operation stops.

**User response**

Retry operation with a proper Data mover.

**0241E DSM\_RC\_ABORT\_STGPOOL\_COPY\_CONT\_NO Operation failed because the copy continue option was set to NO.**

---

## Explanation

Operation failed because the copy continue option was set to NO.

## System action

The current operation stops.

## User response

This abort code indicates that a store operation, like backup or archive failed because the copy continue option was set to NO. The sysadmin will need to resolve the problem on the server end.

## **0242E DSM\_RC\_ABORT\_RETRY\_SINGLE\_TXN Transaction failed because of a problem during a store operation.**

---

## Explanation

Transaction failed because of a problem during a store operation. This error is typical when the next storage pool has a different copy storage pool list and we switch to this pool in the middle of a transaction.

## System action

Transaction is aborted.

## User response

Resend objects in separate transactions.

## **0245 E DSM\_RC\_ABORT\_PATH\_RESTRICTED The current client configuration does not comply with the value of the DATAWRITEPATH or DATAREADPATH server option for this node.**

---

## Explanation

The values of the DATAWRITEPATH and DATAREADPATH server options specify where the client is allowed to send data, and where data is read from. The values for the specified node name should correspond with the client configuration. For example, you will get this error message if DATAWRITEPATH contains a LAN value and the client is configured to use LAN-free protocol, or vice versa.

## System action

Processing stopped.

## User response

Check the client, server, and storage agent logs to determine why the client was not able to send data LAN-free. Make sure the client configuration and server options are compatible.

## **0247 E DSM\_RC\_ABORT\_INSERT\_NOT\_ALLOWED This server does not support backup operations.**

---

## Explanation

This server only supports archive operations, backup is not allowed.

## System action

The current operation ends.

## User response

Use only archive operations with this server.

## 0248 E DSM\_RC\_ABORT\_DELETE\_NOT\_ALLOWED Deleting this object: "*fshlll*" is not allowed.

---

## Explanation

The object is either under a hold and cannot be deleted, or it is on a retention-protection enabled server and has not expired.

## System action

The object is skipped and processing continues.

## User response

Check the status of the object through a query to see if it is held, or when it expires.

## 0249 E DSM\_RC\_ABORT\_TXN\_LIMIT\_EXCEEDED The number of objects in this transaction exceed TXNGROUPMAX values.

---

## Explanation

There are too many objects in this transaction.

## System action

The current operation ends.

## User response

Try the operation again with fewer objects in the transaction, or increase the TXNGROUPMAX value on the server.

## 0250 E DSM\_RC\_ABORT\_OBJECT\_ALREADY\_HELD *fshlll* is already under hold.

---

## Explanation

One of the objects in the transaction The specified object is already under hold, and it cannot be placed under a new hold.

## System action

The current operation ends. This object is skipped and processing continues.



## User response

Issue a query to see the status of the objects, and try the operation again, without the object that is already held.

## 0292 E DSM\_RC\_TCA\_FORK\_FAILED Error starting the dsmtca or dsmenc process.

---

### Explanation

An error has occurred starting the dsmtca or dsmenc process; specifically, the `fork()` function has failed.

### System action

Processing ends.

### User response

Probable system error. If the problem persists, restart the workstation.

## 0295 E DSM\_RC\_TCA\_INVALID\_REQUEST The IBM Spectrum Protect dsmtca received an invalid request.

---

### Explanation

The dsmtca or dsmenc process was invoked by the backup-archive client and received an unknown request argument in the call.

### System action

Processing ends.

### User response

It is possible that the dsmtca or dsmenc process was mistakenly invoked by a process other than the backup-archive client. If that is not the case, then this is an internal error. If the problem recurs, contact your IBM service representative.

## 0296 E DSM\_RC\_TCA\_NOT\_ROOT This action requires IBM Spectrum Protect administrative authority on this system.

---

### Explanation

An activity has been attempted that must be performed by the IBM Spectrum Protect administrator (for example, open registration, file space delete or password update).

### System action

Processing ends.

### User response

If the activity is required, the administrator for this system must perform it.

## 0297 E DSM\_RC\_TCA\_SEMGET\_ERROR Error allocating semaphores.

---

## Explanation

An error has occurred because the semaphores you are attempting to allocate have become insufficient.

## System action

Processing ends.

## User response

Ask your system administrator for assistance, and possibly increase the number of semaphores in your system.

## **0298 E DSM\_RC\_TCA\_SEM\_OP\_ERROR Error setting semaphore value or waiting on semaphore.**

---

## Explanation

An error has occurred while attempting to set or wait on a semaphore.

## System action

Processing ends.

## User response

Probable system error. If the problem persists, restart the workstation.

## **0400 E DSM\_RC\_INVALID\_OPT An invalid option was found during option parsing.**

---

## Explanation

An invalid option was found.

## System action

The system returns to the calling procedure.

## User response

Verify the options in dsm.opt, dsm.sys, and the options string. Check the error log for more details about the error. on the AS/400 platform, verify the options in \*LIB/QOPTIBM Spectrum Protect(APIOPT).

## **0405 E DSM\_RC\_NO\_HOST\_ADDR TCPSERVERADDRESS not defined for this server in the System Options File**

---

## Explanation

The TCPSERVERADDRESS for this server is not defined in the server name stanza in the system options file.

## System action

IBM Spectrum Protect initialization fails and the program ends.

### User response

See the IBM Spectrum Protect administrator for your system, and make sure that the server to which you are trying to connect, has a valid TCPSEVERADDRESS defined in the system options file.

## 0406 S DSM\_RC\_NO\_OPT\_FILE Options file '*file-name*' could not be found, or it cannot be read.

---

### Explanation

Common reasons for this error include:

- The default options file does not exist.
- You specified the -OPTFILE option when starting the IBM Spectrum Protect client, but the options file you provided does not exist.
- The DSM\_CONFIG (or DSMI\_CONFIG if you are using the IBM Spectrum Protect API) environment variable specifies an options file that does not exist.
- You specified the -OPTFILE option when starting the IBM Spectrum Protect client, but the options file that you provided is not in the standard file encoding of the system. For example, on Windows the expected file encoding is ANSI.
- You specified the -OPTFILE option when starting the IBM Spectrum Protect client, but the options file that you provided does not have appropriate read permissions for the user that is running the operation.

### System action

IBM Spectrum Protect client processing stops.

### User response

Make sure that the options file you want to use exists, it has the read rights set for the user that is running the operation, and it is in the standard file encoding of the system. For example, on Windows the expected file encoding is ANSI. Review the configuration information in the IBM Spectrum Protect client manual specific to your operating system. If the problem persists, ask your IBM Spectrum Protect administrator for further assistance.

## 0408 E DSM\_RC\_MACHINE\_SAME A virtual node name must not equal either a node name or the system host name.

---

### Explanation

A VIRTUALNODENAME option was entered with a name the same as either a NODENAME option or the system host name.

### System action

Initialization fails and the program ends.

### User response

If the virtual node name entered was the same as the host name, remove the virtual node name option. If it was the same as the node name option, you can remove either one, depending upon the intended usage. Node name is used to assign an alternate name to your system. Virtual node name is used to access another system's server data.

## 0409 E DSM\_RC\_INVALID\_SERVER Server name not found in System Options File

---

## Explanation

The system options file does not contain the SERVERNAME option.

## System action

IBM Spectrum Protect initialization fails and the program ends.

## User response

See the IBM Spectrum Protect administrator for your system, and make sure that the system options file contains the server name.

## 0410 E DSM\_RC\_INVALID\_KEYWORD An invalid option keyword was found during option parsing.

---

### Explanation

An invalid option keyword was found in the dsmInit configuration file, the option string, dsm.sys, or dsm.opt.

### System action

The system returns to the calling procedure.

### User response

Correct the spelling of the option keywords. Verify that the dsmInit configuration file only has a subset of the dsm.sys options. Check the error log for more details about the error.

## 0411 S DSM\_RC\_PATTERN\_TOO\_COMPLEX The include or exclude pattern cannot be parsed.

---

### Explanation

The pattern is formatted incorrectly or is too complex to be interpreted.

### System action

Processing stopped.

### User response

Verify that the include or exclude pattern is specified correctly. If the pattern is correct, then contact IBM technical support for further assistance.

## 0412 S DSM\_RC\_NO\_CLOSING\_BRACKET Include/Exclude pattern is missing a closing bracket

---

### Explanation

The include or exclude pattern is incorrectly constructed. The closing bracket is missing.

**System action**

Processing stopped.

**User response**

Correct the syntax for the pattern.

## **0426 E DSM\_RC\_CANNOT\_OPEN\_TRACEFILE Initialization functions cannot open the trace file specified.**

---

**Explanation**

The file could not be opened during initialization. The specified path might be incorrect. It is also possible that the current user does not have permission to write to the tracefile in the directory specified. It is also possible that no space is available at the tracefile location.

**System action**

Processing stops.

**User response**

Make sure the tracefile option points to a valid path and that the user has proper permissions to write to the specified file.

## **0427 E DSM\_RC\_CANNOT\_OPEN\_LOGFILE Initialization functions cannot open the error log file specified.**

---

**Explanation**

The error log file could not be opened during initialization. The specified path may be incorrect. It is also possible that the current user does not have permission to write to the logfile in the directory specified. It is also possible that no space is available at the given logfile location.

**System action**

Processing terminates.

**User response**

Make sure the logfile option points to a valid path and that the user has proper permissions to write to the file specified.

## **0600 E DSM\_RC\_DUP\_LABEL A duplicate volume label exists. The operation cannot continue.**

---

**Explanation**

For removable media, IBM Spectrum Protect uses the volume label as the file space name. To prevent data from different volumes being stored in the same file space on the IBM Spectrum Protect server, backup or archive of removable media volumes having duplicate volume labels is not allowed.

**System action**

The requested operation does not run.

### User response

Change the volume labels on the removable media volumes so that there are no duplicate labels. Then restart IBM Spectrum Protect and try the operation again.

## 0601 E DSM\_RC\_NO\_LABEL The drive has no label. The operation cannot continue.

---

### Explanation

Backup or archive of removable media requires that the media have a volume label. An attempt was made to back up or archive data on a removable volume that has no label.

### System action

The requested operation does not run.

### User response

Create a volume label on the removable media, then try the operation again.

## 0610 E DSM\_RC-NLS\_CANT\_OPEN\_TXT Unable to open message text file.

---

### Explanation

The system is unable to open the message txt file (dscenu.txt or dsmclientV3.cat for AIX). On the AS/400 platform this file is QANSAPI/QAANSENU(TXT).

### System action

The system returns to the calling procedure.

### User response

Verify that the dscenu.txt file is in the directory pointed to by DSMI\_DIR. For AIX, verify that the dsmclientV3.cat file has a symbolic link to /usr/lib/nls/msg/<locale>/dsmclientV3.cat .

## 0611 E DSM\_RC-NLS\_CANT\_READ\_HDR Unable to use message text file.

---

### Explanation

The system is unable to use the message text file (dscenu.txt or dsmclientV3.cat for AIX) because of an invalid header. On the AS/400 platform this file is QANSAPI/QAANSENU(TXT).

### System action

The system returns to the calling procedure.

## User response

Install the message text file again.

## 0612 E DSM\_RC-NLS\_INVALID\_CNTL\_REC Unable to use message text file.

---

### Explanation

The system is unable to use the message txt file (dscenu.txt or dsmclientV3.cat for AIX) because of an invalid control record. On the AS/400 platform this file is QANSAPI/QAANSENU(TXT).

### System action

The system returns to the calling procedure.

## User response

Install the message text file again.

## 0613 E DSM\_RC-NLS\_INVALID\_DATE\_FMT Invalid value for DATEFORMAT specified.

---

### Explanation

An invalid value is specified for DATEFORMAT.

### System action

The system returns to the calling procedure.

## User response

Specify a valid value.

## 0614 E DSM\_RC-NLS\_INVALID\_TIME\_FMT Invalid value for TIMEFORMAT specified.

---

### Explanation

An invalid value is specified for TIMEFORMAT.

### System action

The system returns to the calling procedure.

## User response

Specify a valid value.

## 0615 E DSM\_RC-NLS\_INVALID\_NUM\_FMT Invalid value for NUMBERFORMAT specified.

---

### Explanation

An invalid value is specified for NUMBERFORMAT.

### System action

The system returns to the calling procedure.

### User response

Specify a valid value.

## 0620 E DSM\_RC\_LOG\_CANT\_BE\_OPENED Unable to open error log file.

---

### Explanation

The system is unable to open the error log file.

### System action

The system returns to the calling procedure.

### User response

Verify the DSMI\_LOG value and access permission. On the AS/400 platform, verify the value specified for ERRORLOGNAME in the API options file.

## 0621 E DSM\_RC\_LOG\_ERROR\_WRITING\_TO\_LOG The log file cannot be written to.

---

### Explanation

There was an error writing to the log file.

### System action

The system returns to the calling procedure.

### User response

Verify the DSMI\_LOG value and access permission. on the AS/400 platform, verify the value specified for ERRORLOGNAME in the API options file.

## 0622 E DSM\_RC\_LOG\_NOT\_SPECIFIED The log file name was not specified.

---

### Explanation



The system is unable to open the error log file.

### **System action**

The system returns to the calling procedure.

### **User response**

Verify the DSMI\_LOG value and access permission. On the AS/400 platform, verify the value specified for ERRORLOGNAME in the API options file.

## **0927 E DSM\_RC\_NOT\_ADSM\_AUTHORIZED Only a IBM Spectrum Protect authorized user can perform this Action.**

---

### **Explanation**

User must be a IBM Spectrum Protect authorized user to perform this action. User is not password authorized and this action requires authorization.

### **System action**

Processing stopped.

### **User response**

User must be root user, or user must be the owner of the executable and the set effective user id bit is set to 'on' ('s' bit).

## **961 E DSM\_RC\_DIRECT\_STORAGE\_AGENT\_UNSUPPORTED Direct connection to the Storage Agent is not allowed.**

---

### **Explanation**

You cannot connect directly to the Storage Agent.

### **System action**

Processing stopped.

### **User response**

To perform Lanfree operations using the Storage Agent, specify the ENABLELANFREE option in your options file, and restart the process.

## **963 E DSM\_RC\_FS\_NAMESPACE\_DOWNLEVEL The long namespace has been removed from the local file space. If you wish to proceed with the backup/archive operation, rename your file space on the server.**

---

### **Explanation**

The process has detected that the server namespace is NTW:LONG, but the local volume does not have long name support. If you would like to back up the volume using the short names, rename the file space on the server. If you would like to back up using long names, add the long namespace support back to the volume in question.

### System action

Processing stopped.

### User response

Add the long namespace support to the volume or rename(remove) the corresponding server file space.

**0996 E DSM\_RC\_SERVER\_DOWNLEVEL\_FUNC The IBM Spectrum Protect server is downlevel and does not support the requested function. See error log for version information.**

---

### Explanation

The function being used requires a more current IBM Spectrum Protect Server.

### System action

The operation fails.

### User response

Upgrade your IBM Spectrum Protect Server to a level that supports this function. See error log for version information.

**0997 E DSM\_RC\_STORAGEAGENT\_DOWNLEVEL The IBM Spectrum Protect Storage Agent is downlevel and does not support the requested function. See error log for version information.**

---

### Explanation

The function being used requires a more current IBM Spectrum Protect Storage Agent.

### System action

The operation fails.

### User response

Upgrade your IBM Spectrum Protect Storage Agent to a level that supports this function. See error log for version information.

**0998 E DSM\_RC\_SERVER\_AND\_SA\_DOWNLEVEL The IBM Spectrum Protect Server and IBM Spectrum Protect Storage agent are downlevel and do not support the requested function. See error log for version information.**

---

### Explanation

The function being used requires a more current IBM Spectrum Protect Server and IBM Spectrum Protect Storage agent

### System action

The operation fails.

### User response

Upgrade your IBM Spectrum Protect Server and IBM Spectrum Protect Storage agent to a level that supports this function. See error log for version information.

## **1376 E DSM\_RC\_DIGEST\_VALIDATION\_ERROR Error processing 'filespace namepath-namefile-name'; end-to-end digest validation failed.**

### Explanation

Cryptographic digest of the restored or retrieved data did not match the digest generated during the backup or archive operation. Possible causes are a transmission error, data corruption, or a hash collision.

### System action

Processing stops

### User response

Try the restore operation again. If the problem persists, contact IBM technical support for additional assistance.

## **2000 E DSM\_RC\_NULL\_OBJNAME The object name pointer is NULL.**

### Explanation

There is no value provided for the object name pointer.

### System action

The system returns to the calling procedure.

### User response

Provide an address for the dsmObjName structure.

## **2001 E DSM\_RC\_NULL\_DATABLKPTR The data block pointer is NULL.**

### Explanation

There is no value provided for the data block pointer.

### System action

The system returns to the calling procedure.

### User response

Provide an address for the DataBlk structure.

## **2002 E DSM\_RC\_NULL\_MSG msg parameter for dsmRCMsg is a NULL pointer.**

---

### **Explanation**

The message parameter for dsmRCMsg is a NULL pointer.

### **System action**

The system returns to the calling procedure.

### **User response**

Allocate enough space for the message parameter.

## **2004 E DSM\_RC\_NULL\_OBJATTRPTR The object attribute pointer is NULL.**

---

### **Explanation**

There is no value provided for the object attribute pointer.

### **System action**

The system returns to the calling procedure.

### **User response**

Provide an address for the ObjAttr structure.

## **2006 E DSM\_RC\_NO\_SESS\_BLK There is no server session information.**

---

### **Explanation**

The server did not respond with the session information.

### **System action**

The system returns to the calling procedure.

### **User response**

Verify the server status.

## **2007 E DSM\_RC\_NO\_POLICY\_BLK There is no server policy information.**

---

### **Explanation**

The server did not respond with the policy information.

### **System action**

The system returns to the calling procedure.

### User response

Verify the server policy definitions.

## **2008 E DSM\_RC\_ZERO\_BUFLLEN The dataBlk bufferLen value is zero.**

---

### Explanation

The value for the dataBlk bufferLen is zero.

### System action

The system returns to the calling procedure.

### User response

Provide a non-zero value for the bufferLen.

## **2009 E DSM\_RC\_NULL\_BUFPTR The dataBlk bufferPtr is NULL.**

---

### Explanation

There is no value provided for the dataBlk bufferPtr.

### System action

The system returns to the calling procedure.

### User response

Provide an address for the bufferPtr.

## **2010 E DSM\_RC\_INVALID\_OBJTYPE The objType is invalid.**

---

### Explanation

The value for the objType is invalid.

### System action

The system returns to the calling procedure.

### User response

The value for dsmObjName.objType must be:

- DSM\_OBJ\_FILE or DSM\_OBJ\_DIRECTORY for Backup, or
- DSM\_OBJ\_FILE for Archive.

## **2011 E DSM\_RC\_INVALID\_VOTE The dsmEndTxn vote is invalid.**

---

### Explanation

The dsmEndTxn vote is invalid.

### **System action**

The system returns to the calling procedure.

### **User response**

The vote must be DSM\_VOTE\_COMMIT or DSM\_VOTE\_ABORT.

## **2012 E DSM\_RC\_INVALID\_ACTION The update action is invalid.**

---

### **Explanation**

The dsmUpdateFS or dsmUpdateObj action is invalid.

### **System action**

The system returns to the calling procedure.

### **User response**

Correct the action value. Valid values are defined in dsmapitd.h and documented in our Using the API book.

## **2014 E DSM\_RC\_INVALID\_DS\_HANDLE There was an error in the IBM Spectrum Protect API internals.**

---

### **Explanation**

The system encountered an error in the API internals.

### **System action**

The system returns to the calling procedure.

### **User response**

Shut down the process and retry the operation. Verify that any previous dsmInit calls were cleaned up and terminated by a dsmTerminate call. If the problem continues, contact your system administrator or service representative.

## **2015 E DSM\_RC\_INVALID\_REPOS The repository type is invalid.**

---

### **Explanation**

The repository type is invalid.

### **System action**

The system returns to the calling procedure.

### **User response**

For dsmDeleteFS the repository must be one of the following:

- DSM\_ARCHIVE\_REP
- DSM\_BACKUP\_REP
- DSM\_REPOS\_ALL.

## **2016 E DSM\_RC\_INVALID\_FSNAME Filespace name should start with the directory delimiter.**

---

### **Explanation**

The filespace name is invalid.

### **System action**

The system returns to the calling procedure.

### **User response**

Filespace name should start with the directory delimiter.

## **2017 E DSM\_RC\_INVALID\_OBJNAME The object name is either an empty string or has no leading delimiter.**

---

### **Explanation**

The object name is invalid because of an empty string or there is no leading delimiter.

### **System action**

The system returns to the calling procedure.

### **User response**

Verify the format of the dsmObjName full path.

## **2018 E DSM\_RC\_INVALID\_LLNAME Low level qualifier of the object name should start with the directory delimiter.**

---

### **Explanation**

The low level qualifier for the object name is invalid.

### **System action**

The system returns to the calling procedure.

### **User response**

Start the low level qualifier of the object name with the directory delimiter.

## **2019 E DSM\_RC\_INVALID\_OBJOWNER The object owner is invalid.**

---

## Explanation

The object owner must be either the root user, or the object owner must be the same as the session owner.

## System action

The system returns to the calling procedure.

## User response

Verify the session owner and object owner.

## **2020 E DSM\_RC\_INVALID\_ACTYPE The dsmBindMC sendType is invalid.**

---

## Explanation

The dsmBindMC sendType is invalid.

## System action

The system returns to the calling procedure.

## User response

The sendType must be one of the following:

- stBackup
- stArchive
- stBackupMountWait
- stArchiveMountWait

## **2021 E DSM\_RC\_INVALID\_RETCODE no text available for this return code.**

---

## Explanation

The dsmRC parameter for dsmRCMsg is an unsupported return code.

## System action

The system returns to the calling procedure.

## User response

Specify a valid value.

## **2022 E DSM\_RC\_INVALID\_SENDDTYPE The dsmSendObj sendType is invalid.**

---

## Explanation

The dsmSendObj sendType is invalid.



### System action

The system returns to the calling procedure.

### User response

The sendType must be one of the following:

- stBackup
- stArchive
- stBackupMountWait
- stArchiveMountWait

## 2023 E DSM\_RC\_INVALID\_PARAMETER The dsmDeleteObj delType is invalid.

---

### Explanation

The dsmDeleteObj delType is invalid.

### System action

The system returns to the calling procedure.

### User response

The delType must be dtBackup or dtArchive.

## 2024 E DSM\_RC\_INVALID\_OBJSTATE The query Backup objState is invalid.

---

### Explanation

The query Backup objState is invalid.

### System action

The system returns to the calling procedure.

### User response

The qryBackupData.objState must be one of the following:

- DSM\_ACTIVE
- DSM\_INACTIVE
- DSM\_ANY\_MATCH

## 2025 E DSM\_RC\_INVALID\_MCNAME The management class name was not found.

---

### Explanation

A query or send operation is unable to find the management class name.

### **System action**

The system returns to the calling procedure.

### **User response**

Verify the management class name.

## **2026 E DSM\_RC\_INVALID\_DRIVE\_CHAR The drive letter is not an alphabetic character.**

---

### **Explanation**

The drive letter is not an alphabetic character. This return code is valid on Microsoft Windows only.

### **System action**

The system returns to the calling procedure.

### **User response**

Verify that the drive designation is an alphabetic character. The referenced field is dsmDosFSAttrib.driveLetter.

## **2027 E DSM\_RC\_NULL\_FSNAME The Register Filespace name is NULL.**

---

### **Explanation**

There is no value provided for the Register Filespace name.

### **System action**

The system returns to the calling procedure.

### **User response**

Provide a filespace name on dsmRegisterFS.

## **2028 E DSM\_RC\_INVALID\_HLNAME High level qualifier of the object name should start with the directory delimiter.**

---

### **Explanation**

The high level qualifier for the object name is invalid.

### **System action**

The system returns to the calling procedure.

### **User response**

High level qualifier of the object name should start with the directory delimiter.

## **2029 E DSM\_RC\_NUMOBJ\_EXCEED The number of objects on dsmBeginGetData exceeds DSM\_MAX\_GET\_OBJ | DSM\_MAX\_PARTIAL\_GET\_OBJ.**

---

### **Explanation**

The number of objects (numObjId) specified on the dsmBeginGetData call exceeds DSM\_MAX\_GET\_OBJ | DSM\_MAX\_PARTIAL\_GET\_OBJ.

### **System action**

The system returns to the calling procedure.

### **User response**

Check the number of objects before calling dsmBeginGetData. If it is greater than DSM\_MAX\_GET\_OBJ | DSM\_MAX\_PARTIAL\_GET\_OBJ, then issue multiple Get call sequences.

## **2030 E DSM\_RC\_NEWPW\_REQD The new password value is NULL or blank.**

---

### **Explanation**

There is no value provided for new password.

### **System action**

The system returns to the calling procedure.

### **User response**

Provide a new password on dsmChangePW.

## **2031 E DSM\_RC\_OLDPW\_REQD The old password value is NULL or blank.**

---

### **Explanation**

There is no value provided for old password.

### **System action**

The system returns to the calling procedure.

### **User response**

Provide an old password on dsmChangePW.

## **2032 E DSM\_RC\_NO\_OWNER\_REQD On dsmInit, the owner is not allowed to establish a session when PASSWORDACCESS=generate.**

---

## Explanation

PASSWORDACCESS=GENERATE establishes a session with the current login user as the owner. The application should set clientOwnerNameP to NULL when PASSWORDACCESS=GENERATE is in effect.

## System action

The system returns to the calling procedure. Whether the application can continue processing depends on how the application handles the error.

## User response

This message applies to applications that utilize the IBM Spectrum Protect API, and is intended primarily for the vendor of the application for which the message is issued. Depending on the application, this could be a configuration issue.

Consult the documentation for the application and verify that the application is configured correctly. If the problem persists, contact the application vendor for further assistance.

## 2033 E DSM\_RC\_NO\_NODE\_REQD On dsmInit, the node is not allowed when PASSWORDACCESS=generate.

---

### Explanation

PASSWORDACCESS=generate establishes a session with the current hostname as the node.

### System action

The system returns to the calling procedure.

### User response

When using PASSWORDACCESS=generate, set clientNodeNameP to NULL.

## 2034 E DSM\_RC\_KEY\_MISSING The key file is missing.

---

### Explanation

The key file for Data Protection for Oracle cannot be found.

### System action

The system returns to the calling procedure.

### User response

Ensure that you have ordered the Data Protection for Oracle, and install the key file.

## 2035 E DSM\_RC\_KEY\_BAD The key file content is invalid.

---

### Explanation

The key file content for Data Protection for Oracle is invalid.

## System action

The system returns to the calling procedure.

## User response

Ensure that you have ordered the Data Protection for Oracle, and install the key file.

## **2041 E DSM\_RC\_BAD\_CALL\_SEQUENCE The sequence of calls is invalid.**

---

### Explanation

Then API requires function calls to be made in a specific sequence. The function calls were not made in the expected sequence. The error can be triggered by the following issues:

- An error in the network.
- A bug in the IBM Spectrum Protect API.
- A bug in the IBM Spectrum Protect server.
- A bug in the application (IBM or third party) that uses the IBM Spectrum Protect API.

## System action

The system returns to the calling procedure.

## User response

An end user can respond in the following ways:

- Check the network for errors.
- Look for clues in the IBM Spectrum Protect server activity log file, client side dserror.log log file, and log files that are specific to the problem application.
- Search the IBM support pages for APARs that match the problem. The support site is at IBM Spectrum Protect Support Portal
- If the API application is developed by a third party (not IBM), search that third party's support pages for known issues that match the problem.

If none of the above actions resolve the problem, report the problem to the vendor of the application that uses the IBM Spectrum Protect API.

A developer of an application that uses the IBM Spectrum Protect API must investigate the reason for the problem, including reviewing the IBM Spectrum Protect API state diagram. The IBM Spectrum Protect API state diagram is in the product documentation at IBM Spectrum Protect product documentation

## **2042 E DSM\_RC\_INVALID\_TSMBUFFER The tsmBuffHandle is invalid, or the value of dataPtr is invalid.**

---

### Explanation

An invalid value for a handle or dataPtr has been passed into the API.

## System action

The system returns to the calling procedure.

## User response

There is a problem with the calling application. Verify the values of the tsmBuffHandle and dataptr passed to the API.

## **2043 E DSM\_RC\_TOO\_MANY\_BYTES The number of bytes copied into the tsmBuffer is larger than the allowed value.**

---

### **Explanation**

An invalid number of bytes was copied to a tsmBuffer.

### **System action**

The system returns to the calling procedure.

### **User response**

There is a problem with the calling application. Verify the number of bytes copied into the tsmBuffer.

## **2044 E DSM\_RC\_MUST\_RELEASE\_BUFFER dsmTerminate cannot finish because the application is holding on to 1 or more tsmBuffers.**

---

### **Explanation**

An application is trying to terminate a session, but is still holding some tsmBuffers.

### **System action**

The system returns to the calling procedure.

### **User response**

The application must return all buffers for this session by calling tsmReleaseBuffer, and then issue dsmTerminate.

## **2045 E DSM\_RC\_BUFF\_ARRAY\_ERROR An internal error occurred in the tsmBuffer array.**

---

### **Explanation**

An internal API buffer array error occurred.

### **System action**

The system returns to the calling procedure.

### **User response**

Try the operation again. If the problem continues, contact your system administrator or service representative.

## **2046 E DSM\_RC\_INVALID\_DATA\_BLK When using useTsmBuffers, dataBlk must be NULL in calls to dsmSendObj and dsmGetObj.**

---

### **Explanation**

The value for dataBlk must be NULL when using useTsmBuffers.

### **System action**

The system returns to the calling procedure.

### **User response**

There is a problem with the calling application. Contact your application provider

## **2047 E DSM\_RC\_ENCR\_NOT\_ALLOWED Encryption is not allowed when using useTsmBuffers.**

---

### **Explanation**

useTsmBuffers does not support encryption.

### **System action**

The system returns to the calling procedure.

### **User response**

Try the operation again, without using useTsmBuffers, or disable encryption for this operation.

## **2048 E DSM\_RC\_OBJ\_COMPRESSED This object cannot be restored/retrieved using useTsmBuffers, because it is compressed.**

---

### **Explanation**

useTsmBuffers does not support compression.

### **System action**

The system returns to the calling procedure.

### **User response**

Try the operation again, without using useTsmBuffers.

## **2049 E DSM\_RC\_OBJ\_ENCRYPTED This object cannot be restored/retrieved using useTsmBuffers, because it is encrypted.**

---

### **Explanation**

useTsmBuffers does not support encryption.

### **System action**

The system returns to the calling procedure.

### **User response**

Try the operation again, without using useTsmBuffers.

## **2050 E DSM\_RC\_WILDCHAR\_NOTALLOWED On dsmSendObj, wildcards are not allowed for the objName.**

---

### **Explanation**

On dsmSendObj, wildcards are not allowed for the objName.

### **System action**

The system returns to the calling procedure.

### **User response**

Provide a fs, hl, and ll on the dsmObjName.

## **2051 E DSM\_RC\_POR\_NOT\_ALLOWED When using useTsmBuffers, a restore/retrieve with partial object restore is not allowed.**

---

### **Explanation**

useTsmBuffers does not support partial object restore.

### **System action**

The system returns to the calling procedure.

### **User response**

Make sure the calling application is either using Partial object restore or useTsmBuffers.

## **2052 E DSM\_RC\_NO\_ENCRYPTION\_KEY No encryption key was found. If you are using -encryptkey=prompt make sure there is a value in the encryptionPasswordP field and that bEncryptKeyEnabled is set to true.**

---

### **Explanation**

There was no encryption key found in the password file, or no key was provided by the application.

### **System action**

The system returns to the calling procedure.

### **User response**

If you are using -encryptkey=prompt, make sure there is a value in encryptionPasswordP and that bEncryptKeyEnabled is set to true.



## 2053 E DSM\_RC\_ENCR\_CONFLICT Conflicting encryption key options have been specified.

---

### Explanation

When using the ENABLEENCRYPTKEY option, the parameter bEncryptKeyEnabled for the IBM Spectrum Protect API dsmInitExIn\_t and tsmInitExIn\_t structures cannot be set to bTrue.

### System action

The system returns to the calling procedure.

### User response

Either remove the ENABLEENCRYPTKEY option from the options file, or set the parameter bEncryptKeyEnabled to bFalse in the program using the IBM Spectrum Protect API.

## 2060 E DSM\_RC\_FSNAME\_NOTFOUND The filespace to delete/set access cannot be found.

---

### Explanation

The filespace to delete cannot be found.

### System action

The system returns to the calling procedure.

### User response

Verify the filespace name.

## 2061 E DSM\_RC\_FS\_NOT\_REGISTERED On dsmSendObj, dsmDeleteObj, or dsmUpdateFS the filespace is not registered.

---

### Explanation

On dsmSendObj, dsmDeleteObj, or dsmUpdateFS, the filespace is not registered.

### System action

The system returns to the calling procedure.

### User response

Verify the filespace name.

## 2062 W DSM\_RC\_FS\_ALREADY\_REGED On dsmRegisterFS the filespace is already registered.

---

### Explanation

On dsmRegisterFS the filespace is already registered.

### **System action**

The system returns to the calling procedure.

### **User response**

Verify the filespace name.

## **2063 E DSM\_RC\_OBJID\_NOTFOUND On dsmBeginGetData the objID is NULL.**

---

### **Explanation**

On dsmBeginGetData, the objID is NULL.

### **System action**

The system returns to the calling procedure.

### **User response**

Verify the following:

- The dsmGetList is not NULL.
- Each objID is not NULL.
- The dsmGetList numObjId is not zero.

## **2064 E DSM\_RC\_WRONG\_VERSION On dsmInit, the caller API version is different than the IBM Spectrum Protect library version.**

---

### **Explanation**

On dsmInit, the caller API version is later than the IBM Spectrum Protect library version.

### **System action**

The system returns to the calling procedure.

### **User response**

Install the latest IBM Spectrum Protect API library.

## **2065 E DSM\_RC\_WRONG\_VERSION\_PARM The caller's structure version is different than the IBM Spectrum Protect library version.**

---

### **Explanation**

The caller's structure version is different than the IBM Spectrum Protect library version.

### **System action**

The system returns to the calling procedure.

### User response

Ensure that the stVersion field is set with the value in the header file. Recompile the application with the latest header files.

## **2070 E DSM\_RC\_NEEDTO\_ENDTXN Issue dsmEndTxn and then begin a new transaction session.**

---

### Explanation

This transaction must be ended and a new one must be started due to one of the following reasons:

- The destination changed.
- The byte limit is exceeded
- The maximum number of objects is exceeded.

### System action

The system returns to the calling procedure.

### User response

Issue dsmEndTxn and start a new transaction session.

## **2080 E DSM\_RC\_OBJ\_EXCLUDED The backup or archive object is excluded from processing.**

---

### Explanation

The backup or archive object is excluded from processing.

### System action

The system returns to the calling procedure.

### User response

Verify the objName and Exclude lists.

## **2081 E DSM\_RC\_OBJ\_NOBCG The backup object does not have a copy group.**

---

### Explanation

The backup object does not have a copy group.

### System action

The system returns to the calling procedure.

### User response

Verify server policy definitions.

## **2082 E DSM\_RC\_OBJ\_NOACG The archive object does not have a copy group.**

---

### **Explanation**

The archive object does not have a copy group.

### **System action**

The system returns to the calling procedure.

### **User response**

Verify server policy definitions.

## **2090 E DSM\_RC\_APISYSTEM\_ERROR Memory used by the IBM Spectrum Protect API has been corrupted.**

---

### **Explanation**

Memory used by the IBM Spectrum Protect API has been corrupted.

### **System action**

The system returns to the calling procedure.

### **User response**

Retry the operation. If the problem continues, contact your system administrator or service representative.

## **2100 E DSM\_RC\_DESC\_TOOLONG The sendObj Archive description is too long.**

---

### **Explanation**

The sendObj Archive description is too long.

### **System action**

The system returns to the calling procedure.

### **User response**

The sndArchiveData.descr string must be less than or equal to DSM\_MAX\_DESCR\_LENGTH.

## **2101 E DSM\_RC\_OBJINFO\_TOOLONG The sendObj ObjAttr.objInfo is too long.**

---

### **Explanation**

The sendObj ObjAttr.objInfo is too long.

### **System action**

The system returns to the calling procedure.

### **User response**

The objInfo field must be less than or equal to DSM\_MAX\_OBJINFO\_LENGTH.

## **2102 E DSM\_RC\_HL\_TOOLONG The sendObj dsmObjName.hl is too long.**

### **Explanation**

The sendObj dsmObjName.hl is too long.

### **System action**

The system returns to the calling procedure.

### **User response**

The hl field must be less than or equal to DSM\_MAX\_HL\_LENGTH.

## **2103 E DSM\_RC\_PASSWD\_TOOLONG The password, or encryptionPassword string provided is too long.**

### **Explanation**

The value provided for password or encryptionPassword is too long.

### **System action**

The system returns to the calling procedure.

### **User response**

The password or encryptionPassword field must be less than DSM\_MAX\_VERIFIER\_LENGTH.

## **2104 E DSM\_RC\_FILESPACE\_TOOLONG The sendObj dsmObjName.fs is too long.**

### **Explanation**

The sendObj dsmObjName.fs is too long.

### **System action**

The system returns to the calling procedure.

### **User response**

The fs field must be less than or equal to DSM\_MAX\_FS\_LENGTH.

## **2105 E DSM\_RC\_LL\_TOOLONG The sendObj dsmObjName.ll is too long.**

---

### **Explanation**

The sendObj dsmObjName.ll is too long.

### **System action**

The system returns to the calling procedure.

### **User response**

The ll field must be less than or equal to DSM\_MAX\_LL\_LENGTH.

## **2106 E DSM\_RC\_FSINFO\_TOOLONG On RegisterFS or UpdateFS the fsAttr's fsInfo is too long.**

---

### **Explanation**

On RegisterFS or UpdateFS the fsAttr's fsInfo is too long.

### **System action**

The system returns to the calling procedure.

### **User response**

The fsInfo field must be less than or equal to DSM\_MAX\_FSINFO\_LENGTH.

## **2107 E DSM\_RC\_SENDDATA\_WITH\_ZERO\_SIZE Cannot Send data with a zero byte sizeEstimate.**

---

### **Explanation**

You cannot send data for an object with size estimate = 0.

### **System action**

The system returns to the calling procedure.

### **User response**

Set size estimate greater than 0 in dsmSendObj.

## **2110 E DSM\_RC\_INVALID\_ACCESS\_TYPE The dsmSetAccess access Type is invalid.**

---

### **Explanation**

The dsmSetAccess accessType is invalid.

### **System action**

The system returns to the calling procedure.

### **User response**

The accessType must be one of the following:

- atBackup
- atArchive

## **2111 E DSM\_RC\_QUERY\_COMM\_FAILURE Communications error with server during object query**

---

### **Explanation**

An unexpected communications error occurred during an object query to the server.

### **System action**

Processing stopped.

### **User response**

Verify that communications are active between the client and server machines. Server outages, processor outages, and communication controller outages can cause this error.

## **2112 E DSM\_RC\_NO\_FILES\_BACKUP No files have been previously backed up for this filename/filespace.**

---

### **Explanation**

You tried to set access to files when no files for the specified filename, drive or file system were previously backed up.

### **System action**

Processing stopped.

### **User response**

Ensure that the correct drive or file system was specified and that files are backed up for you to set access.

## **2113 E DSM\_RC\_NO\_FILES\_ARCHIVE No files have been previously archived for this filename/filespace.**

---

### **Explanation**

You tried to set access to files when no files for the specified filename, drive or file system were previously archived.

### **System action**

Processing stopped.

### User response

Ensure that the correct drive or file system was specified and that files are archived for you to set access.

## 2114 E DSM\_RC\_INVALID\_SETACCESS Invalid format for Set Access command.

---

### Explanation

The SET ACCESS command must have at least three operands, the first of which must be either BACKUP or ARCHIVE. A validly formed file specification must follow.

### System action

Processing stopped, the command is not executed.

### User response

Use the HELP SET ACCESS command for complete details of usage, then enter the SET ACCESS command using the correct syntax.

## 2120 E DSM\_RC\_STRING\_TOO\_LONG The following message was too long to log to the server: '*shortened message with message number*'

---

### Explanation

The message text and inserts are too large to send to the server in the available internal buffer.

### System action

The *message number* message is written to the local client error log, then shortened and sent to the server as a part of this message. The message is reduced in length by substituting '...' in the middle of the original message.

### User response

The message referred to has been shortened, but describes the error that occurred. See the documentation for that message for more information.

## 2200 I DSM\_RC\_MORE\_DATA On dsmGetNextQObj or dsmGetData there is more available data.

---

### Explanation

On dsmGetNextQObj or dsmGetData there is more available data.

### System action

The system returns to the calling procedure.

### User response



Call the function again.

## **2210 E DSM\_RC\_BUFF\_TOO\_SMALL The dataBlk buffer is too small for the query response.**

---

### **Explanation**

The dataBlk buffer is too small for the query response.

### **System action**

The system returns to the calling procedure.

### **User response**

On dsmGetNextQObj ensure that the dataBlk buffer is at least as big as the query response structure.

## **2228 E DSM\_RC\_NO\_API\_CONFIGFILE The configuration file specified on dsmInit cannot be opened.**

---

### **Explanation**

The configuration file specified on dsmInit cannot be opened.

### **System action**

The system returns to the calling procedure.

### **User response**

Verify the file name.

## **2229 E DSM\_RC\_NO\_INCLEXCL\_FILE The Include/Exclude definition file was not found.**

---

### **Explanation**

The Include/Exclude definition file was not found.

### **System action**

The system returns to the calling procedure.

### **User response**

Verify the file name on the Inclexcl option.

## **2230 E DSM\_RC\_NO\_SYS\_OR\_INCLEXCL Either the dsm.sys file was not found, or the Inclexcl file specified in dsm.sys was not found.**

---

### **Explanation**

Either the dsm.sys file was not found, or the Inclexcl file specified in dsm.sys was not found.

### **System action**

The system returns to the calling procedure.

### **User response**

The dsm.sys file must be in the directory referenced by the environment variable DSMI\_DIR. Verify the file name on the Inclexcl option in the dsm.sys file.

## **2231 E DSM\_RC\_REJECT\_NO\_POR\_SUPPORT Partial Object Retrieve is not supported on this server.**

---

### **Explanation**

The IBM Spectrum Protect server specified by the user does not support partial object retrieve.

### **System action**

The system returns to the calling procedure.

### **User response**

Specify a IBM Spectrum Protect server which supports the partial object retrieve function.

## **2300 E DSM\_RC\_NEED\_ROOT Only a UNIX root user can execute dsmChangePW or dsmDeleteFS.**

---

### **Explanation**

Only a UNIX root user can execute dsmChangePW or dsmDeleteFS.

### **System action**

The system returns to the calling procedure.

### **User response**

Run this program as a root user.

## **2301 E DSM\_RC\_NEEDTO\_CALL\_BINDMC You must issue dsmBindMC before dsmSendObj.**

---

### **Explanation**

You must issue dsmBindMC before dsmSendObj.

### **System action**

The system returns to the calling procedure.

## User response

Modify your program.

## **2302 I DSM\_RC\_CHECK\_REASON\_CODE The dsmEndTxn vote is ABORT, so check the reason field.**

---

### Explanation

After a dsmEndTxn call, the transaction is aborted by either the server or client with a DSM\_VOTE\_ABORT and the reason is returned.

### System action

The system returns to the calling procedure.

## User response

Check the reason field for the code which explains why the transaction has been aborted.

## **2400 E DSM\_RC\_ALMGR\_OPEN\_FAIL License file could not be opened.**

---

### Explanation

The license file was not found, or could not be opened because of permissions or the file is corrupted.

### System action

The system returns to the calling procedure.

## User response

Check permissions on file. See if the license file is in the correct place.

## **2401 E DSM\_RC\_ALMGR\_READ\_FAIL Read failure on the license file.**

---

### Explanation

The license file was not found, or could not be opened because of permissions, or the file is corrupted.

### System action

The system returns to the calling procedure.

## User response

Check permissions on file. See if the license file is in the correct place.

## **2402 E DSM\_RC\_ALMGR\_WRITE\_FAIL Write failure on the license file.**

---

### Explanation

The license file was not found, or could not be opened because of permissions or the file is corrupted.

### **System action**

The system returns to the calling procedure.

### **User response**

Check permissions on file. See if license file is in the correct place.

## **2403 E DSM\_RC\_\_ALMGR\_DATA\_FMT Data in the license file is not in a valid format.**

---

### **Explanation**

The license file is not valid.

### **System action**

The system returns to the calling procedure.

### **User response**

User needs to obtain a new license.

## **2404 E DSM\_RC\_ALMGR\_CKSUM\_BAD The checksum in the license file does not match the licenseregistration string.**

---

### **Explanation**

The registration string is not valid.

### **System action**

The system returns to the calling procedure.

### **User response**

User needs to obtain a new license.

## **2405 E DSM\_RC\_ALMGR\_TRIAL\_EXPRD This is an expired try and buy license.**

---

### **Explanation**

The registration string is not valid.

### **System action**

The system returns to the calling procedure.

### **User response**

User needs to obtain a new license.

## 4580 E DSM\_RC\_ENC\_WRONG\_KEY Error processing '*filesystemnamepath-namefile-name*'; invalid encryption key.

---

### Explanation

The key you entered does not match the key that was used to encrypt the file during backup. The file can not be restored unless the matching key is entered.

### System action

processing stops.

### User response

Try the restore operation again and provide the correct key.

## 4582 E DSM\_RC\_ENC\_NOT\_AUTHORIZED User is not authorized to encrypt *file-space namedirectory\_pathfile\_name*.

---

### Explanation

The user is not authorized to encrypt the file. Normally, only a IBM Spectrum Protect authorized user or a root user can use IBM Spectrum Protect encryption. However, a certain combination of PASSWORDACCESS and ENCRYPTKEY options may allow encryption operations by a non-authorized user.

### System action

The file is not backed up or restored.

### User response

Log in as a root or IBM Spectrum Protect authorized user and try the operation again. See IBM Spectrum Protect Backup-Archive Client Installation and User's Guide for the correct usage of the ENCRYPTKEY option.

## 4584 E DSM\_RC\_ENC\_TYPE\_UNKOWN Error processing '*filesystemnamepath-namefile-name*': unsupported encryption type.

---

### Explanation

The files you are trying to restore or retrieve have been backed up or archived by a later version of the IBM Spectrum Protect client. The file encryption method is not supported by the current client.

### System action

Object skipped.

### User response

Restore or retrieve the file with the most recent version of the IBM Spectrum Protect client.

## **4600 E DSM\_RC\_CLUSTER\_INFO\_LIBRARY\_NOT\_LOADED CLUSTERNODE is set to YES but the Cluster Information Daemon is not started.**

---

### **Explanation**

The HACMP Cluster Information Daemon must be started in order to specify the CLUSTERNODE option.

### **System action**

Processing ends.

### **User response**

Start the HACMP Cluster Information Daemon.

## **4601 E DSM\_RC\_CLUSTER\_LIBRARY\_INVALID CLUSTERNODE is set to YES but the cluster load library is not valid.**

---

### **Explanation**

The load library that the operating system provides to obtain the cluster name is not valid. A possible cause is an out-of-date load library which does not contain the proper routines this product expects.

### **System action**

Processing ends.

### **User response**

Ensure that the latest cluster software is installed on the system.

## **4602 E DSM\_RC\_CLUSTER\_LIBRARY\_NOT\_LOADED CLUSTERNODE is set to YES but the cluster software is not available on this system.**

---

### **Explanation**

The load library that the operating systems provides to obtain the cluster name is not available on this system.

### **System action**

Processing ends.

### **User response**

Ensure that the cluster software is installed on the system.

## **4603 E DSM\_RC\_CLUSTER\_NOT\_MEMBER\_OF\_CLUSTER CLUSTERNODE is set to YES but this machine is not a member of a cluster.**

---

### **Explanation**

This machine is not a member of a cluster node. Possible causes are that the cluster service has not been configured correctly, or that the cluster is in the process of initialization.

### **System action**

Processing ends.

### **User response**

Ensure that the cluster software is configured properly. If the cluster is in the process of initialization, retry the operation at a later time.

## **4604 E DSM\_RC\_CLUSTER\_NOT\_ENABLED CLUSTERNODE is set to YES but the cluster service is not enabled on this system.**

---

### **Explanation**

The cluster service has not been enabled on this system.

### **System action**

Processing ends.

### **User response**

Enable the cluster service on the system.

## **4605 E DSM\_RC\_CLUSTER\_NOT\_SUPPORTED The CLUSTERNODE option is not supported on this system.**

---

### **Explanation**

This option is not supported on this system.

### **System action**

Processing ends.

### **User response**

Disable the CLUSTERNODE option in the local options file.

## **4606 E DSM\_RC\_CLUSTER\_UNKNOWN\_ERROR An unexpected error (*retcode*) occurred while the program was trying to obtain the cluster name from the system.**

---

### **Explanation**

An unknown error occurred while the program was trying to obtain the cluster name from the cluster service. The error code is the reason code provided directly from the cluster service being used in this operating system environment.

### **System action**

Processing ends.

### **User response**

Consult the documentation for your clustering software for an explanation of the reason code. Insure that your clustering service is operational, then try the IBM Spectrum Protect operation again.

## **5200 E DSM\_RC\_ABORT\_CERTIFICATE\_NOT\_FOUND The remote node is not properly configured on the IBM Spectrum Protect server.**

---

### **Explanation**

The remote node is not properly configured on the IBM Spectrum Protect server.

### **System action**

Processing stopped.

### **User response**

Ensure that the remote node is properly configured and connected to the IBM Spectrum Protect server by using TLS. This validates the remote node configuration and ensures that the information that is related to the remote node is sent to the server.

## **5702 E DSM\_RC\_PROXY\_REJECT\_NO\_RESOURCES Proxy Rejected: The IBM Spectrum Protect server has run out of memory.**

---

### **Explanation**

There is not enough memory available to allow this operation to continue.

### **System action**

Current operation has been cancelled.

### **User response**

Try the operation again. If the problem continues, see your system administrator to increase the amount of memory of the server.



## 5705 E DSM\_RC\_PROXY\_REJECT\_DUPLICATE\_ID Proxy Rejected: The ASNODENAME and NODENAME options have the same value.

---

### Explanation

The ASNODENAME and NODENAME options cannot have the same value.

### System action

The current operation is cancelled.

### User response

Use the ASNODENAME option only to access another node. It is not necessary to set the ASNODENAME option to access your own node. Remove the ASNODENAME option from your option file unless you are actually trying to access a node that you have been granted authority to access with the administrative command "Grant Proxynode".

## 5710 E DSM\_RC\_PROXY\_REJECT\_ID\_IN\_USE Proxy Rejected: The node name you specified in the ASNODENAME option is locked.

---

### Explanation

The IBM Spectrum Protect administrator has locked the node you specified as the ASNODENAME option.

### System action

The IBM Spectrum Protect operation ends.

### User response

The IBM Spectrum Protect server administrator must unlock the node before you can access it. Try the operation later, or check with your IBM Spectrum Protect administrator.

## 5717 E DSM\_RC\_PROXY\_REJECT\_INTERNAL\_ERROR Proxy Rejected: The server has an internal error.

---

### Explanation

The client cannot proxy to the node named by the ASNODENAME option because of an internal server error.

### System action

Current operation has been cancelled.

### User response

See your system administrator immediately.

## 5722 E DSM\_RC\_PROXY\_REJECT\_NOT\_AUTHORIZED Proxy Rejected: Proxy authority has not been granted to this node.

---

## Explanation

The node has not been granted proxy authority to access the node named by the ASNODENAME option. The IBM Spectrum Protect administrator must first grant proxy authority.

## System action

The IBM Spectrum Protect operation ends.

## User response

The IBM Spectrum Protect server administrator must grant proxy authority for this node. See the administrator command "Grant Proxynode".

## **5746 E DSM\_RC\_PROXY\_INVALID\_FROMNODE The ASNODENAME option is not valid with the FROMNODE option.**

---

## Explanation

None.

## System action

Processing stops.

## User response

Remove the ASNODENAME option from the options file or do not use the FROMNODE option.

## **5748 E DSM\_RC\_PROXY\_INVALID\_CLUSTER The ASNODENAME option cannot be used with the CLUSTERNODE option.**

---

## Explanation

None.

## System action

Processing stops.

## User response

Remove the ASNODENAME option and retry the operation.

## **5749 E DSM\_RC\_PROXY\_INVALID\_FUNCTION The operation that is being attempted cannot be invoked using the ASNODENAME option.**

---

## Explanation

None.

## System action

Processing stops.

## User response

Remove the ASNODENAME option and retry the operation.

# 5801 E DSM\_RC\_CRYPTO\_ICC\_ERROR Unexpected error in cryptography library.

---

## Explanation

There was an unexpected error in the cryptography library. See the error log for more information.

## System action

processing stops.

## User response

Check the error log for ANS1467E to determine the cause of failure. Verify you IBM Spectrum Protect client is installed properly. If needed, reinstall client and/or API. If the problem still exists, contact IBM Spectrum Protect technical support.

## Descriptions of I/O codes in server messages

---

IBM Spectrum Protect™ messages can contain input/output (I/O) codes. The codes can be operation codes, completion codes, additional sense codes (ASC), and additional sense code qualifier (ASCQ) codes.

Code descriptions are provided for I/O error messages from the IBM Spectrum Protect server for all supported operating systems.

### Code

#### Description

OP

I/O operation that failed. These values can be displayed:

- READ
- WRITE
- FSR (forward space record)
- RSR (reverse space record)
- FSF (forward space file)
- RSF (reverse space file)
- WEOF (write end of file mark)
- OFFL (rewind and unload the tape)
- FLUSH (flush)
- GET\_MEDIUM\_INFO (get medium information)
- LOCATE (locate)
- QRYLBP (query logical block protection)
- RDBLKID (read block ID)
- SETLBP (set logical block protection)
- SETMODE (set mode)
- REW (rewind)
- SPACEEOD (space end of data)
- TESTREADY (test drive ready)

CC

I/O completion code. This value is returned by the device driver to the server when an error occurs. For a list of completion codes, see Completion code and operation code values overview. For information about tape library system calls and error descriptions for the library I/O control requests, see technote S7002972.

KEY

Byte 2 of the sense bytes from the error. The following lists some definitions:

- 0 = no additional sense bytes available
- 1 = recovered error
- 2 = not ready
- 3 = medium error
- 4 = hardware error
- 5 = incorrect request
- 6 = unit attention (for example, a SCSI bus reset)
- 7 = data protect
- 8 = blank check
- 9 = vendor specific
- A = copy canceled
- B = canceled command
- C = obsolete
- D = volume overflow
- E = miscompare
- F = reserved

#### ASC/ASCQ

ASC and ASCQ codes are bytes 12 and 13 of the sense bytes. The drive or library reference manual provided with the device contains tables explaining the values of the KEY, ASC, and ASCQ fields. Descriptions of standard ASC and ASCQ codes provides additional information about standard values of ASC and ASCQ codes.

#### Operating system error codes

When a command fails, the operating system returns an error number. To determine what the error codes mean, take the following action:

- On AIX®, HP-UX, and Solaris, platforms, view the errno.h file in the /usr/include/sys directory. This file provides definitions for error codes.
- On Linux platforms, view the errno-base.h and errno.h files in the /usr/include/asm-generic directory. These files provides definitions for codes.
- On Windows platforms, contact Microsoft Support for help with error messages.
- Completion code and operation code values overview  
IBM Spectrum Protect messages can contain device driver completion codes from the device drivers.
- Descriptions of standard ASC and ASCQ codes  
Standard ASC and ASCQ codes are described.

## Completion code and operation code values overview

IBM Spectrum Protect™ messages can contain device driver completion codes from the device drivers.

- Device drivers completion codes: Common codes  
IBM Spectrum Protect device drivers provide completion codes that are common to all device classes.
- Device drivers completion codes: Media changers  
IBM Spectrum Protect device drivers provide completion codes that are specific to media changer devices.
- Device drivers completion codes: Tape drives  
IBM Spectrum Protect device drivers provide completion codes that are specific to tape drives.

## Device drivers completion codes: Common codes

IBM Spectrum Protect™ device drivers provide completion codes that are common to all device classes.

The following table shows common completion code values for IBM Spectrum Protect device drivers. Each entry provides a description for the I/O error message and the recommended action. After completing the recommended action, try the failing operation again.

Table 1. Completion code values common to all device classes

Decimal	Hexadecimal	Description	Recommended action
200	X'C8'	The device indicated a failure condition, but sense data was unavailable.	Try the failing operation again.
201	X'C9'	The device driver failed.	Contact IBM Spectrum Protect Support.

Decimal	Hexadecimal	Description	Recommended action
202	X'CA'	The device EEPROM failed.	Test the device. Service the device if necessary.
203	X'CB'	Manual intervention is required.	Correct the problem on the device. The problem can be a stuck tape, dirty heads, or a jammed library arm.
204	X'CC'	The system recovered from an I/O error; for your information only.	No action necessary.
205	X'CD'	The SCSI adapter failed.	Check for loose cables, bent pins, bad cables, bad SCSI adapters, improper termination, or bad terminators.
206	X'CE'	A general SCSI failure occurred.	Check for loose cables, bent pins, bad cables, bad SCSI adapters, improper termination, or bad terminators.
207	X'CF'	The device cannot perform the requested action.	Ensure that the device is on and ready. Ensure that the drive was defined appropriately with the DEFINE DRIVE command. Ensure that the device class was defined appropriately with the DEFINE DEVCLASS command.
208	X'D0'	The command stopped.	Contact IBM Spectrum Protect Support.
209	X'D1'	A failure is detected in the device microcode.	Check the microcode level of the drive. Contact the drive manufacturer and request the latest level.
210	X'D2'	The device was reset due to device power-up, SCSI bus reset, or manual tape load/eject.	Try the failing operation again.
211	X'D3'	The SCSI bus is busy.	Ensure that the SCSI IDs are correctly assigned to the correct device, and the device is not being accessed by another process.
212	X'D4'	Persistent reservation is not supported on this device.	No action is necessary.
213	X'D5'	A persistent reservation operation failed.	Reset the device and try the operation again. If the problem persists, contact IBM Spectrum Protect Support.

## Device drivers completion codes: Media changers

IBM Spectrum Protect™ device drivers provide completion codes that are specific to media changer devices.

The following table shows completion code values for IBM Spectrum Protect device drivers for media changers. Each entry provides a description for the I/O error message and the recommended action. After performing the recommended action, try the failing operation again.

Table 1. Completion code values for media changers

Decimal	Hexadecimal	Description	Recommended action
300	X'12C'	Cartridge entry/exit error	Check the entry/exit ports for a jammed volume.
301	X'12D'	Cartridge load failure	Check the drive for jammed volumes. On AIX®, display the errprt to check for hardware errors.

Decimal	Hexadecimal	Description	Recommended action
302	X'12E'	Cartridge in failed drive	Check the drive for jammed volumes. On AIX, display the errpt to check for hardware errors.
303	X'12F'	Carousel not loaded	Ensure that the carousel is correctly in place and the door is shut.
304	X'130'	Changer failure	On AIX, display the errpt to check for hardware errors.
305	X'131'	Drive failure	Ensure that the heads are clean. On AIX, display the errpt to check for hardware errors.
306	X'132'	Drive or media failure	Ensure that the heads are clean. On AIX, display the errpt to check for hardware errors.
307	X'133'	Entry/exit failure	Check the tape library interface for hardware errors. If there are no errors, contact IBM Spectrum Protect Support.
308	X'134'	Entry/exit port not present	Check the tape library interface for hardware errors. If there are no errors, contact IBM Spectrum Protect Support.
309	X'135'	Library audit error	Ensure that there are no jammed volumes. It is possible that the library audit is failing due to hardware errors. On AIX, display the errpt to check for hardware errors.
310	X'136'	Library full	Check for jammed volumes. Ensure that the volumes are not rearranged. If the library is not full, start the AUDIT LIBRARY command.
311	X'137'	Media export	Check the tape library interface for hardware errors. If there are no errors, contact IBM Spectrum Protect Support.
312	X'138'	Slot failure	Ensure that nothing is jammed in the slot.
313	X'139'	Slot or media failure	Ensure that the volume is not jammed in the slot and that the volumes are not rearranged. If the problem persists, start the AUDIT LIBRARY command.
314	X'13A'	The source slot or drive was empty in an attempt to move a volume	Ensure that the volumes are not rearranged. If the problem persists, start the AUDIT LIBRARY command.
315	X'13B'	The destination slot or drive was full in an attempt to move a volume	Ensure that the volumes are not rearranged, or that a volume is not stuck in the drive. If problem persists, start the AUDIT LIBRARY command.
316	X'13C'	Cleaner cartridge installed	Contact IBM Spectrum Protect support.
317	X'13D'	Media not ejected	Ensure that the volumes are not rearranged, or that a volume is not stuck in the drive. If problem persists, start the AUDIT LIBRARY command.
318	X'13E'	I/O port not configured	Contact IBM Spectrum Protect Support.
319	X'13F'	First destination empty	Ensure that the volumes are not rearranged. If problem persists, start the AUDIT LIBRARY command.
320	X'140'	No inventory information	Start the AUDIT LIBRARY command.

Decimal	Hexadecimal	Description	Recommended action
321	X'141'	Read element status mismatch	Ensure that host bus adapter drivers and firmware are at current levels. Check the tape library interface for hardware errors. If there are no errors, contact IBM Spectrum Protect Support.
322	X'142'	Initialize range failed	Check the tape library interface for hardware errors. If there are no errors, contact IBM Spectrum Protect Support.

## Device drivers completion codes: Tape drives

IBM Spectrum Protect™ device drivers provide completion codes that are specific to tape drives.

The following table shows completion code values for IBM Spectrum Protect device drivers for tape drives. Each entry provides a description for the I/O error message and the recommended action. After trying the recommended action, try the failing operation again.

Table 1. Completion code values for tape drives

Decimal	Hexadecimal	Description	Recommended action
400	X'190'	Physical end of media encountered	Ensure that the heads are clean on the drive.
401	X'191'	End of data detected	Contact IBM Spectrum Protect Support.
402	X'192'	Media corrupted	Ensure that the heads are clean. Ensure that the media is not physically damaged and has not reached the end of life as specified by the media manufacturer.
403	X'193'	Media failure	Ensure that the heads are clean. Ensure that the media is not physically damaged and has not reached the end of life as specified by the media manufacturer.
404	X'194'	Media incompatibility	Ensure that the correct length and type of media is being used.
406	X'196'	Sector that is requested is invalid	Internal server error. Contact IBM Spectrum Protect Support.
407	X'197'	Write protect	Ensure that the volume is not write protected.
408	X'198'	Clean the media and the drive	Clean the drive heads with a cleaning cartridge.
409	X'199'	Media fault	Ensure that the heads are clean. Ensure that the media is not physically damaged and has not reached the end of life as specified by the media manufacturer.
410	X'19A'	Cleaning complete	Try the failing operation again.
411	X'19B'	Logical end of media encountered	Contact IBM Spectrum Protect Support.
412	X'19C'	Media not present in drive	Ensure that the media is correctly positioned in the drive. If problem persists, start the AUDIT LIBRARY command.
413	X'19D'	Encountered the beginning of the media	Contact IBM Spectrum Protect Support.
414	X'19E'	Erase failure	Clean the drive heads.
415	X'19F'	Attempted to overwrite written WORM media	Internal server error. Contact IBM Spectrum Protect Support.

Decimal	Hexadecimal	Description	Recommended action
416	X'1A0'	An incorrect length block was read.	Ensure that the heads are clean. On AIX®, display the errpt to check for hardware errors.
417	X'1A1'	Open read only	Contact IBM Spectrum Protect Support.
418	X'1A2'	Open write only	Contact IBM Spectrum Protect Support.
419	X'1A2'	Media scan failed	Clean the drive and media.
420	X'1A4'	Logical write protect	Ensure that the heads are clean. Check operating system error logs for hardware errors. Verify that the write protect tab is off. Turn off SAN tape acceleration or set CHECKTAPEPOS to OFF or TSMonly.
422	X'1A6'	Cleaning is required	Clean the tape drive.
423	X'1A7'	Media error	Check operating system error logs for hardware errors. Check for bad media.
424	X'1A8'	Encryption-related error occurred	Check your encryption setting on your device class and tape drive.
425	X'1A9'	Decryption-related error occurred	Check your encryption setting on your device class and tape drive.
425	X'1AA'	An external, encryption-related error occurred	Check the encryption setting on your device class and tape drive.
426	X'1AB'	A CRC mismatch occurred	Ensure that the media has not reached the end of life as specified by the media manufacturer. Try the operation again.

## Descriptions of standard ASC and ASCQ codes

Standard ASC and ASCQ codes are described.

The ASC and ASCQ codes are bytes 12 and 13 for SCSI-2 devices. On Windows systems, these codes are displayed in the Windows Event Log, but the information is in different bytes.

See server message ANR8300E or ANR8302E for the recommended action.

The following table provides standard descriptions for some ASC and ASCQ codes. Each value has a prefix of 0x, which indicates that it is a hexadecimal constant. Note that descriptions vary among devices. For an accurate description of ASC and ASCQ codes for any device, see the documentation that comes with the device.

Table 1. Descriptions of standard ASC and ASCQ codes

ASC	ASCQ	Description
0x00	0x00	No additional sense
0x00	0x01	Filemark detected
0x00	0x02	End-of-medium detected
0x00	0x03	Setmark detected
0x00	0x04	Beginning of medium
0x00	0x05	End of data
0x00	0x06	I/O process terminated
0x02	0x00	No seek complete
0x03	0x00	Device write fault
0x03	0x01	No write current



<b>ASC</b>	<b>ASCQ</b>	<b>Description</b>
0x03	0x02	Excessive write errors
0x04	0x00	Logical unit not ready
0x04	0x01	Becoming ready
0x04	0x02	Not ready, initializing command required
0x04	0x03	Not ready, manual intervention required
0x04	0x04	Not ready, formatting
0x05	0x00	No response to select
0x06	0x00	No reference position found
0x07	0x00	Multiple devices selected
0x08	0x00	Communication failure
0x08	0x01	Communication timeout
0x08	0x02	Communication parity error
0x09	0x00	Track following error
0x0A	0x00	Error log overflow
0x0C	0x00	Write error
0x11	0x00	Unrecovered read error
0x11	0x01	Read retries exhausted
0x11	0x02	Error too long to correct
0x11	0x03	Multiple read errors
0x11	0x08	Incomplete block read
0x11	0x09	No gap found
0x11	0x0A	Miscorrected error
0x14	0x00	Recorded entity not found
0x14	0x01	Record not found
0x14	0x02	Filemark/setmark not found
0x14	0x03	End-of-data not found
0x14	0x04	Block sequence error
0x15	0x00	Random positioning error
0x15	0x01	Mechanical positioning error
0x15	0x02	Read positioning error
0x17	0x00	No error correction applied
0x17	0x01	Recovered with retries
0x17	0x02	Recovered with positive head offset
0x17	0x03	Recovered with negative head offset
0x18	0x00	ECC applied
0x1A	0x00	Parameter list length error
0x1B	0x00	Synchronous data transfer error
0x20	0x00	Invalid operation code
0x21	0x00	Block out of range
0x21	0x01	Invalid element address

<b>ASC</b>	<b>ASCQ</b>	<b>Description</b>
0x24	0x00	Invalid field in CDB
0x25	0x00	LUN not supported
0x26	00	Invalid field in parameter list
0x26	0x01	Parameter not supported
0x26	0x02	Parameter value invalid
0x26	0x03	Threshold parameters not supported
0x27	0x00	Write protected
0x28	0x00	Not-ready to ready
0x28	0x01	Import/export element accessed
0x29	0x00	Power-on, reset, bus reset
0x2A	0x00	Parameters changed
0x2A	0x01	Mode parameters changed
0x2A	0x02	Log parameters changed
0x2B	0x00	Copy cannot run
0x2C	0x00	Command sequence error
0x2D	0x00	Overwrite error on update
0x2F	0x00	Command cleared by initiator
0x30	0x00	Incompatible media
0x30	0x01	Media unknown format
0x30	0x02	Media incompatible format
0x30	0x03	Cleaning cartridge installed
0x31	0x00	Media format corrupted
0x33	0x00	Tape length error
0x37	0x00	Rounded parameter
0x39	0x00	Saving parameters not supported
0x3A	0x00	Medium not present
0x3B	0x00	Sequential positioning error
0x3B	0x01	Positioning error at BOT
0x3B	0x02	Positioning error at EOT
0x3B	0x08	Reposition error
0x3B	0x0D	Medium destination element full
0x3B	0x0E	Medium source element empty
0x3D	0x00	Invalid bits in message
0x3E	0x00	LUN not self-configured
0x3F	0x00	Operating conditions changed
0x3F	0x01	Microcode changed
0x3F	0x02	Changed operating definition
0x3F	0x03	Inquiry data changed
0x3F	0x0E	Reported LUNs data changed
0x43	0x00	Message error

ASC	ASCQ	Description
0x44	0x00	Internal target failure
0x45	0x00	Select/reselect failure
0x46	0x00	Unsuccessful soft reset
0x47	0x00	SCSI parity error
0x48	0x00	Initiator detected message received
0x49	0x00	Invalid message error
0x4A	0x00	Command phase error
0x4B	0x00	Data phase error
0x4C	0x00	LUN failed self-configuration
0x4E	0x00	Overlapped commands attempt
0x50	0x00	Write append error
0x50	0x01	Write append position error
0x50	0x02	Position error (timing)
0x51	0x00	Erase failure
0x52	0x00	Cartridge fault
0x53	0x00	Load/media eject failed
0x53	0x01	Unload tape failure
0x53	0x02	Media removal prevented
0x5A	0x00	Operator state changed
0x5A	0x01	Operator media removal
0x5A	0x02	Operator write protect
0x5A	0x03	Operator write permit
0x5B	0x00	Log exception
0x5B	0x01	Threshold condition met
0x5B	0x02	Log counter at maximum
0x5B	0x03	Log list codes exhausted

- ASC and ASCQ codes in the Windows Event Log  
ASC and ASCQ codes are displayed in the Windows Event Log.

## Device error codes in the AIX system error log

Some device error codes are logged in the AIX® system error log.

ADSM\_DD\_LOG1 (0xAC3AB953)  
DEVICE DRIVER SOFTWARE ERROR

This error is logged by the IBM Spectrum Protect™ device driver when a problem is suspected in the IBM Spectrum Protect device driver software. If the IBM Spectrum Protect device driver issues a SCSI I/O command with an illegal operation code, the command fails and the error is logged with this identifier. Report this error immediately to IBM Spectrum Protect Support.

**Detail Data:** Sense Data

The sense data contains information that can determine the cause of the error. Report all data in the error entry to IBM Spectrum Protect Support.

ADSM\_DD\_LOG2 (0x5680E405)

## HARDWARE/COMMAND-ABORTED ERROR

This error is logged by the IBM Spectrum Protect device driver when the device reports a hardware error or stop-command error in response to a SCSI I/O command.

### **Detail Data:** Sense Data

The sense data contains information that can determine which hardware component failed and why. To interpret the sense data for a particular device, refer to the SCSI specification manual for the device.

## ADSM\_DD\_LOG3 (0x461B41DE) MEDIA ERROR

This error is logged by the IBM Spectrum Protect device driver when a SCSI I/O command fails because of corrupted or incompatible media, or because a drive requires cleaning.

### **Detail Data:** Sense Data

The sense data contains information that can determine the cause of the error. To interpret the sense data for a particular device, refer to the SCSI specification manual for the device.

## ADSM\_DD\_LOG4 (0x4225DB66) TARGET DEVICE GOT UNIT ATTENTION

This error is logged by the IBM Spectrum Protect device driver after receiving certain UNIT ATTENTION notifications from a device. UNIT ATTENTIONs are informational and usually indicate that some state of the device changed. For example, this error would be logged if the door of a library device was opened and then closed. Logging this event indicates that the activity occurred and that the library inventory might be changed.

### **Detail Data:** Sense Data

The sense data contains information that describes the reason for the UNIT ATTENTION. To interpret the sense data for a particular device, see the SCSI specification manual for the device.

## ADSM\_DD\_LOG5 (0xDAC55CE5) PERMANENT UNKNOWN ERROR

This error is logged by the IBM Spectrum Protect device driver after receiving an unknown error from a device in response to a SCSI I/O command. If the error persists, report it to IBM Spectrum Protect support personnel.

### **Detail Data:** Sense Data

The sense data consists of information that can determine the cause of the error. Report all data in the error entry to IBM Spectrum Protect Support.

## ADSM\_DD\_LOG6 (0xBC539B26) WARNING OR INFORMATIONAL MESSAGE FOR TARGET DEVICE

This error is logged by the IBM Spectrum Protect device driver after receiving a warning or informational message from a device in response to a SCSI I/O command. These informational messages might not be an indication of a problem. If the message persists, report it to IBM Spectrum Protect Support.

### **Detail Data:** Sense Data

The sense data consists of information that can determine the reason for the message. Report all data in the entry to IBM Spectrum Protect Support.

## IBM Global Security Kit return codes

---

The server and client use the IBM Global Security Kit (GSKit) for SSL (Secure Sockets Layer) processing between the server and the backup-archive client. Some messages that are issued for SSL processing include GSKit return codes.

GSKit is automatically installed or updated during IBM Spectrum Protect™ installation and provides the following libraries:

- GSKit SSL
- GSKit Key Management API

- IBM Crypto for C (ICC)

The `tsmdiag` utility reports the GSKit level that is installed on your system, or you can use one of the following methods:

- For Windows, issue the following commands:

```
regedit /e gskitinfo.txt "HKEY_LOCAL_MACHINE\software\ibm\gsk8\"
notepad gskitinfo.txt
```

**CAUTION:**

You can damage the system registry if you use `regedit` incorrectly.

- For the 64-bit AIX® server, issue the following command from the command line: `gsk8ver_64`

See Table 1 for the GSKit SSL return codes.

The server uses the GSKit Key Management API to automatically create the key management database and server private and public keys. Some messages that are issued for this processing might include GSKit Key Management return codes. See Table 2 for the key management return codes.

Table 1. IBM Global Security Kit SSL general return codes

Return code (hex)	Return code (decimal)	Constant	Explanation
0x00000000	0	GSK_OK	The task completes successfully. Issued by every function call that completes successfully.
0x00000001	1	GSK_INVALID_HANDLE	The environment or SSL handle is not valid. The specified handle was not the result of a successful <code>open()</code> function call.
0x00000002	2	GSK_API_NOT_AVAILABLE	The dynamic link library (DLL) was unloaded and is not available (occurs on Microsoft Windows systems only).
0x00000003	3	GSK_INTERNAL_ERROR	Internal error. Report this error to IBM Software Support.
0x00000004	4	GSK_INSUFFICIENT_STORAGE	Insufficient memory is available to complete the operation.
0x00000005	5	GSK_INVALID_STATE	The handle is not in a valid state for operation, such as completing an <code>init()</code> operation on a handle twice.
0x00000006	6	GSK_KEY_LABEL_NOT_FOUND	Specified key label is not found in key file.
0x00000007	7	GSK_CERTIFICATE_NOT_AVAILABLE	Certificate is not received from the partner.
0x00000008	8	GSK_ERROR_CERT_VALIDATION	Certificate validation error.
0x00000009	9	GSK_ERROR_CRYPTO	Error processing cryptography.
0x0000000a	10	GSK_ERROR_ASN	Error validating ASN fields in certificate.
0x0000000b	11	GSK_ERROR_LDAP	Error connecting to user registry.
0x0000000c	12	GSK_ERROR_UNKNOWN_ERROR	Internal error. Report this error to IBM Software Support.
0x0000000d	13	GSK_INVALID_PARAMETER	Invalid parameter.
0x0000000e	14	GSK_ERROR_UNEXPECTED_INT_EXCEPTION	Invalid parameter. Report this error to IBM Software Support.
0x00000065	101	GSK_OPEN_CIPHER_ERROR	Internal error. Report this error to IBM Software Support.
0x00000066	102	GSK_KEYFILE_IO_ERROR	I/O error reading the key file.
0x00000067	103	GSK_KEYFILE_INVALID_FORMAT	The key file does not have a valid internal format. Recreate the key file.
0x00000068	104	GSK_KEYFILE_DUPLICATE_KEY	The key file has two entries with the same key.

Return code (hex)	Return code (decimal)	Constant	Explanation
0x00000069	105	GSK_KEYFILE_DUPLICATE_LABEL	The key file has two entries with the same label.
0x0000006a	106	GSK_BAD_FORMAT_OR_INVALID_PASSWORD	The key file password is used as an integrity check. Either the key file is corrupted or the password ID is incorrect.
0x0000006b	107	GSK_KEYFILE_CERT_EXPIRED	The default key in the key file has an expired certificate.
0x0000006c	108	GSK_ERROR_LOAD_GSKLIB	An error occurred loading one of the GSK dynamic link libraries. Check that GSK was installed correctly.
0x0000006d	109	GSK_PENDING_CLOSE_ERROR	Indicates that a connection is trying to be made in a GSK environment after the GSK_ENVIRONMENT_CLOSE_OPTIONS was set to GSK_DELAYED_ENVIRONMENT_CLOSE and gsk_environment_close() function was called.
0x000000c9	201	GSK_NO_KEYFILE_PASSWORD	Both the password and the stash-file name were not specified. The key file is not initialized.
0x000000ca	202	GSK_KEYRING_OPEN_ERROR	Unable to open the key file. Either the path was specified incorrectly or the file permissions did not allow the file to be opened.
0x000000cb	203	GSK_RSA_TEMP_KEY_PAIR	Unable to generate a temporary key pair. Report this error to IBM Software Support.
0x000000cc	204	GSK_ERROR_LDAP_NO_SUCH_OBJECT	A user name object was specified that is not found.
0x000000cd	205	GSK_ERROR_LDAP_INVALID_CREDENTIALS	A password that is used for an LDAP (lightweight directory access protocol) query is not correct.
0x000000ce	206	GSK_ERROR_BAD_INDEX	An index into the Fail Over list of LDAP servers was not correct.
0x000000cf	207	GSK_ERROR_FIPS_NOT_SUPPORTED	This installation of GSKit does not support FIPS mode of operation.
0x0000012d	301	GSK_CLOSE_FAILED	Indicates that the GSK environment close request was not properly managed. Cause is most likely due to a gsk_secure_socket*() command that is attempted after a gsk_close_environment() call.
0x00000191	401	GSK_ERROR_BAD_DATE	The system date was not set to a valid value.
0x00000192	402	GSK_ERROR_NO_CIPHERS	The SSLv2 and the SSLv3 are not enabled.
0x00000193	403	GSK_ERROR_NO_CERTIFICATE	The required certificate was not received from the partner.
0x00000194	404	GSK_ERROR_BAD_CERTIFICATE	The received certificate was formatted incorrectly.
0x00000195	405	GSK_ERROR_UNSUPPORTED_CERTIFICATE_TYPE	The received certificate type was not supported.
0x00000196	406	GSK_ERROR_IO	An I/O error occurred on a data read or write operation.
0x00000197	407	GSK_ERROR_BAD_KEYFILE_LABEL	The specified label in the key file is not found.

Return code (hex)	Return code (decimal)	Constant	Explanation
0x00000198	408	GSK_ERROR_BAD_KEYFILE_PASSWORD	The specified key file password is incorrect. The key file cannot be used. The key file also might be corrupt.
0x00000199	409	GSK_ERROR_BAD_KEY_LEN_FOR_EXPORT	In a restricted cryptography environment, the key size is too long to be supported.
0x0000019a	410	GSK_ERROR_BAD_MESSAGE	An incorrectly formatted SSL message was received from the partner.
0x0000019b	411	GSK_ERROR_BAD_MAC	The message authentication code (MAC) was not successfully verified.
0x0000019c	412	GSK_ERROR_UNSUPPORTED	Unsupported SSL protocol or unsupported certificate type.
0x0000019d	413	GSK_ERROR_BAD_CERT_SIG	The received certificate contained an incorrect signature.
0x0000019e	414	GSK_ERROR_BAD_CERT	Incorrectly formatted certificate is received from the partner.
0x0000019f	415	GSK_ERROR_BAD_PEER	Did not receive a valid SSL protocol from the partner.
0x000001a0	416	GSK_ERROR_PERMISSION_DENIED	Report this error to IBM Software Support.
0x000001a1	417	GSK_ERROR_SELF_SIGNED	The self-signed certificate is not valid.
0x000001a2	418	GSK_ERROR_NO_READ_FUNCTION	The <code>read()</code> failed. Report this error to IBM Software Support.
0x000001a3	419	GSK_ERROR_NO_WRITE_FUNCTION	The <code>write()</code> failed. Report this error to IBM Software Support.
0x000001a4	420	GSK_ERROR_SOCKET_CLOSED	The partner closed the socket before the protocol completed.
0x000001a5	421	GSK_ERROR_BAD_V2_CIPHER	The specified V2 cipher is not valid.
0x000001a6	422	GSK_ERROR_BAD_V3_CIPHER	The specified V3 cipher is not valid.
0x000001a7	423	GSK_ERROR_BAD_SEC_TYPE	Report this error to IBM Software Support.
0x000001a8	424	GSK_ERROR_BAD_SEC_TYPE_COMBINATION	Report this error to IBM Software Support.
0x000001a9	425	GSK_ERROR_HANDLE_CREATION_FAILED	The handle cannot be created. Report this error to IBM Software Support.
0x000001aa	426	GSK_ERROR_INITIALIZATION_FAILED	Initialization failed. Report this internal error to service.
0x000001ab	427	GSK_ERROR_LDAP_NOT_AVAILABLE	Not able to access the specified user registry when a certificate is being validated.
0x000001ac	428	GSK_ERROR_NO_PRIVATE_KEY	The specified key did not contain a private key.
0x000001ad	429	GSK_ERROR_PKCS11_LIBRARY_NOTLOADED	A failed attempt was made to load the specified PKCS11 shared library.
0x000001ae	430	GSK_ERROR_PKCS11_TOKEN_LABELMISMATCH	The PKCS #11 driver failed to find the token that is specified by the caller.
0x000001af	431	GSK_ERROR_PKCS11_TOKEN_NOTPRESENT	A PKCS #11 token is not present in the slot.
0x000001b0	432	GSK_ERROR_PKCS11_TOKEN_BADPASSWORD	The password/pin to access the PKCS #11 token is not valid.
0x000001b1	433	GSK_ERROR_INVALID_V2_HEADER	The SSL header received was not a properly formatted SSLv2 header.

Return code (hex)	Return code (decimal)	Constant	Explanation
0x000001b2	434	GSK_CSP_OPEN_ERROR	Cannot open the hardware-based cryptographic service provider. Either the CSP name is not specified correctly or a failed attempt was made to access the specified CSP certificate store.
0x000001b3	435	GSK_CONFLICTING_ATTRIBUTE_SETTING	Attribute setting conflict between PKCS11, CMS key database, and Microsoft Crypto API.
0x000001b4	436	GSK_UNSUPPORTED_PLATFORM	The requested function is not supported on the platform that the application is running. For example, the Microsoft Crypto API is not supported on platforms other than Windows 2000.
0x000001b6	438	GSK_ERROR_INCORRECT_SESSION_TYPE	Incorrect value is returned from the reset session type callback function. Only GSKit <code>gsk_sever_session</code> , <code>gsk_sever_session_with_cl_auth</code> , or <code>gsk_sever_session_with_cl_auth_crit</code> is allowed.
0x000001f5	501	GSK_INVALID_BUFFER_SIZE	The buffer size is negative or zero.
0x000001f6	502	GSK_WOULD_BLOCK	Used with nonblocking I/O. Refer to the nonblocking section for usage.
0x00000259	601	GSK_ERROR_NOT_SSLV3	SSLv3 is required for <code>reset_cipher()</code> , and the connection uses SSLv2.
0x0000025a	602	GSK_MISC_INVALID_ID	A valid ID was not specified for the <code>gsk_secure_soc_misc()</code> function call.
0x000002bd	701	GSK_ATTRIBUTE_INVALID_ID	The function call does not have a valid ID. This issue might also be caused by specifying an environment handle when a handle for an SSL connection should be used.
0x000002be	702	GSK_ATTRIBUTE_INVALID_LENGTH	The attribute has a negative length, which is not valid.
0x000002bf	703	GSK_ATTRIBUTE_INVALID_ENUMERATION	The enumeration value is not valid for the specified enumeration type.
0x000002c0	704	GSK_ATTRIBUTE_INVALID_SID_CACHE	A parameter list that is not valid for replacing the SID cache routines.
0x000002c1	705	GSK_ATTRIBUTE_INVALID_NUMERIC_VALUE	When a numeric attribute is set, the specified value is not valid for the specific attribute that is being set.
0x000002c2	706	GSK_CONFLICTING_VALIDATION_SETTING	Conflicting parameters were set for additional certificate validation.
0x000002c3	707	GSK_AES_UNSUPPORTED	The AES cryptographic algorithm is not supported.
0x000002c4	708	GSK_PEERID_LENGTH_ERROR	The PEERID does not have the correct length.
0x000002c5	709	GSK_CIPHER_INVALID_WHEN_FIPS_MODE_OFF	The particular cipher is not allowed when FIPS mode of operation is off.
0x000002c6	710	GSK_CIPHER_INVALID_WHEN_FIPS_MODE_ON	No approved FIPS ciphers are selected in FIPS mode of operation.
0x00000641	1601	GSK_TRACE_STARTED	The trace started successfully.
0x00000642	1602	GSK_TRACE_STOPPED	The trace stopped successfully.



Return code (hex)	Return code (decimal)	Constant	Explanation
0x00000643	1603	GSK_TRACE_NOT_STARTED	No trace file was previously started, so it cannot be stopped.
0x00000644	1604	GSK_TRACE_ALREADY_STARTED	Trace file is started, so it cannot be restarted.
0x00000645	1605	GSK_TRACE_OPEN_FAILED	Trace file cannot be opened. The first parameter of <code>gsk_start_trace()</code> must be a valid full path file name.

Table 2. IBM Global Security Kit key management return codes

Return code (hex)	Return code (decimal)	Constant	Explanation
0x00000000	0	GSK_OK	The task completes successfully. This message is issued by every function call that completes successfully.
0x00000001	1	GSK_INVALID_HANDLE	The environment or SSL handle is not valid. The specified handle was not the result of a successful <code>open()</code> function call.
0x00000002	2	GSK_API_NOT_AVAILABLE	The DLL (dynamic link library) was unloaded and is not available (occurs on Microsoft Windows systems only).
0x00000003	3	GSK_INTERNAL_ERROR	Internal error. Report this error to IBM Software Support.
0x00000004	4	GSK_INSUFFICIENT_STORAGE	Insufficient memory is available to complete the operation.
0x00000005	5	GSK_INVALID_STATE	The handle is in an incorrect state for operation, such as completing an <code>init()</code> operation on a handle twice.
0x00000006	6	GSK_KEY_LABEL_NOT_FOUND	Specified key label is not found in key file.
0x00000007	7	GSK_CERTIFICATE_NOT_AVAILABLE	Certificate is not received from the partner.
0x00000008	8	GSK_ERROR_CERT_VALIDATION	Certificate validation error.
0x00000009	9	GSK_ERROR_CRYPTO	Error processing cryptography.
0x0000000a	10	GSK_ERROR_ASN	Error validating ASN fields in certificate.
0x0000000b	11	GSK_ERROR_LDAP	Error connecting to user registry.
0x0000000c	12	GSK_ERROR_UNKNOWN_ERROR	Internal error. Report this error to IBM Software Support.
0x00000065	101	GSK_OPEN_CIPHER_ERROR	Internal error. Report this error to IBM Software Support.
0x00000066	102	GSK_KEYFILE_IO_ERROR	I/O error reading the key file.
0x00000067	103	GSK_KEYFILE_INVALID_FORMAT	The key file has an internal format that is not valid. Recreate key file.
0x00000068	104	GSK_KEYFILE_DUPLICATE_KEY	The key file has two entries with the same key.

Return code (hex)	Return code (decimal)	Constant	Explanation
0x00000069	105	GSK_KEYFILE_DUPLICATE_LABEL	The key file has two entries with the same label.
0x0000006a	106	GSK_BAD_FORMAT_OR_INVALID_PASSWORD	The key file password is used as an integrity check. Either the key file is corrupted or the password ID is incorrect.
0x0000006b	107	GSK_KEYFILE_CERT_EXPIRED	The default key in the key file has an expired certificate.
0x0000006c	108	GSK_ERROR_LOAD_GSKLIB	An error occurred while one of the GSK dynamic link libraries is loaded. Check GSK was installed correctly.
0x0000006d	109	GSK_PENDING_CLOSE_ERROR	This message indicates that a connection is trying to be made in a GSK environment after the GSK_ENVIRONMENT_CLOSE_OPTIONS was set to GSK_DELAYED_ENVIRONMENT_CLOSE and gsk_environment_close() function was called.
0x000000c9	201	GSK_NO_KEYFILE_PASSWORD	Both the password and the stash-file name were not specified, so the key file is not initialized.
0x000000ca	202	GSK_KEYRING_OPEN_ERROR	Unable to open the key file. Either the path was specified incorrectly or the file permissions did not allow the file to be opened.
0x000000cb	203	GSK_RSA_TEMP_KEY_PAIR	Unable to generate a temporary key pair. Report this error to IBM Software Support.
0x000000cc	204	GSK_ERROR_LDAP_NO_SUCH_OBJECT	A user name object was specified that is not found.
0x000000cd	205	GSK_ERROR_LDAP_INVALID_CREDENTIALS	A Password that is used for an LDAP query is not correct.
0x000000ce	206	GSK_ERROR_BAD_INDEX	An index into the Fail Over list of LDAP servers was not correct.
0x000000cf	207	GSK_ERROR_FIPS_NOT_SUPPORTED	This installation of GSKit does not support FIPS mode of operation.
0x0000012d	301	GSK_CLOSE_FAILED	Indicates that the GSK environment close request was not properly managed. Cause is most likely due to attempting a gsk_secure_socket*() command after a gsk_close_environment() call.
0x00000191	401	GSK_ERROR_BAD_DATE	The system date was set to a value that is not valid.
0x00000192	402	GSK_ERROR_NO_CIPHERS	SSLv2 and SSLv3 are not enabled.
0x00000193	403	GSK_ERROR_NO_CERTIFICATE	The required certificate was not received from the partner.

Return code (hex)	Return code (decimal)	Constant	Explanation
0x00000194	404	GSK_ERROR_BAD_CERTIFICATE	The received certificate was formatted incorrectly.
0x00000195	405	GSK_ERROR_UNSUPPORTED_CERTIFICATE_TYPE	The received certificate type was not supported.
0x00000196	406	GSK_ERROR_IO	An I/O error occurred on a data read-or-write operation.
0x00000197	407	GSK_ERROR_BAD_KEYFILE_LABEL	The specified label in the key file is not found.
0x00000198	408	GSK_ERROR_BAD_KEYFILE_PASSWORD	The specified key file password is incorrect. The key file cannot be used. The key file might also be corrupt.
0x00000199	409	GSK_ERROR_BAD_KEY_LEN_FOR_EXPORT	In a restricted cryptography environment, the key size is too long to be supported.
0x0000019a	410	GSK_ERROR_BAD_MESSAGE	An incorrectly formatted SSL message was received from the partner.
0x0000019b	411	GSK_ERROR_BAD_MAC	The MAC was not successfully verified.
0x0000019c	412	GSK_ERROR_UNSUPPORTED	Unsupported SSL protocol or unsupported certificate type.
0x0000019d	413	GSK_ERROR_BAD_CERT_SIG	The received certificate contained an incorrect signature.
0x0000019e	414	GSK_ERROR_BAD_CERT	Incorrectly formatted certificate is received from the partner.
0x0000019f	415	GSK_ERROR_BAD_PEER	An SSL protocol that is not valid is received from the partner.
0x000001a0	416	GSK_ERROR_PERMISSION_DENIED	Report this error to IBM Software Support.
0x000001a1	417	GSK_ERROR_SELF_SIGNED	The self-signed certificate is not valid.
0x000001a2	418	GSK_ERROR_NO_READ_FUNCTION	The read() failed. Report this error to IBM Software Support.
0x000001a3	419	GSK_ERROR_NO_WRITE_FUNCTION	The write() failed. Report this error to IBM Software Support.
0x000001a4	420	GSK_ERROR_SOCKET_CLOSED	The partner closed the socket before the protocol completed.
0x000001a5	421	GSK_ERROR_BAD_V2_CIPHER	The specified V2 cipher is not valid.
0x000001a6	422	GSK_ERROR_BAD_V3_CIPHER	The specified V3 cipher is not valid.
0x000001a7	423	GSK_ERROR_BAD_SEC_TYPE	Report this error to IBM Software Support.
0x000001a8	424	GSK_ERROR_BAD_SEC_TYPE_COMBINATION	Report this error to IBM Software Support.
0x000001a9	425	GSK_ERROR_HANDLE_CREATION_FAILED	The handle is not created. Report this error to IBM Software Support.
0x000001aa	426	GSK_ERROR_INITIALIZATION_FAILED	Initialization failed. Report this internal error to service.

Return code (hex)	Return code (decimal)	Constant	Explanation
0x000001ab	427	GSK_ERROR_LDAP_NOT_AVAILABLE	Unable to access the specified user registry when a certificate is being validated
0x000001ac	428	GSK_ERROR_NO_PRIVATE_KEY	The specified key did not contain a private key.
0x000001ad	429	GSK_ERROR_PKCS11_LIBRARY_NOTLOADED	A failed attempt was made to load the specified PKCS11 shared library.
0x000001ae	430	GSK_ERROR_PKCS11_TOKEN_LABELMISMATCH	The PKCS #11 driver failed to find the token that is specified by the caller.
0x000001af	431	GSK_ERROR_PKCS11_TOKEN_NOTPRESENT	A PKCS #11 token is not present in the slot.
0x000001b0	432	GSK_ERROR_PKCS11_TOKEN_BADPASSWORD	The password/pin to access the PKCS #11 token is incorrect.
0x000001b1	433	GSK_ERROR_INVALID_V2_HEADER	The SSL header received was not a properly formatted SSLv2 header.
0x000001b2	434	GSK_CSP_OPEN_ERROR	Could not open the hardware-based cryptographic service provider (CSP). Either the CSP name is not specified correctly or a failed attempt was made to access the specified CSP certificate store.
0x000001b3	435	GSK_CSP_OPEN_ERROR	Some conflicting attributes for SSL operation were defined.
0x000001b4	436	GSK_CSP_OPEN_ERROR	The Microsoft Crypto API is only supported on Microsoft Windows 2000 with Service Pack 2 applied.
0x000001b5	437	GSK_CSP_OPEN_ERROR	System is running in IPv6 mode without setting a PEERID.
0x000001f5	501	GSK_INVALID_BUFFER_SIZE	The buffer size is negative or zero.
0x000001f6	502	GSK_WOULD_BLOCK	Used with nonblocking I/O. Refer to the nonblocking section for usage.
0x00000259	601	GSK_ERROR_NOT_SSLV3	SSLv3 is required for reset_cipher(), and the connection uses SSLv2.
0x0000025a	602	GSK_MISC_INVALID_ID	An ID that is not valid was specified for the gsk_secure_soc_misc() function call.
0x000002bd	701	GSK_ATTRIBUTE_INVALID_ID	The function call has an ID that is not valid. This issue might also be caused by specifying an environment handle when a handle for an SSL connection should be used.
0x000002be	702	GSK_ATTRIBUTE_INVALID_LENGTH	The attribute has a negative length, which is not valid.
0x000002bf	703	GSK_ATTRIBUTE_INVALID_ENUMERATION	The enumeration value is not valid for the specified enumeration type.

Return code (hex)	Return code (decimal)	Constant	Explanation
0x000002c0	704	GSK_ATTRIBUTE_INVALID_SID_CACHE	A parameter list that is not valid for replacing the SID cache routines.
0x000002c1	705	GSK_ATTRIBUTE_INVALID_NUMERIC_VALUE	When a numeric attribute is set, the specified value is not valid for the specific attribute that is being set.
0x000002c2	706	GSK_CONFLICTING_VALIDATION_SETTING	Conflicting parameters were set for additional certificate validation.
0x000002c3	707	GSK_AES_UNSUPPORTED	The AES cryptographic algorithm is not supported.
0x000002c4	708	GSK_PEERID_LENGTH_ERROR	The PEERID does not have the correct length.
0x000002c5	709	GSK_CIPHER_INVALID_WHEN_FIPS_MODE_OFF	The particular cipher is not allowed when FIPS mode of operation is off.
0x000002c6	710	GSK_CIPHER_INVALID_WHEN_FIPS_MODE_ON	No approved FIPS ciphers are selected in FIPS mode of operation.
0x00000641	1601	GSK_TRACE_STARTED	The trace started successfully.
0x00000642	1602	GSK_TRACE_STOPPED	The trace stopped successfully.
0x00000643	1603	GSK_TRACE_NOT_STARTED	No trace file was previously started so it cannot be stopped.
0x00000644	1604	GSK_TRACE_ALREADY_STARTED	Trace file is started so it cannot be started again.
0x00000645	1605	GSK_TRACE_OPEN_FAILED	Trace file cannot be opened. The first parameter of <code>gsk_start_trace()</code> must be a valid, full-path file name.

## Glosariusz

Ten glosariusz zawiera terminy i definicje dla produktu IBM Spectrum Protect, IBM Spectrum Protect Snapshot oraz powiązanych produktów.

W tym glosariuszu używane są następujące odsyłacze:

- *Patrz* odsyła z niepreferowanego do preferowanego terminu lub ze skrótu do pełnej formy terminu.
- *Patrz także* odsyła do terminu pokrewnego lub przeciwnego.

Inne terminy i definicje są dostępne w serwisie IBM® Terminology.

ABCDEFGHIJKLMNOPQRSTUVWXYZ

### A

ACK

Patrz potwierdzenie.

ACL

Patrz lista kontroli dostępu.

adaptacyjne tworzenie kopii zapasowej fragmentu pliku

Typ operacji tworzenia kopii zapasowej, w którym do serwera przesyłane są tylko te fragmenty pliku, które uległy zmianie; nie jest przesyłany cały plik. Adaptacyjne tworzenie kopii zapasowej fragmentu pliku zmniejsza ruch w sieci i zwiększa szybkość operacji tworzenia kopii zapasowej.

administrator

Osoba odpowiedzialna za zadania administracyjne, takie jak autoryzacja dostępu i zarządzanie treścią. Administratorzy mogą także nadawać użytkownikom uprawnienia różnego poziomu.

adres IP

Unikalny adres urządzenia lub jednostki logicznej w sieci zgodny ze standardem IP (Internet Protocol).

agent LVSA (Logical Volume Snapshot Agent)

Oprogramowanie pełniące rolę dostawcy obrazu stanu w celu utworzenia obrazu stanu woluminu logicznego podczas tworzenia kopii zapasowej obrazu stanu podczas pracy.

agent pamięci masowej

Program umożliwiający bezpośrednio tworzenie kopii zapasowej danych klienta i ich odtwarzanie w pamięci masowej podłączonej do sieci SAN.

agregat

Obiekt zapisany w jednej lub większej liczbie pul pamięci masowej składający się z grupy plików logicznych wspólnie pogrupowanych. Patrz także plik logiczny, plik fizyczny.

akceptor klienta

Usługa udostępniająca przeglądarkom WWW aplet Java™ klienta WWW. W systemach Windows akceptor klienta jest instalowany i uruchamiany jako usługa. W systemach AIX, UNIX i Linux akceptor klienta jest uruchamiany jako demon.

aktywny system plików

System plików, do którego dodano zarządzanie pamięcią masową. Gdy obsługiwane jest zarządzanie pamięcią masową, zadania dla aktywnego systemu plików obejmują: migrację automatyczną, uzgadnianie, migrację wybiórczą i przywracanie. Patrz także nieaktywny system plików.

aktywny zestaw strategii

Aktywowany zestaw strategii zawierający reguły strategii obecnie używane przez wszystkie węzły klienckie przypisane do domeny strategii. Patrz także domena strategii, zestaw strategii.

aktywować

Sprawdzić zawartość zestawu strategii, a następnie ustawić ten zestaw strategii jako aktywny.

algorytm Nagle'a

Algorytm zmniejszający przeciążenie w sieciach TCP/IP przez łączenie mniejszych pakietów i wysyłanie ich razem.

aplikacyjny interfejs programistyczny zarządzania pamięcią masową danych (DSMAPI)

Zestaw funkcji i semantyka służąca do monitorowania zdarzeń dotyczących plików, zarządzania danymi w plikach i konserwacji tych danych. W środowisku programu interfejs DSMAPI używa zdarzeń do powiadamiania aplikacji zarządzających danymi o operacjach wykonywanych na plikach, przechowuje dowolne atrybuty dotyczące plików, obsługuje obszary zarządzane w plikach, a także steruje dostępem do obiektu pliku za pomocą uprawnień dostępu DSMAPI.

archiwizować

Kopiować programy, dane lub pliki na inny nośnik pamięci masowej zwykle w celu długoterminowego przechowywania lub ze względów bezpieczeństwa. Patrz także pobieranie.

atribut rozszerzony (extended attribute - EA)

Nazwy lub pary wartości powiązane z plikami lub katalogami. Istnieją trzy klasy atrybutów rozszerzonych: atrybuty użytkownika, atrybuty systemowe i atrybuty zaufane.

AutoFS

Patrz system plików podłączany automatycznie.

automatyczne wykrywanie

Funkcja wykrywająca, raportująca i aktualizująca numer seryjny dysku lub biblioteki w bazie danych, gdy definiowana jest ścieżka z serwera lokalnego.

autoryzowany użytkownik

Użytkownik posiadający uprawnienia administratora klienta na stacji roboczej. Ten użytkownik zmienia hasła, dokonuje rejestracji otwartych i usuwa obszary plików.

## B

---

baza danych plików wstępnie zmigrowanych

Baza danych zawierająca informacje o wszystkich plikach wstępnie zmigrowanych do pamięci masowej serwera.

biblioteka

1. Repozytorium dla nośników odłączalnych, takich jak dyski magnetyczne i taśmy magnetyczne.
2. Kolekcja zawierająca co najmniej jeden napęd i być może urządzenia automatyzujące (w zależności od typu biblioteki), która umożliwia dostęp do woluminów pamięci masowej.

biblioteka taśm

Zestaw urządzeń i narzędzi do obsługi środowiska taśm dla danej instalacji. Biblioteka taśm może zawierać stelaże przemysłowe dla taśmowej pamięci masowej, mechanizmy do automatycznego podłączania taśm, zestaw napędów taśm i zestaw powiązanych woluminów taśm podłączonych do tych napędów.

biblioteka współużytkowana

Urządzenie biblioteki używane przez wiele serwerów menedżerów pamięci masowej.

biblioteka zewnętrzna

Kolekcja napędów, które są zarządzane przez system zarządzania nośnikami inny niż serwer zarządzania pamięcią masową.

bieżąca kopia zapasowa

Pełna kopia zapasowa, w której pliki dzienników transakcji nie są usuwane, aby procedury tworzenia kopii zapasowych używające przyrostowych lub różnicowych kopii zapasowych nie zostały zakłócone.

buforować

Umieszczać zduplikowaną kopię pliku na nośniku o dostępie bezpośrednim, gdy serwer migruje ten plik do innej puli pamięci masowej w hierarchii.

## C

---

CAD

Patrz demon akceptora klienta.

centralny program planujący

Funkcja umożliwiająca administratorowi zaplanowanie operacji klienta i komend administracyjnych. Operacje można zaplanować w taki sposób, aby były wykonywane okresowo lub w określonej dacie. Patrz także harmonogram komendy administracyjnej, harmonogram klienta.

centrum przetwarzania danych

W środowisku zwirtualizowanym jest to kontener, który przechowuje hosty, klastry, sieci i składnice danych.

czas dostępu do pliku

W systemach AIX, UNIX i Linux: czas uzyskania ostatniego dostępu do pliku.

czas przechowywania

Mierzony w dniach czas, przez jaki kopie zapasowe i archiwalne plików są przechowywane w puli pamięci masowej, zanim zostaną usunięte. Czas przechowywania jest wyznaczany przez atrybuty grupy kopii i domyślne okresy karencji dla domeny.

częstotliwość

Atrybut grupy kopii określający minimalny odstęp czasu między tworzeniem przyrostowych kopii zapasowych (w dniach).

## D

---

dane wiodące

Bajty danych z początkowej części zmigrowanego pliku, które są zapisane w pliku pośredniczącym odpowiadającym danemu plikowi w lokalnym systemie plików. Ilość danych wiodących zapisanych w pliku pośredniczącym zależy od określonej wielkości pliku pośredniczącego.

deduplikacja

Patrz także deduplikacja danych.

deduplikacja danych

Metoda zmniejszania ilości potrzebnej pamięci masowej przez eliminowanie nadmiarowych danych. Na nośniku pamięci masowej przechowywana jest tylko jedna instancja danych. Pozostałe instancje tych samych danych są zastępowane wskaźnikami do przechowywanej instancji. Patrz także deduplikacja podczas wstawiania, deduplikacja danych z przetwarzaniem końcowym.

deduplikacja danych z przetwarzaniem końcowym

Metoda zmniejszania ilości potrzebnej pamięci masowej przez eliminowanie nadmiarowych danych. Dane są najpierw zapisywane w puli pamięci masowej, następnie są identyfikowane zduplikowane dane, na koniec odzyskiwany jest wolny obszar w puli pamięci masowej. Patrz także deduplikacja danych, deduplikacja podczas wstawiania.

deduplikacja podczas wstawiania

Metoda zmniejszania ilości potrzebnej pamięci masowej przez eliminowanie nadmiarowych danych. Dane są deduplikowane w momencie zapisywania w kontenerze puli pamięci masowej. Patrz także deduplikacja danych, deduplikacja danych z przetwarzaniem końcowym.

demon

Program nienadzorowany, który w sposób nieprzerwany lub okresowy wykonuje funkcje, takie jak kontrola sieci.

demon akceptora klienta (CAD)

Patrz akceptor klienta.

demon kronikowania

W systemach AIX, UNIX lub Linux: program śledzący zmiany w plikach znajdujących się w systemach plików.

demon monitorowania pamięci masowej

Demon, który sprawdza użycie miejsca we wszystkich systemach plików, dla których aktywna jest funkcja zarządzania pamięcią masową, i automatycznie uruchamia proces migracji progowej, jeśli stopień użycia miejsca w systemie plików osiąga lub przekracza próg górny.

domena

Grupa węzłów klienckich z co najmniej jednym zestawem strategii, która zarządza danymi lub zasobami pamięci masowej dla węzłów klienckich. Patrz także domena strategii.

domena klienta

Zestaw dysków, systemów plików lub woluminów wybranych przez użytkownika w celu utworzenia kopii zapasowej lub archiwalnej danych za pomocą klienta kopii zapasowych i archiwalnych.

domena strategii

Grupa użytkowników strategii z jednym lub większą liczbą zestawów strategii, która zarządza danymi lub zasobami pamięci masowej dla tych użytkowników. Użytkownikami są węzły klienckie powiązane z daną domeną strategii. Patrz także aktywny zestaw strategii, domena.

domyślna klasa zarządzania

Klasa zarządzania przypisana do zestawu strategii. Klasa ta jest wykorzystywana do zarządzania plikami kopii zapasowych lub plikami archiwum, gdy pliki te nie są jawnie powiązane z konkretną klasą zarządzania za pomocą listy włączyń/wykluczeń.

DRM

Patrz menedżer odtwarzania po awarii.

DSMAPI

Patrz aplikacyjny interfejs programistyczny zarządzania pamięcią masową danych.

dziennik aktywności

Dziennik, w którym rejestrowane są zwykłe komunikaty dotyczące aktywności generowane przez serwer. Komunikaty te zawierają informacje o operacjach serwera i klientów, takie jak czas uruchamiania sesji i błędy we/wy urządzeń.

dziennik błędów

Zestaw danych lub plik używany do rejestrowania informacji o błędach w produkcie lub systemie.

dziennik odtwarzania

Dziennik aktualizacji, które mają zostać zapisane w bazie danych. Za pomocą tego dziennika można przywrócić działanie systemu po awarii systemu lub nośników. Dziennik odtwarzania składa się z dziennika aktywnego (w tym kopii lustrzanej dziennika) i dzienników archiwalnych.

## E

---

EA

Patrz atrybut rozszerzony.

EB

Patrz eksabajt.

EFS

Patrz szyfrowany system plików.

eksabajt (EB)

W kontekście procesora, rzeczywistej i wirtualnej pamięci masowej, a także ilości danych w kanale: dwa do potęgi 60 lub 1 152 921 504 606 846 976 bajtów. W kontekście dyskowej pamięci masowej i ilości przesyłanych danych: 1 000 000 000 000 000 000 bajtów.

## F

---

fizyczny poziom zajętości

Ilość miejsca zajmowanego przez pliki fizyczne w puli pamięci masowej. Miejsce to uwzględnia miejsce niewykorzystane, które powstało po usunięciu plików logicznych z agregatów. Patrz także plik logiczny, logiczny poziom zajętości, plik fizyczny.

format rodzimy

Format danych zapisywanych w puli pamięci masowej bezpośrednio przez serwer. Patrz także nierodzimny format danych.

FSID

Patrz identyfikator obszaru plików.

FSM

Patrz migrator systemu plików.

## G

---

GB

Patrz gigabajt.

General Parallel File System (GPFS)

Wysokowydajny system plików ze współużytkowanymi dyskami, który umożliwia dostęp do danych z węzłów w środowisku klastrowym. Patrz także zarządzanie cyklem życia informacji.

generowanie hasła

Proces tworzący i zapisujący nowe hasło w zaszyfrowanym pliku haseł, gdy stare hasło utraci ważność. Automatyczne generowanie hasła eliminuje konieczność wyświetlania monitu o wprowadzenie hasła.

gigabajt (GB)



(2) W kontekście pamięci procesora, rzeczywistej i wirtualnej pamięci masowej, a także ilości danych w kanale: dwa do potęgi 30 lub 1 073 741 824 bajty. W kontekście dyskowej pamięci masowej i ilości przesyłanych danych: 1 000 000 000 bajtów.

#### GPFS

Patrz General Parallel File System.

#### grupa kolokacji

Zdefiniowana przez użytkownika grupa węzłów klienckich, których dane są zapisane na minimalnej liczbie woluminów dzięki procesowi kolokacji.

#### grupa kopii

Obiekt strategii zawierający atrybuty sterujące sposobem generowania wersji kopii zapasowych lub kopii archiwalnych, miejscem, w którym wersje kopii zapasowych lub kopie archiwalne są początkowo umieszczane, a także momentem utraty ważności przez wersje kopii zapasowych lub kopie archiwalne. Grupa kopii należy do klasy zarządzania. Patrz także grupa kopii archiwalnych, grupa kopii zapasowych, wersja kopii zapasowej, klasa zarządzania.

#### grupa kopii archiwalnych

Obiekt strategii zawierający atrybuty sterujące generowaniem plików archiwum, ich miejscem docelowym i utratą ważności przez te pliki. Patrz także grupa kopii.

#### grupa kopii zapasowych

Obiekt strategii zawierający atrybuty sterujące generowaniem wersji kopii zapasowych plików, ich miejscem docelowym i utratą ważności przez te pliki. Grupa kopii zapasowych należy do klasy zarządzania. Patrz także grupa kopii.

#### GUID

Patrz unikalny identyfikator globalny.

## H

---

#### harmonogram

Rekord bazy danych opisujący operacje klienta lub komendy administracyjne, które mają być przetworzone. Patrz także harmonogram komendy administracyjnej, harmonogram klienta.

#### harmonogram klienta

Rekord bazy danych opisujący planowane przetwarzanie operacji klienta w określonym czasie. Do operacji klienta należą: tworzenie kopii zapasowych i archiwalnych, odtwarzanie, pobieranie, wykonywanie komendy systemu operacyjnego klienta lub makra. Patrz także harmonogram komendy administracyjnej, centralny program planujący, harmonogram.

#### harmonogram komendy administracyjnej

Rekord bazy danych opisujący planowane przetwarzanie komendy administracyjnej w określonym czasie. Patrz także centralny program planujący, harmonogram klienta, harmonogram.

#### hierarchia pamięci masowej

Zdefiniowany przez administratora logiczny porządek podstawowych pul pamięci masowej. Porządek ten jest zwykle oparty na szybkości i pojemności urządzeń, których używają poszczególne pule pamięci. Hierarchia pamięci masowej jest zdefiniowana przez określenie następczej puli pamięci masowej w definicji puli pamięci masowej. Patrz także pula pamięci masowej.

#### hierarchiczne zarządzanie pamięcią masową (HSM)

Funkcja, która automatycznie dystrybuje dane i zarządza nimi na dyskach, taśmach lub dyskach i taśmach, traktując urządzenia o tych i potencjalnie innych typach jako poziomy w hierarchii pamięci masowej, które występują w segmentach od urządzeń szybkich i drogiej do urządzeń wolniejszych, tańszych i prawdopodobnie wymiennych. Głównym celem jest minimalizacja czasu dostępu do danych i maksymalizacja dostępnej pojemności. Patrz także klient hierarchicznego zarządzania pamięcią masową, przywracanie, hierarchia pamięci masowej.

#### HSM

Patrz hierarchiczne zarządzanie pamięcią masową.

## I

---

#### i-węzeł

Wewnętrzna struktura opisująca pojedyncze pliki w systemach AIX, UNIX i Linux. I-węzeł zawiera węzeł, typ, właściciela i położenie pliku.

#### identyfikator obszaru plików (file space ID - FSID)

Unikalny identyfikator liczbowy, jaki serwer przypisuje do obszaru plików, gdy jest on zapisywany w pamięci masowej serwera.

#### ILM

Patrz zarządzanie cyklem życia informacji.

## K

---

kB

Patrz kilobajt.

kilobajt (kB)

W kontekście pamięci procesora, rzeczywistej i wirtualnej pamięci masowej, a także ilości danych w kanale: dwa do potęgi 10 lub 1 024 bajty. W kontekście dyskowej pamięci masowej i ilości przesyłanych danych: 1 000 bajtów.

klasa uprawnień

Poziom uprawnień nadanych administratorowi. Klasa uprawnień określa czynności administracyjne, które administrator może wykonywać. Patrz także uprawnienie, klasa uprawnień węzła, klasa uprawnień operatora, klasa uprawnień strategii, klasa uprawnień pamięci masowej, klasa uprawnień systemowych.

klasa uprawnień administracyjnych

Patrz klasa uprawnień.

klasa uprawnień operatora

Klasa uprawnień pozwalająca administratorowi na wyłączenie lub zatrzymanie serwera, włączenie serwera, anulowanie procesów serwera i zarządzanie nośnikami wymiennymi. Patrz także klasa uprawnień.

klasa uprawnień pamięci masowej

Klasa uprawnień dająca administratorowi uprawnienia do sterowania sposobem przydzielania i używania zasobów pamięci serwera, np. monitorowania bazy danych, dziennika aktywności i pamięci masowej serwera. Patrz także klasa uprawnień.

klasa uprawnień strategii

Klasa uprawnień zezwalająca administratorowi na zarządzanie obiektami strategii, rejestrowanie węzłów klienckich i planowanie operacji klientów dla węzłów klienckich. Uprawnienia te mogą być ograniczone do określonych domen strategii. Patrz także klasa uprawnień.

klasa uprawnień systemowych

Klasa uprawnień dająca administratorowi uprawnienia do wykonywania wszystkich komend serwera. Patrz także klasa uprawnień.

klasa uprawnień węzła

Klasa uprawnień dająca administratorowi uprawnienia do zdalnego dostępu do klientów kopii zapasowych i archiwalnych dla określonego węzła klienckiego lub dla wszystkich klientów w domenie strategii. Patrz także klasa uprawnień.

klasa urządzeń

Nazwany zestaw parametrów stosowanych do grupy urządzeń pamięci masowej. Każda klasa urządzeń ma unikalną nazwę i reprezentuje urządzenie takie jak dysk, plik, dysk optyczny lub taśma.

klasa zarządzania

Obiekt strategii, który użytkownicy mogą powiązać z każdym plikiem w celu określenia sposobu używanego przez serwer do zarządzania plikiem. Klasa zarządzania może zawierać grupę kopii zapasowych, grupę kopii archiwalnych i atrybuty zarządzania pamięcią masową. Patrz także powiązać, grupa kopii, klient hierarchicznego zarządzania pamięcią masową, zestaw strategii, ponowne wiązanie.

klient

Program lub komputer żądający usług z serwera. Patrz także serwer.

klient administracyjny

Program działający na serwerze plików, stacji roboczej lub komputerze mainframe używany przez administratorów do sterowania serwerem i jego monitorowania. Patrz także klient kopii zapasowych i archiwalnych.

klient aplikacji

Program zainstalowany w systemie w celu zabezpieczenia aplikacji. Serwer udostępnia usługi tworzenia kopii zapasowej klientowi aplikacji.

klient biblioteki

Serwer używający komunikacji serwer-serwer do uzyskania dostępu do biblioteki zarządzanej przez inny serwer zarządzania pamięci masowej. Patrz także menedżer biblioteki.

klient hierarchicznego zarządzania pamięcią masową (klient HSM)

Program kliencki działający razem z serwerem w celu udostępnienia systemowi hierarchicznego zarządzania pamięcią masową (HSM). Patrz także hierarchiczne zarządzanie pamięcią masową, klasa zarządzania.

klient HSM

Patrz klient hierarchicznego zarządzania pamięcią masową.

klient kopii zapasowych i archiwalnych

Program działający na stacji roboczej lub na serwerze plików udostępniający użytkownikom narzędzia do tworzenia kopii zapasowych plików, archiwizowania i odtwarzania plików, a także ich pobierania. Patrz także klient administracyjny.

klient/serwer

Termin odnoszący się do modelu interakcji w przetwarzaniu danych rozproszonych, w którym program znajdujący się na jednym komputerze wysyła żądania do programu znajdującego się na innym komputerze i czeka na odpowiedź. Program żądający jest zwany klientem, a program odpowiadający jest zwany serwerem.

kod pośredniczący

Skrót w systemie plików Windows generowany przez klienta HSM dla zmigrowanego pliku umożliwiający użytkownikom przezroczysty dostęp do plików. Kod pośredniczący jest reprezentacją zmigrowanego pliku w postaci pliku rzadkiego z przyłączonym punktem ponownej analizy.

#### kolekcja zestawów kopii zapasowych

Grupa zestawów kopii zapasowych tworzonych w tym samym czasie i mających te same nazwy zestawów kopii zapasowych, nazwy woluminów, opisy i klasy urządzeń. Serwer identyfikuje każdy zestaw kopii zapasowych za pomocą nazwy węzła, nazwy zestawu kopii zapasowych i typu pliku.

#### kolokacja

Proces utrzymywania wszystkich danych należących do obszaru plików jednego klienta, jednego węzła klienckiego lub grupy węzłów klienckich na minimalnej liczbie woluminów o dostępie sekwencyjnym w puli pamięci masowej. Kolokacja może zmniejszyć liczbę woluminów, do których trzeba uzyskać dostęp, gdy konieczne jest odtworzenie ogromnej ilości danych.

#### kompresja

Funkcja usuwająca powtarzające się znaki, spacje lub tańcuchy znaków albo dane binarne z przetwarzanych danych i zastępująca je znakami sterującymi. Kompresja zmniejsza ilość pamięci masowej wymaganej do przechowywania danych. Patrz także kompresja podczas wstawiania.

#### kompresja podczas wstawiania

Metoda redukowania zajmowanego miejsca. Powtarzające się znaki, spacje, tańcuchy znaków lub dane binarne są usuwane w momencie zapisywania danych do puli pamięci masowej kontenera. Patrz także kompresja.

#### konfiguracja korporacyjna

Metoda konfigurowania serwerów, aby administrator mógł dystrybuować konfigurację jednego z serwerów na inne serwery za pomocą komunikacji typu serwer-serwer. Patrz także menedżer konfiguracji, serwer zarządzany, profil, subskrypcja.

#### kontener

Położenie pamięci masowej danych, na przykład plik, katalog lub urządzenie. Patrz także pula pamięci masowej kontenera.

#### kontrolować

Sprawdzać logiczne niespójności między informacjami posiadanymi przez serwer a rzeczywistym stanem systemu. Menedżer pamięci masowej może kontrolować informacje dotyczące takich elementów jak woluminy, biblioteki i licencje. Na przykład, gdy menedżer pamięci masowej kontroluje wolumin, serwer wyszukuje niespójności między informacjami o plikach, dla których utworzono kopie zapasowe lub archiwalne, zapisanymi w bazie danych a rzeczywistymi danymi powiązanymi z każdą kopią zapasową lub archiwalną w pamięci masowej serwera.

#### konwersacja

Połączenie między dwoma programami zrealizowane za pomocą sesji, które umożliwia im wzajemną komunikację podczas przetwarzania transakcji.

#### kopia archiwalna

Plik lub grupa plików zarchiwizowanych w pamięci masowej serwera.

#### kopia rozmyta

Wersja kopii zapasowej lub kopii archiwalnej pliku, która może nie odzwierciedlać dokładnie oryginalnej zawartości tego pliku, ponieważ kopia zapasowa lub archiwalna tego pliku została utworzona w czasie jego modyfikacji.

#### kopia zapasowa grupy

Tworzenie kopii zapasowej grupy zawierającej listę plików pochodzących z co najmniej jednego źródłowego obszaru plików.

#### kopia zapasowa obrazu stanu

Kopia zapasowa pełnego systemu plików lub surowego woluminu logicznego jako pojedynczego obiektu.

#### kopia zapasowa woluminu logicznego

Kopia zapasowa systemu plików lub woluminu logicznego w postaci pojedynczego obiektu.

#### kopiowanie w tle

Obraz stanu woluminu. Obraz stanu może być tworzony również wtedy, gdy aplikacje w systemie zapisują dane w woluminie.

## L

#### LAN

Patrz sieć lokalna.

#### limit

1. Dla programu HSM w systemach AIX, UNIX i Linux: wyrażony w megabajtach limit ilości danych, które mogą zostać zmigrowane i zmigrowane wstępnie z systemu plików do pamięci masowej serwera.
2. Dla programu HSM w systemach Windows: zdefiniowany przez użytkownika limit miejsca zajmowanego przez przywrócone pliki.

#### limit czasu

Przydzielony odstęp czasu, w którym zdarzenie ma wystąpić lub zostać zakończone przed przerwaniem operacji.

#### limit połączeń

Maksymalna liczba woluminów, jakie mogą być równocześnie dostępne w danej klasie urządzeń. Limit połączeń określa maksymalną liczbę punktów połączenia. Patrz także punkt połączenia.

#### lista dołączeń i wykluczeń

Lista opcji, które włączają lub wykluczają wybrane pliki z operacji tworzenia kopii zapasowej. Opcja wykluczania (exclude) określa pliki, dla których kopia zapasowa nie będzie tworzona. Opcja włączania (include) określa pliki stanowiące wyjątek od reguł wykluczania lub przypisuje klasę zarządzania do pliku albo grupy plików dla usług tworzenia kopii zapasowych lub archiwalnych. Patrz także plik włączeń/wykluczeń.

lista kontroli dostępu (ACL)

W zagadnieniach związanych z bezpieczeństwem komputerów: lista powiązana z obiektem, która określa wszystkie podmioty mające dostęp do obiektu i prawa dostępu.

lista wykluczeń/włączeń

Patrz lista dołączeń i wykluczeń.

LOFS

Patrz wirtualny system plików LOFS.

logiczny poziom zajętości

Miejsce zajmowane przez pliki logiczne w puli pamięci masowej. Miejsce to nie uwzględnia wolnego miejsca powstałego wskutek usunięcia plików logicznych z plików agregatów i dlatego może być go mniej niż w przypadku fizycznego poziomu zajętości. Patrz także fizyczny poziom zajętości.

lokalne

1. Termin odnoszący się do urządzenia, pliku lub systemu, do którego dostęp jest uzyskiwany bezpośrednio z systemu użytkownika bez użycia linii komunikacyjnej.
2. W produktach HSM: termin odnoszący się do miejsca docelowego migrowanych plików, które są przenoszone. Patrz także zdalne.

lokalny wolumin w tle

Dane zapisane w woluminach w tle znajdujących się w dyskowym podsystemie pamięci masowej.

LUN

Patrz numer jednostki logicznej.

LVSA

Patrz agent LVSA.

## M

macierzysty system plików

System plików, z którego dany plik został zmigrowany. Kiedy plik jest przywracany, jest on umieszczany z powrotem w macierzystym systemie plików.

maksymalna jednostka transmisji (MTU)

Największy możliwy blok danych, który może być wysłany za pomocą danego nośnika fizycznego w jednej ramce. Na przykład maksymalną jednostką transmisji dla sieci Ethernet jest 1500 bajtów.

MB

Patrz megabajt.

megabajt (MB)

W kontekście pamięci procesora, rzeczywistej i wirtualnej pamięci masowej, a także ilości danych w kanale: dwa do potęgi 20 lub 1 048 576 bajtów. W kontekście dyskowej pamięci masowej i ilości przesyłanych danych: 1 000 000 bajtów.

menedżer biblioteki

Serwer sterujący operacjami urządzenia, gdy wiele serwerów zarządzania pamięcią masową współużytkuje urządzenie pamięci masowej. Patrz także klient biblioteki.

menedżer konfiguracji

Serwer dystrybuujący informacje konfiguracyjne, takie jak strategie i harmonogramy, do serwerów zarządzanych zgodnie z ich profilami. Informacje konfiguracyjne mogą obejmować strategie i harmonogramy. Patrz także konfiguracja korporacyjna, serwer zarządzany, profil.

menedżer odtwarzania po awarii (DRM)

Funkcja pomagająca w przygotowaniu i użyciu planu odtwarzania po awarii dla serwera.

metadane

Dane opisujące charakterystykę danych; dane opisowe.

metoda komunikacji

Metoda, za pomocą której klient i serwer wymieniają informacje. Patrz także protokół TCP/IP (Transmission Control Protocol/Internet Protocol).

miejsce docelowe

Atrybut grupy kopii lub klasy zarządzania określający podstawową pulę pamięci masowej, w której zostanie utworzona kopia zapasowa lub archiwalna pliku klienta lub do której zostanie on zmigrowany. Patrz także pula pamięci masowej kopii.

migracja

Proces przenoszenia danych z jednego miejsca w inne lub aplikacji z jednego systemu komputerowego do drugiego.

migracja

Proces przenoszenia danych lub aplikacji z jednego systemu komputerowego do drugiego.

migracja automatyczna  
Proces używany do automatycznego przenoszenia plików z lokalnego systemu plików lub pamięci podręcznej z uwzględnieniem opcji i ustawień wybranych przez administratora na stacji roboczej. Patrz także migracja na żądanie, migracja progowa.

migracja na żądanie  
Proces używany do reagowania na sytuację braku miejsca w systemie plików, dla którego aktywne jest hierarchiczne zarządzanie pamięcią masową (HSM). Pliki są migrowane do serwera pamięci masowej do momentu, gdy użycie miejsca spadnie do dolnego progu ustawionego dla systemu plików. Jeśli progi górny i dolny są takie same, migrowany jest jeden plik. Patrz także migracja automatyczna, migracja wybiórcza, migracja progowa.

migracja progowa  
Proces przenoszenia plików z lokalnego systemu plików do pamięci masowej serwera z uwzględnieniem wartości progów górnego i dolnego zdefiniowanych dla systemu plików. Patrz także migracja automatyczna, migracja na żądanie, zadanie migracji, migracja wybiórcza.

migracja wstępna  
Proces kopiowania plików zakwalifikowanych do migracji do pamięci masowej serwera, w którym oryginalne pliki są pozostawiane w lokalnym systemie plików w stanie niezmienionym.

migracja wybiórcza  
Proces kopiowania plików wybranych przez użytkownika z lokalnego systemu plików do pamięci masowej serwera i zastępowania ich plikami pośredniczącymi w lokalnym systemie plików. Patrz także migracja na żądanie, migracja progowa.

migrator systemu plików (file system migrator - FSM)  
Rozszerzenie jądra przechwytyjące wszystkie operacje systemu plików i udostępniające wszelką wymaganą obsługę zarządzania pamięcią masową. Jeśli nie jest wymagana żadna obsługa zarządzania pamięcią masową, operacja jest przekazywana do systemu operacyjnego, który wykonuje zwykłe funkcje. Migrator systemu plików jest podłączany przez system plików, gdy do tego systemu plików dodawane jest zarządzanie pamięcią masową.

migrowany plik  
Plik, który został skopiowany z lokalnego systemu plików do pamięci masowej. W przypadku klientów HSM w systemach UNIX lub Linux ten plik jest zastępowany plikiem pośredniczącym w lokalnym systemie plików. W systemach Windows utworzenie pliku pośredniczącego jest opcjonalne. Patrz także stan pliku, plik wstępnie zmigrowany, plik rezydentny, plik pośredniczący.

moment zatwierdzenia  
Zadany moment, gdy dane uważa się za spójne.

MTU  
Patrz maksymalna jednostka transmisji.

## N

---

narzędzie przenoszenia danych  
Narzędzie przenoszące dane w imieniu serwera. Narzędziem przenoszenia danych jest serwer plików pamięci masowej NAS.

natychmiastowe odtwarzanie VSS  
Operacja, która odtwarza dane z lokalnego obrazu stanu. Obraz stanu jest kopią zapasową VSS, która znajduje się w lokalnym woluminie w tle. Operacja odtwarzania pobiera dane za pomocą metody odtwarzania wspieranej sprzętowo (na przykład FlashCopy).

nazwa węzła  
Unikalna nazwa identyfikująca stację roboczą, serwer plików lub komputer PC na serwerze.

nazwa WWN  
64-bitowy unikalny identyfikator nazwy (bez znaku).

NDMP  
Patrz Network Data Management Protocol.

NetBIOS (Network Basic Input/Output System)  
Standardowy interfejs sieci i komputerów osobistych używany w sieciach lokalnych do udostępniania funkcji obsługi komunikatów, serwera wydruków i serwera plików. Aplikacje używające interfejsu NetBIOS nie muszą obsługiwać szczegółów protokołów sterowania łączem danych (DLC) w sieci LAN.

Network Basic Input/Output System  
Patrz NetBIOS.

Network Data Management Protocol (NDMP)  
Protokół umożliwiający aplikacjom zarządzania pamięcią masową sterowanie operacjami tworzenia i odtwarzania kopii zapasowych serwera plików obsługującego protokół NDMP bez instalowania oprogramowania uzyskanego u dostawcy na tym serwerze plików.

nieaktywny system plików  
System plików, w którym dezaktywowano zarządzanie pamięcią masową. Patrz także aktywny system plików.

nieobciążające żądanie kopii zapasowej VSS

Operacja tworzenia kopii zapasowej używająca dostawcy sprzętu Usługi kopiowania woluminów w tle (VSS) firmy Microsoft (zainstalowanego w systemie alternatywnym) do przeniesienia danych na serwer. Ten typ operacji tworzenia kopii zapasowej przenosi obciążenie związane z operacją tworzenia kopii zapasowej z systemu produkcyjnego do innego systemu.

nierodzimiy format danych

Format danych zapisywanych w puli pamięci masowej inny niż format, którego serwer używa podczas wykonywania operacji. Patrz także format rodzimy.

numer i-węzła

Numer określający konkretny plik i-węzła w systemie plików.

numer jednostki logicznej (LUN)

W standardzie Small Computer System Interface (SCSI): unikalny identyfikator używany do odróżniania urządzeń, z których każde jest jednostką logiczną (LU).

## O

---

obiekt reliktowy

Niewielki podzbiór atrybutów usuniętego obiektu. Obiekt reliktowy jest przechowywany przez określony czas i na koniec podanego okresu obiekt ten jest trwale usuwany.

obiekt zarządzany

Definicja w bazie danych serwera zarządzanego, która została rozdystrybuowana na ten serwer zarządzany przez menedżera konfiguracji. Gdy serwer zarządzany zasubskrybuje profil, wszystkie obiekty powiązane z tym profilem staną się obiektami zarządzanymi w bazie danych serwera zarządzanego.

obraz

System plików lub surowy wolumin logiczny traktowany jako jeden obiekt, dla którego tworzona jest kopia zapasowa.

obraz stanu

Kopia zapasowa obrazu stanu zawierająca widok woluminu w zadanym momencie.

obraz stanu bazy danych

Pełna kopia zapasowa całej bazy danych na nośniku, który można przenieść fizycznie. Gdy tworzony jest obraz stanu bazy danych, nie jest przerywana bieżąca seria kopii zapasowych bazy danych. Z obrazem stanu bazy danych nie mogą być powiązane przyrostowe kopie zapasowe bazy danych. Patrz także seria kopii zapasowych bazy danych, pełna kopia zapasowa.

obszar

Część pliku tworzona podczas procesu deduplikacji danych. W celu znalezienia duplikatów obszary są porównywane z obszarami innych plików w celu.

obszar plików

Logiczny obszar w pamięci masowej serwera zawierający grupę plików, dla których węzeł kliencki utworzył kopię zapasową lub archiwalną z jednej partycji logicznej, systemu plików lub wirtualnego punktu podłączenia. Węzły klienckie mogą odtwarzać, pobierać lub usuwać swoje obszary plików z pamięci masowej serwera. W pamięci masowej serwera pliki należące do jednego obszaru plików niekoniecznie są zapisane razem.

obszar plików z obsługą Unicode

Obszar plików o nazwie, która jest zgodna ze standardem Unicode kompatybilnym z dowolnymi ustawieniami narodowymi na stacjach roboczych, w wielu językach.

odbiornik

Repozytorium serwera zawierające dziennik komunikatów serwera i klienta w postaci zdarzeń. Odbiornikiem może być na przykład program użytkownika, konsola serwera lub dziennik aktywności. Patrz także zdarzenie.

odtworzenie

Kopiowanie informacji z kopii zapasowej do aktywnej pamięci masowej w celu ich użycia. Przykład: kopiowanie informacji z pamięci masowej serwera do klienckiej stacji roboczej.

odtworzenie pojedynczej skrzynki pocztowej

Patrz odtwarzanie skrzynki pocztowej.

odtworzenie skrzynki pocztowej

Funkcja odtwarzająca dane programu Microsoft Exchange Server (z kopii zapasowych programu IBM Data Protection for Microsoft Exchange) na poziomie skrzynki pocztowej lub elementów skrzynki pocztowej.

odtworzenie VSS

Funkcja używająca usługi VSS (Microsoft Volume Shadow Copy Service) do odtwarzania obrazów stanu zapisanych w pamięci masowej serwera. Obrazy te zostały wcześniej utworzone przez funkcję kopii zapasowej VSS i są odtwarzane w oryginalnej lokalizacji.

odzyskiwanie

Proces konsolidowania pozostałych danych z wielu woluminów o dostępie sekwencyjnym do mniejszej liczby nowych woluminów o dostępie sekwencyjnym.

okno uruchamiania

Przedział czasu, w którym musi być zainicjowany harmonogram.

okres oczekiwania na podłączenie  
Maksymalna liczba minut, przez jaką serwer oczekuje na wykonanie żądania podłączenia woluminu wolumin nośników o dostępie sekwencyjnym, zanim anuluje to żądanie.

okres przechowywania kopii archiwalnej  
Liczba dni, przez które menedżer pamięci masowej przechowuje zarchiwizowany plik, gdy serwer nie może ponownie powiązać tego pliku z odpowiednią klasą zarządzania. Patrz także powiązać.

okres przechowywania kopii zapasowych  
Liczba dni, przez które menedżer pamięci masowej przechowuje kopię zapasową, jeśli serwer nie może ponownie powiązać tego pliku z odpowiednią klasą zarządzania.

okres przechowywania podłączenia  
Maksymalna liczba minut, przez jaką serwer przechowuje podłączony wolumin nośników o dostępie sekwencyjnym, który nie jest używany, zanim go odłączy.

osierocony plik pośredniczący  
Plik, dla którego nie znaleziono pliku zmigrowanego na serwerze udostępniającemu węzłowi klienckiemu usługi zarządzania pamięcią masową. Na przykład plik pośredniczący może być osierocony wtedy, gdy plik opcji systemowych klienta zostanie zmodyfikowany w taki sposób, że będzie nawiązywane połączenie z serwerem innym niż serwer, do którego ten plik został zmigrowany.

ośrodek chroniony  
Patrz także ośrodek podstawowy.

ośrodek dodatkowy  
Ośrodek fizyczny lub wirtualny, który składa się z zasobów sprzętowych, sieciowych i pamięci masowej, używany na wypadek awarii ośrodka podstawowego. W razie wystąpienia awarii w ośrodku podstawowym operacje mogą być kontynuowane w ośrodku dodatkowym. Patrz także ośrodek podstawowy.

ośrodek odtwarzania  
Patrz ośrodek dodatkowy.

ośrodek podstawowy  
Ośrodek fizyczny lub wirtualny, który składa się z zasobów sprzętowych, sieciowych i pamięci masowej. Zwykle produkcja odbywa się w ośrodku podstawowym. Dane mogą być replikowane do ośrodka dodatkowego na wypadek konieczności przetłoczenia awaryjnego lub odzyskiwania po awarii. Patrz także ośrodek dodatkowy.

## P

---

pakiet  
W zagadnieniach dotyczących przesyłania danych: sekwencja cyfr binarnych, w tym danych i sygnałów sterujących, przesyłanych i przetwarzanych jako całość.

pamięć masowa serwera  
Pule pamięci podręcznej, podstawowe, kopii i danych aktywnych używane przez serwer do zapisywania plików użytkowników: wersji kopii zapasowych, kopii archiwalnych i plików zmigrowanych z węzłów klientów HSM (plików z zarządzaniem pamięcią). Patrz także pula danych aktywnych, pula pamięci masowej kontenera, pula pamięci masowej kopii, podstawowa pula pamięci masowej, wolumin puli pamięci masowej, wolumin.

partycja zarządzania obciążeniem (WPAR)  
Partycja w pojedynczej instancji systemu operacyjnego.

pełna kopia zapasowa  
Proces tworzenia kopii zapasowej całej bazy danych serwera. Pełna kopia zapasowa rozpoczyna nową serię kopii zapasowych bazy danych. Patrz także seria kopii zapasowych bazy danych, obraz stanu bazy danych, przyrostowa kopia zapasowa.

plan odtwarzania po awarii  
Plik utworzony przez menedżera odtwarzania po awarii (DRM) zawierający informacje o sposobie odtwarzania systemów komputerowych po wystąpieniu awarii i skrypty, które można uruchomić w celu wykonania niektórych zadań odtwarzania. Plik ten zawiera informacje o oprogramowaniu i sprzęcie używanym przez serwer i miejscu, w którym znajduje się nośnik odtwarzania.

plik fizyczny  
Plik zapisany w jednej lub większej liczbie pul pamięci masowej, składający się z jednego pliku logicznego lub grupy plików logicznych tworzących razem agregat. Patrz także agregat, plik logiczny, fizyczny poziom zajętości.

plik historii woluminów  
Plik zawierający informacje o woluminach, które były używane przez serwer podczas operacji tworzenia kopii zapasowych baz danych i do eksportowania danych administratora, węzła, strategii lub serwera. W tym pliku ponadto znajdują się informacje o woluminach pul pamięci masowej o dostępie sekwencyjnym, które zostały dodane, ponownie wykorzystane lub usunięte. Informacje te są kopią informacji o woluminach zapisanych w bazie danych serwera.

plik konfiguracyjny urządzenia

1. W przypadku serwera: plik zawierający informacje o zdefiniowanych klasach urządzeń i - na niektórych serwerach - o zdefiniowanych bibliotekach i napędach. Informacje te to kopia informacji konfiguracyjnych urządzenia w bazie danych.
2. W przypadku agenta pamięci masowej: plik zawierający nazwę i hasło agenta pamięci masowej, informacje o serwerze zarządzającym bibliotekami i napędami podłączonymi do sieci SAN używanymi przez agenta pamięci masowej.

#### plik logiczny

Plik zapisany w jednej lub większej liczbie pul pamięci masowej serwera jako samodzielny plik lub jako część agregatu. Patrz także agregat, plik fizyczny, fizyczny poziom zajętości.

#### plik makra

Plik zawierający jedną lub więcej komend administracyjnych produktu IBM Spectrum Protect, który może być uruchomiony wyłącznie z klienta administracyjnego za pomocą komendy MACRO. Patrz także skrypt komend produktu IBM Spectrum Protect.

#### plik opcji

Plik zawierający opcje przetwarzania. Patrz także plik opcji systemowych klienta, plik opcji użytkownika klienta.

#### plik opcji klienta

Edytowalny plik określający serwer i metodę komunikacji oraz udostępniający konfigurację dla operacji tworzenia kopii zapasowych, archiwizowania, hierarchicznego zarządzania pamięcią masową i planowania.

#### plik opcji serwera

Plik zawierający ustawienia, które sterują różnymi operacjami serwera. Ustawienia te wpływają między innymi na procesy komunikacji, urządzenia i wydajność serwera.

#### plik opcji systemowych klienta

Plik używany na klientach systemów AIX, UNIX lub Linux zawierający zestaw opcji przetwarzania określających serwery, z którymi nawiązywane są połączenia w celu udostępnienia usług. Ponadto ten plik określa metody komunikacji i opcje dla operacji tworzenia kopii zapasowych, archiwizowania, hierarchicznego zarządzania pamięcią masową i planowania. Patrz także plik opcji użytkownika klienta, plik opcji.

#### plik opcji użytkownika klienta

Plik zawierający zestaw opcji przetwarzania używanych przez klientów w systemie. Ten zestaw może obejmować opcje określające serwer, z którym komunikuje się klient, a także opcje wpływające na operacje tworzenia kopii zapasowych, operacje archiwizowania, operacje hierarchicznego zarządzania pamięcią masową i operacje zaplanowane. Ten plik jest zwany również plikiem dsm.opt. Dla systemów AIX, UNIX lub Linux patrz także plik opcji systemowych klienta. Patrz także plik opcji systemowych klienta, plik opcji.

#### plik pamięci podręcznej

Obraz stanu woluminu logicznego utworzony przez agenta LVSA (Logical Volume Snapshot Agent). Bloki są zapisywane tuż przed modyfikacją podczas tworzenia kopii zapasowej obrazu stanu, a ich obszary logiczne są zapisywane w plikach pamięci podręcznej.

#### plik pośredniczący

Plik, który zastępuje oryginalny plik w lokalnym systemie plików, gdy zostanie on zmigrowany do pamięci masowej. Plik pośredniczący zawiera informacje niezbędne do przywrócenia zmigrowanego pliku z pamięci masowej serwera. Plik ten zawiera również dodatkowe informacje, których można użyć, aby nie trzeba było przywracać zmigrowanego pliku. Patrz także migrowany plik, plik rezydentny.

#### plik przedawniony

Zmigrowany lub zmigrowany wstępnie plik oznaczony jako plik, który ma utracić ważność i zostać usunięty z pamięci masowej. Jeśli plik pośredniczący lub oryginalna kopia wstępnie zmigrowanego pliku zostanie usunięta z systemu lokalnego albo jeśli oryginalna kopia wstępnie zmigrowanego pliku zostanie zaktualizowana, odpowiadający jej zmigrowany lub wstępnie zmigrowany plik zostanie oznaczony do utraty ważności i usunięcia przy następnym uruchomieniu uzgadniania.

#### plik rezydentny

W systemie Windows: kompletny plik w lokalnym systemie plików, którym może być także plik zmigrowany, ponieważ w pamięci masowej serwera istnieje zmigrowana kopia. W systemie UNIX lub Linux: kompletny plik w lokalnym systemie plików, który nie został zmigrowany lub zmigrowany wstępnie lub który został przywrócony z pamięci masowej serwera i zmodyfikowany.

#### plik rzadki

Plik większy niż ilość znajdujących się w nim danych, zawierający puste miejsca na dane, które zostaną dodane w przyszłości.

#### plik specjalny

W systemach AIX, UNIX i Linux: plik definiujący urządzenia dla systemu lub pliki specjalne tworzone przez procesy. Istnieją trzy podstawowe typy plików specjalnych: FIFO (first-in, first-out), blokowe i znakowe.

#### plik włączeń/wykluczeń

Plik zawierający instrukcje określające pliki, dla których ma być tworzona kopia zapasowa, a także powiązane klasy zarządzania, które mają być używane przez operacje tworzenia kopii zapasowych lub archiwalnych. Patrz także lista



dołączeń i wykluczeń.

plik wstępnie zmigrowany  
Plik, który został skopiowany do pamięci masowej serwera, ale nie został zastąpiony plikiem pośredniczącym w lokalnym systemie plików. Identyczna kopia pliku istnieje zarówno w lokalnym systemie plików, jak i w pamięci masowej serwera. Pliki wstępnie zmigrowane występują w systemach plików UNIX i Linux, do których dodano zarządzanie pamięcią masową. Patrz także stan pliku, migrowany plik, plik rezydentny.

plik z zarządzaniem pamięcią  
Plik migrowany z węzła klienckiego przez klienta HSM. Klient HSM na żądanie przywraca plik do węzła klienckiego.

plik zadania  
Wygenerowany plik zawierający informacje konfiguracyjne dotyczące zadania migracji. Plik ten jest w formacie XML i może być tworzony, a także modyfikowany w kliencie HSM dla graficznego interfejsu użytkownika klienta Windows. Patrz także zadanie migracji.

plik zniszczony  
Plik fizyczny, w którym wykryto błędy odczytu.

pobieranie  
Kopiowanie zarchiwizowanych informacji z puli pamięci masowej do stacji roboczej w celu ich użycia. Operacja pobierania nie ma wpływu na wersję archiwalną zapisaną w puli pamięci masowej. Patrz także archiwizować.

podstawowa pula pamięci masowej  
Nazwany zestaw woluminów lub kontenerów, których serwer używa do zapisywania wersji kopii zapasowych i archiwalnych plików, a także plików zmigrowanych z węzłów klienckich. Patrz także pula pamięci masowej kopii, pamięć masowa serwera, pula pamięci masowej, wolumin puli pamięci masowej.

ponowne wiązanie  
Kojarzenie wszystkich wersji kopii zapasowych pliku z nową nazwą klasy zarządzania. Na przykład plik, który ma aktywną wersję kopii zapasowej, jest powiązany ponownie, gdy dla nowszej wersji tego pliku zostanie utworzona kopia zapasowa z użyciem innego powiązania klasy zarządzania. Patrz także powiązać, klasa zarządzania.

porcja  
Kontener pamięci masowej w chmurze używany przez usługę Amazon Simple Storage Service (Amazon S3).

potok nazwany  
Typ komunikacji międzyprocesowej pozwalającej na przesyłanie strumieni danych między równorzędnymi procesami węzłów sieci, takich jak klient i serwer.

potwierdzenie (ACK)  
Przesłanie znaków potwierdzenia odbioru jako pozytywnej odpowiedzi na przesłanie danych.

powiązać  
Skojarzyć plik z nazwą klasy zarządzania. Patrz także okres przechowywania kopii archiwalnej, klasa zarządzania, ponowne wiązanie.

powiązania profilu  
W menedżerze konfiguracji: relacja zdefiniowana między profilem a obiektem, takim jak domena strategii. Powiązania profilu definiują informacje konfiguracyjne dystrybuowane do serwera zarządzanego, gdy profil ten zostanie zasubskrybowany przez serwer.

powiązanie  
Zdefiniowana relacja między węzłem klienckim a harmonogramem klienta. Powiązanie określa nazwę harmonogramu, nazwę domeny strategii, do której należy ten harmonogram, a także nazwę węzła klienckiego wykonującego zaplanowane operacje.

profil  
Nazwana grupa informacji konfiguracyjnych, która może być dystrybuowana z menedżera konfiguracji po zasubskrybowaniu przez serwer zarządzany. Informacje konfiguracyjne mogą obejmować: zarejestrowane identyfikatory administratorów, strategię, harmonogramy klientów, zestawy opcji klientów, harmonogramy administrowania, skrypty komend menedżera pamięci masowej, definicje serwerów i grup serwerów. Patrz także menedżer konfiguracji, konfiguracja korporacyjna, serwer zarządzany.

protokół komunikacyjny  
Zestaw zdefiniowanych interfejsów umożliwiających komputerom wzajemną komunikację.

protokół TCP/IP (Transmission Control Protocol/Internet Protocol)  
Zestaw protokołów komunikacyjnych, stanowiących standard branżowy i nie będących protokołami prawnie zastrzeżonymi, zapewniających niezawodne połączenia na całej trasie między aplikacjami za pomocą sieci sprzęgających o różnych typach. Patrz także metoda komunikacji.

próg migracji  
Dolne i górne pojemności puli pamięci masowej lub systemów plików wyrażone jako wartości procentowe, przy których migracja ma być uruchamiana i zatrzymywana.

próg odzyskiwania  
Procentowa wartość pamięci masowej, jaka musi istnieć na woluminie nośników o dostępie sekwencyjnym, aby serwer mógł odzyskać ten wolumin. Pamięć staje się odzyskiwalna w miarę utraty ważności przez pliki lub usuwania plików.

przedrostek woluminu taśm

Kwalifikator wysokiego poziomu nazwy pliku lub nazwy zestawu danych na standardowej etykiecie taśmy.

przenoszenie danych bez obciążania sieci LAN  
Przenoszenie danych klienta między systemem klienta i urządzeniem pamięci masowej w sieci SAN z pominięciem sieci lokalnej.

przepustowość  
W zagadnieniach związanych z zarządzaniem pamięcią masową: łączna liczba bajtów związanych z obciążeniem, z wyłączeniem narzutu, dla których wykonywana jest operacja tworzenia lub odtwarzania kopii zapasowej, podzielona przez czas trwania tej operacji.

przesyłanie danych bez obciążania sieci LAN  
Patrz przenoszenie danych bez obciążania sieci LAN.

przyrostowa kopia zapasowa  
Proces tworzenia kopii zapasowej plików i katalogów lub kopiowania stron w bazie danych, które są nowe lub które uległy zmianie od chwili utworzenia ostatniej pełnej lub przyrostowej kopii zapasowej. Patrz także wybiórcze tworzenie kopii zapasowych.

przywracanie  
Kopiowanie zmigrowanego pliku z pamięci masowej serwera z powrotem do macierzystego systemu plików za pomocą klienta zarządzania pamięcią masową. Patrz także przywracanie wybiórcze.

przywracanie przezroczyste  
Proces używany w celu automatycznego przywrócenia zmigrowanego wcześniej pliku do stacji roboczej lub serwera plików w chwili uzyskania dostępu do pliku. Patrz także przywracanie wybiórcze.

przywracanie wybiórcze  
Proces kopiowania plików wybranych przez użytkownika z pamięci masowej serwera do lokalnego systemu plików. Patrz także przywracanie, przywracanie przezroczyste.

pula danych aktywnych  
Nazwany zestaw woluminów puli pamięci masowej zawierający tylko aktywne wersje danych kopii zapasowej klienta. Patrz także pamięć masowa serwera, pula pamięci masowej, wolumin puli pamięci masowej.

pula pamięci masowej  
Zestaw woluminów pamięci masowej lub kontenerów, który jest miejscem docelowym używanym do zapisywania danych klientów. Patrz także pula danych aktywnych, pula pamięci masowej kontenera-chmury, pula pamięci masowej kopii, pula pamięci masowej kontenera-katalogu, podstawowa pula pamięci masowej, hierarchia pamięci masowej.

pula pamięci masowej kontenera  
Podstawowa pula pamięci masowej, której serwer używa do przechowywania danych. Dane są przechowywane w kontenerach w katalogach systemu plików lub w pamięci masowej w chmurze. Dane są deduplikowane, jeśli to konieczne, ponieważ serwer zapisuje je w puli pamięci masowej. Patrz także pula pamięci masowej kontenera-chmury, kontener, pula pamięci masowej kontenera-katalogu.

pula pamięci masowej kontenera-chmury  
Pula pamięci masowej, której serwer używa do przechowywania danych w pamięci masowej w chmurze. Pamięć masowa w chmurze może znajdować się w siedzibie lub poza siedzibą przedsiębiorstwa. Patrz także pamięć masowa kontenera, pula pamięci masowej katalogu-kontenera, pula pamięci masowej.

pula pamięci masowej kontenera-katalogu  
Pula pamięci masowej, której serwer używa do przechowywania danych w katalogach pamięci masowej. Dane, które są przechowywane w puli pamięci masowej kontenera-katalogu, mogą podlegać deduplikacji podczas wstawiania lub po stronie klienta. Patrz także pula pamięci masowej kontenera-chmury, pula pamięci masowej kontenera, pula pamięci masowej kontenera-kopii, pula pamięci masowej.

pula pamięci masowej kontenera-kopii  
Pula pamięci masowej, której serwer używa do przechowywania kopii obszarów z puli pamięci masowej w chmurze katalogu-kontenera. Kopie są używane do naprawy uszkodzeń w puli pamięci masowej kontenera-katalogu. Pule pamięci masowej kontenera-kopii używają nośników sekwencyjnych, takich jak taśmy. Patrz także pula pamięci katalogu-kontenera.

pula pamięci masowej kopii  
Nazwany zestaw woluminów zawierających kopie plików znajdujących się w podstawowych pulach pamięci masowej. Pule pamięci masowej kopii są używane tylko do tworzenia kopii zapasowych danych zapisanych w podstawowych pulach pamięci masowej. Pula pamięci masowej kopii nie może być miejscem docelowym dla grupy kopii zapasowych, grupy kopii archiwalnych ani klasy zarządzania (dla plików z zarządzaniem pamięcią). Patrz także miejsce docelowe, podstawowa pula pamięci masowej, pamięć masowa serwera, pula pamięci masowej, wolumin puli pamięci masowej.

punkt podłączenia  
Napęd logiczny, za pomocą którego uzyskuje się dostęp do woluminów należących do klasy urządzeń o dostępie sekwencyjnym. Dla nośników wymiennych, takich jak taśmy, punkt podłączenia jest napędem logicznym powiązany z napędem fizycznym. Dla urządzeń o typie plikowym, punkt podłączenia jest napędem logicznym powiązany ze strumieniem we/wy. Patrz także limit podłączeń.

randomizacja  
Proces dystrybuowania czasów uruchamiania harmonogramów dla różnych klientów w obrębie określonej wartości procentowej okna uruchamiania harmonogramu.

reguła autoryzacji  
Specyfikacja zezwalająca innemu użytkownikowi na odtwarzanie lub pobieranie plików użytkownika z pamięci masowej.

reguła uwierzytelniania  
Specyfikacja określająca, że inny użytkownik może odtwarzać lub pobierać pliki z pamięci masowej.

rejestr  
Repozytorium zawierające informacje o dostępie i konfiguracji dotyczące użytkowników, systemów i oprogramowania.

rejestracja otwarta  
Proces rejestrowania, w którym użytkownicy mogą sami rejestrować na serwerze swoje stacje robocze jako węzły klienckie. Patrz także rejestracja zamknięta.

rejestracja zamknięta  
Proces rejestracji, w którym tylko administrator może rejestrować stacje robocze jako węzły klienckie na serwerze. Patrz także rejestracja otwarta.

rejestrowanie  
Definiowanie węzła klienckiego lub identyfikatora administratora, który może uzyskiwać dostęp do serwera.

rejestrowanie korporacyjne  
Proces wysyłania zdarzeń z serwera do wyznaczonego serwera zdarzeń. Serwer zdarzeń kieruje zdarzenia do wyznaczonych odbiorników, takich jak programy użytkownika. Patrz także zdarzenie.

rekord zdarzenia  
Rekord bazy danych opisujący rzeczywisty status i wynik zdarzenia.

rodzimy system plików  
System plików lokalnie dodany do serwera plików, który nie został dodany do zarządzania pamięcią masową. Klient HSM nie udostępnia usług zarządzania pamięcią masową takiemu systemowi plików.

rozmyta kopia zapasowa  
Wersja kopii zapasowej pliku, która może nie odzwierciedlać dokładnie bieżącej zawartości pliku, ponieważ kopia zapasowa tego pliku została utworzona w tym samym momencie, gdy plik był modyfikowany.

rozszerzanie  
Zwiększanie ilość miejsca przeznaczanego do zapisania informacji w bazie danych lub informacji z dzienników odtwarzania.

## S

---

SAN  
Patrz sieć pamięci masowej.

Secure Sockets Layer (SSL)  
Protokół zabezpieczeń zapewniający prywatność komunikacji. Używając protokołu SSL, aplikacje klient/serwer komunikują się w sposób chroniący przed podsłuchaniem, atakiem lub fałszowaniem komunikatów.

sekcja  
Grupa wierszy w pliku, które spełniają tę samą funkcję lub definiują część systemu. Sekcje są zwykle oddzielone pustymi wierszami lub dwukropkami, a każda sekcja ma nazwę.

seria kopii zapasowych bazy danych  
Jedna pełna kopia zapasowa bazy danych plus 32 przyrostowe kopie zapasowe utworzone od momentu utworzenia pełnej kopii zapasowej. Każda pełna kopia zapasowa rozpoczyna nową serię kopii zapasowych bazy danych. Każda seria kopii zapasowych jest identyfikowana przez liczbę. Patrz także obraz stanu bazy danych, pełna kopia zapasowa.

serwer  
Program lub komputer udostępniający usługi innym programom lub komputerom. Patrz także klient.

serwer menedżera danych  
Serwer gromadzący metadane dla spisu zasobów klienta i zarządzający transakcjami dla agenta pamięci masowej za pomocą sieci lokalnej. Serwer menedżera danych informuje agenta pamięci masowej o odpowiednich atrybutach biblioteki i identyfikatorze woluminu docelowego.

serwer nośników  
W środowisku z/OS: program umożliwiający dostęp do dyskowej lub taśmowej pamięci masowej w systemie z/OS serwerom IBM Spectrum Protect działającym w systemach operacyjnych innych niż z/OS.

serwer plików  
Dedykowany komputer wraz z peryferyjnymi urządzeniami pamięci masowej podłączonymi do sieci lokalnej, na których zapisywane są programy i pliki współużytkowane przez użytkowników sieci.

serwer plików NAS  
Patrz serwer plików pamięci masowej podłączonej przez sieć.

serwer plików pamięci masowej podłączonej przez sieć (serwer plików NAS)

Dedykowane urządzenie pamięci masowej używające systemu operacyjnego zoptymalizowanego pod kątem funkcji udostępniania plików. Serwer plików NAS może jednocześnie posiadać cechy węzła i narzędzia przenoszenia danych.

**serwer zarządzany**  
Serwer, który otrzymuje informacje konfiguracyjne z menedżera konfiguracji za pomocą subskrypcji jednego lub większej liczby profili. Informacje konfiguracyjne mogą obejmować definicje obiektów takich jak strategie i harmonogramy. Patrz także menedżer konfiguracji, konfiguracja korporacyjna, profil, subskrypcja.

**serwer zdarzeń**  
Serwer, do którego inne serwery mogą wysyłać zdarzenia w celu ich zarejestrowania. Serwer zdarzeń kieruje zdarzenia do odbiorników skonfigurowanych dla zdarzeń serwera wysyłającego.

**sesja**  
Logiczne lub wirtualne połączenie między dwoma stacjami, programami lub urządzeniami w sieci, które dwóm takim elementom umożliwia komunikację i wymianę danych. Patrz także sesja administracyjna.

**sesja administracyjna**  
Okres, w którym użytkownik używający identyfikatora administratora komunikuje się z serwerem w celu wykonania czynności administracyjnych. Patrz także sesja węzła klienckiego, sesja.

**sesja węzła klienckiego**  
Sesja, w której węzeł kliencki komunikuje się z serwerem w celu wykonania żądań utworzenia kopii zapasowej, odtwarzania, archiwizowania, pobierania, migrowania lub przywracania. Patrz także sesja administracyjna.

**sieć lokalna (LAN)**  
Sieć łącząca szereg urządzeń w ograniczonym obszarze (takim jak pojedynczy budynek lub miasteczko akademickie), która może być połączona z rozleglejszą siecią.

**sieć pamięci masowej (storage area network - SAN)**  
Dedykowana sieć pamięci masowej, która jest dostosowana do konkretnego środowiska i łączy serwery, systemy, produkty pamięci masowej, produkty sieciowe, oprogramowanie i usługi.

**składnica danych**  
W środowisku zwirtualizowanym jest to położenie, w którym przechowywane są dane maszyny wirtualnej.

**skrypt**  
Seria komend umieszczonych w pliku wykonujących konkretne funkcje podczas wykonywania tego pliku. Skrypty są interpretowane w czasie wykonywania. Patrz także skrypt komend produktu IBM Spectrum Protect.

**skrypt komend produktu IBM Spectrum Protect**  
Sekwencja komend administracyjnych produktu IBM Spectrum Protect zapisana w bazie danych serwera IBM Spectrum Protect. Taki skrypt można uruchomić za pomocą dowolnego interfejsu umożliwiającego dostęp do serwera. Skrypt może zawierać podstawienia parametrów komend i instrukcje warunkowe. Patrz także plik makra, skrypt.

**sprawdzanie poprawności**  
Sprawdzanie, czy w zestawie strategii nie występują warunki, które spowodują wystąpienie błędów, jeśli zestaw ten zostanie oznaczony jako aktywny. W procesie sprawdzania poprawności sprawdzane jest na przykład, czy zestaw strategii zawiera domyślną klasę zarządzania.

**SSL**  
Patrz Secure Sockets Layer.

**stabilizowany obszar plików**  
Obszar plików, który istnieje na serwerze, ale nie istnieje na kliencie.

**stacja robocza**  
Terminal lub komputer osobisty, na którym użytkownik może uruchamiać aplikacje i który zwykle jest połączony z komputerem mainframe lub siecią.

**stan globalnej nieaktywności**  
Stan wszystkich systemów plików, do których dodano zarządzanie pamięcią masową i w którym zarządzanie pamięcią masową zostało globalnie dezaktywowane dla węzła klienckiego.

**stan pliku**  
Tryb zarządzania pamięcią masową pliku znajdującego się w systemie plików, do którego dodano zarządzanie pamięcią masową. Plik może być w jednym z trzech stanów: rezydentny, wstępnie zmigrowany lub zmigrowany. Patrz także migrowany plik, plik wstępnie zmigrowany, plik rezydentny.

**stan systemu plików**  
Tryb zarządzania pamięcią masową systemu plików znajdującego się na stacji roboczej, w której zainstalowano klienta hierarchicznego zarządzania pamięcią masową (HSM). System plików może być w jednym z następujących stanów: rodzimy, aktywny, nieaktywny lub nieaktywny globalnie.

**strona**  
Zdefiniowana jednostka miejsca na nośniku pamięci masowej lub w woluminie bazy danych.

**subskrypcja**  
W środowisku pamięci masowej, proces identyfikowania subskrybentów, do których są dystrybuowane profile. Patrz także konfiguracja korporacyjna, serwer zarządzany.

**surowy wolumin logiczny**

Fragment woluminu fizycznego składający się z bloków nieprzydzielonych i nieposiadający definicji systemu plików JFS (Journaled File System). Wolumin logiczny jest dostępny do odczytu/zapisu jedynie przez funkcje we/wy niskiego poziomu. system plików podłączany automatycznie (AutoFS)

System plików zarządzany przez demona automounter. Demon automounter monitoruje określoną ścieżkę katalogów i automatycznie podłącza system plików w celu uzyskania dostępu do danych.

szeregowanie

Proces obsługi plików, które są modyfikowane podczas przetwarzania kopii zapasowych lub archiwalnych. Patrz także szeregowanie dynamicznych powtarzanych, szeregowanie statycznych powtarzanych, szeregowanie statyczne.

szeregowanie dynamiczne

Typ szeregowania kopii, w którym dla pliku lub folderu tworzona jest kopia zapasowa przy pierwszej próbie, bez względu na to, czy zostanie on zmieniony podczas wykonywania operacji tworzenia kopii zapasowej lub archiwalnej. Patrz także szeregowanie dynamicznych powtarzanych, szeregowanie statycznych powtarzanych, szeregowanie statyczne.

szeregowanie dynamicznych powtarzanych

Wartość szeregowania wskazująca, że nie może zostać utworzona kopia zapasowa ani archiwalna pliku, który został zmieniony podczas wykonywania operacji. Klient kopii zapasowych i archiwalnych ponawia operację tworzenia kopii zapasowej lub archiwalnej określoną liczbę razy. Jeśli plik zostanie zmieniony podczas każdej próby, klient kopii zapasowych i archiwalnych utworzy kopię zapasową lub archiwalną pliku dla ostatniej próby. Patrz także szeregowanie dynamiczne, szeregowanie, szeregowanie statycznych powtarzanych, szeregowanie statyczne.

szeregowanie statyczne

Wartość szeregowania grupy kopii określająca, że plik nie może być modyfikowany podczas wykonywania operacji tworzenia kopii zapasowej lub archiwalnej. Jeśli plik jest używany podczas pierwszej próby, menedżer pamięci masowej nie utworzy kopii zapasowej lub archiwalnej pliku. Patrz także szeregowanie dynamiczne, szeregowanie, szeregowanie dynamicznych powtarzanych, szeregowanie statycznych powtarzanych.

szeregowanie statycznych powtarzanych

Wartość szeregowania grupy kopii określająca, że plik nie może być modyfikowany podczas wykonywania operacji tworzenia kopii zapasowej lub archiwalnej. Klient podejmuje określoną liczbę prób wykonania tej operacji. Jeśli podczas każdej kolejnej próby plik jest używany, jego kopia zapasowa lub archiwalna nie zostanie utworzona. Patrz także szeregowanie dynamiczne, szeregowanie, szeregowanie dynamicznych powtarzanych, szeregowanie statyczne.

szybkie odtwarzanie VSS

Operacja, która odtwarza dane z lokalnego obrazu stanu. Obraz stanu jest kopią zapasową VSS, która znajduje się w lokalnym woluminie w tle. Operacja odtwarzania pobiera dane za pomocą metody kopiowania na poziomie plików.

szybkość przesyłania danych sieciowych

Szybkość obliczona przez podzielenie łącznej liczby przestanych bajtów przez czas ich przesyłania. Szybkość ta może być na przykład czasem przeznaczonym na przesyłanie danych w sieci.

szyfrowany system plików (Encrypted File System - EFS)

System plików, w którym używane jest szyfrowanie na poziomie systemu plików.

---

## Ś

ścieżka

Obiekt definiujący relację jeden-do-jednego między miejscem źródłowym a miejscem docelowym. Ścieżka umożliwia dostęp do miejsca docelowego z miejsca źródłowego. Dane mogą być przesyłane z miejsca źródłowego do docelowego lub odwrotnie. Miejscem źródłowym może być na przykład narzędzie przenoszenia danych (takie jak serwer plików NAS), a miejscem docelowym może być napęd taśm.

---

## T

TCA

Patrz zaufany agent komunikacyjny.

TCP/IP

Patrz protokół TCP/IP (Transmission Control Protocol/Internet Protocol).

tryb

Atrybut grupy kopii określający, czy ma być tworzona kopia zapasowa pliku, który nie uległ zmianie od chwili utworzenia ostatniej kopii zapasowej. Patrz także tryb bezwzględny, tryb zmodyfikowany.

tryb bezwzględny

W zagadnieniach związanych z zarządzaniem pamięcią masową: tryb grupy kopii zapasowej określający, że plik lub katalog jest uwzględniany w przyrostowej kopii zapasowej nawet wtedy, gdy nie został zmieniony od momentu utworzenia ostatniej kopii zapasowej. Patrz także tryb, tryb zmodyfikowany.

tryb częściowego przywracania plików

Tryb przywracania, w którym funkcja HSM odczytuje tylko fragment zmigrowanego pliku z pamięci masowej zgodnie z żądaniem aplikacji uzyskującej dostęp do pliku.

tryb dostępu

Atrybut puli pamięci masowej lub woluminu pamięci masowej określający, czy serwer może zapisywać dane w puli pamięci masowej lub woluminie pamięci masowej albo odczytywać je z tej puli albo woluminu.

tryb planowania

Typ operacji planowania dla węzła serwera i węzła klienckiego obsługujących dwa tryby planowania: z odpytywaniem przez klienta i inicjowane przez serwer.

tryb planowania inicjowany przez serwer

Technika komunikacji klient/serwer, w której serwer nawiązuje połączenie z węzłem klienckim, kiedy zachodzi konieczność wykonania zadań. Patrz także tryb planowania z odpytywaniem przez klienta.

tryb planowania z odpytywaniem przez klienta

Metoda działania, w której klient odpytuje serwer na potrzeby obsługi. Patrz także tryb planowania inicjowany przez serwer.

tryb zmodyfikowany

W zagadnieniach związanych z zarządzaniem pamięcią masową: tryb grupy kopii zapasowej określający, że plik lub katalog jest uwzględniany w przyrostowej kopii zapasowej tylko wtedy, gdy został zmieniony od momentu utworzenia ostatniej kopii zapasowej. Plik lub katalog jest uznawany za zmodyfikowany, jeśli uległa zmianie jego data, wielkość, właściciel lub uprawnienia. Patrz także tryb bezwzględny, tryb.

tworzenie kopii zapasowej odłączonego woluminu

Operacja tworzenia kopii zapasowej, w której wolumin jest zablokowany po to, aby żadne inne aplikacje w systemie nie mogły uzyskać do niego dostępu podczas wykonywania tej operacji.

tworzenie kopii zapasowej VSS

Operacja tworzenia kopii zapasowej używająca Usługi kopiowania woluminów w tle (VSS) firmy Microsoft. Operacja tworzenia kopii zapasowej tworzy obraz stanu (spójna kopia w zadanym momencie). Tę kopię można zapisać w lokalnych woluminach w tle lub w pamięci masowej serwera.

tworzenie kopii zapasowej woluminu podczas pracy

Operacja tworzenia kopii zapasowej, w której wolumin jest dostępny dla innych aplikacji w systemie podczas wykonywania tej operacji.

tworzenie kopii zapasowych z wykorzystaniem kroniki

Metoda tworzenia kopii zapasowych klientów Windows i AIX wykorzystująca mechanizm powiadamiania o zmianach w plikach w celu zwiększenia wydajności tworzenia przyrostowej kopii zapasowej przez ograniczenie konieczności pełnego skanowania systemu plików.

typ urządzenia plikowego

Typ urządzenia określający użycie plików o dostępie sekwencyjnym na dyskowej pamięci masowej jako woluminów.

## U

---

UCS-2

Dwubajtowy (16-bitowy) schemat kodowania oparty na specyfikacji ISO/IEC 10646-1. UCS-2 definiuje trzy poziomy implementacji: poziom 1 - łączenie kodowanych elementów nie jest dozwolone; poziom 2 - łączenie kodowanych elementów jest dozwolone tylko dla następujących języków: tajski, indyjski, hebrajski i arabski; poziom 3 - dozwolona jest każda kombinacja kodowanych elementów.

UNC

Patrz uniwersalna konwencja nazewnictwa.

Unicode

Standard kodowania znaków umożliwiający wymianę, przetwarzanie i wyświetlanie tekstu napisanego w powszechnie stosowanych na świecie językach, a także w wielu tekstach klasycznych i historycznych.

unikalny identyfikator globalny (GUID)

Określony za pomocą algorytmu numer, który jednoznacznie identyfikuje jednostkę w systemie. Patrz także unikalny identyfikator uniwersalny.

unikalny identyfikator uniwersalny (UUID)

128-bitowy identyfikator liczbowy, dzięki któremu żadne dwa komponenty nie mają takiego samego identyfikatora. Patrz także unikalny identyfikator globalny.

uniwersalna konwencja nazewnictwa (UNC)

Nazwa serwera połączona z nazwą sieciową. Nazwy te razem identyfikują zasób w domenie.

uprawnienie

Prawo do dostępu do obiektów, zasobów lub funkcji. Patrz także klasa uprawnień.

usługa kroniki

W systemie Microsoft Windows: program śledzący zmiany w plikach znajdujących się w systemach plików.

usługa Volume Shadow Copy Service (VSS)

Zestaw funkcji API firmy Microsoft umożliwiających tworzenie kopii zapasowych w tle dla woluminów, dokładnych kopii zapasowych plików, w tym wszystkich plików otwartych itd.

UTF-8

Format UTF (Unicode Transformation Format) jest 8-bitowym formatem kodowania, który zaprojektowano z myślą o ułatwieniu użycia istniejących systemów wykorzystujących format ASCII. Wartością CCSID dla danych w formacie UTF-8

jest 1208.

utrata ważności

Proces identyfikowania plików, zestawów danych lub obiektów przeznaczonych do usunięcia z powodu upłynięcia ich daty ważności lub okresu przechowywania.

UUID

Patrz unikalny identyfikator uniwersalny.

uzgadnianie

Proces zapewniania spójności między oryginalnym repozytorium danych i większym systemem, w którym są przechowywane dane jako kopia zapasowa. Przykłady większych systemów, w których przechowywane są dane tworzące kopię zapasową, są serwery pamięci masowej lub inne systemy pamięci masowej. W procesie uzgadniania dane, które są określone jako zbędne, są usuwane.

użytkownik root

Użytkownik systemu wykonujący operacje bez ograniczeń. Użytkownik root ma specjalne prawa i uprawnienia wymagane do wykonania czynności administracyjnych.

## V

---

VSS

Patrz usługa Volume Shadow Copy Service.

## W

---

wartość procentowa dla migracji wstępnej

Ustawienie zarządzania pamięcią masową określające, czy kolejne zakwalifikowane do migrowania pliki w systemie plików zostaną poddane migracji wstępnej po przeprowadzeniu migracji progowej lub migracji na żądanie.

wersja

Kopia zapasowa pliku zapisana w pamięci masowej serwera. Najnowsza kopia zapasowa pliku jest wersją aktywną. Wcześniej utworzone kopie tego samego pliku są wersjami nieaktywnymi. Liczba wersji przechowywanych przez serwer zależy od atrybutów grupy kopii określonych w klasie zarządzania.

wersja aktywna

Najnowsza zapisana kopia zapasowa pliku. Aktywnej wersji pliku nie można usunąć aż do momentu, gdy proces tworzenia kopii zapasowej wykryje, że użytkownik zastąpił ten plik nowszą wersją lub usunął go z serwera plików albo stacji roboczej. Patrz także wersja kopii zapasowej, wersja nieaktywna.

wersja kopii zapasowej

Plik lub katalog, dla którego węzeł kliencki utworzył kopię zapasową w pamięci masowej. W pamięci masowej może istnieć więcej niż jedna wersja kopii zapasowej, ale tylko jedna z nich jest wersją aktywną. Patrz także wersja aktywna, grupa kopii, wersja nieaktywna.

wersja nieaktywna

Wersja kopii zapasowej pliku, która nie jest najnowszą wersją kopii zapasowej albo jest wersją kopii zapasowej pliku, która już nie istnieje w systemie klienta. Nieaktywne wersje kopii zapasowych są kwalifikowane do przetwarzania obsługującego utratę ważności zgodnie z klasą zarządzania przypisaną do danego pliku. Patrz także wersja aktywna, wersja kopii zapasowej.

węzeł

Serwer plików lub stacja robocza zarejestrowana na serwerze, na której zainstalowano program klienta kopii zapasowych i archiwalnych.

węzeł agenta

Węzeł kliencki, któremu nadano uprawnienie proxy do wykonywania operacji w imieniu innego węzła klienckiego będącego węzłem docelowym.

węzeł docelowy

Węzeł kliencki, do którego innym węzłem klienckim (zwanym węzłami agentów) nadano uprawnienie proxy. Uprawnienie proxy umożliwia węzłom agentów wykonywanie operacji, takich jak tworzenie i odtwarzanie kopii zapasowych, w imieniu węzła docelowego będącego właścicielem danych.

węzeł kliencki

Serwer plików lub stacja robocza zarejestrowana na serwerze, na której zainstalowano program klienta kopii zapasowych i archiwalnych.

węzeł NAS

Węzeł kliencki, który jest serwerem plików NAS. Dane węzła NAS są przesyłane przez serwer plików NAS sterowany przez protokół zarządzania danymi sieciowymi (NDMP). Węzeł NAS jest zwany również węzłem serwera plików NAS.

węzeł serwera plików NAS

Patrz węzeł NAS.

wiek pliku

W kontekście ustalania priorytetów migracji: liczba dni od ostatniego dostępu do pliku.



wielkość pliku pośredniczącego

Wielkość pliku, który zastępuje plik oryginalny w lokalnym systemie plików, gdy zostanie on zmigrowany do pamięci masowej serwera. Wielkość zdefiniowana dla pliku pośredniczącego określa ilość danych wiodących, które można zapisać w pliku pośredniczącym. Domyślnym ustawieniem wielkości pliku pośredniczącego jest wielkość bloku zdefiniowana dla systemu plików pomniejszona o 1 bajt.

wielkość szacunkowa

Wyrażona w megabajtach ilość miejsca dostępnego w puli pamięci masowej.

wirtualny obszar plików

Reprezentacja katalogu w systemie plików NAS w postaci ścieżki do tego katalogu.

wirtualny punkt podłączenia

Gałąź katalogu systemu plików, która jest zdefiniowana jako wirtualny system plików. Wirtualny system plików jest obsługiwany przez własny obszar plików na serwerze. Serwer przetwarza wirtualny punkt podłączenia jako oddzielny system plików, ale system operacyjny klienta tego nie robi.

wirtualny system plików LOFS (loopback virtual file system - LOFS)

System plików tworzony przez podłączenie katalogu do innego katalogu lokalnego; zwany również podłączeniem przez podłączenie. System plików LOFS można także utworzyć za pomocą programu automounter.

wolumin

Indywidualna jednostka pamięci masowej na dysku taśmie lub innym nośniku, na którym możliwe jest zapisywanie danych, obsługująca określoną postać listy identyfikatorów i parametrów, takiej jak etykieta woluminu lub sterowanie we/wy. Patrz także wolumin chwilowy, pamięć masowa serwera, pula pamięci masowej, wolumin puli pamięci masowej.

wolumin chwilowy

Wolumin oznaczony etykietą, który jest pusty lub nie zawiera żadnych poprawnych danych, nie jest zdefiniowany i jest dostępny do użycia. Patrz także wolumin.

wolumin logiczny

Część woluminu fizycznego zawierająca system plików.

wolumin puli pamięci masowej

Wolumin przypisany do puli pamięci masowej. Patrz także pula danych aktywnych, pula pamięci masowej kopii, podstawowa pula pamięci masowej, pamięć masowa serwera, wolumin.

wolumin w tle

Dane zapisane z obrazu stanu woluminu. Obraz stanu może być tworzony również wtedy, gdy aplikacje w systemie zapisują dane w woluminie.

wolumin wirtualny

Plik archiwum na serwerze docelowym, który reprezentuje wolumin nośników sekwencyjnych dla serwera źródłowego.

WPAR

Patrz partycja zarządzania obciążeniem.

wtyczka

Osobno instalowany moduł oprogramowania, który dodaje funkcję do istniejącego programu, aplikacji lub interfejsu.

WWN

Patrz nazwa WWN.

wybiórcze tworzenie kopii zapasowych

Proces tworzenia kopii zapasowych niektórych plików lub katalogów z domeny klienta. Tworzona jest kopia zapasowa tych plików, które nie zostały wykluczone na liście włączeń/wykluczeń. Pliki te muszą spełniać warunki dotyczące szeregowania w grupie kopii zapasowych klasy zarządzania przypisanej do każdego pliku. Patrz także przyrostowa kopia zapasowa.

wykluczanie

Proces identyfikowania plików na liście włączeń/wykluczeń. Ten proces zapobiega tworzeniu kopii zapasowych lub migrowaniu plików za każdym razem, gdy użytkownik wprowadzi operację przyrostowego lub selektywnego tworzenia kopii zapasowych. Plik można wykluczyć z operacji tworzenia kopii zapasowej i z zarządzania pamięcią masową, tylko z operacji tworzenia kopii zapasowej lub tylko z zarządzania pamięcią masową.

## Z

---

zadanie migracji

Specyfikacja plików do zmigrowania i działań, które mają być wykonane na plikach macierzystych po migracji. Patrz także plik zadania, migracja progowa.

zgregowana szybkość przesyłania danych

Statystyka wydajności wskazująca średnią liczbę bajtów przestanych w ciągu sekundy podczas przetwarzania danej operacji.

zapis lustrzany

Proces zapisywania tych samych danych w wielu dyskach jednocześnie. Zapis lustrzany chroni przed utratą danych uwzględnionych w dzienniku odtwarzania lub bazie danych.

zarządzanie cyklem życia informacji (information lifecycle management - ILM)



System zarządzania plikami wykorzystujący strategie dla pul pamięci masowej i zestawów plików. Patrz także General Parallel File System.

zarządzanie pamięcią masową  
Patrz hierarchiczne zarządzanie pamięcią masową.

zaufany agent komunikacyjny (TCA)  
Program obsługujący protokół hasła logowania, gdy klienci używają funkcji generowania hasła.

zdalne  
W produktach HSM: termin odnoszący się do miejsca źródłowego migrowanych plików, które są przenoszone. Patrz także lokalne.

zdarzenie  
Wystąpienie czegoś istotnego dla zadania lub systemu. Zdarzenia mogą obejmować zakończenie lub niepowodzenie operacji, działanie użytkownika lub zmianę stanu procesu. Patrz także rejestrowanie korporacyjne, odbiornik.

zestaw kopii zapasowych  
Przenośna, skonsolidowana grupa aktywnych wersji plików kopii zapasowej wygenerowanych dla klienta kopii zapasowych i archiwalnych.

zestaw opcji klienta  
Grupa opcji zdefiniowanych na serwerze i używana w węzłach klienckich razem z plikami opcji klientów.

zestaw strategii  
Grupa reguł w domenie strategii. Reguły te określają sposób automatycznego zarządzania danymi lub zasobami pamięci masowej dla węzłów klienckich w domenie strategii. Reguły mogą być zawarte w klasach zarządzania. Patrz także aktywny zestaw strategii, klasa zarządzania.

zestaw węzłów GPFS  
Podłączona, zdefiniowana grupa systemów plików GPFS.

znak wieloznaczny  
Znak specjalny, np. gwiazdka (\*) lub znak zapytania (?), który może reprezentować jeden lub wiele znaków. Znak wieloznaczny może być zastąpiony dowolnym znakiem lub zestawem znaków.

znak zastępczy  
Patrz znak wieloznaczny.

zużycie zasobów sesji  
Czas oczekiwania, czas procesora i ilość pamięci zużyte lub pobrane podczas sesji klienta.