

CATIA

Composites Part Design to Manufacturing Process

Technical Overview
Presentation

Tim Greenwood

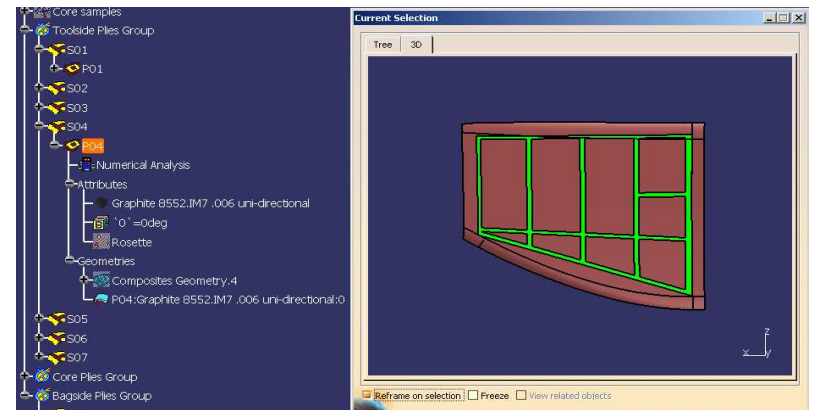

Usual Challenges of Composites

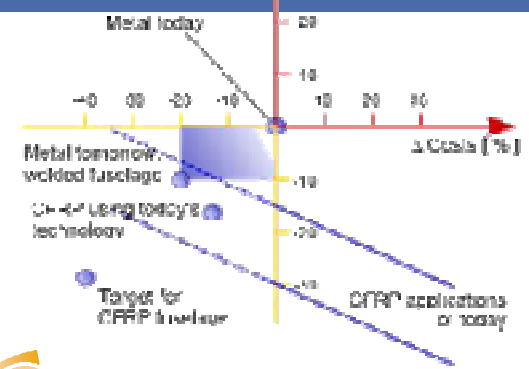

Long cycle time

Cost (Raw Materials, Affordability)

Lots of data to manage

Lots of tedious geometrical tasks

Lack of Mock-up Integration

Lack of Concurrent Engineering

Trial-and-Error in the Shop Floor

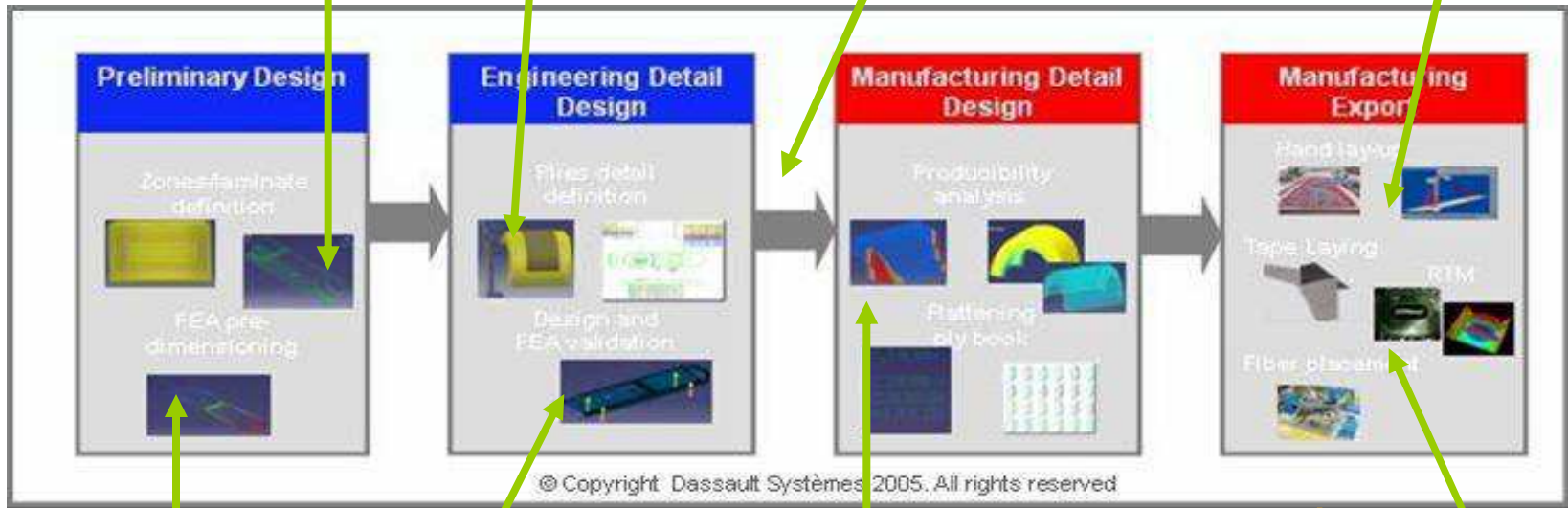

No integration between Analysis and Design

Hard to simulate the global behavior of the Part

Lack of ability to predict manufacturing issues upfront

No Integration with highly specialized manufacturing applications

Environmental Issues (Regulations, Biodegradability, Recyclability, etc...)

CATIA PLM V5 Composites Solutions

- **End-to-end Composites Solution to address Industry challenges**
 - Native V5 Composites Solution from Design to Analysis and Manufacturing
 - Feature-based, specification-driven, dedicated Solution integrated to CATIA V5

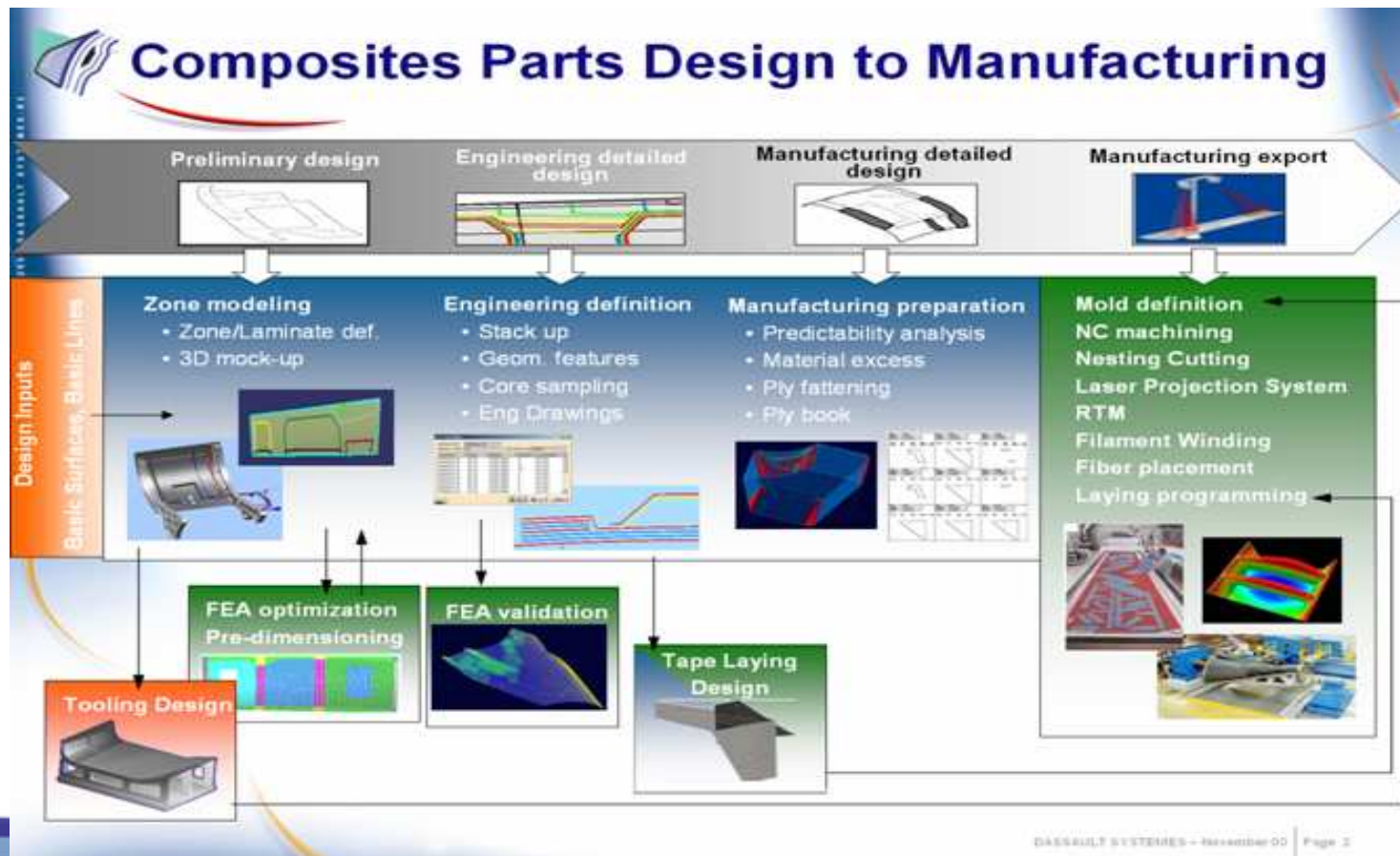

CATIA Composites

- Modular and flexible packaging :
 - A “all-in-one” CATIA Composites configuration (CD3) including a full mechanical seat plus the CATIA Composites Part Design to Manufacturing (CPD) product
 - To respond to specific roles, two subset Composites products, CATIA Composites Engineering (CPE) and CATIA Composites Manufacturing (CPM)

CPD scope: all in one solution for composite design

CATIA Composites Engineering 2 dedicated to preliminary and engineering detailed design

CATIA Composites Design for Manufacturing 2 dedicated to manufacturing preparation

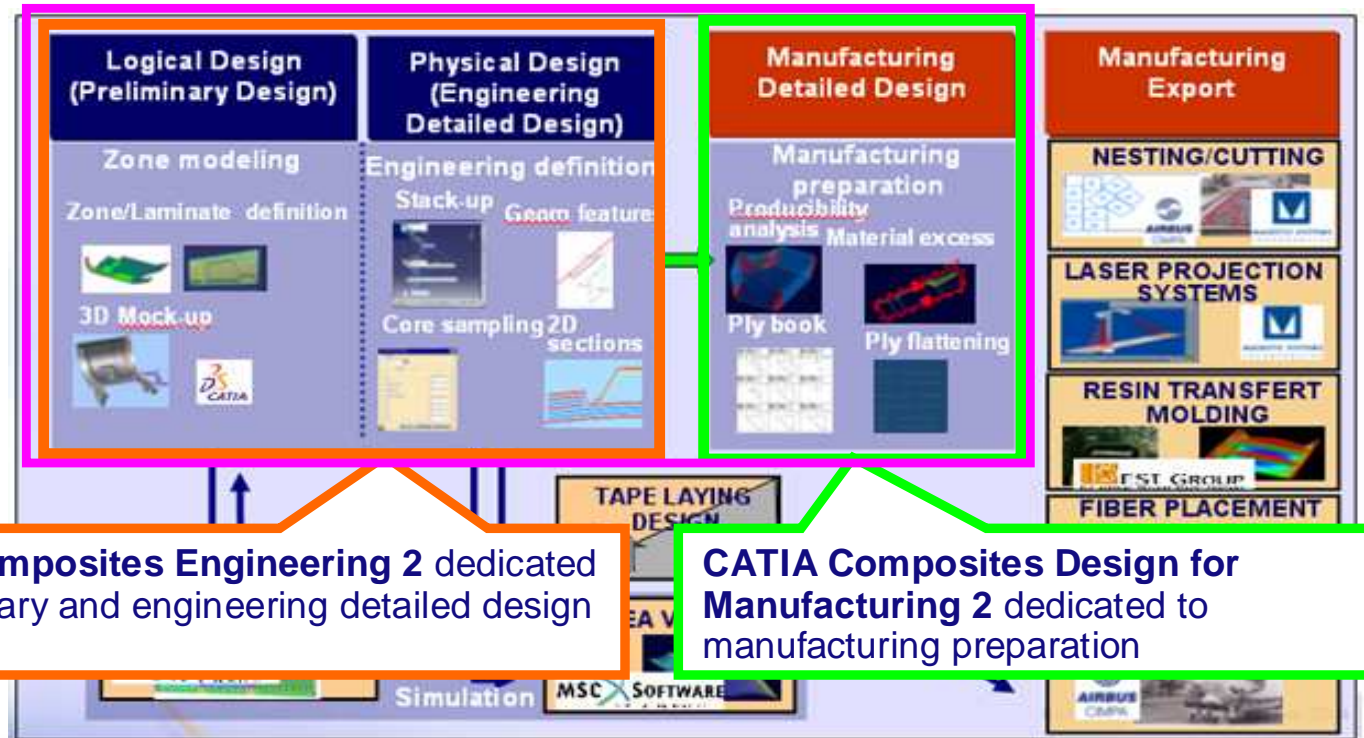

CATIA - Composites Engineering (CPE)

Productive process oriented environment dedicated from preliminary to engineering detailed design of composite parts

Benefits

- **Fully integrated in the V5 environment**
- **Shortened part composite part design time period** (up to ten times faster)
- **Fast plies generation from zones** (automatic management of the ply staggering and stacking rules)
- **Design right first time** by taking into account manufacturing constraints early in the design phase
- **Easy concurrent work** thanks to true collaborative composites engineering environment

Capabilities

- **Easy to use zone** (geometry and laminate) and **transition zones modeling** definition
- **Powerful ply modeling tools** based on 3D features
- **Complex geometrical configuration support**
- **Solid generation from zones and plies** (exact solid)
- **Complete composites inspection tools** (core sample and numerical analysis, ply table..)
- **Best-in-class fiber simulation** tools for early manufacturability assessment
- **Easy know-how and composites design features sharing and merging**

Developed in part with industry leader

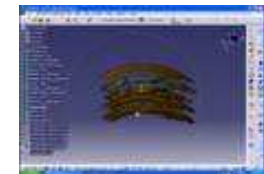
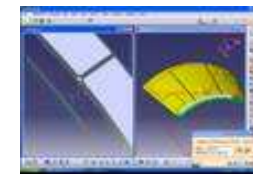
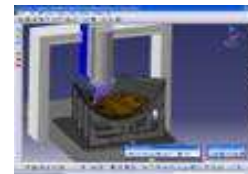
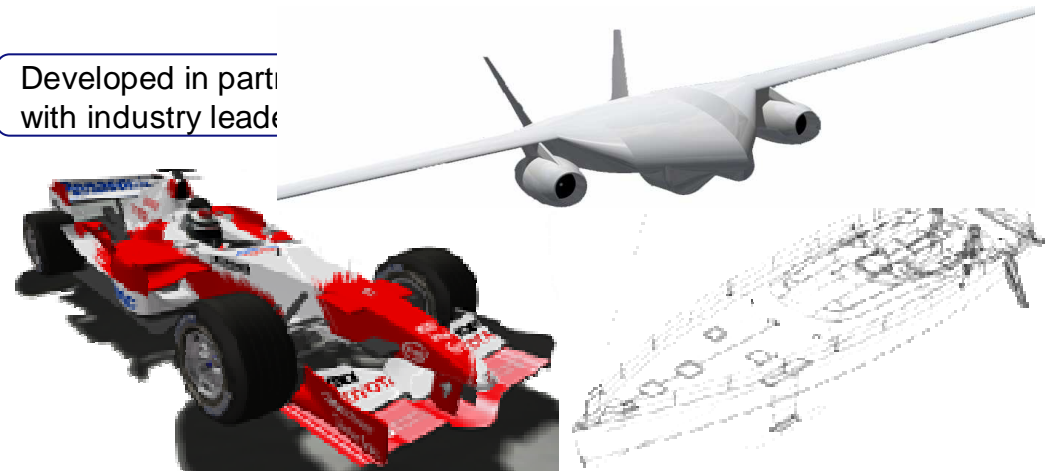

CATIA - Composites Manufacturing (CPM)

Productive process oriented environment dedicated to manufacturing detailed design of composite parts

Benefits

- **Fully integrated in the V5 environment**
- **Design right first time** by taking into account manufacturing constraints early in the design phase
- **Easy collaboration between design and manufacturing offices** enabling concurrent engineering
- **Strong manufacturing partnerships** ensure that composites solution can be used by any company, regardless of the manufacturing process and machine providers

Capabilities

- **Dedicated manufacturing part modeling** capabilities such as manufacturing shell swapping, material excess definition and 3D multi-splice
- **Best-in-class fiber simulation and flattening tools** for early assessment of manufacturability
- **Effective manufacturing export capabilities and automatic shop floor documentation**
- **Powerful synchronization/collaboration mechanisms** with engineering detailed design

One system to cover overall composite manufacturing along with DS leading partners

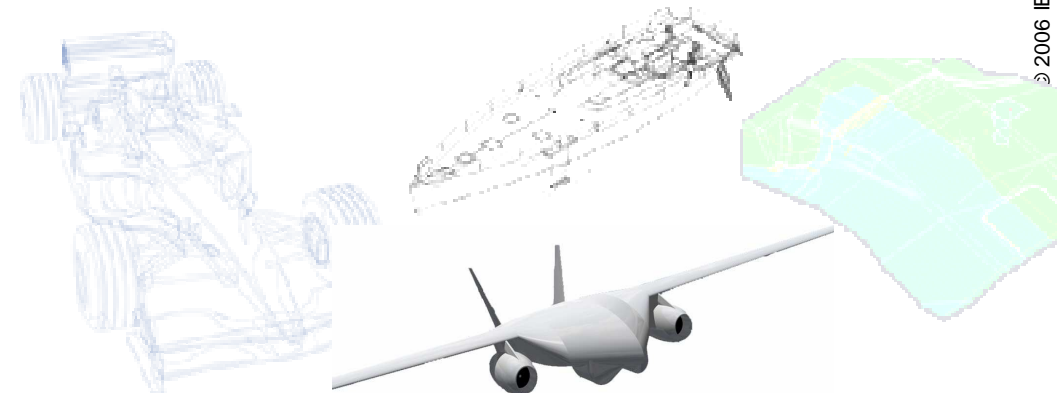

© 2006 IBM Corporation

CATIA PLM V5 Composites Solutions (2)

■ CAA V5 Market-leading Partners Expertise to complement the V5 Composites Offering

- **Hand Lay-up Solution** : Advanced Fiber Modeler (Simulayt), Quickform (ESI), TruLaserView (Magestic), TruNest (Magestic), Composite Link (Simulayt)
- **RTM Solution** : PAM-RTM (ESI Group)
- **Tape Laying / Fiber Placement Solution** : Torlay (Mtorres), Tapelay (CIMPA), iCPS (Ingersoll), ACE V2 (Cincinnati)

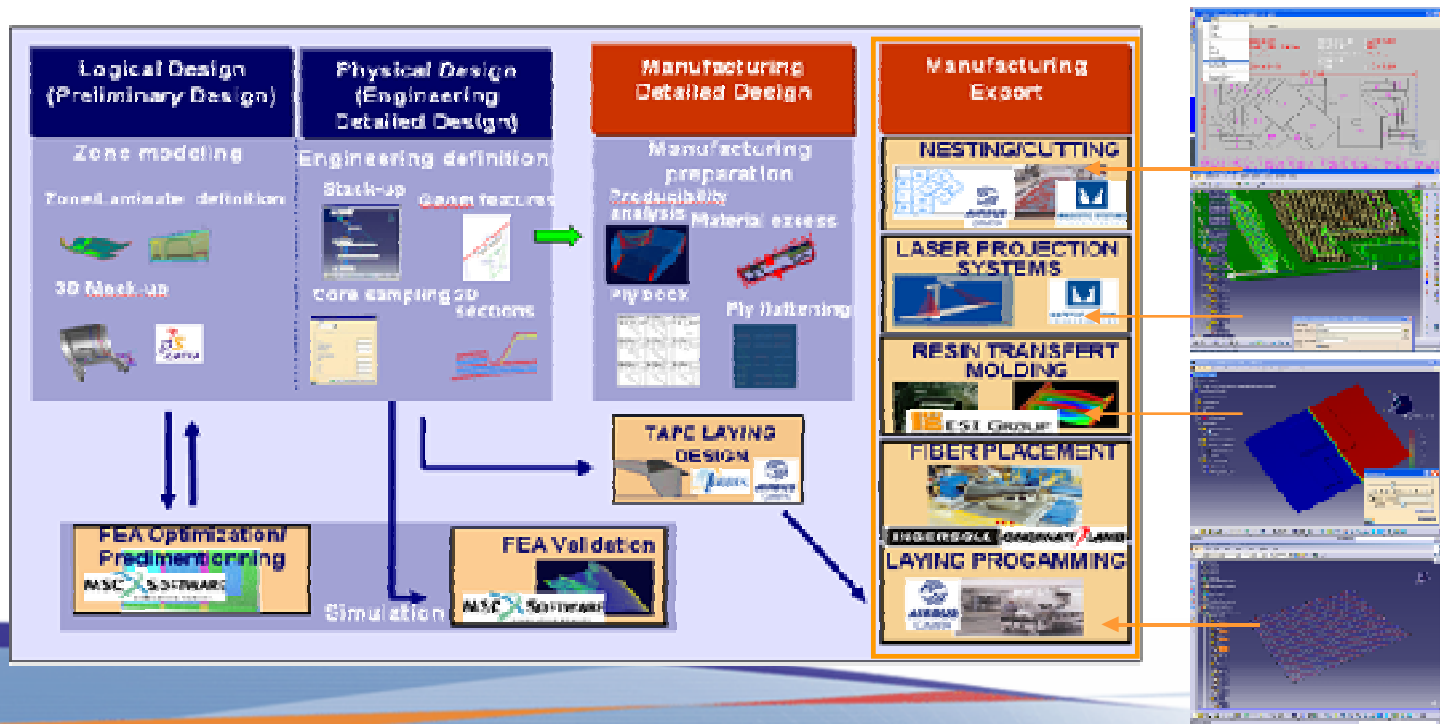

Improve Productivity

- Preliminary design
- Engineering detailed design
- Manufacturing preparation
- Downstream Manufacturing

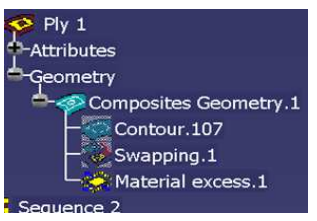
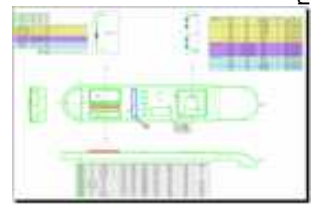
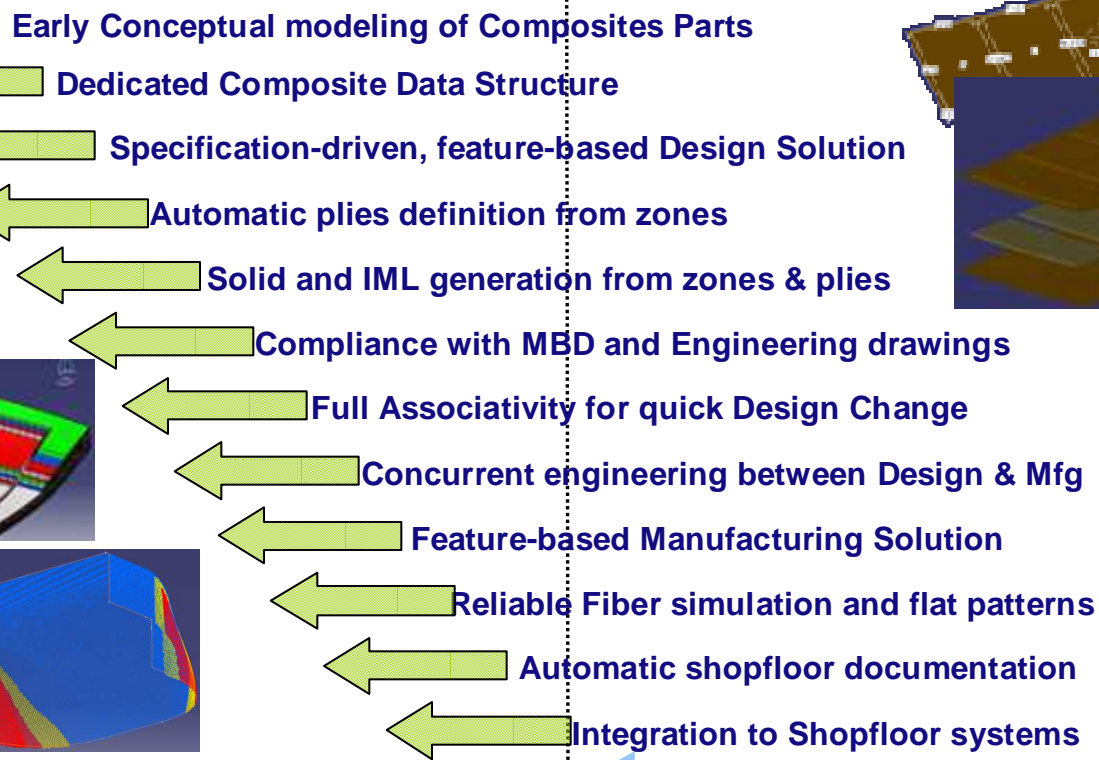
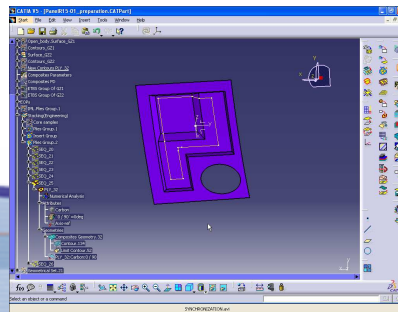
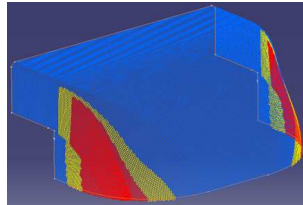
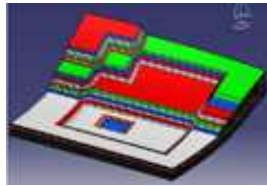
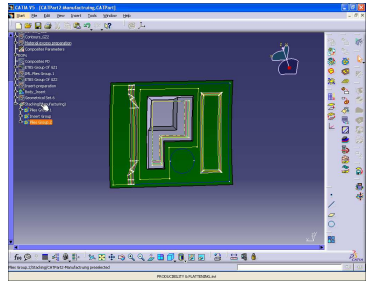

Productivity Gain

Reduce initial design time by 40%

Cut manufacturing design time in half

Cut design modifications cycle by 60%

Reduce lay-up time by 70%



Facilitate Innovation

Eliminate basic repetitive design work to focus more on innovation

- Specification-driven process and feature-based approach help reduce tedious tasks
- Add knowledge-based engineering to your design to capitalize on your know-how : Design rules and checks, parameters and formulas, Design optimization,...
- Capture your design intent into Automation Templates and reuse this knowledge across the families of parts or features: User Defined Features, Powercopy, Part Templates,...
- Benefit from the openness of the Composites architecture to further customize the process (CAA V5, VB)

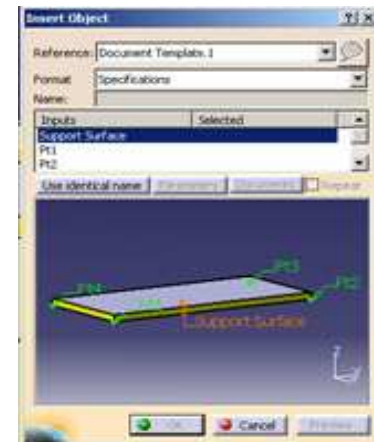
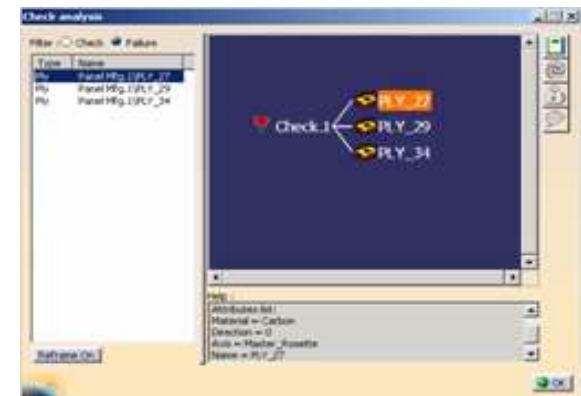
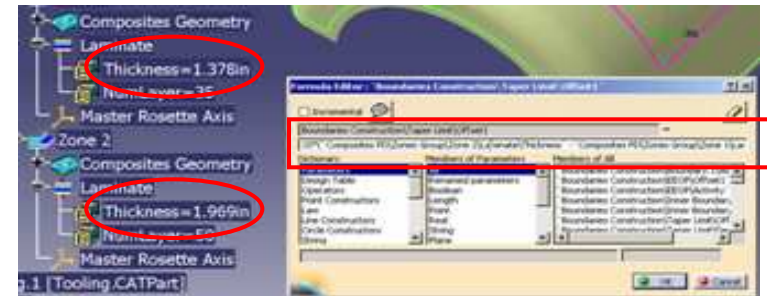

Reduce design cycle by 200% using Templates

Cut Trades Studies time by half

Integrate the Company know-how to improve competitiveness

Apply Company Standards

Ensure Manufacturability, Quality

Eliminate the Trial & Error and costly change orders

- Early incorporation of Manufacturing constraints
- Upfront Simulation of Manufacturing Procedures (Lay-up, Laser Projection, NC, Resin Injection ...)
- Direct Integration with the Shop Floor systems

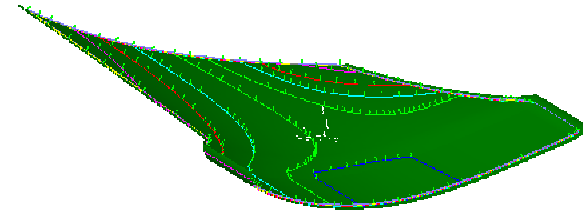

Optimize Parts Quality

- Full associativity from Design to Manufacturing ensures data consistency
- Integrated FEA properties transfer helps avoid errors and shortens optimization cycles to eliminate overdesign
- Reliable Producibility Analysis and Flat Patterns Generation significantly reduce material waste

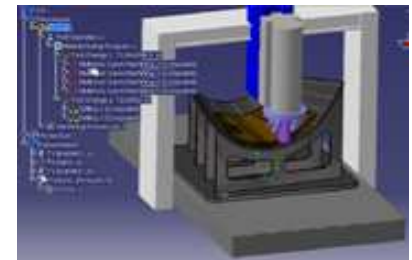

© 2006 IBM Corporation

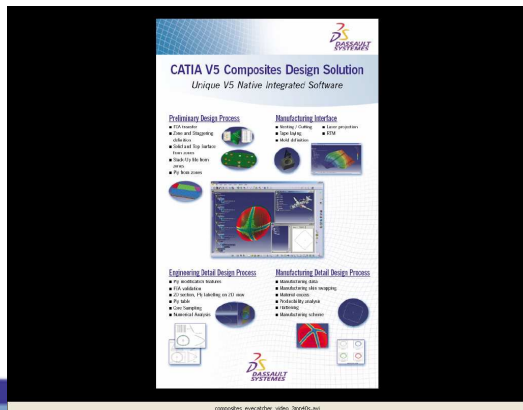

Decrease the number of change orders by over 90%

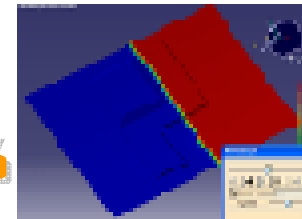

Cut material waste by 35%

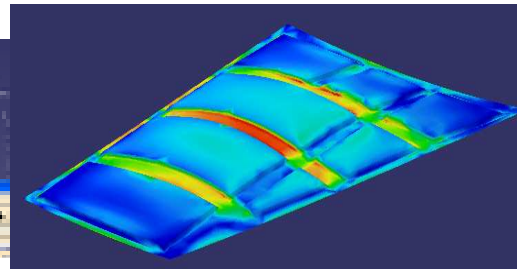

Optimize Weight and Strength

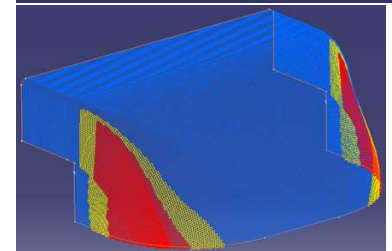

CATIA - Composites Design (CPE)

Preliminary Design



Key Features :

- Composite Parameters definition : V5 Catalog of Composite materials, Fiber Directions
- Zones definition : Structural Zones Geometry, Laminate Import, Transition Zones definition for drop-off areas
- Design Checks : Connection Generator
- Solid & Top Surface from Zones

Key Benefits :

- Conceptual Definition very early in the lifecycle of the program
- IML generation for concurrent Engineering on sub-structures
- Ability to generate intermediate surfaces needed as support for further tasks (ex : core creation for core stiffened panel)
- Solid generation for DMU, FTA, Drafting purpose
- Link the Composite Design to FEA at the Preliminary Design stage

Material	Orientation	Z1-1	Z2-1	Z3-1	Z4-1	Z5-1	Z6-1	Z7-1	Z8-1
S1454_G900	0	3	1	1	1	1	1	1	1
S1454_G900	45	1	1	1	1	1	1	1	0
U174_T900	90	0	0	0	0	0	0	0	0
Adhesive	0	0	1	0	1	0	1	0	0

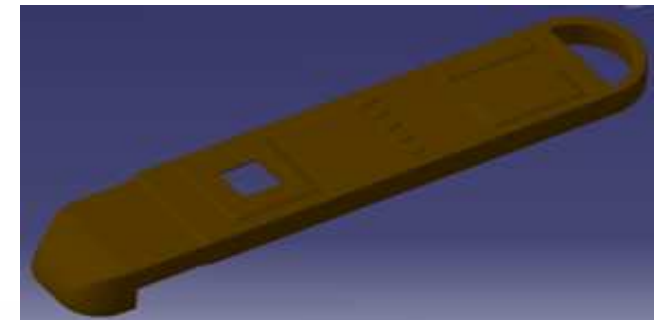
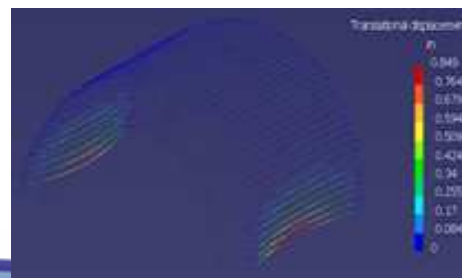
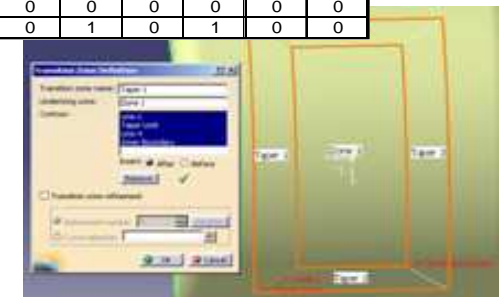

CATIA - Composites Design (CPE)

From Conceptual to Detailed Design

- **Key Features :**
 - Stack-up file export : Stacking Order optimization, Logical zones combinations
 - Plies creation from Zones with Tapers : Direct Staggered definition
 - Plies with Staggering value : Assisted staggering of Plies, Staggering Report, Dedicated features, Variable drop-off, Plies Crossing

- **Key Benefits :**
 - Automated plies generation from Zones
 - Staggered definition of plies using tapers, or user-defined staggering with report and dedicated features



Sequence	Ply	Geo-Lvl	Material	Zone 1	Zone 2
Sequence 1	Ply 1	32	GLASS	0	0
Sequence 2	Ply 2	15	GLASS	90	90
Sequence 3	Ply 3	34	GLASS	45	45
Sequence 4	Ply 4	23	GLASS	-45	-45
Sequence 5	Ply 5	14	GLASS	90	90
Sequence 6	Ply 6	16	GLASS	0	0
Sequence 7	Ply 7	27	GLASS	45	45
Sequence 8	Ply 8	22	GLASS	-45	-45
Sequence 9	Ply 9	5	GLASS	0	0
Sequence 10	Ply 10	13	GLASS	90	90
Sequence 11	Ply 11	26	GLASS	45	45
Sequence 12	Ply 12	24	GLASS	-45	-45
Sequence 13	Ply 13	10	GLASS	90	90
Sequence 14	Ply 14	31	GLASS	0	0
Sequence 15	Ply 15	35	GLASS	45	45
Sequence 16	Ply 16	33	GLASS	45	45
Sequence 17	Ply 17	12	GLASS	90	90
Sequence 18	Ply 18	15	GLASS		45
Sequence 19	Ply 19	13	GLASS		90
Sequence 20	Ply 20	11	GLASS		-45

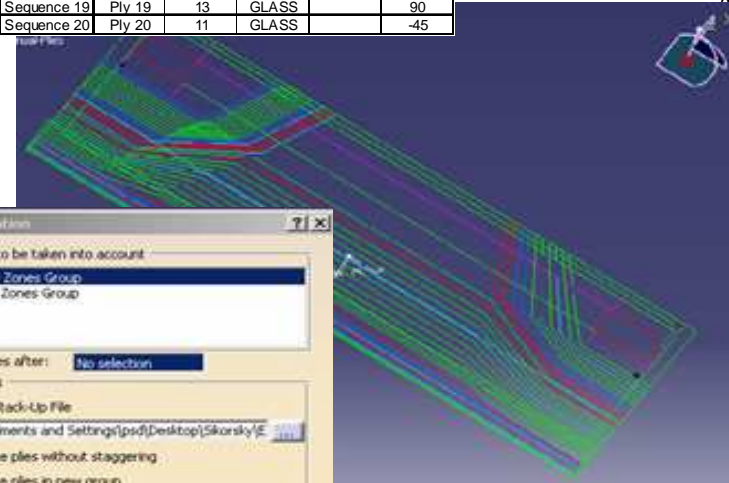
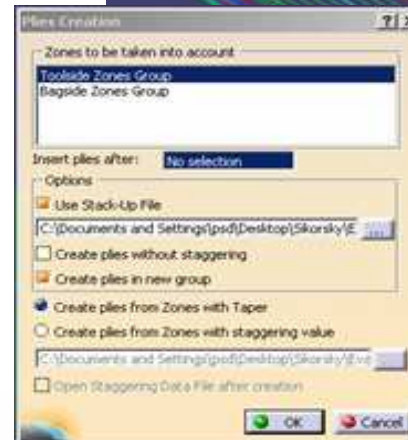
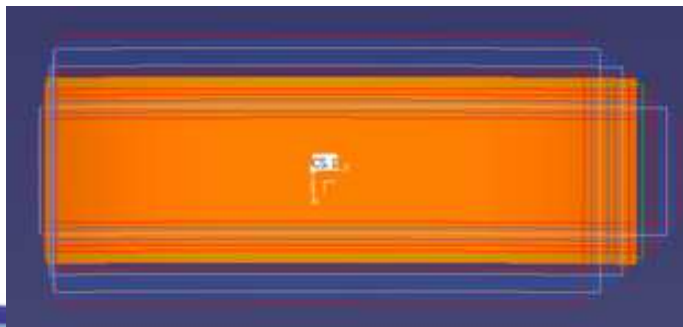

CATIA - Composites Design (CPE)

Engineering Detailed Design

Key Features :

- Manual Plies Groups, Plies (Adhesive, Bonding strips) and Core Creation
- Design Checks : Core Sampling, Numerical Analysis, Stacking Table
- Export to external Files
- Exact Solid and Smooth IML from Plies
- Exploded Surfaces



Key Benefits :

- Second entry-level in the Composites process for non-structural entities
- Dedicated Features for Data Integrity and Design Validation
- Refined Solid from Plies for DMU
- Smooth IML for Tooling and Relational Design

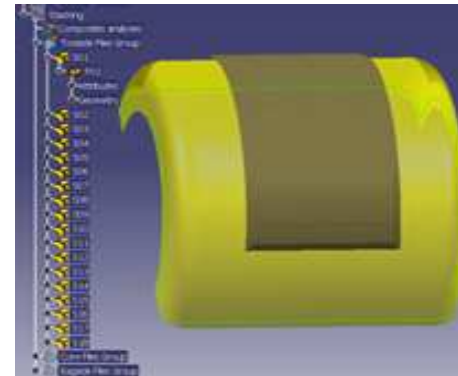

Sequence	Ply	Material	Direction	Local Rosette
Sequence 1	Ply 1	GLASS	0	Master Rosette Axis
Sequence 2	Ply 2	GLASS	90	Master Rosette Axis
Sequence 3	Ply 3	GLASS	45	Master Rosette Axis
Sequence 4	Ply 4	GLASS	-45	Master Rosette Axis
Sequence 5	Ply 5	GLASS	90	Master Rosette Axis
Sequence 6	Ply 6	GLASS	0	Master Rosette Axis
Sequence 7	Ply 7	GLASS	45	Master Rosette Axis
Sequence 8	Ply 8	GLASS	-45	Master Rosette Axis
Sequence 9	Ply 9	GLASS	0	Master Rosette Axis
Sequence 10	Ply 10	GLASS	90	Master Rosette Axis
Sequence 11	Ply 11	GLASS	-45	Master Rosette Axis
Sequence 12	Ply 12	GLASS	45	Master Rosette Axis
Sequence 13	Ply 13	GLASS	90	Master Rosette Axis
Sequence 14	Ply 14	GLASS	0	Master Rosette Axis
Sequence 15	Ply 15	GLASS	45	Master Rosette Axis
Sequence 16	Ply 16	GLASS	45	Master Rosette Axis
Sequence 17	Ply 17	GLASS	90	Master Rosette Axis
Sequence 26	Ply 26	GLASS	-45	Master Rosette Axis
Sequence 34	Ply 34	GLASS	90	Master Rosette Axis
Sequence 35	Ply 35	GLASS	45	Master Rosette Axis
Sequence 36	Ply 36	GLASS	45	Master Rosette Axis
Sequence 37	Ply 37	GLASS	0	Master Rosette Axis
Sequence 38	Ply 38	GLASS	90	Master Rosette Axis
Sequence 39	Ply 39	GLASS	-45	Master Rosette Axis
Sequence 40	Ply 40	GLASS	45	Master Rosette Axis
Sequence 41	Ply 41	GLASS	90	Master Rosette Axis
Sequence 42	Ply 42	GLASS	0	Master Rosette Axis
Sequence 43	Ply 43	GLASS	-45	Master Rosette Axis
Sequence 44	Ply 44	GLASS	45	Master Rosette Axis
Sequence 45	Ply 45	GLASS	0	Master Rosette Axis
Sequence 46	Ply 46	GLASS	90	Master Rosette Axis
Sequence 47	Ply 47	GLASS	-45	Master Rosette Axis
Sequence 48	Ply 48	GLASS	45	Master Rosette Axis
Sequence 49	Ply 49	GLASS	90	Master Rosette Axis
Sequence 50	Ply 50	GLASS	0	Master Rosette Axis

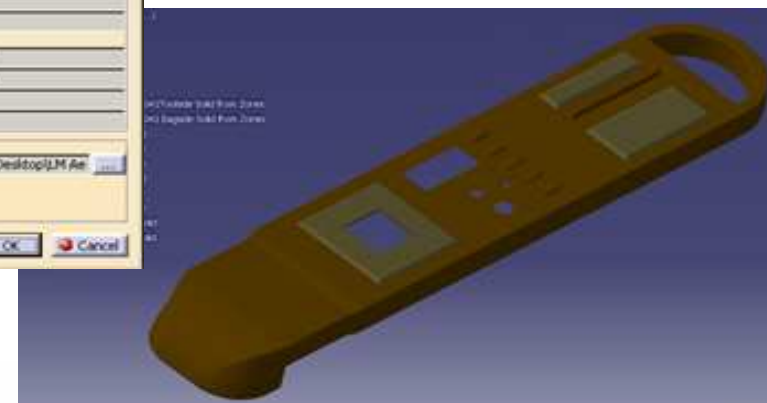
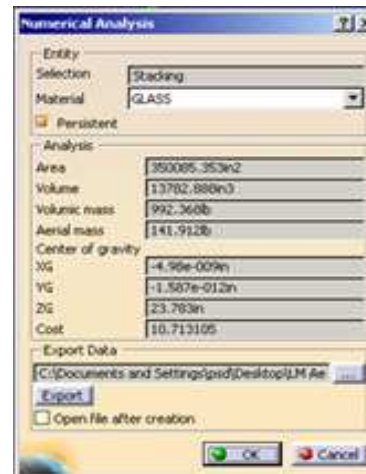

CATIA – Mechanical Design

Engineering Drawings

■ Key Features :

- Drawing views and section cuts creation
- Generative View style options to visualize solids, plies boundaries and/or exploded surfaces, flat patterns and Export to external Files
- Annotation Templates for Plies and Cut-pieces labelling
- Embedded Sheets for Ply Table, Core samples, Numerical Analysis, etc...

■ Key Benefits :

- Associativity of 2D Composites Drawings with 3D Design
- Dedicated Labeling of Composites entities

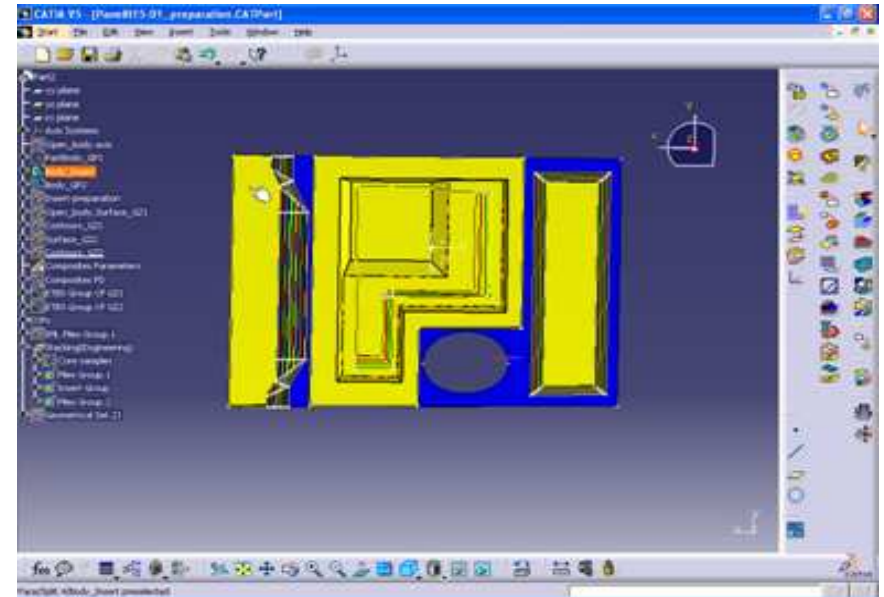

CATIA – Product Review (DMU)

Enabling Model Based Definition

Key Features :

- Browsing the complete Stacking data structure : List of Plies Groups, Plies, Cores with associated attributes
- Visualization of all Composites Geometries, Exploded Surfaces, Solids and IMLs
- 3D Dynamic Sectioning, On Solids and / or Exploded Plies Surfaces
- 3D FTA Annotations

Key Benefits

- Composites Data can be visualized from a Low-end-Viewer as V5 native data by without a Composites license.
- Seamless Communication with cross-functional Disciplines such as Stress, NC or Tooling.

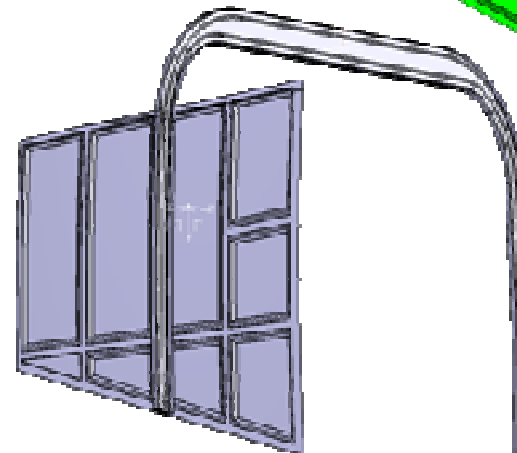
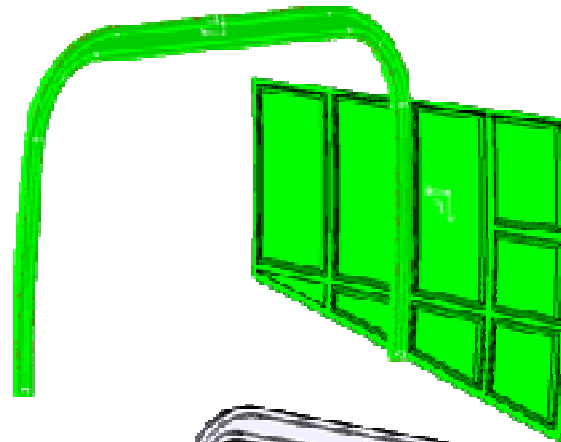

F07:Grapple \$552.IV7 .0075 Woven:

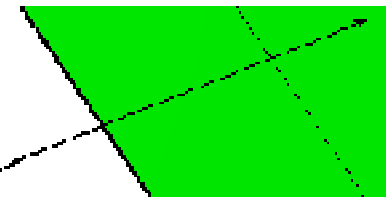

CATIA – Structural Analysis (GPS/EST)

Composite Stress Analysis

Key Features :

- Associative Meshing & Pre-processing in CATIA V5
- Composite Properties Import, from Zones or Plies
- Integrated Elfini Solving & Post-processing : Deformation, Displacements, Stress, Strain, etc ...
- Create Reports and optimize the Part if needed
- LMS Virtual Lab add-on for Nastran deck creation
- Simulayt Composite Link bridge to Abaqus solver

Key Benefits :

- Automatic Composites Properties Transfer from the Design model to the mesh, at Zones level for Pre-dimensionning or at Plies level for Design certification
- Link with Elfini, Nastran and Abaqus solvers

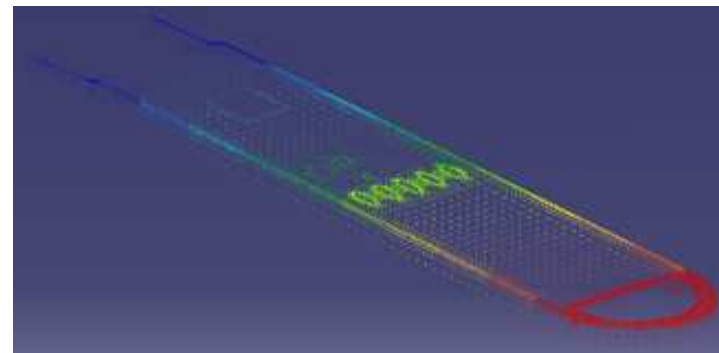
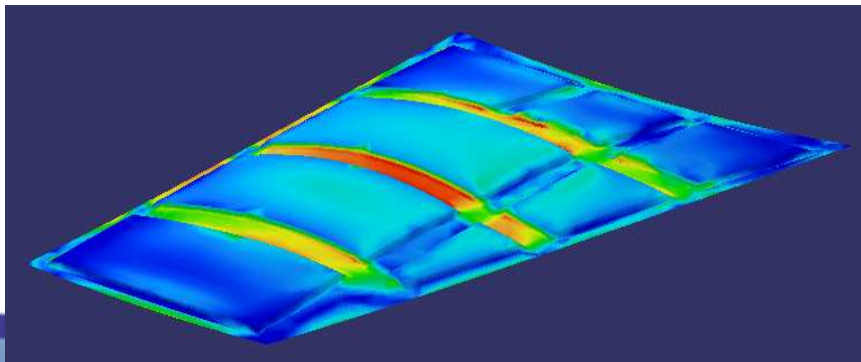
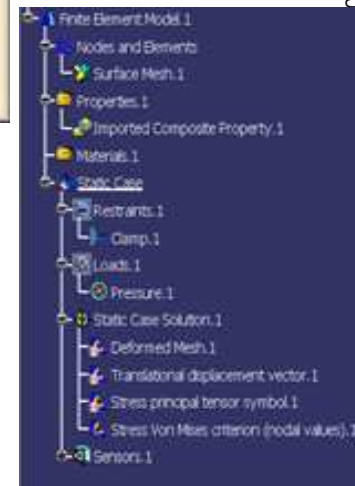
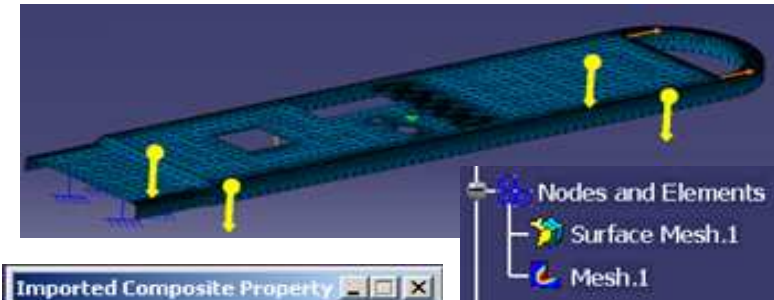

CATIA - Composites Manufacturing (CPM) Manufacturing Preparation

Key Features

- Swapping feature to account for Spring Back
- Material Excess and Extended EOP
- Splicing feature for Material Roll Width with butt-splice and No-splice areas definition

Key Benefits

- Early incorporation of Manufacturing constraints
- Split between Engineering & Manufacturing Parts provides easier Data Management
- Concurrent Engineering between teams improves Productivity

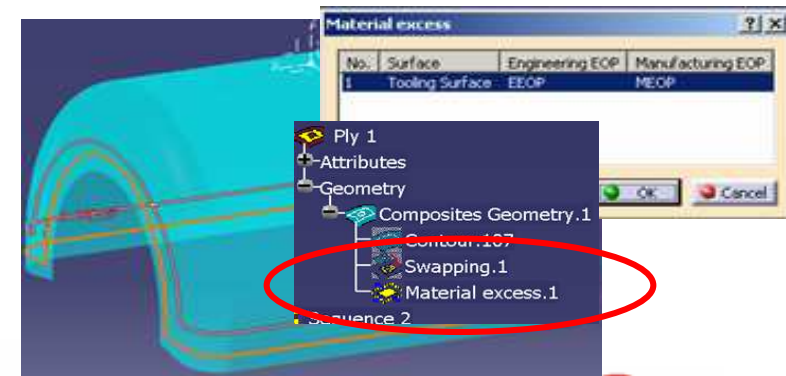
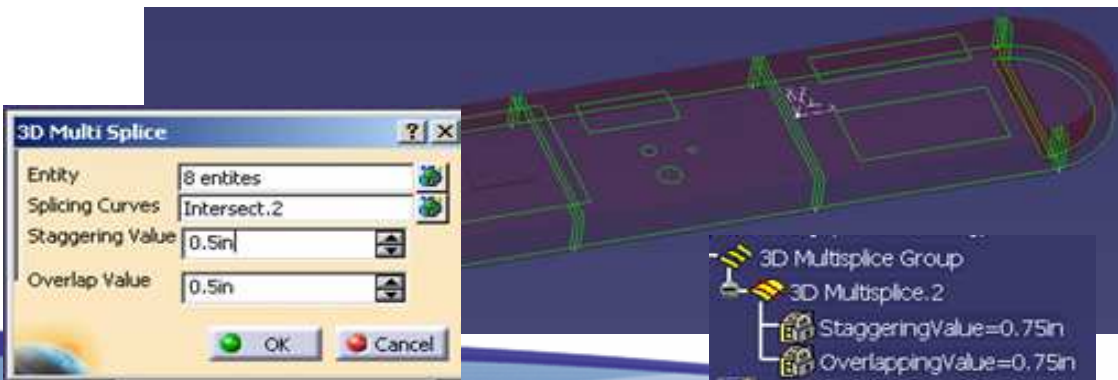
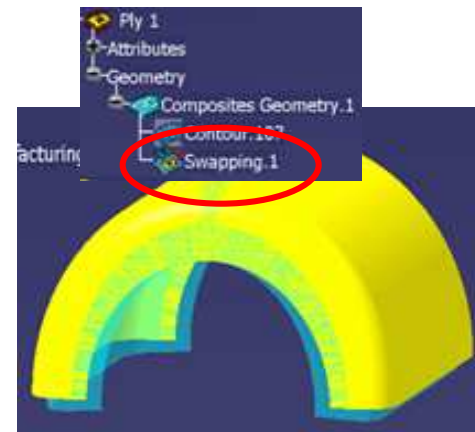
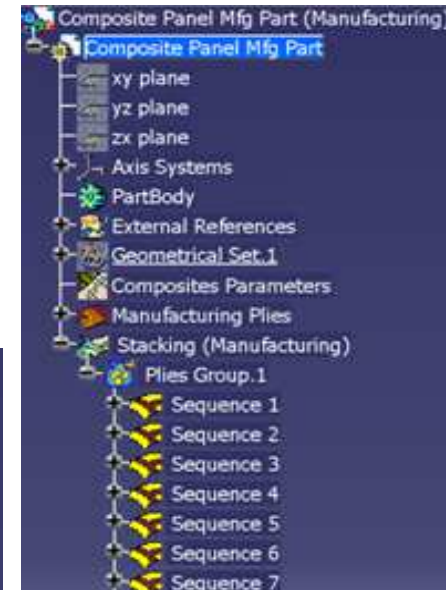

CATIA - Composites Manufacturing (CPM)

Producibility and Flattening

Key Features

- Dedicated Producibility Analysis capability
- Several display modes : Shear Deformation and Fiber Deviation/Rotation
- Several Propagation types : minimum distortion and symmetry
- Thickness Update accounts for draping sequence
- User Defined Darting features
- Inspection Tool
- Plies Flattening
- 2D/3D and 3D/2D Geometry Transfer

Key Benefits

- Early assessment of Fiber Deformations and Deviations
- Reliable Flat Patterns generation eliminates trial and error in floor

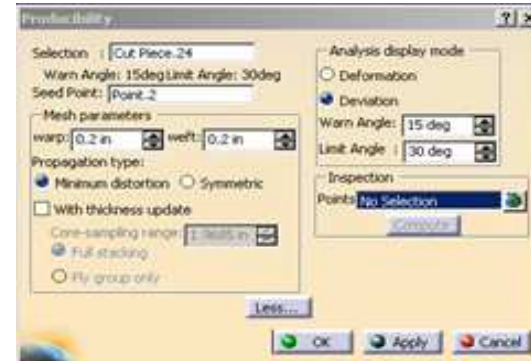

	Actual(deg)	Detail(deg)	Deformation(deg)
Point.68 - 0	-0.964182	0.964182	90.0000
Point.68 - 90	-0.00002421	0.00002421	99.9996
Point.68 - 180	-36.4994	36.4994	107.4423
Point.68 - 270	-87.6063	87.6063	102.2781

Export Data
 [Documents and Settings\pud\Desktop\Skunk\Evaluation\214.dwg] Export

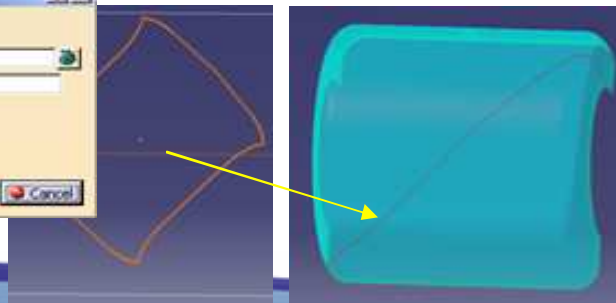
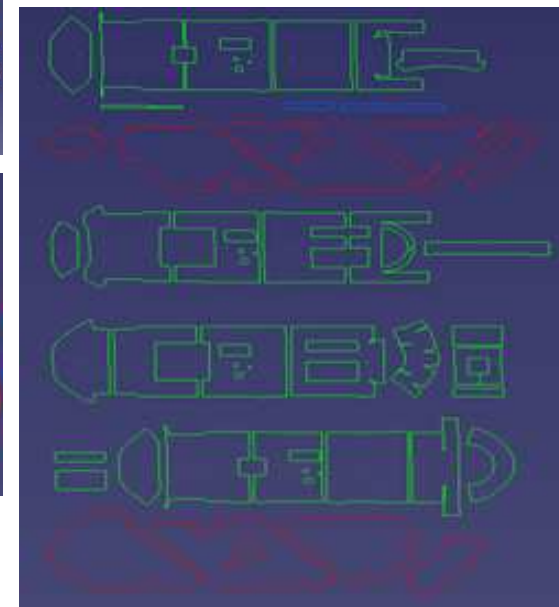
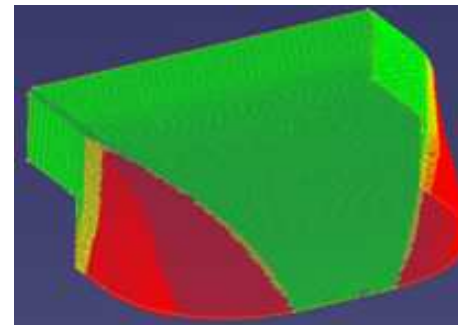
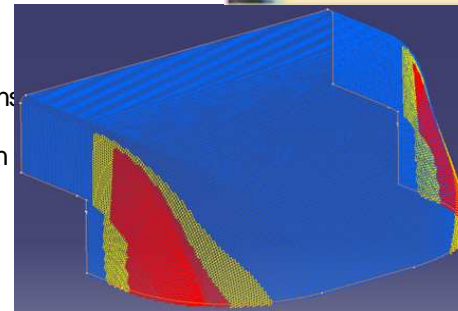

CATIA - Composites Manufacturing

Key partnerships for Fiber Simulation / Flattening



Advanced Fiber Modeler (AFM)

- Key Features :
 - Seed Curve and Order of Drape specification
 - Optimized propagation types
 - Instant flat patterns display
 - Accounts for surface topology, draping sequence and darts
- Key Benefits :
 - Cutting-edge add-on for advanced Producibility and Flattening, fully integrated to CATIA V5
 - Simulates fabric draping on complex surfaces

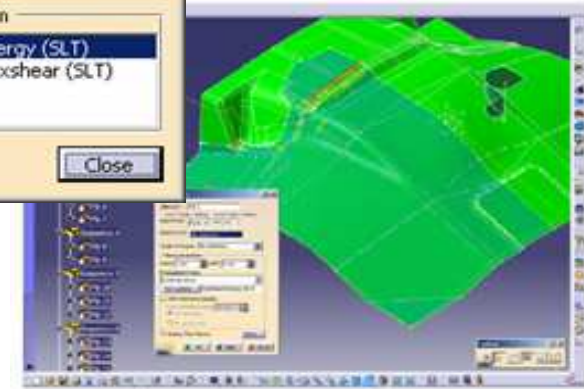

© 2006 IBM Corporation

Pam-Quickform

- Key Features :
 - Unique Unidirectional Simulation with control of maximum shearing angle and spreading
 - Seed Curve specification
 - Instant flat patterns display
- Key Benefits :
 - Dedicated Bidirectional and Unidirectional Fiber Simulation and Flattening Solution, fully integrated to CATIA V5



Minimum distortion
Symmetric
PAM-QUIKFORM Bidirectional
PAM-QUIKFORM Unidirectional
External solve

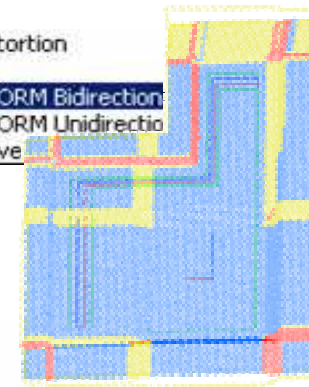

CATIA - Composites Manufacturing

Downstream Manufacturing for Hand Lay-up

Key Features

- 2D Ply Book
- 3D Dynamic Ply Book to support 3D Master
- Neutral DXF and IGES export of all 2D Flat Patterns and 3D Geometry
- CAA V5 TruNest (Magestic Systems)
- CAA V5 Panogen (CIMPA)
- CAA V5 TruLaserView (Magestic Systems)

Key Benefits

- Automatic 2D and 3D Shopfloor documentation
- Neutral Export to the Shop floor systems
- Dedicated CAA V5 Partner applications for Nesting/Cutting and Laser Projection to address major production systems

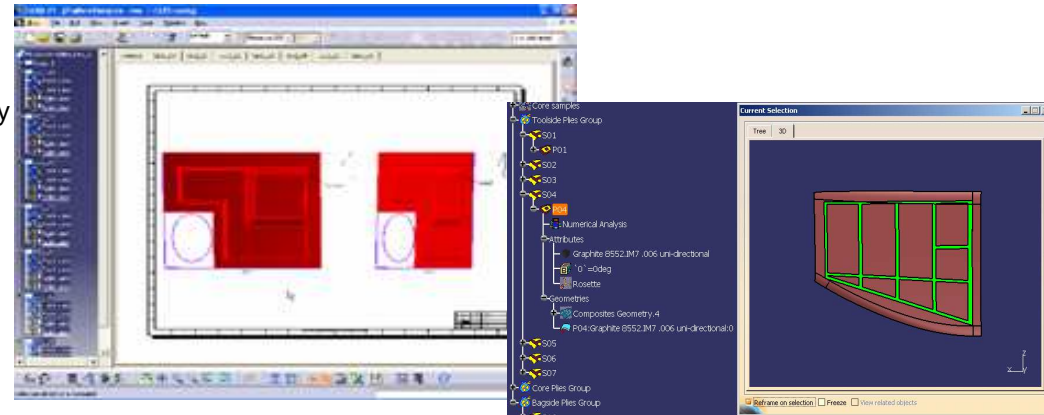

Name	Size	Type
Ply_45_P1454_G814_60.dxf	32 KB	DXF File
Ply_45_P1454_G814_60.igs	20 KB	IGS File
Ply_45_P1454_G814_60.Flat.igs	29 KB	IGS File

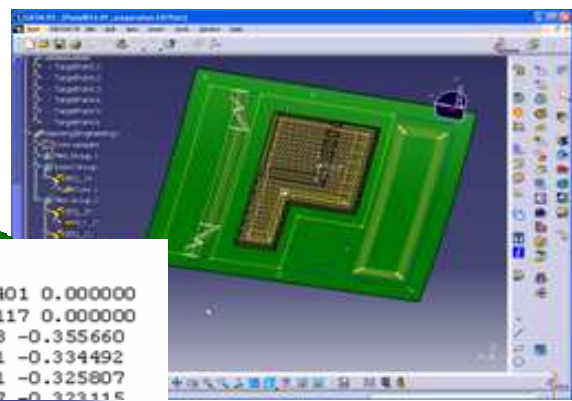
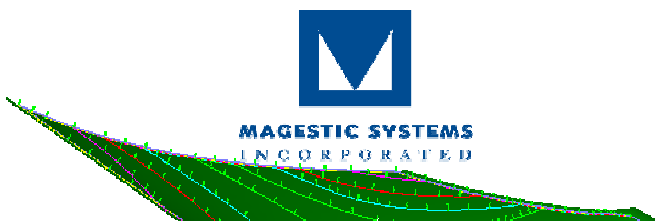

```
START Sequence.1-Ply.1
P 21
-5.077202 -11.709691 19.443072 -0.298528 0.954401 0.000000
-3.113200 -11.083891 66.465235 -0.308830 0.951117 0.000000
0.249138 -9.263305 68.076389 -0.311810 0.881068 -0.355660
3.810866 -7.446909 69.318408 -0.345120 0.876931 -0.334492
6.621364 -6.043586 69.989234 -0.370275 0.869911 -0.325807
8.484802 -4.601435 70.433454 -0.387638 0.858267 -0.323115
```

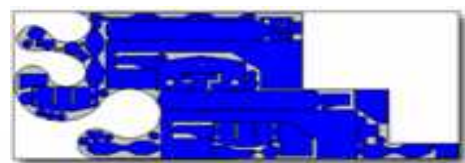
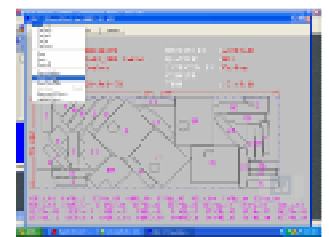

CATIA - Composites Manufacturing

Downstream Manufacturing for Automated Processes

■ Key Features

- CAA V5 PAM-RTM (ESI Group) to predict the filling of a mold during RTM process and control injection parameters such as time, pressure or temperature.
- Dedicated Solutions to address the main Tape Laying and Fiber Placement machines Providers :

- *Integrated CAA V5 Pan-PRT Solution (CIMPA) for Tapes Design & Manufacturing*
- *Integrated CAA V5 TORLAY (MTorres)*
- *Integrated CAA V5 iCPS (Ingersoll)*
- *CAA V5 ACE V2 Interface (Cincinnati)*

■ Key Benefits

- V5 Integrated Resin Injection Simulation Solution
- Integration with highly specialized Manufacturing Applications to address Automated Composites Processes

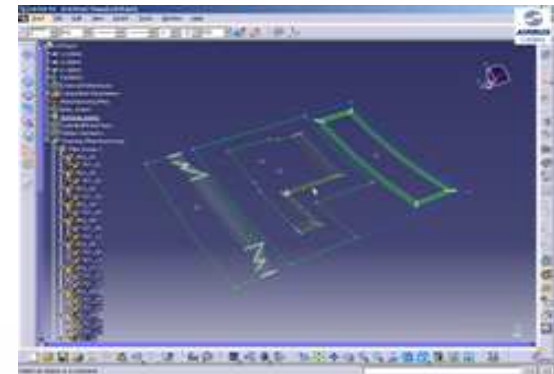
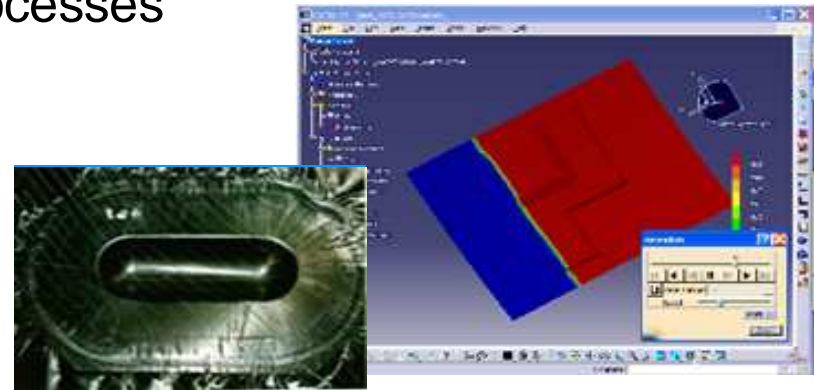

CATIA - Manufacturing

Tooling, NC Machining & Digital Simulation

■ Key Features

- CATIA V5 Tooling Solutions
- CATIA V5 NC programming and Machining from Drilling, Cutting operations
- DELMIA V5 Digital Simulation of processes
 - *Assembly Process Simulation*
 - *Laser Projection Simulation*
 - *Tape Laying / Fiber Placement simulation*

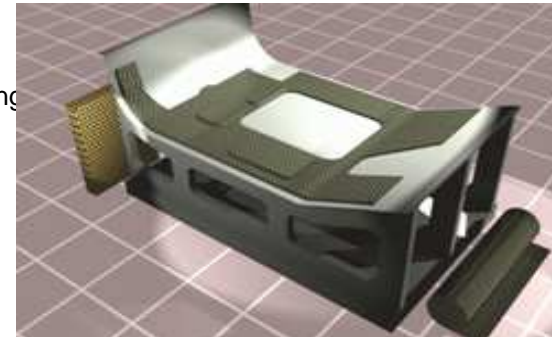

■ Key Benefits

- Unified Platform from Design to Tooling and NC Machining
- Composites Process optimization in context of Product Definition and Resources
- Digital Simulation of all Composites Processes

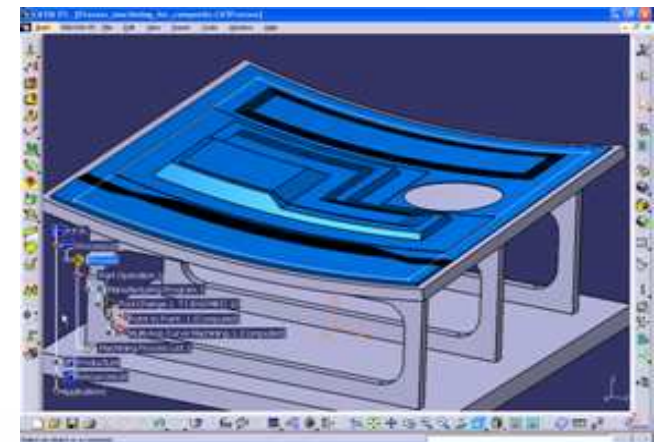
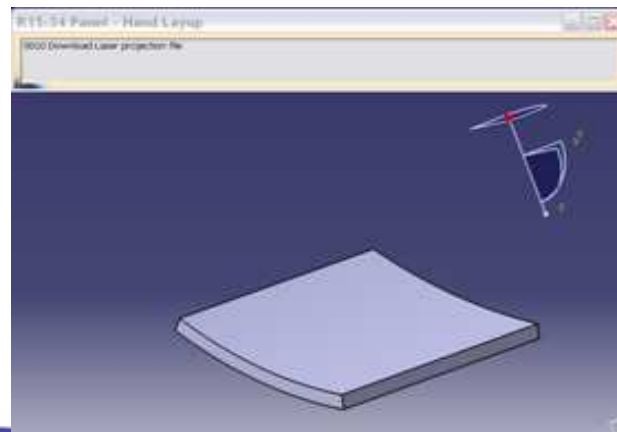

Any Questions?