



IBM Power Sistemlerde Güvenlik : PowerSC

Security and Compliance for
Power Systems

Zuhal AKSÜT

Power Sistemler Teknik Satış Uzmanı

Entegre Servis Yönetimi ve Güvenlik Çözümleri

30 Mayıs 2012, Çarşamba

Grand Hyatt İstanbul



PowerSC Features

PowerSC provides a security and compliance solution to protect datacenters virtualized with PowerVM enabling higher quality services

Business Requirements

- Compliance and Audit
- Guarantee that the OS has not been hacked or compromised in any way
- Ensure that every Virtual System has appropriate security patches
- Compliance and Audit to External Standards

Trusted Logging

The SVM/VIOS capture all LPAR audit log information in real time.

Trusted Boot

Boot images and OS are cryptographically signed and validated using a virtual Trusted Platform Module (vTPM)

Trusted Network Connect and Patch Management

With the Trusted Network Connection protocol imbedded in the VIOS, we can detect any system attempting to access the network and determine if it is at the correct security patch and update level.

Security Compliance Automation

Pre-built compliance profiles that match various industry standards such as Payment Card Industry, DOD and Sox/Cobit. Activated and Reported on centrally using AIX Profile Manager

Capabilities

- ✓ Tamper-proof logs
- ✓ Defense against tampering
- ✓ Notification of unpatched systems
- ✓ Compliance automation and reporting

PowerSC – Security Compliance Automation

Actively Detect Compliance Issues

Business challenge:

Regulatory compliance requires setting security on systems in a uniform manner so they comply to various industry standards. Understanding and applying a particular standard is tedious, time consuming and error prone.

Solution:

Security Compliance Automation provides pre-built profiles that are certified to comply with industry standards like the Payment Card Industry Data Security Standard(PCI) v2, Department of Defense Security Technical Implementation Guide for Unix(DOD STIG) and the Control Objectives for Information and related Technology(COBIT)

Benefits:

- Ability to **set security settings** more many AIX systems in a **repeatable** manner which **reduces** cost for administration
- **Reduces the labor cost** to continue to research changes in the various standards supported by IBM Security Compliance Automation
- Provides **centralized reporting** on an ongoing basis to **demonstrate compliance** to standards for auditing purposes

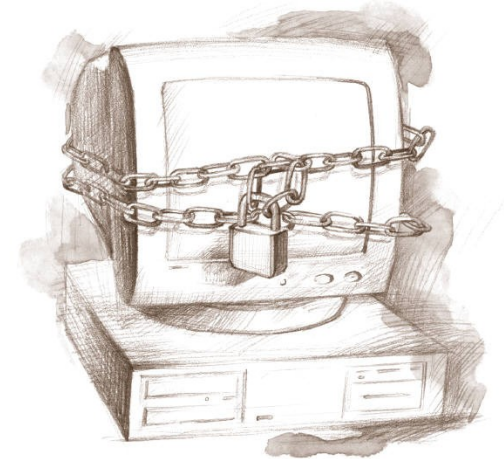

Compliance Automation - Standards

DoD Security Technical Implementation Guide

- Automation of configuration and monitoring for AIX and VIOS in compliance with DoD Unix STIG v5r1 for UNIX <http://iase.disa.mil/stigs/stig/unix-stig-v5r1.pdf>
- 158 pages
- Currently, PowerSC can automate the configuration and monitoring of 90% of all settings required by DoD.



Compliance Automation

Payment Card Industry Data Security Standard v2.0

- Applies to any part of IT that processes, passes or stores credit card information.
(<https://www.pcisecuritystandards.org/>)
- PCI-DSS requirements 70 pages document which describes 12 major security and security configuration sections.
 - Requirement 1: Build and Maintain a Secure Network
 - Requirement 2: Protect Cardholder Data
 - Requirement 3: Protect stored cardholder data
 - Requirement 4: Encrypt transmission of cardholder data across open, public networks
 - Requirement 5: Use and regularly update anti-virus software or programs
 - Requirement 6: Develop and maintain secure systems and applications
 - Requirement 7: Restrict access to cardholder data by business need to know
 - Requirement 8: Assign a unique ID to each person with computer access.
 - Requirement 9: Restrict physical access to cardholder data
 - Requirement 10: Track and monitor all access to network resources and cardholder data.
 - Requirement 11: Regularly test security systems and processes
 - Requirement 12: Maintain a policy that addresses information security for employees and contractors



PowerSC PCI-DSS Coverage

- Approximately 150 xml rules to assist in the configuration in 7 of the 12 requirement areas.

Security Compliance Automation

AIX Profile Manager is a Systems Director plug-in that is designed to simplify consistent AIX configuration across multiple systems

Simplified configuration using the AIX Profile Manager

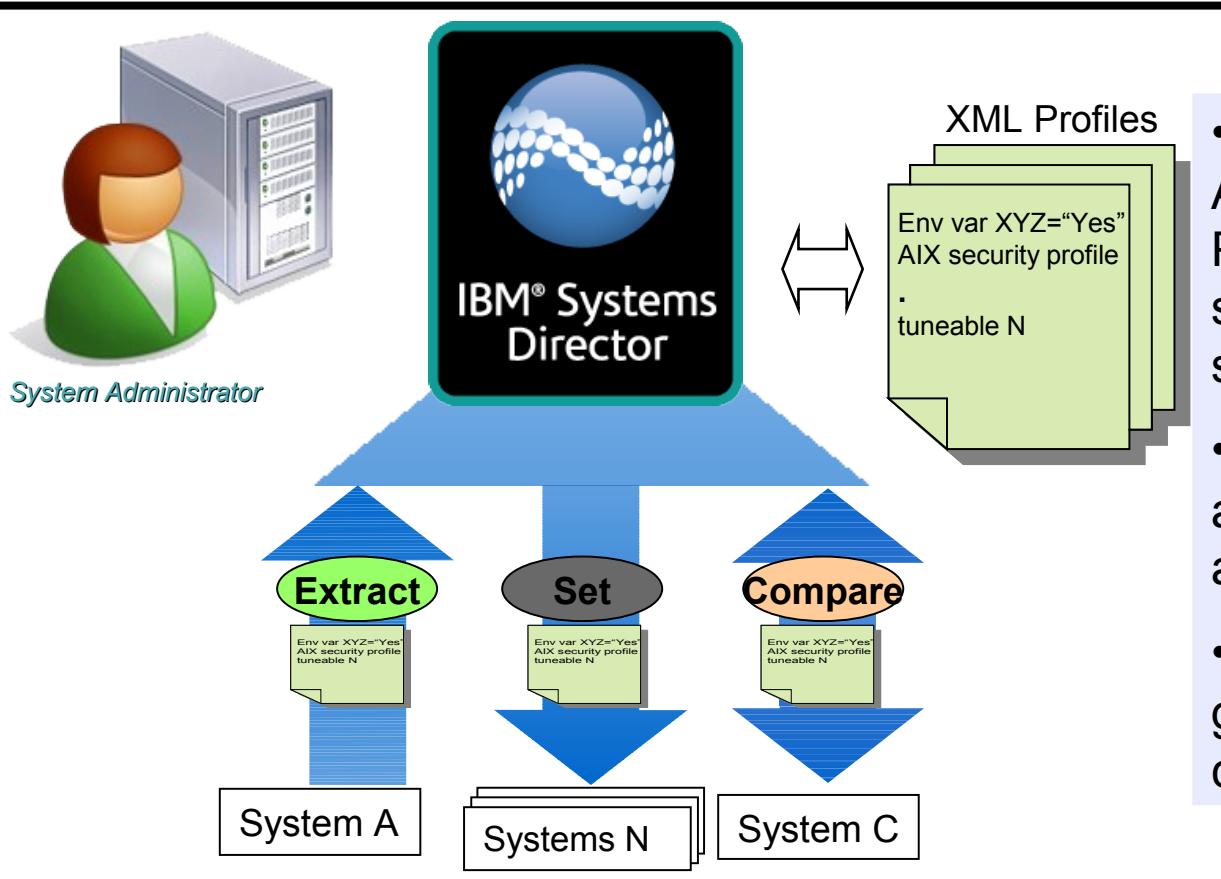

- Security Compliance Automation provides AIX Profiles that set system settings to match supported standards
- The AIX Profile Manager activates these profiles applying the settings
- The AIX Profile Manager can generate reports to show any compliance exceptions

Security Compliance Automation

No extensive logs to read, no guess work.
Simply a clear view of system out of compliance.

The screenshot shows the IBM Systems Director web interface in Mozilla Firefox. The main content area displays a table of system compliance data under the heading 'Navigate Resources'. The table has columns for 'Access', 'Problems', and 'Compliance'. One row is highlighted in red, indicating a 'Critical' compliance issue.

Access	Problems	Compliance	OS Version	Management	Description
OK	OK	OK			
OK	OK	Critical	6.1	None	NativeManag...
Offline	OK	OK	6.1	None	
OK	Information	OK	6.1	None	
No access	OK	OK	6:16	None	NativeManag...

IBM Systems Director welcome page

IBM Systems Director - Mozilla Firefox: IBM Edition

Navigation... X AIX Profile... X VMControl X WPAR Manager X Power System... X

- ✓ **Remote Access** 6.2.1.2
Ready
Setup Remote Control
- ✓ **Storage Management** 6.2.1.2
Ready
SMI-S Providers Systems And Volumes
Storage Subsystems And Volumes
- ✓ **Network Management** 6.2.1.2
Ready
View all network systems
- BladeCenter and System x Management** 6.2.1.2
Additional plug-ins are required before BladeCenter chassis can be fully managed.
Setup required for I/O module plug-ins BladeCenter chassis and members
Servers and service processors
- ✓ **Power Systems Management** 6.2.1.2
Ready
AIX/Linux virtual servers IBM i virtual servers
- ✓ **System z Management** 6.2.1.2
Ready
z/VM hosts Linux on System z
- ✓ **AIX Profile Manager** 1.1.0.0
6 Systems are AIX Profile Manager capable.
Navigate resources View and Collect Inventory

Distributed with AIX 6.1 TL 6 & 7.1 standard and enterprise editions
Installation: run APMgrSetup.sh

Entegre Servis Yönetimi ve Güvenlik Çözümleri

AIX Profile Manager

IBM Systems Director - Mozilla Firefox: IBM Edition

AIX Profile Manager

The configuration is configurable thresholds. Clicking on the link will perform an immediate configuration status check on all systems.

Common tasks

- View and manage profiles
- View and Manage templates
- View and manage systems
- View and manage compare results
- View and manage retrieve results
- View event log

Perform an immediate configuration status check on all systems

PowerSC – Trusted Logging

Protecting, centralizing logs for Virtual Machines

Business challenge:

Security Compliance mandates strict control over system audit logs. Virtualized and Cloud workloads complicate this mandate.

Solution:

Trusted Logging provides **secure centralized protection** for AIX audit and system logs and is integrated with PowerVM virtualization.

Benefits:

- Auditors are assured that Administrators for an AIX VM cannot delete audit trails
- Easy manageability: Centralized audit logs are easier to backup, archive and manage
- Centralized logging ensures that even when virtual machines are discarded the audit logs remain on the central location for audit purposes.

PowerSC Trusted Logging

How does it work?

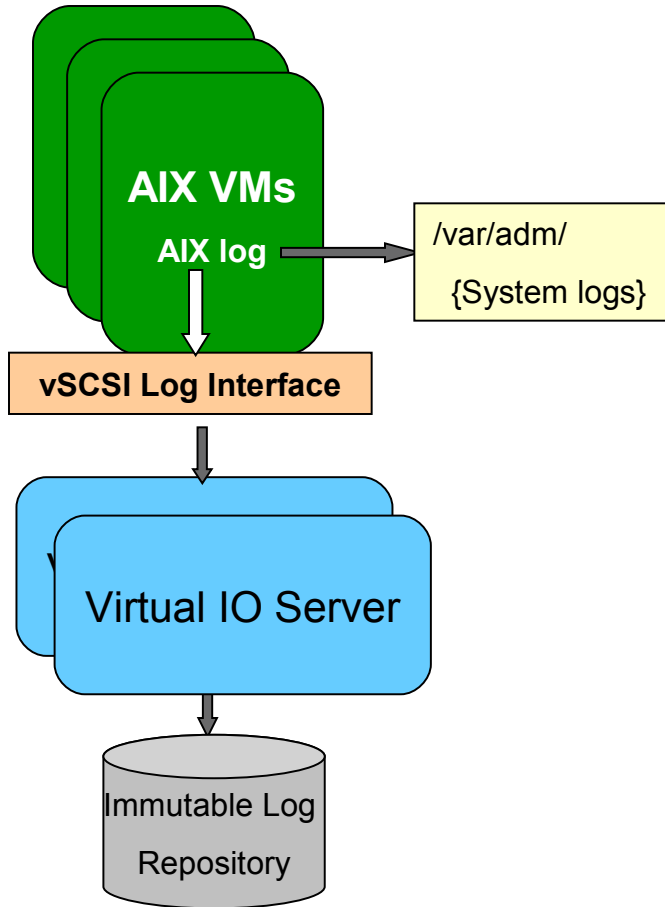

- AIX Logs use a Special Log Virtual SCSI Device
- Log Virtual SCSI device is created and managed by VIOS
- Logging data is written to an Immutable Repository or storage connected to the VIOS Server
- As the data is stored the AIX VM cannot alter or remove logs owned by VIO Server
- Normal AIX Logs in the VM are still available as well

PowerSC Trusted Logging

Basic configuration:

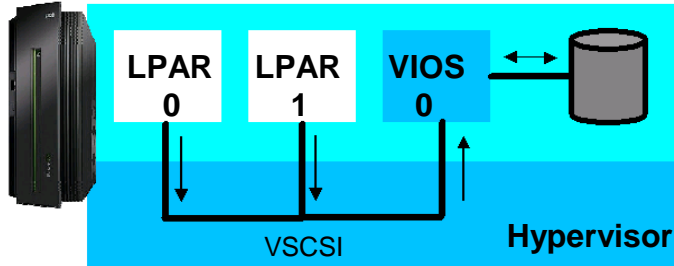

Clustered VIOS configuration:

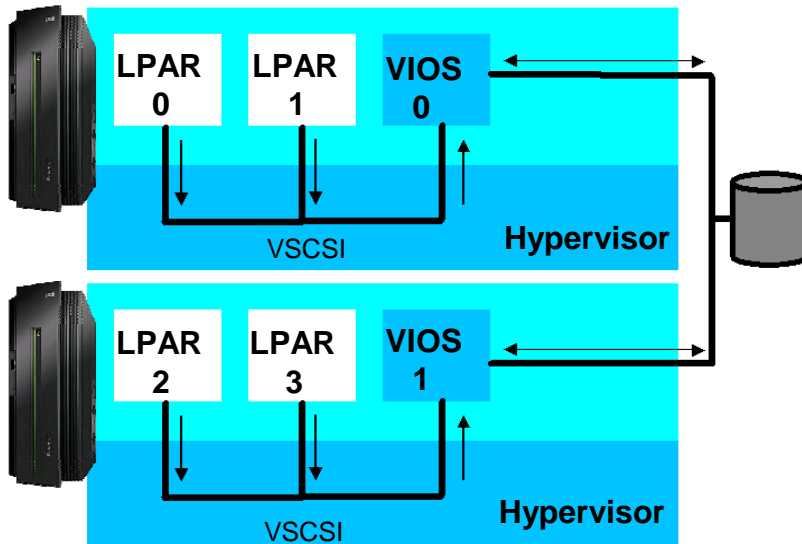

Power is performance redefined

Trusted Logging

- Log Messages transferred via hypervisor to VIOS.
- VIOS stores log files on local filesystem or Fibre Channel LUN.
- Optional Clustered VIOS configuration centralizes log data across systems – any VIOS can retrieve and analyze any log.
- One-line configuration change to enable for audit or syslog on an LPAR.
- Simple Audit Analytics
- Eliminates need for SIEM agent on LPARs
- Open APIs to SIEM vendors

PowerSC – Trusted Boot

Validate Trust for a System

Business challenge:

Ensuring that system virtual boot images haven't be altered either by accident or maliciously

Solution:

Trusted Boot provides a **Virtual Trusted Platform Module(vTPM)** for each Virtual Machine. The vTPM is used to hold the boot measurement data to validate the Trust of a system.

Benefits:

- **Trust Visibility:** Gives ability to display trust of a system
- Allows security **compliance to be demonstrated**
- Provides additional **control and assurance** for Virtual Workloads



PowerSC Trusted Boot

How does it work?

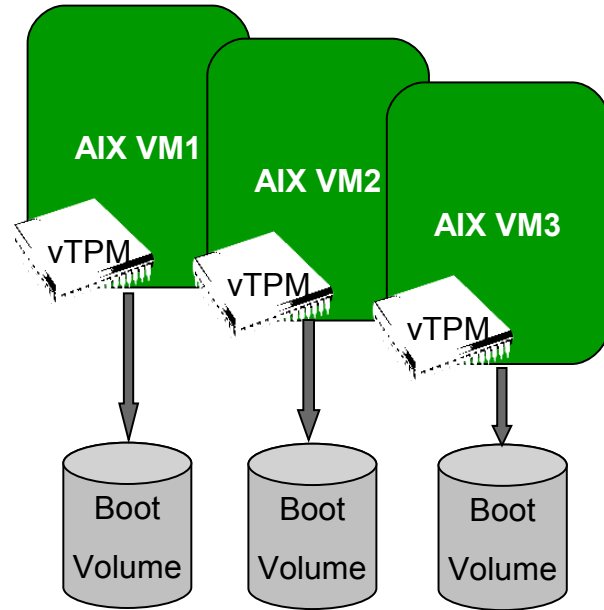

This feature requires Firmware 7.4 or above

- Each Virtual Machine has its own vTPM Configured using HMC/SDMC
- During the AIX Boot process Measurements are taken and Compared to vTPM contents
- PowerVM Hypervisor and PowerSC work together to metric the boot process and store the metrics in the vTPM
- Trusted Status is available for “Attestation” using OpenPTS Monitor

Trusted Boot Technology Overview

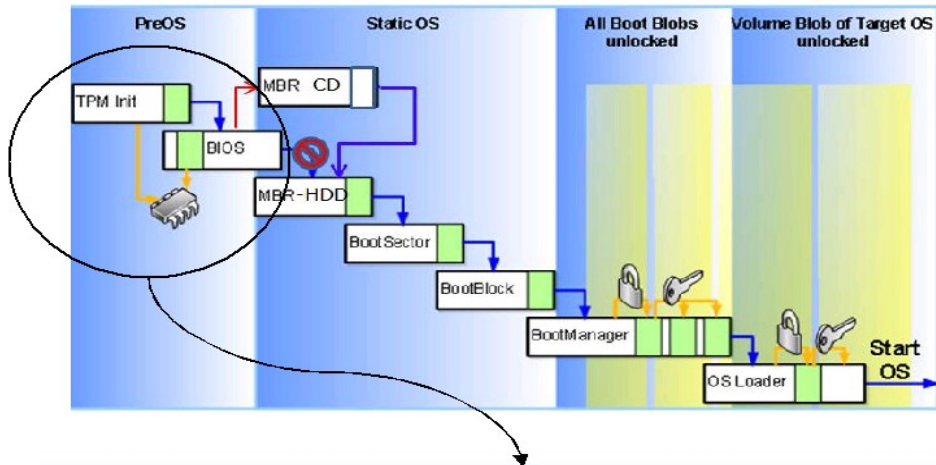

- vTPM virtual TPM
- Protected within the Power Hypervisor and with the pHyp's perfect security record
- Measure boot image
- Measure kernel extensions
- Measure AIX Trusted Execution (TE) Kernext
- TE to verify OS, and Applications.



Chain of trust - trusted boot

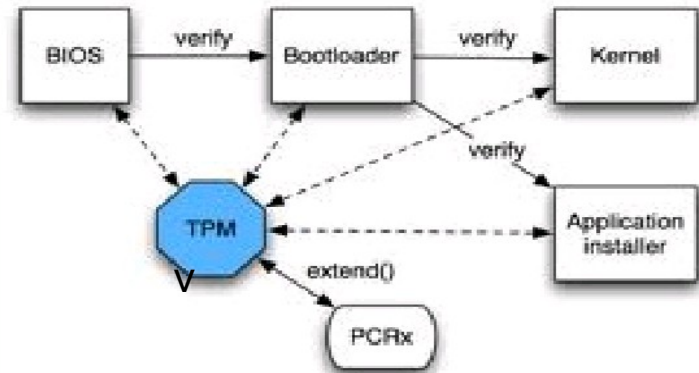

How to Monitor Trusted System Status?

Trusted Monitor OpenPTS GUI

The screenshot shows the OpenPTS GUI with a sidebar on the left containing a tree view of system statuses. The main area displays a table of systems with a 'TE mismatch' status. A callout window provides details for a specific system.

Enroll
All (101)
Trusted (95)
Unknown state (0)
Error (0)
Not enrolled (0)
Update pending (1)
Not trusted (5)
 TE mismatch (3)
 kernel mismatch (1)
 bootloader mismatch (1)

TE mismatch
Attest Acknowledge Unenroll

Hostname	Last Update
ClusterNode4	Wed Jun 01 16:28:14 BST 2011
ClusterNode45	Wed Jun 01 16:28:14 BST 2011
ClusterNode51	Wed Jun 01 16:28:14 BST 2011

General Log

Hostname: ClusterNode4
Status: TE mismatch
Reason: The current measure of the trusted execution database is different from reference
Remediation: You should investigate the change, restore the database and/or acknowledge the new measure.

- A easy read list of not trusted systems
- A change in kernel extension, user command or application
- AIX TE will pin point the file that changed.

PowerSC – Trusted Network Connect and Patch Management

Actively Detect Compliance Issues

Business challenge:

Maintaining virtual machines and ensuring that site specified patch levels are adhered to is challenging when many systems and virtual machines are deployed.

Solution:

Trusted Network Connect and Patch Management detects noncompliant virtual machines during activation and alerts administrators immediately.

Benefits:

- **Active notification** of down level systems via email and SMS
- **Simplifies audits** since active monitoring at virtual machine activation proves compliance to patch policy
- **Raises visibility** of non compliance within the virtual data center and cloud environments



PowerSC – Trusted Network Connect and Patch Management

How does it work?

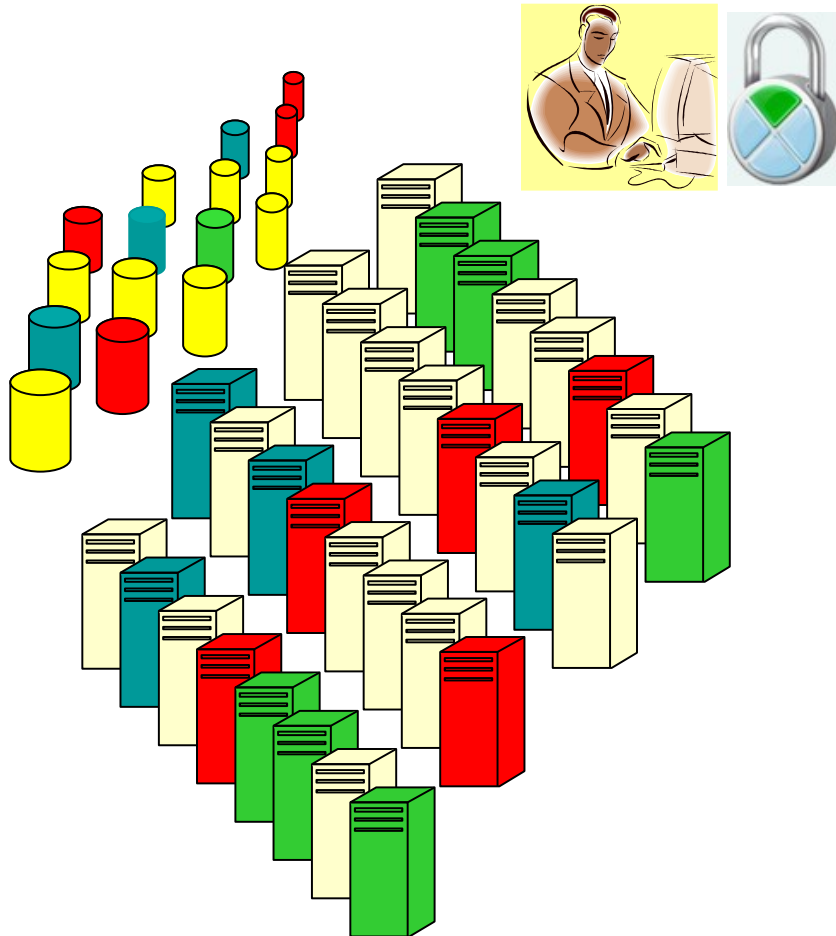

- Trusted Network Connect (TNC) is integrated with the Service Update Manager Assistant (SUMA) and the Network Installation Manager (NIM)
- During the Boot process TNC in the LPAR communicates to TNC server in VIOS
- TNC Server is notified of patch levels
- TNC Server Sends Alert if not at correct patch level

TNC Server

- View verification Technology Levels

```
# tncconsole list -r ALL
#Release TL      SP
6100      6      4
6100      4      9
```

- Add a TNC Client to TNC Server

```
# tncconsole add -I ip=9.3.198.46
```

- Create a Policy and Policy Group

```
# tncconsole add -G 61-06-04_Group ip=9.3.198.46
```

```
# tncconsole add -F 61-06-04_Policy 6100-06-04
```

```
# tncconsole add -P 61-06-04_Policy ipgroup=61-06-04_Group
```

```
# tncconsole list -F ALL
```

```
#f#policyname      Release TL      SP
61-06-04_Policy    6100      6      4
```

```
# tncconsole list -G ALL
```

```
#ipgroupname      ip      policyname
61-06-04_Group    9.3.198.46      61-06-04_Policy
```

Power is performance redefined

Process Flow

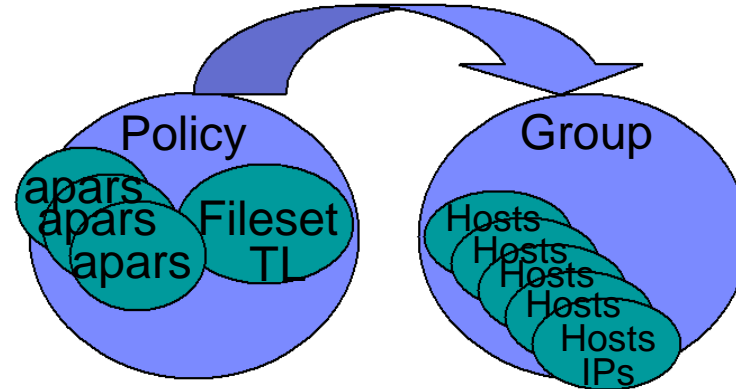

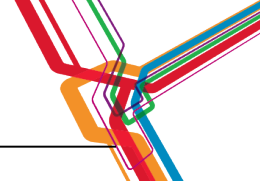

TNC with integrated Patch Management

- Automatic Notification of Security Patches
- Identification of down level systems
- Centralized management through NIM to patch systems.
- Automatic Notification if new, down level virtualized system boot, migrates, resumes into datacenter



Power is performance redefined

PowerSC Editions

Security and Compliance Options



- **PowerSC Express**
 - *Basic compliance for AIX*
- **PowerSC Standard**
 - *Security and compliance for virtual & cloud environments*

PowerSC Editions	Express	Standard
Security and Compliance Automation	✓	✓
Trusted Logging		✓
Trusted Boot**		✓
Trusted Network Connect and Patch Management		✓

** Requires POWER7 System with eFW7.4

How is PowerSC Packaged?

- PowerSC Express
 - AIX PowerSC Express software package
- PowerSC Standard Edition is a combination of following
 - Includes PowerSC Express Edition + “Trusted Features”
 - PowerSC Software running on the AIX Operating System
 - Extensions to the Virtualization Firmware and VIOS
- PowerSC Standard Edition Installation Requires
 - AIX PowerSC Standard software Package
 - AIX Version 6 TL7 or higher or AIX 7 TL1 or higher
 - VIOS level v2.2.1 and above
 - Firmware(eFW7.4) and above for the “Trusted Boot” Feature

Power is performance redefined



Deliver new services faster

- Compliance Automation accelerates secure system creation and compliance.



Deliver higher quality services

- PowerSC hardens the Cloud and Virtual Infrastructure avoiding security related events providing higher quality systems.



Deliver services with superior economics

- PowerSC automation and Trusted features reduce labor costs to maintain secure systems



Power is performance redefined

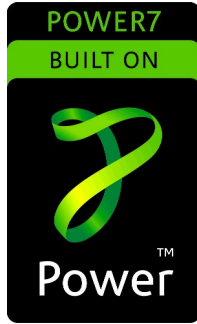

Power is Security and Compliance

**Entegre Servis Yönetimi ve
Güvenlik Çözümleri**

30 Mayıs 2012, Çarşamba
Grand Hyatt İstanbul

Learn more about PowerSC on the Web

<http://www.ibm.com/systems/power/software/security/>

Home Solutions Services Products Support & downloads My IBM Welcome Mr. Thomas Bosworth [Not you?] [IBM Sign in]

Power Systems > Power Systems > Software >

Power Systems security

Meeting needs for IT security compliance

Power is data protection and compliance

Overview Features Resources

Today's leaders face multiple challenges, including the need to secure the enterprise against a barrage of new and evolving sophisticated threats. The [IBM business-driven approach to enterprise security](#) helps to identify gaps in your existing capabilities across the people, processes, applications, data, technology and physical facilities across your organization. IBM is the only security vendor in the market today with end-to-end coverage across all risk areas to help you create an intelligent dynamic and secure infrastructure.

Real security means protecting information in your virtualized environment

CIOs and IT Architects are transitioning to new IT architectures like Cloud Computing, Service Oriented Architecture (SOA) and xml web services to facilitate rapid deployment of new workloads to meet changing business demands. These new architectures pose new security risks. IBM Power Systems servers coupled with [PowerVM](#) technology are designed to help clients build a dynamic infrastructure with a secure virtualization environment.

PowerVM hypervisor provides isolation in these virtualized environments. Through advanced dynamic logical partitioning (LPAR) capabilities, a single partition can act as a completely separate AIX, i, or Linux operating environment. Partitions can have dedicated or shared processor resources. Application development and testing can be performed in secure independent domains.

PowerVM hypervisor facts:

- The PowerVM hypervisor is secure by design. IBM is the only vendor who designs the

We're here to help

Easy ways to get the answers you need.

Chat now

E-mail IBM

Find a Business Partner

or call us at
1-866-883-8901
Priority code:
101AR13W

Management
Energy
Security
Availability
Operating Systems
Virtualization
IBM® Systems Software

AIX security

Resources

- PowerSC 7.1 (pdf)
 - <http://www-03.ibm.com/systems/power/software/security/index.html>
- IBM Systems Director 6.2.x Information Center
 - <http://publib.boulder.ibm.com/infocenter/director/v6r2x/index.jsp>
- AIX Profile Manager V1.1.1 for IBM Systems Director
 - http://publib.boulder.ibm.com/infocenter/aix/v6r1/topic/com.ibm.aix.apmgr/apmgr_pdf.pdf
- IBM AIX Version 7.1 Differences Guide, *SG24-7910-00*
 - <http://www.redbooks.ibm.com/abstracts/sg247910.html?Open>
- Beat the AIX Security Expert gotchas, developerWorks
 - <http://www.ibm.com/developerworks/aix/library/au-aixsecexpert/index.html>
- The clever way to catch new stuff (or catch up):
 - AIX movies (system hardening with aixpert, pConsole and much, much more)

TEŞEKKÜRLER ...