

Net.Data



Reference

Net.Data



Reference

Note

Be sure to read the information in "Appendix D. Notices" on page 319 before using this information and the product it supports.

Oct 1999 Edition

© Copyright International Business Machines Corporation 1997, 1999. All rights reserved.

US Government Users Restricted Rights – Use, duplication or disclosure restricted by GSA ADP Schedule Contract with IBM Corp.

Contents

Preface	vii
About Net.Data	vii
About This Book	vii
Who Should Read This Book	viii
About Examples in This Book	viii
How to Read the Syntax Diagrams	viii
Chapter 1. Net.Data Macro Language Constructs	1
Net.Data Macro Syntax	1
Common Syntax Elements	4
Variable Name	4
Variable Reference	4
Strings	5
Macro Language Constructs	6
Comment Block	7
DEFINE Block or Statement	9
ENVVAR Statement	13
EXEC Block or Statement	14
FUNCTION Block	16
Function Call (@)	23
HTML Block	26
IF Block	28
INCLUDE Statement	34
INCLUDE_URL Statement	36
LIST Statement	38
MACRO_FUNCTION Block	40
MESSAGE Block	44
REPORT Block	48
ROW Block	51
TABLE Statement	53
WHILE Block	55
Chapter 2. Variables	59
User-defined Variables	60
Conditional Variables	60
Environment Variables	61
Executable Variables	61
Hidden Variables	62
List Variables	63
Table Variables	64
Net.Data Table Processing Variables	65
<i>Nn</i>	66
NLIST	67
NUM_COLUMNS	68
NUM_ROWS	69
ROW_NUM	70
TOTAL_ROWS	71
<i>V_columnName</i>	72
VLIST	73
<i>Vn</i>	74
Net.Data Report Variables	75
ALIGN	76
DTW_DEFAULT_REPORT	77

DTW_HTML_TABLE	78
RPT_MAX_ROWS	79
START_ROW_NUM	81
Net.Data Language Environment Variables	84
DATABASE	85
DB_CASE	87
DB2PLAN	88
DB2SSID	89
DTW_APPLET_ALTTEXT	90
DTW_EDIT_CODES	91
DTW_PAD_PGM_PARMS	92
DTW_SAVE_TABLE_IN	93
DTW_SET_TOTAL_ROWS	94
LOCATION	95
LOGIN	96
NULL_RPT_FIELD	97
PASSWORD	98
SHOWSQL	99
SQL_STATE	100
TRANSACTION_SCOPE	101
Net.Data Miscellaneous Variables	102
DTW_CURRENT_FILENAME	103
DTW_CURRENT_LAST_MODIFIED	104
DTW_DEFAULT_MESSAGE	105
DTW_LOG_LEVEL	106
DTW_MACRO_FILENAME	107
DTW_MACRO_LAST_MODIFIED	108
DTW_MBMODE	109
DTW_MP_PATH	110
DTW_MP_VERSION	111
DTW_PRINT_HEADER	112
DTW_REMOVE_WS	113
RETURN_CODE	114
Chapter 3. Net.Data Built-in Functions	115
Function Names	115
Input and Output Parameters	115
Function Result Formatting	116
Function Parameter Rules	116
General Functions	116
DTW_ADDQUOTE	118
DTW_CACHE_PAGE	120
DTW_DATE	124
DTW_EXIT	126
DTW_GETCOOKIE	127
DTW_GETENV	129
DTW_GETINIDATA	131
DTW_HTMLLENCODE	132
DTW_QHTMLLENCODE	134
DTW_SENDMAIL	135
DTW_SETCOOKIE	140
DTW_SETENV	144
DTW_TIME	146
DTW_URLESCSEQ	148
Math Functions	150
DTW_ADD	151

DTW_DIVIDE	153
DTW_DIVREM	155
DTW_FORMAT	157
DTW_INTDIV	160
DTW_MULTIPLY	162
DTW_POWER	164
DTW_SUBTRACT	166
String Functions	168
DTW_ASSIGN	169
DTW_CHARTOHEX	170
DTW_CONCAT	171
DTW_DELSTR	172
DTW_HEXTOCHAR	174
DTW_INSERT	175
DTW_LASTPOS	177
DTW_LENGTH	179
DTW_LOWERCASE	180
DTW_POS	182
DTW_REPLACE	184
DTW_REVERSE	186
DTW_STRIP	187
DTW_SUBSTR	189
DTW_TRANSLATE	191
DTW_UPPERCASE	193
Word Functions	195
DTW_DELWORD	196
DTW_SUBWORD	198
DTW_WORD	200
DTW_WORDINDEX	201
DTW_WORDLENGTH	202
DTW_WORDPOS	203
DTW_WORDS	205
Table Functions	206
DTW_TB_APPENDROW	207
DTW_TB_COLS	209
DTW_TB_DELETECOL	211
DTW_TB_DELETEROW	212
DTW_TB_DLIST	214
DTW_TB_DUMPH	216
DTW_TB_DUMPV	217
DTW_TB_GETN	219
DTW_TB_GETV	221
DTW_TB_HTMLENCODE	223
DTW_TB_INPUT_CHECKBOX	225
DTW_TB_INPUT_RADIO	227
DTW_TB_INPUT_TEXT	229
DTW_TB_INSERTCOL	231
DTW_TB_INSERTROW	232
DTW_TB_LIST	234
DTW_TB_QUERYCOLNONJ	236
DTW_TB_ROWS	238
DTW_TB_SELECT	239
DTW_TB_SETCOLS	241
DTW_TB_SETN	242
DTW_TB_SETV	244
DTW_TB_TABLE	246

DTW_TB_TEXTAREA	248
Flat File Interface Functions.	250
Access to Flat File Data Sources.	250
Flat File Interface Delimiters	252
Locking Files	253
DTWF_APPEND.	254
DTWF_CLOSE	257
DTWF_DELETE	258
DTWF_INSERT	260
DTWF_OPEN	263
DTWF_READ	265
DTWF_REMOVE	268
DTWF_SEARCH.	270
DTWF_UPDATE	273
DTWF_WRITE	276
Web Registry Functions	279
DTWR_ADDENTRY	280
DTWR_CLEARREG	282
DTWR_CLOSEREG	283
DTWR_CREATEREG	284
DTWR_DELENTY.	286
DTWR_DELREG.	288
DTWR_LISTREG	289
DTWR_LISTSUB	291
DTWR_OPENREG	293
DTWR_RTVENTRY	295
DTWR_UPDATEENTRY	297
Persistent Macro Functions	299
DTW_ACCEPT	300
DTW_COMMIT	302
DTW_ROLLBACK	303
DTW_RTVHANDLE.	304
DTW_STATIC	305
DTW_TERMINATE	307
Appendix A. Net.Data Technical Library	309
Appendix B. DB2 WWW Connection	311
EXEC_SQL.	311
HTML_INPUT	311
HTML_REPORT	311
SQL	311
SQL_MESSAGE	312
SQL_REPORT	312
SQL_CODE	312
Appendix C. Net.Data Operating System Reference	313
Appendix D. Notices	319
Trademarks.	320
Glossary	323
Index	325

Preface

Thank you for selecting Net.Data[®], the IBM[®] development tool for creating dynamic Web pages! With Net.Data you can rapidly develop Web pages with a dynamic content by incorporating data from a variety of data sources and by using the power of programming languages you already know.

About Net.Data

With IBM's Net.Data product, you can create dynamic Web pages using data from both relational and non-relational database management systems (DBMSs), including DB2, IMS, ODBC-enabled databases, and databases that can be accessed through DRDA, and using applications written in programming languages such as Java, JavaScript, Perl, C, C++, and REXX. The Net.Data family of products provides similar capabilities on machines executing the Windows NT, AIX, OS/2, OS/390, OS/400, HP-UX, Sun Solaris, Santa Cruz Operating System (SCO), and Linux operating systems.

Net.Data is a macro processor that executes as middleware on a Web server machine. You can write Net.Data application programs, called *macros*, that Net.Data interprets to create dynamic Web pages with customized content based on input from the user, the current state of your databases, other data sources, existing business logic, and other factors that you design into your macro.

A request, in the form of a URL (uniform resource locator), flows from a browser, such as Netscape Navigator or Internet Explorer, to a Web server that forwards the request to Net.Data for execution. Net.Data locates and executes the macro, and builds a Web page that it customizes based on functions that you write. These functions can:

- Encapsulate business logic within applications written in, but not limited to, C, C++, RPG, COBOL, JAVA, Perl, or REXX programming languages
- Access databases such as DB2
- Access other data sources such as flat files

Net.Data passes this Web page to the Web server, which in turn forwards the page over the network for display at the browser.

Net.Data can be used in server environments that are configured to use interfaces such as HyperText Transfer Protocol (HTTP) and Common Gateway Interface (CGI). HTTP is an industry-standard interface for interaction between a browser and Web server, and CGI is an industry-standard interface for Web server invocation of gateway applications like Net.Data. These interfaces allow you to select your favorite browser or Web server for use with Net.Data.

For improved performance, Net.Data supports a variety of Web server Application Programming Interfaces (APIs). In addition, Net.Data can be launched as a Java servlet.

About This Book

This book explains the syntax and usage of Net.Data language constructs, variables, and functions.

This book might refer to products or features that are announced, but not yet available.

More information, sample Net.Data macros, demos, and the latest copy of this book, is available from the following World Wide Web sites:

- <http://www.ibm.com/software/data/net.data>
- <http://www.as400.ibm.com/netdata>

Who Should Read This Book

People involved in planning and writing Net.Data applications can use the information in this book to understand what language constructs, variables, and functions Net.Data provides.

To understand the concepts discussed in this book, you should be familiar with Web servers, simple SQL statements, and HTML (including using HTML forms), and the information in *Net.Data Administration and Programming Guide*.

About Examples in This Book

Examples used in this book are kept simple to illustrate specific concepts. The examples are not intended to show all of the ways in which Net.Data constructs can be used. Likewise, some of the examples are fragments of code that cannot be executed by themselves.

How to Read the Syntax Diagrams

The following rules apply to the syntax diagrams used in this book:

- Read the syntax diagrams from left to right, from top to bottom, following the path of the line.

The ►— symbol indicates the beginning of a statement.

The —► symbol indicates that the statement syntax is continued on the next line.

The ►— symbol indicates that a statement is continued from the previous line.

The —► symbol indicates the end of a statement.

Diagrams of syntactical units other than complete statements start with the ►— symbol and end with the —► symbol.

- Required items appear on the horizontal line (the main path).



- Optional items appear below the main path.



If an optional item appears above the main path, that item has no effect on the execution of the statement and is used only for readability.

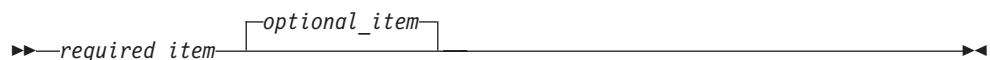

- If you can choose from two or more items, they appear vertically, in a stack. If you *must* choose one of the items, one item of the stack appears on the main path.

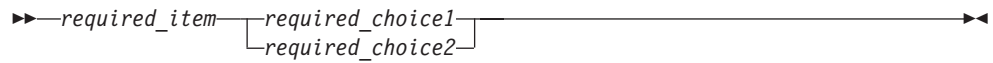

If choosing one of the items is optional, the entire stack appears below the main path.

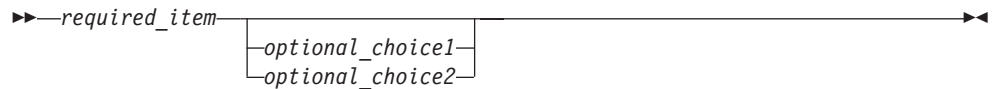

If one of the items is the default, it appears above the main path and the remaining choices are shown below.

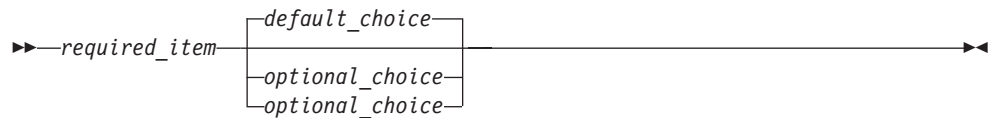

- An arrow returning to the left, above the main line, indicates an item that can be repeated.

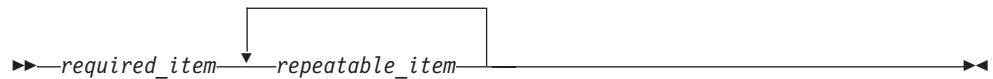

If the repeat arrow contains punctuation, you must separate repeated items with the specified punctuation.

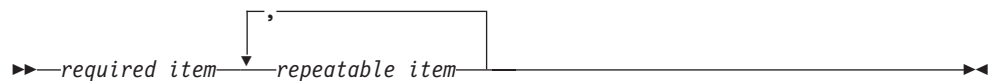

A repeat arrow above a stack indicates that you can repeat the items in the stack.

- Keywords appear in uppercase (for example, FROM). In Net.Data, keywords can be in any case. Terms that are not keywords appear in lowercase letters (for example, *column-name*). They represent user-supplied names or values.
- If punctuation marks, parentheses, arithmetic operators, or other such symbols are shown, you must enter them as part of the syntax.

Chapter 1. Net.Data Macro Language Constructs

This chapter describes the Net.Data macro syntax and the language constructs used in the Net.Data macro. The language constructs consist of a keyword and a statement or block in the Net.Data macro, specify different variable types, and perform other special tasks such as including files.

This chapter describes:

- “Net.Data Macro Syntax”
- “Common Syntax Elements” on page 4
- “Macro Language Constructs” on page 6

Net.Data Macro Syntax

A Net.Data macro is a text file consisting of a series of Net.Data macro language constructs that:

- Specify the layout of Web pages
- Define variables and functions
- Call functions that are defined in the macro or that Net.Data passes to language environments for processing

Each statement is composed of one or more language constructs, which in turn are composed of keywords, special characters, strings, names, and variables. The following diagram depicts the global structure of a syntactically valid Net.Data macro. See “Macro Language Constructs” on page 6 for detailed syntax of each element in the global structure.

The Net.Data macro contains two parts: the declaration part and the presentation

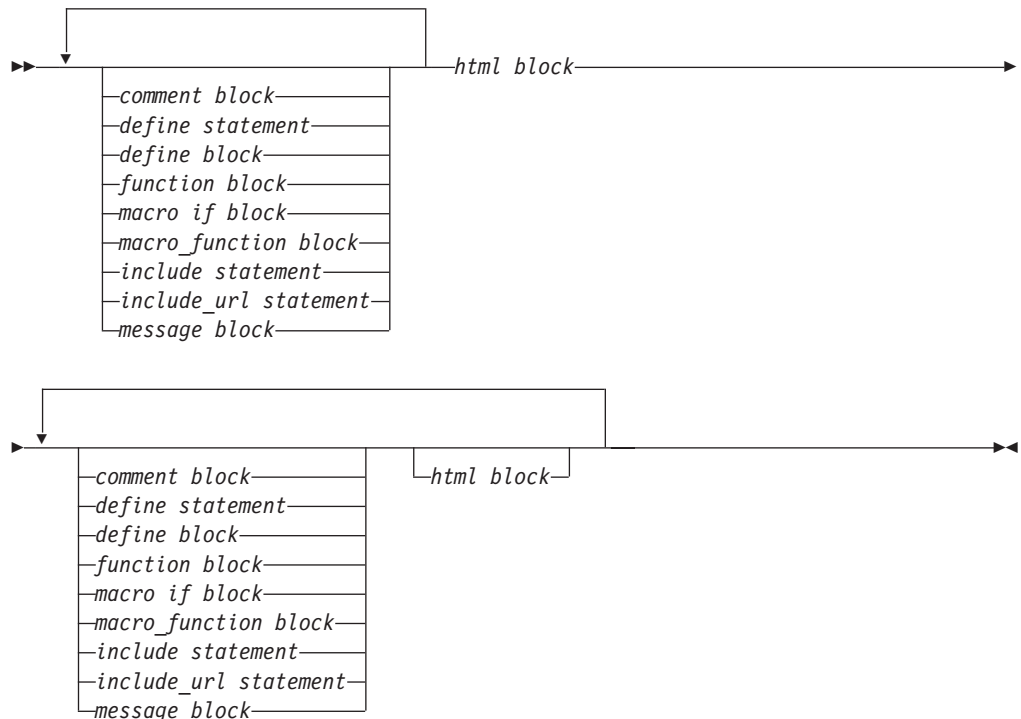

part. You can use these parts multiple times and in any order.

- *Declaration part* contains the definitions of variables and functions in the macro.
- *Presentation part* contains HTML blocks that contain HTML statements that specify the layout of the Web page. This part includes the report section.

Figure 1 shows the declaration and presentation parts of the macro.

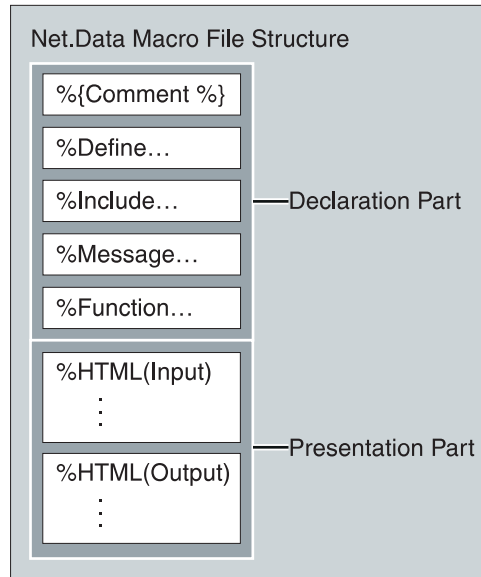

Figure 1. Macro Structure

Variables and functions that are used in the declaration or presentation part must be defined before being used by a variable reference or a function call.

Figure 2 on page 3 demonstrates the parts of a macro. The declaration part contains the DEFINE and FUNCTION definition blocks. The HTML blocks act as input and output blocks.

```

%{ ***** Define block *****}
%DEFINE {
  page_title="Net.Data macro Template"
%}

%{ ***** Function Definition block *****}
%FUNCTION(DTW_REXX) rexx1 (IN input) returns(result)
  { %EXEC{ompsamp.cmd %}
%}

%FUNCTION(DTW_REXX) today () RETURNS(result)
  {
    result = date()
%}

%{ ***** HTML Block: Input *****}
%HTML (INPUT) {
<html>
<head>
<title>$(page_title)</title>
</head><body>
<h1>Input Form</h1>
Today is @today()

<FORM METHOD="post" ACTION="output">
Type some data to pass to a REXX program:
<INPUT NAME="input_data" TYPE="text" SIZE="30">
<p>
<INPUT TYPE="submit" VALUE="Enter">

<hr>
<p>[<a href="/">Home page]
</body></html>
%}

%{ ***** HTML Block: Output *****}
%HTML (OUTPUT) {
<html>
<head>
<title>$(page_title)</title>
</head><body>
<h1>Output Page</h1>
<p>@rexx1(input_data)
<p><hr>
<p>[<a href="/">Home page</a> |
<a href="input">Previous page</a>]
</body></html>
%}

```

Figure 2. The Macro Template Format

The Net.Data macro language is a free-form language, giving you flexibility for writing your macros. Unless specifically noted, extra white space characters are ignored. Each of the Net.Data macro language constructs is described in the following section, along with several other elements that are used to define the constructs. The Net.Data macro language supports DB2 WWW Connection language elements for backward compatibility. Although these language elements are described in “Appendix B. DB2 WWW Connection” on page 311, it is recommended that you use the Net.Data language constructs.

The examples show some of the ways you can use the language constructs, variables, functions, and other elements in your macros. You can download the samples and demos from the Net.Data Web pages for more extensive examples:

- <http://www.ibm.com/software/data/net.data>
- <http://www.as400.ibm.com/netdata>

Common Syntax Elements

The following syntax elements are used frequently in the language construct descriptions:

- “Variable Name”
- “Variable Reference”
- “Strings” on page 5

Variable Name

Purpose:

Identifies a variable. A variable is an object whose value can change during the execution of a macro.

Variable names must begin with a letter or underscore (`_`) and contain any alphanumeric characters, underscores, hash marks (`#`), or periods (`.`). All variable names are case sensitive except `N_columnName` and `V_columnName` (See “Net.Data Table Processing Variables” on page 65 for more information about these two exceptions.).

Variable Reference

Purpose:

Returns the value of a variable and is specified with `$` and `()`. For example: if `VAR = 'abc'`, `$(VAR)` returns the value `'abc'`. Variable references are evaluated during run time. When a variable is defined for an EXEC statement or block, Net.Data runs the specified action when it reads the variable reference.

You can dynamically generate a variable name by including variable references, strings, and function calls within a variable reference. If you reference a dynamically-generated variable that does not follow the variable name rules, Net.Data resolves the reference to an empty string.

In variable references, leading and trailing whitespace is ignored and whitespace between function calls, strings, and variable references is not allowed. If a newline character is encountered between function calls, strings, and variable references, an error message is issued. A variable reference with any other white space returns an empty string.

Syntax:

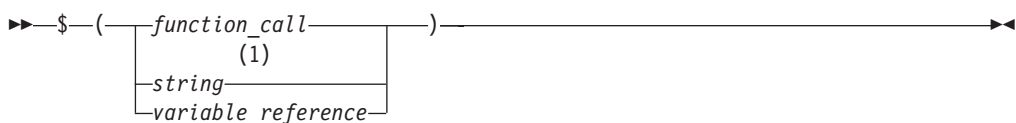

Notes:

- 1 String can contain only the characters that are allowed in variable names: alphanumeric characters, underscores (`_`), hash marks (`#`), or periods (`.`).

Example 1: Variable reference

If you have defined a variable `homeURL`:

```
%DEFINE homeURL="http://www.ibm.com/"
```

You can refer to the homepage as `$(homeURL)` and create a link:

```
<a href="$(homeURL)">Home page</a>
```

Example 2: Dynamically-generated variable reference

You can dynamically generate variable references to dynamically reference a field value in a row:

```
%WHILE (INDEX < NUM_COLS) {  
  $(V$(INDEX))  
  @DTW_ADD(INDEX, "1", INDEX)  
%}
```

Example 3: A dynamic variable reference with nested variable references and a function call

```
%define my = "my"  
%define u = "lower"  
%define myLOWERvar = "hey"  
  
$($(my)@dtw_ruppercase(u)var)
```

The variable reference returns the value of `hey`.

Strings

Any sequence of alphabetic and numeric characters and punctuation. If the string appears within double quotes, the new-line character is not allowed. See the string parameter description in each language construct for restrictions when used with the language construct.

Strings in quotes (`""`), can contain any character except the new-line character. If the string is in brackets, (`{ %}`), it can contain any character including the new-line character. For example,

```
%define multiline = {  
  first line  
  second line  
%}
```

To specify double quotes inside a quoted string, use two pairs of double quotes. A string used as function argument or as term in a comparison expression can contain double quotes. For example, if you define a string value as:

```
%DEFINE result = " ""Hello world!"" "
```

The value of `result` is:

```
"Hello world!"
```

An HTML statement is a string.

Strings used as function arguments, terms, and variable values can contain variable references and function calls. In the following example, the function call `myfunc2` has a string parameter that contains a variable reference and a function call.

```
%html(report) {  
  @myfunc2("abc$(var1)@myfunc()")  
%}
```

Net.Data resolves the variable reference `$(var1)` and the function call `@myfunc()`, rather than interpreting them literally as part of the string, before passing the string to the function `myfunc2`.

Macro Language Constructs

This section describes the language constructs used in the Net.Data macro.

Each language construct description can contain the following information:

Purpose

Defines why you use the language construct in the Net.Data macro.

Syntax

Provides a diagram of the language construct's logical structure.

Parameters

Defines all the elements in the syntax diagram and provides cross references to other language constructs' syntax and examples.

Context

Explains where in the Net.Data macro structure the language construct can be used.

Restrictions

Defines which elements it can contain and specifies any usage restrictions.

Examples

Provides simple examples and explanations for using the keyword statement or block within the Net.Data macro.

The following constructs are used in the macro; please refer to each constructs description for syntax and examples.

- "Comment Block" on page 7
- "DEFINE Block or Statement" on page 9
- "ENVVAR Statement" on page 13
- "EXEC Block or Statement" on page 14
- "FUNCTION Block" on page 16
- "Function Call (@)" on page 23
- "HTML Block" on page 26
- "IF Block" on page 28
- "INCLUDE Statement" on page 34
- "INCLUDE_URL Statement" on page 36
- "LIST Statement" on page 38
- "MACRO_FUNCTION Block" on page 40
- "MESSAGE Block" on page 44
- "REPORT Block" on page 48
- "ROW Block" on page 51
- "TABLE Statement" on page 53
- "WHILE Block" on page 55

Comment Block

Purpose

Documents the functions of the Net.Data macro. Because the COMMENT block can be used anywhere in the macro, it is not documented in the other syntax diagrams.

The COMMENT block can also be used in the Net.Data initialization file.

Syntax

```
►► —%{—text—%} —————►►
```

Values

text Any string on one or more lines. Net.Data ignores the contents of all comments.

Context

Comments can be placed anywhere between Net.Data language constructs in a Net.Data macro or the Net.Data initialization file

Restrictions

Any text or characters are allowed; however, comment blocks cannot be nested.

Examples

Example 1: A basic comment block

```
%{  
This is a comment block. It can contain any number of lines  
and contain any characters. Its contents are ignored by Net.Data.  
%}
```

Example 2: Comments in a FUNCTION block

```
%function(DTW_REXX) getAddress(IN name,  %{ customer name %}  
                               IN phone,  %{ customer phone number %}  
                               OUT address %{ customer address %}  
                               )  
  
{  
    ....  
%}
```

Example 3: Comments in an HTML block

```
%html(report) {  
  
  %{ run the query and save results in a table %}  
  @myQuery(resultTable)  
  
  %{ build a form to display a page of data %}  
  <form method="POST" action="report">  
  
    %{ send the table to a REXX function to send the data output %}  
    @displayRows(START_ROW_NUM, submit, resultTable, RPT_MAX_ROWS)  
  
    %{ pass START_ROW_NUM as a hidden variable to the next invocation %}  
    <input name="START_ROW_NUM" type="hidden" value="$(START_ROW_NUM)">  
  
    %{ build the next and previous buttons %}  
    %if (submit == "both" || submit == "next_only")  
      <input name="submit" type="submit" value="next">
```

```

%endif
%if (submit == "both" || submit == "prev_only")
  <input name="submit" type="submit" value="previous">
%endif
</form>
%}

```

Example 4: Comments in a DEFINE block

```

%define {
  START_ROW_NUM = "1"           %{ starting row number for output table %}
  RPT_MAX_ROWS = "25"          %{ maximum number of rows in the table %}
  resultTable = %table         %{ table to hold query results           %}
%}

```

Example 5: Comments in the Net.Data initialization file

```

%{ changes: removed RETURN_CODE parm and DTW_DEFAULT ENVIRONMENT statement %}

...

ENVIRONMENT (DTW_SQL) dtwsq1 (IN LOCATION, DB2SSID, DB2PLAN, TRANSACTION_SCOPE)
ENVIRONMENT (DTW_ODBC) odbc11 (IN LOCATION, TRANSACTION_SCOPE)
ENVIRONMENT (DTW_PERL) perl11 ()
ENVIRONMENT (DTW_REXX) rexx11 ()
ENVIRONMENT (DTW_FILE) filed11 ()
ENVIRONMENT (DTW_APPLET) appld11 ()
ENVIRONMENT (DTW_SYSTEM) sysd11 ()

```

DEFINE Block or Statement

Purpose

The DEFINE section defines variables names in the declaration part of the macro and can be either a statement or a block.

- Use statements to define one variable at a time
- Use blocks to define several variables

The variable definition can be on a single line, using double quotes (""), or can span multiple lines, using brackets and a percent sign ({ %}). After the variable is defined, you can reference it anywhere in the macro.

Syntax

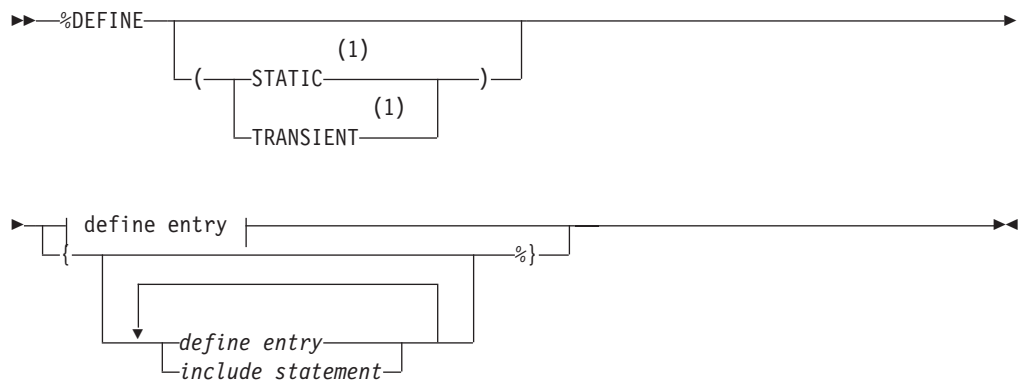

define entry:

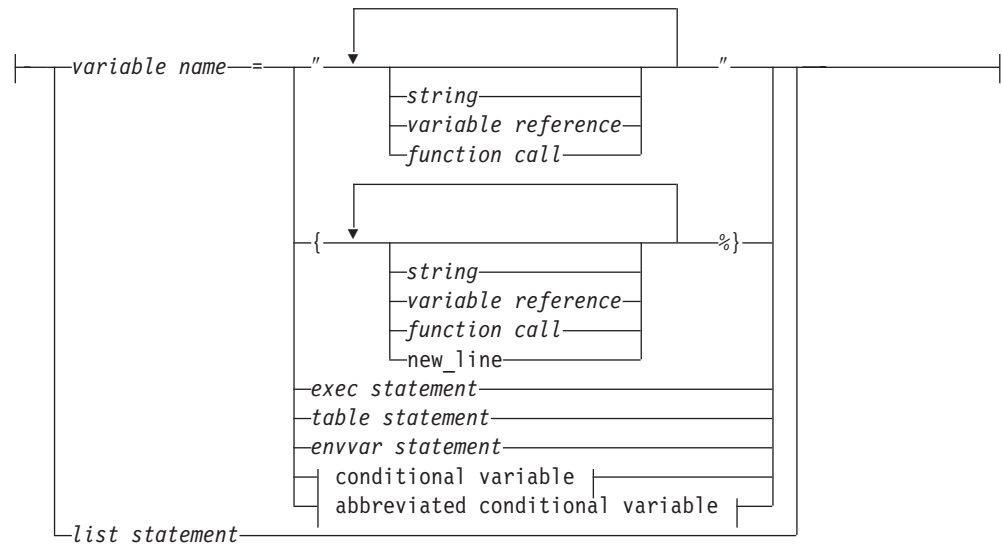

conditional variable:

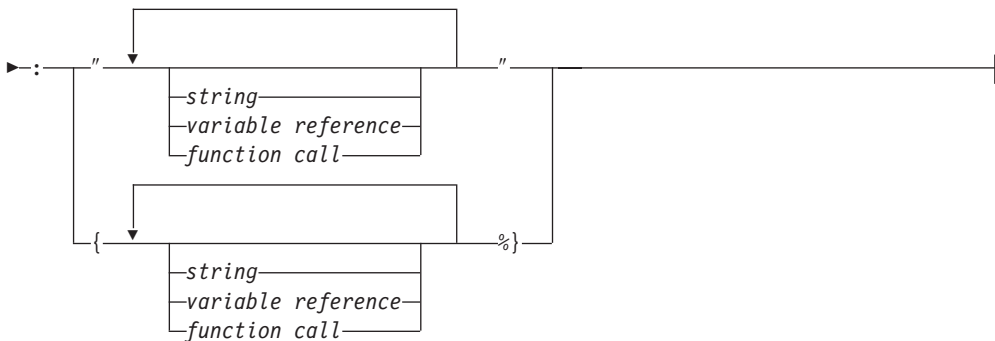
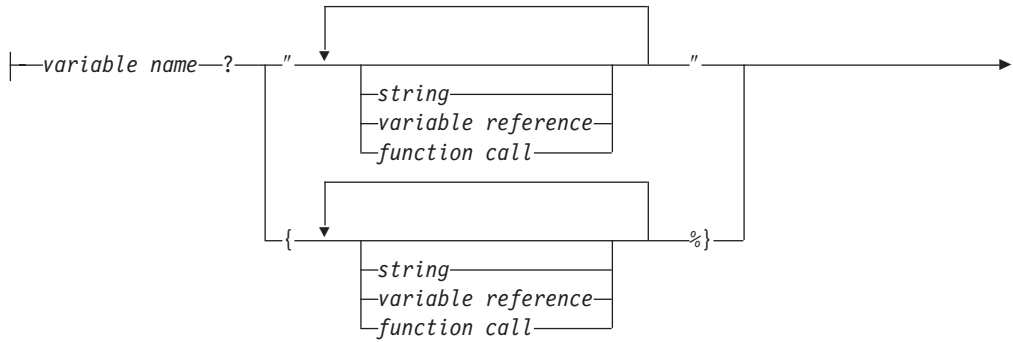

abbreviated conditional variable:

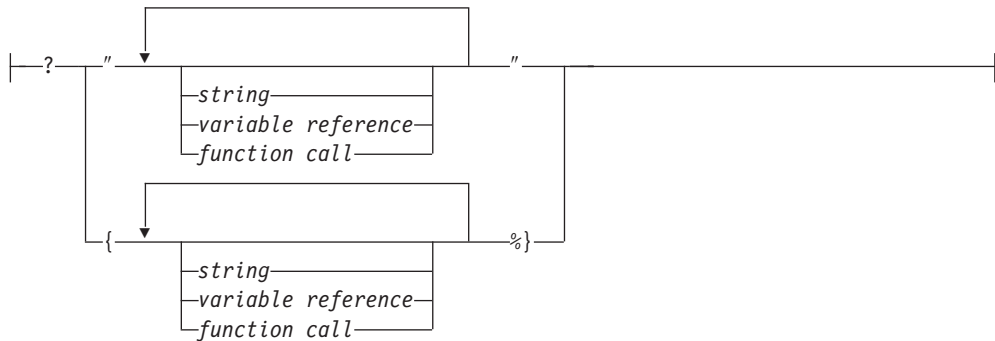

Notes:

- 1 STATIC and TRANSIENT are keywords for persistent macros, which are currently available on the OS/400 operating system, only.

Values

%DEFINE

A keyword that defines variables.

STATIC

A keyword that specifies that the variable retains its value across macro invocations within a persistent transaction. This is the default for persistent macros.

TRANSIENT

A keyword that specifies that this variable does not retain its value across macro invocations. This is the default for non-persistent macros.

define entry:

variable name

A name that identifies a variable. See “Variable Name” on page 4 for syntax information.

string

Any sequence of alphabetic and numeric characters and punctuation. If the string appears within double quotes, the new-line character is not allowed.

variable reference

Returns the value of a variable and is specified with \$ and (). For example: if VAR= 'abc', then \$(VAR) returns the value 'abc'. See “Variable Reference” on page 4 for syntax information.

function call

Invokes one or more FUNCTION or MACRO_FUNCTION blocks, or a Net.Data built-in function with specified arguments. See “Function Call (@)” on page 23 for syntax and examples.

exec statement

The EXEC statement. The name of an external program that executes when a variable is referenced or a function is called. See “EXEC Block or Statement” on page 14 for syntax and examples.

table statement

The TABLE statement. Defines a collection of related data containing an array of identical records, or rows, and an array of column names describing the fields in each row. See “TABLE Statement” on page 53 for syntax and examples.

envvar statement

The ENVVAR statement. Refers to environment variables. See “ENVVAR Statement” on page 13 for syntax and examples.

conditional variable

Sets the value of a variable based on the value of another variable or string.

abbreviated conditional variable

Sets the value of a variable based on the value of another variable or string. A shorter form of the conditional variable.

list statement

The LIST statement. Defines variables that are used to build a delimited list of values. See “LIST Statement” on page 38 for syntax and examples.

include statement

The INCLUDE statement. Reads and incorporates a file into the Net.Data macro. See “INCLUDE Statement” on page 34 for syntax and examples.

Context

The DEFINE block or statement must be in an IF block or outside all other blocks in the declaration part of the Net.Data macro.

Restrictions

- Can contain the following elements:
 - Comment block

- Conditional variables
 - LIST statement
 - TABLE statement
 - Variable references
 - INCLUDE statement
 - EXEC statement
 - Function calls
 - ENVVAR statement
- You cannot use a variable in its own definition. For example, the following variable definition is not allowed:

```
%DEFINE var = "The value is $(var)."
```

Examples

Example 1: Simple variable definitions

```
%DEFINE var1 = "orders"
%DEFINE var2 = "${var1}.html"
```

During run time, the variable reference `$(var2)` is evaluated as `orders.html`.

Example 2: Quotes inside a string

```
%DEFINE hi = "say ""hello"""
%DEFINE empty = ""
```

When displayed, the variable `hi` has the value `say "hello"`. The variable `empty` is null.

Example 3: Definition of multiple variables

```
%DEFINE{ DATABASE = "testdb"
         home = "http://www.ibm.com"
         SHOWSQL = "YES"
         PI = "3.14150"
%}
```

Example 4: Multiple-line definition of a variable

```
%DEFINE text = {This variable definition
                spans two lines
%}
```

Example 5: This example of a conditional variable demonstrates how the variable `var` takes the resulting value inside the quotations marks (""") if the resulting value does not contain any NULL values.

```
%DEFINE var = ? "Hello! $(V)@MyFunc()"
%}
```

ENVVAR Statement

Purpose

Defines a variable as an environment variable in the DEFINE block. When the ENVVAR variable is referenced, Net.Data returns the current value of the environment variable by the same name.

Syntax

▶▶—%ENVVAR—▶▶

Context

The ENVVAR statement can be in the DEFINE block or statement.

Values

%ENVVAR

The keyword for defining a variable as an environment variable in a DEFINE block. This variable gets the value of an environment variable anywhere in the macro.

Restrictions

The ENVVAR statement can contain no other elements.

Examples

Example 1: In this example, ENVVAR defines a variable, which when referenced, returns the current value for the environment variable SERVER_SOFTWARE, the name of the Web server.

```
%DEFINE SERVER_SOFTWARE = %ENVVAR

%HTML (REPORT){
The server is $(SERVER_SOFTWARE).
%}
```

EXEC Block or Statement

Purpose

Specifies an external program to execute when a variable is referenced or a function is called.

When Net.Data encounters an executable variable in a macro, it looks for the referenced executable program using the following method:

1. It searches the EXEC_PATH in the Net.Data initialization file. See the configuration chapter in *Net.Data Administration and Programming Guide* for your operating system for more information about EXEC_PATH.
2. If Net.Data does not locate the program, it searches the directories defined by the system. If it locates the executable program, Net.Data runs the program.

Authorization Tip: Ensure that the user ID under which Net.Data executes has access rights to any files referenced by the EXEC statement or block. See the section on specifying Web server access rights to Net.Data files in the configuration chapter of *Net.Data Administration and Programming Guide* for your operating system for more information.

The EXEC statement and block are used in two different contexts and have different syntax, depending where they are used. Use the EXEC statement in the DEFINE block, and use the EXEC block in the FUNCTION block.

Syntax

The EXEC statement syntax when used in the DEFINE block:

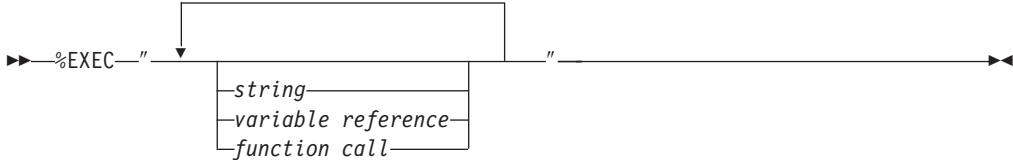

The EXEC block syntax when used in the FUNCTION block:

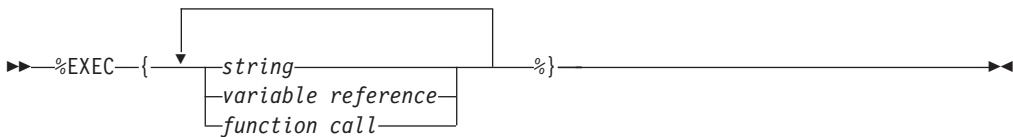

Values

%EXEC

The keyword that specifies the name of an external program to be executed when a variable is referenced or when a function is called. When Net.Data encounters a variable reference that is defined in an EXEC statement, it processes what the EXEC statement declares for the variable.

string

Any sequence of alphabetic and numeric characters and punctuation. If the string appears within double quotes, the new-line character is not allowed.

variable reference

Returns the value of a variable and is specified with \$ and (). For example: if VAR='abc', then \$(VAR) returns the value 'abc'. See “Variable Reference” on page 4 for syntax information.

function call

Invokes one or more FUNCTION or MACRO_FUNCTION blocks, or a Net.Data built-in function with specified arguments. See “Function Call (@)” on page 23 for syntax and examples.

Context

The EXEC block or statement can be found in these contexts:

- DEFINE block
- FUNCTION block

Restrictions

The EXEC block or statement can contain these elements:

- Comment block
- String
- Variable references
- Function call

The following Net.Data-provided language environments support the EXEC statement:

- REXX
- System
- Perl

Examples**Example 1:** Executable file referenced by a variable

```
%DEFINE mycall = %EXEC "MYEXEC.EXE $(empno)"

%HTML (report){
<P>Here is the report you requested:
<HR>$(mycall)
%}
```

This example executes MYEXEC.EXE on every reference to the variable, mycall.

Example 2: Executable file referenced by a function

```
%FUNCTION(DTW_REXX) my_rexx_pgm(INOUT a, b, IN c, INOUT d){
  %EXEC{ mypgm.cmd this is a test %}
%}
```

This example executes mypgm.cmd when the function my_rexx_pgm is called.

FUNCTION Block

Purpose

Defines a subroutine that Net.Data invokes from the macro. The executable statements in a FUNCTION block can be inline statements directly interpreted by a language environment, or they can be a call to an external program.

EXEC Blocks in Function Blocks: If you use the EXEC block within the FUNCTION block, it must be the only executable statement in the FUNCTION block. Before passing the executable statement to the language environment, Net.Data appends the file name of the program in the EXEC block to a path name determined by the EXEC_PATH configuration statement in the initialization file. The resulting string is passed to the language environment to be executed.

The method that the language environment uses to process the EXEC block depends on the particular language environment; the REXX, System, and Perl Net.Data-provided language environments support the EXEC block.

Using Special Characters in Language Statements: When characters that match Net.Data language constructs syntax are used in the language statements section of a function block as part of syntactically valid embedded program code (such as REXX or Perl), they can be misinterpreted as Net.Data language constructs, causing errors or unpredictable results in a macro.

For example, a Perl function might use the COMMENT block delimiter characters, %{. When the macro is run, the %{ characters are interpreted as the beginning of a COMMENT block. Net.Data then looks for the end of the COMMENT block, which it thinks it finds when it reads the end of the function block. Net.Data then proceeds to look for the end of the function block, and when it can't be found, issues an error.

Use one of the following methods to use Net.Data special characters as part of your embedded program code, without having them interpreted by Net.Data as special characters:

- Use the EXEC statement to call the program code, rather than putting the code inline.
- Use a variable reference to specify the special characters.

For example, the following Perl function contains characters representing a COMMENT block delimiter, %{, as part of its Perl language statements:

```
%function(DTW_PERL) func() {  
    ...  
    for $num_words (sort bynumber keys %{ $Rtitles{$num} }) {  
        &make_links($Rtitles{$num}{$num_words});  
    }  
    ...  
%}
```

To ensure that Net.Data interprets the %{ characters as Perl source code rather than as a Net.Data COMMENT block delimiter, rewrite the function in either of the following ways:

- Use the %EXEC statement:

```
%function(DTW_PERL) func() {  
    %EXEC{ func.pr1 %}  
%}
```

- Use a variable reference to specify the %{ characters:

```

%define percent_openbrace = "%{"
%function(DTW_PERL) func() {
...
for $num_words (sort bynumber keys $(percent_openbrace) $Rtitles{$num} }) {
&make_links($Rtitles{$num}{$num_words});
}
...
%}

```

Syntax

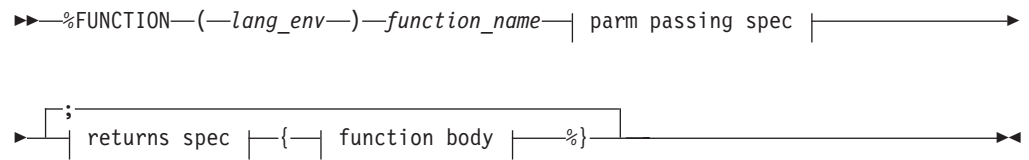

parm passing spec:

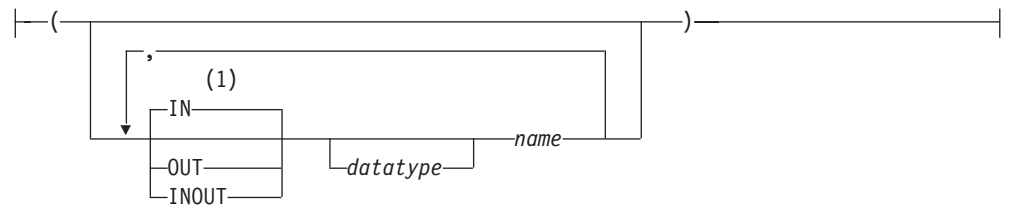

returns spec:



function body:



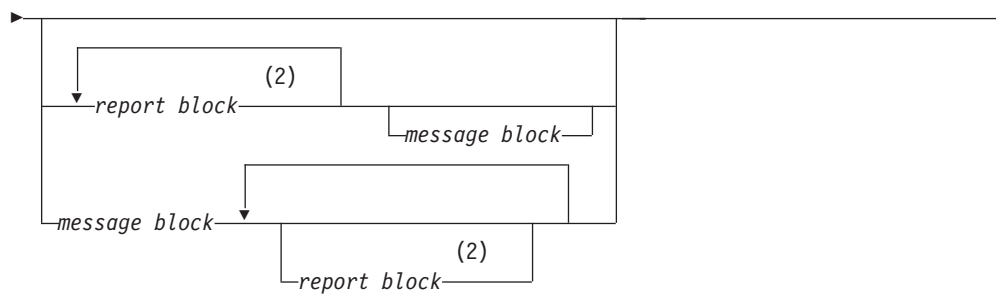

Notes:

- 1 The default parameter type of IN applies when no parameter type is specified at the beginning of the parameter list. A parameter without a parameter type uses the type most recently specified in the parameter list, or type IN if no type has been specified. For example, in the parameter list (*parm1*, INOUT *parm2*, *parm3*, OUT *parm4*, *parm5*), parameters *parm1*, *parm3*, and *parm5* do not have parameter types. The parameter *parm1* has a type of IN because no initial parameter type has been specified. The parameter *parm3* has a type of INOUT because it is the most recently specified parameter type. Similarly, the parameter *parm5* has a type of OUT because it is the most recently specified type in the parameter list.
- 2 The repeated report block is valid for:
 - SQL and ODBC language environments when processing stored procedures that return multiple result sets for the OS/390 operating systems.
 - Functions calling any language environment for the OS/400, OS/2, Windows NT, and UNIX operating systems.

Values

%FUNCTION

The keyword that specifies a subroutine that Net.Data invokes from the macro.

lang_env

The language environment that processes the function body. See the *Net.Data Administration and Programming Guide* for more information.

function_name

The name of the function being defined that can be an alphabetic or numeric string that begins with an alphabetic character or underscore and contains any combination of alphabetic, numeric, or underscore characters.

parm passing spec:

IN Specifies that Net.Data passes input data to the language environment. IN is the default.

OUT

Specifies that the language environment returns output data to Net.Data.

INOUT

Specifies that Net.Data passes input data to the language environment and the language environment returns output data to Net.Data.

datatype

Specifies the datatype of the parameter. The data type of the parameter.

For a list of supported data types for stored procedures, see the operating system appendix of *Net.Data Reference*.

name

An alphabetic or numeric string beginning with an alphabetic character or underscore and containing any combination of alphabetic, numeric, or underscore characters.

returns spec:

RETURNS

Declares the variable that contains the function value assigned by the language environment, after the function completes.

function body:

inline statement block

Syntactically valid statements from the language environment specified in the function definition, for example; REXX, SQL, or Perl. See *Net.Data Administration and Programming Guide* for a description of the language environment you are using. See the programming language's programming reference for syntax and usage. The string representing the inline statement block can contain Net.Data variable references and function calls, which get evaluated before execution of the inline statement block (program).

exec block

The EXEC block. The name of an external program that executes when a variable is referenced or a function is called. See "EXEC Block or Statement" on page 14 for syntax and examples.

report block

The REPORT block. Formatting instructions for the output of a function call. You can use header and footer information for the report. See "REPORT Block" on page 48 for syntax and examples.

message block

The MESSAGE block. A set of return codes, the associated messages, and the actions Net.Data takes when a function call is returned. See "MESSAGE Block" on page 44 for syntax and examples.

Context

The FUNCTION block can be found in these contexts:

- IF block
- Outside of any block or statement in the declaration part of the Net.Data macro.

Restrictions

- The FUNCTION block can contain these elements:
 - Comment block
 - EXEC block
 - MESSAGE block
 - REPORT block
 - Inline statement blocks
- SQL statements in the inline statement block can have the following lengths. Your database might have different restrictions; refer to your database documentation to determine if your database has a smaller restriction. IBM DB2 database restrictions are listed below, if they are different from the Net.Data limits:
 - For OS/2, Windows NT, and UNIX: 64 KB
 - DB2 has the following restrictions:
 - DB2 Universal Database V6 or higher: 64 KB

- DB2 Universal Database V5.2 or lower: 32 KB
- For OS/390: 32 KB
- For OS/400: 32 KB

Examples

The following examples are general and do not cover all language environments. See *Net.Data Language Environment Reference* for more information about using FUNCTION blocks with a specific language environment.

Example 1: A REXX substring function

```
%DEFINE lstring = "longstring"
%FUNCTION(DTW_REXX) substring(IN x, y, z) RETURNS(s) {
  s = substr("$x", $(y), $(z));
%}
%DEFINE a = {@substring(lstring, "1", "4")} % { assigns "long" to a %}
```

When *a* is evaluated, the @substring function call is found and the substring FUNCTION block is executed. Variables are substituted in the executable statements in the FUNCTION block, then the text string *s* = substr("longstring", 1, 4) is passed to the REXX interpreter to execute. Because the RETURNS

Example 2: Invoking an external REXX program

- Net.Data macro:

```
%FUNCTION(DTW_REXX) my_rexx_pgm(INOUT a, b, IN c, OUT d) {
  %EXEC{ mypgm.cmd this is a test %}
%}
%HTML(INPUT) {
  <P> Original variable values: $(w) $(x) $(z)
  <P> @my_rexx_pgm(w, x, y, z)
  <P> Modified variable values: $(w) $(x) $(z)
%}
```

Variables *w* and *x* correspond to the INOUT parameters *a* and *b* in the function. Their values and the value of *y*, which corresponds to the IN parameter *c*, should already be defined from HTML form input or from a DEFINE statement. Variables *a* and *b* are assigned new values when parameters *a* and *b* return values. The variable *z* is defined when the OUT parameter *d* returns a value.

- REXX program mypgm.cmd:

```
/* Sample REXX Program for Example 2 */
/* Test arguments */
num_args = arg();
say 'There are' num_args 'arguments';
do i = 1 to num_args;
  say 'arg' i 'is "'arg(i)'"'
end;
/* Set variables passed from Net.Data */
d = a || b || c; /* concatenate a, b, and c forming d */
a = ''; /* reset a to null string */
b = ''; /* reset b to null string */
return;
```

- Output from mypgm.cmd:

```
There are 1 arguments
arg 1 is "this is a test"
```

The EXEC statement tells the REXX language environment to tell the REXX interpreter to execute the external REXX program mypgm.cmd. Because the REXX language environment can directly share Net.Data variables with the REXX program, it assigns the REXX variables *a*, *b*, and *c* the values of the Net.Data variables *w*, *x* and *y* before executing mypgm.cmd. mypgm.cmd can directly use the

variables *a*, *b*, and *c* in REXX statements. When the program ends, the REXX variables *a*, *b*, and *d* are retrieved from the REXX program, and their values are assigned to the Net.Data variables *w*, *x*, and *z*. Because the RETURNS clause is not used in the definition of the my_rexx_pgm FUNCTION block, the value of the @my_rexx_pgm function call is the null string, "", (if the return code is 0) or the value of the REXX program return code (if the return code is nonzero).

Example 3: An SQL query and report

```
%FUNCTION(DTW_SQL) query_1(IN x, IN y) {
  SELECT customer.num, order.num, part.num, status
  FROM customer, order, shippingpart
  WHERE customer.num = '$(x)'
    AND customer.ordernumber = order.num
    AND order.num = '$(y)'
    AND order.partnumber = part.num
  %REPORT{
    <P>Here is the status of your order:
    <P>$(NLIST)
    <UL>
    %ROW{
      <LI>$(V1) $(V2) $(V3) $(V4)
    %}
    </UL>
  %}
%}
%DEFINE customer_name="IBM"
%DEFINE customer_order="12345"
%HTML(REPORT) {
  @query_1(customer_name, customer_order)
%}
```

The @query_1 function call substitutes IBM for \$(x) and 12345 for \$(y) in the SELECT statement. Because the definition of the SQL function query_1 does not identify an output table variable, the default table is used (see the TABLE variables block for details). The NLIST and Vi variables referenced in the REPORT block are defined by the default table definition. The report produced by the REPORT block is placed in the output HTML where the query_1 function is invoked.

Example 4: A system call to execute a Perl script

- Net.Data macro:

```
%FUNCTION(DTW_SYSTEM) today() RETURNS(result) {
  %exec{ perl "today.pl" %}
%}
%HTML(INPUT) {
  @today()
%}
```

- Perl program today.pl:

```
$date = 'date';
chop $date;
open(DTW, "> $ENV{DTWPIPE}") || die "Could not open: $!";
print DTW "result = \"\$date\"\n";
```

The System language environment interprets the executable statements in a FUNCTION block by passing them to the operating system through the C language system() function call. This method does not allow Net.Data variables to be directly passed or retrieved to the executable statements, as the REXX language environment does, so the System language environment passes and retrieves variables as described here:

- Input parameters are passed as system environment variables through the putenv() function and can be retrieved by the executing program. Different

languages reference the variables differently. A UNIX cshell script refers to environment variables by preceding the environment variable name with a '\$', such as \$x. A Perl language script refers to them by referencing the associative array %ENV, such as %ENV{'x'}. A DOS batch (.BAT) file refers to the variable name enclosed in percent signs, such as %x%.

- Output parameters are passed back to the language environment by writing to a pipe whose name is passed in the environment variable DTWPIPE, except on the OS/400 platform, where output parameters are passed back to the language environment as system environment variables. The data that is written to the named pipe has the form name="value", just as with DEFINE statements. If a variable name corresponding to an output parameter is written this way, the new value replaces the current value. If a variable name is written that does not correspond to an output parameter, it is ignored.

When the @today function call is encountered, Net.Data performs variable substitution on the executable statements. In this example, there are no Net.Data variables in the executable statements, so no variable substitution is performed. The executable statements and parameters are passed to the System language environment, which creates a named pipe and sets the environment variable DTWPIPE to the name of the pipe.

Then the external program is called with the C system() function call. The external program opens the pipe as write-only and writes the values of output parameters to the pipe as if it were a standard stream file. The external program generates HTML output by writing to STDOUT. In this example, the output of the system date program is assigned to the variable result, which is the variable identified in the RETURNS clause of the FUNCTION block. This value of the result variable replaces the @today() function call in the HTML block.

Example 5: Perl language environment

```
%FUNCTION(DTW_PERL) today() RETURNS(result) {
    $date = 'date';
    chop $date;
    open(DTW, "> $ENV{DTWPIPE}") || die "Could not open: $!";
    print DTW "result = \"\$date\"\n";
}%
%HTML(INPUT) {
    @today()
}%
```

Compare this example with Example 4 to see how the EXEC block is used. In Example 4, the System language environment does not understand how to interpret Perl programs, but the language environment does know how to call external programs. The EXEC block tells it to call a program called perl as an external program. The actual Perl language statements are interpreted by the external Perl program. Example 5 has no EXEC block, because the Perl language environment is able to directly interpret Perl language statements.

Function Call (@)

Purpose

Invokes a FUNCTION block, MACRO_FUNCTION block, or built-in function with specified arguments. If the function is not a built-in function, you must define it in the Net.Data macro before you specify a function call.

Syntax

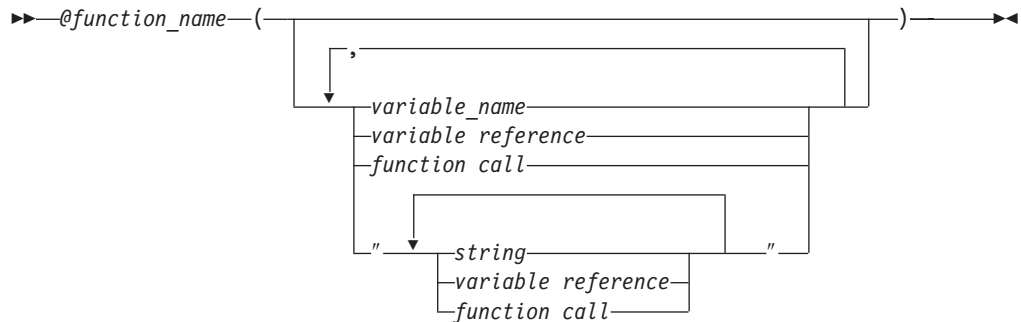

Values

@function_name

The name of any existing function. An alphabetic or numeric string that begins with an alphabetic character or underscore and contains any combination of alphabetic, numeric, or underscore characters.

variable name

A name that identifies a variable. See “Variable Name” on page 4 for syntax information.

string

Any sequence of alphabetic and numeric characters and punctuation, except the new-line character.

variable reference

Returns the value of a variable and is specified with \$ and (). For example: if `VAR='abc'`, then `$(VAR)` returns the value 'abc'. See “Variable Reference” on page 4 for syntax information.

function call

Invokes one or more FUNCTION or MACRO_FUNCTION blocks, or a Net.Data built-in function with specified arguments.

Context

Function calls can be found in these contexts:

- HTML block
- REPORT block
- ROW block
- DEFINE block
- IF block
- MACRO_FUNCTION block
- MESSAGE block
- WHILE block
- Function call statement
- Outside of any block in the declaration part of the Net.Data macro

Restrictions

- Function calls can contain these elements:
 - Comment block
 - Strings
 - Function calls
 - Variable References
- OUT or INOUT parameter values cannot contain variable references, function calls, or literal strings.

Examples

Example 1: A call to the SQL function formQuery

```
%FUNCTION(DTW_SQL) formQuery(){
SELECT $(queryVal) from $(tableName)
%}

%HTML (input){
<P>Which columns of $(tableName) do you want to see?
<FORM METHOD="POST" ACTION="report">
<INPUT NAME="queryVal" TYPE="CHECKBOX" VALUE="NAME">Name
<INPUT NAME="queryVal" TYPE="CHECKBOX" VALUE="MAIL">E-mail
<INPUT NAME="queryVal" TYPE="CHECKBOX" VALUE="FAX">FAX
<INPUT TYPE="SUBMIT" VALUE="Submit request">
%}

%HTML (report){
<P>Here are the columns you selected:
<HR>@formQuery()
%}
```

Example 2: A call to a REXX function with input and output parameters

```
%FUNCTION(DTW_REXX) my_rexx_pgm(INOUT a, b, IN c, OUT d) {
%EXEC{ mypgm.cmd this is a test %}
%}
%HTML(INPUT) {
<P> Original variable values: $(w) $(x) $(z)
<P> @my_rexx_pgm(w, x, y, z)
<P> Modified variable values: $(w) $(x) $(z)
%}
```

Example 3: A call to a REXX function, with input parameters, that uses variable references and function calls

```
%FUNCTION(DTW_REXX) my_rexx_pgm(IN a, b, c, d, OUT e) {
...
%}
%HTML(INPUT) {
<p> @my_rexx_pgm($(myA), @getB(), @retrieveC(), $(myD), myE)
%}
```

Example 4: A macro that illustrates the use of the INOUT parameter.

```
%DEFINE a = "initial value of a"

%FUNCTION(DTW_REXX) func1(INOUT x) {
Say 'value at start of function:<br>
Say 'x =' x
Say '<p>'
x = "new value of a"
%REPORT {
<p>value at start of report block:<br>
x = $(x)<br>
@dtw_assign(x, "newest value of a")
}
```

```

        value at end of report block:<br>
        x = $(x)<br>
    %}
%}

%HTML(report) {
    initial values:<br>
    a = $(a)<br>
    @func1(a)
    value after function call:<br>
    a = $(a)<br>
%}

```

Resulting output:

```

initial values:
a = initial value of a

value at start of function:
x = initial value of a

value at start of report block:
x = new value of a

value at end of report block:
x = newest value of a

value after function call:
a = newest value of a

```

HTML Block

Purpose

Defines how a Web page is to be presented. The name of the HTML block to be executed is specified on the URL when Net.Data is invoked. The HTML block can contain most Net.Data macro language statements and any valid presentation statements, such as HTML and Javascript.

Syntax

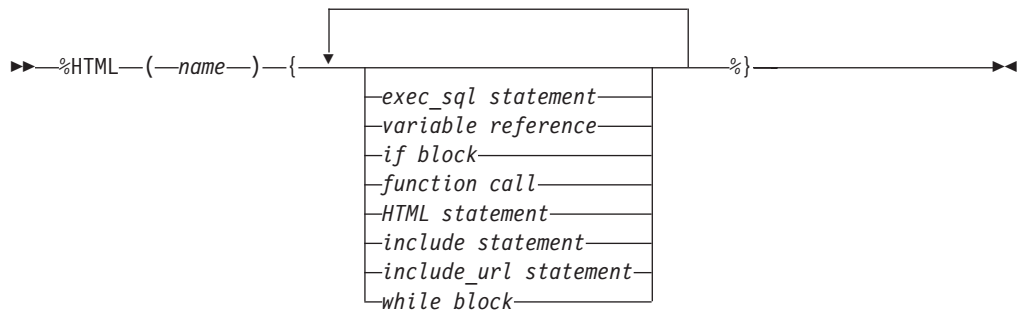

Values

`%%HTML`

The keyword that specifies the block that contains HTML tags and text to be displayed on the client's browser.

`name`

An alphabetic or numeric string that begins with an alphabetic character or underscore and contains any combination of alphabetic, numeric, or underscore characters, including periods.

`exec_sql statement`

A DB2WWW Release 1 language element that is supported for compatibility. See "Appendix B. DB2 WWW Connection" on page 311 or DB2 World Wide Web Release 1 documentation.

`variable reference`

Returns the value of a variable and is specified with `$` and `()`. For example: if `VAR='abc'`, then `$(VAR)` returns the value 'abc'. See "Variable Reference" on page 4 for syntax information.

`if block`

The IF block. Performs conditional string processing. String values in the condition list are treated as numeric for comparisons if they are strings that represent integers and have no leading or trailing white space. They can have a single leading plus (+) or minus (-) sign. See "IF Block" on page 28 for syntax and examples.

`function call`

Invokes one or more `FUNCTION` or `MACRO_FUNCTION` blocks, or a Net.Data built-in function with specified arguments. See "Function Call (@)" on page 23 for syntax and examples.

`HTML statements`

Includes any alphabetic or numeric characters, as well as HTML tags to be formatted for the client's browser.

include statement

The INCLUDE statement. Reads and incorporates a file into the Net.Data macro. See “INCLUDE Statement” on page 34 for syntax and examples.

include_url statement

The INCLUDE_URL statement. Reads and incorporates another file into the Net.Data Web macro where the statement is specified. The specified file can exist on a local or remote server. See “INCLUDE_URL Statement” on page 36 for syntax and examples.

while block

The WHILE block. Performs looping with conditional string processing. See “WHILE Block” on page 55 for syntax and examples.

Context

The HTML block can be found in these contexts:

- IF block
- Outside of any block in the declaration part of the Net.Data macro

Restrictions

The HTML block can contain these elements:

- Comment block
- EXEC_SQL statement
- IF block
- HTML statements
- INCLUDE statement
- INCLUDE_URL statement
- WHILE block
- Variable references
- Function calls

Examples

Example 1: HTML block with include files for headings and footings

```
%HTML(example1){
%INCLUDE"header.html"
<P>You can put <EM>any</EM> HTML in an HTML block.
An SQL function call is made like this:
@xmp1()
%INCLUDE"footer.html"
%}
```

Example 2: HTML block with a name that contains a period

```
%HTML(my.report){
%INCLUDE"header.html"
<P>You can put <EM>any</EM> HTML in an HTML block.
An SQL function call is made like this:
@xmp1()
%INCLUDE"footer.html"
%}
```

IF Block

Purpose

Performs conditional string processing. The IF block provides the ability to test one or more conditions, and then to perform a block of statements based on the outcome of the condition test. You can use the IF block in the declaration part of a Net.Data macro, the HTML block, the MACRO_FUNCTION block, the REPORT block, the WHILE block, and the ROW block, as well as nest it inside another IF block.

String values in the condition list are treated as numeric for comparisons if they are strings that represent integers and have no leading or trailing white space. They can have a single leading plus (+) or minus (-) sign.

Restriction: Net.Data does not support numerical comparison of non-integer numbers; for example, floating point numbers.

Nested IF blocks: The rules for IF block syntax are determined by the block's position in the macro. If an IF block is nested within an IF block that is outside of any other block in the declaration part, it can use any element that the outside block can use. If an IF block is nested within another block that is in an IF block, it takes on the syntax rules for the block it is inside.

In the following example, the nested IF block must follow the rules used when it is inside an HTML block.

```
%IF block
...
  %HTML block
...
  %IF block
```

You can nest up to 1024 IF blocks.

Syntax

►►%IF | condition list | statement_block | else_if spec | %ENDIF◄◄

condition list:

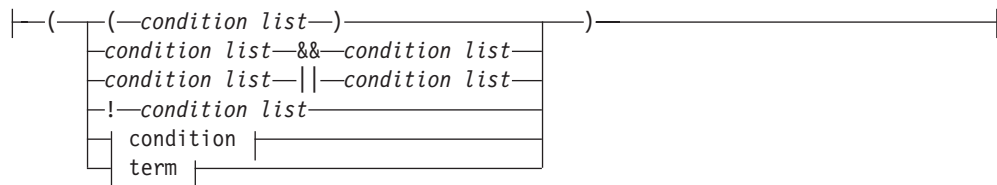

statement_block:

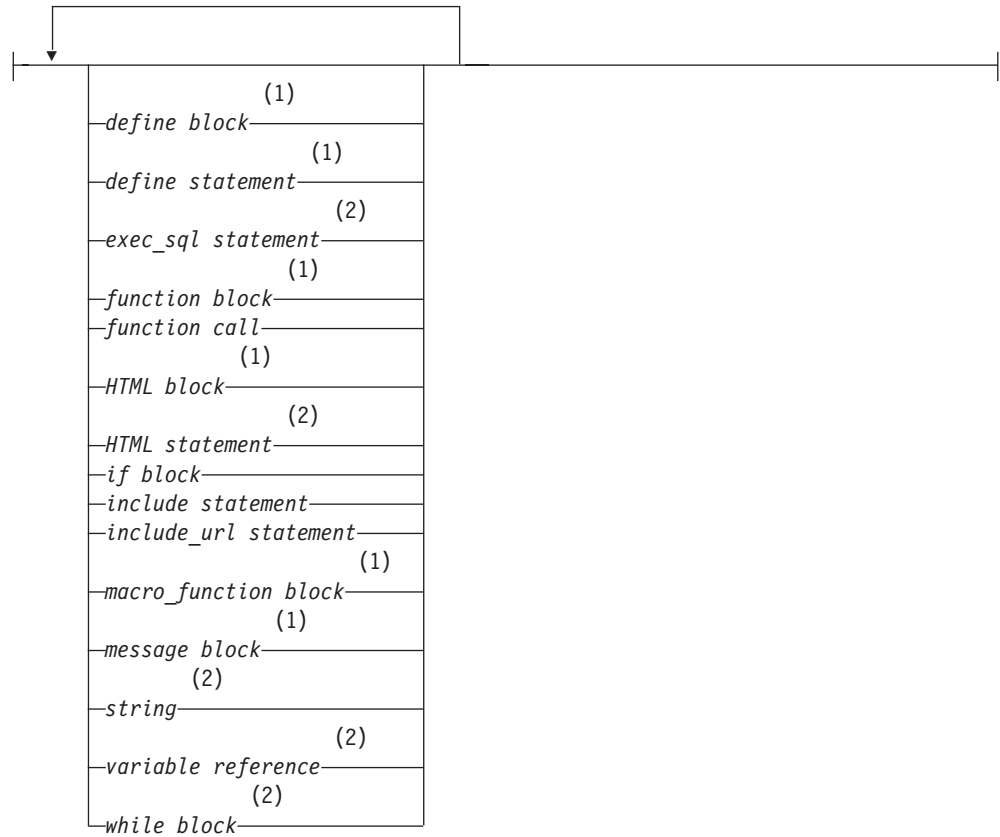

condition:



term:

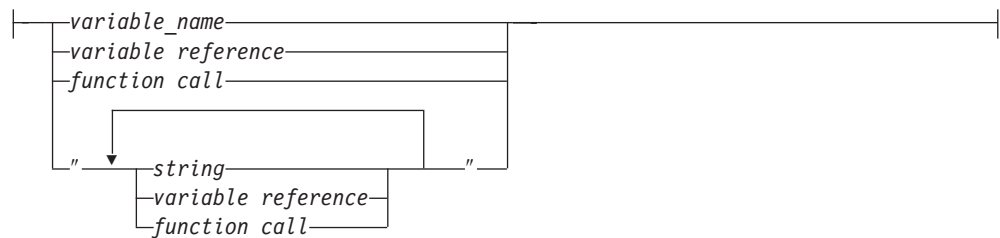

else_if spec:

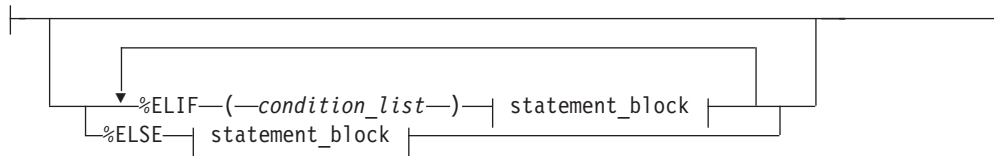

Notes:

- 1 This language construct is valid when the IF block is located outside of any other block in the declaration part of the macro.
- 2 This language construct is valid when the IF block is located in an HTML block, MACRO_FUNCTION block, REPORT block, ROW block, or WHILE block.

Values

%IF

The keyword that specifies conditional string processing.

condition list

Compares the values of conditions and terms. Condition lists can be connected using Boolean operators. A condition list can be nested inside another condition list.

statement_block

The following valid Net.Data macro constructs. Please see diagram notes and restrictions to determine the context in which the macro constructs are valid.

define statement

The DEFINE block or statement. Defines variables and sets configuration variables. Variable names must begin with a letter or underscore (_) and contain any alphanumeric characters or underscore. See “DEFINE Block or Statement” on page 9 for syntax and examples.

exec_sql statement

A DB2WWW Release 1 language element that is supported for compatibility. See “Appendix B. DB2 WWW Connection” on page 311 or DB2 World Wide Web Release 1 documentation.

function block

A keyword that specifies a subroutine that can be invoked from the Net.Data macro. The executable statements in a FUNCTION block can contain language statements that are directly interpreted by a language environment, or they can indicate a call to an external program. See “FUNCTION Block” on page 16 for syntax and examples.

function call

Invokes one or more FUNCTION or MACRO_FUNCTION blocks, or a Net.Data built-in function with specified arguments. See “Function Call (@)” on page 23 for syntax and examples.

HTML block

Includes any alphabetic or numeric characters, as well as HTML tags to be formatted for the client’s browser.

HTML statement

Includes any alphabetic or numeric characters, and HTML tags to be formatted for the client’s browser.

if block

The IF block. Performs conditional string processing. String values in the condition list are treated as numeric for comparisons if they are strings that represent integers and have no leading or trailing white space. They can have a single leading plus (+) or minus (-) sign.

include statement

The INCLUDE statement. Reads and incorporates a file into the Net.Data macro. See “INCLUDE Statement” on page 34 for syntax and examples.

include_url statement

The INCLUDE_URL statement. Reads and incorporates another file into the Net.Data Web macro where the statement is specified. The specified file can exist on a local or remote server. See “INCLUDE_URL Statement” on page 36 for syntax and examples.

macro_function block

A keyword that specifies a subroutine that can be invoked from the Net.Data macro. The executable statements in a MACRO_FUNCTION block can contain Net.Data macro language source statements. See “MACRO_FUNCTION Block” on page 40 for syntax and examples.

message block

The MESSAGE block. A set of return codes, the associated messages, and the actions Net.Data takes when a function call is returned. See “MESSAGE Block” on page 44 for syntax and examples.

string

Any sequence of alphabetic and numeric characters and punctuation. If the string is in the term of the condition list, it can contain any character except the new-line character. If the string is in the executable block of code, it can contain any character, including the new-line character.

variable reference

Returns the value of a variable and is specified with \$ and (). For example: if VAR= 'abc', then \$(VAR) returns the value 'abc'. See “Variable Reference” on page 4 for syntax information.

while block

The WHILE block. Performs looping with conditional string processing. See “WHILE Block” on page 55 for syntax and examples

condition

A comparison between two terms using comparison operators. An IF condition is treated as a numeric comparison if both of the following conditions are true:

- The condition operator is one of the following operators: <, <=, >, >=, ==, !=
- Both terms are strings representing valid integers, where a valid integer is a string of digits, optionally preceded by a plus (+) or minus (-) sign, and no other white space.

If either condition is not true, a normal string comparison is performed.

term

A variable name, string, variable reference, or function call.

%ELIF

A keyword that starts the alternative processing path and can contain condition lists and most Net.Data macro statements.

%ENDIF

A keyword that closes the %IF block.

%ELSE

A keyword that executes associated statements if all other condition lists are not satisfied.

Context

The IF block can be found in these contexts:

- Outside of any other block in the declaration part of a Net.Data macro
- HTML block
- IF block
- MACRO_FUNCTION block
- REPORT block
- ROW block
- WHILE block

Restrictions

The IF block can contain these elements when located outside of any other block in the declaration part of the Net.Data macro:

- Comment block
- DEFINE block
- DEFINE statement
- FUNCTION block
- Function call
- HTML block
- IF block
- INCLUDE statement
- INCLUDE_URL statement
- MACRO_FUNCTION block
- MESSAGE block
- Variable reference

The IF block can contain these elements when located in the HTML block, MACRO_FUNCTION block, REPORT block, ROW block, or WHILE block of the Net.Data macro:

- Comment block
- EXEC_SQL statement
- Function calls
- IF block
- INCLUDE statement
- INCLUDE_URL statement
- HTML statement
- String
- Variable reference
- WHILE block

You can nest up to 1024 IF blocks.

Examples

Example 1: An IF block in the declaration part of a Net.Data macro

```
%DEFINE a = "1"
%DEFINE b = "2"
...
%IF ($(DTW_HTML_TABLE) == "YES")
  %define OUT_FORMAT = "HTML"
%ELSE
  %define OUT_FORMAT = "CHARACTER"
%ENDIF
```

```
%HTML(REPORT) {  
    ...  
%}
```

Example 2: An IF block inside an HTML block

```
%HTML(REPORT) {  
    @myFunctionCall()  
    %IF ($RETURN_CODE) == $(failure_rc)  
        <P> The function call failed with failure code $(RETURN_CODE).  
    %ELIF ($(RETURN_CODE) == $(warning_rc))  
        <P> The function call succeeded with warning code $(RETURN_CODE).  
    %ELIF ($(RETURN_CODE) == $(success_rc))  
        <P>The function call was successful.  
    %ELSE  
        P>The function call returned with unknown return code $(RETURN_CODE).  
    %ENDIF  
%}
```

Example 3: A numeric comparison

```
%IF (ROW_NUM < "100")  
    <p>The table is not full yet...  
%ELIF (ROW_NUM == "100")  
    <p>The table is now full...  
%ELSE  
    <p>The table has overflowed...  
%ENDIF
```

A numeric comparison is done because the implicit table variable ROW_NUM always returns an integer value, and the value that is being compared is also an integer.

Example 4: Nested IF blocks

```
%IF (MONTH == "January")  
    %IF (DATE = "1")  
        HAPPY NEW YEAR!  
    %ELSE  
        Ho hum, just another day.  
    %ENDIF  
%ENDIF
```

INCLUDE Statement

Purpose

Reads and incorporates a file into the Net.Data macro in which the statement is specified.

Net.Data searches the directories specified in the INCLUDE_PATH statement in the initialization file to find the include file.

You can use include files the same way you can in most high-level languages. They can insert common headings and footings, define common sets of variables, or incorporate a common subroutine library of FUNCTION block definitions into a Net.Data macro.

Net.Data executes an INCLUDE statement only once when processing the macro and inserts the content of the included file at the location of the INCLUDE statement in the macro. Any variable references in the name of the included file are resolved at the time the INCLUDE statement is first executed, not when the content of the included file is to be executed.

When an INCLUDE statement is in a ROW or WHILE block, Net.Data does not repeatedly execute the INCLUDE statement. Net.Data executes the INCLUDE statement the first time it executes the ROW or WHILE block, incorporates the content of the included file into the block, and then repeatedly executes the ROW or WHILE block with the content of the included file.

Authorization Tip: Ensure that the user ID under which Net.Data executes has access rights to any files referenced by the INCLUDE statement. See the section on specifying Web server access rights to Net.Data files in the configuration chapter of *Net.Data Administration and Programming Guide* for more information.

Tip: If you want to include an HTML file from a local Web server, use the INCLUDE_URL construct as shown in Example 3 for INCLUDE_URL. By using the demonstrated syntax, you do not have to update the INCLUDE_PATH in the Net.Data initialization file to specify directories that are already known to the Web server.

Syntax

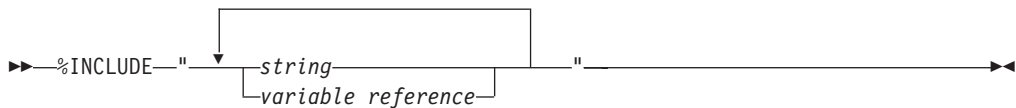

Values

%INCLUDE

The keyword that indicates a file is to be read and incorporated into the Net.Data macro.

name

An alphabetic or numeric string beginning with an alphabetic character or underscore and containing any combination of alphabetic, numeric, or underscore characters.

string

Any sequence of alphabetic and numeric characters and punctuation, except the new-line character.

variable reference

Returns the value of a variable and is specified with \$ and (). For example: if VAR='abc', then \$(VAR) returns the value 'abc'. See "Variable Reference" on page 4 for syntax information.

Context

The INCLUDE statement can be found in these contexts:

- DEFINE block
- HTML block
- REPORT block
- ROW block
- IF block
- MESSAGE block
- MACRO_FUNCTION block
- WHILE block
- Outside of any block in the declaration part of the Net.Data macro

Restrictions

The INCLUDE statement can contain these elements:

- Comment block
- Strings
- Variable references

Function calls in the string are not allowed.

You can nest up to ten INCLUDE statements.

Examples

Example 1: An INCLUDE statement in an HTML block

```
%HTML(start){  
%INCLUDE "header.hti"  
...  
%}
```

Example 2: An INCLUDE statement in a REPORT block

```
%REPORT {  
  %INCLUDE "report_header.txt"  
  %ROW {  
    %INCLUDE "row_include.txt"  
  }  
  %INCLUDE "report_footer.txt"  
%}
```

Example 3: Variable references in an INCLUDE statement

```
%define REMOTE_USER = %ENVVAR  
%include "$(REMOTE_USER).hti"
```

INCLUDE_URL Statement

Purpose

Reads and incorporates another file into the Net.Data generated output in which the statement is specified. The specified file can exist on a local or remote server.

Using the INCLUDE_URL statement, you can invoke one macro from another macro without requiring the application user to select a Submit button.

Net.Data executes an INCLUDE_URL statement only once when processing the macro and inserts the content of the included file at the location of the INCLUDE_URL statement in the macro. Any variable references in the name of the included file are resolved at the time the INCLUDE_URL statement is first executed, not when the content of the included file is to be executed.

When an INCLUDE_URL statement is in a ROW or WHILE block, Net.Data does not repeatedly execute the INCLUDE_URL statement. Net.Data executes the INCLUDE_URL statement the first time it executes the ROW or WHILE block, incorporates the content of the included file into the block, and then repeatedly executes the ROW or WHILE block with the content of the included file.

Syntax

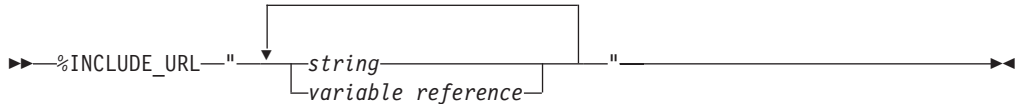

Values

%INCLUDE_URL

The keyword that indicates that a file is to be read and incorporated into the Net.Data macro from the local or a remote server.

string

Any sequence of alphabetic and numeric characters and punctuation, except the new-line character.

variable reference

Returns the value of a variable and is specified with \$ and (). For example: if VAR='abc', then \$(VAR) returns the value 'abc'. See "Variable Reference" on page 4 for syntax information.

Context

INCLUDE_URL statements can be found in these contexts:

- DEFINE block
- HTML block
- IF block
- MACRO_FUNCTION block
- MESSAGE block
- REPORT block
- ROW block
- WHILE block
- Outside of any block in the declaration part of the Net.Data macro

Restrictions

INCLUDE_URL statements can contain these elements:

- Comment block
- Strings
- Variable references

On OS/390, the INCLUDE_URL file can be up to 256 KB. Other operating systems do not have a limit.

When using the INCLUDE_URL statement, do not start an infinite sequence of macro requests by invoking the current macro recursively.

INCLUDE_URL is *not* supported in the OS/400 environment.

Examples

Example 1: Including an HTML file from another server

```
%include_url "http://www.ibm.com/path/myfile.html"
```

Example 2: Including an HTML file from a remote server by calling the server name

```
%include_url "myserver/path/myfile.html"
```

Where myservers is the server name.

Example 3: Including an HTML file from the local Web server

```
%include_url "/path/myfile.html"
```

Tip: By using this method, you do not have to update the INCLUDE_URL path in the Net.Data configuration file to specify directories that are already known to the Web server. If the *string* does *not* begin with a slash, Net.Data assumes the string is a server name and attempts to retrieve the file from the server with the corresponding name.

Example 4: Including other Net.Data macros from a remote server

```
%REPORT{  
<P>Current hot pick as of @DTW_rTIME():  
%include_url "http://www.ibm.com/cgi-bin/db2www/hotpic.mac/report?custno=$(custno)"
```

In this example, the macro hotpic.mac is called and custno is sent as a variable. If the *string* begins with a slash, Net.Data retrieves the INCLUDE file from the local Web server.

LIST Statement

Purpose

Builds a delimited list of values. You can use the LIST statement when you construct SQL queries with multiple items like those found in some WHERE or HAVING clauses.

Syntax

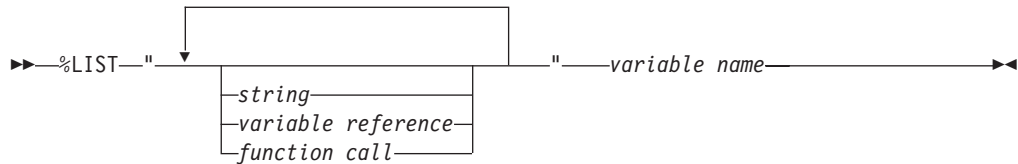

Values

%LIST

The keyword that specifies that variables are to be used to build a delimited list of values.

string

Any sequence of alphabetic and numeric characters and punctuation, except the new-line character.

variable reference

Returns the value of a variable and is specified with \$ and (). For example: if VAR='abc', then \$(VAR) returns the value 'abc'. See "Variable Reference" on page 4 for syntax information.

function call

Invokes one or more FUNCTION or MACRO_FUNCTION blocks, or a Net.Data built-in function with specified arguments. See "Function Call (@)" on page 23 for syntax and examples.

variable name

A name that identifies a variable. See "Variable Name" on page 4 for syntax information.

Context

The LIST statement can be found in these contexts:

- DEFINE statement

Restrictions

The LIST statement can contain these elements:

- Comment block
- Variable references
- Function calls
- Strings

Examples

Example 1: A list of variables

```
%DEFINE{  
DATABASE="custcity"  
%LIST " OR " conditions  
conditions="cond1='Sao Paolo'"
```

```
conditions="cond2='Seattle'"
conditions="cond3='Shanghai'"
whereClause=conditions ? "WHERE ${conditions}" : ""
%}
```

MACRO_FUNCTION Block

Purpose

Defines a subroutine that can be invoked from the Net.Data macro. The executable statements in a MACRO_FUNCTION block must be Net.Data macro language source statements.

Syntax

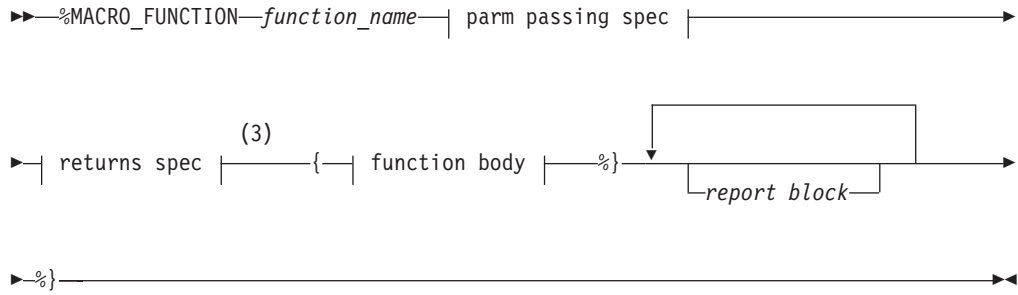

parm passing spec:

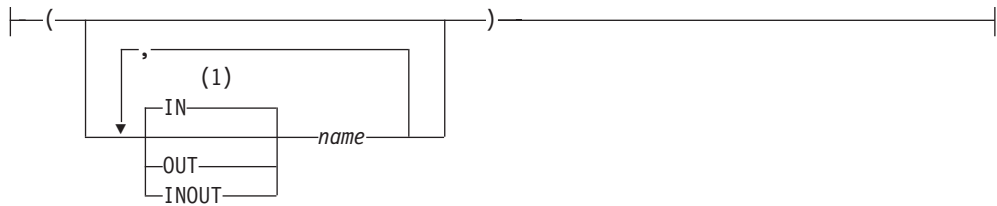

returns spec:



function body:

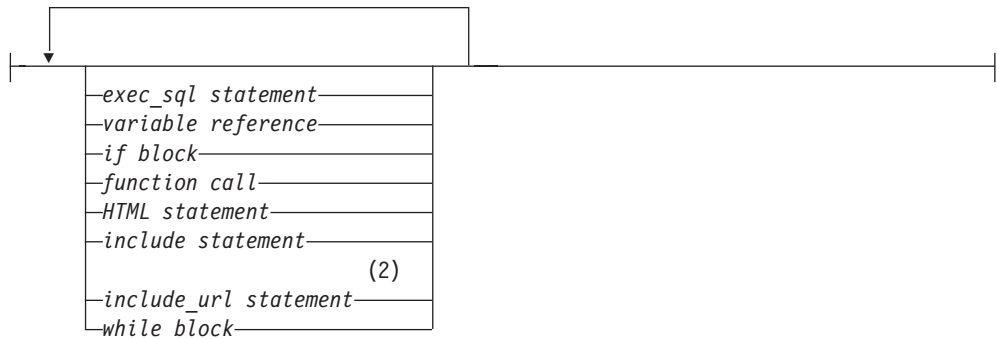

Notes:

- 1 The default parameter type of IN applies when no parameter type is specified at the beginning of the parameter list. A parameter without a parameter type uses the type most recently specified in the parameter list, or type IN if no type has been specified. For example, in the parameter list (*parm1*, INOUT *parm2*, *parm3*, OUT *parm4*, *parm5*), parameters *parm1*, *parm3*, and *parm5* do not have parameter types. The parameter *parm1* has a type of IN because no initial parameter type has been specified. The parameter *parm3* has a type of INOUT because it is the most recently specified parameter type. Similarly, the parameter *parm5* has a type of OUT because it is the most recently specified type in the parameter list.
- 2 The INCLUDE_URL statement is not supported by OS/400.
- 3 The RETURNS statement is supported on OS/390 and OS/400 only.

Values

%MACRO_FUNCTION

The keyword that specifies a subroutine that can be invoked from the Net.Data macro. The executable statements in a MACRO_FUNCTION block must contain language statements that Net.Data directly interprets.

function_name

The name of the function being defined. An alphabetic or numeric string that begins with an alphabetic character or underscore and contains any combination of alphabetic, numeric, or underscore characters.

parm passing spec:

IN Specifies that Net.Data passes input data to the language environment. IN is the default.

OUT

Specifies that the language environment returns output data to Net.Data.

INOUT

Specifies that Net.Data passes input data to the language environment and the language environment returns output data to Net.Data.

name

An alphabetic or numeric string beginning with an alphabetic character or underscore and containing any combination of alphabetic, numeric, or underscore characters. *name* can represent a Net.Data table or a result set.

returns spec:

RETURNS

Declares the variable that contains the function value after the function completes.

function body:

exec_sql

A DB2WWW Release 1 language element that is supported for compatibility. See "Appendix B. DB2 WWW Connection" on page 311 or DB2 World Wide Web Release 1 documentation.

variable reference

Returns the value of a variable and is specified with \$ and (). For example: if VAR= 'abc', then \$(VAR) returns the value 'abc'. See "Variable Reference" on page 4 for syntax information.

if block

The IF block. Performs conditional string processing. String values in the condition list are treated as numeric for comparisons if they represent integers and have no leading or trailing white space. They might have one leading plus (+) or minus (-) sign.

function call

Invokes one or more FUNCTION or MACRO_FUNCTION blocks, or a Net.Data built-in function with specified arguments. See "Function Call (@)" on page 23 for syntax and examples.

HTML statement

Includes any alphabetic or numeric characters, as well as HTML tags to be formatted for the client's browser.

include statement

The INCLUDE statement. Reads and incorporates a file into the Net.Data macro. See "INCLUDE Statement" on page 34 for syntax and examples.

include_url statement

The INCLUDE_URL statement. Reads and incorporates another file into the Net.Data macro in which the statement is specified. The specified file can exist on a local or remote server. See "INCLUDE_URL Statement" on page 36 for syntax and examples.

while block

The WHILE block. Performs looping with conditional string processing. See "WHILE Block" on page 55 for syntax and examples.

report block

The REPORT block. Formatting instructions for the output of a function call. You can use header and footer information for the report. See "REPORT Block" on page 48 for syntax and examples.

Context

The MACRO_FUNCTION block can be found in these contexts:

- IF block
- Outside of any block in the declaration part of the Net.Data macro

Restrictions

The MACRO_FUNCTION block can contain these elements:

- Comment block
- EXEC_SQL statement
- HTML statements
- IF block
- INCLUDE statement
- INCLUDE_URL statement

Not supported for OS/400

- REPORT block
- WHILE block
- Variable references
- Function calls

Examples

Example 1: A macro function that specifies message handling

```
%MACRO_FUNCTION setMessage(IN rc, OUT message) {
%IF (rc == "0")
  @dtw_assign(message, "Function call was successful.")
%ELIF (rc == "-1")
  @dtw_assign(message, "Function failed, out of memory.")
}
```

```

%ELIF (rc == "-2")
    @dtw_assign(message, "Function failed, invalid parameter.")
%ENDIF
%}

```

Example 2: A macro function that specifies header information

```

%MACRO_FUNCTION setup(IN browserType) {
%{ call this function at the top of each HTML block in the macro %}
%INCLUDE "header_info.html"
@dtw_rdate()
%IF (browserType == "IBM")
    @setupIBM()
%ELIF (browserType == "MS")
    @setupMS()
%ELIF (browserType == "NS")
    @setupNS()
%ELSE
    @setupDefault()
%ENDIF
%}

```

Example 3: A macro function that contains a REPORT block

```

%MACRO_FUNCTION myfunc (INOUT table) {
    %REPORT {
        <table>
        %ROW {
            <tr><td>$(V1)</td><td>$(V2)</td></tr>
        %}
        </table>
    %}
%}

```

Example 4: A macro function that uses the RETURNS keyword

```

%MACRO_FUNCTION myfunc () RETURNS(VALUE) {
    @DTW_ASSIGN(VALUE, "Success...")
%}

```

MESSAGE Block

Purpose

Specifies messages to display and actions to take based on the return code from a function.

Define the set of return codes, along with their corresponding messages and actions in the MESSAGE block. When a function call completes, Net.Data compares its return code with return codes defined in the MESSAGE block. If the function's return code matches one in the MESSAGE block, Net.Data displays the message and evaluates the action to determine whether to continue processing or exit the Net.Data macro.

A MESSAGE block can be global in scope, or local to a single FUNCTION block. If the MESSAGE block is defined at the outermost macro layer, it is considered global in scope. When multiple global MESSAGE blocks are defined, only the last block processed is considered active. If the MESSAGE block is defined inside a FUNCTION block, the block is local in scope to the FUNCTION block where it is defined. See the MESSAGE block section in the *Net.Data Administration and Programming Guide* for return code processing rules.

Syntax

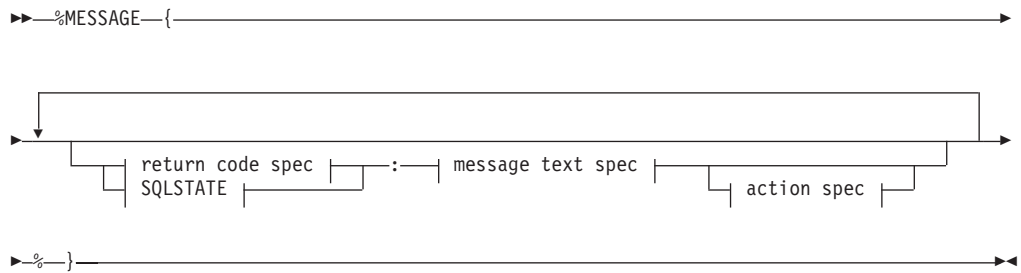

return code spec:



SQLSTATE:



message text spec:

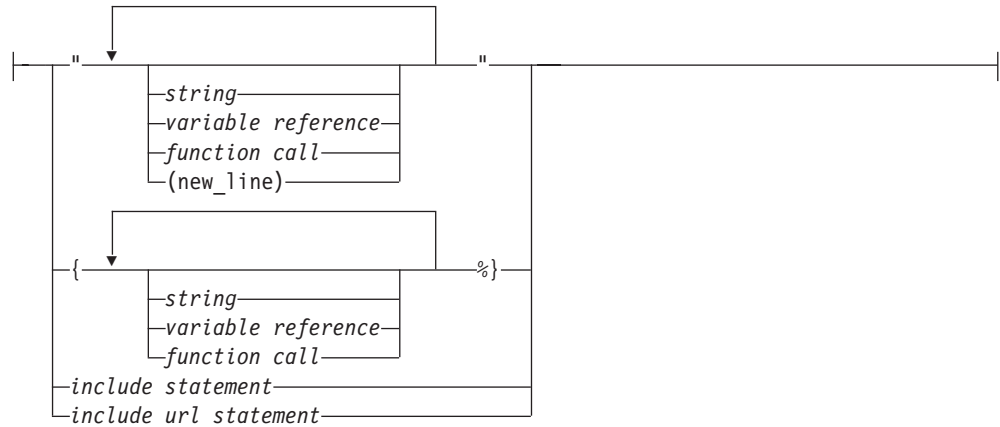

action spec:



Values

%MESSAGE

A keyword for the block that defines a set of return codes, the associated messages, and the actions Net.Data takes when a function call is returned.

return code spec

A positive or negative integer. If the value of the Net.Data RETURN_CODE variable matches the *return code spec* value, the remaining information in the message statement is used to process the function call. You can also specify messages for return codes not specifically entered in the MESSAGE block.

+DEFAULT

A keyword used to specify a default positive message code. Net.Data uses the information in this message statement to process the function call if RETURN_CODE is greater than zero (0) and an exact match is not specified.

-DEFAULT

A keyword to specify a default negative message code. Net.Data uses the information in this message statement to process the function call if RETURN_CODE is less than zero (0) and an exact match is not specified.

DEFAULT

A keyword to specify the default message code. Net.Data uses the information in this message statement to process the function call, if all of the following conditions are met:

- If RETURN_CODE is greater or less than zero, but not zero
- If no exact match for the return code is specified
- If the +DEFAULT or -DEFAULT values are not specified for when RETURN_CODE is greater or less than zero

msg_code

The message code that specifies errors and warnings that can occur during processing. A string of numeric digits with values from 0 to 9.

SQLSTATE

A keyword that provides application programs with common codes for common error conditions. The SQLSTATE values are based on the SQLSTATE specification contained in the SQL standard and the coding scheme is the same on all IBM implementations of SQL.

state_id

The SQLSTATE. An alphanumeric string of five characters (bytes) with a format of *ccsss*, where *cc* indicates class and *sss* indicates subclass.

message text spec

A string that is sent to the Web browser if the RETURN_CODE matches the *return_code* value in the current message statement.

string

Any sequence of alphabetic and numeric characters and punctuation. If the string appears within double quotes, the new-line character is not allowed.

variable reference

Returns the value of a variable and is specified with \$ and (). For example: if VAR='abc', then \$(VAR) returns the value 'abc'. See "Variable Reference" on page 4 for syntax information.

function call

Invokes one or more FUNCTION or MACRO_FUNCTION blocks, or a Net.Data built-in function with specified arguments. See "Function Call (@)" on page 23 for syntax and examples.

action spec

Determines what action Net.Data takes if the RETURN_CODE matches the *return_code* value in the current message statement.

EXIT

A keyword that specifies to exit the macro immediately when the error or warning corresponding to the specified message code occurs. This value is the default.

CONTINUE

A keyword that specifies to continue processing when the error or warning corresponding to the specified message code occurs.

include statement

The INCLUDE statement. Reads and incorporates a file into the Net.Data macro. The INCLUDE statement can appear anywhere in the MESSAGE. See "INCLUDE Statement" on page 34 for syntax and examples.

include_url statement

The INCLUDE_URL statement. Reads and incorporates another file into the Net.Data macro in which the statement is specified. The specified file can exist on a local or remote server. See "INCLUDE_URL Statement" on page 36 for syntax and examples.

Context

The MESSAGE block can be found in these contexts:

- FUNCTION block
- IF block
- Outside of all blocks or statements in the declaration part of the Net.Data macro

Restrictions

The MESSAGE block can contain these elements:

- Comment block
- Function calls
- Variable references
- HTML statements
- Strings
- INCLUDE statement
- INCLUDE_URL statements

For OS/390, OS/2, Windows NT, and UNIX operating systems: SQL functions cannot be called from inside SQL functions.

Examples

Example 1: A local MESSAGE block

```
%{ local message block inside a FUNCTION block %}
%FUNCTION(DTW_REXX) my_function() {
  %EXEC { my_command.cmd %}
  %MESSAGE{
-601: {<H3>The table has already been created, please go back and enter your name.</H3>
<P><a href="input">Return</a>
%}
default: "<H3>Can't continue because of error $(RETURN_CODE)</H3>"%}      : exit
%}
```

Example 2: A global MESSAGE block

```
%{ global message block %}
%MESSAGE {
  -100      : "Return code -100 message"      : exit
  100      : "Return code 100 message"       : continue
  +default : {
This is a long message that spans more
than one line. You can use HTML tags, including
links and forms, in this message. %} : continue
%}

%{ local message block inside a FUNCTION block %}
%FUNCTION(DTW_REXX) my_function() {
  %EXEC { my_command.cmd %}
  %MESSAGE {
  -100      : "Return code -100 message"      : exit
  100      : "Return code 100 message"       : continue
  -default : {
This is a long message that spans more
than one line. You can use HTML tags, including
links and forms, in this message. %} : exit
%}
```

Example 3: A MESSAGE block containing INCLUDE statements.

```
%message {
  %include "rc1000.msg"
  %include "rc2000.msg"
  %include "defaults.msg"
%}
```

REPORT Block

Purpose

Formats output from a function call. You can enter a table name parameter to specify that the report is to use the data in the named table. Otherwise, the report is generated with the first output table found in the function parameter list, or with the default table data if no table name is in the list.

Syntax

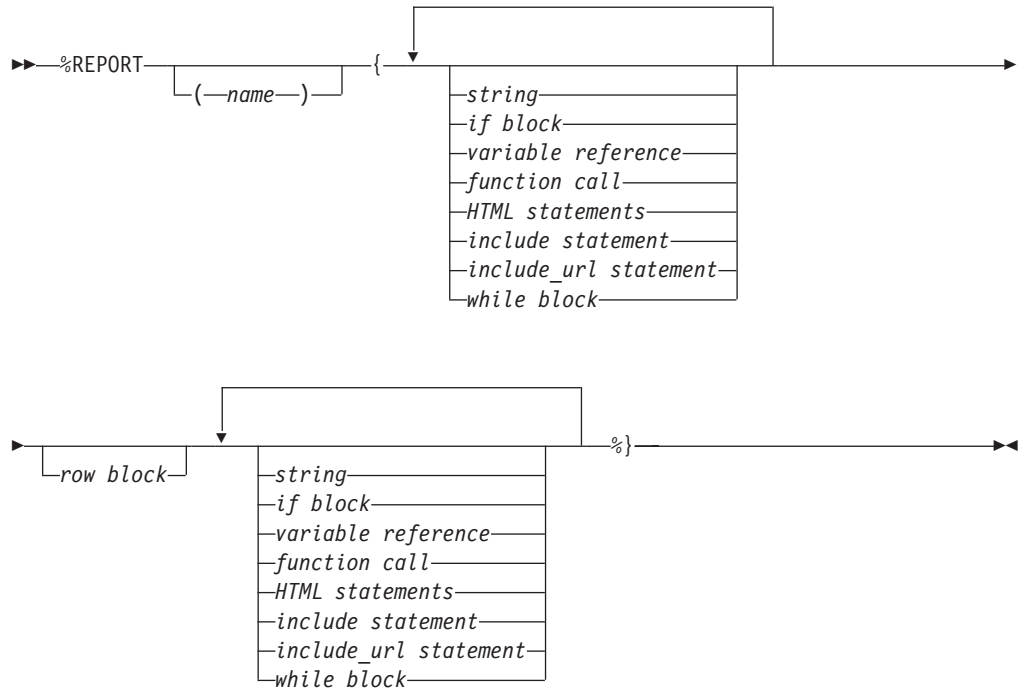

Values

%REPORT

The keyword for specifying formatting instructions for the output of a function call. You can use header and footer information for the report.

name

This value represents a Net.Data table or result set. See the Report Block section in the *Net.Data Administration & Programming Guide* for more information.

string

Any sequence of alphabetic and numeric characters and punctuation.

if block

The IF block. Performs conditional string processing. String values in the condition list are treated as numeric for comparisons if they represent integers and have no leading or trailing white space. They can have one leading plus (+) or minus (-) sign. See "IF Block" on page 28 for syntax and examples.

variable reference

Returns the value of a variable and is specified with \$ and (). For example: if VAR='abc', then \$(VAR) returns the value 'abc'. See "Variable Reference" on page 4 for syntax information.

function call

Invokes one or more FUNCTION or MACRO_FUNCTION blocks, or a Net.Data built-in function with specified arguments. See “Function Call (@)” on page 23 for syntax and examples.

HTML statements

Includes any alphabetic or numeric characters, as well as HTML tags to be formatted for the client’s browser.

include statement

The INCLUDE statement. Reads and incorporates a file into the Net.Data macro. See “INCLUDE Statement” on page 34 for syntax and examples.

include_url statement

The INCLUDE_URL statement. Reads and incorporates another file into the Net.Data macro in which the statement is specified. The specified file can exist on a local or remote server. See “INCLUDE_URL Statement” on page 36 for syntax and examples.

row block

The ROW block. Displays HTML formatted data once for each row of data that is returned from a function call. See “ROW Block” on page 51 for syntax and examples.

while block

The WHILE block. Performs looping with conditional string processing. See “WHILE Block” on page 55 for syntax and examples.

Context

The REPORT block can be found in these contexts:

- FUNCTION statement or block

Restrictions

The REPORT block can contain these elements:

- Comment block
- IF block
- INCLUDE statements
- INCLUDE_URL statements
- ROW blocks
- WHILE blocks
- Function calls

For OS/390, OS/2, Windows NT, and UNIX operating systems: SQL functions cannot be called from inside SQL functions.

- HTML statements
- Strings
- Variable references

For OS/390: REPORT blocks are not allowed in MACRO_FUNCTION blocks.

Examples

Example 1: A two-column HTML table showing a list of names and locations

```
%FUNCTION(DTW_SQL) mytable() {
  %REPORT{
    <H2>Query Results</H2>
    <P>Select a name for details.
    <TABLE BORDER=1>
    <TR><TD>Name</TD><TD>Location</TD>
  %ROW{
    <TR>
    <TD>
```

```
<a href="/cgi-bin/db2www/name.mac/details?name=$(V1) &location=$(V2)">$(V1)</a></TD>
<TD>$(V2)</TD>
%}
</TABLE>
%}
```

Selecting a name in the table calls the *details* HTML block of the *name.mac* Net.Data macro and sends it the two values as part of the URL. In this example, the values can be used in *name.mac* to look up additional details about the name.

ROW Block

Purpose

Processes each table row returned from a function call. Net.Data processes the statements within the ROW block once for each row.

Syntax

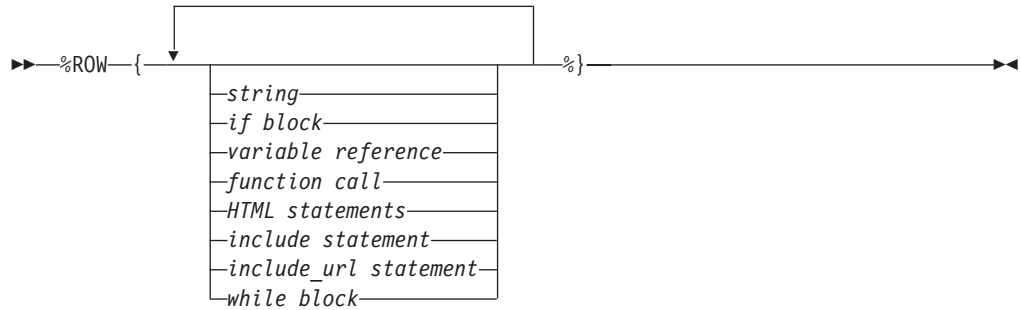

Values

`%ROW`

The keyword that specifies that HTML formatted data is to be displayed, once for each row of data returned from a function call.

`string`

Any sequence of alphabetic and numeric characters and punctuation.

`if block`

The IF block. Performs conditional string processing. String values in the condition list are treated as numeric for comparisons if they are strings that represent integers and have no leading or trailing white space. They can have a single leading plus (+) or minus (-) sign. See “IF Block” on page 28 for syntax and examples.

`variable reference`

Returns the value of a variable and is specified with \$ and (). For example: if `VAR='abc'`, then `$(VAR)` returns the value 'abc'. See “Variable Reference” on page 4 for syntax information.

`function call`

Invokes one or more FUNCTION or MACRO_FUNCTION blocks, or built-in functions with specified arguments. See “Function Call (@)” on page 23 for syntax and examples.

`HTML statements`

Includes any alphabetic or numeric characters, as well as HTML tags to be formatted for the client’s browser.

`include statement`

The INCLUDE statement. Reads and incorporates a file into the Net.Data macro. See “INCLUDE Statement” on page 34 for syntax and examples.

`include_url statement`

The INCLUDE_URL statement. Reads and incorporates another file into the Net.Data macro in which the statement is specified. The specified file can exist on a local or remote server. See “INCLUDE_URL Statement” on page 36 for syntax and examples.

while block

The WHILE block. Performs looping with conditional string processing. See “WHILE Block” on page 55 for syntax and examples.

Context

The ROW block can be found in these contexts:

- REPORT block

Restrictions

The ROW block can contain these elements:

- Comment block
- IF blocks
- INCLUDE statements
- INCLUDE_URL statements
- WHILE blocks
- Function calls

For OS/390, OS/2, Windows NT, and UNIX operating systems: SQL functions cannot be called from inside SQL functions.

- Variable references
- HTML statements
- Strings

Examples

Example 1: A two-column HTML table showing a list of names and locations

```
%REPORT{
<H2>Query Results</H2>
<P>Select a name for details.
<TABLE BORDER=1>
<TR><TD>Name</TD><TD>Location</TD>

%ROW{
<TR>
<TD>
<a href="/cgi-bin/db2www/name.mac/details?name=$(V1)&location=$(V2)">$(V1)</a></TD>
<TD>$(V2)</TD>
%}

</TABLE>
%}
```

Selecting a name in the table calls the *details* HTML block of the *name.mac* Net.Data macro and sends it the two values as part of the URL. In this example, the values can be used in *name.mac* to look up additional details about the name.

TABLE Statement

Purpose

Defines a variable which is a collection of related data. The variable contains a set of rows and columns including a row of column headers describing the fields in each row. A table statement can only be in a DEFINE statement or block.

When a TABLE variable is referenced, Net.Data displays the content of the table as either a plain character table, or as an HTML table if the DTW_HTML_TABLE variable is set to YES.

Syntax

```
»» %TABLE | upper limit |
```

upper limit:

```
|  
| ( number )  
| ALL
```

Values

%TABLE

A keyword that specifies the definition of a collection of related data containing an array of identical records, or rows, and an array of column names describing the fields in each row.

upper limit

The number of rows that can be contained in the table. If the upper limit value is not specified, the table can contain an unlimited number of rows.

number

A string of digits with values from 0 to 9. A value of 0 allows for unlimited number of rows in the table.

ALL

A keyword that allows for an unlimited number of rows in the table.

Context

The TABLE statement can be found in these contexts:

- DEFINE statement

Restrictions

The TABLE statement can contain these elements:

- Comment block
- Numbers

Examples

Example 1: A Net.Data table with an upper limit of 30 rows

```
%DEFINE myTable1=%TABLE(30)
```

Example 2: A Net.Data table that uses the default of all rows

```
%DEFINE myTable2=%TABLE
```

Example 3: A Net.Data table that specifies all rows
`%DEFINE myTable3=%TABLE(ALL)`

WHILE Block

Purpose

Provides a looping construct based on conditional string processing. You can use the WHILE block in the HTML block, the REPORT block, the ROW block, the IF block, and the MACRO_FUNCTION block. String values in the condition list are treated as numeric for comparisons if they are strings that represent integers and have no leading or trailing white space. They can have a single leading plus (+) or minus (-) sign.

Syntax

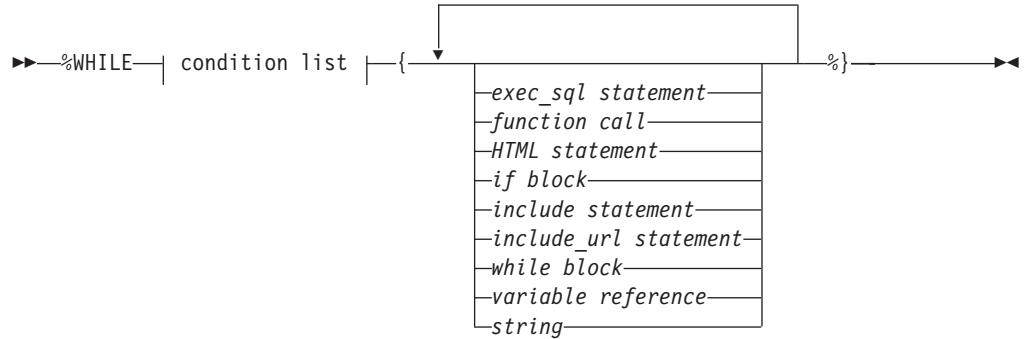

condition list:

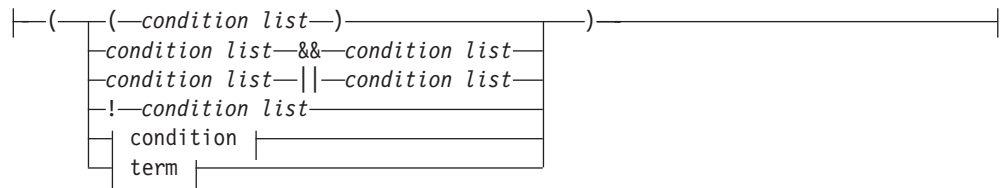

condition:



term:

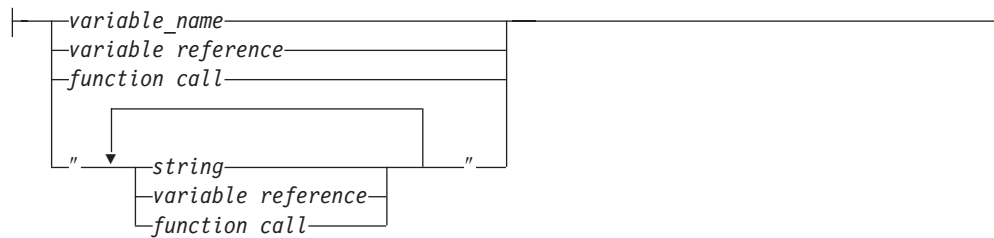

Values

%WHILE

The keyword that specifies loop processing.

condition list

Compares the values of conditions and terms. Condition lists can be connected using Boolean operators. A condition list can be nested inside another condition list.

condition

A comparison between two terms using comparison operators. An IF condition is treated as a numeric comparison if both of the following conditions are true:

- The condition operator is one of the following operators: <, <=, >, >=, ==, !=
- Both terms are strings representing valid integers, where a valid integer is a string of digits, optionally preceded by a plus (+) or minus (-) sign, and no other white space.

If either condition is not true, a normal string comparison is performed.

term

A variable name, string, variable reference, for function call.

exec_sql statement

A DB2WWW Release 1 language element that is supported for compatibility. See "Appendix B. DB2 WWW Connection" on page 311 or DB2 World Wide Web Release 1 documentation.

function call

Invokes one or more FUNCTION or MACRO_FUNCTION blocks, or built-in functions with specified arguments. See "Function Call (@)" on page 23 for syntax and examples.

HTML statement

Includes any alphabetic or numeric characters, as well as HTML tags to be formatted for the client's browser.

if block

The IF block. Performs conditional string processing. String values in the condition list are treated as numeric for comparisons if they represent integers and have no leading or trailing white space. They can have one leading plus (+) or minus (-) sign. See "IF Block" on page 28 for syntax and examples.

include statement

The INCLUDE statement. Reads and incorporates a file into the Net.Data macro. See "INCLUDE Statement" on page 34 for syntax and examples.

include_url statement

The INCLUDE_URL statement. Reads and incorporates another file into the

Net.Data Web macro where the statement is specified. The specified file can exist on a local or remote server. See “INCLUDE_URL Statement” on page 36 for syntax and examples.

while block

The WHILE block. Performs looping with conditional string processing. See “WHILE Block” on page 55 for syntax and examples.

variable reference

Returns the value of a variable and is specified with \$ and (). For example: if VAR='abc', then \$(VAR) returns the value 'abc'. See “Variable Reference” on page 4 for syntax information.

string

Any sequence of alphabetic and numeric characters and punctuation. A string in the term of the condition list can contain any character except the new-line character.

variable name

A name that identifies a variable. See “Variable Name” on page 4 for syntax information.

Context

The WHILE block can be found in these contexts:

- HTML block
- REPORT block
- ROW block
- MACRO_FUNCTION block
- IF block
- WHILE block

Restrictions

The WHILE block can contain these elements:

- Comment block
- EXEC_SQL statement
- IF block
- WHILE block
- Strings
- HTML statements
- Function calls
- Variable references
- INCLUDE statements
- INCLUDE_URL statements

Examples

Example 1: A WHILE block that generates rows in a table

```
%DEFINE loopCounter = "1"

%HTML(build_table) {
%WHILE (loopCounter <= "100") {
  %{ generate table tag and column headings %}
  %IF (loopCounter == "1")
    <TABLE BORDER>
    <TR>
    <TH>Item #
    <TH>Description
    </TR>
  %ENDIF

  %{ generate individual rows %}
  <TR>
```

```
<TD>
<TD>$(loopCounter)
<TD>@getDescription(loopCounter)
</TR>

%{ generate end table tag %}
%IF (loopCounter == "100")
  </TABLE>
%ENDIF

%{ increment loop counter %}
@dtw_add(loopCounter, "1", loopCounter)
%}
%}
```

Chapter 2. Variables

Net.Data provides two types of variables: user-defined variables and Net.Data variables.

“User-defined Variables” on page 60

Variables that you define for your application. You can define the variables that perform the following tasks:

- **“Conditional Variables” on page 60**
Assign a variable value based on the value of another variable or string.
- **“Environment Variables” on page 61**
Use the ENVVAR language construct to reference environment variables.
- **“Executable Variables” on page 61**
Use the EXEC language construct to invoke other programs from a variable reference.
- **“Hidden Variables” on page 62**
Hide variable reference from HTML source.
- **“List Variables” on page 63**
Build a delimited string of values using the LIST language construct.
- **“Table Variables” on page 64**
Pass an array of values to and from a function. Can be used for report output.

Net.Data Variables

Variables that are for miscellaneous processing and file manipulation, table processing, report formatting, and language environments.

Some variables have values that you can define or modify, others are defined by Net.Data. The description for the variable specifies whether you define a value or not. See the description of a variable to determine how the value is defined.

The following variable types are provided by Net.Data:

- **“Net.Data Table Processing Variables” on page 65**
Defined by Net.Data to let you process Net.Data tables. Use these variables to access data from SQL queries and function calls. They are only recognized inside REPORT or ROW blocks, unless otherwise specified.
- **“Net.Data Report Variables” on page 75**
Help you customize reports from a function. You can define or reference report variables in any Net.Data macro block.
- **“Net.Data Language Environment Variables” on page 84**
Help you customize the way FUNCTION blocks are processed, using language environments.
- **“Net.Data Miscellaneous Variables” on page 102**
Defined by Net.Data to affect Net.Data processing, find out the status of a function call, and obtain information about the result set of a database query. Some miscellaneous variables are set by Net.Data and cannot be changed.

The output for many Net.Data variables varies depending on the operating system on which it runs.

In this chapter, operating system support for each variable is specified. The following list defines operating system abbreviations:

HP-UX	Hewlett Packard UNIX operating system
SCO	Santa Cruz Operation OpenServer
SUN	Solaris Operating System
Win NT	Microsoft Windows NT operating system

User-defined Variables

This section describes the user-defined variables. You define these variables within the macro.

Conditional Variables

AIX	HP-UX	Linux	OS/2	OS/390	OS/400	SCO	SUN	Win NT
X	X	X	X	X	X	X	X	X

The value of a conditional variable is conditionally set based on the value of another variable or string. This is also called a *ternary operation*.

The syntax of conditional variable is:

```
test ? trueValue : falseValue
```

Where:

test Is a condition to test.

trueValue
Is the value to use if the test is true.

falseValue
Is the value to use if the test is false.

Example 1: A conditional variable defined with two possible values

```
varA = varB ? "value_1" : "value_2"
```

If varB exists, varA=value_1, otherwise varA=value_2.

Example 2: A conditional variable defined with a variable reference

```
varname = ? "${value_1}"
```

In this case, *varname* is null if *value_1* is null, otherwise *varname* is set to *value_1*.

Example 3: A conditional variable used with a LIST statement and WHERE clause

```
%DEFINE{
%list " AND " where_list
where_list = ? "custid = ${cust_inp}"
where_list = ? "product_name LIKE '${(prod_inp)}%"
where_clause = ? "WHERE ${where_list}"
%}
```



```
%FUNCTION(DTW_SQL) mySelect() {
    SELECT * FROM prodtbl $(where_clause)
%}
```

Conditional and LIST variables are most effective when used together. The above example shows how to set up a WHERE clause in the DEFINE block. The variables *cust_inp* and *prod_inp* are HTML input variables passed from the Web browser, usually from an HTML form. The variable *where_list* is a LIST variable made of two conditional statements, each statement containing a variable from the Web browser.

If the Web browser returns values for both variables *cust_inp* and *prod_inp*, for example, IBM and 755C, the *where_clause* is:

```
WHERE custid = IBM AND product_name LIKE '755C%'
```

If either variable *cust_inp* or *prod_inp* is null or not defined, the WHERE clause changes to omit the null value. For example, if *prod_inp* is null, the WHERE clause is:

```
WHERE custid = IBM
```

If both values are null or undefined, the variable *where_clause* is null and no WHERE clause appears in SQL queries containing *\$(where_clause)*.

Environment Variables

AIX	HP-UX	Linux	OS/2	OS/390	OS/400	SCO	SUN	Win NT
X	X	X	X	X	X	X	X	X

Environment variables let you use the Net.Data ENVVAR language construct to reference environment variables that exist in the process under which Net.Data is running.

Example 1: A variable is assigned the value of an environment variable

```
%define SERVER_NAME=%ENVVAR
```

...

The server is *\$(SERVER_NAME)*

The environment variable *SERVER_NAME* has the value of the current server name, which, in this example, is *www.ibm.com*.

The server is *www.ibm.com*

See “ENVVAR Statement” on page 13 for more information about the ENVVAR statement.

Executable Variables

AIX	HP-UX	Linux	OS/2	OS/390	OS/400	SCO	SUN	Win NT
X	X	X	X	X	X	X	X	X

Executable variables allow you to invoke other programs from a variable reference using the executable variable feature. An executable variable is defined in a

Net.Data macro using the EXEC language element. For more information about the EXEC language element, see "EXEC Block or Statement" on page 14.

When Net.Data encounters an executable variable in a macro, it looks for the referenced executable program using the following method:

1. It searches the EXEC_PATH in the Net.Data initialization file. See the configuration chapter in *Net.Data Administration and Programming Guide* for more information about EXEC_PATH.
2. If Net.Data does not locate the program, it searches the directories defined by the system. If it locates the executable program, Net.Data runs the program.

Example 1: An executable variable definition

```
%DEFINE runit=%exec "testProg"
```

The variable *runit* is defined to execute the executable program *testProg*; *runit* becomes an executable variable.

Net.Data runs the executable program when it encounters a executable variable reference in a Net.Data macro. For example, the program *testProg* is executed when a executable variable reference is made to the variable *runit* in a Net.Data macro.

A simple method is to reference an executable variable from another variable definition. Example 2 demonstrates this method. The variable *date* is defined as an executable variable and *dateRpt* is then defined as a variable reference, that contains the executable variable.

Example 2: An executable variable as a variable reference

```
%DEFINE date=%exec "date"  
%DEFINE dateRpt="Today is $(date)"
```

When Net.Data resolves the variable reference $$(dateRpt)$, Net.Data searches for the executable *date*, runs the program, and returns:

```
Today is Tue 11-07-1995
```

An executable variable is never set to the value of the output of the executable program it calls. Using the previous example, the value of *date* is null. If you use it in a DTW_ASSIGN function call to assign its value to another variable, the value of the new variable after the assignment is null also. The only purpose of an executable variable is to invoke the program it defines.

You can also pass parameters to the program to be executed by specifying them with the program name on the variable definition.

Example 3: Executable variables with parameters

```
%DEFINE mph=%exec "calcMPH $(distance) $(time)"
```

The values of *distance* and *time* are passed to the program *calcMPH*.

Hidden Variables

AIX	HP-UX	Linux	OS/2	OS/390	OS/400	SCO	SUN	Win NT
X	X	X	X	X	X	X	X	X

With hidden variables, you can reference variables while hiding the actual variable value in your HTML source. To use hidden variables:

1. Define a variable for each string you want to hide.
2. In the HTML block where the variables are referenced, use double dollar signs instead of a single dollar sign to reference the variables. For example, \$\$*(X)* instead of \$(*X*).

Do not reference hidden variables with dynamically constructed variable names.

Example 1: Hidden variables in a HTML form

```
%HTML(INPUT) {
<FORM ...>
<P>Select fields to view:
<SELECT NAME="Field">
<OPTION VALUE="$$ (name)"> Name
<OPTION VALUE="$$ (addr)"> Address
.
.
.
</FORM>
%}

%DEFINE{
name="customer.name"
addr="customer.address"
%}

%FUNCTION(DTW_SQL) mySelect() {
  SELECT $(Field) FROM customer
%}
.
.
.
```

When the HTML form is displayed on a Web browser, \$\$*(name)* and \$\$*(addr)* are replaced with \$(*name*) and \$(*addr*) respectively, so the actual table and column names never appear on the HTML form and no one can tell that the true variable names are hidden. When the customer submits the form, the HTML(REPORT) block is called. When @mySelect() calls the FUNCTION block, \$(*Field*) is substituted in the SQL statement with customer.name or customer.addr in the SQL query.

List Variables

AIX	HP-UX	Linux	OS/2	OS/390	OS/400	SCO	SUN	Win NT
X	X	X	X	X	X	X	X	X

You can use list variables to build a delimited string of values. They are particularly useful in helping you construct an SQL query with multiple items like those found in some WHERE or HAVING clauses.

The blanks are significant. Usually you want to have a blank space on both sides of the value. Most queries use Boolean or mathematical operators (for example, AND, OR, and >). See "LIST Statement" on page 38 for syntax and more information.

Example 1: Use of conditional, hidden, and list variables

```

%HTML(INPUT){
<FORM METHOD="POST" ACTION="/cgi-bin/db2www/example2.max/report">
Select one or more cities:<BR>
<INPUT TYPE="checkbox" NAME="conditions" VALUE="$$ (cond1)">Sao Paulo<BR>
<INPUT TYPE="checkbox" NAME="conditions" VALUE="$$ (cond2)">Seattle<BR>
<INPUT TYPE="checkbox" NAME="conditions" VALUE="$$ (cond3)">Shanghai<BR>
<INPUT TYPE="submit" VALUE="Submit Query">
</FORM>
%}

%DEFINE{
DATABASE="custcity"
%LIST " OR " conditions
cond1="cond1='Sao Paolo'"
cond2="cond2='Seattle'"
cond3="cond3='Shanghai'"
whereClause= ? "WHERE $(conditions)" : ""
%}

%FUNCTION(DTW_SQL) mySelect(){
SELECT name, city FROM citylist
$(whereClause)
%}

%HTML(REPORT){
@mySelect()
%}

```

If no boxes are checked in the HTML form, *conditions* is null, so *whereClause* is also null in the query. Otherwise, *whereClause* has the selected values separated by the Boolean operator OR. For example, if all three cities are selected, the SQL query is:

```

SELECT name, city FROM citylist
WHERE cond1='Sao Paolo' OR cond2='Seattle' OR cond3='Shanghai'

```

Example 2: Value separators

```

%DEFINE %LIST " | " VLIST
%REPORT{
%ROW{
<EM>$(ROW_NUM):</EM> $(VLIST)
%}
%}

```

The table processing variable VLIST uses two quotes and an OR bar, (|), as a value separator in this example. The string of values are separated by the value in quotes.

Table Variables

AIX	HP-UX	Linux	OS/2	OS/390	OS/400	SCO	SUN	Win NT
X	X	X	X	X	X	X	X	X

The table variable defines a collection of related data. It contains a set of rows and columns including a row of column headers. Use table variables to pass groups of values to a function. You can refer to the individual elements of a table (the rows) in a REPORT block of a function or by using table built-in functions. Table variables are often used for output from an SQL function and input to a report, but you can also pass them as IN, OUT, or INOUT parameters to any non-SQL function. Tables can only be passed to SQL functions as OUT parameters. See “TABLE Statement” on page 53 for syntax and more information.

When a TABLE variable is referenced, Net.Data displays the content of the table as either a plain character table, or as an HTML table if the DTW_HTML_TABLE variable is set to YES.

Example 1: A SQL result set that is passed to a REXX program

```
%DEFINE{
  DATABASE = "iddata"
  MyTable = %TABLE(ALL)
  DTW_DEFAULT_REPORT = "NO"
%}

%FUNCTION(DTW_SQL) Query(OUT table) {
  select * from survey
%}

%FUNCTION(DTW_REXX) showTable(INOUT table) {
  Say 'Number of Rows: 'table_ROWS
  Say 'Number of Columns: 'table_COLS
  do j=1 to table_COLS
    Say "Here are all of the values for column " table_N.j ":"
    do i = 1 to table_ROWS
      Say "<B>"i"</B>: " table_V.i.j
    end
  end
%}

%HTML (report){
<HTML>
<PRE>
@Query(MyTable)
<p>
@showTable(MyTable)
</PRE>
</HTML>
%}
```

The HTML REPORT block calls an SQL query, saves the result in a table variable and then passes the variable to a REXX function.

Net.Data Table Processing Variables

Net.Data defines these variables for use in the REPORT and ROW blocks, unless noted otherwise. Use these variables to reference values that your queries return.

- “Nn” on page 66
- “NLIST” on page 67
- “NUM_COLUMNS” on page 68
- “NUM_ROWS” on page 69
- “ROW_NUM” on page 70
- “TOTAL_ROWS” on page 71
- “V_columnName” on page 72
- “VLIST” on page 73
- “Vn” on page 74

Nn

AIX	HP-UX	Linux	OS/2	OS/390	OS/400	SCO	SUN	Win NT
X	X	X	X	X	X	X	X	X

Purpose

The column name returned by a function call or query for column n.

You can reference *Nn* in REPORT and ROW blocks.

Examples

Example 1: A variable reference for a column name

The name of column 2 is \$(N2).

Example 2: Saves the value of a column name for use outside a REPORT block using DTW_ASSIGN

```
%define coll=""
...
%function (DTW_SQL) myfunc() {
  select * from atable
  %report {
    @dtw_assign(coll, N1)
    %row{ %}
  }
%}

%html(report) {
@myfunc()
The column name for the first column is $(coll)
%}
```

This example shows how you can use this variable outside the REPORT block by using DTW_ASSIGN. For more information, see “DTW_ASSIGN” on page 169.

Example 3: *Nn* within an HTML table to define column names

```
%REPORT{
<H2>Product directory</H2>
<TABLE BORDER=1 CELLPADDING=3>
<TR><TD>$(N1)</TD><TD>$(N2)</TD><TD>$(N3)</TD>
%ROW{
<TR><TD>$(V1)</TD><TD>$(V2)</TD><TD>$(V3)</TD>
%}
</TABLE>
%}
```

NLIST

AIX	HP-UX	Linux	OS/2	OS/390	OS/400	SCO	SUN	Win NT
X	X	X	X	X	X	X	X	X

Purpose

Contains a list of all the column names from the result of a function call or query. The default separator is a space.

You can reference NLIST in REPORT and ROW blocks.

Examples

Example 1: A list of column names with ALIGN

```
%DEFINE ALIGN="YES"
...
%FUNCTION (DTW_SQL) myfunc() {
select * from MyTable
%report{
Your query was on these columns: $(NLIST).
%row {
...
%}
%}
%}
```

The list of column names uses a space between column names with ALIGN set to YES.

Example 2: A %LIST variable to change the separator to " | "

```
%DEFINE %LIST " | " NLIST
...
%FUNCTION (DTW_SQL) myfunc() {
select * from MyTable
%report{
Your query was on these columns: $(NLIST).
%row {
...
%}
%}
%}
```

NUM_COLUMNS

AIX	HP-UX	Linux	OS/2	OS/390	OS/400	SCO	SUN	Win NT
X	X	X	X	X	X	X	X	X

Purpose

The number of table columns that Net.Data is processing in the report block; the columns are returned by a function call or query.

You can reference NUM_COLUMNS in REPORT and ROW blocks.

Examples

Example 1: NUM_COLUMNS used as a variable reference with NLIST

```
%REPORT{
Your query result has $(NUM_COLUMNS) columns: $(NLIST).
...
%}
```

NUM_ROWS

AIX	HP-UX	Linux	OS/2	OS/390	OS/400	SCO	SUN	Win NT
					X			

Purpose

The number of rows in the table that Net.Data is processing in the REPORT block. The number of rows is affected by the value of the *upper limit* parameter defined for the Net.Data table holding the data. For example, if *upper limit* is set to 30, but the SELECT statement returns 1000 rows, the value of NUM_ROWS is 30. Additionally, if *upper limit* is set to 30 and the SELECT statement returns 20 rows, NUM_ROWS equals 20. See "TABLE Statement" on page 53 for more information about the TABLE statement and the *upper limit* parameter.

NUM_ROWS is not affected by the value of START_ROW_NUM as long as START_ROW_NUM is not passed to the language environment. For example, if START_ROW_NUM is set to 5 (specifying that the table displayed on the Web page should be populated starting with row 5) and the SELECT statement returns 25 rows, NUM_ROWS is set to 25, not 21. The first four rows are discarded from the table, but are included in the value of NUM_ROWS. However, if START_ROW_NUM is passed to the language environment, then NUM_ROWS will only contain the number of rows starting at the row specified by START_ROW_NUM. In the example above, NUM_ROWS will be set to 21.

You can reference NUM_ROWS in REPORT and ROW blocks.

Examples

Example 1: Displays the number of names being processed in the REPORT block

```
%DEFINE DTW_SET_TOTAL_ROWS="YES"

%REPORT{
<H2>E-mail directory</H2>
<UL>
%ROW{
<LI>Name: <a href="mailto:$(V1)">$(V2)</a><BR>
Location: $(V3)
%}
</UL>
Names displayed: $(NUM_ROWS)<BR>
Names found: $(TOTAL_ROWS)
%}
```

ROW_NUM

AIX	HP-UX	Linux	OS/2	OS/390	OS/400	SCO	SUN	Win NT
X	X	X	X	X	X	X	X	X

Purpose

A table variable whose value Net.Data increments each time a row is processed in a Net.Data table. The variable acts as a counter and its value is the number of the current row being processed.

RPT_MAX_ROWS can affect the value of ROW_NUM. For example, if 100 rows are in a table, and you have set RPT_MAX_ROWS to 20, the final value of ROW_NUM is 20, because row 20 was the last row processed.

You can reference ROW_NUM only from within a ROW block.

Examples

Example 1: Populates a column in the HTML output by using ROW_NUM to label each row in the table

```
%REPORT{  
<TABLE BORDER=1>  
<TR><TD> Row Number </TD> <TD> Customer </TD>  
%ROW{  
<TR><TD> $(ROW_NUM) </TD> <TD> $(V_custname) </TD>  
%}  
</TABLE>  
%}
```

The REPORT block produces a table like the one shown below.

Row Number	Customer
1	Jane Smith
2	Jon Chiu
3	Frank Nguyen
4	Mary Nichols

TOTAL_ROWS

AIX	HP-UX	Linux	OS/2	OS/390	OS/400	SCO	SUN	Win NT
X	X	X	X	X	X	X	X	X

Purpose

The total number of rows a query returns, no matter what the value of *upper_limit* for the TABLE language construct. For example, if RPT_MAX_ROWS is set to display a maximum of 20 rows, but the query returns 100 rows, this variable is set to 100 after ROW processing.

Operating system differences:

- On the OS/400 operating system, this variable can be referenced anywhere in a REPORT or ROW block.
- On the OS/390, OS/2, Windows NT, and UNIX operating systems, this variable can be referenced in the REPORT footer, only.

Language Environment Restriction: Use this variable only with the following database language environments:

- SQL
- ODBC
- Oracle
- Sybase

Required: You must set DTW_SET_TOTAL_ROWS to YES to use this variable. See "DTW_SET_TOTAL_ROWS" on page 94 for more information.

Examples

Example 1: Displays the total number of names found

```
%DEFINE DTW_SET_TOTAL_ROWS="YES"

%REPORT{
<H2>E-mail directory</H2>
<UL>
%ROW{
<LI>Name: <a href="mailto:$(V1)">$(V2)</a><BR>
Location: $(V3)
%}
</UL>
Names found: $(TOTAL_ROWS)
%}
```

V_columnName

AIX	HP-UX	Linux	OS/2	OS/390	OS/400	SCO	SUN	Win NT
X	X	X	X	X	X	X	X	X

Purpose

The value for the specified column name for the current row. The variable is not set for undefined column names. A query containing two column names with the same name gives unpredictable results. Consider using an AS clause in your SQL to rename duplicate column names.

You can reference *V_columnName* only within a ROW block.

Values

V_columnName

Table 1. *V_columnName* Values

Values	Description
<i>columnName</i>	The column name in current row of the database table.

Examples

Example 1: Using *V_columnName* as a variable reference

```
%FUNCTION(DTW_SQL) myQuery() {
  SELECT NAME, ADDRESS from $(qtable)
  %REPORT{

  %ROW{

  Value of NAME column in row $(ROW_NUM) is $(V_NAME).<BR>
  %}
  %}
  %}
```

VLIST

AIX	HP-UX	Linux	OS/2	OS/390	OS/400	SCO	SUN	Win NT
X	X	X	X	X	X	X	X	X

Purpose

A list of all the field values for the current row being processed in a ROW block.

You can reference VLIST only within a ROW block. The default separator is a space.

Examples

Example 1: Using list tags to display query results

```
%DEFINE ALIGN="YES"

%REPORT{
Here are the results of your query:
<OL>
%ROW{
<LI>$(VLIST)
%}
</OL>
%}
```

Example 2: Using a list variable to change the separator to <P>

```
%DEFINE %LIST "<P>" VLIST

%REPORT{
Here are the results of your query:
%ROW{
<HR>$(VLIST)
%}
%}
```

Vn

AIX	HP-UX	Linux	OS/2	OS/390	OS/400	SCO	SUN	Win NT
X	X	X	X	X	X	X	X	X

Purpose

The value for the specified column number n for the current row.

You can reference Vn only within a ROW block.

Net.Data assigns the variable for each field the table; use the variable in a variable reference, specifying the number of the field you want to reference. To use this variable outside the block, assign the value of Vn to a previously defined global variable or an OUT or INOUT function parameter variable.

Examples

Example 1: Report displaying an HTML table

```
%REPORT{
<H2>E-mail directory</H2>
<TABLE BORDER=1 CELLPADDING=3>
<TR><TD>Name</TD><TD>E-mail address</TD><TD>Location</TD>
%ROW{
<TR><TD>$(V1)</TD>
<TD><a href="mailto:$(V2)">$(V2)</a></TD>
<TD>$(V3)</TD>
%}
</TABLE>
%}
```

The second column shows the e-mail address. You can send the person a message by clicking on the link.

Net.Data Report Variables

These variables help you customize your reports. Each variable has a default value. You can override the default value by assigning a new value to the variable.

- “ALIGN” on page 76
- “DTW_DEFAULT_REPORT” on page 77
- “DTW_HTML_TABLE” on page 78
- “RPT_MAX_ROWS” on page 79
- “START_ROW_NUM” on page 81

ALIGN

AIX	HP-UX	Linux	OS/2	OS/390	OS/400	SCO	SUN	Win NT
X	X	X	X	X	X	X	X	X

Purpose

Controls leading and trailing spaces used with the table processing variables NLIST and VLIST.

Performance Tip: Use ALIGN only when necessary as it requires that Net.Data determine the maximum column length for all columns in the table to calculate padding requirements. This process can impact performance.

When set to YES, ALIGN provides padding to align table processing variables for display. If you want to embed query results in HTML links or form actions, use the default value of NO to prevent Net.Data from surrounding report variables with leading and trailing spaces.

Specify the value of this variable using a DEFINE statement or with the @DTW_ASSIGN() function.

Values

ALIGN="YES"|"NO"

Table 2. ALIGN Values

Values	Description
YES	Net.Data adds leading and trailing spaces to report variables with spaces to align them for display.
NO	Net.Data does not add leading or trailing spaces. NO is the default.

Examples

Example 1: Using the ALIGN variable to separate each column by a space

```
%DEFINE ALIGN="YES"  
<P>Your query was on these columns: $(NLIST)
```

DTW_DEFAULT_REPORT

AIX	HP-UX	Linux	OS/2	OS/390	OS/400	SCO	SUN	Win NT
X	X	X	X	X	X	X	X	X

Purpose

Determines whether Net.Data generates a default report for functions that have no REPORT block. When this variable is set to YES, Net.Data generates the default report. When set to NO, Net.Data suppresses default report generation. Suppressing the default report is useful, for example, if you receive the results of a function call in a table variable and want to pass the results to a different function to process.

Specify the value of this variable using a DEFINE statement or with the @DTW_ASSIGN() function.

Values

DTW_DEFAULT_REPORT="YES"|"NO"|"MULTIPLE"

Table 3. DTW_DEFAULT_REPORT Values

Values	Description
YES	Net.Data generates the default report for functions without REPORT blocks and displays the results at the browser. YES is the default.
NO	Net.Data discards the default report for functions without REPORT blocks.
MULTIPLE	Net.Data generates default reports for result sets or output tables that are not assigned to a REPORT block, in functions with multiple REPORT blocks

Examples

Example 1: Overriding the default report generated by Net.Data

```
%DEFINE DTW_DEFAULT_REPORT="NO"
```

DTW_HTML_TABLE

AIX	HP-UX	Linux	OS/2	OS/390	OS/400	SCO	SUN	Win NT
X	X	X	X	X	X	X	X	X

Purpose

Displays results in an HTML table instead of displaying the table in a text-type format (that is, using the TABLE tags rather than the PRE tags).

The generated TABLE tag includes a border and cell-padding specification:

```
<TABLE BORDER CELLPADDING=2>
```

Specify the value of this variable using a DEFINE statement or with the @DTW_ASSIGN() function.

Values

```
DTW_HTML_TABLE="YES"|"NO"
```

Table 4. DTW_HTML_TABLE Values

Values	Description
YES	Displays table data using HTML table tags.
NO	Displays table data in a text format, using PRE tags. NO is the default.

Examples

Example 1: Displays results from an SQL function with HTML tags

```
%DEFINE DTW_HTML_TABLE="YES"

%FUNCTION(DTW_SQL){
SELECT NAME, ADDRESS FROM $(qTable)
%}
```

RPT_MAX_ROWS

AIX	HP-UX	Linux	OS/2	OS/390	OS/400	SCO	SUN	Win NT
X	X	X	X	X	X	X	X	X

Purpose

Specifies the number of rows in a table that are processed in a function REPORT block or during the generation of a default report if a REPORT block is not specified.

The database language environments use this variable to limit the number of rows returned, which can substantially improve performance for large result sets. Use this variable with START_ROW_NUM to break queries with large result sets into smaller tables, each on its own HTML page.

OS/400, Windows NT, OS/2, and UNIX users: To pass this variable to the language environment, include it as an IN parameter in the database language environment's ENVIRONMENT statement in the Net.Data initialization file. To learn more about the database language environment statement, see the configuration chapter of the *Net.Data Administration and Programming Guide* for your operating system.

OS/390 users: RPT_MAX_ROWS is implicitly passed to the database language environments when it is defined in the macro.

Specify the value of this variable using a DEFINE statement or with the @DTW_ASSIGN() function.

Values

RPT_MAX_ROWS="ALL"|"0"|"number"

Table 5. RPT_MAX_ROWS Values

Values	Description
ALL	Indicates that there is no limit on the number of rows to be displayed in a table generated by a function call. All rows will be displayed.
0	Specifies that all rows in the table will be displayed. This value is the same as specifying ALL.
number	A positive integer indicating the maximum number of rows to be displayed in a table generated by a function call. If the FUNCTION block contains a REPORT and ROW block, this number specifies the number of times the ROW block is executed.

Examples

Example 1: Defines RPT_MAX_ROWS in a DEFINE statement

```
%DEFINE RPT_MAX_ROWS="20"
```

The above method limits the number of rows any function returns to 20 rows.

Example 2: Uses HTML input to define the variable with an HTML form

Maximum rows to return (0 for no limit):
<INPUT TYPE="text" NAME="RPT_MAX_ROWS" SIZE=3>

The lines in the above example can be placed in a FORM tag to let the application users set the number of rows they want returned from a query.

START_ROW_NUM

AIX	HP-UX	Linux	OS/2	OS/390	OS/400	SCO	SUN	Win NT
X	X	X	X	X	X	X	X	X

Purpose

Specifies the starting row number in a table that will get processed in a function REPORT block or during the generation of a default report if a REPORT block is not specified.

The database language environments use this variable to determine the starting row in the result set to begin processing. To substantially improve performance for large result sets, use this variable with RPT_MAX_ROWS to break queries with large result sets into smaller tables.

OS/400, Windows NT, OS/2, and UNIX users: To pass this variable to the language environment, include it as an IN parameter in the database language environment's ENVIRONMENT statement in the Net.Data initialization file. To learn more about the database language environment statement, see the configuration chapter of the *Net.Data Administration and Programming Guide* for your operating system.

OS/390 users: START_ROW_NUM is implicitly passed to the database language environments when it is defined in the macro.

Specify the value of this variable using a DEFINE statement or with the @DTW_ASSIGN() function.

Values

START_ROW_NUM="number"

Table 6. START_ROW_NUM Values

Values	Description
<i>number</i>	<p>A positive integer indicating the row number with which to begin displaying a report. The default value is 1.</p> <p>If START_ROW_NUM is specified in a database language environment's environment statement in the initialization file, this number specifies the row number of the result set processed by the database language environment.</p> <p>If START_ROW_NUM is not passed to the language environment, this number specifies the row number of the Net.Data table used to display a report.</p>

Examples

Example 1: Scrolling with HTML form Next and Previous buttons

```
%define {
  DTW_HTML_TABLE      = "YES"
  START_ROW_NUM       = "1"
  RPT_MAX_ROWS        = "10"
  totalSize           = ""
  includeNext         = "YES"
  includePrev         = "YES"
  includeLast         = "YES"
  includeFirst        = "YES"
%}
```

```

%function(DTW_SQL) myQuery(){
    select * from NETDATADEV.CUSTOMER
}%

%function(DTW_SQL) count(OUT size){
    select count(*) from NETDATADEV.CUSTOMER
    %report{
        %row{
            @DTW_ASSIGN(size,V1)
        }
    }
}%

%html(report) {
    %{ get the total number of records if we haven't already %}
    %if (totalSize == "")
        @count(totalSize)
    %endif

    %{ set START_ROW_NUM based on the button user clicked %}
    %if (totalSize <= RPT_MAX_ROWS)
        %{ there's only one page of data %}
        @DTW_ASSIGN(START_ROW_NUM, "1")
        @DTW_ASSIGN(includeFirst, "NO")
        @DTW_ASSIGN(includeLast, "NO")
        @DTW_ASSIGN(includeNext, "NO")
        @DTW_ASSIGN(includePrev, "NO")
    %elif (submit == "First Page" || submit == "")
        %{ first time through or user selected "First Page" button %}
        @DTW_ASSIGN(START_ROW_NUM, "1")
        @DTW_ASSIGN(includePrev, "NO")
        @DTW_ASSIGN(includeFirst, "NO")
    %elif (submit == "Last Page")
        %{ user selected "Last Page" button %}
        @DTW_SUBTRACT(totalSize, RPT_MAX_ROWS, START_ROW_NUM)
        @DTW_ADD(START_ROW_NUM, "1", START_ROW_NUM)
        @DTW_ASSIGN(includeLast, "NO")
        @DTW_ASSIGN(includeNext, "NO")
    %elif (submit == "Next")
        %{ user selected "Next" button %}
        @DTW_ADD(START_ROW_NUM, RPT_MAX_ROWS, START_ROW_NUM)
        %if (@DTW_rADD(START_ROW_NUM, RPT_MAX_ROWS) > totalSize)
            @DTW_ASSIGN(includeNext, "NO")
            @DTW_ASSIGN(includeLast, "NO")
        %endif
    %elif (submit == "Previous")
        %{ user selected "Previous" button %}
        @DTW_SUBTRACT(START_ROW_NUM, RPT_MAX_ROWS, START_ROW_NUM)
        %if (START_ROW_NUM <= "1" )
            @DTW_ASSIGN(START_ROW_NUM, "1")
            @DTW_ASSIGN(includePrev, "NO")
            @DTW_ASSIGN(includeFirst, "NO")
        %endif
    %endif

    %{ run the query to get the data %}
    @myQuery()

    %{ output the correct buttons at the bottom of the report %}
    <center>
    <form method="POST" action="report">
    <input name="START_ROW_NUM" type="hidden" value="$(START_ROW_NUM)">
    <input name="totalSize" type="hidden" value="$(totalSize)">
    %if (includeFirst == "YES" )
    <input name="submit" type="submit" value="First Page">
    %endif
}

```

```
%if (includePrev == "YES" )
<input name="submit" type="submit" value="Previous">
%endif
%if (includeNext == "YES" )
<input name="submit" type="submit" value="Next">
%endif
%if (includeLast == "YES" )
<input name="submit" type="submit" value="Last Page">
%endif
</form>
</center>
%}
```

Net.Data Language Environment Variables

Use these variables with functions to help you customize the way FUNCTION blocks are processed by language environments. Each variable has a default value. You can override the default value by assigning a new value to the variable.

- "DATABASE" on page 85
- "DB_CASE" on page 87
- "DB2PLAN" on page 88
- "DB2SSID" on page 89
- "DTW_APPLET_ALTTEXT" on page 90
- "DTW_EDIT_CODES" on page 91
- "DTW_PAD_PGM_PARAMS" on page 92
- "DTW_SAVE_TABLE_IN" on page 93
- "DTW_SET_TOTAL_ROWS" on page 94
- "LOCATION" on page 95
- "LOGIN" on page 96
- "NULL_RPT_FIELD" on page 97
- "PASSWORD" on page 98
- "SHOWSQL" on page 99
- "SQL_STATE" on page 100
- "TRANSACTION_SCOPE" on page 101

DATABASE

AIX	HP-UX	Linux	OS/2	OS/390	OS/400	SCO	SUN	Win NT
X	X	X	X		X	X	X	X

Purpose

Specifies the database or ODBC data source to access when calling a database function. This variable can be changed multiple times within a macro to access multiple databases or ODBC data sources.

OS/400 operating system: This variable is optional. Net.Data, by default, specifies DATABASE="LOCAL"; the DTW_SQL language environment uses the local relational database directory entry.

Windows NT, OS/2, and UNIX operating systems: Define this variable before calling any database function, except when using the DTW_ORA (Oracle) language environment. Additionally, you must use Live Connection when accessing multiple databases from the same HTML block and through the same language environment.

Specify the value of this variable using a DEFINE statement or with the @DTW_ASSIGN() function.

Values

DATABASE="dbname"

Table 7. DATABASE Values

Values	Description
dbname	The name of the database Net.Data connects to.

Examples

Example 1: Specifies to connect to the CELDIAL database for any SQL operations

```
%DEFINE DATABASE="CELDIAL"

%FUNCTION (DTW_SQL) getRpt() {
SELECT * FROM customer
%}

%HTML (report) {
%INCLUDE "rpthead.htm"
@getRpt()
%INCLUDE "rptfoot.htm"
%}
```

The database CELDIAL is accessed when the function getRpt is called.

Example 2: Overrides previous DATABASE definitions with DTW_ASSIGN

```
%DEFINE DATABASE="DB2C1"
...
%HTML(monthRpt){
@DTW_ASSIGN(DATABASE, "DB2D1")
%INCLUDE "rpthead.htm"
@getRpt()
%INCLUDE "rptfoot.htm"
%}
```

The HTML block queries the database DB2D1, regardless of what the previous value for DATABASE was.

DB_CASE

AIX	HP-UX	Linux	OS/2	OS/390	OS/400	SCO	SUN	Win NT
X	X	X	X	X	X	X	X	X

Purpose

Specifies which case to use for SQL commands and converts all characters to either upper or lower case. If this variable is not defined, the default action is to not convert the SQL command characters.

Specify the value of this variable using a DEFINE statement or with the @DTW_ASSIGN() function.

Values

DB_CASE="UPPER" | "LOWER"

Table 8. DB_CASE Values

Values	Description
UPPER	Converts all SQL command characters to upper case.
LOWER	Converts all SQL command characters to lower case.

Examples

Example 1: Specifies upper case for all SQL commands

```
%DEFINE DB_CASE="UPPER"
```

DB2PLAN

AIX	HP-UX	Linux	OS/2	OS/390	OS/400	SCO	SUN	Win NT
				X				

Purpose

Allocates a plan for a connection to a local DB2 subsystem. The variable specifies the name of a plan for the Net.Data SQL language environment at the local DB2 subsystem that Net.Data will access.

Specify the value of this variable using a DEFINE statement or with the @DTW_ASSIGN() function.

Requirement: For the value of this variable in the macro to take effect, it must be listed on the ENVIRONMENT statement for the SQL language environment.

Values

DB2PLAN="*plan_name*"

Table 9. DB2PLAN Values

Values	Description
<i>plan_name</i>	The name of the DB2 plan. The name can be eight characters or less.

Examples

Example 1: Specifies the plan in the DEFINE statement

```
%DEFINE DB2PLAN="DTWGA22"
```

DB2SSID

AIX	HP-UX	Linux	OS/2	OS/390	OS/400	SCO	SUN	Win NT
				X				

Purpose

Establishes a connection to a local DB2 subsystem. The variable specifies the subsystem ID of the local DB2 subsystem that Net.Data will access. Only one local database connection is allowed for each macro.

Requirement: For the value of this variable in the macro to take effect, it must be listed on the ENVIRONMENT statement for the SQL language environment.

Values

DB2PLAN="*subsystem_id*"

Table 10. DB2SSID Values

Values	Description
<i>subsystem_id</i>	The name of the DB2 subsystem. The name can be eight characters or less.

Examples

Example 1: Specifies a subsystem ID in the DEFINE statement

```
%DEFINE DB2SSID="DBNC"
```

DTW_APPLET_ALTTEXT

AIX	HP-UX	Linux	OS/2	OS/390	OS/400	SCO	SUN	Win NT
X	X	X	X	X	X	X	X	X

Purpose

Displays HTML tags and text to browsers that do not recognize the APPLET tag and is used with the the Applet language environment.

Specify the value of this variable using a DEFINE statement or with the @DTW_ASSIGN() function.

Values

DTW_APPLET_ALTTEXT="HTML_text_and_tags"

Table 11. DTW_APPLET_ALTTEXT Values

Values	Description
HTML_text_and_tags	HTML tags and text for browsers that do not recognize the APPLET tag.

Examples

Example 1: Alternate text that indicates a Web browser restriction

```
%DEFINE DTW_APPLET_ALTTEXT="<P>Sorry, your browser is not java-enabled."
```

DTW_EDIT_CODES

AIX	HP-UX	Linux	OS/2	OS/390	OS/400	SCO	SUN	Win NT
					X			

Purpose

Converts NUMERIC, DECIMAL, INTEGER and SMALLINT data types that are returned as a result of an SQL operation for the DTW_SQL language environment. The variable DTW_EDIT_CODES is a string of characters that correspond to the resulting columns of the table that DTW_SQL LE will build; for example, the fifth character in DTW_EDIT_CODES will be applied to the fifth column of the result set if that column is one of the supported types. This single character can be any of the supported system supplied edit codes that are defined in *Data Description Specification Reference*.

For example, a DECIMAL(6,0) field would normally be displayed as the character string '112698'. By specifying an edit code of 'Y' for that column in the variable DTW_EDIT_CODES, the corresponding column in the resulting table is displayed as a character string that represents the date of '11/26/98'.

Tip: Applying a user-supplied edit code to a column that results in a character string with non-numeric characters (such as commas or currency symbols) can cause syntax errors if the character string is sent back to the server for subsequent processing within a Net.Data macro. For example, the non-numeric column value might be used for numeric comparisons in subsequent DTW_SQL functions calls, causing syntax errors.

Specify the value of this variable using a DEFINE statement or with the @DTW_ASSIGN() function.

Values

DTW_EDIT_CODES="*edit_code*"

Table 12. DTW_EDIT_CODES Values

Values	Description
<i>edit_code</i>	Specifies a string of characters that correspond to the resulting columns of the table that the SQL language environment builds.

Examples

Example 1:

```
@DTW_ASSIGN(DTW_EDIT_CODES "JJLJJ*****Y")
```

DTW_PAD_PGM_PARMS

AIX	HP-UX	Linux	OS/2	OS/390	OS/400	SCO	SUN	Win NT
					X			

Purpose

Indicates to a language environment whether character parameters (data type of CHAR or CHARACTER) are to be padded with blanks when they are being passed to a program or stored procedure.

For IN or INOUT parameters, if the length of parameter value is less than the precision that is specified, blanks are inserted to the right of the parameter value until the length of the parameter value is the same as the precision.

For OUT parameters, the parameter value is set to *precision* blanks.

After the call to the program or stored procedure, all trailing blanks are removed from OUT and INOUT parameter values.

Set this variable in the Net.Data initialization file to specify a value for all of your macros. You can override the value by defining it in the macro. If DTW_PAD_PGM_PARMS is not defined in the macro, it uses the value in the Net.Data initialization file.

DTW_PAD_PGM_PARMS is supported by the Direct Call and SQL language environments.

Values

DTW_PAD_PGM_PARMS="YES"|"NO"

Table 13. DTW_PAD_PGM_PARMS Values

Values	Description
YES	All IN and INOUT character parameter values are left justified and padded with blanks for the defined precision of the parameter, before the parameters are passed to a program or stored procedure. Trailing blanks are removed after the call to a program or stored procedure.
NO	No padding is added to character parameter values (values are NULL-terminated) when passing parameters to programs or stored procedures. Trailing blanks are not removed after calling a program or stored procedure.

Examples

Example 1: Pads parameters with blanks

DTW_PAD_PGM_PARMS="YES"

DTW_SAVE_TABLE_IN

AIX	HP-UX	Linux	OS/2	OS/390	OS/400	SCO	SUN	Win NT
X	X	X	X	X	X	X	X	X

Purpose

Identifies a table variable that the SQL language environment uses to store table data from a query. This table can then be used later, for example, in a REXX program that analyzes table data.

Specify the value of this variable using a DEFINE statement or with the @DTW_ASSIGN() function.

Values

DTW_SAVE_TABLE_IN="table_name_var"

Table 14. DTW_SAVE_TABLE_IN Values

Values	Description
table_name_var	The name of a table for the SQL language environment to store table data from a query.

Examples

Example 1: A previously-defined table variable used in a REXX call

```
%DEFINE theTable = %TABLE(2)
%DEFINE DTW_SAVE_TABLE_IN = "theTable"

%FUNCTION(DTW_SQL) doQuery() {
  SELECT MODNO, COST, DESCRIP FROM EQPTABLE
  WHERE TYPE='MONITOR'
%}

%FUNCTION(DTW_REXX) analyze_table(myTable) {
  %EXEC{ anzTbl.cmd %}
%}

%HTML(doTable) {
  @doQuery()
  @analyze_table(theTable)
%}
```

A REXX FUNCTION block calls the REXX program anzTbl.cmd, which uses the table variable theTable to analyze data in the table. The variable theTable was returned from a previous SQL function call.

DTW_SET_TOTAL_ROWS

AIX	HP-UX	Linux	OS/2	OS/390	OS/400	SCO	SUN	Win NT
X	X	X	X	X	X	X	X	X

Purpose

Specifies to a database language environment that the total number of rows in the result set for a query should be assigned to TOTAL_ROWS.

Specify the value of this variable using a DEFINE statement or with the @DTW_ASSIGN() function.

OS/400, OS/2, Windows NT, and UNIX users: To pass this variable to the language environment, include it as an IN variable in the database language environment's ENVIRONMENT statement in the Net.Data initialization file. See the configuration chapter of *Net.Data Administration and Programming Guide* to learn more about the database language environment statement.

OS/390 users: DTW_SET_TOTAL_ROWS is implicitly passed to the database language environments when it is defined in the macro.

Performance tip: Setting DTW_SET_TOTAL_ROWS to YES affects performance because to determine the total rows, the database language environment requires that all rows be retrieved.

Values

DTW_SET_TOTAL_ROWS="YES"|"NO"

Table 15. DTW_SET_TOTAL_ROWS Values

Values	Description
YES	Assigns the value of the total number of rows to the TOTAL_ROWS variable. Important: You must set this value if you want to reference the variable TOTAL_ROWS to determine the number of rows returned from a query.
NO	Net.Data does not set the TOTAL_ROWS variable and TOTAL_ROWS cannot be referenced in a macro. NO is the default.

Examples

Example 1: Defines DTW_SET_TOTAL_ROWS for using TOTAL_ROWS

```
%DEFINE DTW_SET_TOTAL_ROWS="YES"

...

%FUNCTION (DTW_SQL) myfunc() {
select * from MyTable
%report {
...
%row
...
%}
<P>Your query is limited to $(TOTAL_ROWS) rows. The query returned too many rows.
%}
%}
```

LOCATION

AIX	HP-UX	Linux	OS/2	OS/390	OS/400	SCO	SUN	Win NT
				X				

Purpose

Establishes a connection to a remote database server. The variable specifies the name by which the remote server is known to the local DB2 subsystem. The value of LOCATION must be defined in the SYSIBM.SYSLOCATIONS table of the Communications Database (CDB). If this variable is not defined within a macro, any SQL requests made by the macro are executed at the local DB2 subsystem.

Requirement: For the value of this variable in the macro to take effect, it must be listed on the ENVIRONMENT statement for the SQL language environment.

Specify the value of this variable using a DEFINE statement or with the @DTW_ASSIGN() function.

Values

LOCATION="remote_dbase_name"

Table 16. LOCATION Values

Values	Description
remote_dbase_name	The name of a valid remote database server that is defined in the SYSIBM.SYSLOCATIONS table of the CDB. The name can be eight characters or less.

Examples

Example 1: Defines the remote database location in the DEFINE statement

```
%DEFINE LOCATION="QMFDJ00"
```

LOGIN

AIX	HP-UX	Linux	OS/2	OS/390	OS/400	SCO	SUN	Win NT
X	X	X	X		X	X	X	X

Purpose

Provides access to protected data by passing a user ID to the database language environment. Use this variable with PASSWORD to incorporate the security algorithms of DB2.

OS/400 Users: OS/400 ignores both LOGIN and PASSWORD if the DATABASE variable is not defined or if it is set to a value of "*LOCAL". Database access is routed through the user profile under which Net.Data is running.

Security tip: While you can code this value in the Net.Data macro, it is preferable to have the application user enter user IDs in an HTML form. Additionally, using the default value of the Web server ID provides a level of access that might not meet your security needs.

Specify the value of this variable using a DEFINE statement or with the @DTW_ASSIGN() function.

Values

LOGIN="database_user_id"

Table 17. LOGIN Values

Values	Description
database_user_id	A valid database user ID. The default is to use the user ID that started the Web server.

Examples

Example 1: Restricting access to the user ID, DB2USER

```
%DEFINE LOGIN="DB2USER"
```

Example 2: Using an HTML form input line

```
USERID&#58; <INPUT TYPE="text" NAME="LOGIN" SIZE=6>
```

This example shows a line you can include as part of an HTML form for application users to enter their user IDs.

NULL_RPT_FIELD

AIX	HP-UX	Linux	OS/2	OS/390	OS/400	SCO	SUN	Win NT
					X			

Purpose

Specifies a string the user can provide to the DTW_SQL language environment to represent NULL values that are returned in an SQL result set.

Specify the value of this variable using a DEFINE statement or with the @DTW_ASSIGN() function.

Values

NULL_RPT_FIELD="null_char"

Table 18. NULL_RPT_FIELD Values

Values	Description
null_char	Specifies a string to represent NULL values that are returned in an SQL result set. The default is an empty string.

Examples

Example 1: Specifies a string representing NULL values in the SQL language environment

```
%DEFINE NULL_RPT_FIELD = "++++"
```

PASSWORD

AIX	HP-UX	Linux	OS/2	OS/390	OS/400	SCO	SUN	Win NT
X	X	X	X		X	X	X	X

Purpose

Provides access to protected data by passing a password to the database language environment. Use this variable with LOGIN to incorporate the security algorithms of DB2.

OS/400 Users: OS/400 ignores both LOGIN and PASSWORD if the DATABASE variable is not defined or if it is set to a value of `"*LOCAL"`. Database access is routed through the user profile under which Net.Data is running.

Security tip: While you can code this value in the Net.Data macro, it is preferable to have application users enter passwords in an HTML form.

Specify the value of this variable using a DEFINE statement or with the @DTW_ASSIGN() function.

Values

PASSWORD=`"password"`

Table 19. PASSWORD Values

Values	Description
<code>password</code>	Specifies a valid password to provide automatic access to the database language environment.

Examples

Example 1: Restricting access to application users with the password NETDATA

```
%DEFINE PASSWORD="NETDATA"
```

Example 2: HTML form input line

```
PASSWORD&#58; <INPUT TYPE="password" NAME="PASSWORD" SIZE=8>
```

This example shows a line you can include as part of an HTML form for application users to input their own passwords.

SHOWSQL

AIX	HP-UX	Linux	OS/2	OS/390	OS/400	SCO	SUN	Win NT
X	X	X	X	X	X	X	X	X

Purpose

Hides or displays the SQL of the query used on the Web browser. Displaying the SQL during testing is especially helpful when you are debugging your Net.Data macros. SHOWSQL can only be used if DTW_SHOWSQL is set to YES in the Net.Data configuration file. For more information about the DTW_SHOWSQL configuration variable, see the configuration chapter in *Net.Data Administration and Programming Guide* for your operating system.

Specify the value of this variable using a DEFINE statement or with the @DTW_ASSIGN() function.

Values

SHOWSQL="YES"|"NO"

Table 20. SHOW_SQL Values

Values	Description
YES	Displays the SQL of the query sent to the database.
NO	Hides the SQL of the query sent to the database. NO is the default.

Examples

Example 1: Displays all SQL queries

In the configuration file:

```
DTW_SHOWSQL YES
```

In the macro:

```
%DEFINE SHOWSQL="YES"
```

Example 2: Specifying whether to display SQL using HTML form input.

In the configuration file:

```
DTW_SHOWSQL YES
```

In the macro:

```
SHOWSQL: <INPUT TYPE="radio" NAME="SHOWSQL" VALUE="YES"> Yes  
<INPUT TYPE="radio" NAME="SHOWSQL" VALUE="" CHECKED> No
```

SQL_STATE

AIX	HP-UX	Linux	OS/2	OS/390	OS/400	SCO	SUN	Win NT
X	X	X	X	X	X	X	X	X

Purpose

Accesses or displays the SQL state value returned from the database.

This variable is a predefined variable and its value cannot be modified. Use the variable as a variable reference.

Examples

Example 1: Displays the SQL state in the REPORT block

```
%FUNCTION (DTW_SQL) val1() {
  select * from customer
%REPORT {
  ...
%ROW {
  ...
%}
  SQLSTATE=$(SQL_STATE)
%}
```

TRANSACTION_SCOPE

AIX	HP-UX	Linux	OS/2	OS/390	OS/400	SCO	SUN	Win NT
X	X	X	X	X	X	X	X	X

Purpose

Specifies the transaction scope for SQL commands, determining whether Net.Data issues a COMMIT after each SQL command or after all SQL commands in an HTML block complete successfully. When you specify that all SQL commands must complete successfully before a commit, an unsuccessful SQL command causes all previously executed SQL to *the same database* in that block to be rolled back.

For the TRANSACTION_SCOPE variable to take effect, include it in the ENVIRONMENT statement in the Net.Data configuration file. You can then specify the value of this variable using a DEFINE statement or with the @DTW_ASSIGN() function.

Consistency considerations: On operating systems other than OS/400 and OS/390, updates to the database receiving unsuccessful responses might be rolled back while the updates to the other databases accessed in the same HTML block might be committed when all of the following conditions are true:

- TRANSACTION_SCOPE = "MULTIPLE" is specified
- Multiple databases are accessed in one HTML block (which is possible when using Live Connection)
- An unsuccessful response is returned from an SQL request

If you access multiple databases from Net.Data on OS/400 or using IBM's DataJoiner, you can achieve multiple database update coordination and consistency when updating from Net.Data.

On OS/400 and OS/390, TRANSACTION_SCOPE = "MULTIPLE" causes all IBM database updates issued from a single HTML block to be committed or rolled back together.

On operating systems other than OS/400, the REXX, Perl, and Java language environments run in their own separate operating system processes. Thus, any database updates you issue from these language environments are committed or rolled back separately from database updates issued from a Net.Data macro, regardless of the Net.Data TRANSACTION_SCOPE value.

Values

TRANSACTION_SCOPE="SINGLE"|"MULTIPLE"

Table 21. TRANSACTION_SCOPE Values

Values	Description
SINGLE	Net.Data issues a COMMIT after each SQL command in an HTML block successfully completes.
MULTIPLE	Specifies the Net.Data issues a COMMIT only after all SQL commands in an HTML block complete successfully. MULTIPLE is the default.

Examples

Example 1: Specifies to issue a COMMIT after each transaction

```
%DEFINE TRANSACTION_SCOPE="SINGLE"
```

Net.Data Miscellaneous Variables

These variables are Net.Data-defined variables that you can use to affect Net.Data processing, find out the status of a function call, and obtain information about the result set of a database query, as well as determine information about file locations and dates. You might find these variables useful in functions you write or use them when testing your Net.Data macros.

- “DTW_CURRENT_FILENAME” on page 103
- “DTW_CURRENT_LAST_MODIFIED” on page 104
- “DTW_DEFAULT_MESSAGE” on page 105
- “DTW_LOG_LEVEL” on page 106
- “DTW_MACRO_FILENAME” on page 107
- “DTW_MACRO_LAST_MODIFIED” on page 108
- “DTW_MBMODE” on page 109
- “DTW_MP_PATH” on page 110
- “DTW_MP_VERSION” on page 111
- “DTW_PRINT_HEADER” on page 112
- “DTW_REMOVE_WS” on page 113
- “RETURN_CODE” on page 114

DTW_CURRENT_FILENAME

AIX	HP-UX	Linux	OS/2	OS/390	OS/400	SCO	SUN	Win NT
X	X	X	X	X	X	X	X	X

Purpose

The name and extension of the current input file. The input file is either a Net.Data macro or a file specified in an INCLUDE statement.

This variable is a predefined variable and its value cannot be modified. Use the variable as a variable reference.

Examples

<P>This file is <I>\$(DTW_CURRENT_FILENAME)</I>,
and was updated on \$(DTW_CURRENT_LAST_MODIFIED).

DTW_CURRENT_LAST_MODIFIED

AIX	HP-UX	Linux	OS/2	OS/390	OS/400	SCO	SUN	Win NT
X	X	X	X	X	X	X	X	X

Purpose

The date and time the current file was last modified. The current file can be a Net.Data macro or a file specified in an INCLUDE statement. The output format is determined by the system on which Net.Data runs.

This variable is a predefined variable and its value cannot be modified. Use the variable as a variable reference.

Examples

```
<P>This file is <I>$(DTW_CURRENT_FILENAME)</I>,  
and was updated on $(DTW_CURRENT_LAST_MODIFIED).
```

DTW_DEFAULT_MESSAGE

AIX	HP-UX	Linux	OS/2	OS/390	OS/400	SCO	SUN	Win NT
X	X	X	X		X	X	X	X

Purpose

Contains the message text returned from a call to a built-in function or to language environment when an error occurs.

You can use the DTW_DEFAULT_MESSAGE variable in any part of the Net.Data macro.

This variable is a predefined variable, it is not recommended to modify its value. Use the variable as a variable reference.

Examples

Example 1: A message stating whether the function completed successfully

```
@function1()
%IF ("$(RETURN_CODE)" == "0")
  The function completed successfully.
%ELSE
  The function failed with the return code $(RETURN_CODE). The error message
  returned is "$(DTW_DEFAULT_MESSAGE)".
%ENDIF
```

Example 2: The default text for when a function returns a non-zero return code

```
%MESSAGE{
default: {<h2>Net.Data received return code: $(RETURN_CODE).
Error message is $(DTW_DEFAULT_MESSAGE)</h2> %} : continue
%}
```

The user sees the default error message, if a function returns a return code other than 0.

DTW_LOG_LEVEL

AIX	HP-UX	Linux	OS/2	OS/390	OS/400	SCO	SUN	Win NT
X	X	X	X			X	X	X

Purpose

The level of messages that Net.Data writes to the log file.

You can specify the value of this variable using a DEFINE statement or with the @DTW_ASSIGN() function.

Requirement: Define DTW_LOG_DIR in the Net.Data initialization file to initiate logging; otherwise Net.Data does not log messages when you specify the DTW_LOG_LEVEL variable in the macro.

Values

DTW_LOG_LEVEL="OFF|ERROR|WARNING"

Table 22. DTW_LOG_LEVEL Values

Values	Description
OFF	Net.Data does not log errors. OFF is the default.
ERROR	Net.Data logs error messages.
WARNING	Net.Data logs warnings, as well as error messages.

Examples

```
%DEFINE DTW_LOG_LEVEL="ERROR"
```

DTW_MACRO_FILENAME

AIX	HP-UX	Linux	OS/2	OS/390	OS/400	SCO	SUN	Win NT
X	X	X	X	X	X	X	X	X

Purpose

The name and extension of the current Net.Data macro.

This variable is a predefined variable and its value cannot be modified. Use the variable as a variable reference.

Examples

<P>This Net.Data macro is <I>\$(DTW_MACRO_FILENAME)</I>,
and was updated on \$(DTW_MACRO_LAST_MODIFIED).

DTW_MACRO_LAST_MODIFIED

AIX	HP-UX	Linux	OS/2	OS/390	OS/400	SCO	SUN	Win NT
X	X	X	X	X	X	X	X	X

Purpose

The date and time the Net.Data macro was last modified. The output format depends on the system on which Net.Data runs.

This variable is a predefined variable and its value cannot be modified. Use the variable as a variable reference.

Examples

<P>This Net.Data macro is <I>\$(DTW_MACRO_FILENAME)</I>, and was updated on \$(DTW_MACRO_LAST_MODIFIED).

DTW_MBMODE

AIX	HP-UX	Linux	OS/2	OS/390	OS/400	SCO	SUN	Win NT
X	X	X	X	X		X	X	X

Purpose

Provides multiple-byte character set (MBCS) support for string and word functions used by the Default language environment. You can set this variable in the Net.Data initialization file, but you can use it in the macro to set or override the current setting.

Specify the value of this variable using a DEFINE statement or with the @DTW_ASSIGN() function.

You can set this variable in the Net.Data initialization file, but you can use it in the macro to set or override the current setting.

OS/400 users: Net.Data for OS/400 automatically enables functions for MBCS support and does not need this variable. Net.Data for OS/400 ignores this variable in macros that are migrated to the OS/400 operating system.

Values

DTW_MBMODE="YES"|"NO"

Table 23. DTW_MBMODE Values

Values	Description
YES	Specifies MBCS support for string and word functions.
NO	Specifies that string and word functions do not have MBCS support. NO is the default.

Examples

Example 1: Overrides the value in the INI file

INI file:

```
DTW_MBMODE NO
```

Macro:

```
%DEFINE DTW_MBMODE = "YES"
```

DTW_MP_PATH

AIX	HP-UX	Linux	OS/2	OS/390	OS/400	SCO	SUN	Win NT
X	X	X	X	X	X	X	X	X

Purpose

The path and name of the Net.Data executable file. Depending on your system, the output looks like the following sample path and name:

```
/usr/lpp/internet/server_root/cgi-bin/db2www
```

This variable is a predefined variable and its value cannot be modified. Use the variable as a variable reference.

Examples

The Net.Data executable file is `$(DTW_MP_PATH)`.

DTW_MP_VERSION

AIX	HP-UX	Linux	OS/2	OS/390	OS/400	SCO	SUN	Win NT
X	X	X	X	X	X	X	X	X

Purpose

The version and release number of Net.Data running on the server.

This variable is a predefined variable and its value cannot be modified. Use the variable as a variable reference.

Examples

This Web application uses `$(DTW_MP_VERSION)`.

DTW_PRINT_HEADER

AIX	HP-UX	Linux	OS/2	OS/390	OS/400	SCO	SUN	Win NT
X	X	X	X	X	X	X	X	X

Purpose

Specifies text for the HTTP header.

You must have this variable set before Net.Data processes any text sent to the Web browser, because Net.Data reads this variable once before displaying text and does not look at it again. Any changes to the DTW_PRINT_HEADER variable are ignored after Net.Data has sent text to the browser.

If you are using DTW_PRINT_HEADER to generate your own headers (DTW_PRINT_HEADER = "NO"), you must set DTW_REMOVE_WS to "NO".

Specify the value of this variable using a DEFINE statement or with the @DTW_ASSIGN() function.

Values

DTW_PRINT_HEADER="YES"|"NO"

Table 24. DTW_PRINT_HEADER Values

Values	Description
YES	Net.Data prints out the text Content-type: text/html for the HTTP header. YES is the default.
NO	Net.Data does not print out an HTTP header. You can generate custom HTTP header information.

Examples

One of the most common uses of this variable is to enable Net.Data macros to send cookies. To set a cookie, the DTW_PRINT_HEADER variable must be set to NO, and the first three lines must be the Content-type header, the Set-Cookie statement, and a blank line.

Example 1: Enabling Net.Data to send a cookie

```
%DEFINE DTW_PRINT_HEADER="NO"

%HTML(cookie1) {
Content-type: text/html
Set-Cookie: UsrId=56, expires=Friday, 12-Dec-99, 12:00:00 GMT; path=/

<P>
Any text
%}
```

DTW_REMOVE_WS

AIX	HP-UX	Linux	OS/2	OS/390	OS/400	SCO	SUN	Win NT
X	X	X	X	X	X	X	X	X

Purpose

Reduces the size of a dynamically generated Web page by compressing extra space caused by tabulators, white space, and new-line characters.

Specify the value of this variable in the DEFINE block.

Using <PRE></PRE> tags: Defining this variable to YES affects the amount and type of white space that is printed. If the variable is set to YES, portions of HTML pages that use <PRE></PRE> tags might not display as intended.

If you are using DTW_PRINT_HEADER to generate your own headers (DTW_PRINT_HEADER="NO"), you must set DTW_REMOVE_WS to "NO".

OS/390 users: Set this variable in the Net.Data initialization file to specify a value for all of your macros. You can override the value by defining it in the macro. If DTW_REMOVE_WS is not defined in the macro, it uses the value in the initialization file.

Values

DTW_REMOVE_WS="YES"|"NO"

Table 25. DTW_REMOVE_WS Values

Values	Description
YES	Net.Data compresses a sequence of two or more white spaces to one new-line character, generating shorter HTML result pages.
NO	Net.Data does not compress white spaces. NO is the default.

Examples

Example 1: Compressing white space

DTW_REMOVE_WS="YES"

RETURN_CODE

AIX	HP-UX	Linux	OS/2	OS/390	OS/400	SCO	SUN	Win NT
X	X	X	X	X	X	X	X	X

Purpose

The return code returned by a call to a built-in function or a call to a language environment. Net.Data uses this value to process MESSAGE blocks. You can use this variable to determine whether a function call succeeded or failed. A value of zero indicates successful completion of a function call.

You can reference the RETURN_CODE variable in any part of the Net.Data macro.

This value is predefined; it is not recommended to modify the value. Use it as a variable reference.

Examples

Example 1: A message stating whether the function completed successfully

```
@function1()
%IF ("$(RETURN_CODE)" == "0")
  The function completed successfully.
%ELSE
  The function failed with the return code $(RETURN_CODE).
%ENDIF
```

Example 2: A default message when a return code is not 0

```
%MESSAGE{
default: "<h2>Net.Data received return code: $(RETURN_CODE)</h2>" : continue
%}
```

If a function returns a return code other than 0, the default message is displayed.

Chapter 3. Net.Data Built-in Functions

Net.Data provides a wide variety of functions that you can use without creating your own FUNCTION blocks. Net.Data built-in functions are divided into the following categories:

- **General-purpose functions** help you develop Web pages with Net.Data and do not fit in the other categories. See “General Functions” on page 116.
- **Math functions** perform mathematical operations. See “Math Functions” on page 150.
- **String-manipulation functions** modify strings and characters. See “String Functions” on page 168.
- **Word-manipulation functions** modify words or sets of words. See “Word Functions” on page 195.
- **Table-manipulation functions** help you generate forms and reports from your table data. See “Table Functions” on page 206.
- **Flat-file interface functions** perform file input and output. See “Flat File Interface Functions” on page 250.
- **Web-registry functions** perform operations on a Web registry. See “Web Registry Functions” on page 279.
- **Persistent macro functions** support transaction processing in Net.Data. See “Persistent Macro Functions” on page 299

Although some function parameters are described as having type *integer* or *float*, the terms are used to denote a string that represents an integer or float value, respectively.

Function Names

Net.Data built-in functions begin with DTW, which is a reserved prefix. User-defined functions should not use this prefix.

Using the DTW prefix for functions that are not Net.Data built-in functions may result in unpredictable behavior.

Built-in function names are not case sensitive.

Input and Output Parameters

Functions can have parameter passing specifications that determine whether Net.Data uses the parameter for input, output, or both input and output. These parameter passing specifications are specified by the following keywords:

IN Specifies that the parameter passes input data to the language environment from Net.Data.

OUT Specifies that the parameter returns output data from the language environment to Net.Data.

INOUT Specifies that the parameter passes input data to the language environment and returns output data from the language environment to Net.Data.

Function Result Formatting

Many functions have one or more of the following forms:

- Functions beginning with DTW_r, DTWF_r, and DTWR_r return their results to the function call, so they do not have an output parameter. This example shows the server time:

```
Current local time is @DTW_rTIME().
```

- Functions beginning with DTW_m perform the function on multiple parameters. Each parameter behaves as both an input parameter and an output parameter. The function is performed on the parameter and the results are returned in the parameter. This example converts the three input parameters to all capital letters for a consistent look in the display:

```
@DTW_mUPPERCASE(model, style, shipNo)
Shipment $(shipNo) contains $(quantity) of model $(model) $(style).
```

- Other functions beginning with DTW_, DTWF_, and DTWR_ return their results in an output parameter. You must specify the output parameter. This example shows the server time:

```
@DTW_TIME(nowTime)
Current local time is $(nowTime).
```

Function Parameter Rules

Place function parameters in the correct order. You must specify all *input* parameters before the last input parameter can be specified, or specify a null ("") to accept the default. For example, you can call DTW_TB_INPUT_TEXT as in the following example:

```
@DTW_TB_INPUT_TEXT(myTable, "1", "2", "", "", "32")
```

In the above example the fourth and fifth parameters use default values. Include them as nulls to indicate that "32" is the value for MAXLENGTH in the generated HTML. The final parameter is not specified, so the default value is used. If you choose to accept the default value for MAXLENGTH and the two previous parameters, omit them, as shown below:

```
@DTW_TB_INPUT_TEXT(myTable, "1", "2")
```

You must specify intermediate null values in the parameter lists for input parameters when subsequent non-null *input* parameters exist. You do not need to specify intermediate null input parameters before specifying your final *output* parameter.

General Functions

General functions help you develop Web pages with Net.Data and do not fit in the other categories. The following functions are general-purpose functions:

- "DTW_ADDQUOTE" on page 118
- "DTW_CACHE_PAGE" on page 120
- "DTW_DATE" on page 124
- "DTW_EXIT" on page 126
- "DTW_GETCOOKIE" on page 127
- "DTW_GETENV" on page 129
- "DTW_GETINIDATA" on page 131
- "DTW_HTMLENCODE" on page 132
- "DTW_QHTMLENCODE" on page 134
- "DTW_SENDMAIL" on page 135
- "DTW_SETCOOKIE" on page 140

- “DTW_SETENV” on page 144
- “DTW_TIME” on page 146
- “DTW_URLESCSEQ” on page 148

DTW_ADDQUOTE

AIX	HP-UX	Linux	OS/2	OS/390	OS/400	SCO	SUN	Win NT
X	X	X	X	X	X	X	X	X

Purpose

Replaces single quotes in an input string with two single quotes.

Format

@DTW_ADDQUOTE(stringIn, stringOut)

@DTW_rADDQUOTE(stringIn)

@DTW_mADDQUOTE(stringMult, stringMult2, ..., stringMultn)

Parameters

Table 26. DTW_ADDQUOTE Parameters

Data Type	Parameter	Use	Description
string	<i>stringIn</i>	IN	A variable or literal string. DTW_mADDQUOTE can have multiple input strings.
string	<i>stringOut</i>	OUT	A variable that contains the modified form of <i>stringIn</i> .
string	<i>stringMult</i>	INOUT	<ul style="list-style-type: none">On input: A variable that contains a string.On output: A variable containing the input string with each single quote (') character replaced by two single-quote characters.

Return Codes

Table 27. DTW_ADDQUOTE Return Codes

Return Code	Explanation
-1001	The server could not process a Net.Data request to allocate memory.
1003	The number of parameters passed on a function call either exceeded the maximum number allowed, or was less than the minimum number required by the function.
1005	A parameter passed on a function call, required to be a string variable, was of a different variable type.
1006	A literal string was passed on a function call for a parameter which was required to be an output parameter.

Usage Notes

Consider using this function for all SQL INPUT statements where input is obtained from a Web browser. For example, if you enter O'Brien as a last name, as in the following example, the single quote might give you an error:

```
INSERT INTO USER1.CUSTABLE (LNAME, FNAME)
VALUES ('O'Brien', 'Patrick')
```

Using the DTW_ADDQUOTE function changes the SQL statement and prevents the error:

```
INSERT INTO USER1.CUSTABLE (LNAME, FNAME)
VALUES ('O'Brien', 'Patrick')
```

Examples

Example 1: Adds an extra single quote on the OUT parameter

```
@DTW_ADDQUOTE(string1,string2)
```

- Input: string1="John's Web page"
- Returns: string2="John''s Web page"

Example 2: Adds an extra single quote on the returned value of the function call

```
@DTW_rADDQUOTE("The title of the article is 'Once upon a time'")
```

- Returns: "The title of the article is ''Once upon a time''"

Example 3: Adds extra single quotation marks on each of the INOUT parameters of the function call

```
@DTW_mADDQUOTE(string1,string2)
```

- Input: string1="Joe's bag", string2=""to be or not to be""
- Returns: string1="Joe''s bag", string2=""'to be or not to be''"

Example 4: Inserts extra single quotation marks into data being inserted in a DB2 table

```
%FUNCTION(DTW_SQL) insertName(){
INSERT INTO USER1.CUSTABLE (LNAME,FNAME)
VALUES ('@DTW_rADDQUOTE(lastname)', '@DTW_rADDQUOTE(firstname)')
%}
```

- Input: lastname="O'Brien", firstname="Patrick"
- Returns: "O''Brien", "Patrick"

DTW_CACHE_PAGE

AIX	HP-UX	Linux	OS/2	OS/390	OS/400	SCO	SUN	Win NT
X								

Purpose

Caches partial or complete Web pages that are generated as a result of the processing of macros.

Format

@DTW_CACHE_PAGE(cacheid, url, age, status)

Parameters

Table 28. DTW_CACHE_PAGE Parameters

Parameter	Use	Description
<i>cache_id</i>	IN	A string variable identifying the cache where the page will be placed.
<i>cached_page_ID</i>	IN	A string variable containing an identifier used to locate the cached page in a subsequent DTW_CACHE_PAGE cache request. The string can be a URL.
<i>age</i>	IN	A string variable containing a length of time in seconds. This parameter determines whether a page has expired. If the page is older than <i>age</i> , the page is not sent to the browser. If <i>age</i> is specified as -1, and the page exists in the cache, Net.Data sends it to the Web browser regardless of its age directly from the cache. Net.Data does not replace the page in the cache.
<i>status</i>	OUT	A string variable indicating the state of the cached page. Possible values are in lowercase: <ul style="list-style-type: none"> • ok: The output page will be cached when the macro execution terminates. • new: The page is not in the cache. • renew: The page is in the cache, but has expired. • no_cache: The cache identifier specified does not exist. It must be defined in the cache configuration files. Your macro can continue executing without page caching. • inactive: The cache you specified has been marked inactive. Your macro can continue executing without page caching. • busy: Your macro has issued the DTW_CACHE_PAGE built-in function before in this execution. Your macro can continue executing. • error: An error occurred while trying to communicate with the cache.

Return Codes

Table 29. DTW_CACHE_PAGE Return Codes

Return Code	Explanation
-1001	The server could not process a Net.Data request to allocate memory.
1001	An input parameter contained a NULL value.
1002	An input parameter contained a string value which consisted of the null-terminating character.
1003	The number of parameters passed on a function call either exceeded the maximum number allowed, or was less than the minimum number required by the function.
1005	A parameter passed on a function call, required to be a string variable, was of a different variable type.
1006	A literal string was passed on a function call for a parameter which was required to be an output parameter.
1007	A parameter contains a value which is not valid.

Usage Notes

1. When invoked, DTW_CACHE_PAGE() attempts to retrieve the specified page from the cache and to send it to the Web browser as if it were the output page generated from the macro. If the page is found and it has not expired, Net.Data stops processing the macro, exits from the macro, and sends the cached page to the Web browser.

If the requested page is not in the cache or the existing cached page is older than the value of *age*, Net.Data generates a new output page. When the macro successfully completes, Net.Data sends the new page to the browser and caches the page.

2. For most caching applications, specify DTW_CACHE_PAGE() at the top of the macro to cache all of the Web page that is generated when the macro executes. This technique makes it easier to maintain the macro when the macro is updated. For example, when the function is in the middle of the macro, it might not be noticed when a HTML report section is added earlier in the macro. Net.Data would not cache the new report output. Additionally, this method improves performance as Net.Data stops all further processing when it determines that the page is cached.

For advanced caching applications, you can place the function in specific locations of the macro when you need to make the decision to cache at a specific point during processing, rather than at the beginning of the macro. For example, you might need to make the caching decision based on how many rows are returned from a query or function call.

Examples

Example 1: Places the DTW_CACHE_PAGE() function at the beginning of the macro to capture all HTML output

```
%IF (customer_status == "Classic")
@DTW_CACHE_PAGE("mymacro.mac", "http://www.mypage.org", "-1", status)
%ENDIF
% DEFINE { ...%}

...

%HTML(OUTPUT) {
<title>This is the page title
```

```

</head>
<body>
<center>
This is the Main Heading
<p>It is $(time). Have a nice day!
</body>
</html>

%}

```

Example 2: Places the function in the HTML block because the decision to cache depends on the expected size of the HTML output

```

%DEFINE { ...%}

...

%FUNCTION(DTW_SQL) count_rows(){
    select count(*) from customer
%REPORT{
    %ROW{
        @DTW_ASSIGN(ALL_ROWS, V1)
    %}
    %}
%}

%FUNCTION(DTW_SQL) all_customers(){
    select * from customer
%}

%HTML(OUTPUT) {
<html>
<head>
<title>This is the customer list
</head>
<body>

@count_rows()

    %IF ($(ALL_ROWS) > "100")
    @DTW_CACHE_PAGE("mymacro.mac", "http://www.mypage.org", "-1", status)
%ENDIF

@all_customers()

</body>
</html>
%}

```

In this example, the page is cached or retrieved based on the expected size of the HTML output. HTML output pages are considered cache-worthy only when the database table contains more than 100 rows. Net.Data always sends the text in the OUTPUT block, This is the customer list, to the browser after executing the macro; the text is never cached. The lines following the function call, @count_rows(), are cached or retrieved when the conditions of the IF block are satisfied. Together, both parts form a complete Net.Data output page.

Example 3: Dynamically retrieves the cache ID and the cached page ID

```

%HTML(OUTPUT) {
    %IF (customer == "Joe Smith")

@DTW_CACHE_PAGE(@DTW_rGETENV("DTW_MACRO_FILENAME"), @DTW_rGETENV("URL"), "-1", status)

%ENDIF

```

```
...
<html>
  <head>
    <title>This is the page title</title>
  </head>
  <body>
    <center>
      <h3>This is the Main Heading</h3>
      <p>It is @DTW_rDATE(). Have a nice day!
    </body>
  </html>

%}
```

DTW_DATE

AIX	HP-UX	Linux	OS/2	OS/390	OS/400	SCO	SUN	Win NT
X	X	X	X	X	X	X	X	X

Purpose

Returns the current system date in the specified format.

Format

@DTW_DATE(format, stringOut)

@DTW_DATE(stringOut)

@DTW_rDATE(format)

@DTW_rDATE()

Parameters

Table 30. DTW_DATE Parameters

Data Type	Parameter	Use	Description
string	<i>format</i>	IN	A variable or literal string specifying the data format. Valid formats include: D - Day of the year (001–366) E - European date format (dd/mm/yy) N - Normal date format (dd mon yyyy) O - Ordered date format (yy/mm/dd) S - Standard date format (yyyymmdd) U - USA date format (mm/dd/yy) The default is N.
string	<i>stringOut</i>	OUT	A variable that contains the date in the specified format.

Return Codes

Table 31. DTW_DATE Return Codes

Return Code	Explanation
-1001	The server could not process a Net.Data request to allocate memory.
1001	An input parameter contained a NULL value.
1003	The number of parameters passed on a function call either exceeded the maximum number allowed, or was less than the minimum number required by the function.
1005	A parameter passed on a function call, required to be a string variable, was of a different variable type.
1006	A literal string was passed on a function call for a parameter which was required to be an output parameter.
1007	A parameter contains a value which is not valid.

Examples

Example 1: Normal date format

```
@DTW_DATE(results)
```

- Returns: results = "25 Apr 1997"

Example 2: European date format

```
@DTW_DATE("E", results)
```

- Returns: results="25/04/97"

Example 3: US date format

```
%HTML(report){
```

```
<P>This report created on @DTW_rDATE("U").
```

- Returns: 04/25/97

DTW_EXIT

AIX	HP-UX	Linux	OS/2	OS/390	OS/400	SCO	SUN	Win NT
X	X	X	X	X	X	X	X	X

Purpose

Specifies to leave the macro immediately. Net.Data sends any Web pages that are generated prior to DTW_EXIT() being called to the Web browser .

Format

@DTW_EXIT()

Return Codes

Table 32. DTW_EXIT Return Codes

Return Code	Explanation
1003	The number of parameters passed on a function call either exceeded the maximum number allowed, or was less than the minimum number required by the function.

Usage Notes

1. Use DTW_EXIT() to immediately stop the processing of a macro. Using this technique saves the time Net.Data would use to process the entire file.
2. Ensure that the entire macro is syntactically correct before adding the DTW_EXIT() function. Using DTW_EXIT() causes Net.Data to stop processing the macro when it encounters the call to this function, which can prevent you from catching errors that occur after the DTW_EXIT() function has been processed.

Examples

Example 1: Exiting a macro

```
%HTML(cache_example) {  
  
<html>  
  <head>  
    <title>This is the page title</title>  
  </head>  
  <body>  
    <center>  
      <h3>This is the Main Heading</h3>  
      <!!!!!!!!!!!!!!!!!!!!!!!!!!!!!!!!!!!!!!!!!!!!!!!!!!!!!!!!!!!!!!!!!!!!!!!!!!!!>  
      <! Joe Smith sees a very short page !>  
      <!!!!!!!!!!!!!!!!!!!!!!!!!!!!!!!!!!!!!!!!!!!!!!!!!!!!!!!!!!!!!!!!!!!!!!!!!!!!>  
      %IF (customer == "Joe Smith")  
  
@DTW_EXIT()  
  
%ENDIF  
  
...  
  
</body>  
</html>  
%}
```

DTW_GETCOOKIE

AIX	HP-UX	Linux	OS/2	OS/390	OS/400	SCO	SUN	Win NT
X	X	X	X	X	X	X	X	X

Purpose

Returns the value of the specified cookie.

Format

@DTW_GETCOOKIE(IN cookie_name, OUT cookie_value)

@DTW_rGETCOOKIE(IN cookie_name)

Parameters

Table 33. DTW_GETCOOKIE Parameters

Data Type	Parameter	Use	Description
string	<i>cookie_name</i>	IN	A variable or literal string that specifies the name of the cookie.
string	<i>cookie_value</i>	OUT	<p>A variable containing the value of the cookie retrieved by the function, such as user state information.</p> <p>OS/400 and OS/390 users: If the cookie value has URL style encodings (for example "%20"), the cookie value is decoded before the value is returned.</p> <p>Workstation users: If the cookie value has URL style encodings (for example "%20"), the cookie value is <i>not</i> decoded before the value is returned.</p>

Return Codes

Table 34. DTW_GETCOOKIE Return Codes

Return Code	Explanation
-1001	The server could not process a Net.Data request to allocate memory.
1001	An input parameter contained a NULL value.
1002	An input parameter contained a string value which consisted of the null-terminating character.
1003	The number of parameters passed on a function call either exceeded the maximum number allowed, or was less than the minimum number required by the function.
1005	A parameter passed on a function call, required to be a string variable, was of a different variable type.
1006	A literal string was passed on a function call for a parameter which was required to be an output parameter.
8000	The cookie cannot be found.

Usage Notes

Define and retrieve a cookie in two separate HTTP requests. Because a cookie is visible only after it has been sent to the client, if a macro tries to get a cookie that was defined in the same HTTP request, you might receive unexpected results.

Examples

Example 1: Retrieves cookies that contain user ID and password information

```
@DTW_GETCOOKIE("mycookie_name_for_userID", userID)
@DTW_GETCOOKIE("mycookie_name_for_password", password)
```

Example 2: Determines if a cookie for a user exists before gathering user information

```
%MESSAGE {
    8000 : "" : continue
%}

%HTML(welcome) {
    <html>
    <body>
    <h1>Net.Data Club</h1>
    @DTW_GETCOOKIE("NDC_name", name)
    %IF ( $(RETURN_CODE) == "8000" ) % { The cookie is not found. %}
    <form method="post" action="remember">
    <p>Welcome to the club. Please enter your name.<br>
    <input name="name">
    <input type="submit" value="submit"><br>
    </form>
    %ELSE
    <p>Hi, $(name). Welcome back.
    %ENDIF
    </body>
    </html>
    %}
```

The HTML welcome section checks whether the cookie NDC_name exists. If the cookie exists, the browser displays a personalized greeting. If the cookie does not exist, the form prompts for the user's name, and posts it to the HTML remember section, which sets the user's name into the cookie NDC_name as shown below:

```
%HTML(remember) {
    <html>
    <body>
    <H1>Net.Data Club</H1>
    @DTW_SETCOOKIE("NDC_name", name, "expires=Wednesday, 01-Dec-2010 00:00:00;path=/")
    <p>Thank you.
    <p><a href="welcome">Come back</a>
    </body>
    </html>
    %}
```

DTW_GETENV

AIX	HP-UX	Linux	OS/2	OS/390	OS/400	SCO	SUN	Win NT
X	X	X	X	X	X	X	X	X

Purpose

Returns the value of the specified environment variable.

Format

@DTW_GETENV(envVarName, envVarValue)

@DTW_rGETENV(envVarName)

Parameters

Table 35. DTW_GETENV Parameters

Data Type	Parameter	Use	Description
string	<i>envVarName</i>	IN	A variable or literal string.
string	<i>envVarValue</i>	OUT	The value of the environment variable specified in <i>envVarName</i> . A null string is returned if the value is not found.

Return Codes

Table 36. DTW_GETENV Return Codes

Return Code	Explanation
-1001	The server could not process a Net.Data request to allocate memory.
1003	The number of parameters passed on a function call either exceeded the maximum number allowed, or was less than the minimum number required by the function.
1005	A parameter passed on a function call, required to be a string variable, was of a different variable type.
1006	A literal string was passed on a function call for a parameter which was required to be an output parameter.

Usage Notes

You can also use the ENVVAR statement to reference the values of environment variables. For more information, see "ENVVAR Statement" on page 13.

Examples

Example 1: Returns the value for the PATH statement on the OUT parameter

```
@DTW_GETENV(myEnvVarName, myEnvVarValue)
```

- Input: myEnvVarName = "PATH"
- Returns: myEnvVarValue = "/usr/bin"

Example 2: Returns the value for the PATH statement

```
@DTW_rGETENV(myPath)
```

- Input: myPath = "PATH"
- Returns: "/usr/bin"

Example 3: Returns the value for the protocol of the server

```
The server is @DTW_rGETENV("SERVER_PROTOCOL").
```

- Returns: "HTTP/1.0"

DTW_GETINIDATA

AIX	HP-UX	Linux	OS/2	OS/390	OS/400	SCO	SUN	Win NT
X	X	X	X	X	X	X	X	X

Purpose

Returns the value of the specified configuration variable.

Format

@DTW_GETINIDATA(iniVarName, iniVarValue)

@DTW_rGETINIDATA(iniVarName)

Parameters

Table 37. DTW_GETINIDATA Parameters

Data Type	Parameter	Use	Description
string	<i>iniVarName</i>	IN	A variable or literal string.
string	<i>iniVarValue</i>	OUT	The value of the configuration variable specified in <i>iniVarName</i> .

Return Codes

Table 38. DTW_GETINIDATA Return Codes

Return Code	Explanation
-1001	The server could not process a Net.Data request to allocate memory.
1003	The number of parameters passed on a function call either exceeded the maximum number allowed, or was less than the minimum number required by the function.
1005	A parameter passed on a function call, required to be a string variable, was of a different variable type.
1006	A literal string was passed on a function call for a parameter which was required to be an output parameter.

Usage Notes

1. If a configuration variable is specified that is not the configuration file, Net.Data returns an empty string.
2. **For OS/390, OS/2, Windows NT, and UNIX users:** configuration path variables (MACRO_PATH, EXEC_PATH, and INCLUDE_PATH), as well as ENVIRONMENT statements, cannot be retrieved with this call.
3. **For OS/400 users:** ENVIRONMENT statements cannot be retrieved with this call.

Examples

Example 1: Returns the Net.Data path variable value

```
@DTW_GETINIDATA(myEnvVarName, myEnvVarValue)
```

- Input: myEnvVarName = "FFI_PATH"
- Returns: myEnvVarValue = "D:\FFI"

DTW_HTMLENCODER

AIX	HP-UX	Linux	OS/2	OS/390	OS/400	SCO	SUN	Win NT
X	X	X	X	X	X	X	X	X

Purpose

Encodes selected characters using HTML character escape codes.

Format

@DTW_HTMLENCODER(stringIn, stringOut)

@DTW_rHTMLENCODER(stringIn)

Parameters

Table 39. DTW_HTMLENCODER Parameters

Data Type	Parameter	Use	Description
string	<i>stringIn</i>	IN	A variable or literal string.
string	<i>stringOut</i>	OUT	A variable containing the modified input string in which certain characters have been replaced by the HTML character escape codes.

Return Codes

Table 40. DTW_HTMLENCODER Return Codes

Return Code	Explanation
-1001	The server could not process a Net.Data request to allocate memory.
1003	The number of parameters passed on a function call either exceeded the maximum number allowed, or was less than the minimum number required by the function.
1005	A parameter passed on a function call, required to be a string variable, was of a different variable type.
1006	A literal string was passed on a function call for a parameter which was required to be an output parameter.

Usage Notes

1. Use this function to encode character data that you do not want the Web browser to interpret as HTML. For example, by using the appropriate escape code, you can display characters such as less-than (<) and greater-than (>) within a Web page, which would otherwise be interpreted by the browser as components of HTML tags.
2. Table 41 shows the characters that are encoded by the DTW_HTMLENCODER function.

Table 41. Character Escape Codes for HTML

Character	Name	Code
SPACE	Space	
"	Double quote	"
#	Number sign	#

Table 41. Character Escape Codes for HTML (continued)

%	Percent	%
&	Ampersand	&
[Left bracket	(
]	Right bracket)
+	Plus	+
\	Slash	/
:	Colon	:
;	Semicolon	;
<	Less than	<
=	Equals	=
>	Greater than	>
?	Question mark	?
@	At sign	@
/	Backslash	\
^	Carat	^
{	Left brace	{
	Straight line	|
}	Right brace	}
~	Tilde	~

Examples

Example 1: Encodes the space character

```
@DTW_HTMLENCODE(string1,string2)
```

- Input: string1 = "Jim's dog"
- Returns: string2 = "Jim's dog"

Example 2: Encodes spaces, the less-than sign, and the equal sign

```
@DTW_rHTMLENCODE("X <= 10")
```

- Returns: "X <= 10"

DTW_QHTML ENCODE

AIX	HP-UX	Linux	OS/2	OS/390	OS/400	SCO	SUN	Win NT
X	X	X	X	X	X	X	X	X

Purpose

Performs the same function as @DTW_HTML ENCODE but also encodes the single-quote character (') as '. The HTML character escape codes that DTW_QHTML ENCODE uses are shown in Table 41 on page 132.

Format

@DTW_QHTML ENCODE(stringIn, stringOut)

@DTW_rQHTML ENCODE(stringIn)

Parameters

Table 42. DTW_QHTML ENCODE Parameters

Data Type	Parameter	Use	Description
string	<i>stringIn</i>	IN	A variable or literal string.
string	<i>stringOut</i>	OUT	A variable that contains the modified form of <i>stringIn</i> in which certain characters are replaced by the HTML character escape codes.

Return Codes

Table 43. DTW_QHTML ENCODE Return Codes

Return Code	Explanation
-1001	The server could not process a Net.Data request to allocate memory.
1003	The number of parameters passed on a function call either exceeded the maximum number allowed, or was less than the minimum number required by the function.
1005	A parameter passed on a function call, required to be a string variable, was of a different variable type.
1006	A literal string was passed on a function call for a parameter which was required to be an output parameter.

Examples

Example 1: Encodes an apostrophe and a space

```
@DTW_QHTML ENCODE(string1,string2)
```

- Input: string1 = "Jim's dog"
- Returns: string2 = "Jim's dog"

Example 2: Encodes apostrophes, spaces, and an ampersand

```
@DTW_rQHTML ENCODE("John's & Jane's")
```

- Returns: "John's & Jane's"

DTW_SENDMAIL

AIX	HP-UX	Linux	OS/2	OS/390	OS/400	SCO	SUN	Win NT
X	X	X	X	X	X	X	X	X

Purpose

Dynamically builds and transmits electronic mail (e-mail) messages.

Format

@DTW_SENDMAIL(IN Sender, IN Recipient, IN Message, IN Subject, IN CarbonCopy, IN BlindCarbonCopy, IN ReplyTo, IN Organization)

@DTW_SENDMAIL(IN Sender, IN Recipient, IN Message, IN Subject, IN CarbonCopy, IN BlindCarbonCopy, IN ReplyTo)

@DTW_SENDMAIL(IN Sender, IN Recipient, IN Message, IN Subject, IN CarbonCopy, IN BlindCarbonCopy)

@DTW_SENDMAIL(IN Sender, IN Recipient, IN Message, IN Subject, IN CarbonCopy)

@DTW_SENDMAIL(IN Sender, IN Recipient, IN Message, IN Subject)

@DTW_SENDMAIL(IN Sender, IN Recipient, IN Message)

Parameters

Table 44. DTW_SENDMAIL Parameters

Data Type	Parameter	Use	Description
string	<i>sender</i>	IN	A variable or literal string that specifies the author's address. This parameter is required. Valid formats are: <ul style="list-style-type: none">• Name <user@domain>• <user@domain>• user@domain
string	<i>recipient</i>	IN	A variable or literal string that specifies the e-mail addresses to which this message will be sent. This value can contain multiple recipients, separated by a comma (.). This parameter is required. Valid <i>recipient</i> formats are: <ul style="list-style-type: none">• Name <user@domain>• <user@domain>• user@domain
string	<i>message</i>	IN	A variable or literal string that contains the text of the e-mail message. This parameter is required.
string	<i>subject</i>	IN	A variable or literal string that contains the text of subject line. This is an optional parameter. You must specify a null string ("") to specify additional parameters.

Table 44. DTW_SENDMAIL Parameters (continued)

Data Type	Parameter	Use	Description
string	<i>CarbonCopy</i>	IN	A variable or literal string that contains the e-mail addresses, or names and e-mail addresses of additional recipients. This value can contain multiple additional recipients separated by a comma (.). See the <i>Recipient</i> parameter for valid recipient formats. This is an optional parameter. You must specify a null string ("") to specify additional parameters.
string	<i>BlindCarbonCopy</i>	IN	A variable or literal string that contains the e-mail addresses, or names and e-mail addresses of additional recipients, but the recipients do not appear in the e-mail header. This value can contain multiple additional recipients separated by a comma (.). See the <i>Recipient</i> parameter for valid recipient formats. This is an optional parameter. You must specify a null string ("") to specify additional parameters.
string	<i>ReplyTo</i>	IN	A variable or literal string that contains the e-mail address to which replies to this message should be sent. This is an optional parameter. You must specify a null string ("") to specify additional parameters. Valid <i>ReplyTo</i> formats are: <ul style="list-style-type: none"> • Name <user@domain> • <user@domain> • user@domain
string	<i>Organization</i>	IN	A variable or literal string that contains the organization name of the <i>sender</i> . This is an optional parameter.

Return Codes

Table 45. DTW_SENDMAIL Return Codes

Return Code	Explanation
-1001	The server could not process a Net.Data request to allocate memory.
1001	An input parameter contained a NULL value.
1002	An input parameter contained a string value which consisted of the null-terminating character.
1003	The number of parameters passed on a function call either exceeded the maximum number allowed, or was less than the minimum number required by the function.
1005	A parameter passed on a function call, required to be a string variable, was of a different variable type.
7000	Net.Data is unable to connect to the specified SMTP server.
7001	An SMTP error occurred while Net.Data tried to relay the e-mail message to the specified SMTP server.
7002	The specified SMTP server does not support the Extended Simple Mail Transfer Protocol (ESMTP).

Usage Notes

1. You can use the optional configuration variable, `DTW_SMTP_SERVER`, to specify the SMTP server to use for transmitting e-mail messages. The value of this parameter can either be a host name, an IP address, or a node and name. When this variable is not defined, Net.Data uses the local host as the SMTP server. See the configuration chapter in the *Net.Data Administration and Programming Guide* for your operating system to learn more about this variable.
2. **OS/400, OS/2, Windows NT, and UNIX users:** Standard Simple Mail Transfer Protocol (SMTP) servers accept only 7-bit data, such as U.S. ASCII characters. If your message has 8-bit characters, it is recommended that you specify an Extended Simple Mail Transfer Protocol (ESMTP) server; ESMTP servers accept 8-bit characters. Net.Data does not encode your 8-bit data into 7-bit data. If you do not have access to an ESMTP server, remove all 8-bit characters from the e-mail message.

Net.Data for OS/390 users do not need to modify e-mail messages for SMTP servers.

3. Character set support:
 - **OS/400 users:** You can use the optional configuration variable, `DTW_SMTP_CHARSET` to specified which ASCII character to use when converting the message from EBCDIC to ASCII. If `DTW_SMTP_CHARSET` is not specficied, the default character set is iso-8859-1. See the configuration chapter in *Net.Data Administration and Programming Guide for OS/400* to learn more about this variable and the supported character sets.
 - **OS/2, Windows NT, and UNIX users:** Table 46 describes the supported character sets:

Table 46. Character sets supported by Net.Data

Locale	Character set	OS/2 or UNIX codepage	Windows NT codepage
U.S, Western Europe	"iso-8859-1"	819	1252
Japan	"x-sjis"	943	932
Chinese (simplified)	"gb2312"	1381	936
Korea	"euc-kr"	970	949
Chinese (traditional)	"big5"	950	950

4. The following list describes conditions under which Net.Data does not send an e-mail message:
 - The specified SMTP server cannot be reached.
 - The specified SMTP server does not support the Extended Simple Mail Transfer Protocol (ESMTP), but the specified e-mail message contains non-U.S. ASCII characters.

Examples

Example 1: Function call that builds and sends a simple e-mail message

```
@DTW_SENDMAIL("<ibmuser1@ibm.com>", "<ibmuser2@ibm.com>", "There is a meeting at 9:30.", "Status meeting")
```

The `DTW_SENDMAIL` function sends an e-mail message with the following information:

Date: Mon, 3 Apr 1998 09:54:33 PST
To: <ibmuser2@ibm.com>
From: <ibmuser1@ibm.com>
Subject: Status meeting

There is a meeting at 9:30.

The information for Date is constructed by using the system date and time functions and is formatted in a SMTP-specific data format.

Example 2: Function call that builds and sends an e-mail message with multiple recipients, carbon copy and blind carbon copy recipients, and the company name

```
@DTW_SENDMAIL("IBM User 1 <ibmuser1@ibm.com>", "IBM User 2 <ibmuser2@ibm.com>,  
IBM User 3 <ibmuser3@ibm.com>, IBM User 4 <ibmuser4@ibm.com>", "There is a meeting at 9:30.",  
"Status meeting", "IBM User 5 <ibmuser5@ibm.com>", "IBM User 6 <ibmuser6@ibm.com>,"  
"meeting@ibm.com", "IBM")
```

The DTW_SENDMAIL function sends an e-mail message with the following information:

Date: Mon, 3 Apr 1998 09:54:33 PST
To: IBM User 2 <ibmuser2@ibm.com>, IBM User 3 <ibmuser3@ibm.com>, IBM User 4 <ibmuser4@ibm.com>
CC: IBM User 5 <ibmuser5@ibm.com>
BCC: IBM User 6 <ibmuser6@ibm.com>
From: IBM User 1 <ibmuser1@ibm.com>
ReplyTo: meeting@ibm.com
Organization: IBM
Subject: Status meeting

There is a meeting at 9:30.

Example 3: Macro that builds and sends e-mail through a Web form interface

```
%HTML(start) {  
<html>  
<body>  
<h1>Net.Data E-Mail Example</h1>  
<form method="post" action="sendemail">  
<p>To:<br><input name="recipient"><p>  
Subject:<br><input name="subject"><p>  
Message:<br><textarea name=message rows=20 cols=40>  
</textarea><p>  
<input type="submit" value="Send E-mail"><br>  
</form>  
</body>  
</html>  
%}  
  
%HTML(sendemail) {  
<html>  
<body>  
<h1>Net.Data E-Mail Example</h1>  
&DTW_SENDMAIL("Net.Data E-mail Service <netdata@us.ibm.com>", recipient, message, subject)  
<p>E-mail has been sent out.  
</body>  
</html>  
%}
```

This macro sends e-mail through a Web form interface. The HTML start section displays a form into which the recipient's e-mail address, a subject, and a message can be typed. When the user clicks on the **Send E-mail** button, the message is sent out to the recipients specified in the HTML(sendemail) section. This section calls DTW_SENDMAIL and uses the parameters obtained from the Web form to

determine the content of the e-mail message, as well as the sender and recipients. Once the e-mail messages have been sent, a confirmation notice is displayed.

Example 4: A macro that uses an SQL query to determine the list of recipients

```
%Function(DTW_SQL) mailing_list(IN message) {
  SELECT EMAIL_ADDRESS FROM CUSTOMERS WHERE ZIPCODE='CA'
  %REPORT {
    Sending out product information to all customers who live in California...<P>
    %ROW {
      @DTW_SENDMAIL("John Doe Corp. <John.Doe@doe.com>", V1, message, "New Product Release")
      E-mail sent out to customer ${V1}.<BR>
    }
  }
}
```

This macro sends out an automated e-mail message to a specified group of customers determined by the results of a SQL query from the customer database. The SQL query also retrieves the e-mail addresses of the customers. The e-mail contents are determined by the value of *message* and can be static or dynamic (for example, you could use another SQL query to dynamically specify the version number of the product or the prices of various offerings).

DTW_SETCOOKIE

AIX	HP-UX	Linux	OS/2	OS/390	OS/400	SCO	SUN	Win NT
X	X	X	X	X	X	X	X	X

Purpose

Generates JavaScript code that sets a cookie on the client system.

Format

@DTW_SETCOOKIE(IN cookie_name, IN cookie_value, IN advanced_options)

@DTW_SETCOOKIE(IN cookie_name, IN cookie_value)

Parameters

Table 47. DTW_SETCOOKIE Parameters

Data Type	Parameter	Use	Description
string	<i>cookie_name</i>	IN	A variable or literal string that specifies the name of the cookie
string	<i>cookie_value</i>	IN	A variable or literal string the specifies the value of the cookie. Avoid using semicolons, commas, and spaces as a part of <i>cookie_value</i> . When they are required, use the Net.Data function DTW_rURLESCSEQ to process the string that contains the special characters before passing it to DTW_SETCOOKIE. For example, <pre>@DTW_SETCOOKIE("my_cookie_name", @DTW_rURLESCSEQ("my cookie value"))</pre>

Table 47. DTW_SETCOOKIE Parameters (continued)

Data Type	Parameter	Use	Description
string	<i>advanced_options</i>	IN	<p>A string that contains optional attributes, separated by semicolons, that are used to define the cookie. These attributes can be:</p> <p>expires = date Specifies a date string that defines the valid lifetime of the cookie. After the date expires, the cookie is not longer stored or retrieved. Syntax: <i>weekday</i>, <i>DD-month-YYYY HH:MM:SS GMT</i></p> <p>Where:</p> <p><i>weekday</i> Specifies the full name of the weekday.</p> <p><i>DD</i> Specifies the numerical date of the month.</p> <p><i>month</i> Specifies the three-character abbreviation of the month.</p> <p><i>YYYY</i> Specifies the four-character number of the year.</p> <p><i>HH:MM:SS</i> Specifies the timestamp with hours, minutes, and seconds.</p> <p>domain = domain_name Specifies the domain attributes of the cookie, for use in domain attribute matching.</p> <p>path = path Specifies the subset of URLs in a domain for which the cookie is valid.</p> <p>secure Specifies that the cookie is transmitted only over secured channels to HTTPS servers.</p> <p>When the <i>secure</i> option is not specified, the cookie can be sent over unsecured channels. The <i>secure</i> option does not require that the browser encrypt the cookie, nor does it ensure that the page containing the DTW_SETCOOKIE statement is transmitted over SSL.</p> <p>For additional information about the advanced options, see the Netscape cookie specification at http://home.netscape.com</p>

Return Codes

Table 48. DTW_SETCOOKIE Return Codes

Return Code	Explanation
-1001	The server could not process a Net.Data request to allocate memory.

Table 48. DTW_SETCOOKIE Return Codes (continued)

Return Code	Explanation
1001	An input parameter contained a NULL value.
1002	An input parameter contained a string value which consisted of the null-terminating character.
1003	The number of parameters passed on a function call either exceeded the maximum number allowed, or was less than the minimum number required by the function.
1005	A parameter passed on a function call, required to be a string variable, was of a different variable type.

Usage Notes

1. If the client Web browser does not support Java Script, the browser does not set the cookie.
2. Because DTW_SETCOOKIE generates Java Script code, do not call DTW_SETCOOKIE inside a <SCRIPT> or <NOSCRIPT> HTML element.
3. To retrieve a cookie, use the DTW_GETCOOKIE() function. See "DTW_GETCOOKIE" on page 127 to learn how to define a cookie.
4. Define and retrieve a cookie in two separate HTTP requests. Because a cookie is visible only after it has been sent to the client, if a macro tries to get a cookie that was defined in the same HTTP request, you might receive unexpected results.

Examples

Example 1: Defines cookies that contain user ID and password information with the Secure advanced option

```
@DTW_SETCOOKIE("mycookie_name_for_userID", "User1")
@DTW_SETCOOKIE("mycookie_name_for_password", "sd3dT", "secure")
```

Example 2: Defines cookies that contain the expiration date advanced option

```
@DTW_SETCOOKIE("mycookie_name_for_userID", "User1",
    "expires=Wednesday 01-Dec-2010 00:00:00")
@DTW_SETCOOKIE("mycookie_name_for_password", "sd3dT",
    "expires=Wednesday, 01-Dec-2010 00:00:00;secure")
```

Function calls should be on one line; the lines are split in this example for formatting purposes.

Example 3: Determines if a cookie for a user exists before gathering user information

```
%HTML(welcome) {
  <html>
  <body>
  <h1>Net.Data Club</h1>
  @DTW_GETCOOKIE("NDC_name", name)
  %IF ( $(RETURN_CODE) == "8000" ) %{ The cookie is not found. %}
  <form method="post" action="remember">
  <p>Welcome to the club. Please enter your name.<br>
  <input name="name">
  <input type="submit" value="submit"><br>
  </form>
  %ELSE
  <p>Hi, $(name). Welcome back.
```

```
%ENDIF
</body>
</html>
%}
```

The HTML(welcome) section checks whether the cookie NDC_name exists. If the cookie exists, the browser displays a personalized greeting. If the cookie does not exist, the browser prompts for the user's name, and posts it to the HTML(remember) section. This section records the user's name into the cookie NDC_name as shown below:

```
%HTML(remember) {
  <html>
  <body>
  <H1>Net.Data Club>
  @DTW_SETCOOKIE("NDC_name", name, "expires=Wednesday, 01-Dec-2010 00:00:00;path=/")
  <p>Thank you.
  <p><a href="welcome">Come back</a>
  </body>
  </html>
  %}
```

DTW_SETENV

AIX	HP-UX	Linux	OS/2	OS/390	OS/400	SCO	SUN	Win NT
X	X	X	X	X	X	X	X	X

Purpose

Assigns an environment variable with a specified value and returns the previous value.

Format

@DTW_SETENV(envVarName, envVarValue, prevValue)

@DTW_rSETENV(envVarName, envVarValue)

Parameters

Table 49. DTW_SETENV Parameters

Data Type	Parameter	Use	Description
string	<i>envVarName</i>	IN	A variable or literal string representing the environment variable.
string	<i>envVarValue</i>	IN	A variable or literal string with the value to which the environment variable is assigned.
string	<i>prevValue</i>	OUT	A variable that contains the previous value of the environment variable.

Return Codes

Table 50. DTW_SETENV Return Codes

Return Code	Explanation
-1001	The server could not process a Net.Data request to allocate memory.
1001	An input parameter contained a NULL value.
1003	The number of parameters passed on a function call either exceeded the maximum number allowed, or was less than the minimum number required by the function.
1005	A parameter passed on a function call, required to be a string variable, was of a different variable type.
1006	A literal string was passed on a function call for a parameter which was required to be an output parameter.

Usage Notes

If no previous value for the environment variable is found, an empty string is returned.

Examples

Example 1: Returns the value for the previous path

```
@DTW_SETENV("PATH", "myPath", prevValue)
```

- Input: envVarName = "PATH", envVarValue = "myPath"
- Returns: prevValue = "myPreviousPath"

Example 2: Returns the value for the previous path and assigns the value for PATH value

```
@DTW_rSETENV("PATH", "myPath")
```

- Input: envVarName = "PATH", envVarValue = "myPath"
- Returns: "myPreviousPath", PATH = "myPath"

DTW_TIME

AIX	HP-UX	Linux	OS/2	OS/390	OS/400	SCO	SUN	Win NT
X	X	X	X	X	X	X	X	X

Purpose

Returns the current system time in the specified format.

Format

@DTW_TIME(stringIn, stringOut)

@DTW_TIME(stringOut)

@DTW_rTIME(stringIn)

@DTW_rTIME()

Parameters

Table 51. DTW_TIME Parameters

Data Type	Parameter	Use	Description
string	<i>stringIn</i>	IN	A variable or literal string specifying the time format. Valid formats are: C - Civil time (hh:mmAM/PM using a 12-hour clock) L - Local time (hh:mm:ss) N - Normal time (hh:mm:ss using a 24-hour clock); default X - Extended time (hh:mm:ss.ccc, using a 24-hour clock and where ccc is the number of milliseconds) H - Number of hours since midnight M - Number of minutes since midnight S - Number of seconds since midnight
string	<i>stringOut</i>	OUT	A variable that contains the time in the specified format.

Return Codes

Table 52. DTW_TIME Return Codes

Return Code	Explanation
-1001	The server could not process a Net.Data request to allocate memory.
1003	The number of parameters passed on a function call either exceeded the maximum number allowed, or was less than the minimum number required by the function.
1005	A parameter passed on a function call, required to be a string variable, was of a different variable type.
1006	A literal string was passed on a function call for a parameter which was required to be an output parameter.
1007	A parameter contains a value which is not valid.

Examples

Example 1: Twenty-four hour clock format

```
@DTW_TIME(results)
```

- Returns: results = "10:30:53"

Example 2: Civil time format

```
@DTW_TIME("C", results)
```

- Returns: results = "10:30AM"

Example 3: Returns the number of minutes since midnight with the function call

```
@DTW_rTIME("M")
```

- Returns: "630"

Example 4: Returns the default time and data formats with the function call

```
%REPORT{
```

```
<P>This report was created at @DTW_rTIME(), @DTW_rDATE().
```

```
%}
```

- Returns: This report was created 15:04:39, 01 May 1997.

DTW_URLESCSEQ

AIX	HP-UX	Linux	OS/2	OS/390	OS/400	SCO	SUN	Win NT
X	X	X	X	X	X	X	X	X

Purpose

Replaces selected characters not allowed in a URL with their escape values, known as URL-encoded codes.

Format

@DTW_URLESCSEQ(stringIn, stringOut)

@DTW_rURLESCSEQ(stringIn)

Parameters

Table 53. DTW_URLESCSEQ Parameters

Data Type	Parameter	Use	Description
string	<i>stringIn</i>	IN	A variable or literal string.
string	<i>stringOut</i>	OUT	A variable containing the input string with characters that are not allowed in URLs that are replaced with their hexadecimal escape values.

Return Codes

Table 54. DTW_URLESCSEQ Return Codes

Return Code	Explanation
-1001	The server could not process a Net.Data request to allocate memory.
1003	The number of parameters passed on a function call either exceeded the maximum number allowed, or was less than the minimum number required by the function.
1005	A parameter passed on a function call, required to be a string variable, was of a different variable type.
1006	A literal string was passed on a function call for a parameter which was required to be an output parameter.

Usage Notes

Use this function to pass any of the characters listed in Table 55 to another macro or HTML block.

Table 55. Character Escape Values for URLs

Character	Name	Code
SPACE	Space	%20
"	Double quote	%22
#	Number sign	%23
%	Percent	%25
&	Ampersand	%26
+	Plus	%2B
\	Backslash	%2F

Table 55. Character Escape Values for URLs (continued)

:	Colon	%3A
;	Semicolon	%3B
<	Less than	%3C
=	Equals	%3D
>	Greater than	%3E
?	Question mark	%3F
@	At sign	%40
[Left bracket	%5B
/	Slash	%5C
]	Right bracket	%5D
^	Carat	%5E
{	Left brace	%7B
	Straight line	%7C
}	Right brace	%7D
-	Tilde	%7E

Examples

Example 1: Replaces the space and an ampersand characters in *string1* with their escape values and assigns the result to *string2*

```
@DTW_URLESCSEQ(string1,string2)
```

- Input: string1 = "Guys & Dolls"
- Returns: string2 = "Guys%20%26%20Dolls"

Example 2: Replaces space and ampersand characters with their escape codes.

```
@DTW_rURLESCSEQ("Guys & Dolls")
```

- Returns: "Guys%20%26%20Dolls"

Example 3: Uses DTW_rURLESCSEQ in a ROW block, and replaces space and 'at' characters with their escape codes.

```
%ROW{
```

```
<P><a href="fullrpt.mac/input?name=@DTW_rURLESCSEQ(V1)&email=@DTW_rURLESCSEQ(V2)">
$(V1)</a>
```

```
%}
```

- Input: V1="Patrick O'Brien", V2="obrien@ibm.com"
- Returns:

```
<P><a href="fullrpt.mac/input?name=Patrick%20'O'Brien&email="obrien%40ibm.com">
Patrick O'Brien</a>
```

When the application user clicks on the name "Patrick O'Brien," the values specified for the name and e-mail address flow within the query string of the URL that causes Net.Data to execute the input section of the fullrpt.mac macro.

Math Functions

These functions let you do mathematical calculations.

NLS considerations for math functions: Net.Data displays decimal points in numerical values based on regional settings specified at the Web server under which Net.Data is running. For example, if the decimal point is specified as a comma (,) at the Web server, Net.Data uses the comma to format decimal data. Net.Data uses the following settings to determine which character is used to specify a decimal point:

For OS/390, Windows NT, OS/2, and UNIX operating systems:

The LOCALE under which the Web server executes

For the OS/400 operating system:

- V4R2 or subsequent releases: specified by the user profile under which the process is running.
- V4R1 or previous releases: retrieved from the QDECFMT system value.

The following functions are available for mathematical calculations:

- “DTW_ADD” on page 151
- “DTW_DIVIDE” on page 153
- “DTW_DIVREM” on page 155
- “DTW_FORMAT” on page 157
- “DTW_INTDIV” on page 160
- “DTW_MULTIPLY” on page 162
- “DTW_POWER” on page 164
- “DTW_SUBTRACT” on page 166

DTW_ADD

AIX	HP-UX	Linux	OS/2	OS/390	OS/400	SCO	SUN	Win NT
X	X	X	X	X	X	X	X	X

Purpose

Adds two numbers.

Format

@DTW_ADD(number1, number2, precision, result)

@DTW_ADD(number1, number2, result)

@DTW_rADD(number1, number2, precision)

@DTW_rADD(number1, number2)

Parameters

Table 56. DTW_ADD Parameters

Data Type	Parameter	Use	Description
float	<i>number1</i>	IN	A variable or literal string representing a number.
float	<i>number2</i>	IN	A variable or literal string representing a number.
integer	<i>precision</i>	IN	A variable or literal string representing a positive whole number that specifies the precision of the result. The default is 9.
float	<i>result</i>	OUT	A variable that contains the sum of <i>number1</i> and <i>number2</i> .

Return Codes

Table 57. DTW_ADD Return Codes

Return Code	Explanation
-1001	The server could not process a Net.Data request to allocate memory.
1001	An input parameter contained a NULL value.
1002	An input parameter contained a string value which consisted of the null-terminating character.
1003	The number of parameters passed on a function call either exceeded the maximum number allowed, or was less than the minimum number required by the function.
1005	A parameter passed on a function call, required to be a string variable, was of a different variable type.
1006	A literal string was passed on a function call for a parameter which was required to be an output parameter.
4000	A parameter contains an invalid whole number value.
4001	A parameter contains an invalid number value.
4002	The result of an arithmetic operation had an exponent that was outside the supported range of -999,999,999 to +999,999,999.

Examples

Example 1:

```
@DTW_ADD(NUM1, NUM2, "2", result)
```

- Input: NUM1 = "105", NUM2 = "3"
- Returns: result = "1.1E+2"

Example 2:

```
@DTW_rADD("12", NUM2, "5")
```

- Input: NUM2 = "7.00"
- Returns: "19.00"

DTW_DIVIDE

AIX	HP-UX	Linux	OS/2	OS/390	OS/400	SCO	SUN	Win NT
X	X	X	X	X	X	X	X	X

Purpose

Divides one number by the other.

Format

@DTW_DIVIDE(number1, number2, precision, result)

@DTW_DIVIDE(number1, number2, result)

@DTW_rDIVIDE(number1, number2, precision)

@DTW_rDIVIDE(number1, number2)

Parameters

Table 58. DTW_DIVIDE Parameters

Data Type	Parameter	Use	Description
float	<i>number1</i>	IN	A variable or literal string representing a number that is to be divided.
float	<i>number2</i>	IN	A variable or literal string representing a number.
integer	<i>precision</i>	IN	A variable or literal string representing a positive whole number that specifies the precision of the result. The default is 9.
float	<i>result</i>	OUT	A variable that contains the result of <i>number1</i> divided by <i>number2</i> .

Return Codes

Table 59. DTW_DIVIDE Return Codes

Return Code	Explanation
-1001	The server could not process a Net.Data request to allocate memory.
1001	An input parameter contained a NULL value.
1002	An input parameter contained a string value which consisted of the null-terminating character.
1003	The number of parameters passed on a function call either exceeded the maximum number allowed, or was less than the minimum number required by the function.
1005	A parameter passed on a function call, required to be a string variable, was of a different variable type.
1006	A literal string was passed on a function call for a parameter which was required to be an output parameter.
4000	A parameter contains an invalid whole number value.
4001	A parameter contains an invalid number value.
4002	The result of an arithmetic operation had an exponent that was outside the supported range of -999,999,999 to +999,999,999.

Examples

Example 1:

```
@DTW_DIVIDE("8.0", NUM2, result)
```

- Input: NUM2 = "2"
- Returns: result = "4"

Example 2:

```
@DTW_rDIVIDE("1", NUM2, "5")
```

- Input: "1", NUM2 = "3"
- Returns: "0.33333"

Example 3:

```
@DTW_rDIVIDE(NUM1, "2", "5")
```

- Input: NUM1 = "5"
- Returns: "2.5"

DTW_DIVREM

AIX	HP-UX	Linux	OS/2	OS/390	OS/400	SCO	SUN	Win NT
X	X	X	X	X	X	X	X	X

Purpose

Divides one number by the other and returns the remainder.

Format

@DTW_DIVREM(number1, number2, precision, result)

@DTW_DIVREM(number1, number2, result)

@DTW_rDIVREM(number1, number2, precision)

@DTW_rDIVREM(number1, number2)

Parameters

Table 60. DTW_DIVREM Parameters

Data Type	Parameter	Use	Description
float	<i>number1</i>	IN	A variable or literal string representing a number that is to be divided.
float	<i>number2</i>	IN	A variable or literal string representing a number.
integer	<i>precision</i>	IN	A variable or literal string representing a positive whole number that specifies the precision of the result. The default is 9.
float	<i>result</i>	OUT	A variable that contains the remainder of <i>number1</i> divided by <i>number2</i> .

Return Codes

Table 61. DTW_DIVIDEREM Return Codes

Return Code	Explanation
-1001	The server could not process a Net.Data request to allocate memory.
1001	An input parameter contained a NULL value.
1002	An input parameter contained a string value which consisted of the null-terminating character.
1003	The number of parameters passed on a function call either exceeded the maximum number allowed, or was less than the minimum number required by the function.
1005	A parameter passed on a function call, required to be a string variable, was of a different variable type.
1006	A literal string was passed on a function call for a parameter which was required to be an output parameter.
4000	A parameter contains an invalid whole number value.
4001	A parameter contains an invalid number value.
4002	The result of an arithmetic operation had an exponent that was outside the supported range of -999,999,999 to +999,999,999.

Usage Notes

The sign of the remainder, if nonzero, is the same as that of the first parameter.

Examples

Example 1:

```
@DTW_DIVREM(NUM1, NUM2, result)
```

- Input: NUM1 = "2.1", NUM2 = "3"

- Returns: result = "2.1"

Example 2:

```
@DTW_rDIVREM("10", NUM2)
```

- Input: NUM2 = "0.3"

- Returns: "0.1"

Example 3:

```
@DTW_rDIVREM("3.6", "1.3")
```

- Returns: "1.0"

Example 4:

```
@DTW_rDIVREM("-10", "3")
```

- Returns: "-1"

DTW_FORMAT

AIX	HP-UX	Linux	OS/2	OS/390	OS/400	SCO	SUN	Win NT
X	X	X	X	X	X	X	X	X

Purpose

Customizes the formatting for a number.

Format

@DTW_FORMAT(number, before, after, exp, expt, precision, result)

@DTW_FORMAT(number, before, after, exp, expt, result)

@DTW_FORMAT(number, before, after, exp, result)

@DTW_FORMAT(number, before, after, result)

@DTW_FORMAT(number, before, result)

@DTW_FORMAT(number, result)

@DTW_rFORMAT(number, before, after, exp, expt, precision)

@DTW_rFORMAT(number, before, after, exp, expt)

@DTW_rFORMAT(number, before, after, exp)

@DTW_rFORMAT(number, before, after)

@DTW_rFORMAT(number, before)

@DTW_rFORMAT(number)

Parameters

Table 62. DTW_FORMAT Parameters

Data Type	Parameter	Use	Description
float	<i>number</i>	IN	A variable or literal string representing a number.
integer	<i>before</i>	IN	A variable or literal string representing a positive whole number. This is an optional parameter. You must enter a null string ("") to have additional parameters.
integer	<i>after</i>	IN	A variable or literal string representing a positive whole number. This is an optional parameter. You must enter a null string ("") to specify additional parameters.
integer	<i>exp</i>	IN	A variable or literal string representing a positive whole number. You must specify a null string ("") to specify additional parameters.
integer	<i>expt</i>	IN	A variable or literal string representing a positive whole number. You must enter a null string ("") to specify additional parameters.
integer	<i>precision</i>	IN	A variable or literal string representing a positive whole number that specifies the precision of the result. The default is 9.
float	<i>result</i>	OUT	A variable that contains the number with the specified rounding and formatting.

Return Codes

Table 63. DTW_FORMAT Return Codes

Return Code	Explanation
-1001	The server could not process a Net.Data request to allocate memory.
1001	An input parameter contained a NULL value.
1002	An input parameter contained a string value which consisted of the null-terminating character.
1003	The number of parameters passed on a function call either exceeded the maximum number allowed, or was less than the minimum number required by the function.
1005	A parameter passed on a function call, required to be a string variable, was of a different variable type.
1006	A literal string was passed on a function call for a parameter which was required to be an output parameter.
4000	A parameter contains an invalid whole number value.
4001	A parameter contains an invalid number value.

Usage Notes

1. If *number* is the only parameter is specified, the result is formatted as if @DTW_rADD(number,"0") was executed.
2. The *before* and *after* parameters describe how many characters are used for the integer and decimal parts of the *result* parameter, respectively. If you omit either or both of these parameters, the number of characters used for that part is as many as is needed.
3. If the *before* parameter is not large enough to contain the integer part of the number (plus the sign for a negative number), an error results. If the *before* parameter is larger than needed for that part, the *number* parameter value is padded on the left with blanks. If the *after* parameter is not the same size as the decimal part of the *number* parameter, the number is rounded (or extended with zeros) to fit. Specifying 0 causes the number to be rounded to an integer.
4. The *expp* and *expt* parameters control the exponent part of the result. The *expp* parameter sets the number of places for the exponent part; the default is to use as many as is needed (which may be zero). The *expt* parameter sets the trigger point for use of exponential notation. The default is the default value of the precision parameter.
5. If *expp* is 0, no exponent is supplied and the number is expressed in simple form with added zeros as necessary. If *expp* is not large enough to contain the exponent, an error results.
6. If the number of places needed for the integer or decimal part exceeds *expt* or twice *expt*, respectively, use the exponential notation. If *expt* is 0, exponential notation is always used unless the exponent is 0. (If *expp* is 0, this overrides a 0 value of *expt*.) If the exponent is 0 when a nonzero *expp* is specified, then *expp*+2 blanks are supplied for the exponent part of the result. If the exponent is 0 and *expp* is not specified, the simple form is used.

Examples

Example 1:

```
@DTW_FORMAT(NUM, BEFORE, result)
• Input: NUM = "3", BEFORE = "4"
• Returns: result= " 3"
```

Example 2:

```
@DTW_FORMAT("1.73", "4", "0", result)
```

- Returns: result = " 2"

Example 3:

```
@DTW_FORMAT("1.73", "4", "3", result)
```

- Returns: result = " 1.730"

Example 4:

```
@DTW_FORMAT(" - 12.73", "", "4", result)
```

- Returns: result = "-12.7300"

Example 5:

```
@DTW_FORMAT("12345.73", "", "", "2", "2", result)
```

- Returns: result = "1.234573E+04"

Example 6:

```
@DTW_FORMAT("1.234573", "", "3", "", "0", result)
```

- Returns: result = "1.235"

Example 7:

```
@DTW_rFORMAT(" - 12.73")
```

- Returns: " - 12.73"

Example 8:

```
@DTW_rFORMAT("0.000")
```

- Returns: "0"

Example 9:

```
@DTW_rFORMAT("12345.73", "", "", "3", "6")
```

- Returns: "12345.73"

Example 10:

```
@DTW_rFORMAT("1234567e5", "", "3", "0")
```

- Returns: "123456700000.000"

Example 11:

```
@DTW_rFORMAT("12345.73", "", "3", "", "0")
```

- Returns: "1.235E+4"

DTW_INTDIV

AIX	HP-UX	Linux	OS/2	OS/390	OS/400	SCO	SUN	Win NT
X	X	X	X	X	X	X	X	X

Purpose

Divides one number by the other and returns the integer part of the result.

Format

@DTW_INTDIV(number1, number2, precision, result)

@DTW_INTDIV(number1, number2, result)

@DTW_rINTDIV(number1, number2, precision)

@DTW_rINTDIV(number1, number2)

Parameters

Table 64. DTW_INTDIV Parameters

Data Type	Parameter	Use	Description
float	<i>number1</i>	IN	A variable or literal string representing a number a number that is to be divided.
float	<i>number2</i>	IN	A variable or literal string representing a number.
integer	<i>precision</i>	IN	A variable or literal string representing a positive whole number that specifies the precision of the result. The default is 9.
float	<i>result</i>	OUT	A variable that contains integer part of <i>number1</i> divided by <i>number2</i> .

Return Codes

Table 65. DTW_INTDIV Return Codes

Return Code	Explanation
-1001	The server could not process a Net.Data request to allocate memory.
1001	An input parameter contained a NULL value.
1003	The number of parameters passed on a function call either exceeded the maximum number allowed, or was less than the minimum number required by the function.
1005	A parameter passed on a function call, required to be a string variable, was of a different variable type.
1006	A literal string was passed on a function call for a parameter which was required to be an output parameter.
4000	A parameter contains an invalid whole number value.
4001	A parameter contains an invalid number value.
4002	The result of an arithmetic operation had an exponent that was outside the supported range of -999,999,999 to +999,999,999.

Examples

Example 1:

```
@DTW_INTDIV(NUM1, NUM2, result)
```

- Input: NUM1 = "10", NUM2 = "3"
- Returns: result = "3"

Example 2:

```
@DTW_rINTDIV("2", NUM2)
```

- Input: NUM2 = "3"
- Returns: "0"

DTW_MULTIPLY

AIX	HP-UX	Linux	OS/2	OS/390	OS/400	SCO	SUN	Win NT
X	X	X	X	X	X	X	X	X

Purpose

Multiplies two numbers.

Format

@DTW_MULTIPLY(number1, number2, precision, result)

@DTW_MULTIPLY(number1, number2, result)

@DTW_rMULTIPLY(number1, number2, precision)

@DTW_rMULTIPLY(number1, number2)

Parameters

Table 66. DTW_MULTIPLY Parameters

Data Type	Parameter	Use	Description
float	<i>number1</i>	IN	A variable or literal string representing a number.
float	<i>number2</i>	IN	A variable or literal string representing a number.
integer	<i>precision</i>	IN	A variable or literal string representing a positive whole number that specifies the precision of the result. The default is 9.
float	<i>result</i>	OUT	A variable that contains the product of <i>number1</i> and <i>number2</i> .

Return Codes

Table 67. DTW_MULTIPLY Return Codes

Return Code	Explanation
-1001	The server could not process a Net.Data request to allocate memory.
1001	An input parameter contained a NULL value.
1002	An input parameter contained a string value which consisted of the null-terminating character.
1003	The number of parameters passed on a function call either exceeded the maximum number allowed, or was less than the minimum number required by the function.
1005	A parameter passed on a function call, required to be a string variable, was of a different variable type.
1006	A literal string was passed on a function call for a parameter which was required to be an output parameter.
4000	A parameter contains an invalid whole number value.
4001	A parameter contains an invalid number value.
4002	The result of an arithmetic operation had an exponent that was outside the supported range of -999,999,999 to +999,999,999.

Examples

Example 1:

```
@DTW_MULTIPLY(NUM1, NUM2, result)
```

- Input: NUM1 = "4", NUM2 = "5"
- Returns: result = "20"

Example 2:

```
@DTW_rMULTIPLY("0.9", NUM2)
```

- Input: NUM2 = "0.8"
- Returns: "0.72"

DTW_POWER

AIX	HP-UX	Linux	OS/2	OS/390	OS/400	SCO	SUN	Win NT
X	X	X	X	X	X	X	X	X

Purpose

Raises a whole number to a whole number power.

Format

@DTW_POWER(number1, number2, precision, result)

@DTW_POWER(number1, number2, result)

@DTW_rPOWER(number1, number2, precision)

@DTW_rPOWER(number1, number2)

Parameters

Table 68. DTW_POWER Parameters

Data Type	Parameter	Use	Description
float	<i>number1</i>	IN	A variable or literal string representing a number that is to be raised to a power.
float	<i>number2</i>	IN	A variable or literal string representing a number.
integer	<i>precision</i>	IN	A variable or literal string representing a positive whole number that specifies the precision of the result. The default is 9.
float	<i>result</i>	OUT	A variable that contains the result of <i>number1</i> raised to the power of <i>number2</i> .

Return Codes

Table 69. DTW_POWER Return Codes

Return Code	Explanation
-1001	The server could not process a Net.Data request to allocate memory.
1001	An input parameter contained a NULL value.
1003	The number of parameters passed on a function call either exceeded the maximum number allowed, or was less than the minimum number required by the function.
1005	A parameter passed on a function call, required to be a string variable, was of a different variable type.
1006	A literal string was passed on a function call for a parameter which was required to be an output parameter.
4000	A parameter contains an invalid whole number value.
4001	A parameter contains an invalid number value.
4002	The result of an arithmetic operation had an exponent that was outside the supported range of -999,999,999 to +999,999,999.

Examples

Example 1:

```
@DTW_POWER(NUM1, NUM2, result)
```

- Input: NUM1 = "2", NUM2 = "-3"
- Returns: result = "0.125"

Example 2:

@DTW_rPOWER("1.7", NUM2, precision)

- Input: NUM2 = "8", precision = "5"
- Returns: "69.758"

DTW_SUBTRACT

AIX	HP-UX	Linux	OS/2	OS/390	OS/400	SCO	SUN	Win NT
X	X	X	X	X	X	X	X	X

Purpose

Subtracts one number from the other number.

Format

@DTW_SUBTRACT(number1, number2, precision, result)

@DTW_SUBTRACT(number1, number2, result)

@DTW_rSUBTRACT(number1, number2, precision)

@DTW_rSUBTRACT(number1, number2)

Parameters

Table 70. DTW_SUBTRACT Parameters

Data Type	Parameter	Use	Description
float	<i>number1</i>	IN	A variable or literal string representing a number from which another number is to be subtracted.
float	<i>number2</i>	IN	A variable or literal string representing a number.
integer	<i>precision</i>	IN	A variable or literal string representing a positive whole number that specifies the precision of the result. The default is 9.
float	<i>result</i>	OUT	A variable that contains the difference of <i>number1</i> and <i>number2</i> .

Return Codes

Table 71. DTW_SUBTRACT Return Codes

Return Code	Explanation
-1001	The server could not process a Net.Data request to allocate memory.
1001	An input parameter contained a NULL value.
1002	An input parameter contained a string value which consisted of the null-terminating character.
1003	The number of parameters passed on a function call either exceeded the maximum number allowed, or was less than the minimum number required by the function.
1005	A parameter passed on a function call, required to be a string variable, was of a different variable type.
1006	A literal string was passed on a function call for a parameter which was required to be an output parameter.
4000	A parameter contains an invalid whole number value.
4001	A parameter contains an invalid number value.
4002	The result of an arithmetic operation had an exponent that was outside the supported range of -999,999,999 to +999,999,999.

Examples

Example 1:

```
@DTW_SUBTRACT(NUM1, NUM2, comp)
%IF(comp > "0")
<P>$(NUM1) is larger than $(NUM2).
%ENDIF
```

- Input: NUM2 = "2.07"
- Returns: "-0.77"

This example shows a way to compare numeric values, which are strings in Net.Data.

Example 2:

```
@DTW_SUBTRACT(NUM1, NUM2, result)
• Input: NUM1 = "1.3, NUM2 = "1.07"
• Returns: result = "0.23"
```

Example 3:

```
@DTW_rSUBTRACT("1.3", NUM2)
• Input: NUM2 = "2.07"
• Returns: "-0.77"
```

String Functions

The following functions are the set of standard string functions that Net.Data supports:

- “DTW_ASSIGN” on page 169
- “DTW_CHARTOHEX” on page 170
- “DTW_CONCAT” on page 171
- “DTW_DELSTR” on page 172
- “DTW_HEXTOCHAR” on page 174
- “DTW_INSERT” on page 175
- “DTW_LASTPOS” on page 177
- “DTW_LENGTH” on page 179
- “DTW_LOWERCASE” on page 180
- “DTW_POS” on page 182
- “DTW_REPLACE” on page 184
- “DTW_REVERSE” on page 186
- “DTW_STRIP” on page 187
- “DTW_SUBSTR” on page 189
- “DTW_TRANSLATE” on page 191
- “DTW_UPPERCASE” on page 193

MBCS support for OS/390, OS/2, Windows NT, and UNIX: You can specify multiple-byte character set (MBCS) support for word and string functions with the DTW_MBMODE configuration value. Specify this value in the Net.Data initialization file; the default is no support. You can override the value in the initialization file by setting the DTW_MBMODE variable in a Net.Data macro. See the configuration variable section in *Net.Data Administration and Programming Guide* and “DTW_MBMODE” on page 109 for more information.

MBCS support for OS/400: DBCS support is provided automatically and does not require this variable.

DTW_ASSIGN

AIX	HP-UX	Linux	OS/2	OS/390	OS/400	SCO	SUN	Win NT
X	X	X	X	X	X	X	X	X

Purpose

Assigns a value to a variable.

Format

```
@DTW_ASSIGN(stringOut, stringIn)
```

Parameters

Table 72. DTW_ASSIGN Parameters

Data Type	Parameter	Use	Description
string	<i>stringOut</i>	OUT	A variable that contains the literal string identical to <i>stringIn</i> .
string	<i>stringIn</i>	IN	A variable or literal string.

Return Codes

Table 73. DTW_ASSIGN Return Codes

Return Code	Explanation
-1001	The server could not process a Net.Data request to allocate memory.
1003	The number of parameters passed on a function call either exceeded the maximum number allowed, or was less than the minimum number required by the function.
1005	A parameter passed on a function call, required to be a string variable, was of a different variable type.
1006	A literal string was passed on a function call for a parameter which was required to be an output parameter.

Examples

Example 1:

```
@DTW_ASSIGN(RC, "0")
```

- Sets RC to "0".

Example 2:

```
@DTW_ASSIGN(string1, string2)
```

- Sets *string1* to the value of *string2*.

DTW_CHARTOHEX

AIX	HP-UX	Linux	OS/2	OS/390	OS/400	SCO	SUN	Win NT
				X	X			

Purpose

Converts each character in a string to two hexadecimal characters.

Format

@DTW_CHARTOHEX(stringIn, stringOut)

@DTW_rCHARTOHEX(stringIn)

Parameters

Table 74. DTW_CHARTOHEX Parameters

Data Type	Parameter	Use	Description
string	<i>stringIn</i>	IN	A variable or literal string that is to be converted.
string	<i>stringOut</i>	OUT	A variable that contains <i>stringIn</i> represented in hexadecimal format.

Return Codes

Table 75. DTW_CHARTOHEX Return Codes

Return Code	Explanation
-1001	The server could not process a Net.Data request to allocate memory.
1003	The number of parameters passed on a function call either exceeded the maximum number allowed, or was less than the minimum number required by the function.
1005	A parameter passed on a function call, required to be a string variable, was of a different variable type.
1006	A literal string was passed on a function call for a parameter which was required to be an output parameter.

Usage Notes

Each hexadecimal character represents 4-bits of the input character (a character is represented by 8 bits).

Examples

Example 1: EBCDIC operating systems

```
@DTW_rCHARTOHEX("12345")
• Returns: "F1F2F3F4F5"
```

Example 2: ASCII operating systems

```
@DTW_rCHARTOHEX("12345")
• Returns: "C1C2C3C4C5"
```

DTW_CONCAT

AIX	HP-UX	Linux	OS/2	OS/390	OS/400	SCO	SUN	Win NT
X	X	X	X	X	X	X	X	X

Purpose

Concatenates two strings.

Format

@DTW_CONCAT(stringIn1, stringIn2, stringOut)

@DTW_rCONCAT(stringIn1, stringIn2)

Parameters

Table 76. DTW_CONCAT Parameters

Data Type	Parameter	Use	Description
string	<i>stringIn1</i>	IN	A variable or literal string.
string	<i>stringIn2</i>	IN	A variable or literal string.
string	<i>stringOut</i>	OUT	A variable that contains the string ' <i>stringIn1stringIn2</i> ', where <i>string1</i> is concatenated with <i>string2</i> .

Return Codes

Table 77. DTW_CONCAT Return Codes

Return Code	Explanation
-1001	The server could not process a Net.Data request to allocate memory.
1003	The number of parameters passed on a function call either exceeded the maximum number allowed, or was less than the minimum number required by the function.
1005	A parameter passed on a function call, required to be a string variable, was of a different variable type.
1006	A literal string was passed on a function call for a parameter which was required to be an output parameter.

Examples

Example 1:

```
@DTW_CONCAT("This", " is a test.", result)
```

- Returns: result = "This is a test."

Example 2:

```
@DTW_CONCAT(string1, "1-2-3", result)
```

- Input: string1 = "Testing "
- Returns: result = "Testing 1-2-3"

Example 3:

```
@DTW_rCONCAT("This", " is a test.")
```

- Returns: "This is a test."

DTW_DELSTR

AIX	HP-UX	Linux	OS/2	OS/390	OS/400	SCO	SUN	Win NT
X	X	X	X	X	X	X	X	X

Purpose

Deletes a substring of a string from the *n*th character for *length* characters.

Format

@DTW_DELSTR(stringIn, n, length, stringOut)

@DTW_DELSTR(stringIn, n, stringOut)

@DTW_rDELSTR(stringIn, n, length)

@DTW_rDELSTR(stringIn, n)

Parameters

Table 78. DTW_DELSTR Parameters

Data Type	Parameter	Use	Description
string	<i>stringIn</i>	IN	A variable or literal string.
integer	<i>n</i>	IN	The position of the character at which the substring to delete begins. If <i>n</i> is greater than the length of <i>stringIn</i> , <i>stringOut</i> is set to the value of <i>stringIn</i> .
integer	<i>length</i>	IN	The length of the substring to delete. The default is to delete all characters to the end of <i>stringIn</i> .
string	<i>stringOut</i>	OUT	A variable that contains the modified form of <i>stringIn</i> .

Return Codes

Table 79. DTW_DELSTR Return Codes

Return Code	Explanation
-1001	The server could not process a Net.Data request to allocate memory.
1001	An input parameter contained a NULL value.
1002	An input parameter contained a string value which consisted of the null-terminating character.
1003	The number of parameters passed on a function call either exceeded the maximum number allowed, or was less than the minimum number required by the function.
1005	A parameter passed on a function call, required to be a string variable, was of a different variable type.
1006	A literal string was passed on a function call for a parameter which was required to be an output parameter.
1007	A parameter contains a value which is not valid.

Examples

Example 1:

```
@DTW_DELSTR("abcde", "3", "2", result)
```

- Returns: result = "abe"

Example 2:

```
@DTW_rDELSTR("abcde", "4", "1")
```

- Returns: "abce"

DTW_HEXTOCHAR

AIX	HP-UX	Linux	OS/2	OS/390	OS/400	SCO	SUN	Win NT
				X	X			

Purpose

Converts each hexadecimal character in a string to a character value.

Format

@DTW_HEXTOCHAR(stringIn, stringOut)

@DTW_rHEXTOCHAR(stringIn)

Parameters

Table 80. DTW_HEXTOCHAR Parameters

Data Type	Parameter	Use	Description
string	<i>stringIn</i>	IN	A variable or literal string that is to be converted.
string	<i>stringOut</i>	OUT	A variable that contains <i>stringIn</i> represented in character format.

Return Codes

Table 81. DTW_HEXTOCHAR Return Codes

Return Code	Explanation
-1001	The server could not process a Net.Data request to allocate memory.
1003	The number of parameters passed on a function call either exceeded the maximum number allowed, or was less than the minimum number required by the function.
1005	A parameter passed on a function call, required to be a string variable, was of a different variable type.
1006	A literal string was passed on a function call for a parameter which was required to be an output parameter.
1007	A parameter contains a value which is not valid.

Usage Notes

Each hexadecimal character in the input string represents 4 bits in the resultant character string (a character is represented by 8 bits). The input string must contain an even number of hexadecimal characters and can contain the following characters: 0-9, A-F, and a-f.

Examples

Example 1: EBCDIC operating systems

```
@DTW_rHEXTOCHAR("F1F2F3")
```

- Returns: "123"

Example 2: ASCII operating systems

```
@DTW_rHEXTOCHAR("303132")
```

- Returns: "123"

DTW_INSERT

AIX	HP-UX	Linux	OS/2	OS/390	OS/400	SCO	SUN	Win NT
X	X	X	X	X	X	X	X	X

Purpose

Inserts a string into another string starting after the *n*th character.

Format

@DTW_INSERT(stringIn1, stringIn2, n, length, pad, stringOut)

@DTW_INSERT(stringIn1, stringIn2, n, length, stringOut)

@DTW_INSERT(stringIn1, stringIn2, n, stringOut)

@DTW_INSERT(stringIn1, stringIn2, stringOut)

@DTW_rINSERT(stringIn1, stringIn2, n, length, pad)

@DTW_rINSERT(stringIn1, stringIn2, n, length)

@DTW_rINSERT(stringIn1, stringIn2, n)

@DTW_rINSERT(stringIn1, stringIn2)

Parameters

Table 82. DTW_INSERT Parameters

Data Type	Parameter	Use	Description
string	<i>stringIn1</i>	IN	A variable or literal string to be inserted into <i>stringIn2</i> .
string	<i>stringIn2</i>	IN	A variable or literal string.
integer	<i>n</i>	IN	The character position in <i>stringIn2</i> after which <i>stringIn1</i> is inserted. If <i>n</i> is greater than the length of <i>stringIn2</i> , it is padded with the padding character, <i>pad</i> , until it has enough characters. The default is to insert at the beginning of <i>stringIn2</i> .
integer	<i>length</i>	IN	The number of characters of <i>stringIn1</i> to insert. The string is padded with the padding character, <i>pad</i> , if this parameter is greater than the length of <i>stringIn1</i> . The default is the length of <i>stringIn1</i> .
integer	<i>pad</i>	IN	The padding character, as described for <i>n</i> and <i>length</i> . The default pad character is a blank.
string	<i>stringOut</i>	OUT	A variable that contains <i>stringIn2</i> modified by inserting part or all of <i>stringIn1</i> .

Return Codes

Table 83. DTW_INSERT Return Codes

Return Code	Explanation
-1001	The server could not process a Net.Data request to allocate memory.
1001	An input parameter contained a NULL value.

Table 83. DTW_INSERT Return Codes (continued)

Return Code	Explanation
1003	The number of parameters passed on a function call either exceeded the maximum number allowed, or was less than the minimum number required by the function.
1005	A parameter passed on a function call, required to be a string variable, was of a different variable type.
1006	A literal string was passed on a function call for a parameter which was required to be an output parameter.
1007	A parameter contains a value which is not valid.

Examples

Example 1:

```
@DTW_INSERT("123", "abc", result)
```

- Returns: result = "123abc"

Example 2:

```
@DTW_INSERT("123", "abc", "5", result)
```

- Returns: result = "abc 123"

Example 3:

```
@DTW_INSERT("123", "abc", "5", "6", result)
```

- Returns: result = "abc 123 "

Example 4:

```
@DTW_INSERT("123", "abc", "5", "6", "/", result)
```

- Returns: result = "abc//123///"

Example 5:

```
@DTW_INSERT("123", "abc", "5", "6", "+")
```

- Returns: "abc++123++"

DTW_LASTPOS

AIX	HP-UX	Linux	OS/2	OS/390	OS/400	SCO	SUN	Win NT
X	X	X	X	X	X	X	X	X

Purpose

Returns the position of the last occurrence of a string in another string, starting from the *n*th character and working backwards (right to left).

Format

@DTW_LASTPOS(stringIn1, stringIn2, n, position)

@DTW_LASTPOS(stringIn1, stringIn2, position)

@DTW_rLASTPOS(stringIn1, stringIn2, n)

@DTW_rLASTPOS(stringIn1, stringIn2)

Parameters

Table 84. DTW_LASTPOS Parameters

Data Type	Parameter	Use	Description
string	<i>stringIn1</i>	IN	A variable or literal string searched for in <i>stringIn2</i> .
string	<i>stringIn2</i>	IN	A variable or literal string.
integer	<i>n</i>	IN	The character position in <i>stringIn2</i> to begin searching for <i>stringIn1</i> . The default is to start searching at the last character and scan backwards (from right to left).
integer	<i>position</i>	OUT	The position of the last occurrence of <i>stringIn1</i> in <i>stringIn2</i> . If no occurrence is found, 0 is returned.

Return Codes

Table 85. DTW_LASTPOS Return Codes

Return Code	Explanation
-1001	The server could not process a Net.Data request to allocate memory.
1001	An input parameter contained a NULL value.
1003	The number of parameters passed on a function call either exceeded the maximum number allowed, or was less than the minimum number required by the function.
1005	A parameter passed on a function call, required to be a string variable, was of a different variable type.
1006	A literal string was passed on a function call for a parameter which was required to be an output parameter.
1007	A parameter contains a value which is not valid.

Examples

Example 1:

```
@DTW_LASTPOS(" ", "abc def ghi", result)
```

- Returns: result = "8"

Example 2:

```
@DTW_LASTPOS(" ", "abc def ghi", "10", result)
```

- Returns: result = "8"

Example 3:

```
@DTW_rLASTPOS(" ", "abc def ghi", "7")
```

- Returns: "4"

DTW_LENGTH

AIX	HP-UX	Linux	OS/2	OS/390	OS/400	SCO	SUN	Win NT
X	X	X	X	X	X	X	X	X

Purpose

Returns the length of a string.

Format

@DTW_LENGTH(stringIn, length)

@DTW_rLENGTH(stringIn)

Parameters

Table 86. DTW_LENGTH Parameters

Data Type	Parameter	Use	Description
string	<i>stringIn</i>	IN	A variable or literal string.
integer	<i>length</i>	OUT	A symbol containing the number of characters in <i>stringIn</i> .

Return Codes

Table 87. DTW_LENGTH Return Codes

Return Code	Explanation
-1001	The server could not process a Net.Data request to allocate memory.
1003	The number of parameters passed on a function call either exceeded the maximum number allowed, or was less than the minimum number required by the function.
1005	A parameter passed on a function call, required to be a string variable, was of a different variable type.
1006	A literal string was passed on a function call for a parameter which was required to be an output parameter.

Examples

Example 1:

```
@DTW_LENGTH("abcdefgh", result)
```

- Returns: result = "8"

Example 2:

```
@DTW_rLENGTH("")
```

- Returns: "0"

DTW_LOWERCASE

AIX	HP-UX	Linux	OS/2	OS/390	OS/400	SCO	SUN	Win NT
X	X	X	X	X	X	X	X	X

Purpose

Returns a string in all lowercase.

Format

@DTW_LOWERCASE(stringIn, stringOut)

@DTW_rLOWERCASE(stringIn)

@DTW_mLOWERCASE(stringMult1, stringMult2, ..., stringMultn)

Parameters

Table 88. DTW_LOWERCASE Parameters

Data Type	Parameter	Use	Description
string	<i>stringIn</i>	IN	A variable or literal string with characters of any case.
string	<i>stringOut</i>	OUT	A variable that contains <i>stringIn</i> with all characters in lowercase.
string	<i>stringMult</i>	INOUT	<ul style="list-style-type: none">On input: A variable that contains a string.On output: A variable that contains the input string converted to lowercase.

Return Codes

Table 89. DTW_LOWERCASE Return Codes

Return Code	Explanation
-1001	The server could not process a Net.Data request to allocate memory.
1003	The number of parameters passed on a function call either exceeded the maximum number allowed, or was less than the minimum number required by the function.
1005	A parameter passed on a function call, required to be a string variable, was of a different variable type.
1006	A literal string was passed on a function call for a parameter which was required to be an output parameter.

Examples

Example 1:

```
@DTW_LOWERCASE("This", stringOut)
```

- Returns: stringOut = "this"

Example 2:

```
@DTW_rLOWERCASE(string1)
```

- Input: string1 = "Hello"
- Returns: "hello"

Example 3:

@DTW_mLOWERCASE(string1, string2, string3)

- Input: string1 = "THIS", string2 = "IS", string3 = "LOWERCASE"
- Returns: string1 = "this", string2 = "is", string3 = "lowercase"

DTW_POS

AIX	HP-UX	Linux	OS/2	OS/390	OS/400	SCO	SUN	Win NT
X	X	X	X	X	X	X	X	X

Purpose

Returns the position of the first occurrence of a string in another string, using a forward search pattern.

Format

@DTW_POS(stringIn1, stringIn2, n, nOut)

@DTW_POS(stringIn1, stringIn2, nOut)

@DTW_rPOS(stringIn1, stringIn2, n)

@DTW_rPOS(stringIn1, stringIn2)

Parameters

Table 90. DTW_POS Parameters

Data Type	Parameter	Use	Description
string	<i>stringIn1</i>	IN	A variable or literal string to search for.
string	<i>stringIn2</i>	IN	A variable or literal string to search.
integer	<i>n</i>	IN	The character position in <i>stringIn2</i> to begin searching. The default value is to start searching at the first character of <i>stringIn2</i> .
integer	<i>nOut</i>	OUT	A variable that contains the position of the first occurrence of <i>stringIn1</i> in <i>stringIn2</i> . If no occurrence is found, 0 is returned.

Return Codes

Table 91. DTW_POS Return Codes

Return Code	Explanation
-1001	The server could not process a Net.Data request to allocate memory.
1001	An input parameter contained a NULL value.
1002	An input parameter contained a string value which consisted of the null-terminating character.
1003	The number of parameters passed on a function call either exceeded the maximum number allowed, or was less than the minimum number required by the function.
1005	A parameter passed on a function call, required to be a string variable, was of a different variable type.
1006	A literal string was passed on a function call for a parameter which was required to be an output parameter.
1007	A parameter contains a value which is not valid.

Examples

Example 1:

```
@DTW_POS("day", "Saturday", result)
```

- Returns: result = "6"

Example 2:

```
@DTW_POS("a", "Saturday", "3", result)
```

- Returns: result = "7"

Example 3:

```
@DTW_rPOS(" ", "abc def ghi", "5")
```

- Returns: "8"

DTW_REPLACE

AIX	HP-UX	Linux	OS/2	OS/390	OS/400	SCO	SUN	Win NT
				X	X			

Purpose

Replaces characters in a string.

Format

@DTW_REPLACE(stringIn, stringFrom, stringTo, n, option, stringOut)

@DTW_REPLACE(stringIn, stringFrom, stringTo, n, stringOut)

@DTW_REPLACE(stringIn, stringFrom, stringTo, stringOut)

@DTW_rREPLACE(stringIn, stringFrom, stringTo, n, option)

@DTW_rREPLACE(stringIn, stringFrom, stringTo, n)

@DTW_rREPLACE(stringIn, stringFrom, stringTo)

Parameters

Table 92. DTW_REPLACE Parameters

Data Type	Parameter	Use	Description
string	<i>stringIn</i>	IN	A variable or literal string that is to be searched.
string	<i>stringFrom</i>	IN	A variable or literal string that is to be replaced.
string	<i>stringTo</i>	IN	A variable or literal string that replaces occurrences of <i>stringFrom</i> .
integer	<i>n</i>	IN	The position of the character at which to begin the search.
string	<i>option</i>	IN	Specifies whether to replace all occurrences, or just the first occurrence, and can have one of the following values: A or a Replaces all occurrences. The default is A. F or f Replaces only the first occurrence.
string	<i>stringOut</i>	OUT	A variable that contains <i>stringIn</i> with occurrences of <i>stringFrom</i> replaced by <i>stringTo</i> .

Return Codes

Table 93. DTW_REPLACE Return Codes

Return Code	Explanation
-1001	The server could not process a Net.Data request to allocate memory.
1003	The number of parameters passed on a function call either exceeded the maximum number allowed, or was less than the minimum number required by the function.
1005	A parameter passed on a function call, required to be a string variable, was of a different variable type.

Table 93. DTW_REPLACE Return Codes (continued)

Return Code	Explanation
1006	A literal string was passed on a function call for a parameter which was required to be an output parameter.

Examples

Example 1:

```
@DTW_REPLACE("ABCABCABC", "AB", "1234")
```

- Returns: "1234C1234C1234C"

DTW_REVERSE

AIX	HP-UX	Linux	OS/2	OS/390	OS/400	SCO	SUN	Win NT
X	X	X	X	X	X	X	X	X

Purpose

Reverses a string so that the last character is first, second to last is second, until the entire string is reversed.

Format

@DTW_REVERSE(stringIn, stringOut)

@DTW_rREVERSE(stringIn)

Parameters

Table 94. DTW_REVERSE Parameters

Data Type	Parameter	Use	Description
string	<i>stringIn</i>	IN	A variable or literal string to reverse.
string	<i>stringOut</i>	OUT	A variable that contains the reversed form of <i>stringIn</i> .

Return Codes

Table 95. DTW_REVERSE Return Codes

Return Code	Explanation
-1001	The server could not process a Net.Data request to allocate memory.
1003	The number of parameters passed on a function call either exceeded the maximum number allowed, or was less than the minimum number required by the function.
1005	A parameter passed on a function call, required to be a string variable, was of a different variable type.
1006	A literal string was passed on a function call for a parameter which was required to be an output parameter.

Examples

Example 1:

```
@DTW_REVERSE("This is it.", result)
```

- Returns: result = ".ti si sihT"

Example 2:

```
@DTW_rREVERSE(string1)
```

- Input: string1 = "reversed"
- Returns: "desrever"

DTW_STRIP

AIX	HP-UX	Linux	OS/2	OS/390	OS/400	SCO	SUN	Win NT
X	X	X	X	X	X	X	X	X

Purpose

Removes leading blanks, trailing blanks, or both from a string.

Format

@DTW_STRIP(stringIn, option, stringOut)

@DTW_STRIP(stringIn, stringOut)

@DTW_rSTRIP(stringIn, option)

@DTW_rSTRIP(stringIn)

Parameters

Table 96. DTW_STRIP Parameters

Data Type	Parameter	Use	Description
string	<i>stringIn</i>	IN	A variable or literal string.
string	<i>option</i>	IN	Specifies which blanks to remove from <i>stringIn</i> . The default is B. B or b - remove both leading and trailing blanks L or l - remove leading blanks only T or t - remove trailing blanks only
string	<i>stringOut</i>	OUT	A variable that contains <i>stringIn</i> with blanks removed as specified by option.

Return Codes

Table 97. DTW_STRIP Return Codes

Return Code	Explanation
-1001	The server could not process a Net.Data request to allocate memory.
1001	An input parameter contained a NULL value.
1003	The number of parameters passed on a function call either exceeded the maximum number allowed, or was less than the minimum number required by the function.
1005	A parameter passed on a function call, required to be a string variable, was of a different variable type.
1006	A literal string was passed on a function call for a parameter which was required to be an output parameter.
1007	A parameter contains a value which is not valid.

Examples

Example 1:

```
@DTW_STRIP(" day ", result)
```

- Returns: result = "day"

Example 2:

```
@DTW_STRIP(" day ", "T", result)
• Returns: result = " day"
```

Example 3:

```
@DTW_rSTRIP(" a day ", "L")
• Returns: "a day "
```

DTW_SUBSTR

AIX	HP-UX	Linux	OS/2	OS/390	OS/400	SCO	SUN	Win NT
X	X	X	X	X	X	X	X	X

Purpose

Returns a substring of a string, with optional pad characters.

Format

@DTW_SUBSTR(stringIn, n, length, pad, stringOut)

@DTW_SUBSTR(stringIn, n, length, stringOut)

@DTW_SUBSTR(stringIn, n, stringOut)

@DTW_rSUBSTR(stringIn, n, length, pad)

@DTW_rSUBSTR(stringIn, n, length)

@DTW_rSUBSTR(stringIn, n)

Parameters

Table 98. DTW_SUBSTR Parameters

Data Type	Parameter	Use	Description
string	<i>stringIn</i>	IN	A variable or literal string to be searched.
integer	<i>n</i>	IN	The first character position of the substring. The default is to start at the beginning of <i>stringIn</i> .
integer	<i>length</i>	IN	The number of characters of the substring. The default is the rest of the string.
string	<i>pad</i>	IN	The padding character used if <i>n</i> is greater than the length of <i>stringIn</i> or if <i>length</i> is longer than <i>stringIn</i> . The default is a blank.
string	<i>stringOut</i>	OUT	A variable that contains a substring of <i>stringIn</i> .

Return Codes

Table 99. DTW_SUBSTR Return Codes

Return Code	Explanation
-1001	The server could not process a Net.Data request to allocate memory.
1001	An input parameter contained a NULL value.
1003	The number of parameters passed on a function call either exceeded the maximum number allowed, or was less than the minimum number required by the function.
1005	A parameter passed on a function call, required to be a string variable, was of a different variable type.
1006	A literal string was passed on a function call for a parameter which was required to be an output parameter.
1007	A parameter contains a value which is not valid.

Examples

Example 1:

```
@DTW_SUBSTR("abc", "2", result)
```

- Returns: result = "bc"

Example 2:

```
@DTW_SUBSTR("abc", "2", "4", result)
```

- Returns: result = "bc "

Example 3:

```
@DTW_SUBSTR("abc", "2", "4", ".", result )
```

- Returns: result = "bc.."

Example 4:

```
@DTW_rSUBSTR("abc", "2", "6", ".")
```

- Returns: "bc...."

DTW_TRANSLATE

AIX	HP-UX	Linux	OS/2	OS/390	OS/400	SCO	SUN	Win NT
X	X	X	X	X	X	X	X	X

Purpose

Returns a string with each character translated to another character or unchanged.

Format

@DTW_TRANSLATE(stringIn, tableO, tableI, default, stringOut)

@DTW_TRANSLATE(stringIn, tableO, tableI, stringOut)

@DTW_TRANSLATE(stringIn, tableO, stringOut)

@DTW_TRANSLATE(stringIn, stringOut)

@DTW_rTRANSLATE(stringIn, tableO, tableI, default)

@DTW_rTRANSLATE(stringIn, tableO, tableI)

@DTW_rTRANSLATE(stringIn, tableO)

@DTW_rTRANSLATE(stringIn)

Parameters

Table 100. DTW_TRANSLATE Parameters

Data Type	Parameter	Use	Description
string	<i>stringIn</i>	IN	A variable or literal string.
string	<i>tableO</i>	IN	A variable or literal string used as a translation table. Use null ("") to specify <i>tableI</i> or <i>default</i> ; otherwise this parameter is optional.
string	<i>tableI</i>	IN	A variable or literal string searched for in <i>stringIn</i> . Use null ("") to specify <i>default</i> ; otherwise this parameter is optional.
string	<i>default</i>	IN	The default character to use. The default is a blank.
string	<i>stringOut</i>	OUT	A variable that contains the translated result of <i>stringIn</i> .

Return Codes

Table 101. DTW_TRANSLATE Return Codes

Return Code	Explanation
-1001	The server could not process a Net.Data request to allocate memory.
1001	An input parameter contained a NULL value.
1003	The number of parameters passed on a function call either exceeded the maximum number allowed, or was less than the minimum number required by the function.
1005	A parameter passed on a function call, required to be a string variable, was of a different variable type.
1006	A literal string was passed on a function call for a parameter which was required to be an output parameter.
1007	A parameter contains a value which is not valid.

Usage Notes

1. If *tableI*, *tableO*, and the *default* character are not in the parameter list, the *stringIn* parameter is translated to uppercase.
2. If *tableI* and *tableO* are in the list, each character in the input string is searched for in *tableI* and translated to the corresponding character in *tableO*. If a character in *tableI* has no corresponding character in *tableO*, the *default* character is used instead.

Examples

Example 1:

```
@DTW_TRANSLATE("abbc", result)
```

- Returns: result = "ABBC"

Example 2:

```
@DTW_TRANSLATE("abbc", "R", "bc", result)
```

- Returns: result = "aRR "

Example 3:

```
@DTW_rTRANSLATE("abcdef", "12", "abcd", ".")
```

- Returns: "12..ef"

Example 4:

```
@DTW_rTRANSLATE("abbc", "", "", "")
```

- Returns: "abbc"

DTW_UPPERCASE

AIX	HP-UX	Linux	OS/2	OS/390	OS/400	SCO	SUN	Win NT
X	X	X	X	X	X	X	X	X

Purpose

Returns a string in uppercase.

Format

@DTW_UPPERCASE(stringIn, stringOut)

@DTW_rUPPERCASE(stringIn)

@DTW_mUPPERCASE(stringMult1, stringMult2, ..., stringMultn)

Parameters

Table 102. DTW_UPPERCASE Parameters

Data Type	Parameter	Use	Description
string	<i>stringIn</i>	IN	A variable or literal string with characters of any case.
string	<i>stringOut</i>	OUT	A variable that contains <i>stringIn</i> with all characters in uppercase.
string	<i>stringMult</i>	INOUT	<ul style="list-style-type: none">On input: A variable that contains a string.On output: A variable that contains the input string converted to uppercase.

Return Codes

Table 103. DTW_UPPERCASE Return Codes

Return Code	Explanation
-1001	The server could not process a Net.Data request to allocate memory.
1003	The number of parameters passed on a function call either exceeded the maximum number allowed, or was less than the minimum number required by the function.
1005	A parameter passed on a function call, required to be a string variable, was of a different variable type.
1006	A literal string was passed on a function call for a parameter which was required to be an output parameter.

Examples

Example 1:

```
@DTW_UPPERCASE("Test", result)
```

- Returns: result = "TEST"

Example 2:

```
@DTW_rUPPERCASE(string1)
```

- Input: string1 = "Web pages"
- Returns: "WEB PAGES"

Example 3:

@DTW_mUPPERCASE(string1, string2, string3)

- Input: string1 = "This", string2 = "is", string3 = "uppercase"
- Returns: string1 = "THIS", string2 = "IS", string3 = "UPPERCASE"

Word Functions

These functions supplement the string functions by modifying words or sets of words. Net.Data interprets a word as a space-delimited string, or a string with spaces on both sides. Here are some examples:

String value	Number of words
one two three	3
one , two , three	5
Part 2: Internet Sales Grow	5

MBCS support for OS/390, OS/2, Windows NT, and UNIX: You can specify multiple-byte character set (MBCS) support for word and string functions with the DTW_MBMODE configuration value. Specify this value in the Net.Data initialization file; the default is no support. You can override the value in the initialization file by setting the DTW_MBMODE variable in a Net.Data macro. See the configuration variable section in *Net.Data Administration and Programming Guide* and “DTW_MBMODE” on page 109 for more information.

MBCS support for OS/400: DBCS support is provided automatically and does not require this variable.

The following functions are word functions that Net.Data supports:

- “DTW_DELWORD” on page 196
- “DTW_SUBWORD” on page 198
- “DTW_WORD” on page 200
- “DTW_WORDINDEX” on page 201
- “DTW_WORDLENGTH” on page 202
- “DTW_WORDPOS” on page 203
- “DTW_WORDS” on page 205

DTW_DELWORD

AIX	HP-UX	Linux	OS/2	OS/390	OS/400	SCO	SUN	Win NT
X	X	X	X	X	X	X	X	X

Purpose

Deletes words in a string, starting from word *n* for the number of words specified by *length*.

Format

@DTW_DELWORD(stringIn, n, length, stringOut)

@DTW_DELWORD(stringIn, n, stringOut)

@DTW_rDELWORD(stringIn, n, length)

@DTW_rDELWORD(stringIn, n)

Parameters

Table 104. DTW_DELWORD Parameters

Data Type	Parameter	Use	Description
string	<i>stringIn</i>	IN	A variable or literal string.
integer	<i>n</i>	IN	The word position of the first word to be deleted.
integer	<i>length</i>	IN	The number of words to delete. The default is to delete all words from <i>n</i> to the end of <i>stringIn</i> . Optional parameter.
string	<i>stringOut</i>	OUT	A variable that contains the modified form of <i>stringIn</i> .

Return Codes

Table 105. DTW_DELWORD Return Codes

Return Code	Explanation
-1001	The server could not process a Net.Data request to allocate memory.
1001	An input parameter contained a NULL value.
1003	The number of parameters passed on a function call either exceeded the maximum number allowed, or was less than the minimum number required by the function.
1005	A parameter passed on a function call, required to be a string variable, was of a different variable type.
1006	A literal string was passed on a function call for a parameter which was required to be an output parameter.
1007	A parameter contains a value which is not valid.

Examples

Example 1

```
@DTW_DELWORD("Now is the time", "5", result)
```

- Returns: result = "Now is the time"

Example 2:

```
@DTW_DELWORD("Now is the time", "2", result)
```

- Returns: result = "Now"

Example 3:

```
@DTW_DELWORD("Now is the time", "2", "2", result)
```

- Returns: result = "Now time"

Example 4:

```
@DTW_rDELWORD("Now is the time.", "3")
```

- Returns: "Now is"

DTW_SUBWORD

AIX	HP-UX	Linux	OS/2	OS/390	OS/400	SCO	SUN	Win NT
X	X	X	X	X	X	X	X	X

Purpose

Returns a substring of a string, beginning at word *n* s for the number of words specified by *length*.

Format

@DTW_SUBWORD(stringIn, n, length, stringOut)

@DTW_SUBWORD(stringIn, n, stringOut)

@DTW_rSUBWORD(stringIn, n, length)

@DTW_rSUBWORD(stringIn, n)

Parameters

Table 106. DTW_SUBWORD Parameters

Data Type	Parameter	Use	Description
string	<i>stringIn</i>	IN	A variable or literal string.
integer	<i>n</i>	IN	The word position of the first word of the substring. A null is returned if this value is greater than the number of words in <i>stringIn</i> .
integer	<i>length</i>	IN	The number of words in the substring. If this value is greater than the number of words from <i>n</i> to the end of <i>stringIn</i> , all words to the end of <i>stringIn</i> are returned. The default is to return all words from <i>n</i> to the end of <i>stringIn</i> .
string	<i>stringOut</i>	OUT	A variable that contains a substring of <i>stringIn</i> specified by <i>n</i> and <i>length</i> .

Return Codes

Table 107. DTW_SUBWORD Return Codes

Return Code	Explanation
-1001	The server could not process a Net.Data request to allocate memory.
1001	An input parameter contained a NULL value.
1003	The number of parameters passed on a function call either exceeded the maximum number allowed, or was less than the minimum number required by the function.
1005	A parameter passed on a function call, required to be a string variable, was of a different variable type.
1006	A literal string was passed on a function call for a parameter which was required to be an output parameter.
1007	A parameter contains a value which is not valid.

Examples

Example 1:

```
@DTW_SUBWORD("Now is the time", "5", result)
```

- Returns: result = ""

Example 2:

```
@DTW_SUBWORD("Now is the time", "2", result)
```

- Returns: result = "is the time"

Example 3:

```
@DTW_SUBWORD("Now is the time", "2", "2", result)
```

- Returns: result = "is the"

Example 4:

```
@DTW_rSUBWORD("Now is the time", "3")
```

- Returns: "the time"

DTW_WORD

AIX	HP-UX	Linux	OS/2	OS/390	OS/400	SCO	SUN	Win NT
X	X	X	X	X	X	X	X	X

Purpose

Returns the *n*th word in a string.

Format

@DTW_WORD(stringIn, n, stringOut)

@DTW_rWORD(stringIn, n)

Parameters

Table 108. DTW_WORD Parameters

Data Type	Parameter	Use	Description
string	<i>stringIn</i>	IN	A variable or literal string.
integer	<i>n</i>	IN	The word position of the word to return. If this value is greater than the number of words in <i>stringIn</i> , a null is returned.
string	<i>stringOut</i>	OUT	A variable that contains the word at word position <i>n</i> .

Return Codes

Table 109. DTW_WORD Return Codes

Return Code	Explanation
-1001	The server could not process a Net.Data request to allocate memory.
1001	An input parameter contained a NULL value.
1003	The number of parameters passed on a function call either exceeded the maximum number allowed, or was less than the minimum number required by the function.
1005	A parameter passed on a function call, required to be a string variable, was of a different variable type.
1006	A literal string was passed on a function call for a parameter which was required to be an output parameter.
1007	A parameter contains a value which is not valid.

Examples

Example 1:

```
@DTW_WORD("Now is the time", "3", result)
```

- Returns: result = "the"

Example 2:

```
@DTW_WORD("Now is the time", "5", result)
```

- Returns: result = ""

Example 3:

```
@DTW_rWORD("Now is the time", "4")
```

- Returns: "time"

DTW_WORDINDEX

AIX	HP-UX	Linux	OS/2	OS/390	OS/400	SCO	SUN	Win NT
X	X	X	X	X	X	X	X	X

Purpose

Returns the character position of the first character in the *n*th word of a string.

Format

@DTW_WORDINDEX(stringIn, n, stringOut)

@DTW_rWORDINDEX(stringIn, n)

Parameters

Table 110. DTW_WORDINDEX Parameters

Data Type	Parameter	Use	Description
string	<i>stringIn</i>	IN	A variable or literal string.
integer	<i>n</i>	IN	The word position of the word to index. If this value is greater than the number of words in the input string, 0 is returned.
string	<i>stringOut</i>	OUT	A variable that contains the character position of the <i>n</i> th word of <i>stringIn</i> .

Return Codes

Table 111. DTW_WORDINDEX Return Codes

Return Code	Explanation
-1001	The server could not process a Net.Data request to allocate memory.
1001	An input parameter contained a NULL value.
1003	The number of parameters passed on a function call either exceeded the maximum number allowed, or was less than the minimum number required by the function.
1005	A parameter passed on a function call, required to be a string variable, was of a different variable type.
1006	A literal string was passed on a function call for a parameter which was required to be an output parameter.
1007	A parameter contains a value which is not valid.

Examples

Example 1:

```
@DTW_WORDINDEX("Now is the time", "3", result)
```

- Returns: result = "8"

Example 2:

```
@DTW_WORDINDEX("Now is the time", "6", result)
```

- Returns: result = "0"

Example 3:

```
@DTW_rWORDINDEX("Now is the time", "2")
```

- Returns: "5"

DTW_WORDLENGTH

AIX	HP-UX	Linux	OS/2	OS/390	OS/400	SCO	SUN	Win NT
X	X	X	X	X	X	X	X	X

Purpose

Returns the length of the n th word of a string.

Format

@DTW_WORDLENGTH(stringIn, n, stringOut)

@DTW_rWORDLENGTH(stringIn, n)

Parameters

Table 112. DTW_WORDLENGTH Parameters

Data Type	Parameter	Use	Description
string	<i>stringIn</i>	IN	A variable or literal string.
integer	<i>n</i>	IN	The word position of the word whose length you want to know. If this value is greater than the number of words in the input string, 0 is returned.
string	<i>stringOut</i>	OUT	A variable that contains the length of the n th word in <i>stringIn</i> .

Return Codes

Table 113. DTW_WORDLENGTH Return Codes

Return Code	Explanation
-1001	The server could not process a Net.Data request to allocate memory.
1001	An input parameter contained a NULL value.
1003	The number of parameters passed on a function call either exceeded the maximum number allowed, or was less than the minimum number required by the function.
1005	A parameter passed on a function call, required to be a string variable, was of a different variable type.
1006	A literal string was passed on a function call for a parameter which was required to be an output parameter.
1007	A parameter contains a value which is not valid.

Examples

Example 1:

```
@DTW_WORDLENGTH("Now is the time", "1", result)
```

- Returns: result = "3"

Example 2:

```
@DTW_rWORDLENGTH("Now is the time", "6")
```

- Returns: "0"

DTW_WORDPOS

AIX	HP-UX	Linux	OS/2	OS/390	OS/400	SCO	SUN	Win NT
X	X	X	X	X	X	X	X	X

Purpose

Returns the word number of the first occurrence of one string within another.

Format

@DTW_WORDPOS(stringIn1, stringIn2, n, stringOut)

@DTW_WORDPOS(stringIn1, stringIn2, stringOut)

@DTW_rWORDPOS(stringIn1, stringIn2, n)

@DTW_rWORDPOS(stringIn1, stringIn2)

Parameters

Table 114. DTW_WORDPOS Parameters

Data Type	Parameter	Use	Description
string	<i>stringIn1</i>	IN	A variable or literal string.
string	<i>stringIn2</i>	IN	A variable or literal string to search.
integer	<i>n</i>	IN	The word position in <i>stringIn2</i> to begin searching. If this value is larger than the number of words in <i>stringIn2</i> , 0 is returned. The default is to search from the beginning of <i>stringIn2</i> .
string	<i>stringOut</i>	OUT	The word position of <i>stringIn1</i> in <i>stringIn2</i> .

Return Codes

Table 115. DTW_WORDPOS Return Codes

Return Code	Explanation
-1001	The server could not process a Net.Data request to allocate memory.
1001	An input parameter contained a NULL value.
1003	The number of parameters passed on a function call either exceeded the maximum number allowed, or was less than the minimum number required by the function.
1005	A parameter passed on a function call, required to be a string variable, was of a different variable type.
1006	A literal string was passed on a function call for a parameter which was required to be an output parameter.
1007	A parameter contains a value which is not valid.

Usage Notes

Multiple blanks are treated as single blanks for comparison.

Examples

Example 1:

```
@DTW_WORDPOS("the", "Now is the time", result)
```

- Returns: result = "3"

Example 2:

```
@DTW_WORDPOS("The", "Now is the time", result)
```

- Returns: result = "0"

Example 3:

```
@DTW_WORDPOS("The", "Now is the time", "5", result)
```

- Returns: result = "0"

Example 4:

```
@DTW_WORDPOS("is the", "Now is the time", result)
```

- Returns: result = "2"

Example 5:

```
@DTW_rWORDPOS("be", "To be or not to be", "3")
```

- Returns: "6"

DTW_WORDS

AIX	HP-UX	Linux	OS/2	OS/390	OS/400	SCO	SUN	Win NT
X	X	X	X	X	X	X	X	X

Purpose

Returns the number of words in a string.

Format

@DTW_WORDS(stringIn, stringOut)

@DTW_rWORDS(stringIn)

Parameters

Table 116. DTW_WORDS Parameters

Data Type	Parameter	Use	Description
string	<i>stringIn</i>	IN	A variable or literal string.
string	<i>stringOut</i>	OUT	A variable that contains the number of words in <i>stringIn</i> .

Return Codes

Table 117. DTW_WORDS Return Codes

Return Code	Explanation
-1001	The server could not process a Net.Data request to allocate memory.
1003	The number of parameters passed on a function call either exceeded the maximum number allowed, or was less than the minimum number required by the function.
1005	A parameter passed on a function call, required to be a string variable, was of a different variable type.
1006	A literal string was passed on a function call for a parameter which was required to be an output parameter.

Examples

Example 1:

```
@DTW_WORDS("Now is the time", result)
```

- Returns:

```
result = "4"
```

Example 2:

```
@DTW_rWORDS(" ")
```

- Returns: "0"

Table Functions

These functions simplify working with Net.Data tables and are more efficient than writing your own functions using REXX, C, or Perl.

- “DTW_TB_APPENDROW” on page 207
- “DTW_TB_COLS” on page 209
- “DTW_TB_DELETEROW” on page 212
- “DTW_TB_DELETECOL” on page 211
- “DTW_TB_DLIST” on page 214
- “DTW_TB_DUMP” on page 216
- “DTW_TB_DUMPV” on page 217
- “DTW_TB_GETN” on page 219
- “DTW_TB_GETV” on page 221
- “DTW_TB_HTMLENCODE” on page 223
- “DTW_TB_INPUT_CHECKBOX” on page 225
- “DTW_TB_INPUT_RADIO” on page 227
- “DTW_TB_INPUT_TEXT” on page 229
- “DTW_TB_INSERTCOL” on page 231
- “DTW_TB_INSERTROW” on page 232
- “DTW_TB_LIST” on page 234
- “DTW_TB_QUERYCOLNONJ” on page 236
- “DTW_TB_ROWS” on page 238
- “DTW_TB_SELECT” on page 239
- “DTW_TB_SETCOLS” on page 241
- “DTW_TB_SETN” on page 242
- “DTW_TB_SETV” on page 244
- “DTW_TB_TABLE” on page 246
- “DTW_TB_TEXTAREA” on page 248

DTW_TB_APPENDROW

AIX	HP-UX	Linux	OS/2	OS/390	OS/400	SCO	SUN	Win NT
X	X	X	X	X	X	X	X	X

Purpose

Adds one or more rows to the end of a Net.Data table.

Format

@DTW_TB_APPENDROW(table, rows)

Parameters

Table 118. DTW_TB_APPENDROW Parameters

Data Type	Parameter	Use	Description
table	<i>table</i>	INOUT	The macro table variable for which rows are appended.
integer	<i>rows</i>	IN	The number of rows to append to <i>table</i> .

Return Codes

Table 119. DTW_TB_APPENDROW Return Codes

Return Code	Explanation
-1001	The server could not process a Net.Data request to allocate memory.
1001	An input parameter contained a NULL value.
1003	The number of parameters passed on a function call either exceeded the maximum number allowed, or was less than the minimum number required by the function.
1004	A parameter passed on a function call, required to be a Net.Data macro table variable, was of a different variable type.
1005	A parameter passed on a function call, required to be a string variable, was of a different variable type.
1007	A parameter contains a value which is not valid.
1008	A parameter is outside of table bounds.
1010	Data was written to the table until it was full, and the remainder of the data was discarded.

Usage Notes

1. The number of columns in the table must be set before calling DTW_TB_APPENDROW(). You can set the number of columns with the DTW_TB_SETCOLS() or DTW_TB_INSERTCOL() functions, or by passing the table to a language environment to be set.
2. You can assign values to the new rows with the DTW_TB_SETV() function after rows are appended to the table, or pass the table to a language environment for processing.
3. If there is a limit on the total number of rows allowed in the table, and the number of rows to be appended can cause the limit to be exceeded, an error is returned to the caller.

Examples

Example 1: Appends ten rows to the table

```
%DEFINE myTable = %TABLE
```

```
@DTW_TB_APPENDROW(myTable, "10")
```

DTW_TB_COLS

AIX	HP-UX	Linux	OS/2	OS/390	OS/400	SCO	SUN	Win NT
X	X	X	X	X	X	X	X	X

Purpose

Returns the number of columns in a Net.Data table.

Format

@DTW_TB_COLS(table, cols)

@DTW_TB_rCOLS(table)

Parameters

Table 120. DTW_TB_COLS Parameters

Data Type	Parameter	Use	Description
table	<i>table</i>	IN	The macro table variable for which the number of columns are returned.
integer	<i>cols</i>	OUT	A variable that contains the number of columns in <i>table</i> .

Return Codes

Table 121. DTW_TB_COLS Return Codes

Return Code	Explanation
-1001	The server could not process a Net.Data request to allocate memory.
1001	An input parameter contained a NULL value.
1003	The number of parameters passed on a function call either exceeded the maximum number allowed, or was less than the minimum number required by the function.
1004	A parameter passed on a function call, required to be a Net.Data macro table variable, was of a different variable type.
1005	A parameter passed on a function call, required to be a string variable, was of a different variable type.
1006	A literal string was passed on a function call for a parameter which was required to be an output parameter.

Examples

Example 1: Retrieves the number of columns and assigns the value to *cols*

```
%DEFINE myTable = %TABLE
%DEFINE cols = ""
...
@FillTable(myTable)
...
@DTW_TB_COLS(myTable, cols)
```

Example 2: Retrieves and displays the value for the current number of columns in the table

```
%DEFINE myTable = %TABLE
...
@FillTable(myTable)
...
<P>My table contains @DTW_TB_rCOLS(myTable) columns.
```

DTW_TB_DELETECOL

AIX	HP-UX	Linux	OS/2	OS/390	OS/400	SCO	SUN	Win NT
X	X	X	X	X	X	X	X	X

Purpose

Deletes one or more columns from a Net.data table.

Format

@DTW_TB_DELETECOL(table, after_col, cols)

Parameters

Table 122. DTW_TB_DELETECOL Parameters

Data Type	Parameter	Use	Description
table	<i>table</i>	INOUT	The macro table variable from which columns are to be deleted.
integer	<i>after_col</i>	IN	The number of the column after which subsequent columns are to be deleted. To delete the first column, specify 0.
integer	<i>cols</i>	IN	The number of columns to delete from <i>table</i> .

Return Codes

Table 123. DTW_TB_DELETECOL Return Codes

Return Code	Explanation
-1001	The server could not process a Net.Data request to allocate memory.
1001	An input parameter contained a NULL value.
1003	The number of parameters passed on a function call either exceeded the maximum number allowed, or was less than the minimum number required by the function.
1004	A parameter passed on a function call, required to be a Net.Data macro table variable, was of a different variable type.
1005	A parameter passed on a function call, required to be a string variable, was of a different variable type.
1007	A parameter contains a value which is not valid.
1008	A parameter is outside of table bounds.

Examples

Example 1: Deletes the third and fourth columns from the table

```
%DEFINE myTable = %TABLE
@DTW_TB_DELETECOL(myTable, "3", "2")
```

Example 2: Deletes the first column from the table

```
%DEFINE myTable = %TABLE
@DTW_TB_DELETECOL(myTable, "0", "1")
```

DTW_TB_DELETEROW

AIX	HP-UX	Linux	OS/2	OS/390	OS/400	SCO	SUN	Win NT
X	X	X	X	X	X	X	X	X

Purpose

Deletes one or more rows from a Net.Data table.

Format

@DTW_TB_DELETEROW(table, start_row, rows)

Parameters

Table 124. DTW_TB_DELETEROW Parameters

Data Type	Parameter	Use	Description
table	<i>table</i>	INOUT	The macro table variable from which rows are to be deleted.
integer	<i>start_row</i>	IN	The row number of the first row in <i>table</i> to delete.
integer	<i>rows</i>	IN	The number of rows to delete from <i>table</i> .

Return Codes

Table 125. DTW_TB_DELETEROW Return Codes

Return Code	Explanation
-1001	The server could not process a Net.Data request to allocate memory.
1001	An input parameter contained a NULL value.
1003	The number of parameters passed on a function call either exceeded the maximum number allowed, or was less than the minimum number required by the function.
1004	A parameter passed on a function call, required to be a Net.Data macro table variable, was of a different variable type.
1005	A parameter passed on a function call, required to be a string variable, was of a different variable type.
1007	A parameter contains a value which is not valid.
1008	A parameter is outside of table bounds.

Usage Notes

The number of columns in the table must be set before calling DTW_TB_DELETEROW(). You can set the number of columns with the DTW_TB_SETCOLS() or DTW_TB_INSERTCOL() functions, or by passing the table to a language environment to be set.

Examples

Example 1: Deletes five rows starting at row 10 of a table

```
%DEFINE myTable = %TABLE
```

```
@DTW_TB_DELETEROW(myTable, "10", "5")
```

Example 2: Deletes all of the rows of a table

```
%DEFINE myTable = %TABLE  
@DTW_TB_DELETE_ROW(myTable, "1", @DTW_TB_rROWS(myTable))
```

DTW_TB_DLIST

AIX	HP-UX	Linux	OS/2	OS/390	OS/400	SCO	SUN	Win NT
X	X	X	X	X	X	X	X	X

Purpose

Generates an HTML definition list from a Net.Data table.

Format

@DTW_TB_DLIST(table, term, def, termstyle, defstyle, link, link_u, image, image_u)

@DTW_TB_DLIST(table, term, def, termstyle, defstyle, link, link_u, image)

@DTW_TB_DLIST(table, term, def, termstyle, defstyle, link, link_u)

@DTW_TB_DLIST(table, term, def, termstyle, defstyle, link)

@DTW_TB_DLIST(table, term, def, termstyle, defstyle)

@DTW_TB_DLIST(table, term, def, termstyle)

@DTW_TB_DLIST(table, term, def)

@DTW_TB_DLIST(table, term)

@DTW_TB_DLIST(table)

Parameters

Table 126. DTW_TB_DLIST Parameters

Data Type	Parameter	Use	Description
table	<i>table</i>	IN	A symbol specifying the macro table variable to display as an HTML definition list.
integer	<i>term</i>	IN	The column number in <i>table</i> that contains <i>term</i> name values (the text to go after the <DT> tag). The default is to use the first column.
integer	<i>def</i>	IN	The column number in <i>table</i> containing term definition values (the text to go after the <DD> tag). The default is to use the second column.
string	<i>termstyle</i>	IN	A variable or literal string that contains a list of HTML elements for the <i>term</i> name values. The default is to use no style tags.
string	<i>defstyle</i>	IN	A variable or literal string containing a list of HTML elements for the <i>term</i> definition values. The default is to use no style tags.
string	<i>link</i>	IN	Specifies for which HTML elements an HTML link is generated. Valid values are DT and DD. The default is not to generate HTML links.
integer	<i>link_u</i>	IN	The column number in <i>table</i> that contains the URLs for the HTML references. The default is not to generate HTML links.
string	<i>image</i>	IN	Specifies for which HTML elements an inline image is generated. Valid values are DT and DD. The default is not to generate inline images (DT).

Table 126. DTW_TB_DLIST Parameters (continued)

Data Type	Parameter	Use	Description
integer	<i>image_u</i>	IN	The column number in <i>table</i> that contains the URLs for the inline images. The default is not to generate inline images.

Return Codes

Table 127. DTW_TB_DLIST Return Codes

Return Code	Explanation
-1001	The server could not process a Net.Data request to allocate memory.
1001	An input parameter contained a NULL value.
1003	The number of parameters passed on a function call either exceeded the maximum number allowed, or was less than the minimum number required by the function.
1004	A parameter passed on a function call, required to be a Net.Data macro table variable, was of a different variable type.
1005	A parameter passed on a function call, required to be a string variable, was of a different variable type.
1007	A parameter contains a value which is not valid.
1008	A parameter is outside of table bounds.

Examples

Example 1: Creates a definition list producing the HTML shown below, depending on the table data

```
@DTW_TB_DLIST(Mytable,"3","4","b i","strong","DD","2","DT","1")
```

Results:

```
<DL>
<DT>
<IMG SRC="http://www.mycompany.com/images/image1.gif" ALT=""><b><i>image1text</i></b>
<DD>
<A HREF="http://www.mycompany.com/link1.html"><strong>link1text</strong></A>
<DT>
<IMG SRC="http://www.mycompany.com/images/image2.gif" ALT=""><b><i>image2text</i></b>
<DD>
<A HREF="http://www.mycompany.com/link2.html"><strong>link2text</strong></A>
<DT>
<IMG SRC="http://www.mycompany.com/images/image3.gif" ALT=""><b><i>image3text</i></b>
<DD>
<A HREF="http://www.mycompany.com/link3.html"><strong>link3text</strong></A>
<DT>
<IMG SRC="http://www.mycompany.com/images/image4.gif" ALT=""><b><i>image4text</i></b>
<DD>
<A HREF="http://www.mycompany.com/link4.html"><strong>link4text</strong></A>
</DT>
</DL>
```

DTW_TB_DUMP

AIX	HP-UX	Linux	OS/2	OS/390	OS/400	SCO	SUN	Win NT
X	X	X	X	X	X	X	X	X

Purpose

Prints out the contents of a Net.Data table using the HTML <PRE> tag, where each row of the table is displayed on one line.

Format

@DTW_TB_DUMP(table)

Parameters

Table 128. DTW_TB_DUMP Parameters

Data Type	Parameter	Use	Description
table	table	IN	A symbol specifying the macro table variable to display.

Return Codes

Table 129. DTW_DB_DUMP Return Codes

Return Code	Explanation
-1001	The server could not process a Net.Data request to allocate memory.
1001	An input parameter contained a NULL value.
1003	The number of parameters passed on a function call either exceeded the maximum number allowed, or was less than the minimum number required by the function.
1004	A parameter passed on a function call, required to be a Net.Data macro table variable, was of a different variable type.
1007	A parameter contains a value which is not valid.

Usage Notes

If the Net.Data table is empty, an error is returned.

Examples

Example 1:

```
@DTW_TB_DUMP(Mytable)
```

The HTML generated by this example looks like this:

```
<PRE>
Name           Department           Position
Jack Smith     Internet Technologies Software Engineer
Helen Williams Database             Development Manager
Alex Jones     Manufacturing        Industrial Engineer
Tom Baker      Procurement         Sales Rep
</PRE>
```

DTW_TB_DUMPV

AIX	HP-UX	Linux	OS/2	OS/390	OS/400	SCO	SUN	Win NT
X	X	X	X	X	X	X	X	X

Purpose

Prints out the contents of the Net.Data table using the HTML <PRE> tag, where each field of the table is on one line.

Format

@DTW_TB_DUMPV(table)

Parameters

Table 130. DTW_TB_DUMPV Parameters

Data Type	Parameter	Use	Description
table	<i>table</i>	IN	A symbol specifying the macro table variable to display.

Return Codes

Table 131. DTW_TB_DUMPV Return Codes

Return Code	Explanation
-1001	The server could not process a Net.Data request to allocate memory.
1001	An input parameter contained a NULL value.
1003	The number of parameters passed on a function call either exceeded the maximum number allowed, or was less than the minimum number required by the function.
1004	A parameter passed on a function call, required to be a Net.Data macro table variable, was of a different variable type.
1007	A parameter contains a value which is not valid.

Usage Notes

If the Net.Data table is empty, an error is returned

Examples

Example 1:

```
@DTW_TB_DUMPV(Mytable)
```

The HTML generated for this example looks like this:

```
<PRE>
http://www.mycompany.com/images/image1.gif
http://www.mycompany.com/link1.html
image1text
link1text
http://www.mycompany.com/images/image2.gif
http://www.mycompany.com/link2.html
image2text
link2text
http://www.mycompany.com/images/image3.gif
http://www.mycompany.com/link3.html
image3text
link3text
http://www.mycompany.com/images/image4.gif
```

```
http://www.mycompany.com/link4.html  
image4text  
link4text  
</PRE>
```

DTW_TB_GETN

AIX	HP-UX	Linux	OS/2	OS/390	OS/400	SCO	SUN	Win NT
X	X	X	X	X	X	X	X	X

Purpose

Returns a column heading from a Net.Data table.

Format

@DTW_TB_GETN(table, col, name)

@DTW_TB_rGETN(table, col)

Parameters

Table 132. DTW_TB_GETN Parameters

Data Type	Parameter	Use	Description
table	<i>table</i>	IN	The macro table variable from which a column name is returned.
integer	<i>col</i>	IN	The column number of the column whose name is to be returned.
string	<i>name</i>	OUT	A variable that contains the name of the column specified in <i>col</i> .

Return Codes

Table 133. DTW_TB_GETN Return Codes

Return Code	Explanation
-1001	The server could not process a Net.Data request to allocate memory.
1001	An input parameter contained a NULL value.
1003	The number of parameters passed on a function call either exceeded the maximum number allowed, or was less than the minimum number required by the function.
1004	A parameter passed on a function call, required to be a Net.Data macro table variable, was of a different variable type.
1005	A parameter passed on a function call, required to be a string variable, was of a different variable type.
1006	A literal string was passed on a function call for a parameter which was required to be an output parameter.
1007	A parameter contains a value which is not valid.
1008	A parameter is outside of table bounds.

Usage Notes

Before calling DTW_TB_GETN(), set the number of columns in the table. You can set the number of columns with the DTW_TB_SETCOLS() or DTW_TB_INSERTCOL() functions, or by passing the table to a language environment to be set.

Examples

Example 1: Retrieves the column name of column 4

```
%DEFINE myTable = %TABLE
%DEFINE name = ""
...
@FillTable(myTable)
...
@DTW_TB_GETN(myTable, "4", name)
```

Example 2: Retrieves the column name of the last column in the table

```
%DEFINE myTable = %TABLE
...
@FillTable(myTable)
...
<P>The column name of the last column is @DTW_TB_rGETN(myTable, @DTW_TB_rCOLS(myTable))
```

DTW_TB_GETV

AIX	HP-UX	Linux	OS/2	OS/390	OS/400	SCO	SUN	Win NT
X	X	X	X	X	X	X	X	X

Purpose

Returns the value at a given row and column in a Net.Data table.

Format

@DTW_TB_GETV(table, row, col, value)

@DTW_TB_rGETV(table, row, col)

Parameters

Table 134. DTW_TB_GETV Parameters

Data Type	Parameter	Use	Description
table	<i>table</i>	IN	The macro table variable for which a table value is returned.
integer	<i>row</i>	IN	The row number of the value to be returned.
integer	<i>col</i>	IN	The column number of the value to be returned.
string	<i>value</i>	OUT	A variable that contains the value at the row and column specified in <i>row</i> and <i>col</i> .

Return Codes

Table 135. DTW_TB_GETV Return Codes

Return Code	Explanation
-1001	The server could not process a Net.Data request to allocate memory.
1001	An input parameter contained a NULL value.
1003	The number of parameters passed on a function call either exceeded the maximum number allowed, or was less than the minimum number required by the function.
1004	A parameter passed on a function call, required to be a Net.Data macro table variable, was of a different variable type.
1005	A parameter passed on a function call, required to be a string variable, was of a different variable type.
1006	A literal string was passed on a function call for a parameter which was required to be an output parameter.
1007	A parameter contains a value which is not valid.
1008	A parameter is outside of table bounds.

Usage Notes

Before calling DTW_TB_GETV(), set the number of columns in the table. You can set the number of columns with the DTW_TB_SETCOLS() or DTW_TB_INSERTCOL() functions, or by passing the table to a language environment to be set.

Examples

Example 1: Retrieves the table value at row 6, column 3

```
%DEFINE myTable = %TABLE
%DEFINE value = ""
...
@FillTable(myTable)
...
@DTW_TB_GETV(myTable, "6", "3", value)
```

Example 2: Retrieves the table value at row 1, column 1

```
%DEFINE myTable = %TABLE
...
@FillTable(myTable)
...
<P>The table value of row 1, column 1 is @DTW_TB_rGETV(myTable, "1", "1").
```

DTW_TB_HTML ENCODE

AIX	HP-UX	Linux	OS/2	OS/390	OS/400	SCO	SUN	Win NT
X	X	X	X	X	X	X	X	X

Purpose

Replaces certain characters in the data located in a Net.Data table with their corresponding HTML character escape codes.

Format

@DTW_TB_HTML ENCODE(table, collist)

@DTW_TB_HTML ENCODE(table)

Parameters

Table 136. DTW_TB_HTML ENCODE Parameters

Data Type	Parameter	Use	Description
table	<i>table</i>	INOUT	The macro table variable to modify.
string	<i>collist</i>	IN	The column numbers in <i>table</i> to encode. The default is to encode all columns.

Return Codes

Table 137. DTW_TB_HTML ENCODE Return Codes

Return Code	Explanation
-1001	The server could not process a Net.Data request to allocate memory.
1001	An input parameter contained a NULL value.
1003	The number of parameters passed on a function call either exceeded the maximum number allowed, or was less than the minimum number required by the function.
1004	A parameter passed on a function call, required to be a Net.Data macro table variable, was of a different variable type.
1005	A parameter passed on a function call, required to be a string variable, was of a different variable type.
1007	A parameter contains a value which is not valid.
1008	A parameter is outside of table bounds.

Usage Notes

The characters that are replaced are indicated in the table below.

Name	Character	Code
Ampersand	&	&
Double quote	"	"
Greater than	>	>
Less than	<	<

Examples

Example 1:

```
@DTW_TB_HTMLencode(Mytable, "3 4")
```

The special characters in columns 3 and 4 of the specified table are replaced with their encoded forms.

DTW_TB_INPUT_CHECKBOX

AIX	HP-UX	Linux	OS/2	OS/390	OS/400	SCO	SUN	Win NT
X	X	X	X	X	X	X	X	X

Purpose

Generates one or more HTML check box input tags from a Net.Data table.

Format

@DTW_TB_INPUT_CHECKBOX(*table*, *prompt*, *namecol*, *valuecol*, *rows*, *checkedrows*)

@DTW_TB_INPUT_CHECKBOX(*table*, *prompt*, *namecol*, *valuecol*, *rows*)

@DTW_TB_INPUT_CHECKBOX(*table*, *prompt*, *namecol*, *valuecol*)

@DTW_TB_INPUT_CHECKBOX(*table*, *prompt*, *namecol*)

Parameters

Table 138. DTW_TB_INPUT_CHECKBOX Parameters

Data Type	Parameter	Use	Description
table	<i>table</i>	IN	The macro table variable to display as check box input tags.
string	<i>prompt</i>	IN	The column number in <i>table</i> or a string containing the text to display next to the check box. This parameter is required but can have a null ("") value. When <i>prompt</i> is null, the value used is the value defined for <i>namecol</i> .
string	<i>namecol</i>	IN	The column number in <i>table</i> or a string containing the input field names.
integer	<i>valuecol</i>	IN	The column number in <i>table</i> that contains the input field values. The default is 1.
integer	<i>rows</i>	IN	The list of rows in <i>table</i> from which to generate the input fields. The default is to use all rows.
integer	<i>checkedrows</i>	IN	The list of rows specifying which <i>rows</i> of <i>table</i> to check. The default is not to check fields.

Return Codes

Table 139. DTW_TB_INPUT_CHECKBOX Return Codes

Return Code	Explanation
-1001	The server could not process a Net.Data request to allocate memory.
1001	An input parameter contained a NULL value.
1002	An input parameter contained a string value which consisted of the null-terminating character.
1003	The number of parameters passed on a function call either exceeded the maximum number allowed, or was less than the minimum number required by the function.

Table 139. DTW_TB_INPUT_CHECKBOX Return Codes (continued)

Return Code	Explanation
1004	A parameter passed on a function call, required to be a Net.Data macro table variable, was of a different variable type.
1005	A parameter passed on a function call, required to be a string variable, was of a different variable type.
1007	A parameter contains a value which is not valid.
1008	A parameter is outside of table bounds.

Examples

Example 1: Generates HTML for three check box input tags

```
@DTW_TB_INPUT_CHECKBOX(Mytable,"3","4","", "2 3 4", "1 3 4")
```

Results:

```
<INPUT TYPE="CHECKBOX" NAME="link2text" VALUE="1">image2text<BR>  
<INPUT TYPE="CHECKBOX" NAME="link3text" VALUE="1" CHECKED>image3text<BR>  
<INPUT TYPE="CHECKBOX" NAME="link4text" VALUE="1" CHECKED>image4text<BR>
```

DTW_TB_INPUT_RADIO

AIX	HP-UX	Linux	OS/2	OS/390	OS/400	SCO	SUN	Win NT
X	X	X	X	X	X	X	X	X

Purpose

Generates HTML radio button input tags from a Net.Data table.

Format

@DTW_TB_INPUT_RADIO(table, prompt, namecol, valuecol, rows, checkedrows)

@DTW_TB_INPUT_RADIO(table, prompt, namecol, valuecol, rows)

@DTW_TB_INPUT_RADIO(table, prompt, namecol, valuecol)

Parameters

Table 140. DTW_TB_INPUT_RADIO Parameters

Data Type	Parameter	Use	Description
table	<i>table</i>	IN	The macro table variable to display as radio button input tags.
string	<i>prompt</i>	IN	The column number in <i>table</i> or a string containing the text to display next to the radio button. Required parameter, but can contain a null ("") value. When <i>prompt</i> is null, uses the value of <i>valuecol</i> .
string	<i>namecol</i>	IN	The column number in <i>table</i> or a string containing the input field names.
integer	<i>valuecol</i>	IN	The column number in <i>table</i> that contains the input field values.
string	<i>rows</i>	IN	The list of rows in <i>table</i> from which to generate the input fields. The default is to use all rows.
integer	<i>checkedrows</i>	IN	A row number in <i>table</i> to display the corresponding radio button as checked. Only one value is allowed.

Return Codes

Table 141. DTW_TB_INPUT_RADIO Return Codes

Return Code	Explanation
-1001	The server could not process a Net.Data request to allocate memory.
1001	An input parameter contained a NULL value.
1002	An input parameter contained a string value which consisted of the null-terminating character.
1003	The number of parameters passed on a function call either exceeded the maximum number allowed, or was less than the minimum number required by the function.
1004	A parameter passed on a function call, required to be a Net.Data macro table variable, was of a different variable type.

Table 141. DTW_TB_INPUT_RADIO Return Codes (continued)

Return Code	Explanation
1005	A parameter passed on a function call, required to be a string variable, was of a different variable type.
1007	A parameter contains a value which is not valid.
1008	A parameter is outside of table bounds.

Examples

Example 1: Generates HTML for three radio button input tags

```
@DTW_TB_INPUT_RADIO(Mytable,"3","Radio4","4","2 3 4","4")
```

Results:

```
<INPUT TYPE="RADIO" NAME="Radio4" VALUE="link2text">image2text<BR>  
<INPUT TYPE="RADIO" NAME="Radio4" VALUE="link3text">image3text<BR>  
<INPUT TYPE="RADIO" NAME="Radio4" VALUE="link4text" CHECKED>image4text<BR>
```

DTW_TB_INPUT_TEXT

AIX	HP-UX	Linux	OS/2	OS/390	OS/400	SCO	SUN	Win NT
X	X	X	X	X	X	X	X	X

Purpose

Generates HTML <INPUT> tags for specified rows in a Net.Data table.

Format

@DTW_TB_INPUT_TEXT(table, prompt, namecol, valuecol, size, maxlen, rows)

@DTW_TB_INPUT_TEXT(table, prompt, namecol, valuecol, size, maxlen)

@DTW_TB_INPUT_TEXT(table, prompt, namecol, valuecol, size)

@DTW_TB_INPUT_TEXT(table, prompt, namecol, valuecol)

@DTW_TB_INPUT_TEXT(table, prompt, namecol)

Parameters

Table 142. DTW_TB_INPUT_TEXT Parameters

Data Type	Parameter	Use	Description
table	<i>table</i>	IN	The macro table variable to display as text input tags.
string	<i>prompt</i>	IN	The column number in <i>table</i> or a string containing the text to display next to the input field. If <i>prompt</i> is null, no text is displayed.
string	<i>namecol</i>	IN	The column number in <i>table</i> that contains the input field names.
integer	<i>valuecol</i>	IN	The column number in <i>table</i> that contains the default input field values, which is specified for the VALUE attribute on the INPUT tag. The default is to not generate the VALUE attribute value.
integer	<i>size</i>	IN	The number of characters of the input field, which is specified for the SIZE attribute on the INPUT tag. The default is the length of the longest default input value, or 10 if no default input exists.
integer	<i>maxlen</i>	IN	The maximum length of an input string, which is specified for the MAXLENGTH attribute of the INPUT tag. The default is not to generate the MAXLENGTH attribute value.
integer	<i>rows</i>	IN	The list of rows in <i>table</i> from which to generate the input fields. The default is to use all rows.

Return Codes

Table 143. DTW_TB_INPUT_TEXT Return Codes

Return Code	Explanation
-1001	The server could not process a Net.Data request to allocate memory.

Table 143. DTW_TB_INPUT_TEXT Return Codes (continued)

Return Code	Explanation
1001	An input parameter contained a NULL value.
1002	An input parameter contained a string value which consisted of the null-terminating character.
1003	The number of parameters passed on a function call either exceeded the maximum number allowed, or was less than the minimum number required by the function.
1004	A parameter passed on a function call, required to be a Net.Data macro table variable, was of a different variable type.
1005	A parameter passed on a function call, required to be a string variable, was of a different variable type.
1007	A parameter contains a value which is not valid.
1008	A parameter is outside of table bounds.

Examples

Example 1: Returns three HTML <INPUT> tags

```
@DTW_TB_INPUT_TEXT(Mytable,"3","3","4","35","40","1 2 3")
```

Results:

```
<P>image1text
<INPUT TYPE="TEXT" NAME="image1text" VALUE="link1text" SIZE="35" MAXLENGTH="40">
<P>image2text
<INPUT TYPE="TEXT" NAME="image2text" VALUE="link2text" SIZE="35" MAXLENGTH="40">
<P>image3text
<INPUT TYPE="TEXT" NAME="image3text" VALUE="link3text" SIZE="35" MAXLENGTH="40">
```

DTW_TB_INSERTCOL

AIX	HP-UX	Linux	OS/2	OS/390	OS/400	SCO	SUN	Win NT
X	X	X	X	X	X	X	X	X

Purpose

Inserts one or more columns into a Net.Data table.

Format

@DTW_TB_INSERTCOL(table, after_col, cols)

Parameters

Table 144. DTW_TB_INSERTCOL Parameters

Data Type	Parameter	Use	Description
table	<i>table</i>	INOUT	The macro table variable into which columns are to be inserted.
integer	<i>after_col</i>	IN	The column number of the column after which the new columns are to be inserted. To insert columns at the beginning of the table, specify 0.
integer	<i>cols</i>	IN	The number of columns to insert into <i>table</i> .

Return Codes

Table 145. DTW_TB_INSERTCOL Return Codes

Return Code	Explanation
-1001	The server could not process a Net.Data request to allocate memory.
1001	An input parameter contained a NULL value.
1003	The number of parameters passed on a function call either exceeded the maximum number allowed, or was less than the minimum number required by the function.
1004	A parameter passed on a function call, required to be a Net.Data macro table variable, was of a different variable type.
1005	A parameter passed on a function call, required to be a string variable, was of a different variable type.
1007	A parameter contains a value which is not valid.
1008	A parameter is outside of table bounds.

Examples

Example 1: Inserts five columns at the end of a table

```
%DEFINE myTable = %TABLE  
  
@DTW_TB_INSERTCOL(myTable, @DTW_TB_rCOLS(myTable), "5")
```

Example 2: Inserts a column at the beginning of a table

```
%DEFINE myTable = %TABLE  
  
@DTW_TB_INSERTCOL(myTable, "0", "1")
```

DTW_TB_INSERTROW

AIX	HP-UX	Linux	OS/2	OS/390	OS/400	SCO	SUN	Win NT
X	X	X	X	X	X	X	X	X

Purpose

Inserts one or more rows into a Net.Data table.

Format

@DTW_TB_INSERTROW(table, after_row, rows)

Parameters

Table 146. DTW_TB_INSERTROW Parameters

Data Type	Parameter	Use	Description
table	<i>table</i>	INOUT	The macro table variable into which rows are to be inserted.
integer	<i>after_row</i>	IN	The number of the row after which new rows are inserted. To insert rows at the beginning of the table, specify 0.
integer	<i>rows</i>	IN	The number of rows to insert into <i>table</i> .

Return Codes

Table 147. DTW_TB_INSERTROW Return Codes

Return Code	Explanation
-1001	The server could not process a Net.Data request to allocate memory.
1001	An input parameter contained a NULL value.
1003	The number of parameters passed on a function call either exceeded the maximum number allowed, or was less than the minimum number required by the function.
1004	A parameter passed on a function call, required to be a Net.Data macro table variable, was of a different variable type.
1005	A parameter passed on a function call, required to be a string variable, was of a different variable type.
1007	A parameter contains a value which is not valid.
1008	A parameter is outside of table bounds.

Usage Notes

Before calling DTW_TB_INSERTROW(), set the number of columns in the table. You can set the number of columns with the DTW_TB_SETCOLS() or DTW_TB_INSERTCOL() functions, or by passing the table to a language environment to be set.

Examples

Example 1: Inserts a row after row five of a table

```
%DEFINE myTable = %TABLE
```

```
@DTW_TB_INSERTROW(myTable, "5", "1")
```

Example 2: Inserts three rows at the start of a table

```
%DEFINE myTable = %TABLE  
@DTW_TB_INSERTROW(myTable, "0", "3")
```

DTW_TB_LIST

AIX	HP-UX	Linux	OS/2	OS/390	OS/400	SCO	SUN	Win NT
X	X	X	X	X	X	X	X	X

Purpose

Generates an HTML list from a Net.Data table.

Format

@DTW_TB_LIST(*table*, *listtype*, *listitem*, *itemstyle*, *link_u*, *image_u*)

@DTW_TB_LIST(*table*, *listtype*, *listitem*, *itemstyle*, *link_u*)

@DTW_TB_LIST(*table*, *listtype*, *listitem*, *itemstyle*)

@DTW_TB_LIST(*table*, *listtype*, *listitem*)

@DTW_TB_LIST(*table*, *listtype*)

Parameters

Table 148. DTW_TB_LIST Parameters

Data Type	Parameter	Use	Description
table	<i>table</i>	IN	A symbol specifying the macro table variable to display as an HTML list.
string	<i>listtype</i>	IN	The type of list to generate. Acceptable values include: DIR MENU OL UL
integer	<i>listitem</i>	IN	The column number in <i>table</i> containing the list values (the text to go after the tag). The default is to use the first column.
string	<i>itemstyle</i>	IN	A variable or literal string containing a list of HTML elements for the term name values. The default is to use no style tags.
integer	<i>link_u</i>	IN	The column number in <i>table</i> that contains the URLs for the HTML links. If this value is not specified, no HTML links are generated.
integer	<i>image_u</i>	IN	The column number in <i>table</i> that contains the URLs for the inline images. If this value is not specified, no inline images are generated.

Return Codes

Table 149. DTW_TB_LIST Return Codes

Return Code	Explanation
-1001	The server could not process a Net.Data request to allocate memory.
1001	An input parameter contained a NULL value.
1002	An input parameter contained a string value which consisted of the null-terminating character.

Table 149. DTW_TB_LIST Return Codes (continued)

Return Code	Explanation
1003	The number of parameters passed on a function call either exceeded the maximum number allowed, or was less than the minimum number required by the function.
1004	A parameter passed on a function call, required to be a Net.Data macro table variable, was of a different variable type.
1005	A parameter passed on a function call, required to be a string variable, was of a different variable type.
1007	A parameter contains a value which is not valid.
1008	A parameter is outside of table bounds.

Examples

Example 1: Generates HTML tags for an ordered list

```
@DTW_TB_LIST(Mytable,"OL","4","TT U","2","1")
```

Results:

```
<TT><U>
<OL>
<LI><A HREF="http://www.mycompany.com/link1.html">
<IMG SRC="http://www.mycompany.com/images/image1.gif" ALT="">link1text</A>
<LI><A HREF="http://www.mycompany.com/link2.html">
<IMG SRC="http://www.mycompany.com/images/image2.gif" ALT="">link2text</A>
<LI><A HREF="http://www.mycompany.com/link3.html">
<
<IMG SRC="http://www.mycompany.com/images/image3.gif" ALT="">link3text</A>
<LI><A HREF="http://www.mycompany.com/link4.html">
<IMG SRC="http://www.mycompany.com/images/image4.gif" ALT="">link4txt</A>
</OL>
</U></TT>
```

DTW_TB_QUERYCOLNONJ

AIX	HP-UX	Linux	OS/2	OS/390	OS/400	SCO	SUN	Win NT
X	X	X	X	X	X	X	X	X

Purpose

Returns the column number associated with a column heading of a Net.Data table.

Format

@DTW_TB_QUERYCOLNONJ(table, name, col)

@DTW_TB_rQUERYCOLNONJ(table, name)

Parameters

Table 150. DTW_TB_QUERYCOLNONJ Parameters

Data Type	Parameter	Use	Description
table	<i>table</i>	IN	The macro table variable from which a column number is to be returned.
string	<i>name</i>	IN	The name of the column heading for which the column number is returned. If the column heading does not exist in the table, 0 is returned.
integer	<i>col</i>	OUT	A variable that contains the column number of the column whose name is specified in <i>name</i> .

Return Codes

Table 151. DTW_TB_QUERYCOLNONJ Return Codes

Return Code	Explanation
-1001	The server could not process a Net.Data request to allocate memory.
1001	An input parameter contained a NULL value.
1003	The number of parameters passed on a function call either exceeded the maximum number allowed, or was less than the minimum number required by the function.
1004	A parameter passed on a function call, required to be a Net.Data macro table variable, was of a different variable type.
1005	A parameter passed on a function call, required to be a string variable, was of a different variable type.
1006	A literal string was passed on a function call for a parameter which was required to be an output parameter.

Usage Notes

1. Before calling DTW_TB_QUERYCOLNONJ(), set the number of columns in the table. You can set the number of columns with the DTW_TB_SETCOLS() or DTW_TB_INSERTCOL() functions, or by passing the table to a language environment to be set.
2. If the column heading does not exist in the table, 0 is returned.

Examples

Example 1: Retrieves the column number for the column whose name is SERIAL_NUMBER

```
%DEFINE myTable = %TABLE  
%DEFINE col = ""
```

```
@DTW_TB_QUERYCOLNONJ(myTable, "SERIAL_NUMBER", col)
```

Example 2: Retrves the column number for the column whose name is SERIAL_NUMBER

```
%DEFINE myTable = %TABLE
```

```
<P>The "SERIAL_NUMBER" column is column number @DTW_TB_rQUERYCOLNONJ(myTable, "SERIAL_NUMBER")
```

DTW_TB_ROWS

AIX	HP-UX	Linux	OS/2	OS/390	OS/400	SCO	SUN	Win NT
X	X	X	X	X	X	X	X	X

Purpose

Returns the number of rows in a Net.Data table.

Format

@DTW_TB_ROWS(table, rows)

@DTW_TB_rROWS(table)

Parameters

Table 152. DTW_TB_ROWS Parameters

Data Type	Parameter	Use	Description
table	<i>table</i>	IN	The macro table variable for which the current number of rows is returned.
integer	<i>rows</i>	OUT	A variable that contains the current number of rows in <i>table</i> .

Return Codes

Table 153. DTW_TB_ROWS Return Codes

Return Code	Explanation
-1001	The server could not process a Net.Data request to allocate memory.
1001	An input parameter contained a NULL value.
1003	The number of parameters passed on a function call either exceeded the maximum number allowed, or was less than the minimum number required by the function.
1004	A parameter passed on a function call, required to be a Net.Data macro table variable, was of a different variable type.
1005	A parameter passed on a function call, required to be a string variable, was of a different variable type.
1006	A literal string was passed on a function call for a parameter which was required to be an output parameter.

Examples

Example 1: Retrieves the current number of rows in the table and assigns the value to *rows*

```
%DEFINE myTable = %TABLE
%DEFINE rows = ""
...
@FillTable(myTable)
...
@DTW_TB_ROWS(myTable, rows)
```

DTW_TB_SELECT

AIX	HP-UX	Linux	OS/2	OS/390	OS/400	SCO	SUN	Win NT
X	X	X	X	X	X	X	X	X

Purpose

Generates an HTML selection list from a Net.Data table.

Format

@DTW_TB_SELECT(*table*, *name*, *optioncol*, *size*, *multiple*, *rows*, *selectedrows*, *valuecol*)

@DTW_TB_SELECT(*table*, *name*, *optioncol*, *size*, *multiple*, *rows*, *selectedrows*)

@DTW_TB_SELECT(*table*, *name*, *optioncol*, *size*, *multiple*, *rows*)

@DTW_TB_SELECT(*table*, *name*, *optioncol*, *size*, *multiple*)

@DTW_TB_SELECT(*table*, *name*, *optioncol*, *size*)

@DTW_TB_SELECT(*table*, *name*, *optioncol*)

@DTW_TB_SELECT(*table*, *name*)

Parameters

Table 154. DTW_TB_SELECT Parameters

Data Type	Parameter	Use	Description
table	<i>table</i>	IN	The macro table variable to display as a SELECT field.
string	<i>name</i>	IN	The value of the NAME attribute of the SELECT field.
integer	<i>optioncol</i>	IN	The column number in <i>table</i> with values to use in the OPTION tags of the SELECT field. The default is to use the first column.
integer	<i>size</i>	IN	The number of rows in <i>table</i> to use for OPTION tags in the SELECT field. The default is to use all the rows.
string	<i>multiple</i>	IN	Specifies whether multiple selections are allowed. The default is N, which does not allow multiple selections.
string	<i>rows</i>	IN	The row numbers from <i>table</i> to use in the SELECT field. The default is to use all the rows.
string	<i>selectedrows</i>	IN	The list of rows from <i>table</i> whose OPTION tags are checked. To specify more than one row, you must have the <i>multiple</i> parameter set to Y. The default is to select the first item.
string	<i>valuecol</i>	IN	The column number in <i>table</i> to use for the VALUE attribute of the OPTION tags. The default value is 1. This parameter is optional.

Return Codes

Table 155. DTW_TB_SELECT Return Codes

Return Code	Explanation
-1001	The server could not process a Net.Data request to allocate memory.
1001	An input parameter contained a NULL value.
1003	The number of parameters passed on a function call either exceeded the maximum number allowed, or was less than the minimum number required by the function.
1004	A parameter passed on a function call, required to be a Net.Data macro table variable, was of a different variable type.
1005	A parameter passed on a function call, required to be a string variable, was of a different variable type.
1007	A parameter contains a value which is not valid.
1008	A parameter is outside of table bounds.

Examples

Example 1: Generates an HTML SELECT menu with multiple selections

```
@DTW_TB_SELECT(Mytable,"URL6","4","","y","1 2 4","1 4")
```

Results:

```
<SELECT NAME="URL6" SIZE="3" MULTIPLE>  
<OPTION SELECTED>image1text  
<OPTION>image2text  
<OPTION SELECTED>image4text  
</SELECT>
```

Example 2: Uses the *valuecol* parameter to generate an HTML SELECT menu that uses a column number from which to obtain the values.

```
@DTW_TB_SELECT(Mytable,"URL6","4","","y","1 2 4","1 4", "2")
```

Results:

```
<SELECT NAME="URL6" SIZE="3" MULTIPLE>  
<OPTION VALUE="text_string1" SELECTED>image1text  
<OPTION VALUE="text_string2">image2text  
<OPTION VALUE="text_string4" SELECTED>image4text  
</SELECT>
```

DTW_TB_SETCOLS

AIX	HP-UX	Linux	OS/2	OS/390	OS/400	SCO	SUN	Win NT
X	X	X	X	X	X	X	X	X

Purpose

Sets the number of columns in a Net.Data table.

Format

@DTW_TB_SETCOLS(table, cols)

Parameters

Table 156. DTW_TB_SETCOLS Parameters

Data Type	Parameter	Use	Description
table	<i>table</i>	INOUT	The macro table variable for which the number of columns is set.
integer	<i>cols</i>	IN	The initial number of columns to allocate in <i>table</i> .

Return Codes

Table 157. DTW_TB_SETCOLS Return Codes

Return Code	Explanation
-1001	The server could not process a Net.Data request to allocate memory.
1001	An input parameter contained a NULL value.
1003	The number of parameters passed on a function call either exceeded the maximum number allowed, or was less than the minimum number required by the function.
1004	A parameter passed on a function call, required to be a Net.Data macro table variable, was of a different variable type.
1005	A parameter passed on a function call, required to be a string variable, was of a different variable type.
1007	A parameter contains a value which is not valid.

Usage Notes

1. The DTW_TB_SETCOLS() function can only be used once for a table. Afterwards, use the DTW_TB_DELETECOL() or DTW_TB_INSERTCOL() functions to change the number of columns in the table.
2. Specify the column headings by using the DTW_TB_SETN() function.

Examples

Example 1: Allocates three columns for the table and assigns the names to the columns

```
%DEFINE myTable = %TABLE
```

```
@DTW_TB_SETCOLS(myTable, "3")  
@DTW_TB_SETN(myTable, "Name", "1")  
@DTW_TB_SETN(myTable, "Address", "2")  
@DTW_TB_SETN(myTable, "Phone", "3")
```

DTW_TB_SETN

AIX	HP-UX	Linux	OS/2	OS/390	OS/400	SCO	SUN	Win NT
X	X	X	X	X	X	X	X	X

Purpose

Assigns a name to a column heading in a Net.Data.

Format

@DTW_TB_SETN(table, name, col)

Parameters

Table 158. DTW_TB_SETN Parameters

Data Type	Parameter	Use	Description
table	<i>table</i>	INOUT	The macro table variable in which a column name will be set.
string	<i>name</i>	IN	A character string that is assigned to the column heading of the column specified in <i>col</i> .
integer	<i>col</i>	IN	The column number of the column whose heading is being set.

Return Codes

Table 159. DTW_TB_SETN Return Codes

Return Code	Explanation
-1001	The server could not process a Net.Data request to allocate memory.
1001	An input parameter contained a NULL value.
1003	The number of parameters passed on a function call either exceeded the maximum number allowed, or was less than the minimum number required by the function.
1004	A parameter passed on a function call, required to be a Net.Data macro table variable, was of a different variable type.
1005	A parameter passed on a function call, required to be a string variable, was of a different variable type.
1007	A parameter contains a value which is not valid.
1008	A parameter is outside of table bounds.

Usage Notes

1. Before calling DTW_TB_SETN(), set the number of columns in the table. You can set the number of columns with the DTW_TB_SETCOLS() or DTW_TB_INSERTCOL() functions, or by passing the table to a language environment to be set.
2. To delete a column heading, assign the column heading value to NULL.

Examples

Example 1: Assigns a name to column headings 1 through 3

```
%DEFINE myTable = %TABLE

@DTW_TB_SETCOLS(myTable, "3")
@DTW_TB_SETN(myTable, "Name", "1")
@DTW_TB_SETN(myTable, "Address", "2")
@DTW_TB_SETN(myTable, "Phone", "3")
```

Example 2: Delete the column heading for column 2. This is done by passing a variable on the function call which has not been defined. By default, this variable will have a value of NULL

```
%DEFINE myTable = %TABLE

@DTW_TB_SETN(myTable, nullVar, "2")
```

DTW_TB_SETV

AIX	HP-UX	Linux	OS/2	OS/390	OS/400	SCO	SUN	Win NT
X	X	X	X	X	X	X	X	X

Purpose

Assigns a value to a particular row and column in a Net.Data table.

Format

@DTW_TB_SETV(table, value, row, col)

Parameters

Table 160. DTW_TB_SETV Parameters

Data Type	Parameter	Use	Description
table	<i>table</i>	INOUT	The macro table variable in which a table value will be set.
string	<i>value</i>	IN	A character string that is assigned to the table value of the row and column specified in <i>row</i> and <i>col</i> .
integer	<i>row</i>	IN	The row number of the value to be set.
integer	<i>col</i>	IN	The column number of the value to be set.

Return Codes

Table 161. DTW_TB_SETV Return Codes

Return Code	Explanation
-1001	The server could not process a Net.Data request to allocate memory.
1001	An input parameter contained a NULL value.
1003	The number of parameters passed on a function call either exceeded the maximum number allowed, or was less than the minimum number required by the function.
1004	A parameter passed on a function call, required to be a Net.Data macro table variable, was of a different variable type.
1005	A parameter passed on a function call, required to be a string variable, was of a different variable type.
1007	A parameter contains a value which is not valid.
1008	A parameter is outside of table bounds.

Usage Notes

1. Before calling DTW_TB_SETV(), set the number of columns in the table. You can set the number of columns with the DTW_TB_SETCOLS() or DTW_TB_INSERTCOL() functions, or by passing the table to a language environment to be set.
2. To delete a table value, assign the value to NULL.

Examples

Example 1: Assigns a value to row 3 column 3

```
%DEFINE myTable = %TABLE  
@DTW_TB_SETV(myTable, "value3.3", "3", "3")
```

Example 2: Delete the table value at row 4, column 2. This is done by passing a variable on the function call which has not been defined. By default, this variable will have a value of NULL.

```
%DEFINE myTable = %TABLE  
@DTW_TB_SETV(myTable, nullVar, "4", "2")
```

DTW_TB_TABLE

AIX	HP-UX	Linux	OS/2	OS/390	OS/400	SCO	SUN	Win NT
X	X	X	X	X	X	X	X	X

Purpose

Generates an HTML table from a Net.Data table.

Format

@DTW_TB_TABLE(*table*, *options*, *collist*, *cellstyle*, *link_u*, *image_u*, *url_text*, *url_style*)

@DTW_TB_TABLE(*table*, *options*, *collist*, *cellstyle*, *link_u*, *image_u*, *url_text*)

@DTW_TB_TABLE(*table*, *options*, *collist*, *cellstyle*, *link_u*, *image_u*)

@DTW_TB_TABLE(*table*, *options*, *collist*, *cellstyle*, *link_u*)

@DTW_TB_TABLE(*table*, *options*, *collist*, *cellstyle*)

@DTW_TB_TABLE(*table*, *options*, *collist*)

@DTW_TB_TABLE(*table*, *options*)

@DTW_TB_TABLE(*table*)

Parameters

Table 162. DTW_TB_TABLE Parameters

Data Type	Parameter	Use	Description
table	<i>table</i>	IN	A macro table variable to display as an HTML table.
string	<i>options</i>	IN	The table attributes inside the TABLE tag. The default is to use no attributes. Valid values include: <ul style="list-style-type: none"> • BORDER • CELLSPACING • WIDTH
string	<i>collist</i>	IN	The column numbers in <i>table</i> to use in the HTML table. The default is to use all the columns.
string	<i>cellstyle</i>	IN	A list of HTML style elements, such as B and I, to go around text in each TD tag. The default is not to use style tags.
integer	<i>link_u</i>	IN	The column number in <i>table</i> containing URLs used to create HTML links. You must specify the column in <i>collist</i> also. The default is not to generate HTML links.
integer	<i>image_u</i>	IN	The column number in <i>table</i> containing URLs used to create inline images. You must specify the column in <i>collist</i> also. The default is not to generate image tags.
integer	<i>url_text</i>	IN	The column number in <i>table</i> containing text to display for HTML links or inline images. The default is to use the URL itself.
string	<i>url_style</i>	IN	A list of HTML style elements for the text specified in <i>url_text</i> . The default is not to generate style tags.

Return Codes

Table 163. DTW_TB_TABLE Return Codes

Return Code	Explanation
-1001	The server could not process a Net.Data request to allocate memory.
1001	An input parameter contained a NULL value.
1003	The number of parameters passed on a function call either exceeded the maximum number allowed, or was less than the minimum number required by the function.
1004	A parameter passed on a function call, required to be a Net.Data macro table variable, was of a different variable type.
1005	A parameter passed on a function call, required to be a string variable, was of a different variable type.
1007	A parameter contains a value which is not valid.
1008	A parameter is outside of table bounds.

Examples

Example 1: Generates HTML tags for a table with a border and using B (bold) and I (italics) tags

```
@DTW_TB_TABLE(Mytable,"BORDER","4 2 1","i","2","1","4","b")
```

Results:

```
<TABLE BORDER>
<TR>
<TH>TITLE
<TH>LINKURL
<TH>IMAGEURL
<TR>
<TD><i>link1text</i>
<TD><A HREF="http://www.mycompany.com/link1.html"><b>link1text</b></A>
<TD><IMG SRC="http://www.mycompany.com/images/image1.gif" ALT=""><b>link1text</b>
<TR>
<TD><i>link2text</i>
<TD><A HREF="http://www.mycompany.com/link2.html"><b>link2text</b></A>
<TD><IMG SRC="http://www.mycompany.com/images/image2.gif" ALT=""><b>link2text</b>
<TR>
<TD><i>link3text</i>
<TD><A HREF="http://www.mycompany.com/link3.html"><b>link3text</b></A>
<TD><IMG SRC="http://www.mycompany.com/images/image3.gif" ALT=""><b>link3text</b>
</TABLE>
```

DTW_TB_TEXTAREA

AIX	HP-UX	Linux	OS/2	OS/390	OS/400	SCO	SUN	Win NT
X	X	X	X	X	X	X	X	X

Purpose

Generates an HTML text area from a Net.Data table.

Format

@DTW_TB_TEXTAREA(table, name, numRows, numcols, valuecol, rows)

@DTW_TB_TEXTAREA(table, name, numRows, numcols, valuecol)

@DTW_TB_TEXTAREA(table, name, numRows, numcols)

@DTW_TB_TEXTAREA(table, name, numRows)

@DTW_TB_TEXTAREA(table, name)

Parameters

Table 164. DTW_TB_TEXTAREA Parameters

Data Type	Parameter	Use	Description
table	<i>table</i>	IN	A macro table variable to show as a TEXTAREA tag.
string	<i>name</i>	IN	The name of the text area.
integer	<i>numrows</i>	IN	The height of the text area, specified in rows. The default is the number of rows in <i>table</i> .
integer	<i>numcols</i>	IN	The width of the text area, specified in columns. The default is the length of the longest row in <i>table</i> .
integer	<i>valuecol</i>	IN	The column number in <i>table</i> whose values are shown in the text area. The default is the first column.
string	<i>rows</i>	IN	A list of rows in <i>table</i> used to generate the TEXTAREA tag. The default is to use all rows.

Return Codes

Table 165. DTW_TB_TEXTAREA Return Codes

Return Code	Explanation
-1001	The server could not process a Net.Data request to allocate memory.
1001	An input parameter contained a NULL value.
1003	The number of parameters passed on a function call either exceeded the maximum number allowed, or was less than the minimum number required by the function.
1004	A parameter passed on a function call, required to be a Net.Data macro table variable, was of a different variable type.
1005	A parameter passed on a function call, required to be a string variable, was of a different variable type.
1007	A parameter contains a value which is not valid.

Table 165. DTW_TB_TEXTAREA Return Codes (continued)

Return Code	Explanation
1008	A parameter is outside of table bounds.

Examples

Example 1: Generates HTML TEXTAREA tags and specifies which rows to include
`@DTW_TB_TEXTAREA(Mytable,"textarea5","3","70","4","1 3 4")`

Results:

```
<TEXTAREA NAME="textarea5" ROWS="3" COLS="70">  
link1text  
link3text  
link4text  
</TEXTAREA>
```

Flat File Interface Functions

The flat file interface (FFI) enables you to open, read, and manipulate data from flat file sources (text files), as well as store data in flat files. The following flat file interface built-in functions are available:

- “DTWF_APPEND” on page 254
- “DTWF_CLOSE” on page 257
- “DTWF_DELETE” on page 258
- “DTWF_OPEN” on page 263
- “DTWF_READ” on page 265
- “DTWF_REMOVE” on page 268
- “DTWF_SEARCH” on page 270
- “DTWF_UPDATE” on page 273
- “DTWF_WRITE” on page 276

The following sections discuss how to use the FFI built-in functions and access flat file sources:

- “Access to Flat File Data Sources”
- “Flat File Interface Delimiters” on page 252
- “Locking Files” on page 253

Access to Flat File Data Sources

You use the FFI_PATH path configuration statement in the Net.Data initialization file to list the directories and sub-directories that are allowed to be specified when using the FFI functions and to provide security for those files not in directories included in the path statement. The Net.Data initialization file is shipped without FFI_PATH. See *Net.Data Administration and Programming Guide* to learn how to configure the path.

The FFI_PATH uses the following syntax:

```
FFI_PATH /path1;/path2;/path3...
```

When you call the FFI language environment in a macro function, you specify the path to the flat file that the FFI function is working with, using the *filename* parameter of the FFI function. For example:

```
%DEFINE myfile = "/macros/myfile.txt" @DTWF_READ(myfile, ...)
```

The following sections discuss:

- “How Net.Data Determines the Flat File Location”
- “Flat File Configuration Rules” on page 251
- “Security Recommendations” on page 252
- “Authorization Requirement” on page 252

How Net.Data Determines the Flat File Location

Net.Data uses the information in the *filename* parameter for FFI functions to search the FFI_PATH statement in the Net.Data initialization file and determine whether to use a specified directory or the current directory.

When a file name is specified on an FFI function, Net.Data attempts to locate the file by searching each of the paths listed in FFI_PATH, starting from the first path

that is specified. Net.Data uses the first copy that it finds. If the file is not found, then Net.Data attempts to find the file in the current working directory of the process or thread in which Net.Data is running.

Example: Net.Data uses the FFI_PATH configuration statement to locate a file

The FFI_PATH contains the following directories:

```
FFI_PATH /macros;/macros/org1;/macros/org2
```

And, the file is located in both the current directory and /macros/org1. If the function call is:

```
DTWF_READ("myfile.txt")
```

Net.Data will use /macros/org1/myfile.txt.

If the DTWF_READ function is being used to read an existing file, and a file name of `myfile.txt` is specified, then Net.Data searches the directories /macros, /macros/org1 and /macros/org2 for the file, assuming that the FFI_PATH contains the list of paths specified above.

Determining the Current Directory:

The current directory for Net.Data depends on the configuration of your Web server:

- If you are using CGI, the current directory is the directory that Net.Data is running from.
- If you are using a Web server API, the current directory can vary. If the server's default request routing or resource mapping is changed, the current directory might be changed, also.

Recommendations for specifying flat file access:

Use the following recommendations to ensure that Net.Data can access flat file data sources.

- When using the DTWF_OPEN function to create flat files, ensure that you specify a directory path that is in FFI_PATH or that you know what the current directory is. If you do not specify a directory, Net.Data attempts to create the file in the current working directory.
- If you include directories in the *filename* parameter, specify the full path that matches one of the paths in FFI_PATH because Net.Data does not search sub-directories within directories specified in FFI_PATH.
- Use absolute paths for the *filename* parameter, especially if you are using a Web server API.

Flat File Configuration Rules

Use the following rules when adding or updating the FFI_PATH in the Net.Data initialization file:

- Path statements in FFI_PATH must contain valid printable characters. FFI does not allow paths that include a question mark (?) or double quotes ("").
- All directories and sub-directories that are used with the *filename* parameter in the macro must be specified in the FFI_PATH. Sub-directories of the paths listed in *filename* are not searched unless explicitly specified in FFI_PATH.
- Use absolute paths for the FFI_PATH statement.

Security Recommendations

You can specify which files FFI functions can access with the FFI_PATH statement in the Net.Data initialization file. FFI only searches the paths listed in the statement, so files in other directories are protected from unauthorized access.

For example, you can specify an FFI_PATH similar to the one below, designating directories for public or guest user IDs.

```
FFI_PATH      C:\public;E:\WWW;E:\guest;A:
```

The following list provides recommendations for making your flat files secure:

- Choose which directories are appropriate to use for flat file operations. These directories need to be added to the FFI_PATH to limit searching to those directories.
- Use care letting people perform DTWF_REMOVE or other export operations in the macro to prevent people from removing or altering files with extensions .dll and .cmd that you might have in the current directory.
- Take appropriate steps to safeguard the files on the system by using reasonable control over what macros are added to the system.
- Do not specify a path in FFI_PATH that lets anonymous FTP users write to the path. If you do, somebody can put a Net.Data macro on the system that allows actions that were not previously allowed.
- Do not add the path of the Net.Data initialization file to the FFI_PATH.

Authorization Requirement

Ensure that the user ID under which Net.Data executes has access rights to files used by the FFI built-in functions. See the section on specifying Web server access rights to Net.Data files in the configuration chapter of *Net.Data Administration and Programming Guide* for more information.

Flat File Interface Delimiters

In order to improve performance, you can keep the Net.Data tabular output from a series of SQL requests in a flat file. You can retrieve the flat file in subsequent requests, instead of re-issuing the SQL requests.

Net.Data flat files can be created from Net.Data tables and Net.Data tables can be built from flat files. In order to make the transformations between the tables and flat files, you must define the mapping between columns in a table and records in a flat file. A *delimiter* is a flag or separator that FFI uses when dividing the file into parts (such as columns of a row) according to the requested transform. Delimiters provide a method for defining how portions of records in a flat file can be separated and mapped to columns in a table, and how columns in a table can be mapped to records in a flat file.

There are two types of delimiters:

New-line character (ASCIITEXT)

Use this transformation when your table is made up of one column.

Net.Data maps each record in the corresponding flat file onto a single row in the table. In this case, the regular new-line character which separates records in the flat file is the only delimiter used.

New-line character and delimiter string (DELIMITED)

Use this transformation when your table is made up of multiple columns.

When Net.Data creates a flat file record from a row in a table, it places the delimiter string as a separator between the items. When Net.Data rebuilds a

table from a flat file, it uses the delimiter string to determine how much of each row to place in a column of the table. In this case, the regular new-line character separates the records in the flat file that correspond to rows in the table, and the delimiter string separates the items within a single record.

For read operations, the delimiter separates the contents of the file into rows and columns of a table. For write operations, the delimiter indicates the end of a value in a table row and column. Net.Data passes the delimiter to the FFI as a Net.Data macro string and does not include a null character at the end of the characters unless explicitly listed in the DELIMITER parameter.

To use the null character in the delimiter, specify the DELIMITER parameter as a slash and a zero in double quotes, "\0", instead of an empty string by using two double quotes, "". If you specify the ASCIITEXT transform, Net.Data uses the new-line character as the delimiter and ignores any requested delimiter.

Undesirable changes to a file can occur if you use a different delimiter for write operations than for read operations. Net.Data writes the file with the new delimiter.

The maximum length of a delimiter is 256 characters.

Locking Files

You can lock flat files using the DTWF_OPEN and DTWF_CLOSE functions. With these functions, Net.Data reserves a flat file so that no other applications can read or update the file.

To lock a file, use the DTWF_OPEN function. This function ensures the file is unavailable to other applications and prevents the file from changing between the time it is read and updated.

To free the file, use the DTWF_CLOSE function. This function releases the file so that other applications can read or update the file.

DTWF_APPEND

AIX	HP-UX	Linux	OS/2	OS/390	OS/400	SCO	SUN	Win NT
X			X	X	X		X	X

Purpose

Writes the contents of a Net.Data table to the end of a text file.

Format

@DTWF_APPEND(filename, transform, delimiter, table, retry, rows)

@DTWF_APPEND(filename, transform, delimiter, table, retry)

@DTWF_APPEND(filename, transform, delimiter, table)

Parameters

Table 166. DTWF_APPEND Parameters

Data Type	Parameter	Use	Description
string	<i>filename</i>	INOUT	The name of the file to which the variable's contents are being added. On successful completion of the call, this parameter returns the fully qualified file name.
string	<i>transform</i>	IN	The format of the file: <ul style="list-style-type: none"> • ASCIITEXT - writes the table to the file with a new-line character between column values and ignores the <i>delimiter</i> parameter. • DELIMITED - writes the table to the file with the delimiter specified in the <i>delimiter</i> parameter. A new-line character in a file indicates the end of a row of a Net.Data macro table for ASCIITEXT and DELIMITED transforms.
string	<i>delimiter</i>	IN	A character string to indicate the ends of values. This parameter is case sensitive. Ignored if <i>transform</i> is ASCIITEXT.
table	<i>table</i>	IN	The table variable from which the records are read. <p>For non-OS/400 users: The maximum length of a row in an FFI table is 16383 characters. This limit includes a null character for each column in the Net.Data macro table.</p>
integer	<i>retry</i>	IN	The number of times to retry if the file cannot be appended to immediately. The default is not to retry.
integer	<i>rows</i>	IN	The maximum number of rows from <i>table</i> to append. The default is to append all the rows. Specifying 0 appends all rows.

Return Codes

Table 167. DTWF_APPEND Return Codes

Return Code	Explanation
-1001	The server could not process a Net.Data request to allocate memory.
1001	An input parameter contained a NULL value.
1002	An input parameter contained a string value which consisted of the null-terminating character.
1003	The number of parameters passed on a function call either exceeded the maximum number allowed, or was less than the minimum number required by the function.
1004	A parameter passed on a function call, required to be a Net.Data macro table variable, was of a different variable type.
1005	A parameter passed on a function call, required to be a string variable, was of a different variable type.
1006	A literal string was passed on a function call for a parameter which was required to be an output parameter.
1007	A parameter contains a value which is not valid.
2000	An flat file interface built-in function could not find the specified file.
2001	A flat file interface built-in function could not open the specified file because it was in use by this or another process, and could not be shared in the specified mode.
2003	A flat file interface built-in function could not read a row of data into a table variable because the number of bytes in the row exceeded the maximum supported number of bytes.
2004	A flat file interface built-in function was attempting to find a file, but encountered a path in the FFI_PATH configuration file variable that was longer than the maximum supported number of bytes, which is 4095.
2005	A call to a system function failed.
2006	A flat file interface built-in function could not access the specified file because it was in use by this or another process and could not be shared in the specified mode.

Usage Notes

The current contents of a file affect the results of using DTWF_APPEND, especially the contents of the last column of the last row. If a new-line character follows the last column value of the last row of the file, appended data is placed in a new row. Otherwise, appended data becomes part of the last row of the file.

Examples

Example 1:

```
%DEFINE {  
  myFile = "c:/private/myfile"  
  myTable = %TABLE  
%}  
@DTWF_APPEND(myFile, "DELIMITED", " ;", myTable)
```

Example 2:

```
%DEFINE {  
    myFile = "c:/private/myfile"  
    myTable = %TABLE  
%}  
@DTWF_APPEND(myFile, "ASCIITEXT", " ;", myTable)
```

Example 3:

```
%DEFINE {  
    myFile = "c:/private/myfile"  
    myTable = %TABLE  
%}  
@DTWF_APPEND(myFile, "ASCIITEXT", " ;", myTable, "0", "10")
```

DTWF_CLOSE

AIX	HP-UX	Linux	OS/2	OS/390	OS/400	SCO	SUN	Win NT
X			X	X	X		X	X

Purpose

Closes a file opened by DTWF_OPEN.

Format

@DTWF_CLOSE(filename, retry)

@DTWF_CLOSE(filename)

Parameters

Table 168. DTWF_CLOSE Parameters

Data Type	Parameter	Use	Description
string	<i>filename</i>	INOUT	The name of the file to close. On successful completion of the call, this parameter returns the fully qualified file name.
integer	<i>retry</i>	IN	The number of times to retry if the file cannot be closed immediately. The default is not to retry.

Return Codes

Table 169. DTWF_CLOSE Return Codes

Return Code	Explanation
-1001	The server could not process a Net.Data request to allocate memory.
1001	An input parameter contained a NULL value.
1002	An input parameter contained a string value which consisted of the null-terminating character.
1003	The number of parameters passed on a function call either exceeded the maximum number allowed, or was less than the minimum number required by the function.
1005	A parameter passed on a function call, required to be a string variable, was of a different variable type.
1007	A parameter contains a value which is not valid.
2002	A flat file interface built-in function could not close the specified file because it was not opened by this macro invocation.

Examples

Example 1:

```
@DTWF_CLOSE(myFile, "5")
```

DTWF_DELETE

AIX	HP-UX	Linux	OS/2	OS/390	OS/400	SCO	SUN	Win NT
X			X	X	X		X	X

Purpose

Deletes lines from a text file.

Format

@DTWF_DELETE(filename, transform, delimiter, retry, rows, startrow)

@DTWF_DELETE(filename, transform, delimiter, retry, rows)

@DTWF_DELETE(filename, transform, delimiter, retry)

@DTWF_DELETE(filename, transform, delimiter)

Parameters

Table 170. DTW_DELETE Parameters

Data Type	Parameter	Use	Description
string	<i>filename</i>	INOUT	The name of the file whose records are to be deleted. On successful completion of the call, this parameter returns the fully qualified file name.
string	<i>transform</i>	IN	The format of the file: <ul style="list-style-type: none"> • ASCIITEXT - writes the table to the file with a new-line character between column values and ignores the <i>delimiter</i> parameter. • DELIMITED - writes the table to the file with the delimiter specified in the <i>delimiter</i> parameter. A new-line character in a file indicates the end of a row of a Net.Data macro table for ASCIITEXT and DELIMITED transforms.
string	<i>delimiter</i>	IN	A character string to indicate the ends of values. This parameter is case sensitive. Ignored if <i>transform</i> is ASCIITEXT.
integer	<i>retry</i>	IN	The number of times to retry if the records cannot be deleted immediately. The default is not to retry.
integer	<i>rows</i>	IN	The maximum number of rows to delete. The default is to delete all the rows. Specifying 0 deletes all rows.
integer	<i>startrow</i>	INOUT	The row number from which to begin deleting. A value of 1 means to begin deleting at the first row. If this value is greater than the number of rows in the file, the value is changed to the last record and returned as an error. The default is to start at 1.

Return Codes

Table 171. DTWF_DELETE Return Codes

Return Code	Explanation
-1001	The server could not process a Net.Data request to allocate memory.
1001	An input parameter contained a NULL value.
1002	An input parameter contained a string value which consisted of the null-terminating character.
1003	The number of parameters passed on a function call either exceeded the maximum number allowed, or was less than the minimum number required by the function.
1005	A parameter passed on a function call, required to be a string variable, was of a different variable type.
1006	A literal string was passed on a function call for a parameter which was required to be an output parameter.
1007	A parameter contains a value which is not valid.
2000	An flat file interface built-in function could not find the specified file.
2001	A flat file interface built-in function could not open the specified file because it was in use by this or another process, and could not be shared in the specified mode.
2003	A flat file interface built-in function could not read a row of data into a table variable because the number of bytes in the row exceeded the maximum supported number of bytes.
2004	A flat file interface built-in function was attempting to find a file, but encountered a path in the FFI_PATH configuration file variable that was longer than the maximum supported number of bytes, which is 4095.
2005	A call to a system function failed.
2006	A flat file interface built-in function could not access the specified file because it was in use by this or another process and could not be shared in the specified mode.

Examples

Example 1:

```
%DEFINE {
  myFile = "c:/private/myfile"
  myTable = %TABLE
  myWait = "5000"
  myRows = "2"
%}
@DTWF_DELETE(myFile, "Delimited", "|", myWait, myRows)
```

Example 2:

```
%DEFINE {
  myFile = "c:/private/myfile"
  myTable = %TABLE
  myStart = "1"
  myRows = "2"
%}
@DTWF_DELETE(myFile, "Asciitext", "|", "0", myRows, myStart)
```

DTWF_INSERT

AIX	HP-UX	Linux	OS/2	OS/390	OS/400	SCO	SUN	Win NT
X			X	X	X		X	X

Purpose

Inserts lines into a text file.

Format

@DTWF_INSERT(filename, transform, delimiter, table, retry, rows, startrow)

@DTWF_INSERT(filename, transform, delimiter, table, retry, rows)

@DTWF_INSERT(filename, transform, delimiter, table, retry)

@DTWF_INSERT(filename, transform, delimiter, table)

Parameters

Table 172. DTWF_INSERT Parameters

Data Type	Parameter	Use	Description
string	<i>filename</i>	INOUT	The name of the file to which records are inserted. On successful completion of the call, this parameter returns the fully qualified file name.
string	<i>transform</i>	IN	The format of the file: <ul style="list-style-type: none"> • ASCIITEXT - writes the table to the file with a new-line character between column values and ignores the <i>delimiter</i> parameter. • DELIMITED - writes the table to the file with the delimiter specified in the <i>delimiter</i> parameter. A new-line character in a file indicates the end of a row of a Net.Data macro table for ASCIITEXT and DELIMITED transforms.
string	<i>delimiter</i>	IN	A character string to indicate the ends of values. This parameter is case sensitive. Ignored if <i>transform</i> is ASCIITEXT.
table	<i>table</i>	IN	The table variable from which records are inserted into the file. <p>For non-OS/400 users: The maximum length of a row in an FFI table is 16383 characters. This limit includes a null character for each column in the Net.Data macro table.</p>
integer	<i>retry</i>	IN	The number of times to retry if the file cannot be written to immediately. The default is not to retry.
integer	<i>rows</i>	IN	The maximum number of rows to insert from <i>table</i> . The default is to insert all the rows. A value of 0 inserts all the rows.

Table 172. DTWF_INSERT Parameters (continued)

Data Type	Parameter	Use	Description
integer	<i>startrow</i>	INOUT	The line number from which to begin inserting. If the value is greater than the number of lines in the file, the value is changed to the last record and returned as an error. Specifying 0 means to insert after the beginning of the file. The default is to start at 1.

Return Codes

Table 173. DTWF_INSERT Return Codes

Return Code	Explanation
-1001	The server could not process a Net.Data request to allocate memory.
1001	An input parameter contained a NULL value.
1002	An input parameter contained a string value which consisted of the null-terminating character.
1003	The number of parameters passed on a function call either exceeded the maximum number allowed, or was less than the minimum number required by the function.
1004	A parameter passed on a function call, required to be a Net.Data macro table variable, was of a different variable type.
1005	A parameter passed on a function call, required to be a string variable, was of a different variable type.
1006	A literal string was passed on a function call for a parameter which was required to be an output parameter.
1007	A parameter contains a value which is not valid.
2000	An flat file interface built-in function could not find the specified file.
2001	A flat file interface built-in function could not open the specified file because it was in use by this or another process, and could not be shared in the specified mode.
2003	A flat file interface built-in function could not read a row of data into a table variable because the number of bytes in the row exceeded the maximum supported number of bytes.
2004	A flat file interface built-in function was attempting to find a file, but encountered a path in the FFI_PATH configuration file variable that was longer than the maximum supported number of bytes, which is 4095.
2005	A call to a system function failed.
2006	A flat file interface built-in function could not access the specified file because it was in use by this or another process and could not be shared in the specified mode.

Examples

Example 1:

```
%DEFINE {
  myFile = "c:/private/myfile"
  myTable = %TABLE
```

```
    myWait = "3000"  
%}  
@DTWF_INSERT(myFile, "Delimited", "|", myTable, myWait)
```

Example 2:

```
%DEFINE {  
    myFile = "c:/private/myfile"  
    myTable = %TABLE  
    myStart = "1"  
    myRows = "2"  
%}  
@DTWF_INSERT(myFile, "Asciitext", "|", myTable, "0", myRows, myStart)
```

DTWF_OPEN

AIX	HP-UX	Linux	OS/2	OS/390	OS/400	SCO	SUN	Win NT
X			X	X	X		X	X

Purpose

Opens a text file.

Format

@DTWF_OPEN(filename, mode, retry)

@DTWF_OPEN(filename, mode)

Parameters

Table 174. DTWF_OPEN Parameters

Data Type	Parameter	Use	Description
string	<i>filename</i>	INOUT	The name of the file to open. On successful completion of the call, this parameter returns the fully qualified file name.
string	<i>mode</i>	IN	The type of access requested: <ul style="list-style-type: none">• r - opens an existing file for reading.• w - creates a file for writing. (Destroys existing file of same name, if it exists.)• a - opens a file for appending. Net.Data creates the file if it is not found.• r+ - opens an existing file for reading and writing.• w+ - creates a file for reading and writing. (Destroys existing file of same name, if it exists.)• a+ - opens a file in append mode for reading or appending. Net.Data creates the file if it is not found.
integer	<i>retry</i>	IN	The number of times to retry if the file cannot be opened immediately. The default is not to retry.

Return Codes

Table 175. DTWF_OPEN Return Codes

Return Code	Explanation
-1001	The server could not process a Net.Data request to allocate memory.
1001	An input parameter contained a NULL value.
1002	An input parameter contained a string value which consisted of the null-terminating character.
1003	The number of parameters passed on a function call either exceeded the maximum number allowed, or was less than the minimum number required by the function.
1005	A parameter passed on a function call, required to be a string variable, was of a different variable type.

Table 175. DTWF_OPEN Return Codes (continued)

Return Code	Explanation
1006	A literal string was passed on a function call for a parameter which was required to be an output parameter.
1007	A parameter contains a value which is not valid.
2000	An flat file interface built-in function could not find the specified file.
2001	A flat file interface built-in function could not open the specified file because it was in use by this or another process, and could not be shared in the specified mode.
2006	A flat file interface built-in function could not access the specified file because it was in use by this or another process and could not be shared in the specified mode.

Usage Notes

1. When the file does not exist, an absolute path for the filename should be specified, and the directory where the file is to be created must match a directory specified in FFI_PATH. If an absolute path is not used, the file will be opened in the current working directory.
2. DTWF_OPEN keeps the file open, otherwise, the file is closed after each flat file operation.
3. Use DTWF_OPEN to reduce the number of times a file is open. If DTWF_OPEN is not used, the file is closed after each flat file operation. The file is left open until it is closed using DTWF_CLOSE or macro processing ends.

Examples

Example 1:

```
%DEFINE {
  myFile = "c:/private/myfile"
  myMode = "r+"
}%
@DTWF_OPEN(myFile, myMode, "1000")
```

DTWF_READ

AIX	HP-UX	Linux	OS/2	OS/390	OS/400	SCO	SUN	Win NT
X			X	X	X		X	X

Purpose

Reads lines from a text file into a Net.Data table.

Format

@DTWF_READ(filename, transform, delimiter, table, retry, rows, startrow, columns)

@DTWF_READ(filename, transform, delimiter, table, retry, rows, startrow)

@DTWF_READ(filename, transform, delimiter, table, retry, rows)

@DTWF_READ(filename, transform, delimiter, table, retry)

@DTWF_READ(filename, transform, delimiter, table)

Parameters

Table 176. DTWF_READ Parameters

Data Type	Parameter	Use	Description
string	<i>filename</i>	INOUT	The name of the file whose records are read into a table variable. On successful completion of the call, this parameter returns the fully qualified file name.
string	<i>transform</i>	IN	The format of the file: <ul style="list-style-type: none"> • ASCIITEXT - writes the table to the file with a new-line character between column values and ignores the <i>delimiter</i> parameter. • DELIMITED - writes the table to the file with the delimiter specified in the <i>delimiter</i> parameter. A new-line character in a file indicates the end of a row of a Net.Data macro table for ASCIITEXT and DELIMITED transforms.
string	<i>delimiter</i>	IN	A character string to indicate the ends of values. This parameter is case sensitive. Ignored if <i>transform</i> is ASCIITEXT.
table	<i>table</i>	OUT	The table variable into which the file records are read. <p>For non-OS/400 users: The maximum length of a row in an FFI table is 16383 characters. This limit includes a null character for each column in the Net.Data macro table.</p>
integer	<i>retry</i>	IN	The number of times to retry if the file cannot be read immediately. The default is not to retry.

Table 176. DTWF_READ Parameters (continued)

Data Type	Parameter	Use	Description
integer	<i>rows</i>	INOUT	The maximum number of file records to read into table. The default is to read all the records, or until the table is full. A value of 0 means to read until the end of the file. The number of rows in the resulting table is returned.
integer	<i>startrow</i>	IN	The record in the file from which to start reading. The default is to start reading at the first record.
integer	<i>columns</i>	OUT	Returns the number of columns in the table.

Return Codes

Table 177. DTWF_READ Return Codes

Return Code	Explanation
-1001	The server could not process a Net.Data request to allocate memory.
1001	An input parameter contained a NULL value.
1002	An input parameter contained a string value which consisted of the null-terminating character.
1003	The number of parameters passed on a function call either exceeded the maximum number allowed, or was less than the minimum number required by the function.
1004	A parameter passed on a function call, required to be a Net.Data macro table variable, was of a different variable type.
1005	A parameter passed on a function call, required to be a string variable, was of a different variable type.
1006	A literal string was passed on a function call for a parameter which was required to be an output parameter.
1007	A parameter contains a value which is not valid.
1010	Data was written to the table until it was full, and the remainder of the data was discarded.
2000	An flat file interface built-in function could not find the specified file.
2001	A flat file interface built-in function could not open the specified file because it was in use by this or another process, and could not be shared in the specified mode.
2003	A flat file interface built-in function could not read a row of data into a table variable because the number of bytes in the row exceeded the maximum supported number of bytes.
2004	A flat file interface built-in function was attempting to find a file, but encountered a path in the FFI_PATH configuration file variable that was longer than the maximum supported number of bytes, which is 4095.
2005	A call to a system function failed.
2006	A flat file interface built-in function could not access the specified file because it was in use by this or another process and could not be shared in the specified mode.

Examples

Example 1:

```
%DEFINE {
  myFile = "c:/private/myfile"
  myTable = %TABLE
  myWait = "1000"
%}
@DTWF_READ(myFile, "DELIMITED", ";", myTable, myWait)
```

Example 2:

```
%DEFINE {
  myFile = "c:/private/myfile"
  myTable = %TABLE
  myWait = "0"
  myRows = "0"
  myStartrow = "1"
  myColumns = ""
%}
@DTWF_READ(myFile, "DELIMITED", ";", myTable, myWait, myRows,
  myStartrow, myColumns)
```

Example 3:

```
%DEFINE {
  myFile = "c:/private/myfile"
  myTable = %TABLE
%}
@DTWF_READ(myFile, "ASCIITEXT", ";", myTable)
@DTW_TB_TABLE(myTable, "BORDER", "")
```

DTWF_REMOVE

AIX	HP-UX	Linux	OS/2	OS/390	OS/400	SCO	SUN	Win NT
X			X	X	X		X	X

Purpose

Deletes an entire file.

Format

@DTWF_REMOVE(filename, retry)

@DTWF_REMOVE(filename)

Parameters

Table 178. DTW_REMOVE Parameters

Data Type	Parameter	Use	Description
string	<i>filename</i>	INOUT	The name of the file to delete. On successful completion of the call, this parameter returns the fully qualified file name.
integer	<i>retry</i>	IN	The number of times to retry if the file cannot be deleted immediately. The default is not to retry.

Return Codes

Table 179. DTWF_REMOVE Return Codes

Return Code	Explanation
-1001	The server could not process a Net.Data request to allocate memory.
1001	An input parameter contained a NULL value.
1002	An input parameter contained a string value which consisted of the null-terminating character.
1003	The number of parameters passed on a function call either exceeded the maximum number allowed, or was less than the minimum number required by the function.
1005	A parameter passed on a function call, required to be a string variable, was of a different variable type.
1006	A literal string was passed on a function call for a parameter which was required to be an output parameter.
1007	A parameter contains a value which is not valid.
2000	An flat file interface built-in function could not find the specified file.
2006	A flat file interface built-in function could not access the specified file because it was in use by this or another process and could not be shared in the specified mode.

Examples

Example 1:

```
%DEFINE myFile = "c:/private/myfile"  
@DTWF_REMOVE(myFile)
```

Example 2:

```
%DEFINE {  
  myFile = "c:/private/myfile"  
  myWait = "2000"  
%}  
@DTWF_REMOVE(myFile, myWait)
```

DTWF_SEARCH

AIX	HP-UX	Linux	OS/2	OS/390	OS/400	SCO	SUN	Win NT
X			X	X	X		X	X

Purpose

Searches a text file for a string, returning the results into a Net.Data table.

Format

@DTWF_SEARCH(filename, transform, delimiter, table, searchFor, retry, rows, startrow)

@DTWF_SEARCH(filename, transform, delimiter, table, searchFor, retry, rows)

@DTWF_SEARCH(filename, transform, delimiter, table, searchFor, retry)

@DTWF_SEARCH(filename, transform, delimiter, table, searchFor)

Parameters

Table 180. DTWF_SEARCH Parameters

Data Type	Parameter	Use	Description
string	<i>filename</i>	INOUT	The name of the file to search. On successful completion of the call, this parameter returns the fully qualified file name.
string	<i>transform</i>	IN	The format of the file: <ul style="list-style-type: none"> • ASCIITEXT - writes the table to the file with a new-line character between column values and ignores the <i>delimiter</i> parameter. • DELIMITED - writes the table to the file with the delimiter specified in the <i>delimiter</i> parameter. A new-line character in a file indicates the end of a row of a Net.Data macro table for ASCIITEXT and DELIMITED transforms.
string	<i>delimiter</i>	IN	A character string to indicate the ends of values. This parameter is case sensitive. Ignored if <i>transform</i> is ASCIITEXT.
table	<i>table</i>	OUT	The table variable into which the search results are placed. Three columns are returned if <i>transform</i> is DELIMITED: <ul style="list-style-type: none"> • The row in which the match was found. • The column in which the match was found. • The matching column from the file. For non-OS/400 users: The maximum length of a row in an FFI table is 16383 characters. This limit includes a null character for each column in the Net.Data macro table.
string	<i>searchFor</i>	IN	The string of characters to search for.

Table 180. DTWF_SEARCH Parameters (continued)

Data Type	Parameter	Use	Description
integer	<i>retry</i>	IN	The number of times to retry if the file cannot be searched immediately. The default is not to retry.
integer	<i>rows</i>	INOUT	The maximum number of rows to read into <i>table</i> . The default is to read all the rows or until <i>table</i> is full. Specifying 0 reads to the end of the file. The number of rows in the resulting table is returned by this parameter.
integer	<i>startrow</i>	IN	The record in the file to start searching from. The default is 1, which begins the search at the first record.

Return Codes

Table 181. DTWF_SEARCH Return Codes

Return Code	Explanation
-1001	The server could not process a Net.Data request to allocate memory.
1001	An input parameter contained a NULL value.
1002	An input parameter contained a string value which consisted of the null-terminating character.
1003	The number of parameters passed on a function call either exceeded the maximum number allowed, or was less than the minimum number required by the function.
1004	A parameter passed on a function call, required to be a Net.Data macro table variable, was of a different variable type.
1005	A parameter passed on a function call, required to be a string variable, was of a different variable type.
1006	A literal string was passed on a function call for a parameter which was required to be an output parameter.
1007	A parameter contains a value which is not valid.
1010	Data was written to the table until it was full, and the remainder of the data was discarded.
2000	An flat file interface built-in function could not find the specified file.
2001	A flat file interface built-in function could not open the specified file because it was in use by this or another process, and could not be shared in the specified mode.
2003	A flat file interface built-in function could not read a row of data into a table variable because the number of bytes in the row exceeded the maximum supported number of bytes.
2004	A flat file interface built-in function was attempting to find a file, but encountered a path in the FFI_PATH configuration file variable that was longer than the maximum supported number of bytes, which is 4095.
2005	A call to a system function failed.
2006	A flat file interface built-in function could not access the specified file because it was in use by this or another process and could not be shared in the specified mode.

Usage Notes

1. The table that is returned for DTWF_SEARCH has three columns. The first two columns contain the row and the column number where the match is found; the last column contains the column value that contains the characters that are specified in the *SearchFor* parameter. For example, if the fourth row of the file contains matching characters in column three, the returned table has a row with the number 4 in the first column to indicate the row of the file that it came from; it has a number 3 in the second column to indicate which column of the file contains a match; and it has the complete column value in the third column.
2. The SearchFor parameter cannot include the contents of the *delimiter* parameter.

Examples

Example 1:

```
%DEFINE {
  myFile = "c:/private/myfile"
  myTable = %TABLE
  myWait = "1000"
  mySearch = "0123456789abcdef"
@DTWF_SEARCH(myFile, "DELIMITED", ";",
             myTable, mySearch, myWait)
```

Example 2:

```
%DEFINE {
  myFile = "c:/private/myfile"
  myTable = %TABLE
  mySearch = "answer:"
  myWait = "0"
  myRows = "0"
  myStartrow = "1"
}%
@DTWF_SEARCH(myFile, "DELIMITED", ";", myTable,
             mySearch, myWait, myRows, myStartrow)
```

DTWF_UPDATE

AIX	HP-UX	Linux	OS/2	OS/390	OS/400	SCO	SUN	Win NT
X			X	X	X		X	X

Purpose

Update lines in a text file with data from a Net.Data table.

Format

@DTWF_UPDATE(filename, transform, delimiter, table, retry, rows, startrow)

@DTWF_UPDATE(filename, transform, delimiter, table, retry, rows)

@DTWF_UPDATE(filename, transform, delimiter, table, retry)

@DTWF_UPDATE(filename, transform, delimiter, table)

Parameters

Table 182. DTWF_UPDATE Parameters

Data Type	Parameter	Use	Description
string	<i>filename</i>	INOUT	The name of the file whose records are updated from a table variable. On successful completion of the call, this parameter returns the fully qualified file name.
string	<i>transform</i>	IN	The format of the file: <ul style="list-style-type: none"> • ASCII TEXT - writes the table to the file with a new-line character between column values and ignores the <i>delimiter</i> parameter. • DELIMITED - writes the table to the file with the delimiter specified in the <i>delimiter</i> parameter. A new-line character in a file indicates the end of a row of a Net.Data macro table for ASCII TEXT and DELIMITED transforms.
string	<i>delimiter</i>	IN	A character string to indicate the ends of values. This parameter is case sensitive. Ignored if <i>transform</i> is ASCII TEXT.
table	<i>table</i>	IN	The table variable from which the file records are updated. <p>For non-OS/400 users: The maximum length of a row in an FFI table is 16383 characters. This limit includes a null character for each column in the Net.Data macro table.</p>
integer	<i>retry</i>	IN	The number of times to retry if the file cannot be written to immediately. The default is not to retry.
integer	<i>rows</i>	IN	The maximum number of records to be updated from <i>table</i> . The default is to update all the records. A value of 0 means to update all rows in the file.

Table 182. DTWF_UPDATE Parameters (continued)

Data Type	Parameter	Use	Description
integer	<i>startrow</i>	INOUT	The first file record to update. The default is 1, which means to start updating at the beginning of the file. If the value is greater than the number of records in a file, the value is changed to indicate the number of the last record in the file and an error is returned.

Return Codes

Table 183. DTWF_UPDATE Return Codes

Return Code	Explanation
-1001	The server could not process a Net.Data request to allocate memory.
1001	An input parameter contained a NULL value.
1002	An input parameter contained a string value which consisted of the null-terminating character.
1003	The number of parameters passed on a function call either exceeded the maximum number allowed, or was less than the minimum number required by the function.
1004	A parameter passed on a function call, required to be a Net.Data macro table variable, was of a different variable type.
1005	A parameter passed on a function call, required to be a string variable, was of a different variable type.
1006	A literal string was passed on a function call for a parameter which was required to be an output parameter.
1007	A parameter contains a value which is not valid.
2000	An flat file interface built-in function could not find the specified file.
2001	A flat file interface built-in function could not open the specified file because it was in use by this or another process, and could not be shared in the specified mode.
2003	A flat file interface built-in function could not read a row of data into a table variable because the number of bytes in the row exceeded the maximum supported number of bytes.
2004	A flat file interface built-in function was attempting to find a file, but encountered a path in the FFI_PATH configuration file variable that was longer than the maximum supported number of bytes, which is 4095.
2005	A call to a system function failed.
2006	A flat file interface built-in function could not access the specified file because it was in use by this or another process and could not be shared in the specified mode.

Usage Notes

If the file does not exist, an absolute path for the filename should be specified, and the directory where the file is to be created must match a directory specified in FFI_PATH. If an absolute path is not used, the file will be opened in the current working directory.

Examples

Example 1:

```
%DEFINE {
  myFile = "c:/private/myfile"
  myTable = %TABLE
  myWait = "1500"
  myRows = "2"
%}
@DTWF_UPDATE(myFile, "Delimited", "|", myTable, myWait, myRows)
```

Example 2:

```
%DEFINE {
  myFile = "c:/private/myfile"
  myTable = %TABLE
  myStart = "1"
  myRows = "2"
%}
@DTWF_UPDATE(myFile, "Asciitext", "|", myTable, "0", myRows, myStart)
```

DTWF_WRITE

AIX	HP-UX	Linux	OS/2	OS/390	OS/400	SCO	SUN	Win NT
X			X	X	X		X	X

Purpose

Writes the contents of a Net.Data table to a text file.

Format

@DTWF_WRITE(filename, transform, delimiter, table, retry, rows, startrow)

@DTWF_WRITE(filename, transform, delimiter, table, retry, rows)

@DTWF_WRITE(filename, transform, delimiter, table, retry)

@DTWF_WRITE(filename, transform, delimiter, table)

Parameters

Table 184. DTWF_WRITE Parameters

Data Type	Parameter	Use	Description
string	<i>filename</i>	INOUT	The name of the file the records of the table variable are written to. On successful completion of the call, this parameter returns the fully qualified file name.
string	<i>transform</i>	IN	The format of the file: <ul style="list-style-type: none"> • ASCIITEXT - writes the table to the file with a new-line character between column values and ignores the <i>delimiter</i> parameter. • DELIMITED - writes the table to the file with the delimiter specified in the <i>delimiter</i> parameter. A new-line character in a file indicates the end of a row of a Net.Data macro table for ASCIITEXT and DELIMITED transforms.
string	<i>delimiter</i>	IN	A character string to indicate the ends of values. This parameter is case sensitive. Ignored if <i>transform</i> is ASCIITEXT.
table	<i>table</i>	IN	The table variable used to export rows to the file. <p>For non-OS/400 users: The maximum length of a row in an FFI table is 16383 characters. This limit includes a null character for each column in the Net.Data macro table.</p>
integer	<i>retry</i>	IN	The number of times to retry if the file cannot be written to immediately. The default is to not retry.
integer	<i>rows</i>	IN	The maximum number of file records to write. The default is to write the entire table. A value of 0 means to write all records to the end of the file.

Table 184. DTWF_WRITE Parameters (continued)

Data Type	Parameter	Use	Description
integer	<i>startrow</i>	INOUT	The record number to start writing to in the file. The default is 1, which means to start at the first record. If a value beyond the end of the file is specified, the last row of the file is returned with an error.

Return Codes

Table 185. DTWF_WRITE Return Codes

Return Code	Explanation
-1001	The server could not process a Net.Data request to allocate memory.
1001	An input parameter contained a NULL value.
1002	An input parameter contained a string value which consisted of the null-terminating character.
1003	The number of parameters passed on a function call either exceeded the maximum number allowed, or was less than the minimum number required by the function.
1004	A parameter passed on a function call, required to be a Net.Data macro table variable, was of a different variable type.
1005	A parameter passed on a function call, required to be a string variable, was of a different variable type.
1006	A literal string was passed on a function call for a parameter which was required to be an output parameter.
1007	A parameter contains a value which is not valid.
2000	An flat file interface built-in function could not find the specified file.
2001	A flat file interface built-in function could not open the specified file because it was in use by this or another process, and could not be shared in the specified mode.
2003	A flat file interface built-in function could not read a row of data into a table variable because the number of bytes in the row exceeded the maximum supported number of bytes.
2004	A flat file interface built-in function was attempting to find a file, but encountered a path in the FFI_PATH configuration file variable that was longer than the maximum supported number of bytes, which is 4095.
2005	A call to a system function failed.
2006	A flat file interface built-in function could not access the specified file because it was in use by this or another process and could not be shared in the specified mode.

Usage Notes

If the file does not exist, an absolute path for the filename should be specified, and the directory where the file is to be created must match a directory specified in FFI_PATH. If an absolute path is not used, the file will be opened in the current working directory.

Examples

Example 1:

```
%DEFINE {
    myFile = "c:/private/myfile"
    myTable = %TABLE
}%
@DTWF_WRITE(myFile, "DELIMITED", ";", myTable)
```

Example 2:

```
%DEFINE {
    myFile = "c:/private/myfile"
    myTable = %TABLE
}%
@DTWF_WRITE(myFile, "ASCIITEXT", ";", myTable, "5000")
```

Example 3:

```
%DEFINE {
    myFile = "c:/private/myfile"
    myTable = %TABLE
}%
@DTWF_WRITE(myFile, "ASCIITEXT", ";", myTable, "5000", "10", "50")
```

Web Registry Functions

A Web registry is a file with a key maintained by Net.Data to allow you to add, retrieve, and delete entries easily. You can create multiple Net.Data Web registries on a single system. Each registry has a name and can contain multiple entries. Net.Data provides functions to maintain registries and the entries they contain.

- “DTWR_ADDENTRY” on page 280
- “DTWR_CLEARREG” on page 282
- “DTWR_CLOSEREG” on page 283
- “DTWR_CREATEREG” on page 284
- “DTWR_DELENTY” on page 286
- “DTWR_DELREG” on page 288
- “DTWR_LISTREG” on page 289
- “DTWR_LISTSUB” on page 291
- “DTWR_OPENREG” on page 293
- “DTWR_RTVENTRY” on page 295
- “DTWR_UPDATEENTRY” on page 297

Restrictions:

- Do not use asterisks (*) for the *registry*, *registryVariable*, and *registryData* parameters when using OS/2.
- Each parameter passed to a Web Registry function is limited to a maximum of 2048 characters.

DTWR_ADDENTRY

AIX	HP-UX	Linux	OS/2	OS/390	OS/400	SCO	SUN	Win NT
X			X		X			X

Purpose

Adds an entry to a Web registry.

Format

@DTWR_ADDENTRY(registry, registryVariable, registryData, index)

@DTWR_ADDENTRY(registry, registryVariable, registryData)

Parameters

Table 186. DTWR_ADDENTRY Parameters

Data Type	Parameter	Use	Description
string	<i>registry</i>	IN	The name of the registry to which the entry is added.
string	<i>registryVariable</i>	IN	The value of the <i>registryVariable</i> string portion of the registry entry to add.
string	<i>registryData</i>	IN	The value of the <i>registryData</i> string portion of the registry entry to add.
string	<i>index</i>	IN	The value of the index portion of the <i>registryVariable</i> string in an indexed entry to add. This parameter is optional. If specified, an indexed entry is added to the specified registry.

Return Codes

Table 187. DTWR_ADDENTRY Return Codes

Return Code	Explanation
-1001	The server could not process a Net.Data request to allocate memory.
1001	An input parameter contained a NULL value.
1002	An input parameter contained a string value which consisted of the null-terminating character.
1003	The number of parameters passed on a function call either exceeded the maximum number allowed, or was less than the minimum number required by the function.
1005	A parameter passed on a function call, required to be a string variable, was of a different variable type.
1007	A parameter contains a value which is not valid.
3003	A Web registry built-in function could not add an entry to the specified registry because the specified entry already exists.
3005	A Web registry built-in function could not use the specified registry because it cannot be found.
3006	A Web registry built-in function could not create the specified registry because a path in the registry name does not exist.

Table 187. DTWR_ADDENTRY Return Codes (continued)

Return Code	Explanation
3007	A Web registry built-in function could not complete the specified operation because the requestor does not have the proper authority to the specified registry.

Examples

Example 1:

```
@DTWR_ADDENTRY("Myregistry", "Jones", "http://Advantis.com/~Jones/webproj")
```

Example 2:

```
@DTWR_ADDENTRY("URLLIST", "SMITH", "http://www.ibm.com/",  
"WORK_URL,")
```

DTWR_CLEARREG

AIX	HP-UX	Linux	OS/2	OS/390	OS/400	SCO	SUN	Win NT
X			X		X			X

Purpose

Clears entries from a Web registry.

Format

@DTWR_CLEARREG(registry)

Parameters

Table 188. DTWR_CLEARREG Parameters

Data Type	Parameter	Use	Description
string	registry	IN	The name of the registry to clear.

Return Codes

Table 189. DTWR_CLEARREG Return Codes

Return Code	Explanation
-1001	The server could not process a Net.Data request to allocate memory.
1001	An input parameter contained a NULL value.
1002	An input parameter contained a string value which consisted of the null-terminating character.
1003	The number of parameters passed on a function call either exceeded the maximum number allowed, or was less than the minimum number required by the function.
1005	A parameter passed on a function call, required to be a string variable, was of a different variable type.
1007	A parameter contains a value which is not valid.
3005	A Web registry built-in function could not use the specified registry because it cannot be found.
3006	A Web registry built-in function could not create the specified registry because a path in the registry name does not exist.
3007	A Web registry built-in function could not complete the specified operation because the requestor does not have the proper authority to the specified registry.

Examples

Example 1:

```
@DTWR_CLEARREG("Myregistry")
```

DTWR_CLOSEREG

AIX	HP-UX	Linux	OS/2	OS/390	OS/400	SCO	SUN	Win NT
					X			

Purpose

Closes a Web registry

Format

@DTWR_CLOSEREG(registry)

Parameters

Table 190. DTWR_CLOSEREG Parameters

Data Type	Parameter	Use	Description
string	<i>registry</i>	IN	The name of the registry to close. Restriction: Do not use special characters such as the asterisk (*) and the backslash (\) in Web registry names.

Return Codes

Table 191. DTWR_CLOSEREG Return Codes

Return Code	Explanation
-1001	The server could not process a Net.Data request to allocate memory.
1001	An input parameter contained a NULL value.
1002	An input parameter contained a string value which consisted of the null-terminating character.
1003	The number of parameters passed on a function call either exceeded the maximum number allowed, or was less than the minimum number required by the function.
1005	A parameter passed on a function call, required to be a string variable, was of a different variable type.
1007	A parameter contains a value which is not valid.
3005	A Web registry built-in function could not use the specified registry because it cannot be found.

Examples

Example 1: Close a registry

```
@DTWR_CLOSEREG("/qsys.lib/mylib.lib/myreg.file")
```

DTWR_CREATEREG

AIX	HP-UX	Linux	OS/2	OS/390	OS/400	SCO	SUN	Win NT
X			X		X			X

Purpose

Creates a new Web registry.

Format

@DTWR_CREATEREG(registry, security)

@DTWR_CREATEREG(registry)

Parameters

Table 192. DTWR_CREATEREG Parameters

Data Type	Parameter	Use	Description
string	<i>registry</i>	IN	The name of the registry to create. Restriction: Do not use special characters such as the asterisk (*) and the backslash (\) in Web registry names.
string	<i>security</i>	IN	The type of security with which to create <i>registry</i> . On UNIX operating systems, the default security is the same as the directory where the registry is created. Specify security for the three security groups: user, group, and public. R gives read permission, W gives write permission, and X give execute permission. For example, to give all three groups full authority, specify *RWX, *RWX, *RWX for this parameter. This parameter is optional.

Return Codes

Table 193. DTWR_CREATEREG Return Codes

Return Code	Explanation
-1001	The server could not process a Net.Data request to allocate memory.
1001	An input parameter contained a NULL value.
1002	An input parameter contained a string value which consisted of the null-terminating character.
1003	The number of parameters passed on a function call either exceeded the maximum number allowed, or was less than the minimum number required by the function.
1005	A parameter passed on a function call, required to be a string variable, was of a different variable type.
1007	A parameter contains a value which is not valid.
3002	A Web registry built-in function could not delete the specified registry.
3006	A Web registry built-in function could not create the specified registry because a path in the registry name does not exist.

Table 193. DTWR_CREATEREG Return Codes (continued)

Return Code	Explanation
3007	A Web registry built-in function could not complete the specified operation because the requestor does not have the proper authority to the specified registry.
3008	A Web registry built-in function could not create the specified registry for unknown reasons.

Examples

Example 1:

```
@DTWR_CREATEREG("myRegistry")
```

Example 2:

```
@DTWR_CREATEREG("URLLIST", "*RWX, *RWX, *R")
```

DTWR_DELENTY

AIX	HP-UX	Linux	OS/2	OS/390	OS/400	SCO	SUN	Win NT
X			X		X			X

Purpose

Deletes an entry from a Web registry.

Format

@DTWR_DELENTY(registry, registryVariable, index)

@DTWR_DELENTY(registry, registryVariable)

Parameters

Table 194. DTWR_DELENTY Parameters

Data Type	Parameter	Use	Description
string	<i>registry</i>	IN	The name of the registry from which the entry is removed.
string	<i>registryVariable</i>	IN	The value of the <i>registryVariable</i> string portion of the entry to remove.
string	<i>index</i>	IN	The value of the index portion of the <i>registryVariable</i> string in an indexed entry. This is an optional parameter. If specified, the indexed entry is removed from the registry.

Return Codes

Table 195. DTWF_DELENTY Return Codes

Return Code	Explanation
-1001	The server could not process a Net.Data request to allocate memory.
1001	An input parameter contained a NULL value.
1002	An input parameter contained a string value which consisted of the null-terminating character.
1003	The number of parameters passed on a function call either exceeded the maximum number allowed, or was less than the minimum number required by the function.
1005	A parameter passed on a function call, required to be a string variable, was of a different variable type.
1007	A parameter contains a value which is not valid.
3004	A Web registry built-in function could not remove or retrieve an entry from the specified registry because the specified entry does not exist.
3005	A Web registry built-in function could not use the specified registry because it cannot be found.
3007	A Web registry built-in function could not complete the specified operation because the requestor does not have the proper authority to the specified registry.

Examples

Example 1:

```
@DTWR_DELENTY("Myregistry", "Jones")
```

Example 2:

```
@DTWR_DELENTY("URLLIST", "SMITH", "WORK_URL")
```

DTWR_DELREG

AIX	HP-UX	Linux	OS/2	OS/390	OS/400	SCO	SUN	Win NT
X			X		X			X

Purpose

Deletes a Web registry

Format

@DTWR_DELREG(registry)

Parameters

Table 196. DTWR_DELREG Parameters

Data Type	Parameter	Use	Description
string	registry	IN	The name of the registry to delete.

Return Codes

Table 197. DTWR_DELREG Return Codes

Return Code	Explanation
-1001	The server could not process a Net.Data request to allocate memory.
1001	An input parameter contained a NULL value.
1002	An input parameter contained a string value which consisted of the null-terminating character.
1003	The number of parameters passed on a function call either exceeded the maximum number allowed, or was less than the minimum number required by the function.
1005	A parameter passed on a function call, required to be a string variable, was of a different variable type.
1007	A parameter contains a value which is not valid.
3005	A Web registry built-in function could not use the specified registry because it cannot be found.
3007	A Web registry built-in function could not complete the specified operation because the requestor does not have the proper authority to the specified registry.

Examples

Example 1:

```
@DTWR_DELREG("Myregistry")
```

DTWR_LISTREG

AIX	HP-UX	Linux	OS/2	OS/390	OS/400	SCO	SUN	Win NT
X			X		X			X

Purpose

Lists the contents of a Web registry.

Format

@DTWR_LISTREG(registry, registryTable)

Parameters

Table 198. DTWR_LISTREG Parameters

Data Type	Parameter	Use	Description
string	<i>registry</i>	IN	The name of the registry to list.
table	<i>registryTable</i>	OUT	The name of the table variable in which the registry entries are placed.

Return Codes

Table 199. DTWR_LISTREG Return Codes

Return Code	Explanation
-1001	The server could not process a Net.Data request to allocate memory.
1001	An input parameter contained a NULL value.
1002	An input parameter contained a string value which consisted of the null-terminating character.
1003	The number of parameters passed on a function call either exceeded the maximum number allowed, or was less than the minimum number required by the function.
1004	A parameter passed on a function call, required to be a Net.Data macro table variable, was of a different variable type.
1005	A parameter passed on a function call, required to be a string variable, was of a different variable type.
1006	A literal string was passed on a function call for a parameter which was required to be an output parameter.
1007	A parameter contains a value which is not valid.
3005	A Web registry built-in function could not use the specified registry because it cannot be found.
3007	A Web registry built-in function could not complete the specified operation because the requestor does not have the proper authority to the specified registry.

Usage Notes

DTWR_LISTREG returns information about the registry entries in an OUT table variable passed by the user. The table variable is defined in the user macro before being passed as a parameter to the FUNCTION block for the LISTREG registry operation.

If the user defined the table variable using the ALL option for the maximum number of rows for the table, this operation lists all available registry entries in the table, one for each table row. On the other hand if the user specified a value X for the maximum number of table rows, then if there are more than X entries in the specified registry only the first X entries are listed and an error code is sent back to indicate that only a partial listing could be done because not enough table rows were available to list additional entries. All registry entries are listed if the value X exceeds the number of available entries in the specified registry.

There are always 2 columns in the table. The Column headers for the table are set to REGISTRY_VARIABLE and REGISTRY_DATA.

Examples

Example 1:

```
%DEFINE RegistryTable = %TABLE(ALL)

@DTWR_LISTREG("URLLIST", RegistryTable)
```

DTWR_LISTSUB

AIX	HP-UX	Linux	OS/2	OS/390	OS/400	SCO	SUN	Win NT
								X

Purpose

Lists immediate subkey entries in a Web registry.

Format

@DTWR_LISTSUB(registry, registryTable)

Parameters

Table 200. DTWR_LISTSUB Parameters

Data Type	Parameter	Use	Description
string	registry	IN	The name of the registry to list.
table	registryTable	OUT	The name of the table variable in which the registry entries are placed.

Return Codes

Table 201. DTWR_LISTSUB Return Codes

Return Code	Explanation
-1001	The server could not process a Net.Data request to allocate memory.
1001	An input parameter contained a NULL value.
1002	An input parameter contained a string value which consisted of the null-terminating character.
1003	The number of parameters passed on a function call either exceeded the maximum number allowed, or was less than the minimum number required by the function.
1005	A parameter passed on a function call, required to be a string variable, was of a different variable type.
1006	A literal string was passed on a function call for a parameter which was required to be an output parameter.
1007	A parameter contains a value which is not valid.
3005	A Web registry built-in function could not use the specified registry because it cannot be found.
3007	A Web registry built-in function could not complete the specified operation because the requestor does not have the proper authority to the specified registry.

Usage Notes

1. DTWR_LISTSUB returns information about the registry entries in an OUT table parameter passed by the user. The table variable is defined in the macro before being passed as a parameter to the LISTSUB registry operation.

If the user has defined the table variable using the ALL option for the maximum number of rows for the table, this operation lists all available registry entries in the table, one for each table row. On the other hand, if the user specified a value X for the maximum number of table rows then if there are more than X entries in the specified registry only the first X entries are listed and an error

code is sent back to indicate that only a partial listing could be done because not enough table rows are available to list additional entries. All registry entries are listed if the value X exceeds the number of available entries in the specified registry. The number of columns in the table is always one.

The column header for the table is set to "REGISTRY_SUBKEY".

2. This function is only valid on operating system that are compatible Windows 95 System Registries.

Examples

Example 1:

```
%DEFINE RegistryTable = %TABLE(ALL)
```

```
@DTWR_LISTSUB("URLLIST", RegistryTable)
```

DTWR_OPENREG

AIX	HP-UX	Linux	OS/2	OS/390	OS/400	SCO	SUN	Win NT
					X			

Purpose

Opens a Web registry.

Format

@DTWR_OPENREG(registry, commit)

@DTWR_OPENREG(registry)

Parameters

Table 202. DTWR_OPENREG Parameters

Data Type	Parameter	Use	Description
string	<i>registry</i>	IN	The name of the registry to open.
string	<i>commit</i>	IN	<p>A single symbol or literal string specifying whether the registry is opened under commitment control or not. The possible values are:</p> <p>Y Open the registry under commitment control.</p> <p>N Do not open the registry under commitment control.</p> <p>The default is N</p>

Return Codes

Table 203. DTWR_OPENREG Return Codes

Return Code	Explanation
-1001	The server could not process a Net.Data request to allocate memory.
1001	An input parameter contained a NULL value.
1002	An input parameter contained a string value which consisted of the null-terminating character.
1003	The number of parameters passed on a function call either exceeded the maximum number allowed, or was less than the minimum number required by the function.
1005	A parameter passed on a function call, required to be a string variable, was of a different variable type.
1007	A parameter contains a value which is not valid.
3005	A Web registry built-in function could not use the specified registry because it cannot be found.
3007	A Web registry built-in function could not complete the specified operation because the requestor does not have the proper authority to the specified registry.

Examples

Example 1: Open the registry under commitment control

```
@DTWR_OPENREG("/qsys.lib/mylib.lib/myreg.file", "Y")
```

DTWR_RTENTRY

AIX	HP-UX	Linux	OS/2	OS/390	OS/400	SCO	SUN	Win NT
X			X		X			X

Purpose

Retrieves a registry string value from a Web registry.

Format

@DTWR_RTENTRY(registry, registryVariable, registryData, index)

@DTWR_RTENTRY(registry, registryVariable, registryData)

@DTWR_rRTENTRY(registry, registryVariable, index)

@DTWR_rRTENTRY(registry, registryVariable)

Parameters

Table 204. DTWR_RTENTRY Parameters

Data Type	Parameter	Use	Description
string	<i>registry</i>	IN	The name of the registry with entries to retrieve.
string	<i>registryVariable</i>	IN	The value of the <i>registryVariable</i> string portion of the registry entry whose <i>registryData</i> string is retrieved.
string	<i>registryData</i>	OUT	Returns the value of the <i>registryData</i> string portion of the registry entry that matches the <i>registryVariable</i> .
string	<i>index</i>	IN	The value of the index portion of the <i>registryVariable</i> string in an indexed entry whose <i>registryData</i> string is returned. This is an optional parameter. If specified, the <i>registryData</i> string of the indexed entry is returned.

Return Codes

Table 205. DTWR_RTENTRY Return Codes

Return Code	Explanation
-1001	The server could not process a Net.Data request to allocate memory.
1001	An input parameter contained a NULL value.
1002	An input parameter contained a string value which consisted of the null-terminating character.
1003	The number of parameters passed on a function call either exceeded the maximum number allowed, or was less than the minimum number required by the function.
1005	A parameter passed on a function call, required to be a string variable, was of a different variable type.
1006	A literal string was passed on a function call for a parameter which was required to be an output parameter.
1007	A parameter contains a value which is not valid.

Table 205. DTWR_RTVENTRY Return Codes (continued)

Return Code	Explanation
3004	A Web registry built-in function could not remove or retrieve an entry from the specified registry because the specified entry does not exist.
3005	A Web registry built-in function could not use the specified registry because it cannot be found.
3007	A Web registry built-in function could not complete the specified operation because the requestor does not have the proper authority to the specified registry.

Examples

Example 1:

```
%DEFINE RegistryData = ""  
@DTWR_RTVENTRY("Myregistry", "Jones", RegistryData)
```

Example 2:

```
@DTWR_RTVENTRY("URLLIST", "SMITH", RegistryData, "WORK_URL")
```

Example 3:

```
@DTWR_rRTVENTRY("Myregistry", "Jones")
```

Example 4:

```
@DTWR_rRTVENTRY("URLLIST", "SMITH", "WORK_URL")
```

DTWR_UPDATEENTRY

AIX	HP-UX	Linux	OS/2	OS/390	OS/400	SCO	SUN	Win NT
X			X		X			X

Purpose

Updates a registry string value in the Web registry.

Format

@DTWR_UPDATEENTRY(registry, registryVariable, newData, index)

@DTWR_UPDATEENTRY(registry, registryVariable, newData)

Parameters

Table 206. DTWR_UPDATEENTRY Parameters

Data Type	Parameter	Use	Description
string	<i>registry</i>	IN	The name of the registry with the entry to update.
string	<i>registryVariable</i>	IN	The value of the <i>registryVariable</i> string portion of the registry entry to update.
string	<i>newData</i>	IN	The new value for the <i>registryData</i> string portion of the registry entry to update.
string	<i>index</i>	IN	The value of the index portion of the <i>registryVariable</i> string in an indexed entry to update. This is an optional parameter. If specified, the indexed entry is updated.

Return Codes

Table 207. DTWR_UPDATEENTRY Return Codes

Return Code	Explanation
-1001	The server could not process a Net.Data request to allocate memory.
1001	An input parameter contained a NULL value.
1002	An input parameter contained a string value which consisted of the null-terminating character.
1003	The number of parameters passed on a function call either exceeded the maximum number allowed, or was less than the minimum number required by the function.
1005	A parameter passed on a function call, required to be a string variable, was of a different variable type.
1007	A parameter contains a value which is not valid.
3003	A Web registry built-in function could not add an entry to the specified registry because the specified entry already exists.
3004	A Web registry built-in function could not remove or retrieve an entry from the specified registry because the specified entry does not exist.
3005	A Web registry built-in function could not use the specified registry because it cannot be found.

Table 207. DTWR_UPDATEENTRY Return Codes (continued)

Return Code	Explanation
3007	A Web registry built-in function could not complete the specified operation because the requestor does not have the proper authority to the specified registry.

Usage Notes

The registry entry name corresponding to the value cannot be changed.

Examples

Example 1:

```
@DTWR_UPDATEENTRY("Myregistry", "Jones", "http://advantis.com/~Jones/personal")
```

Example 2:

```
@DTWR_UPDATEENTRY("URLLIST", "SMITH", "http://www.ibm.com/software/personal", "WORK_URL")
```

Persistent Macro Functions

The persistent macro functions support transaction processing in Net.Data by helping you define which macro blocks are persistent within a single transaction. Use these functions to define the start and end of a transaction, which HTML blocks are persistent throughout the transaction, the scope of the variables within the transaction, and whether to commit or rollback changes within the transaction.

- “DTW_ACCEPT” on page 300
- “DTW_COMMIT” on page 302
- “DTW_ROLLBACK” on page 303
- “DTW_RTVHANDLE” on page 304
- “DTW_STATIC” on page 305
- “DTW_TERMINATE” on page 307

DTW_ACCEPT

AIX	HP-UX	Linux	OS/2	OS/390	OS/400	SCO	SUN	Win NT
					X			

Purpose

Defines the transaction handle used to invoke a persistent macro.

Format

@DTW_ACCEPT(handle, timeout)

@DTW_ACCEPT(handle)

Parameters

Table 208. DTW_ACCEPT Parameters

Data Type	Parameter	Use	Description
string	<i>handle</i>	IN	A variable or literal string specifying a transaction handle to be used in URLs for subsequent macro invocations in this persistent transaction.
integer	<i>timeout</i>	IN	A variable or literal string specifying an amount of time in seconds for the job servicing this port to wait for a response. This value overrides any timeout value specified on the DTW_STATIC() function.

Return Codes

Table 209. DTW_ACCEPT Return Codes

Return Code	Explanation
-1001	The server could not process a Net.Data request to allocate memory.
1001	An input parameter contained a NULL value.
1003	The number of parameters passed on a function call either exceeded the maximum number allowed, or was less than the minimum number required by the function.
1005	A parameter passed on a function call, required to be a string variable, was of a different variable type.
1007	A parameter contains a value which is not valid.
8200	Macro persistence is not enabled.
8201	A persistent built-in function was called out of sequence.

Usage Notes

1. Net.Data requires that the transaction handle be included in the URL that invokes the macro as a response from the Web browser. When a request comes in to the Web server, the server uses the transaction handle to route the request to the CGI process that is processing the transaction.

The transaction handle must be called at the start of each HTML block in the macro until the last logical block, which contains a call to DTW_TERMINATE(). If either a call to DTW_ACCEPT() or DTW_TERMINATE() is not found before any text is output to the browser, a Net.Data error occurs.

2. You can specify a timeout value for this page that overrides the timeout value specified on the @DTW_STATIC() function. The Web server waits for specified amount of time (in seconds) for the user to respond to this request.
3. If this function is called when the macro is not in a persistent state, a Net.Data error occurs.
4. The URLs containing the transaction handle can be coded as actions on form push buttons or as hypertext links on the page presented to the browser.

Examples

Example 1:

```
%DEFINE handle = ""  
@DTW_RTVHANLDE(handle)
```

```
%HTML(REPORT) {  
@DTW_ACCEPT(handle)
```

```
...  
%}
```

DTW_COMMIT

AIX	HP-UX	Linux	OS/2	OS/390	OS/400	SCO	SUN	Win NT
					X			

Purpose

Makes permanent any pending changes made to resources under commitment control since the last commitment boundary and establishes a new commitment boundary.

Format

@DTW_COMMIT()

Parameters

None.

Return Codes

Table 210. DTW_COMMIT Return Codes

Return Code	Explanation
1003	The number of parameters passed on a function call either exceeded the maximum number allowed, or was less than the minimum number required by the function.

Examples

Example 1: Specifies a commit

```
@DTW_COMMIT()  
%HTML(report){  
%}
```

DTW_ROLLBACK

AIX	HP-UX	Linux	OS/2	OS/390	OS/400	SCO	SUN	Win NT
					X			

Purpose

Reestablishes the last commitment boundary as the current commitment boundary. All changes to resources under commitment control for the process that Net.Data is running under made since the last commitment boundary are backed out.

Format

@DTW_ROLLBACK()

Parameters

None.

Return Codes

Table 211. DTW_ROLLBACK Return Codes

Return Code	Explanation
1003	The number of parameters passed on a function call either exceeded the maximum number allowed, or was less than the minimum number required by the function.

Examples

Example 1: Specifies a rollback

```
@DTW_ROLLBACK()  
%HTML(report){  
%}
```

DTW_RTVHANDLE

AIX	HP-UX	Linux	OS/2	OS/390	OS/400	SCO	SUN	Win NT
					X			

Purpose

Generates and returns a transaction handle that is unique to this macro across separate invocations and is calculated based on a combination of thread information, timestamp, and current user.

Format

@DTW_RTVHANDLE(handle)

Parameters

Table 212. DTW_RTVHANDLE Parameters

Data Type	Parameter	Use	Description
string	<i>handle</i>	OUT	A variable that contains a unique transaction handle for the current persistent macro.

Return Codes

Table 213. DTW_RTVHANDLE Return Codes

Return Code	Explanation
-1001	The server could not process a Net.Data request to allocate memory.
1003	The number of parameters passed on a function call either exceeded the maximum number allowed, or was less than the minimum number required by the function.
1005	A parameter passed on a function call, required to be a string variable, was of a different variable type.
1006	A literal string was passed on a function call for a parameter which was required to be an output parameter.

Usage Notes

The transaction handle can be used to ensure that URLs specified as part of a persistent transaction are unique to the HTTP server and can be securely identified as valid requests.

Examples

Example 1: Defines the `handle` variable used to retrieve the transaction handle

```
%DEFINE handle = ""  
@DTW_RTVHANDLE(handle)
```

DTW_STATIC

AIX	HP-UX	Linux	OS/2	OS/390	OS/400	SCO	SUN	Win NT
					X			

Purpose

Indicates that the entire macro is persistent.

Format

@DTW_STATIC(timeout)

@DTW_STATIC()

Parameters

Table 214. DTW_STATIC Parameters

Data Type	Parameter	Use	Description
integer	<i>timeout</i>	IN	A variable or literal string that specifies an amount of time, in seconds, that the process handling this transaction should wait for a response.

Return Codes

Table 215. DTW_STATIC Return Codes

Return Code	Explanation
-1001	The server could not process a Net.Data request to allocate memory.
1001	An input parameter contained a NULL value.
1003	The number of parameters passed on a function call either exceeded the maximum number allowed, or was less than the minimum number required by the function.
1005	A parameter passed on a function call, required to be a string variable, was of a different variable type.
1007	A parameter contains a value which is not valid.
8202	Persistence could not be enabled.

Usage Notes

1. DTW_STATIC should be the first statement in the macro. All variables defined in the macro after this function call will be persistent across multiple macro invocations unless specified otherwise and until DTW_TERMINATE() is called or the process is ended.
2. A timeout value, in seconds, can be specified on the function call to indicate the amount of time the process Net.Data is running under waits for a response from the browser. If the timeout value expires, the process ends, and all changes to resources under commitment control since the last commitment boundary are rolled back.
3. If a timeout value is specified on a subsequent @DTW_ACCEPT() call, Net.Data overrides this value with the value in the subsequent call. If a timeout value is not specified on this call or a subsequent @DTW_ACCEPT() call, the Web server default timeout value is used.

Examples

Example 1: A call to `DTW_STATIC()` specifying a timeout value of 60 seconds.

```
@DTW_STATIC("60")
```

DTW_TERMINATE

AIX	HP-UX	Linux	OS/2	OS/390	OS/400	SCO	SUN	Win NT
					X			

Purpose

Ends a persistent transaction. All changes to resources under commitment control since the last commitment boundary are made permanent.

Format

@DTW_TERMINATE()

Parameters

None

Return Codes

Table 216. DTW_TERMINATE Return Codes

Return Code	Explanation
-1001	The server could not process a Net.Data request to allocate memory.
1003	The number of parameters passed on a function call either exceeded the maximum number allowed, or was less than the minimum number required by the function.
8200	Macro persistence is not enabled.
8201	A persistent built-in function was called out of sequence.

Usage Notes

1. The DTW_TERMINATE function is called at the start of the logical last HTML block of the persistent transaction before any text is output to the browser. If any text output appears before the function, within the block, a Net.Data error will occur. Note that there could be more than one logical last HTML block depending on how the application is written.
2. If this function is called when the macro is not in a persistent state, a Net.Data error will occur.

Examples

Example 1: Terminates the persistent transaction

```
%HTML(QUIT) {  
@DTW_TERMINATE()  
...  
%}
```

Appendix A. Net.Data Technical Library

The Net.Data Technical Library is available from the Net.Data Web site at <http://www.ibm.com/software/data/net.data/library.html>

Document	Description
<ul style="list-style-type: none">• <i>Net.Data Administration and Programming Guide for OS/390</i>• <i>Net.Data Administration and Programming Guide for OS/2, Windows NT, and UNIX</i>• <i>Net.Data Administration and Programming Guide for OS/400</i>	Contains conceptual and task information about installing, configuring, and invoking Net.Data. Also describes how to write Net.Data macros, use Net.Data performance techniques, use Net.Data language environments, manage connections, and use Net.Data logging and traces for trouble shooting and performance tuning.
<i>Net.Data Reference</i>	Describes the Net.Data macro language, variables, and built-in functions.
<i>Net.Data Language Environment Interface Reference</i>	Describes the Net.Data language environment interface.
<i>Net.Data Messages and Codes Reference</i>	Lists Net.Data error messages and return codes.

Appendix B. DB2 WWW Connection

If you have DB2 WWW Connection, you can run your existing applications with Net.Data. We recommend updating your applications to take advantage of Net.Data Version 2 features.

The DB2 WWW language constructs are:

- "EXEC_SQL"
- "HTML_INPUT"
- "HTML_REPORT"
- "SQL"
- "SQL_MESSAGE" on page 312
- "SQL_REPORT" on page 312
- "SQL_CODE" on page 312

EXEC_SQL

This language construct calls an SQL block. We recommend calling SQL statements as functions instead. See "FUNCTION Block" on page 16 for more information.

HTML_INPUT

This language construct is the same as an HTML block named INPUT. See "HTML Block" on page 26 for more information.

HTML_REPORT

This language construct is the same as an HTML block named REPORT. See "HTML Block" on page 26 for more information.

SQL

This language construct is equivalent to a function called with FUNCTION(DTW_SQL) in Net.Data.

It can contain SQL_REPORT and SQL_MESSAGE statements, which are also from DB2 WWW Connection. DB2 WWW Connection does not support named %SQL blocks.

Examples:

Example 1: A DB2 WWW Connection macro

```
%SQL{
UPDATE $(dbtb1) SET URL='$(URL)' WHERE ID=$(ID)
%SQL_MESSAGE{
100: "<B>The selected URL no longer exists in the table</B>." : continue
%}
%}

%HTML_INPUT{
<HTML>
...
%EXEC_SQL
```

```

</HTML>
%}

%HTML_REPORT{
<HTML>
...
</HTML>
%}

```

Example 1: An equivalent Net.Data macro

```

%FUNCTION(DTW_SQL) URLquery(){
UPDATE $(dbtbl) SET URL='$(URL)' WHERE ID=$(ID)
%MESSAGE{
100: "<B>The selected URL no longer exists in the table</B>." : continue
%}
%}

%HTML(INPUT){
<HTML>
...
@URLquery
</HTML>
%}

%HTML(REPORT){
<HTML>
...
</HTML>
%}

```

SQL_MESSAGE

This language construct is equivalent to the Net.Data MESSAGE statement. See "MESSAGE Block" on page 44 for an example.

SQL_REPORT

This language construct is equivalent to the Net.Data REPORT statement. See "REPORT Block" on page 48 for an example.

SQL_CODE

This language construct is from DB2 WWW connection and supported by Net.Data for compatibility. It is equivalent to "RETURN_CODE" on page 114.

Appendix C. Net.Data Operating System Reference

Not all Net.Data features are supported on each operating system. This section shows which features are supported for your operating system. An **X** indicates the feature is supported.

Table 217. Net.Data Language Environments

Language Environment	AIX	HP	LINUX	OS/2	OS/390	OS/400	SCO	SUN	Win NT
Direct Call						X			
Flat File Interface	X			X	X	X	X	X	X
IMS Web	X			X				X	X
Java Applets	X	X	X	X	X	X	X	X	X
Java Applications	X			X		X		X	X
ODBC	X	X		X	X		X	X	X
Oracle	X								X
Perl	X	X	X	X	X			X	X
REXX	X		X	X	X	X	X	X	X
SQL	X	X	X	X	X	X	X	X	X
Sybase	X								X
System	X	X	X	X	X	X	X	X	X
Web Registry	X			X		X			X

Table 218. Net.Data Configuration Variables

Configuration Variable	AIX	HP	LINUX	OS/2	OS/390	OS/400	SCO	SUN	Win NT
DB2INSTANCE	X	X	X	X			X	X	X
DB2MSG					X				
DB2PLAN					X				
DB2SSID					X				
DefaultDBCp					X				
DSNAOINI					X				
DTW_CACHE_HOST	X								X
DTW_CACHE_MACRO					X				
DTW_CACHE_MANAGEMENT_INTERVAL					X				
DTW_CACHE_PAGE					X				
DTW_CACHE_PORT	X								X
DTW_CM_PORT	X	X		X					X
DTW_DEFAULT_ERROR_MESSAGE					X				
DTW_DIRECT_REQUEST	X	X		X	X		X	X	X
DTW_DO_NOT_CACHE_MACRO					X				
DTW_ERROR_LOG_DIR					X				
DTW_ERROR_LOG_LEVEL					X				
DTW_INST_DIR	X		X	X			X	X	X
DTW_LOB_LIFETIME					X				

Table 218. Net.Data Configuration Variables (continued)

Configuration Variable	AIX	HP	LINUX	OS/2	OS/390	OS/400	SCO	SUN	Win NT
DTW_LOG_DIR	X	X	X	X			X	X	X
DTW_LOG_LEVEL	X	X	X	X			X	X	X
DTW_MBMODE	X	X	X	X	X		X	X	X
DTW_REMOVE_WS					X				
DTW_SHOWSQL	X	X	X	X	X	X	X	X	X
DTW_SMTP_CHARSET						X			
DTW_SMTP_SERVER	X	X	X	X	X	X	X	X	X
DTW_SQL_ISOLATION						X			
DTW_SQL_NAMING_MODE						X			
DTW_TRACE_LOG_DIR					X				
DTW_TRACE_LOG_LEVEL					X				
DTW_UNICODE	X	X		X			X	X	X
DTW_VARIABLE_SCOPE	X	X		X			X	X	X

Table 219. Net.Data Variables

Variable	AIX	HP	LINUX	OS/2	OS/390	OS/400	SCO	SUN	Win NT
ALIGN	X	X	X	X	X	X	X	X	X
DATABASE	X	X	X	X		X	X	X	X
DB_CASE	X	X	X	X	X	X	X	X	X
DB2PLAN					X				
DB2SSID					X				
DTW_APPLET_ALTTEXT	X	X	X	X	X	X	X	X	X
DTW_CURRENT_FILENAME	X	X	X	X	X	X	X	X	X
DTW_CURRENT_LAST_MODIFIED	X	X	X	X	X	X	X	X	X
DTW_DEFAULT_MESSAGE	X	X	X	X	X	X	X	X	X
DTW_DEFAULT_REPORT	X	X	X	X	X	X	X	X	X
DTW_EDIT_CODES						X			
DTW_HTML_TABLE	X	X	X	X	X	X	X	X	X
DTW_LOG_LEVEL	X	X	X	X			X	X	X
DTW_MACRO_FILENAME	X	X	X	X	X	X	X	X	X
DTW_MACRO_LAST_MODIFIED	X	X	X	X	X	X	X	X	X
DTW_MBMODE	X	X	X	X	X		X	X	X
DTW_MP_PATH	X	X	X	X	X	X	X	X	X
DTW_MP_VERSION	X	X	X	X	X	X	X	X	X
DTW_PAD_PGM_PARMS						X			
DTW_PRINT_HEADER	X	X	X	X	X	X	X	X	X
DTW_REMOVE_WS	X	X	X	X	X	X	X	X	X
DTW_SAVE_TABLE_IN	X	X	X	X	X	X	X	X	X
DTW_SET_TOTAL_ROWS	X	X	X	X	X	X	X	X	X
LOCATION					X				

Table 219. Net.Data Variables (continued)

Variable	AIX	HP	LINUX	OS/2	OS/390	OS/400	SCO	SUN	Win NT
LOGIN	X	X	X	X		X	X	X	X
Nn	X	X	X	X	X	X	X	X	X
NLIST	X	X	X	X	X	X	X	X	X
NULL_RPT_FIELD						X			
NUM_COLUMNS	X	X	X	X	X	X	X	X	X
NUM_ROWS						X			
PASSWORD	X	X	X	X		X	X	X	X
RETURN_CODE	X	X	X	X	X	X	X	X	X
ROW_NUM	X	X	X	X	X	X	X	X	X
RPT_MAX_ROWS	X	X	X	X	X	X	X	X	X
SHOWSQL	X	X	X	X	X	X	X	X	X
SQL_CODE	X	X	X	X	X	X	X	X	X
SQL_STATE	X	X	X	X	X	X	X	X	X
START_ROW_NUM	X	X	X	X	X	X	X	X	X
TOTAL_ROWS	X	X	X	X	X	X	X	X	X
TRANSACTION_SCOPE	X	X	X	X	X	X	X	X	X
V_columnName	X	X	X	X	X	X	X	X	X
VLIST	X	X	X	X	X	X	X	X	X
Vn	X	X	X	X	X	X	X	X	X

Table 220. Net.Data Functions

Function	AIX	HP	LINUX	OS/2	OS/390	OS/400	SCO	SUN	Win NT
DTW_ACCEPT						X			
DTW_ADD	X	X	X	X	X	X	X	X	X
DTW_ADDQUOTE	X	X	X	X	X	X	X	X	X
DTW_ASSIGN	X	X	X	X	X	X	X	X	X
DTW_CACHE_PAGE	X								X
DTW_COMMIT						X			
DTW_CHARTOHEX					X	X			
DTW_CONCAT	X	X	X	X	X	X	X	X	X
DTW_DATE	X	X	X	X	X	X	X	X	X
DTW_DELSTR	X	X	X	X	X	X	X	X	X
DTW_DELWORD	X	X	X	X	X	X	X	X	X
DTW_DIVIDE	X	X	X	X	X	X	X	X	X
DTW_DIVREM	X	X	X	X	X	X	X	X	X
DTW_EXIT	X	X	X	X	X	X	X	X	X
DTW_FORMAT	X	X	X	X	X	X	X	X	X
DTW_GETCOOKIE	X	X	X	X	X	X	X	X	X
DTW_GETENV	X	X	X	X	X	X	X	X	X
DTW_GETINIDATA	X	X	X	X	X	X	X	X	X

Table 220. Net.Data Functions (continued)

Function	AIX	HP	LINUX	OS/2	OS/390	OS/400	SCO	SUN	Win NT
DTW_HEXTOCHAR					X	X			
DTW_HTMLENCODE	X	X	X	X	X	X	X	X	X
DTW_INSERT	X	X	X	X	X	X	X	X	X
DTW_INTDIV	X	X	X	X	X	X	X	X	X
DTW_LASTPOS	X	X	X	X	X	X	X	X	X
DTW_LENGTH	X	X	X	X	X	X	X	X	X
DTW_LOWERCASE	X	X	X	X	X	X	X	X	X
DTW_MULTIPLY	X	X	X	X	X	X	X	X	X
DTW_POS	X	X	X	X	X	X	X	X	X
DTW_POWER	X	X	X	X	X	X	X	X	X
DTW_QHTMLENCODE	X	X	X	X	X	X	X	X	X
DTW_REPLACE					X	X			
DTW_REVERSE	X	X	X	X	X	X	X	X	X
DTW_ROLLBACK						X			
DTW_RVTHANDLE						X			
DTW_SENDMAIL	X	X	X	X	X	X	X	X	X
DTW_SETCOOKIE	X	X	X	X	X	X	X	X	X
DTW_SETENV	X	X	X	X	X	X	X	X	X
DTW_STATIC						X			
DTW_STRIP	X	X	X	X	X	X	X	X	X
DTW_SUBSTR	X	X	X	X	X	X	X	X	X
DTW_SUBTRACT	X	X	X	X	X	X	X	X	X
DTW_SUBWORD	X	X	X	X	X	X	X	X	X
DTW_TB_APPENDROW	X	X		X	X	X	X	X	X
DTW_TB_COLS	X	X	X	X	X	X	X	X	X
DTW_TB_DELETEROW	X	X		X	X	X	X	X	X
DTW_TB_DELETETECOL	X	X		X	X	X	X	X	X
DTW_TB_DLIST	X	X	X	X	X	X	X	X	X
DTW_TB_DUMPH	X	X	X	X	X	X	X	X	X
DTW_TB_DUMPV	X	X	X	X	X	X	X	X	X
DTW_TB_GETN	X	X	X	X	X	X	X	X	X
DTW_TB_GETV	X	X	X	X	X	X	X	X	X
DTW_TB_HTMLENCODE	X	X	X	X	X	X	X	X	X
DTW_TB_INPUT_CHECKBOX	X	X	X	X	X	X	X	X	X
DTW_TB_INPUT_RADIO	X	X	X	X	X	X	X	X	X
DTW_TB_INPUT_TEXT	X	X	X	X	X	X	X	X	X
DTW_TB_INSERTCOL	X	X		X	X	X	X	X	X
DTW_TB_INSERTROW	X	X		X	X	X	X	X	X
DTW_TB_LIST	X	X	X	X	X	X	X	X	X
DTW_TB_MAXROWS						X			

Table 220. Net.Data Functions (continued)

Function	AIX	HP	LINUX	OS/2	OS/390	OS/400	SCO	SUN	Win NT
DTW_TB_QUERYCOLNONJ	X	X		X	X	X	X	X	X
DTW_TB_ROWS	X	X	X	X	X	X	X	X	X
DTW_TB_SELECT	X	X	X	X	X	X	X	X	X
DTW_TB_SETCOLS	X	X		X	X	X	X	X	X
DTW_TB_SETN	X	X		X	X	X	X	X	X
DTW_TB_SETV	X	X		X	X	X	X	X	X
DTW_TB_TABLE	X	X	X	X	X	X	X	X	X
DTW_TB_TEXTAREA	X	X	X	X	X	X	X	X	X
DTW_TERMINATE						X			
DTW_TIME	X	X	X	X	X	X	X	X	X
DTW_TRANSLATE	X	X	X	X	X	X	X	X	X
DTW_UPPERCASE	X	X	X	X	X	X	X	X	X
DTW_URLESCSEQ	X	X	X	X	X	X	X	X	X
DTW_WORD	X	X	X	X	X	X	X	X	X
DTW_WORDINDEX	X	X	X	X	X	X	X	X	X
DTW_WORDLENGTH	X	X	X	X	X	X	X	X	X
DTW_WORDPOS	X	X	X	X	X	X	X	X	X
DTW_WORDS	X	X	X	X	X	X	X	X	X
DTWF_APPEND	X			X	X	X		X	X
DTWF_CLOSE	X			X	X	X		X	X
DTWF_DELETE	X			X	X	X		X	X
DTWF_INSERT	X			X	X	X		X	X
DTWF_OPEN	X			X	X	X		X	X
DTWF_READ	X			X	X	X		X	X
DTWF_REMOVE	X			X	X	X		X	X
DTWF_SEARCH	X			X	X	X		X	X
DTWF_UPDATE	X			X	X	X		X	X
DTWF_WRITE	X			X	X	X		X	X
DTWR_ADDENTRY	X			X		X			X
DTWR_CLEARREG	X			X		X			X
DTWR_CLOSEREG						X			
DTWR_CREATEREG	X			X		X			X
DTWR_DELENTY	X			X		X			X
DTWR_DELREG	X			X		X			X
DTWR_LISTREG	X			X		X			X
DTWR_LISTSUB	X			X					X
DTWR_OPENREG						X			
DTWR_RTVENTRY	X			X		X			X
DTWR_UPDATEENTRY	X			X		X			X

Table 221. Net.Data Interfaces

Interface Type	AIX	HP	LINUX	OS/2	OS/390	OS/400	SCO	SUN	Win NT
FastCGI	X							X	
CGI	X	X	X	X	X	X	X	X	X
Java Beans									X
Internet Connection API (ICAPI)	X			X	X				X
Internet Server API (ISAPI)									X
Live Connection	X			X				X	X
Lotus Domino Go Web Server (GWAPI)	X			X	X				X
Netscape API (NSAPI)	X							X	X
Servlets	X				X				X

Table 222. Net.Data Tools

Tool	AIX	HP	LINUX	OS/2	OS/390	OS/400	SCO	SUN	Win NT
Administration Tool	X			X					X
NetObjects Fusion Plug-ins									X
Wizards	X			X			X	X	X

Appendix D. Notices

This information was developed for products and services offered in the U.S.A. IBM may not offer the products, services, or features discussed in this document in other countries. Consult your local IBM representative for information on the products and services currently available in your area. Any reference to an IBM product, program, or service is not intended to state or imply that only that IBM product, program, or service may be used. Any functionally equivalent product, program, or service that does not infringe any IBM intellectual property right may be used instead. However, it is the user's responsibility to evaluate and verify the operation of any non-IBM product, program, or service.

IBM may have patents or pending patent applications covering subject matter described in this document. The furnishing of this document does not give you any license to these patents. You can send license inquiries, in writing, to:

IBM Director of Licensing
IBM Corporation
500 Columbus Avenue
Thornwood, NY 10594
U.S.A.

For license inquiries regarding double-byte (DBCS) information, contact the IBM Intellectual Property Department in your country or send inquiries, in writing, to:

IBM World Trade Asia Corporation
Licensing
2-31 Roppongi 3-chome, Minato-ku
Tokyo 106, Japan

The following paragraph does not apply to the United Kingdom or any other country where such provisions are inconsistent with local law:

INTERNATIONAL BUSINESS MACHINES CORPORATION PROVIDES THIS PUBLICATION "AS IS" WITHOUT WARRANTY OF ANY KIND, EITHER EXPRESS OR IMPLIED, INCLUDING, BUT NOT LIMITED TO, THE IMPLIED WARRANTIES OF NON-INFRINGEMENT, MERCHANTABILITY OR FITNESS FOR A PARTICULAR PURPOSE. Some states do not allow disclaimer of express or implied warranties in certain transactions, therefore, this statement may not apply to you.

This information could include technical inaccuracies or typographical errors. Changes are periodically made to the information herein; these changes will be incorporated in new editions of the publication. IBM may make improvements and/or changes in the product(s) and/or the program(s) described in this publication at any time without notice.

Licensees of this program who wish to have information about it for the purpose of enabling: (i) the exchange of information between independently created programs and other programs (including this one) and (ii) the mutual use of the information that has been exchanged, should contact:

IBM Corporation
555 Bailey Avenue, W92/H3
P.O. Box 49023
San Jose, CA 95161-9023

Such information may be available, subject to appropriate terms and conditions, including in some cases, payment of a fee.

The licensed program described in this information and all licensed material available for it are provided by IBM under terms of the IBM Customer Agreement or any equivalent agreement between us.

Information concerning non-IBM products was obtained from the suppliers of those products, their published announcements or other publicly available sources. IBM has not tested those products and cannot confirm the accuracy of performance, compatibility or any other claims related to non-IBM products. Questions on the capabilities of non-IBM products should be addressed to the suppliers of those products.

COPYRIGHT LICENSE:

This information contains sample application programs in source language, which illustrates programming techniques on various operating platforms. You may copy, modify, and distribute these sample programs in any form without payment to IBM, for the purposes of developing, using, marketing or distributing application programs conforming to the application programming interface for the operating platform for which the sample programs are written. These examples have not been thoroughly tested under all conditions. IBM, therefore, cannot guarantee or imply reliability, serviceability, or function of these programs. You may copy, modify, and distribute these sample programs in any form without payment to IBM for the purposes of developing, using, marketing, or distributing application programs conforming to IBM's application programming interfaces.

Trademarks

The following terms are trademarks of the IBM Corporation in the United States or other countries or both:

AIX	Language Environment
AS/400	MVS/ESA
DB2	Net.Data
DB2 Universal Database	OS/2
DRDA	OS/390
DataJoiner	OS/400
IBM	OpenEdition
IMS	

The following terms are trademarks of other companies as follows:

Java and all Java-based trademarks and logos are trademarks of Sun Microsystems, Inc. in the United States and/or other countries.

UNIX is a registered trademark in the United States and/or other countries licensed exclusively through X/Open Company Limited.

Lotus and Domino Go Webserver are trademarks of Lotus Development Corporation in the United States and/or other countries.

Microsoft, Windows, Windows NT, and the Windows logo are trademarks or registered trademarks of Microsoft Corporation in the United States and/or other countries.

Other company, product, and service names, which may be denoted by a double asterisk (**), may be trademarks or service marks of others.

Glossary

absolute path. The full path name of an object. Absolute path names begins at the highest level, or "root" directory (which is identified by the forward slash (/) or back slash (\) character).

API. Application programming interface. Net.Data supports three Web server APIs for improved performance over CGI processes.

applet. A Java program included in an HTML page. Applets work with Java-enabled browsers, such as Netscape Navigator, and are loaded when the HTML page is processed.

application programming interface (API). A functional interface supplied by the operating system or by a separately orderable licensed program that allows an application program written in a high-level language to use specific data or functions of the operating system or licensed program. Net.Data supports the following proprietary Web server APIs for improved performance over CGI processes: ICAPI and GWAPI.

CGI. Common Gateway Interface.

commitment control. The establishment of a boundary within the process that Net.Data is running under where operations on resources are part of a unit of work.

Common Gateway Interface (CGI). A standardized way for a Web server to pass control to an application program and receive data back.

current working directory. The default directory of a process from which all relative path names are resolved.

database. A collection of tables, or a collection of table spaces and index spaces.

database management system (DBMS). A software system that controls the creation, organization, and modification of a database and access to the data stored within it.

DATALINK. A DB2 data type that enables logical references from the database to a file stored outside the database.

data type. An attribute of columns and literals.

DBCLOB. Double-byte character large object.

DBMS. Database management system.

Domino Go Web server. The Web server offered by Lotus Corp. and IBM, that offers both regular and secure connections. ICAPI and GWAPI are the interfaces provided with this server.

firewall. A computer with software that guards an internal network from unauthorized external access.

flat file interface. A set of Net.Data built-in functions that let you read and write data from plain-text files.

GWAPI. Go Web server API.

HTML. Hypertext markup language.

HTTP. Hypertext transfer protocol.

hypertext markup language. A tag language used to write Web documents.

hypertext transfer protocol. The communication protocol used between a Web server and browser.

ICAPI. Internet Connection API. See .

Internet. An international public TCP/IP computer network.

Intranet. A TCP/IP network inside a company firewall.

Java. An operating system-independent object-oriented programming language especially useful for Internet applications.

language environment. A module that provides access from a Net.Data macro to an external data source such as DB2 or a programming language such as Perl.

LOB. Large object.

middleware. Software that mediates between an application program and a network. It manages the interaction between a client application program and a server through the network.

null. A special value that indicates the absence of information.

path. A search route used to locate files.

path name. Tells the system how to locate an object. The path name is expressed as a sequence of directory names followed by the name of the object. Individual directories and the object name are separated by a forward slash (/) or back slash (\) character.

Perl. An interpreted programming language.

persistence. The state of keeping an assigned value for an entire transaction, where a transaction spans multiple Net.Data invocations. Only variables can be persistent. In addition, operations on resources affected by commitment control are kept active until an explicit commit or rollback is done, or when the transaction completes.

port. A 16-bit number used to communicate between TCP/IP and a higher level protocol or application.

registry. A repository where strings can be stored and retrieved.

relative path name. A path name that does not begin at the highest level, or "root" directory. The system assumes that the path name begins at the process's current working directory.

TCP/IP. Transmission Control Protocol / Internet Protocol.

transaction. One Net.Data invocation. If persistent Net.Data is used, then a transaction can span multiple Net.Data invocations.

Transmission Control Protocol / Internet Protocol. A set of communication protocols that support peer-to-peer connectivity functions for both local and wide-area networks.

URL. Uniform resource locator.

uniform resource locator. An address that names a HTTP server and optionally a directory and file name, for example:
<http://www.ibm.com/software/data/net.data/index.html>.

unit of work. A recoverable sequence of operations that are treated as one atomic operation. All operations within the unit of work can be completed (committed) or undone (rolled back) as if the operations are a single operation. Only operations on resources that are affected by commitment control can be committed or rolled back.

Web server. A computer running HTTP server software, such as Internet Connection.

Index

A

absolute paths, for flat files 251
accessing flat files 250
ALIGN 76
alternate text, Web browsers 90
APPLET tag, alternate text 90
authorization requirement, FFI_PATH 252

B

built-in functions 115

C

calling
 external programs 14
 functions 23
calling FFI language environment 250
case, specifying for SQL commands 87
COMMENT block
 description 7
 syntax 7
conditional string processing 28, 55
conditional variables
 description 60
 example 63
 with LIST statements 60
 with variable references 60
configuring the FFI language environment 251
connecting to a database, DATABASE variable 85
connecting to DB2 subsystem
 DB2 plan 88
 location 95
 subsystem ID 89
cookies
 DTW_GETCOOKIE 127
 DTW_PRINT_HEADER 112
 DTW_SETCOOKIE 140
 sending 112
current directory, determining for flat files 251

D

DATABASE 85
database consistency, transaction scope 101
date formats, UTF-8 124
date variables 102
DB_CASE 87
DB2 WWW Connection, language constructs 311
DB2PLAN 88
DB2SSID 89
declaration part, macro 1
DEFINE block
 description 9
 syntax 9
DEFINE statement
 description 9
 syntax 9

delimited string of values 63
delimiters, FFI language environment
 ASCIITEXT 252
 DELIMITED 252
DTW_ACCEPT 300
DTW_ADD 150
DTW_ADDQUOTE 118
DTW_APPLET_ALTTEXT 90
DTW_ASSIGN 66, 168, 169
DTW_CACHE_PAGE 120
DTW_CHARTOHEX 170
DTW_COMMIT 302
DTW_CONCAT 171
DTW_CURRENT_FILENAME 103
DTW_CURRENT_LAST_MODIFIED 104
DTW_DATE 124
DTW_DEFAULT_MESSAGE 105
DTW_DEFAULT_REPORT 77
DTW_DELSTR 172
DTW_DELWORD 195
DTW_DIVIDE 153
DTW_DIVREM 155
DTW_EDIT_CODES 91
DTW_FORMAT 157
DTW_GETCOOKIE 127
DTW_GETENV 129
DTW_GETINIDATA 131
DTW_HEXTOCHAR 174
DTW_HTML_TABLE 78
DTW_HTMLENCODE 132
DTW_INSERT 175
DTW_INTDIV 160
DTW_LASTPOS 177
DTW_LENGTH 179
DTW_LOG_LEVEL 106
DTW_LOWERCASE 180
DTW_MACRO_FILENAME 107
DTW_MACRO_LAST_MODIFIED 108
DTW_MBMODE 109
DTW_MP_PATH 110
DTW_MP_VERSION 111
DTW_MULTIPLY 162
DTW_PAD_PGM_PARMS 92
DTW_POS 182
DTW_POWER 164
DTW_PRINT_HEADER 112
DTW_QHTMLENCODE 134
DTW_REMOVE_WS 113
DTW_REPLACE 184
DTW_REVERSE 186
DTW_ROLLBACK 303
DTW_RTVHANDLE 304
DTW_SAVE_TABLE_IN 93
DTW_SENDMAIL 135
DTW_SET_TOTAL_ROWS 94
DTW_SETCOOKIE 140
DTW_SETENV 144
DTW_STATIC 305

- DTW_STRIP 187
- DTW_SUBSTR 189
- DTW_SUBTRACT 166
- DTW_SUBWORD 198
- DTW_TB_APPENDROW 207
- DTW_TB_COLS 209
- DTW_TB_deleteCOL 211
- DTW_TB_DELETEROW 212
- DTW_TB_DLIST 214
- DTW_TB_DUMPV 216
- DTW_TB_DUMPV 217
- DTW_TB_GETN 219
- DTW_TB_GETV 221
- DTW_TB_HTMLENCODE 223
- DTW_TB_INPUT_CHECKBOX 225
- DTW_TB_INPUT_RADIO 227
- DTW_TB_INPUT_TEXT 229
- DTW_TB_INSERTCOL 231
- DTW_TB_INSERTROW 232
- DTW_TB_LIST 231
- DTW_TB_QUERYCOLNONJ 236
- DTW_TB_ROWS 238
- DTW_TB_SELECT 239
- DTW_TB_SETCOLS 241
- DTW_TB_SETN 242
- DTW_TB_SETV 244
- DTW_TB_TABLE 246
- DTW_TB_TEXTAREA 248
- DTW_TERMINATE 307
- DTW_TIME 146
- DTW_TRANSLATE 191
- DTW_UPPERCASE 193
- DTW_URLESCSEQ 148
- DTW_WORD 200
- DTW_WORDINDEX 201
- DTW_WORDLENGTH 202
- DTW_WORDPOS 203
- DTW_WORDS 205
- DTWF_APPEND 253
- DTWF_CLOSE 253, 257
- DTWF_DELETE 258
- DTWF_INSERT 260
- DTWF_OPEN 253, 263
- DTWF_READ 265
- DTWF_REMOVE 268
- DTWF_SEARCH 270
- DTWF_UPDATE 273
- DTWF_WRITE 276
- DTWR_ADDENTRY 279
- DTWR_CLEARREG 282
- DTWR_CLOSEREG 283
- DTWR_CREATEREG 284
- DTWR_DELENTY 286
- DTWR_DELREG 288
- DTWR_LISTREG 289
- DTWR_LISTSUB 291
- DTWR_OPENREG 293
- DTWR_RTVENTRY 295
- DTWR_UPDATEENTRY 297

E

- environment variables
 - description 61
 - ENVVAR statement 13
 - example 61
- ENVVAR statement 61
 - description 13
 - syntax 13
- error handling 44
- EXEC block
 - description 14
 - syntax 14
- EXEC_PATH 14
- EXEC_SQL 311
- EXEC statement 61
 - description 14
 - syntax 14
- executable variables
 - as a variable reference 62
 - description 61
 - example 62
 - with parameters 62

F

- FFI functions
 - DTWF_APPEND 254
 - DTWF_CLOSE 257
 - DTWF_DELETE 258
 - DTWF_INSERT 260
 - DTWF_OPEN 263
 - DTWF_READ 265
 - DTWF_REMOVE 268
 - DTWF_SEARCH 270
 - DTWF_UPDATE 273
 - DTWF_WRITE 276
 - freeing files 253
 - locking files 253
- FFI language environment
 - accessing files 250
 - authorization requirement 252
 - configuration rules 251
 - current directory 251
 - delimiters 252
 - file location 250
 - security recommendations 252
- FFI_PATH
 - accessing flat files 250
 - configuration rules 251
 - flat file location 250
 - matching paths with *filename* parameter 251
 - security recommendations 252
 - syntax 250
- file location variables 102
- flat files
 - absolute paths 251
 - accessing 250
 - authorization requirement 252
 - configuration rules 251
 - creating in current directory 251

- flat files (*continued*)
 - data sources 250
 - definition 250
 - delimiters 252
 - location
 - current directory 250, 251
 - FFI_PATH 250
 - locking files 253
 - matching the FFI_PATH 251
 - recommendations for access 251
 - security recommendations 252
- footers 34
- freeing files, FFI functions 253
- FUNCTION block
 - description 16
 - syntax 17
- function calls
 - description 23
 - formatting output 48
 - processing table rows 51
 - syntax 23
 - use of INOUT variables 24
- functions
 - description 115
 - flat file interface (FFI) 250
 - general 116
 - math 150
 - naming conventions 115
 - passing groups of values 64
 - persistent 299
 - string 168
 - table 206
 - Web registry 279
 - word 195

G

- general functions 116
 - DTW_ADDQUOTE 118
 - DTW_CACHE_PAGE 120
 - DTW_DATE 124
 - DTW_EXIT 126
 - DTW_GETCOOKIE 127
 - DTW_GETENV 129
 - DTW_GETINIDATA 131
 - DTW_HTMLENCODE 132
 - DTW_QHTMLENCODE 134
 - DTW_SENDMAIL 135
 - DTW_SETCOOKIE 140
 - DTW_SETENV 144
 - DTW_TIME 146
 - DTW_URLESCSEQ 148
- glossary 321

H

- headers 34
- hidden variables
 - description 62
 - example, in an HTML form 63
 - steps 63
- hiding variable names 62

- HTML
 - displaying table results in 78
 - form, entering passwords 98
 - form, entering user IDs 96
 - hiding variable names 62
- HTML block
 - description 26
 - syntax 26
- HTML_INPUT block 311
- HTML_REPORT block 311

I

- IF block
 - description 28
 - syntax 28
- IN keyword 18, 41, 115
- include files 34
- INCLUDE_PATH 34
- INCLUDE statement
 - description 34
 - syntax 34
- INCLUDE_URL statement
 - description 36
 - syntax 36
- INOUT keyword 18, 41, 115
- INOUT variable
 - example 24

L

- language constructs
 - COMMENT block 7
 - common syntax elements 4
 - DB2 WWW Connection 311
 - DEFINE block or statement 9
 - ENVVAR statement 13
 - EXEC block or statement 14
 - FUNCTION block 16
 - function calls 23
 - HTML block 26
 - IF block 28
 - INCLUDE statement 34
 - INCLUDE_URL statement 36
 - LIST statement 38
 - macro
 - description 6
 - syntax 1
 - MACRO_FUNCTION block 40
 - MESSAGE block 44
 - REPORT block 48
 - ROW block 51
 - strings 5
 - TABLE statement 53
 - variable name 4
 - variable reference 4
 - WHILE block 55
- language environment variables
 - DATABASE 85
 - DB_CASE 87
 - DB2PLAN 88
 - DB2SSID 89

language environment variables (*continued*)

- description 84
- DTW_APPLET_ALTTEXT 90
- DTW_EDIT_CODES 91
- DTW_MBMODE 109
- DTW_PAD_PGM_PARMS 92
- DTW_SAVE_TABLE_IN 93
- DTW_SET_TOTAL_ROWS 94
- LOCATION 95
- LOGIN 96
- NULL_RPT_FIELD 97
- PASSWORD 98
- SHOWSQL 99
- SQL_STATE 100
- TRANSACTION_SCOPE 101

line length limits, macros 3

LIST statement

- description 38
- syntax 38

list variables

- description 63
- example 63
- value separators 64

listing delimited strings 63

local DB2 subsystem, ID 89

LOCATION 95

location, connecting to DB2 subsystem 95

location, flat files 250

locking files, FFI functions 253

LOGIN 96

looping 55

lower case, specifying 87

M

MACRO_FUNCTION block

- description 40
- syntax 40

macros

- common syntax elements 4
- declaration part 1
- format 2
- global syntax 1
- language constructs 1
- line length limits 3
- presentation part 1
- sample 2
- stop processing 126

math functions

- DTW_ADD 151
- DTW_DIVIDE 153
- DTW_DIVREM 155
- DTW_FORMAT 157
- DTW_INTDIV 160
- DTW_MULTIPLY 162
- DTW_POWER 164
- DTW_SUBTRACT 166

MBCS support for functions

- string functions 168
- word functions 195

MESSAGE block

- description 44

MESSAGE block (*continued*)

- syntax 44

messages, default text 105

miscellaneous variables

- description 102
- DTW_CURRENT_FILENAME 103
- DTW_CURRENT_LAST_MODIFIED 104
- DTW_DEFAULT_MESSAGE 105
- DTW_MACRO_LAST_MODIFIED 108
- DTW_MP_PATH 110
- DTW_MP_VERSION 111
- DTW_PRINT_HEADER 112
- DTW_REMOVE_WS 113
- RETURN_CODE 114

N

Nn 66

Net.Data tables

- defining 53
- upper limit 53

Next button, RPT_MAX_ROWS 81

NLIST 67

Notices 319

NULL_RPT_FIELD 97

NUM_COLUMNS 68

NUM_ROWS 69

numeric comparison of strings 28, 55

O

operating system reference 312

OUT keyword 18, 41, 115

P

parameters, passing 21

passing groups of values 64

passing parameters, System language environment 21

PASSWORD 98

performance, DTW_EXIT 126

Persistent macro functions

- DTW_ACCEPT 300
- DTW_COMMIT 302
- DTW_ROLLBACK 303
- DTW_RTVHANDLE 304
- DTW_STATIC 305
- DTW_TERMINATE 307

plan, connecting to DB2 subsystem 88

platform support reference 312

presentation part, macro 1

Previous button, RPT_MAX_ROWS 81

R

remote DB2 subsystem, location 95

REPORT block

- ALIGN 76
- description 48
- DTW_DEFAULT_REPORT 77
- DTW_HTML_TABLE 78

REPORT block (*continued*)
 Nn 66
 NLIST 67
 NUM_COLUMNS 68
 NUM_ROWS 69
 RPT_MAX_ROWS 79
 START_ROW_NUM 81
 syntax 48
 table variables 64
 TOTAL_ROWS 71
 report variables
 ALIGN 76
 description 75
 DTW_DEFAULT_REPORT 77
 DTW_HTML_TABLE 78
 RPT_MAX_ROWS 79
 START_ROW_NUM 81
 reports
 formatting 48
 overriding Net.Data default 77
 restricting database access 96, 98
 RETURN_CODE 114
 RETURNS keyword 19, 41
 ROW block
 description 51
 Nn 66
 NLIST 67
 NUM_COLUMNS 68
 NUM_ROWS 69
 ROW_NUM 70
 syntax 51
 TOTAL_ROWS 71
 V_columnName 72
 Vn 73, 74
 ROW_NUM 70
 RPT_MAX_ROWS 79

S

scrolling, with Next and Previous buttons 81
 security
 login ID 96
 passwords 98
 security recommendations, FFI_PATH 252
 sending e-mail from the macro 135
 SHOWSQL 99
 SQL
 commands, specifying case 87
 hiding or displaying 99
 SQL block 311
 SQL_CODE 312
 SQL_MESSAGE block 312
 SQL_REPORT block 312
 SQL_STATE 100
 SQL state, displaying 100
 START_ROW_NUM 81
 string functions
 DTW_ASSIGN 169
 DTW_CHARTOHEX 170
 DTW_CONCAT 171
 DTW_DELSTR 172
 DTW_HEXTOCHAR
 DTW_HEXTOCHAR 174

string functions (*continued*)
 DTW_INSERT
 DTW_INSERT 175
 DTW_LASTPOS 177
 DTW_LENGTH 179
 DTW_LOWERCASE 180
 DTW_POS 182
 DTW_REPLACE 184
 DTW_REVERSE 186
 DTW_STRIP 187
 DTW_SUBSTR 189
 DTW_TRANSLATE 191
 DTW_UPPERCASE 193
 MBCS support 168
 strings
 conditional processing 28, 55
 description 5
 numeric comparisons 28, 55
 of values, delimited 63
 subsystem ID, connecting to DB2 subsystem 89
 supported features table 312
 System language environment, passing parameters 21

T

table functions
 DTW_TB_APPENDROW 207
 DTW_TB_COLS 209
 DTW_TB_DELETETECOL 211
 DTW_TB_DELETEROW 212
 DTW_TB_DLIST 214
 DTW_TB_DUMPH 216
 DTW_TB_DUMPV 217
 DTW_TB_GETN 219
 DTW_TB_GETV 221
 DTW_TB_HTMLENCODE 223
 DTW_TB_INPUT_CHECKBOX 225
 DTW_TB_INPUT_RADIO 227
 DTW_TB_INPUT_TEXT 229
 DTW_TB_INSERTCOL 231
 DTW_TB_INSERTROW 232
 DTW_TB_LIST 234
 DTW_TB_QUERYCOLNONJ 236
 DTW_TB_ROWS 238
 DTW_TB_SELECT 239
 DTW_TB_SETCOLS 241
 DTW_TB_SETN 242
 DTW_TB_SETV 244
 DTW_TB_TABLE 246
 DTW_TB_TEXTAREA 248
 table processing variables
 description 65
 Nn 66
 NLIST 67
 NUM_COLUMNS 68
 NUM_ROWS 69
 ROW_NUM 70
 specifying for SQL language environment 93
 TOTAL_ROWS 71
 V_columnName 72
 Vn 74
 VLIST 73

TABLE statement 64
 description 53
 syntax 53
table variables
 description 64
 example 65
tables
 Net.Data, specifying number of rows 79
 results in HTML 78
TOTAL_ROWS 71
TRANSACTION_SCOPE 101

word functions (*continued*)
 DTW_WORDPOS 203
 DTW_WORDS 205
 MBCS support 195

U

upper case, specifying 87
upper limit 53
UTF-8 format
 date 124

V

V_columnName 72
variable name 4
variable reference 4
variables
 conditional 60
 environment 61
 executable 61
 hidden 62
 language environment 84
 list 63
 miscellaneous 102
 Net.Data, overview 59
 report 75
 table 64, 65
VLIST 73
Vn 74

W

Web registry functions
 DTWR_ADDENTRY 280
 DTWR_CLEARREG 282
 DTWR_CLOSEREG 283
 DTWR_CREATEREG 284
 DTWR_DELENTY 286
 DTWR_DELREG 288
 DTWR_LISTREG 289
 DTWR_LISTSUB 291
 DTWR_OPENREG 293
 DTWR_RTVENTRY 295
 DTWR_UPDATEENTRY 297
WHILE block
 description 55
 syntax 55
word functions
 DTW_DELWORD 196
 DTW_SUBWORD 198
 DTW_WORD 200
 DTW_WORDINDEX 201
 DTW_WORDLENGTH 202



Printed in the United States of America
on recycled paper containing 10%
recovered post-consumer fiber.