



# **The New zEnterprise – A Smarter System For A Smarter Planet**

A Closer Look At zEnterprise

# z196 Has A Familiar 4-Book Design, But Packs More Inside

- Each book has 6 quad-core central processors (CPs) ...
  - ▶ Increased from 5 in System z10
  - ▶ Fully connected topology
- ...Plus 2 shared cache (SC) chips
  - ▶ Each holds up to 96 MB eDRAM L4 cache shared per node
    - 192 MB total per book
- Up to 3TB RAIM memory for system
  - ▶ Up to 768 GB per book

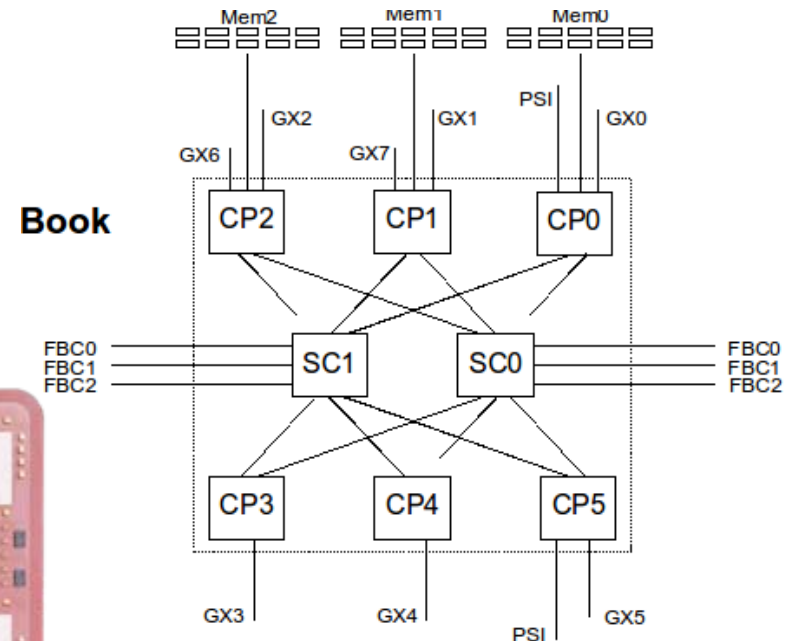
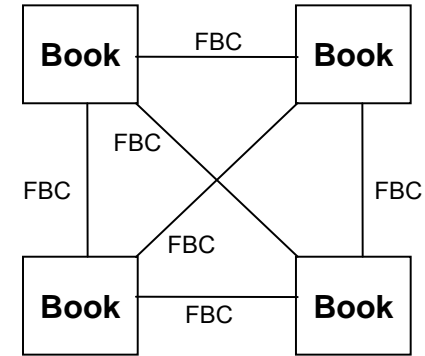

# z196 Core Designed To Be The Fastest Available Today

- Quad-core CP chips designed to reach speeds of 5.2 GHz
  - ▶ Exceeds z10 speed of 4.4 GHz
- Four levels of cache:
  - ▶ Over twice as much on-chip cache as System z10
  - ▶ L1: 64KB I / 128K D private, per core
  - ▶ L2: 1.5MB private, per core (adjacent)
  - ▶ L3: 24MB per chip, shared by all 4 core
  - ▶ Interface to L4 cache (SC Chips) at 40+ GB/sec
- Cryptographic and data compression co-processors
- Memory controller
- I/O Bus Controller (GX)
- Over 100 new instructions

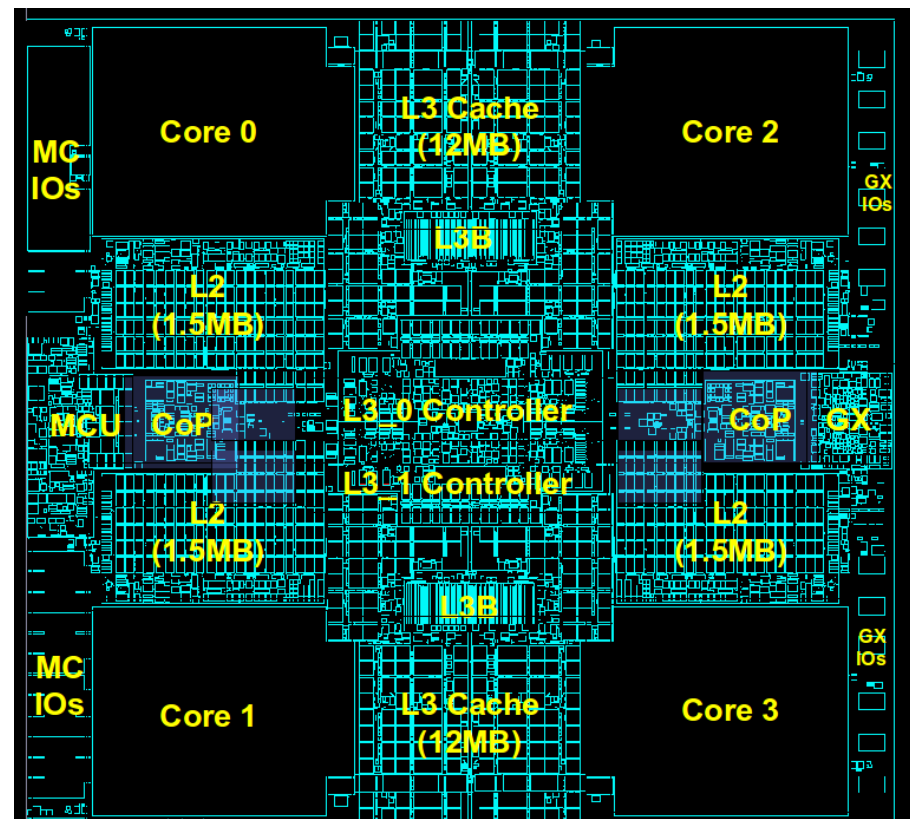

CP Floor Plan – 512.3 mm<sup>2</sup>, 1.4B transistors

**40% improvement for n-way processors**  
**60% more total capacity than System z10**

# zEnterprise Includes System z's First Out-Of-Order (OOO) Core

- Instructions can be reordered
  - ▶ Later (younger) instructions can execute ahead of older stalled instruction
  - ▶ Re-order storage accesses and parallel storage accesses
  - ▶ Yields significant performance benefit for compute-intensive applications

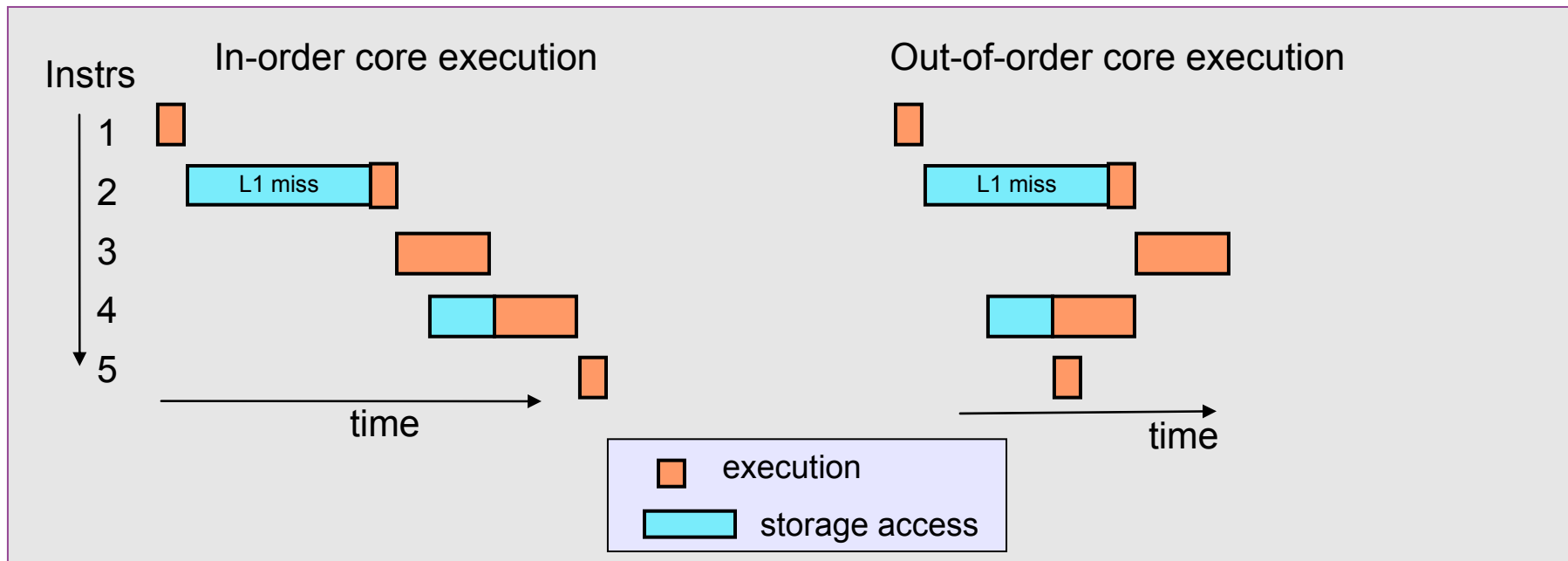

# z196 – A New Generation Of Mainframe Available In Five Models

- Machine type 2817
  - ▶ Five models – M15, M32, M49, M66, M80
- Configurable up to 96 CPs
  - ▶ 20 CPs per node (24 for M80)
  - ▶ 80 configurable as GP, SAP, IFL, ICF, zAAP, zIIP
  - ▶ 2 spares per system
- Capacity On Demand capabilities included
- Up to 60 logical partitions
  - ▶ Up to 1TB per LPAR
- Support for:
  - ▶ z/OS, z/VM, z/VSE, z/TPF, Linux on System z



*Sub-capacity pricing available:*

- 7xx = 100%
- 6xx = 64%
- 5xx = 49%
- 4xx = 20% (xx = 01 - 15)

# z196 Yields Dramatic Improvements Over IBM System z10

For Linux

Up to **60%**

Improvement in  
performance

at **33%**

Less cost



For z/OS

Up to **40%**

Improvement in  
performance

with **60%**

More capacity

**With no increase in energy consumption**

\* Based on 60% increase in total capacity and 40% improvement in engine speed of z199 compared to z10. Also, includes new pricing for IFL, memory and maintenance.

# z196 Can Coexist In A Parallel Sysplex With z10 And z9

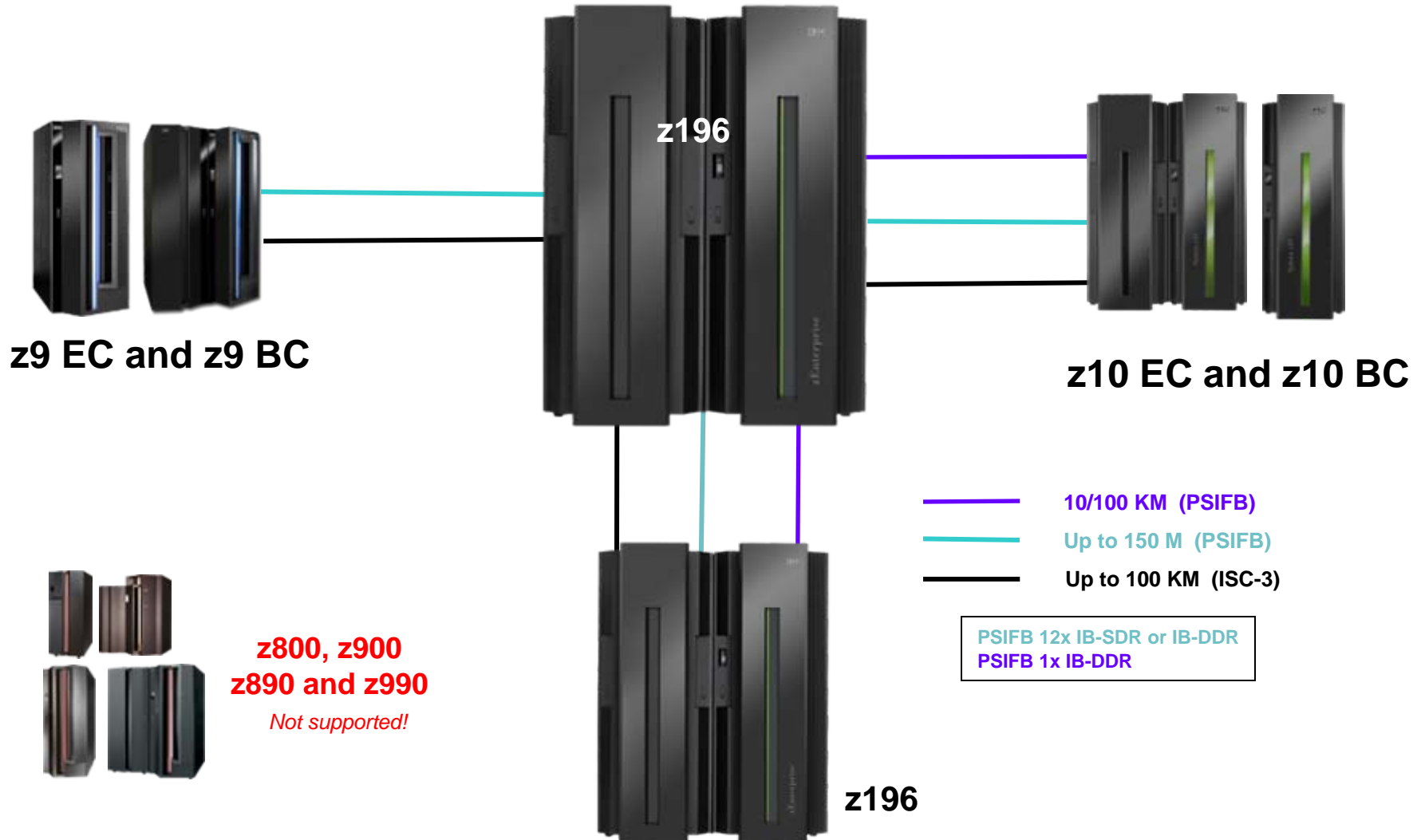

# zBX Is An Extension Of System z

## Machine Type: 2458 – Model 002

### ■ Integrated IBM Certified Components

- ▶ Standard parts – Top-of-rack (TOR) switches, BladeCenter Chassis, Power Distribution Units, Optional Acoustic Panels

### ■ System z support

- ▶ Problem reporting, hardware and firmware updates

### ■ Expanded operating system support for zEnterprise

- ▶ AIX, Linux on System x<sup>1</sup>

### ■ Simplified management

- ▶ Improved time to install and implement new applications
- ▶ Central point of management for heterogeneous workloads
- ▶ No change to applications



### Optimizers

- IBM Smart Analytics Optimizer
- WebSphere® DataPower® appliance<sup>1</sup>

### Select IBM Blades

- BladeCenter PS701 Express
- System x<sup>1</sup>

One to four – 42u racks – capacity for 112 blades

No System z software running in zBX – Passport Advantage software licensed to blades

No MIPS/MSU rating

Configured for high availability

Optional rear door heat exchanger

<sup>1</sup> All statements regarding IBM future direction and intent are subject to change or withdrawal without notice, and represents goals and objectives only.



# zBX Supports New Power PS701 Blades

- POWER7 8-core processor  
3.0GHz
- Single wide blade server
- 3 configurations supported in  
zEnterprise System
  - ▶ 32 GB, 64 GB, 128 GB
- AIX OS 5.3 or greater
- PowerVM
- Hot Swap Power Blades in  
BladeCenter Chassis
- Auto sensing by z196 initiates  
configuration and firmware  
updates done at HMC

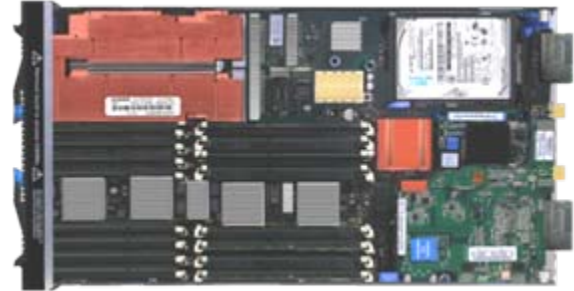

**Machine Type: 8406**  
**Model 71Y**

- System z support extended to zBX blades:
- *Problem reporting and 'phone home' capability*
  - *Blade warranty provided as part of zBX warranty and terms*
  - *Support by IBM System z Service Support Rep (SSR)*

# IBM Smart Analytics Optimizer Uses Breakthrough Technology To Accelerate Business Analytics

## What is it?

System x blades, memory, and software designed to work transparently with DB2 for z/OS

Snapshot of datamart is maintained in blade memories, organized by column, and compressed

Accelerates select queries from DB2 for z/OS, with unprecedented response times

## How is it different?

Performance

Integration

Transparency

Simplified administration



# WebSphere DataPower Appliance Simplifies Deployment And Hardens Security

## What is it?

Helps simplify, govern, and enhance the security of XML and IT services

Provides connectivity, gateway functions, data transformation, protocol bridging, and intelligent load distribution

## How is it different?

Security

Improved support

System z packaging

Operational controls



\* All statements regarding IBM future direction and intent are subject to change or withdrawal without notice, and represents goals and objectives only.

# zEnterprise zBX Integration

Hypervisors are shipped, serviced,  
and deployed as System z  
Licensed Internal Code

Booted automatically at power on reset

Pre-configured private and physically  
isolated internal management  
network

1 Gbps that connects all resources for  
management purposes

Private and secure data network

10 Gbps that connects all resources

Access-controlled using integrated virtual  
LAN (VLAN) provisioning that requires  
no external switches or routers

Less latency – fewer ‘hops’ to get to the  
data and no need for encryption /  
firewall

Full redundancy for high availability

## Centralized and Secure Virtualization Platform

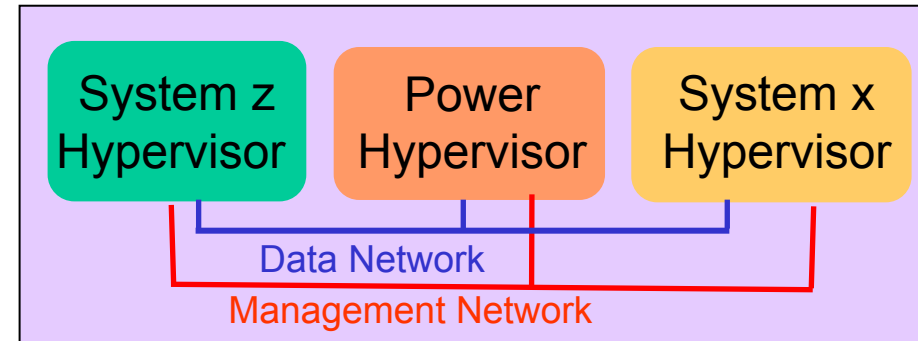

**zEnterprise**

# Uniform Resource Manager (URM) Integrates Management of z196 And zBX Environments

Automatic inventory of all elements

Automatic installation of hypervisors

Create virtual networks

Create virtual machines on any hypervisor from one console

Manage performance of virtual machines as a group for a business workload

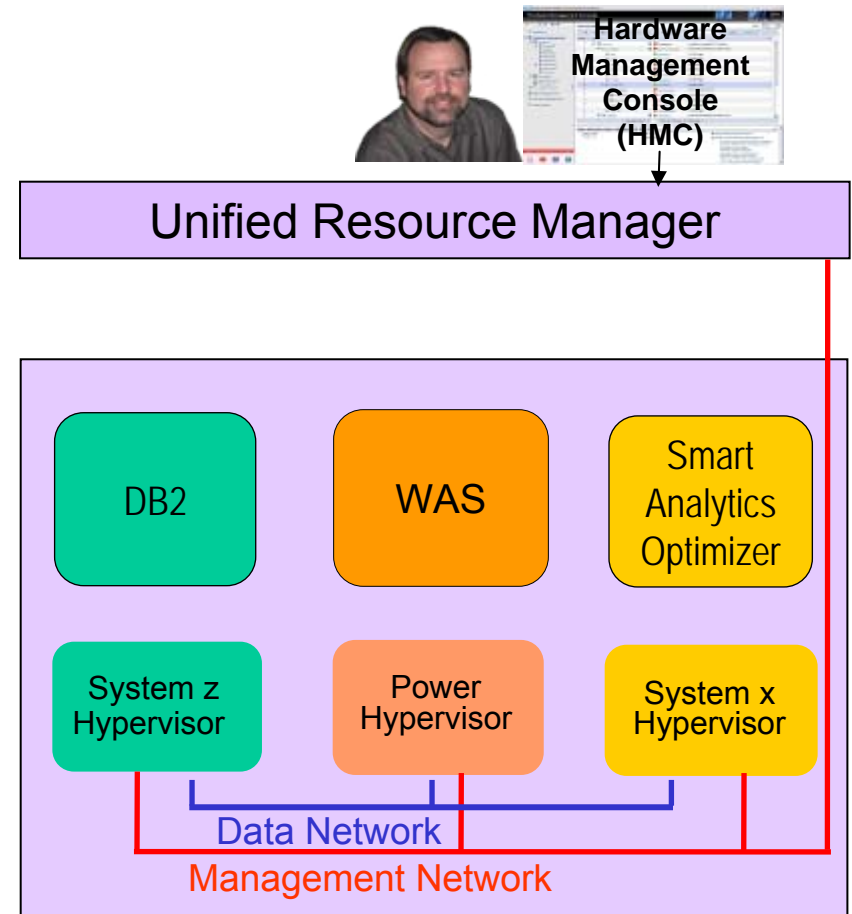

# URM Works With HMC And SE To Manage Resources Between z196 And zBX

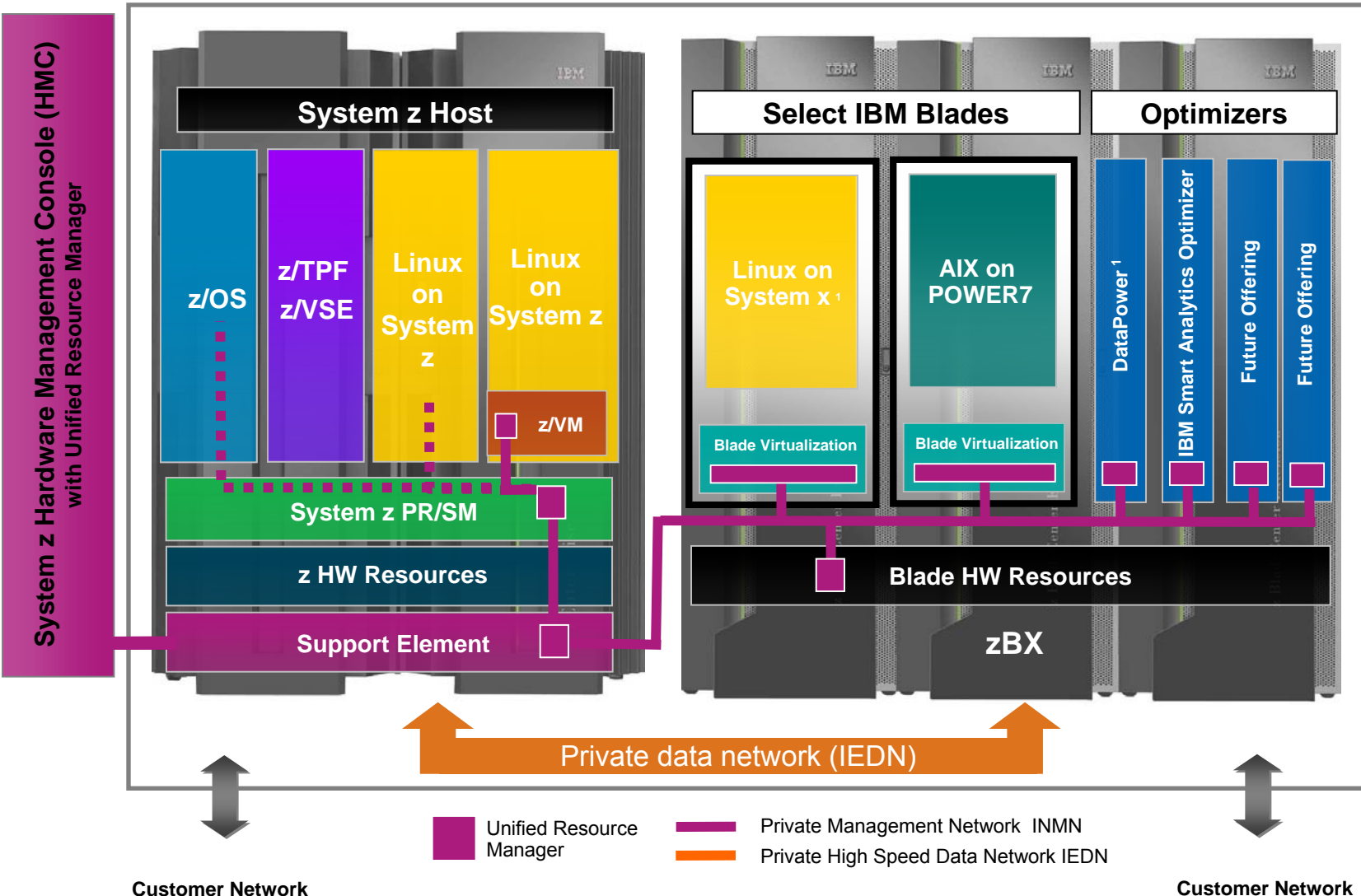

# A Smart New Release Of z/OS Yields Improved Performance And Ease Of Use

## **z/OS Version 1 Release 12....**

*Control-Area Reclaim improves performance up to 40% for applications using VSAM*

*Additional new data set types enable easier data management*

*Management and administration simplified with the z/OS Management Facility (z/OSMF); WLM Policy Editor integrated into z/OSMF*



## **... a Smarter Operating System**

*Innovative self-learning, self-managing and self-optimizing capabilities*

*Learns heuristically from its environment; reports system abnormalities*

*Predictive Failure Analysis predicts problems before they occur*

*Real-Time Diagnostics quickly analyses key indicators on a running system*

*Discovery and Auto Configuration brings “plug and play” capabilities to z/OS platform*

# zEnterprise Is A New Generation Of Computing Power

A “system of systems” to revolutionize the data center

**z196** – a new, fast, high-performance breed of mainframe

**zBX** – integrated AIX and Linux-based application blade servers and blade appliances

**Unified Resource Manager** – resource and workload management firmware extending across the systems

