



zEnterprise: Security and Risk Hub



Agenda

- **Why all of the data breaches?**
- **The “Silver Bullet” in your Security, Risk Strategy: zEnterprise**
- **The “Fort Knox” of Cloud Computing**
- **Case Studies, Client Examples**
- **How to get Started**

How did we get into this huge data breach problem? Lost Centralized Control of the Data.

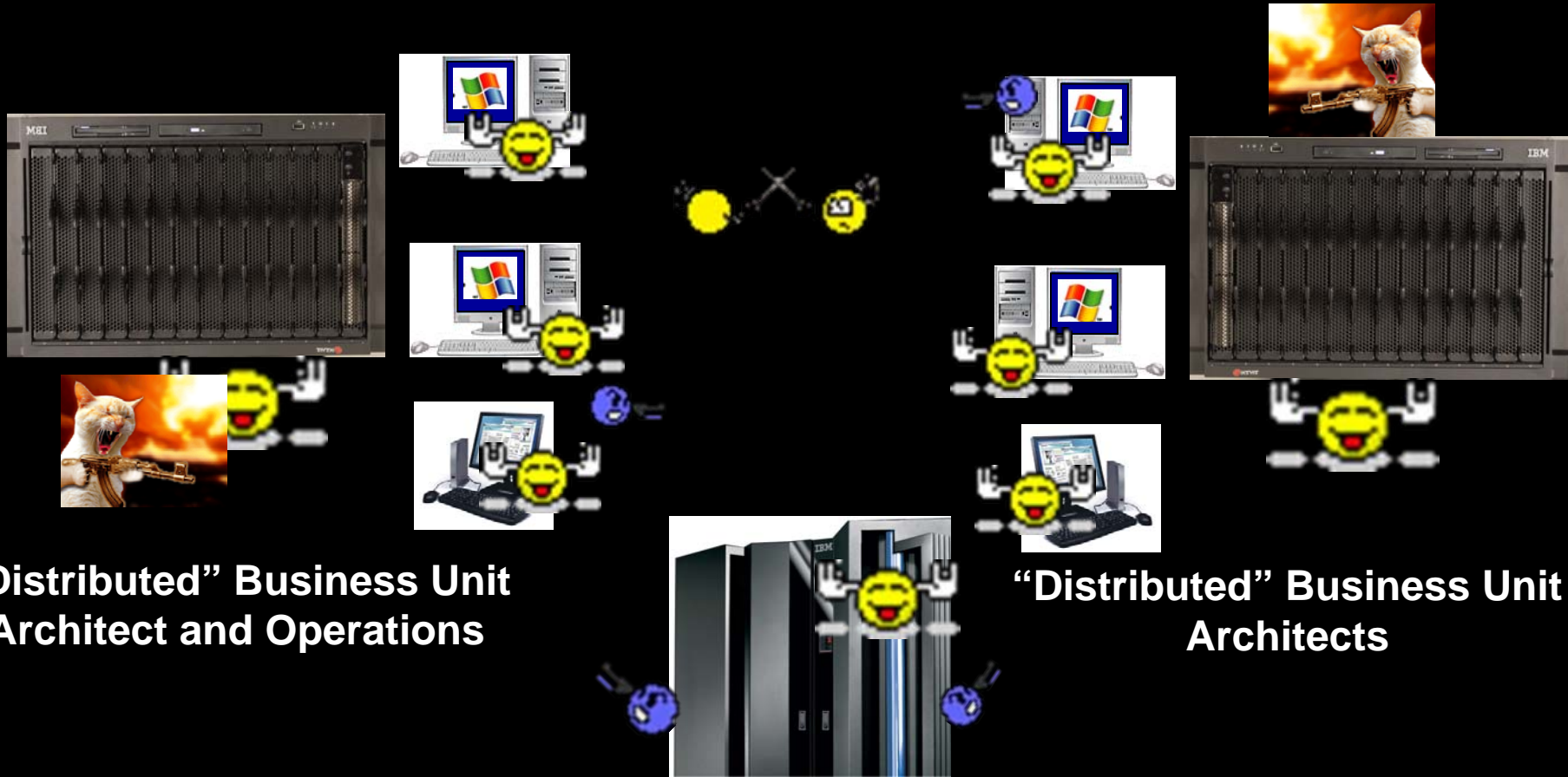

**“Distributed” Business Unit
Architect and Operations**

**“Distributed” Business Unit
Architects**

**“Centralized” Glass House
Operations**

Real Customer Problem



- Store uses WEP wireless for Point of Sale devices
- POS processes cards with banks
- **Common password on all store systems**
- **Security patches not applied to store systems**
- **Hacker plugs in and gets copies of all transactions**
- Problem detected and store systems are getting fixed.
- Mainframe folks are happy they are bullet proof
- **Hypothesis: Mainframe could help secure stores if they use good procedures**
- Store managers run inventory transactions to mainframe
- **No encryption on sign in**
- **No audit records analyzed**

IBM Security: Delivering intelligence, integration and expertise across a comprehensive framework



IBM Security Systems

- Only vendor in the market with end-to-end coverage of the security foundation
- 6K+ security engineers and consultants
- Award-winning X-Force® research
- Largest vulnerability database in the industry

Intelligence • Integration • Expertise

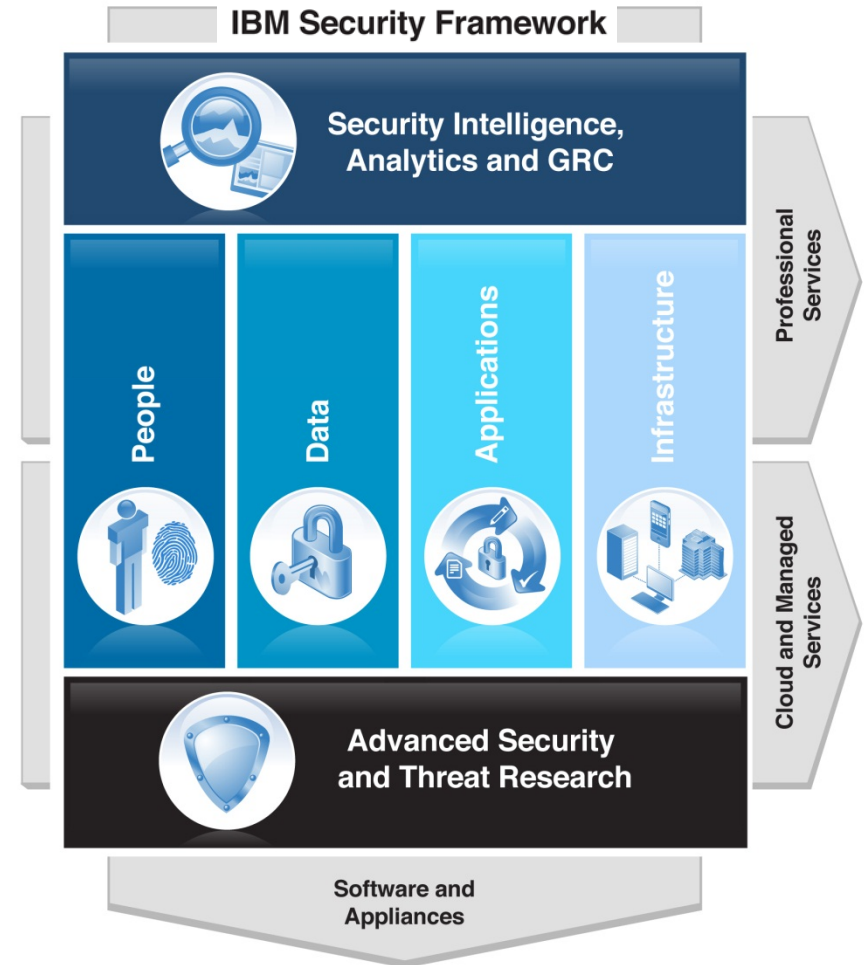

System z Security Conferences and Training

▪ System z Training Available:

- Onsite from IBM Services
- SHARE
- System z Technical University
- Impact
- Information on Demand
- Pulse

2012 RSA Security Conference

- **Largest Security Conference in the World**
 - US: San Francisco, February 27-March 2, 2012
- **RSA Europe**
- **RSA Asia**
- <http://www.rsaconference.com/index.htm>
- **Highlights.....**

RSA CONFERENCE | Where The World Talks Security

IT-Security
made in Germany



USA 2012 February 27 - March 2 | Moscone Center | San Francisco

IBM's FORT KNOX: zEnterprise

System z Security, Risk, & Fraud Strategy: Looking at 2012 and Beyond

The Enterprise Security Hub

Jack Jones, System z Security -- johnjone@us.ibm.com

Greg Boyd, System z Cryptography -- boydg@us.ibm.com

Rich Skinner, IBM Risk, Security Executive Advisor--rsc@us.ibm.com

Glinda Cummings – Tivoli Security for zEnterprise

Kelly Ozley – System z Security BUE



Forrester Survey – *“Please rank which operating system category you feel is inherently more secure?”*

April 10, 2007

Operating System Vendors: Do More To Help Users With Server Security
 by Jennifer Albornoz Mulligan

More secure	Rank	
	1	Mainframe
	2	Unix
	3	Macintosh
Less secure	4	Linux
	5	Windows

Figure 3 - Security Decision-Makers' Opinions On OSes' Security

- Source: Forrester Research, Inc. 41887
- Base: 75 decision-makers responsible for server security

System z Evaluations & Certifications

The Common Criteria program establishes an organizational and technical framework to evaluate the trustworthiness of IT Products and protection profiles

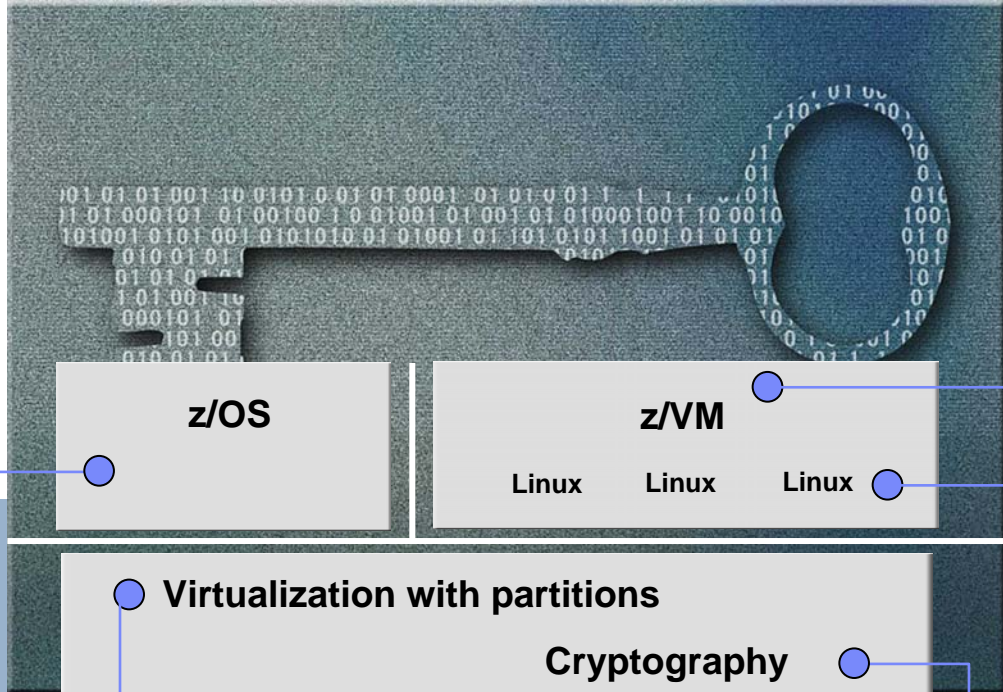

- ### z/VM
- Common Criteria
 - z/VM 5.3
 - EAL 4+ for CAPP and LSPP
 - System Integrity Statement

- ### Linux on System z
- Common Criteria
 - SUSE SLES10 certified at EAL4+ with CAPP
 - Red Hat EL5 EAL4+ with CAPP and LSPP
 - OpenSSL - FIPS 140-2 Level 1 Validated
 - CP Assist - SHA-1 validated for FIPS 180-1 - DES & TDES validated for FIPS 46-3

- ### z/OS
- Common Criteria EAL4+
 - with CAPP and LSPP
 - z/OS 1.7 → 1.10 + RACF
 - z/OS 1.11 + RACF (OSPP)
 - z/OS 1.12 + RACF (OSPP)
 - Common Criteria EAL5
 - z/OS RACF 1.12 (OSPP)
 - z/OS 1.10 IPv6 Certification by JITC
 - IdenTrust™ certification for z/OS PKI Services
 - FIPS 140-2
 - System SSL z/OS 1.10 → 1.12
 - z/OS ICSF PKCS#11 Services – z/OS 1.11
 - Statement of Integrity

- ### Virtualization with partitions
- System z9 EC and z9 BC System z10 EC and z10 BC
 - Common Criteria EAL5 with specific target of evaluation -- LPAR: Logical partitions
 - zEnterprise 196 & zEnterprise 114
 - Common Criteria EAL5+ with specific target of Evaluation – LPAR: Logical partitions
 - Crypto Express2 & Crypto Express3 Coprocessors
 - FIPS 140-2 level 4 Hardware Evaluation
 - Approved by German ZKA
 - CP Assist
 - FIPS 197 (AES)
 - FIPS 46-3 (TDES)
 - FIPS 180-3 (Secure Hash)

Recent 2012 System z Certifications

- **IBM RACF for z/OS 1.12 has achieved Common Criteria certification at Evaluation Assurance Level 5 (EAL5)**
- **IBM's® z/OS® Version 1 R. 13 System ICSF PKCS#11 Cryptographic Module Receives FIPS 140-2 Certification – February 23, 2012**
- **IBM's® z/OS® Version 1 Release 13 System SSL Cryptographic Module Receives FIPS 140-2 Certification – March 20, 2012**

zEnterprise Enables Consolidation of Workloads

IBM Security Solutions Enable Consolidation of Security Management



Unified Resource Manager

The backbone of mainframe security Resource Access Control Facility (RACF)

**Authentication
Authorization
Administration
Auditing**

RACF

Administration

Data & Applications

Networks

z/OS

Architecture

Hardware

Enables application and database security without modifying applications

Can reduce security complexity and expense:

- **Central security process that is easy to apply to new workloads or as user base increases**
- **Tracks activity to address audit and compliance requirements**

- **Integration with distributed system security domain**
- **Checking for “Best Practices” with z/OS HealthChecker**
- **Serving mainframe enterprises for over 30 years**

RACF Features and Functions

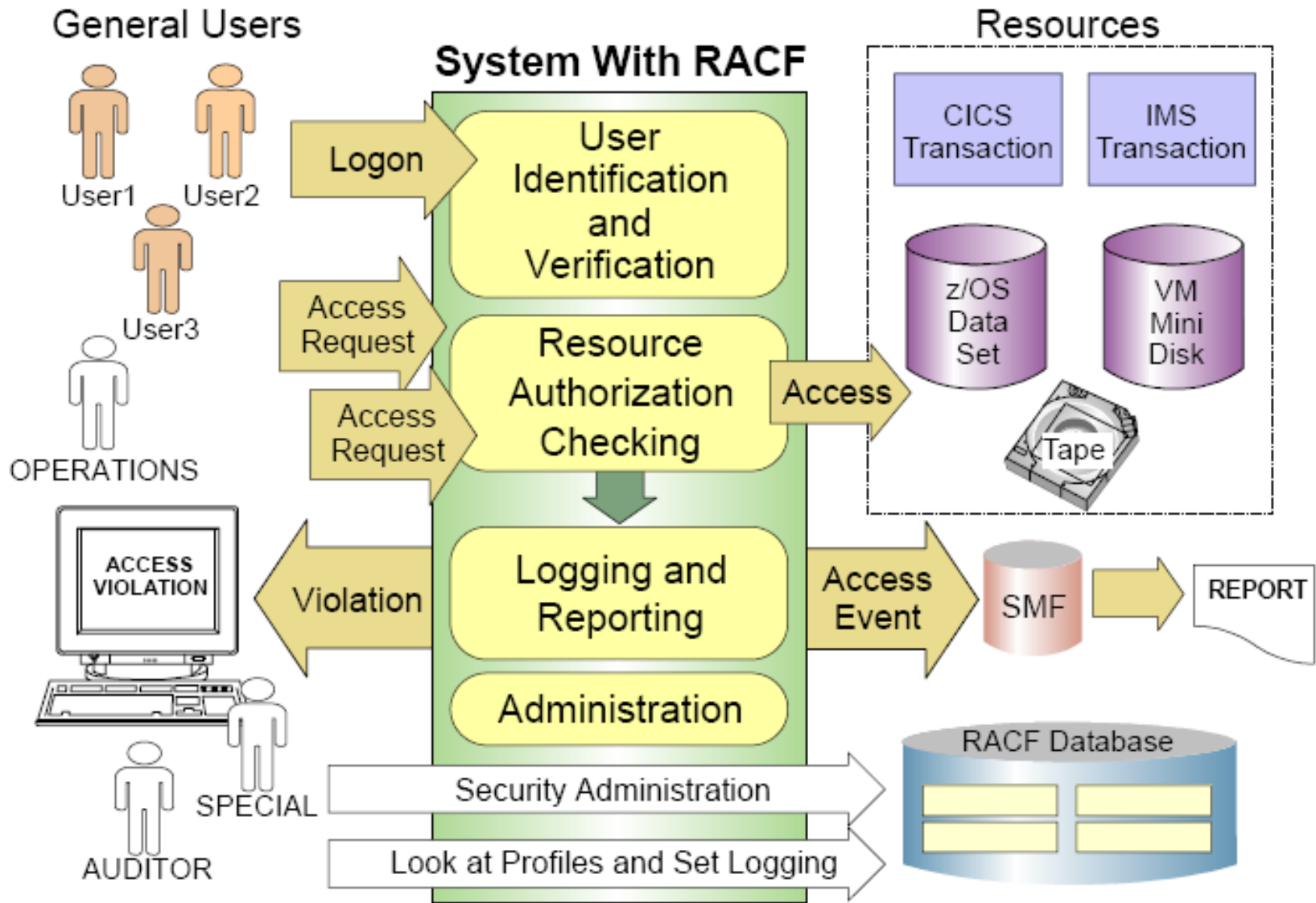

Encryption Solutions

Enterprise Encryption Solutions

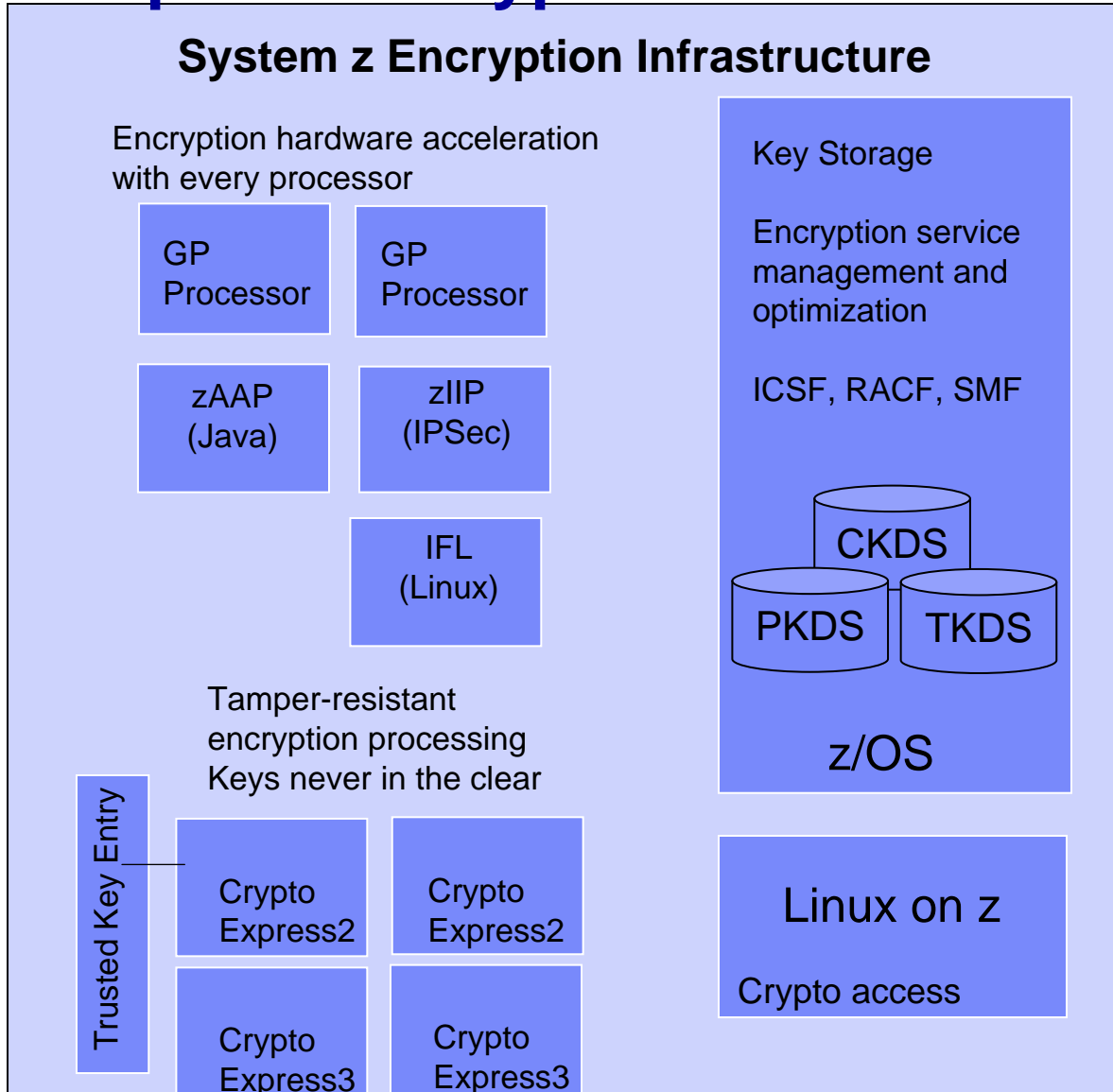

- Tape
- Disk Encryption
- Internet Access
- Web applications
- Java Applications
- Certificate Authority
- Encryption Facility File Exchange
- Databases
- Smart Cards
- POS / ATM
- zBX (zEnterprise Blades)
- Distributed Key Mgmt System (DKMS)
- ISKLM - Encryption Key Lifecycle Mgr

Protocol stack view of z TCP/IP Security Functions

Protect the system

z/OS CS TCP/IP applications use SAF to authenticate users and prevent unauthorized access to datasets, files, and SERVAUTH protected resources..

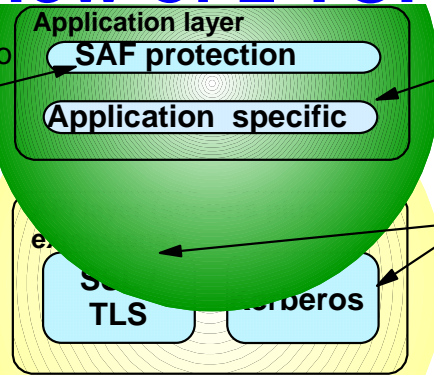

Protect data in the network

Examples of application protocols with built-in security extensions are SNMPv3, DNS, and OSPF.

Both Kerberos and SSL/TLS are located as extensions to the sockets APIs and applications have to be modified to make use of these security functions. Both SSL/TLS and Kerberos are connection-based and only applicable to TCP (stream sockets) applications, not UDP.

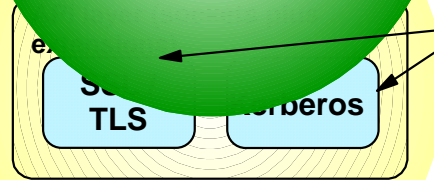

The SAF SERVAUTH class is used to prevent unauthorized user access to TCP/IP resources (stack, ports, networks)

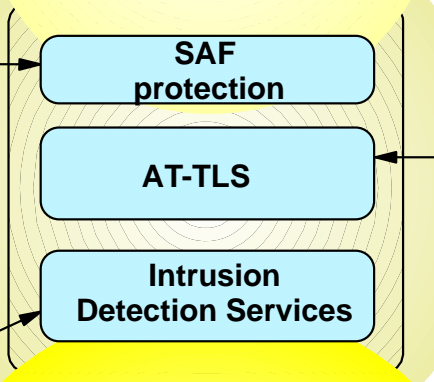

AT-TLS is TCP/IP stack service that provides SSL/TLS services at the TCP transport layer and is transparent to upper-layer protocols. It is available to TCP applications in all programming languages except PASCAL.

Intrusion detection services protect against attacks of various types on the system's legitimate (open) services. IDS protection is provided at both the IP and transport layers.

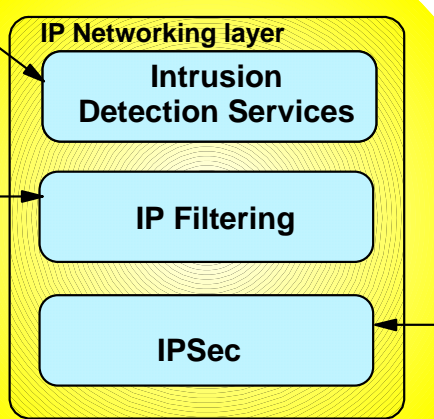

IPSec resides at the networking layer and is transparent to upper-layer protocols, including both transport layer protocol and application protocol.

IP packet filtering blocks out all IP traffic that this systems doesn't specifically permit.

zEnterprise Enhanced Security for Workloads

- Consolidated Systems
- Cloud Servers and Virtual Systems
- Data Hubs
- Security Services

Garanti Bank – Turkey: The adoption of IBM's System z reinforced Garanti's strategy to deliver fast and secure banking services 24 hours a day, ensuring fast, scalable, robust, flexible, cost-effective and **secure environment across different channels** - banking branches, ATMs, POSs, Internet and mobile channels.



Point of Sale

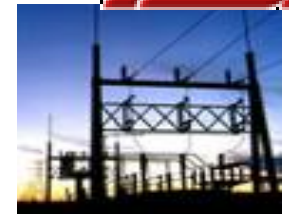

"The HP, Oracle infrastructure simply couldn't support our growing business," said Danny Gurizzan, executive vice president of operations, **Payment Solution Providers (PSP)**. "By teaming with IBM, we are actively pursuing new clients and opportunities, confident that our technology can keep pace and hold operating costs to a minimum. Further, selecting the IBM mainframe gives PSP instant credibility with potential clients thanks to its **well-known security and reliability.**"

<http://www-03.ibm.com/press/us/en/pressrelease/34329.wss>



zSecure References: Norwich Union improved efficiency and reduced errors



Business Challenge:

- Needed to facilitate compliance with identity and access management initiatives
- Needed strategic, robust solution to keep up with high demand for security and audit reports, and with often-complex security requests

Solution:

- IBM Tivoli zSecure Admin, enables efficient RACF administration with fewer resources
- IBM Tivoli zSecure Audit for RACF automatically analyses and reports on security events and exposures

“IBM Tivoli zSecure software gives us a simple, powerful way to comply with identity and access management initiatives, and to assure auditors that preventative, detective and corrective controls are installed.”

Phil Secker, Security Support Manager, Norwich Union

Allied Irish Banks streamlines compliance and risk management efforts – and stays ahead of threats



Value

- Delivered an expected reduction in administration effort
- Strengthened security efforts with deep, proactive auditing of the security configuration
- Enabled staff to respond more quickly to configuration errors and security breaches

Solution

zSecure software

Transformed the banking system completely by implementing the solution on IBM System z platform on z/OS

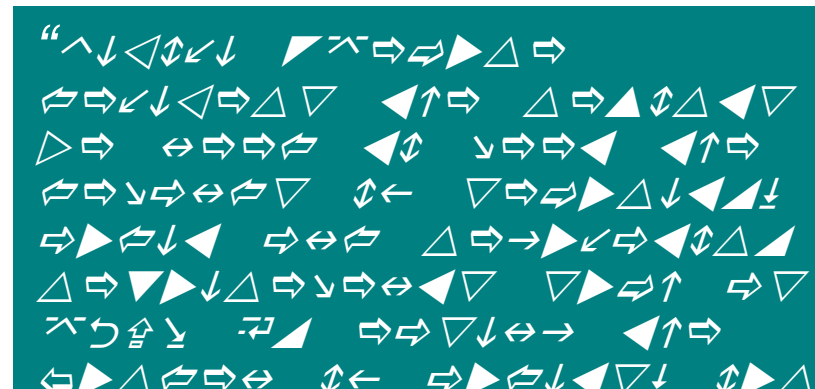

Banco do Brasil saves over \$16 M a year System z as a Certificate Authority

Requirement: Establish a more secure enterprise network after outsourcing network management

Solution:

- Created a VPN (Virtual Private Network) between each device in the network
- Established “Trust” using digital certificates
- Saved millions annually by hosting digital certificates on z/OS



- 30 million accounts
- 4,000 locations
- 20 million transactions per day
- Hosting certificates for all network devices at branch offices

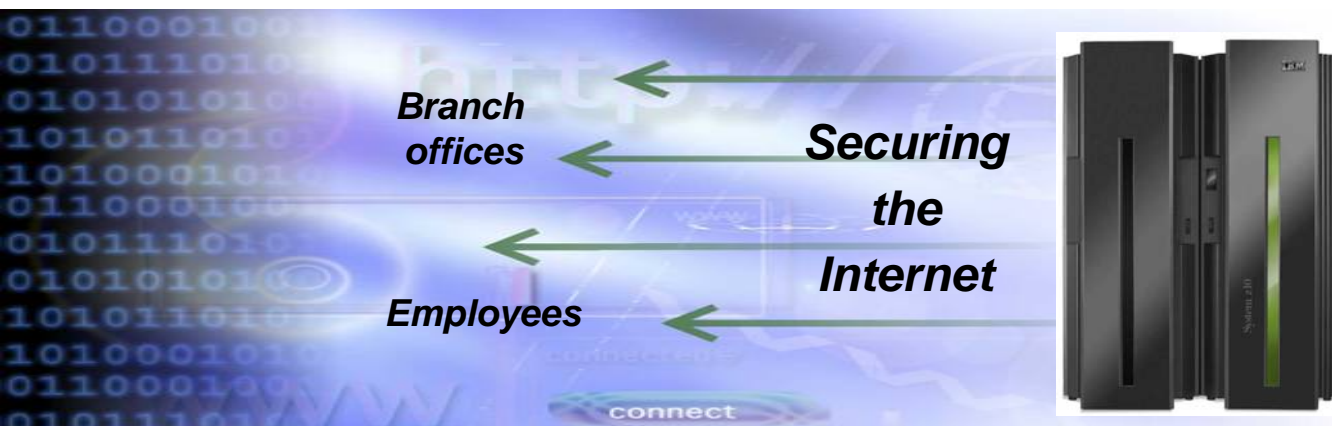

Large Bank / Payments Processor

- Migrated from Encryption Appliances to System z Infrastructure
- 6-9 Months
- Over 100 Million Encryption Transactions a day on peak days

- Other Initiatives
 - **Certificate Authority**
 - **Tape Encryption**
 - **File Encryption**
 - **Network Encryption**
 - **Secure Vault: DB2**

- Have saved over \$2million USD on Encryption Hardware

Bank Itáú Offers Secure Smart Card Solution with System z Encryption



▪ *Problem*

- To ensure the security of its 12 million issued debit cards, the Bank needed to replace its regular cards with security chip-enabled smart cards.
- Performance bottleneck with current security servers processing smart cards

▪ *Solution*

- Leverage superior mainframe security, eliminating separate security servers and migrating smart card solution to the mainframe
- ▶ Installed mainframe PCI Cryptographic Coprocessor cards
 - ▶ Encryption keys generated and stored on cards used for smart card authentication
 - ▶ Expect to scale to support 15M smart cards

▪ *Benefit*

- Reduce fraud from stronger smart card security, while lowering costs, and increased efficiency

The IBM Crypto solution offers considerable scope for expansion and is expected to comfortably support all 12 million smart cards when the rollout is complete.

PII Repository / Secure Vault on System z. Utilizing infrastructures with EAL5 and FIPS 140-2 Level 4 Security Certifications.

Tivoli Federated Identity Manager w/WebSphere

RACF w/zSecure and Communications Server

z/OS

RACF w/ zSecure Tooling

ICSF

Encryption

Data

Centralized PII (Credit Card Numbers, Social Security Numbers, Addresses, etc. stored and protected in a central repository.

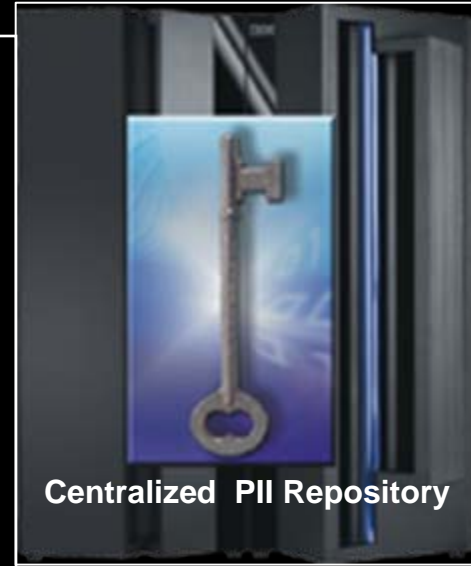

Centralized PII Repository

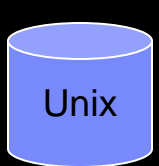
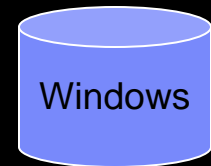
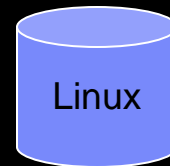

PII is no longer stored in the disparate data stores. Only the Reference Number is stored. If PII is needed, then the system will pull this information from the Central Repository.

Central Repository Structure

Unique Identifier	SS #	CC #	Address
-------------------	------	------	---------

Success:

Lockheed Martin and IBM Deliver Revamped Multi-Level Security Solution to NGA | Lockheed Martin - Microsoft Internet Explorer

File Edit View Favorites Tools Help

Back Forward Stop Home Search Favorites Refresh Mail Print Mail Stop Bluetooth

Address http://www.lockheedmartin.com/news/press_releases/2009/0915_NGA-multi-level-security.html Go Links

Home | Contact Us

Search: GO

Advanced Search

Capabilities | Global | Products | About Us | Careers | Investor Relations | News | Suppliers

News

Email Alerts

Employee News Room

Insights Magazine

LM Today Newsletter

LM1 Video News

Lockheed Martin Photo Gallery

Press Contacts

Press Kit

Press Releases

Speeches

Video Gallery

Home > News

Lockheed Martin and IBM Deliver Revamped Multi-Level Security Solution to NGA

New System Manages Secure Data Access for Users Worldwide

Herndon, Va., September 15th, 2009 -- Lockheed Martin [NYSE: LMT] and IBM [NYSE: IBM] have delivered a new information security system to the National Geospatial-Intelligence Agency (NGA), one that carefully manages multiple levels of security to give users worldwide more reliable, secure access to classified data. The new system replaces older, customized and labor-intensive technology with a streamlined, commercially-based architecture that performs better, costs less, and can grow to manage multiple security levels.

"Multi-level security is all about exercising the right amount of control over critical data. Users need to collaborate, share data between agencies, and access information from the field, but the system must ensure that those users are only accessing data they're authorized to have," said Jerry Mamrol, Lockheed Martin's GeoScout Program Director. "This new solution improves NGA's ability to ensure that the right data gets to the right users, and not to anyone else."

The previous system was designed in the 1980s and was built with very specific, custom technology that performed well but required significant time and resources to operate and maintain. In an effort to reduce costs and simplify the overall system baseline, Lockheed Martin worked with IBM to adapt their COTS mainframe and operating system so that it would meet the NGA's stringent requirements for multi-level security. Lockheed Martin collected user requirements from across the federal government to ensure that the system would "plug and play" with NGA's mission partners. IBM then adapted those requirements into their upgraded System Z baseline, which was put through a rigorous test and evaluation process before earning the government's Protection Level 3 Certification.

The new, improved system offers many benefits over the previous system. Because it is built on a standard commercial baseline and not custom technology, it costs significantly less to operate and maintain. In addition, it is designed to evolve gracefully to accommodate new levels of classification, making it adaptable to a wide range of classified mission needs.

"This is a great example of how the robust security capabilities at the core of our commercial technology can be applied to the security challenges facing the Intelligence Community. This commercial technology enhancement saves time and money, improves performance, and enables the NGA and Lockheed Martin to use more of their resources in mission-level innovation," said David McQueeney, IBM's Federal CTO. "Multi-level security is a critical part of meeting the government's challenge to share information responsibly, and we're pleased to be working with Lockheed Martin to deliver a certified multi-level system for the NGA."

Done Internet

Ways to get started.....

But I don't know anything about security, risk..

How can I work with the Chief Security Officer or Chief Risk Officer?



End to End Entry Points to Success

<http://www-03.ibm.com/security/>

- Security, Risk Assessment
 - Auditing / Compliance Reporting for RACF / ACF2
 - Services Engagement: can be high level or detailed
- Executive Security, Risk, Fraud, and Compliance Briefing
 - End to End Executive Session on IBM Strengths
- Security, Risk Workshop
 - Focuses on Particular Initiative

Elements of System z Security

An Ecosystem that leverages the System z Hardware

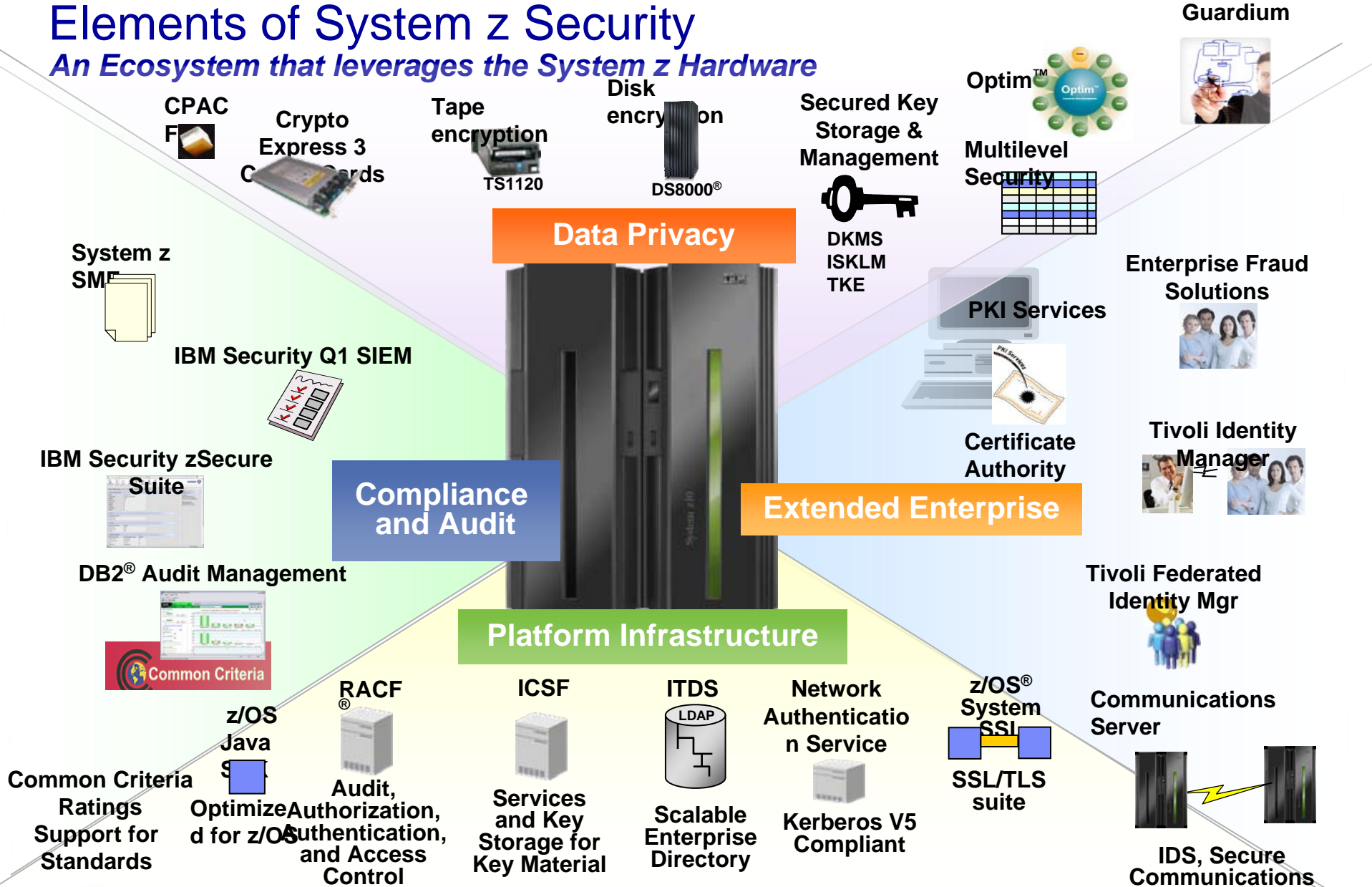

X-Force 2011 Trend Report: Challenges of cloud security

- We saw a number of high profile cloud breaches in 2011 affecting well-known organizations and large populations of their customers
- Customers looking at cloud environments should consider:
 - Cloud-appropriate workloads
 - Appropriate service level agreements (SLAs)
 - Lifecycle approaches to deployment that include exit strategies should things not work out

Securing access to cloud-based applications and services

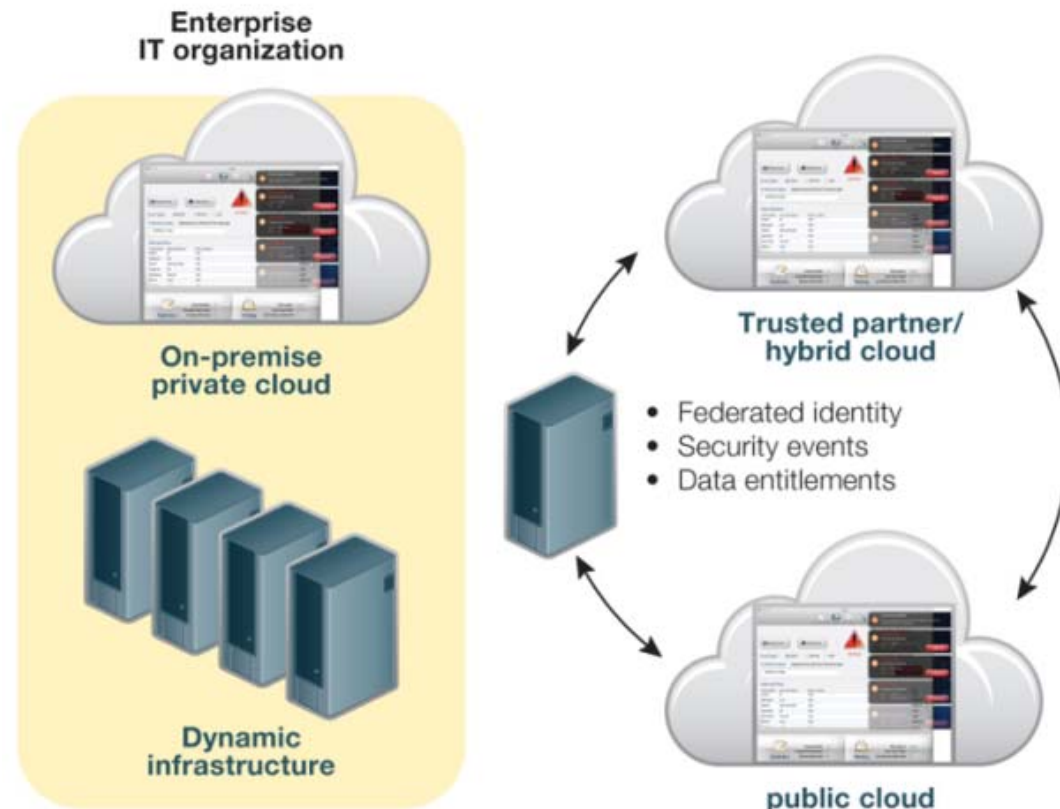

System z has been running a cloud-centric environment for 40+ years, do the same issues exist?



Cloud Computing

Security is one of the top concerns of cloud, as enterprises drastically rethink the way IT resources are designed, deployed and consumed

Our focus is in two areas of cloud security

1 Security from the Cloud

**Cloud-based
Security Services**

Use cloud to deliver security **as-a-Service** - focusing on services such as vulnerability scanning, web and email security, etc.

2 Security for the Cloud

**Public cloud
Off premise**

Secure usage of **Public Cloud applications** – focusing on Audit, Access and Secure Connectivity

Securing the Private Cloud stack – focusing on building security into the cloud infrastructure and its workloads

**Private cloud
On premise**

IBM Project Green - Virtualization Hub

- Expecting substantial savings in multiple dimensions: energy, software and system support costs
- The consolidated environment will use 80% less energy
- This transformation is enabled by the System z's sophisticated virtualization capability
- Provides world class security

IBM'S PROJECT BIG GREEN SPURS GLOBAL SHIFT TO LINUX ON MAINFRAME



Plan to shrink 3,900 computer servers to about 30 mainframes targets 80 percent energy reduction over five years

Optimized environment to increase business flexibility

ARMONK, NY, August 1, 2007 – In one of the most significant transformations of its worldwide data centers in a generation, IBM (NYSE: IBM) today announced that it will consolidate about 3,900 computer servers onto about 30 System z mainframes running the Linux operating system.

United States [change]

Home Solutions Services Products Support & downloads My IBM Welcome [IBM Sign in] [Register]

Green IT

Green technology

Green technology services

Technology recycling

Case studies

News and events

Resource library

Related links

- Smarter computing
- Business partners
- IBM Global Financing
- Solutions for small & mid-sized businesses
- Asset management
- Cloud computing
- Information infrastructure
- Managed support services
- Outsourcing
- Security
- Service Management
- Virtualization

Green IT

Energy efficiency solutions

Comprehensive data center solutions for power and cooling efficiency

Why IBM for a green IT

Issues and opportunities around energy, the environment, and sustainability impact every individual and every business, worldwide. With data centers using 10-30 times more energy per square foot than office space, data center energy use doubling every 5 years, and delayed capital investments in new power plants—energy efficiency is becoming a key metric of IT operational effectiveness. And a green IT strategy is becoming a necessity. A flexible, secure, [dynamic infrastructure](#) can help customers address critical energy and power costs. By combining hardware, software and services offerings, IBM can help companies improve service, better manage risk, and resolve resource constraints—all while reducing overall energy costs by 15-40%.

We're here to help

Easy ways to get the answers you need.

- Chat now
- E-mail IBM

Or call us at: 1-866-883-8901
Priority code: 6N8AJ42W

Security

Economics

Energy Efficiency

Did you know there is a RACF zVM? Linux on z workloads.

Customer Example of Utilizing RACF zVM and LDAP zVM

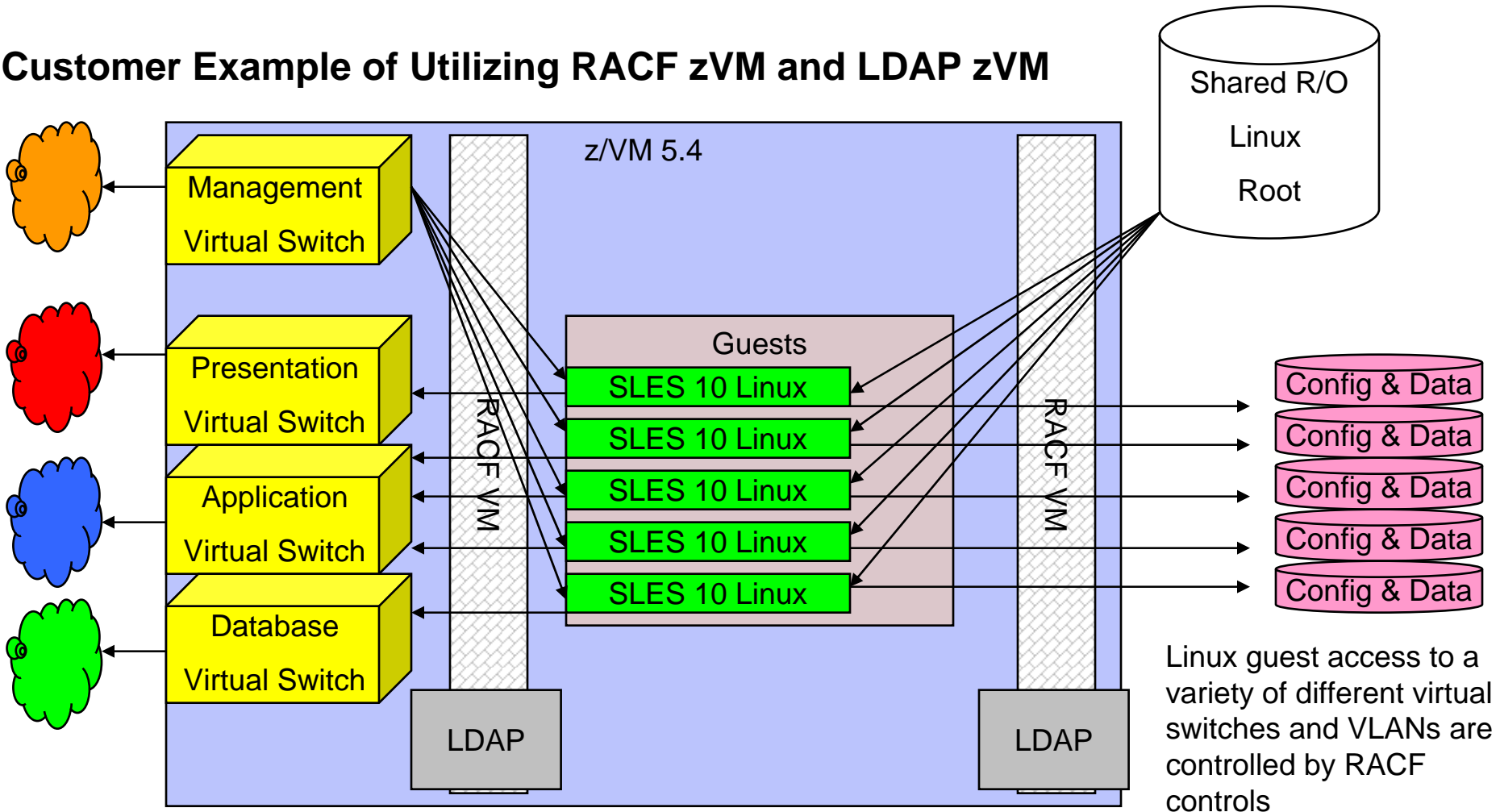

Encryption Management & Controls



Looking for a Secure, Proven Cloud Infrastructure: System z



Security for the Cloud

Public / Private Cloud
Secure Application Hosting
Secure Data Vault

Security from the Cloud

Trusted Identities
Fraud, Risk Analytics
Data Protection



**Securing Cloud
with IBM Security Systems**

Security Intelligence • People • Data • Apps • Infrastructure

Security Services for the Enterprise

- A sampling of Recent 3rd Party Vendor Solutions
- Security Services to run on the System z Cloud





ibm.com/security

© **Copyright IBM Corporation 2012. All rights reserved.** The information contained in these materials is provided for informational purposes only, and is provided AS IS without warranty of any kind, express or implied. IBM shall not be responsible for any damages arising out of the use of, or otherwise related to, these materials. Nothing contained in these materials is intended to, nor shall have the effect of, creating any warranties or representations from IBM or its suppliers or licensors, or altering the terms and conditions of the applicable license agreement governing the use of IBM software. References in these materials to IBM products, programs, or services do not imply that they will be available in all countries in which IBM operates. Product release dates and/or capabilities referenced in these materials may change at any time at IBM's sole discretion based on market opportunities or other factors, and are not intended to be a commitment to future product or feature availability in any way. IBM, the IBM logo, and other IBM products and services are trademarks of the International Business Machines Corporation, in the United States, other countries or both. Other company, product, or service names may be trademarks or service marks of others.