

A decorative graphic in the top left corner consists of several overlapping semi-circles of various colors, including shades of orange, yellow, purple, and blue, arranged in a cluster.

The Gold Standard for Enterprise Computing

Business Analytics on the Ultimate Data Platform

Analyzing *all* the data about customers adds business value

Data Source

Analysis

Business Value

Traditional RDBMS



Analyze all customer records across departments

Complete view of customer value to the company

External Data



Analyze customer sentiment and experience

Attract and retain customers

Real Time Data



Analyze customer data as it happens

Personalize customer interaction in real time

DEMO: Gain a 360° view of customers to help improve profitability

- Identify good customers who have made complaints on Twitter
- Combined data from Twitter with mortgage data in the data warehouse
- Build report with Cognos Report Studio to show complete customer profile

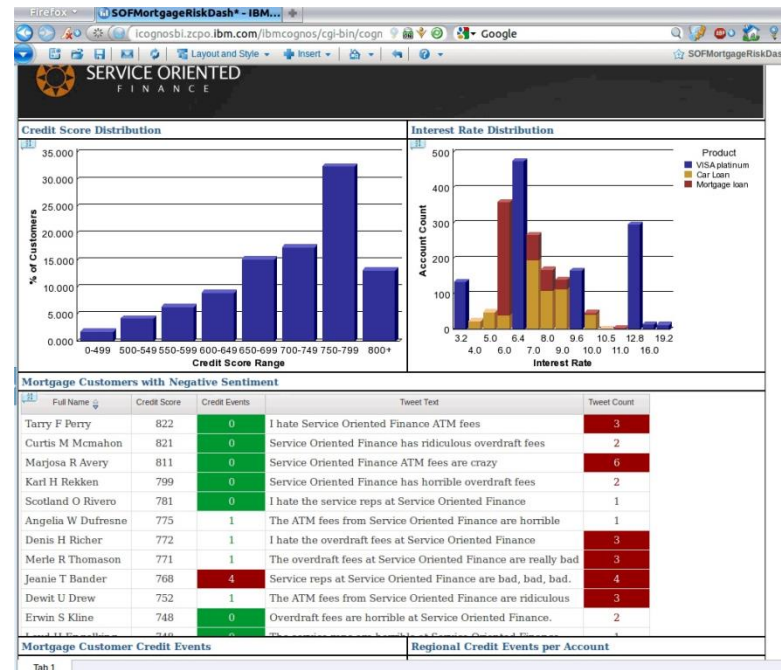
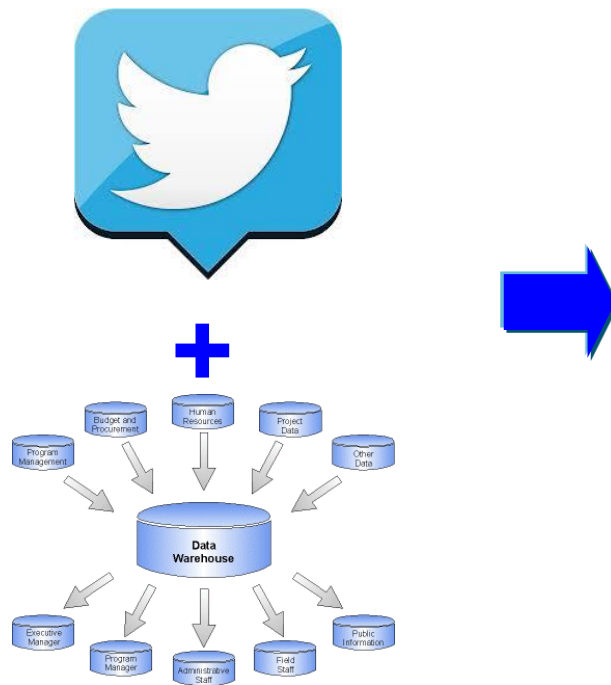

Leading businesses are using IBM analytics to gain a competitive advantage

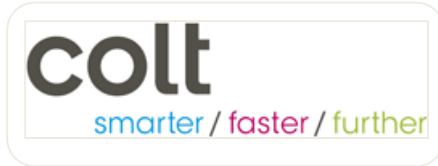

Technology services company **saves USD 1.9M** annually through improved business intelligence



Japanese internet company analyzes and processes 18M transactions/hour, to increase **subscribers by 100%**



Reduced the time to analyze complex GIS data from **days to minutes** - a **98% improvement**

The more analytics a business uses, the better it performs



Supermarket chain increased annual **revenues by 30%**



Enabled **600 percent growth** in mobile solutions and **200 percent growth** in internet banking



Healthcare alliance improves patient outcomes while **reducing spending by USD 2.85B**

60-70% of operational data resides on System z...

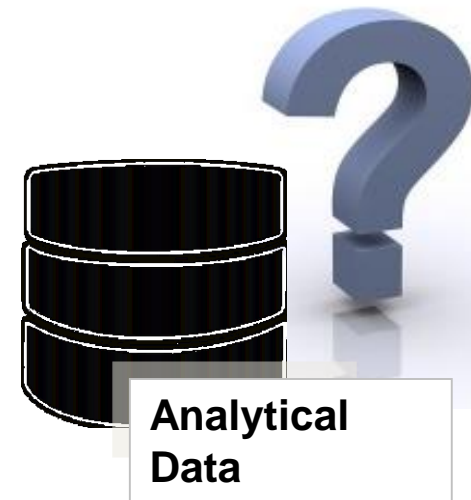

Yet, some customers do not perceive System z as a viable platform for data warehouse and analytics

So what happens?

They adopt an extremely expensive ETL strategy to support analytics

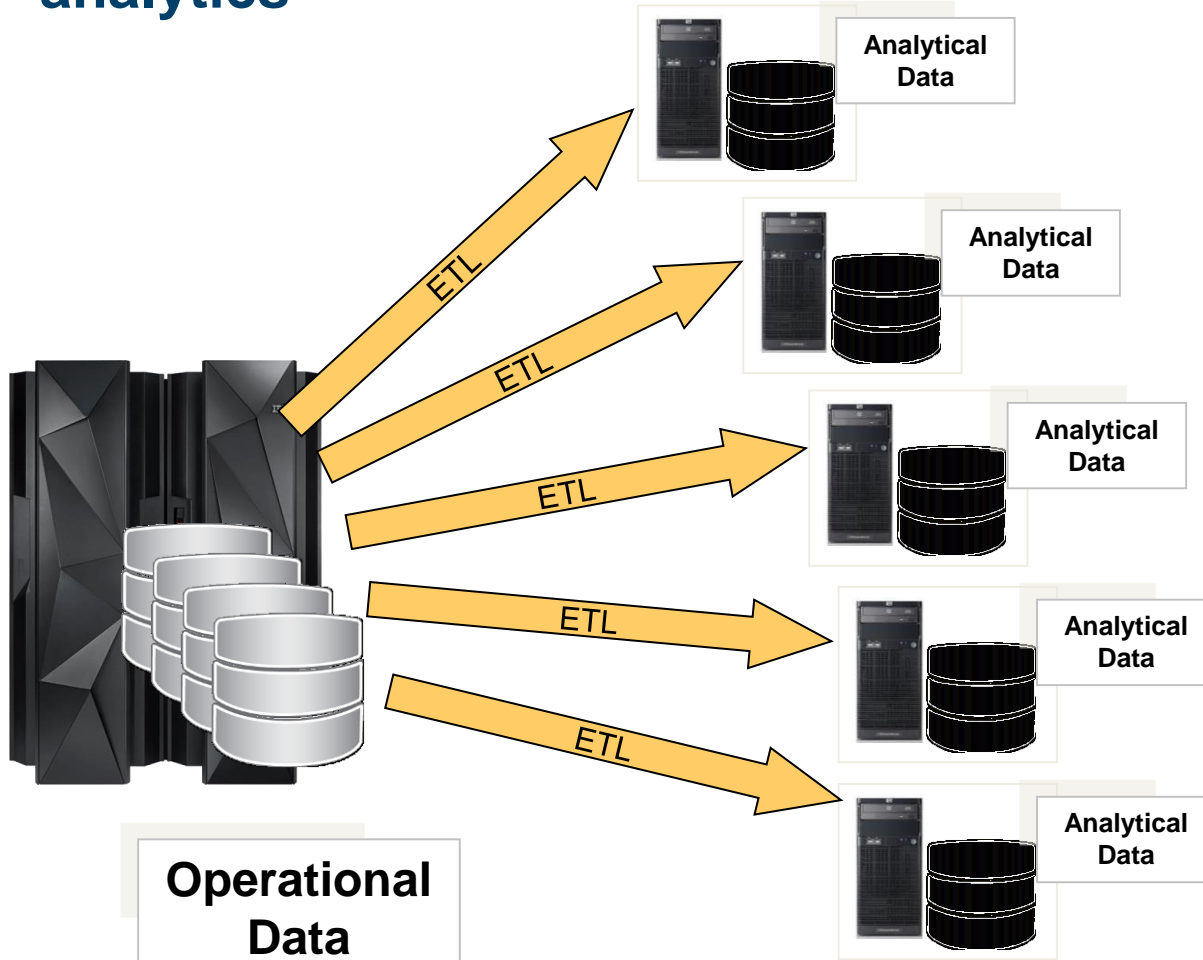

A large European bank:

- 120 database images created from bulk data transfers
- 1,000 applications on 750 cores with 14,000 software titles
- ETL consuming 28% of total distributed cores and **16% of total MIPS**

A large Asian bank:

- One mainframe devoted exclusively to bulk data transfers
- ETL consuming 8% of total distributed core and **18% of total MIPS**

With this strategy, IT costs grow faster than business growth

This leads to significant data transfer costs

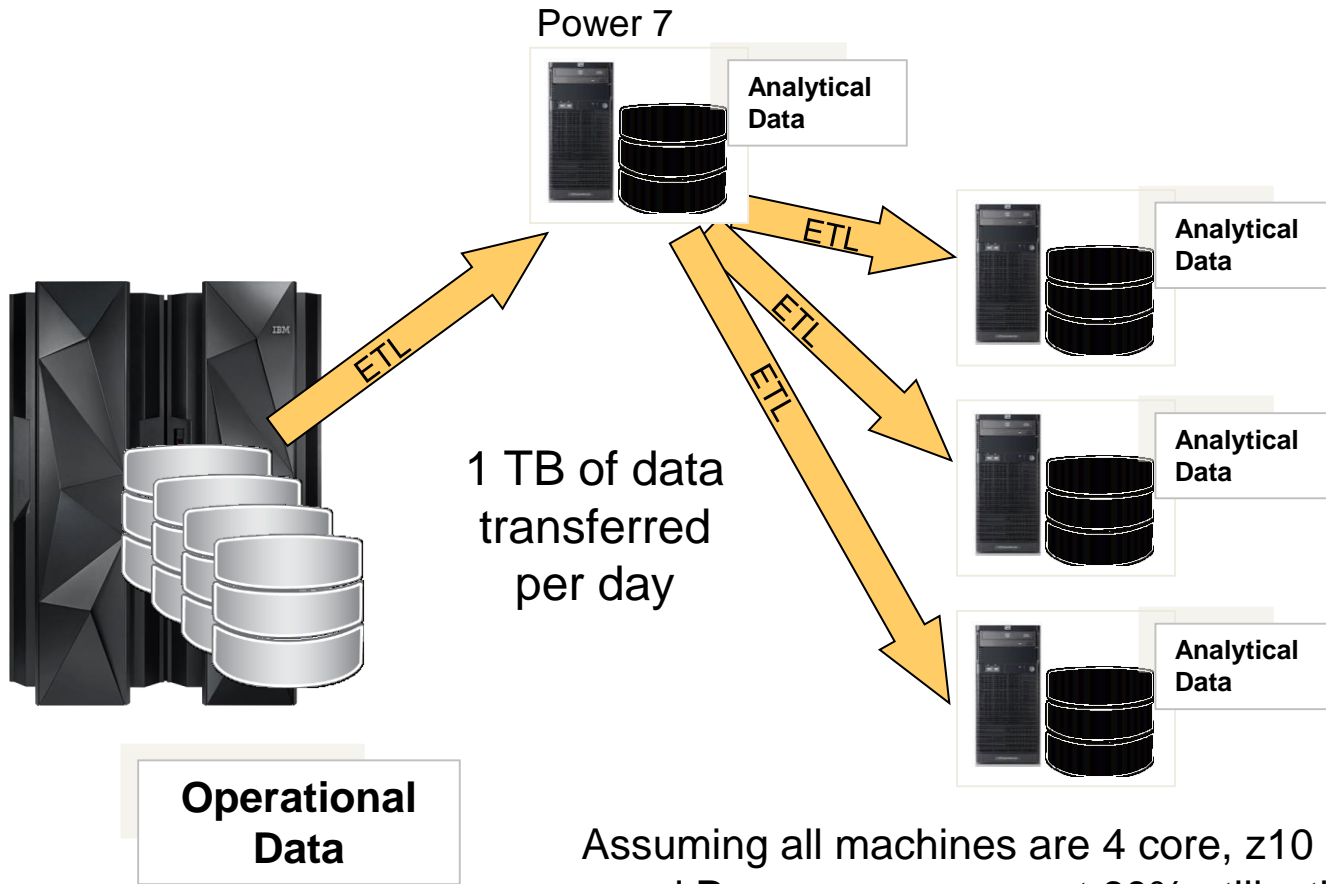

4 yr. amortized cost summary

System costs	= \$8.0M
Labor costs	= \$0.2M
Total	= \$8.2M

Assuming all machines are 4 core, z10 runs at 85% utilization and Power servers run at 60% utilization, transfer will burn **557 MIPS** and use **21 distributed cores per day**

The best-fit solution – *Move analytics closer to the data*

*Full function operational business intelligence
AND business analytics on the same platform*

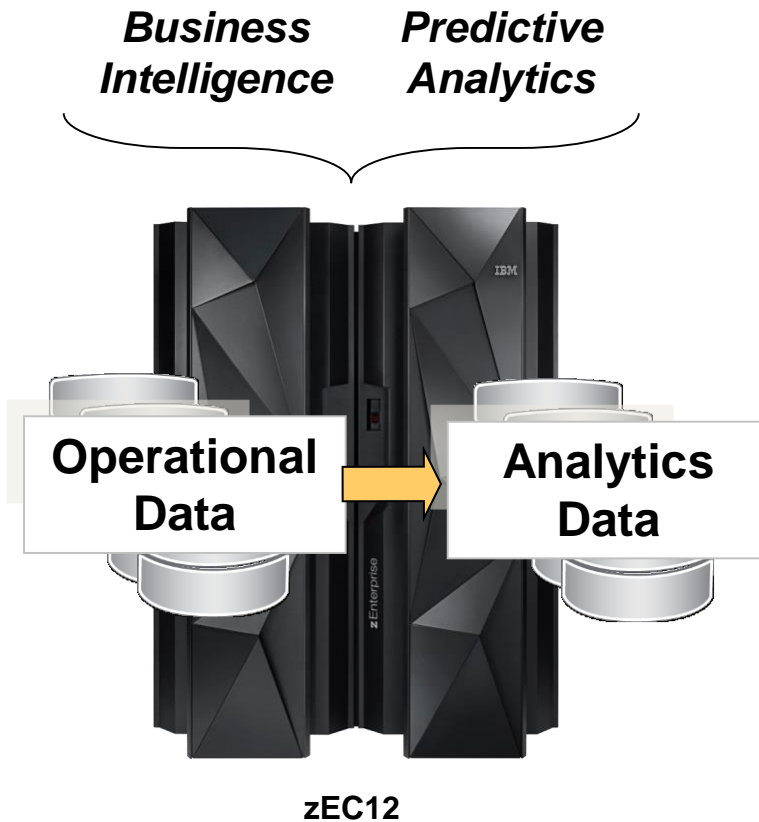

Benefits

- Reduce data transfer costs
- Run analytics in separate partition
- Achieve lowest cost for analytics workloads
- Enable application queries on real-time data
- Easier to surround data with highest levels of security
- Simplifies management

**DB2 for z/OS –
the enterprise standard for
operational and business analytics**

DB2 for z/OS is a first class platform for operational business intelligence queries

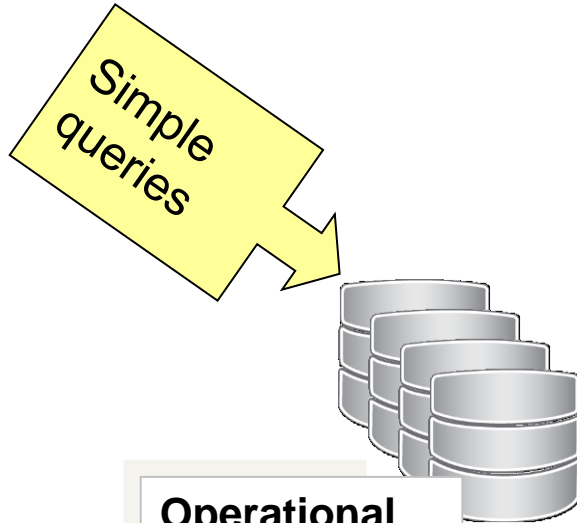

- z/OS Workload Manager optimizes resource sharing to minimize impact on OLTP performance
- Parallel sysplex yields near-linear scaling and high availability
- DB2 Cost Based Optimizer provides best access path and query execution plan

Operational Data

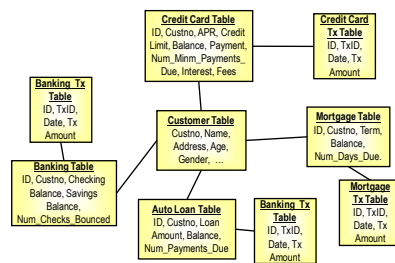

zEnterprise EC12

DB2 for z/OS supports up to 20,000 concurrent connections per subsystem

Up to 22% CPU savings with DB2 11!

Source: IBM internal study

Upgrade to DB2 11 for z/OS to achieve more operational analytics throughput for the same cost

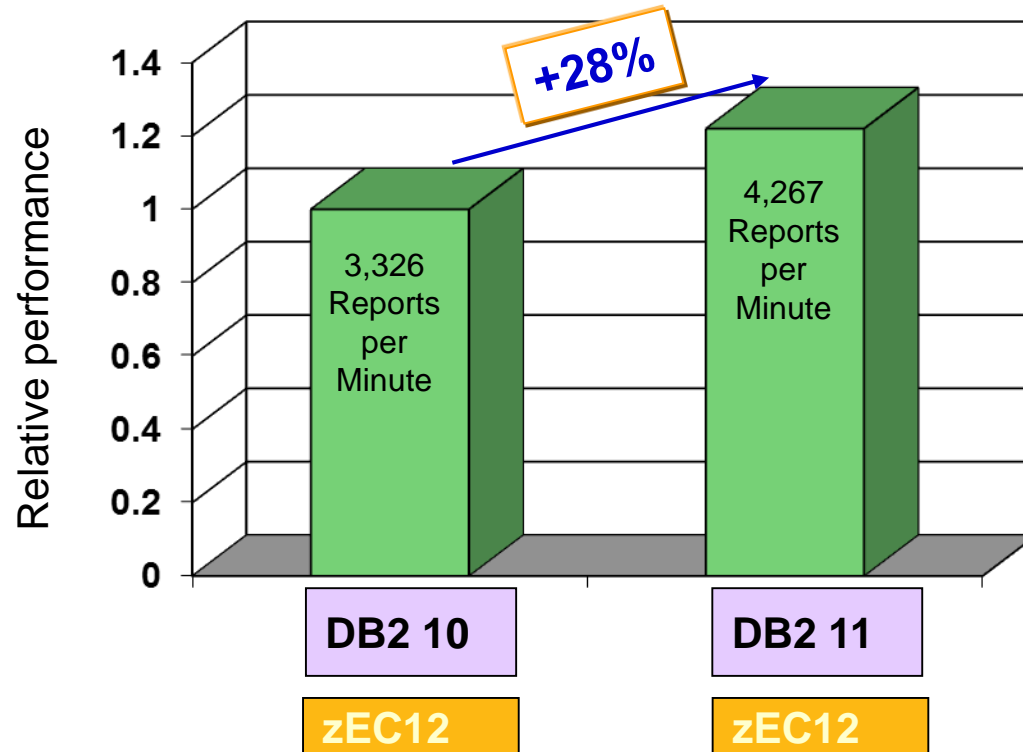

IBM internal analytics workload (BI Day)

Workload consisted of 160,860 Cognos BI Day simple reports. Both tests used 10 CPs and ran at 100% utilization. Results may vary based on customer workload profiles/characteristics.

DB2 for z/OS is also optimized for data warehouse queries

- Data is partitioned to increase parallelism, and compressed to increase I/O performance
- DB2 Cost Based Optimizer decides best execution plan for each query
 - Complex queries decomposed into operations that execute in parallel
 - Queries may be automatically rewritten to take advantage of pre-computed query tables

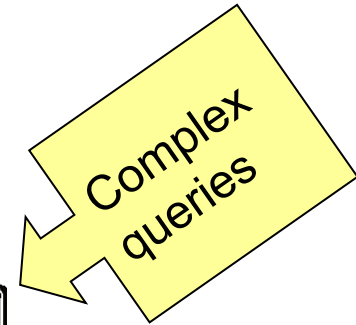

Analytical Data

Data Warehouse workloads typically include a mix of simple, intermediate and complex queries

Up to 40% CPU savings with DB2 11!



zEnterprise EC12

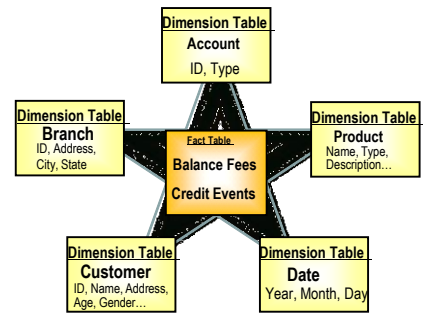

Source: IBM internal study

Add IBM DB2 Analytics Accelerator to speed up deep analytics queries

- A workload-optimized, blade-based appliance based on Netezza Technology that runs queries in seconds versus hours
- Integrated with DB2 for z/OS, and transparent to applications
 - Storage integrated into the hardware rack
 - Pre-load data from DB2 for z/OS at over 400GB/hr
 - Maintain a single copy of data in Accelerator and update incrementally
 - System z workload management works across the Accelerator
- Drives down the costs of data warehousing and business analytics



IBM DB2 Analytics Accelerator executes complex queries significantly faster

Query	DB2 (Secs)	DB2 + Analytics Accelerator (Secs)	Speed Up	Rows Reviewed	Rows Returned
Query 1	9,540	5	1,908x	2,813,571	853,320
Query 2	8,220	5	1,644x	2,813,571	585,780
Query 3	4,560	6	760x	8,260,214	274
Query 4	4,080	5	816x	2,813,571	601,197
Query 5	4,080	70	58x	3,422,765	508
Query 6	3,180	6	530x	4,290,648	165
Query 7	3,120	4	780x	361,521	58,236
Query 8	2,640	2	1,320x	342,529	724
Query 9	2,520	193	13x	4,130,107	137



DEMO: DB2 Analytics Accelerator

Compare DB2 BI Day query processing using the IBM DB2 Analytics Accelerator

BI mixed Workload with IBM DB2 Analytics Accelerator for z/OS

Demo time in minutes: 1

Start Queries
Stop Queries
Reset Demo

Count-down seconds: 0

10 **Concurrent call center users - operational BI**

Run	1	2	3
IDAA status	disabled	enabled	
Concurrent users	10	10	
Queries started	891	939	
Queries completed	891	939	
Avg. resp. time (s)	0.17	0.13	

2 **Concurrent power users - complex ad-hoc reports**

Run	1	2	3
IDAA status	disabled	enabled	
Concurrent users	2	2	
Reports started	4	72	
Reports completed	2	72	
Avg. resp. time (s)	50.88	1.23	

Setup

SYS1,*PROCESSOR -- % CPU utilization (CP) [8D0460]
 Time Range: 05/29/2012 15:16:45 - 05/29/2012 15:17:00

16 █

SYS1,*PROCESSOR -- % MP on CP [8D3550]
 Time Range: 05/29/2012 15:16:45 - 05/29/2012 15:17:00

8 █

SYS1,*IO_SUBSYSTEM -- i/o activity rate [8D0E90]
 Time Range: 05/29/2012 15:16:45 - 05/29/2012 15:17:00

NaN

SYS1,*PROCESSOR -- # CP processors online [8D0D20]
 Time Range: 05/29/2012 15:16:45 - 05/29/2012 15:17:00

3 █

DB2 Analytics Accelerator Status: enabled

```

ACCELERATOR          MEMB  STATUS  REQUESTS  ACTV  QUED  MAXQ
-----
DEMOIDAA             DSN9  STARTED          69    0    0   12
LOCATION=DEMOIDAA    HEALTHY
DETAIL STATISTICS
LEVEL = AQT02012
STATUS = ONLINE
FAILED QUERY REQUESTS          =          0
AVERAGE QUEUE WAIT             =         62 MS
MAXIMUM QUEUE WAIT              =        195 MS
TOTAL NUMBER OF PROCESSORS      =          24
AVERAGE CPU UTILIZATION ON COORDINATOR NODES =         1.00%
AVERAGE CPU UTILIZATION ON WORKER NODES    =         1.00%
NUMBER OF ACTIVE WORKER NODES   =           3
TOTAL DISK STORAGE AVAILAELE    =    8024544 MB
TOTAL DISK STORAGE IN USE       =     13.53%
DISK STORAGE IN USE FOR DATABASE =     79361 MB
DISPLAY ACCEL REPORT COMPLETE
DSN9022I  -DSN9 DSNX8CMD  '--DISPLAY ACCEL' NORMAL COMPLETION
                    
```

Enable Accelerator
Disable Accelerator
Display Status

14

02. Business analytics on the ultimate data platform

© 2014 IBM Corporation

zEnterprise is optimized for business analytics

Standalone Pre-integrated Competitor V3

Quarter Unit



Unit Cost (3yr TCA) \$481/RpH

Workload Time (mins)	1,318
Reports per Hour (RpH)	7,337

IBM zEnterprise with Analytics Accelerator

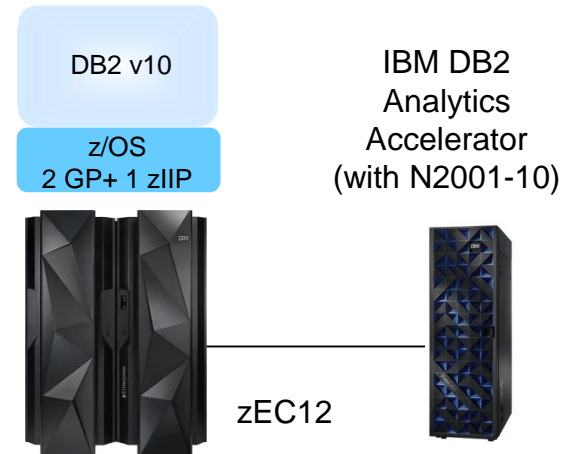

Unit Cost (3yr TCA) \$46/RpH

Workload Time (mins)*	148
Reports per Hour (RpH)	65,338

**9x performance
10x price performance!**

Source: Customer Study on 10TB BIDAY data running 161,166 concurrent reports. Intermediate and complex reports automatically redirected to IBM DB2 Analytics Accelerator for z/OS. Results may vary based on customer workload profiles/characteristics. Note: Indicative 9710 pricing only internal to IBM, quotes to customer require a formal pricing request with configurations.

zEnterprise is optimized for business analytics

Traditional Data Warehouse Competitor



Unit Cost (3yr TCA) \$330K/QpH

Workload Time (secs)*	1,591
Queries per Hour (QpH)	9

IBM zEnterprise with Analytics Accelerator

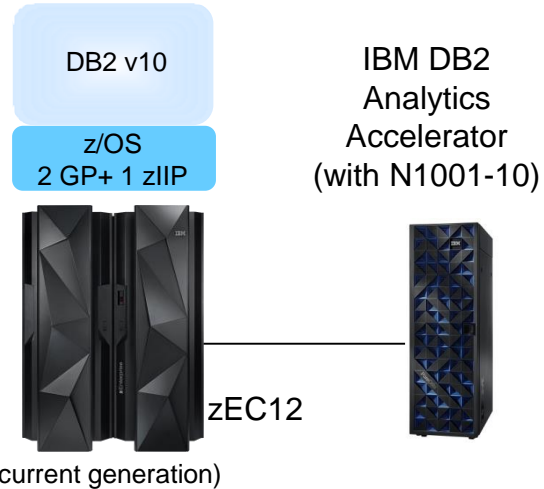

Unit Cost (3yr TCA) \$10K/QpH

Workload Time (secs)*	61
Queries per Hour (QpH)	236

26x performance
33x price performance!

Customer Study on 10TB BI Day data running 161,166 concurrent reports. Intermediate and complex reports automatically redirected to IBM DB2 Analytics Accelerator for z/OS. Results may vary based on customer workload profiles/characteristics.

zEnterprise is optimized for business analytics

In-memory Database Competitor
40 Intel Westmere cores
512GB RAM
8x900 HDDs
1.2TB SSD



Unit Cost (3yr TCA) \$72/RpH

Workload Time (mins)	302
Reports per Hour (RpH)	32,020

**IBM zEnterprise
with Analytics Accelerator**

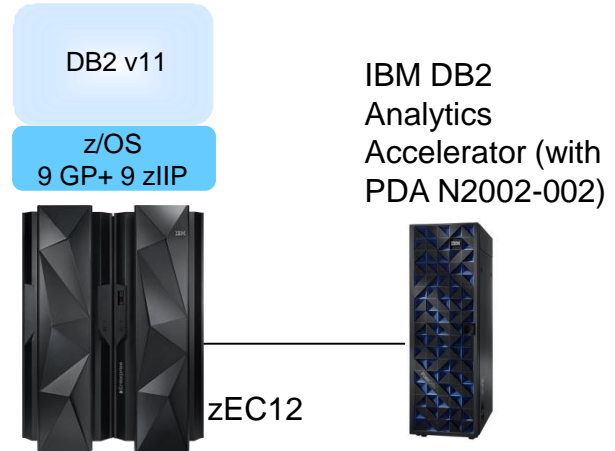

Unit Cost (3yr TCA) \$10/RpH

Workload Time (mins)*	24
Reports per Hour (RpH)	402,915

13x performance
7x price performance!

Results may vary based on customer workload profiles/characteristics. * Results projected from IBM DB2 Analytics Accelerator V4.1 with N2002-002 hardware and DB2 11 for z/OS on zEC12-710 hardware

Swiss Mobiliar uses IBM DB2 Analytics Accelerator to deliver actionable insights



Need:

Cost-effective way to deliver complex analysis for eligibility and excess requirements for insurance products

Solution:

Implemented DB2 Analytics Accelerator and zEnterprise to provide transaction processing and analytics workloads in a cost-effective solution

50%

of the queries performed 100 times faster

20 seconds

to complete queries that took 5 hours

“ IBM DB2 Analytics Accelerator enables us to support the additional workloads that come with business growth without activating more cores on the mainframe. ”

Run a complete portfolio of operational and analytics software on IBM zEnterprise EC12

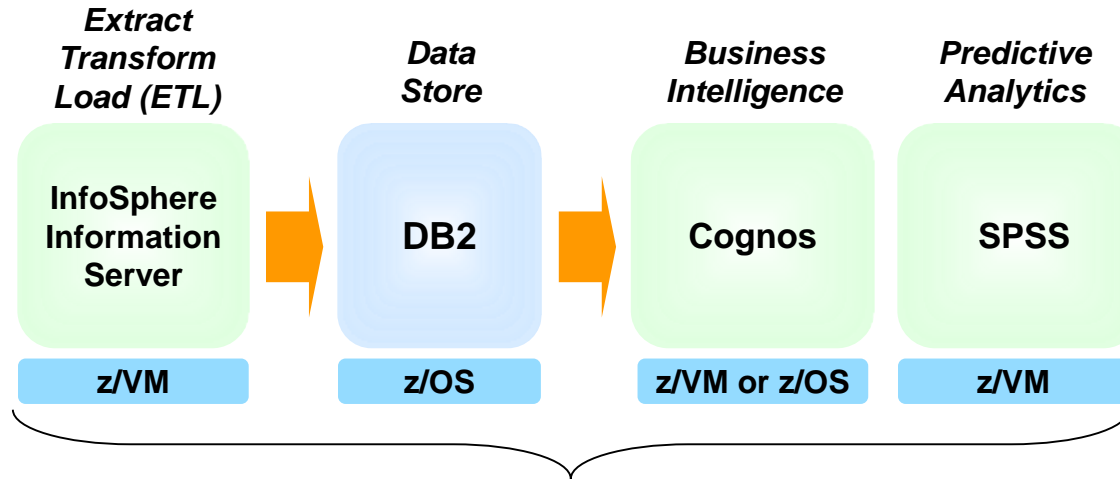

IBM zEnterprise Analytics System 9700 –

A comprehensive packaged solution including hardware, OS, and business analytics software

FastStart Service Pack

Data Integration Pack

Data Analytics Pack



zEnterprise

IBM DB2 Analytics Accelerator

Business analytics answer key questions and drive a competitive edge

Descriptive Analytics:

- Insight into what has happened
- Provides reports/dashboards
 - Aggregate and drill-down on data using different dimensional attributes such as by date, geography, demographics, etc.
- Visualize data using interactive charts, graphs, maps and other objects

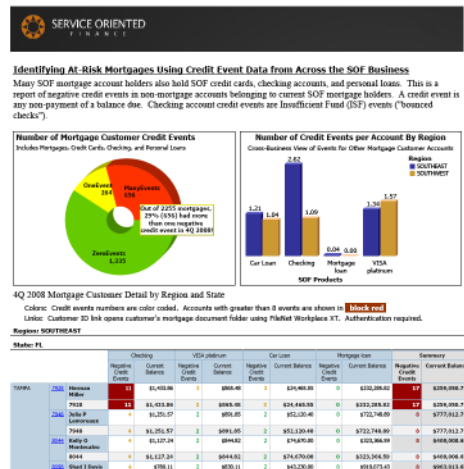

IBM Cognos Enterprise

Predictive Analytics:

- Predicts what might happen
- Provides scores that helps in optimized decision support
 - Build models using historical data and mathematical algorithms such as clustering or classification
- Some models provide rules that can be integrated into business processes

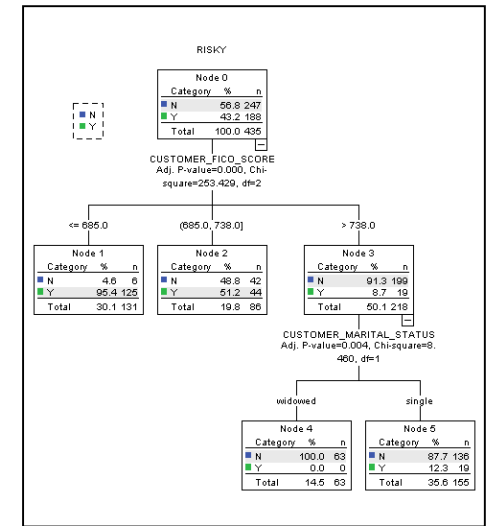

IBM SPSS Statistics and Modeler

IBM Blue Insight uses System z platform to deploy an internal private analytics cloud

Project Scope

- Consolidated 390+ reporting projects onto zEnterprise running Cognos BI
- Today, supports over 200K users and generates over 2M reports/quarter
- Savings of over 74K sq. ft. floor space and 30K MWh energy; user cost reduced 90%

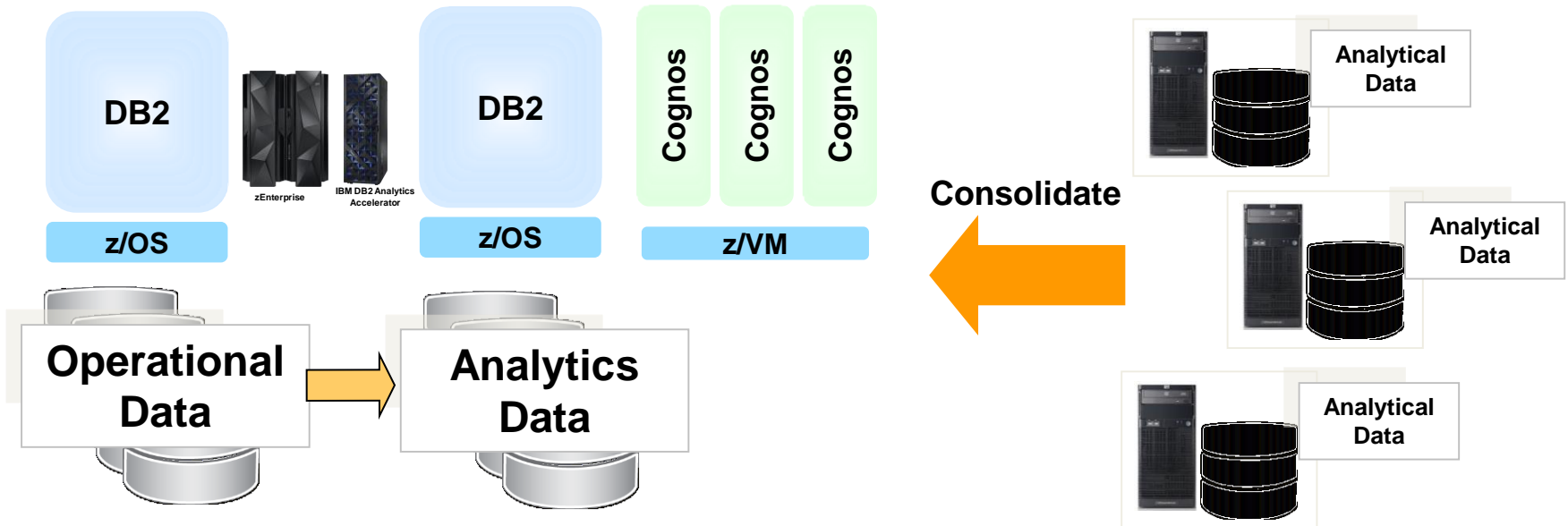

“ Our commitment to informed decision-making led us to consider private **cloud delivery of Cognos via System z**, which is the enabling foundation that makes possible **+\$25M savings over 5 years.** ”

-- IBM CIO Office

Miami-Dade County runs IBM Cognos on business class mainframes

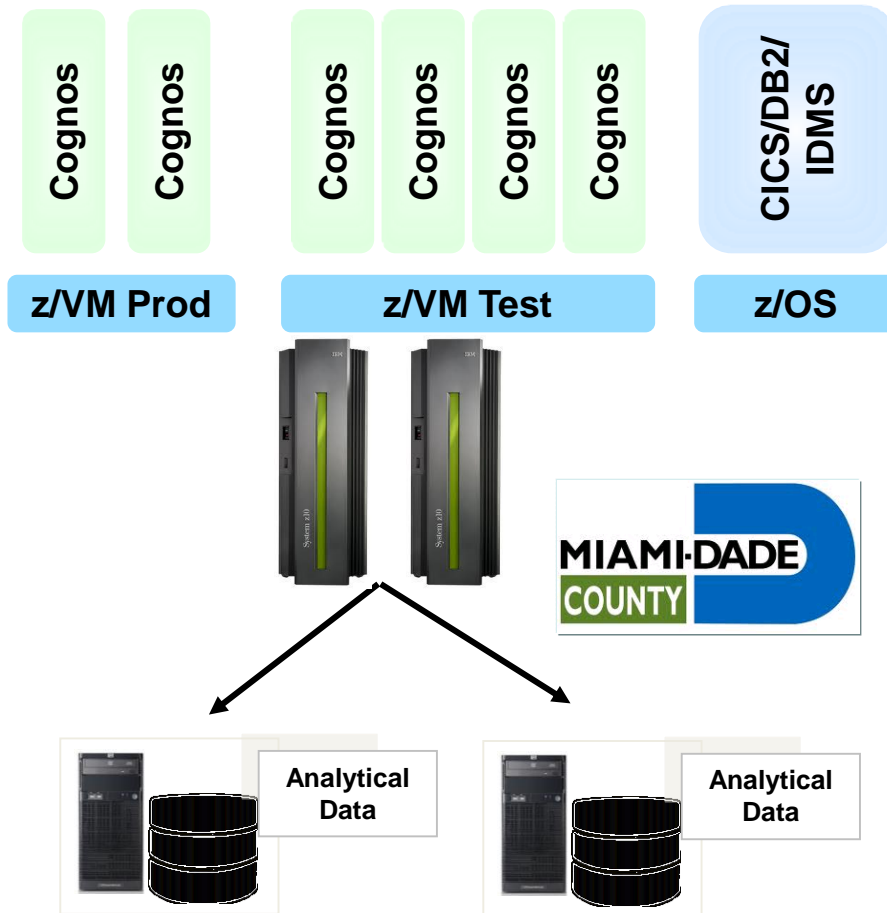

- Moved Cognos BI deployment from Intel servers to System z in 11 days
 - Consolidated multiple deployments to a single platform
 - Consolidated multiple disparate data sources
- Single point for BI administration
- Added a complete disaster recovery plan
- Easily met requirements for growth, 24x7 availability and TCO savings

“We have users from 25 County Service departments with almost 2000 users consuming and creating reports with stable environments on System z”

- Jaci Newmark, Miami-Dade County

Predictive analytics helps businesses run smarter

Turn a Call Center in a Profit Center

A large Dutch financial services company generated **\$30 Million in incremental sales** when 1M calls generated 180,000 suggestions, leading to 22,000 new sales.

Prevent crime before it happens

A large city in the US optimized deployment of police resources, **reducing homicides by 35%** year over year, and robberies by 20%.

Turn clients into advocates

A large Swiss telecom adopted a client retention approach based on satisfaction – and **reduced churn from 14% to 2%**.

Reduce the cost of claims

A large US insurer maximized and accelerated their collections process, achieving an **ROI of 403% with payback in 3 months**.

DEMO: Use predictive analytics to better understand and proactively address customer dissatisfaction

Problem: A bank is dealing with unhappy customers

- Use Cognos Active Report with RAVE visualization to zero-in on most common complaints (ATM charges and overdraft fees)

Solution: Use predictive analytics to better characterize customers

- Target these customers differently to improve their satisfaction levels

- Load data from Data Warehouse on DB2 for z/OS into SPSS Statistics
- Select good customers based on high credit scores tweeting negatively about ATM fees or overdraft fees
- Run Decision Tree to discover rules for characterizing customer complaints about overdraft and ATM fees

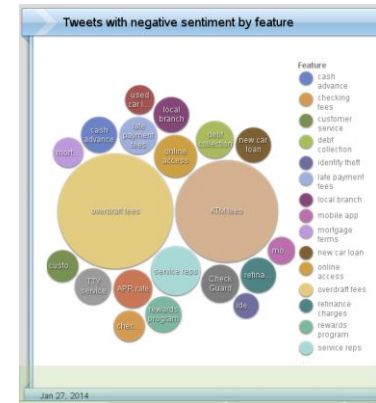

Key features with negative sentiments

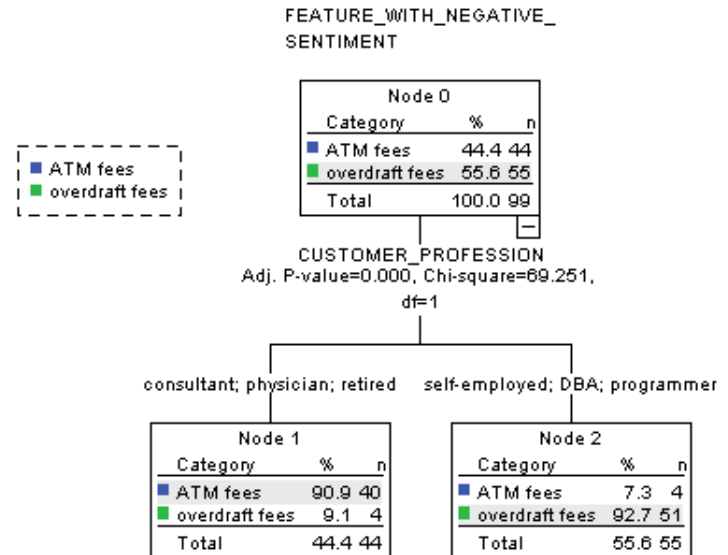

Run end-to-end analytics on zEnterprise to reduce costs and improve reliability

- 60-70% of operational data resides on System z
- zEnterprise offers a fully integrated, optimized analytics solution on one platform
 - From operational data to business analytics
- Consolidating data warehouses on zEnterprise with DB2 Analytics Accelerator can reduce costs by over 90%
- Cognos adds unmatched descriptive intelligence
- SPSS adds unmatched predictive intelligence

